

PALLADIUM BOOKS® PRESENTS:

SYSTEMS FAILURE™

A COMPLETE ROLE-PLAYING GAME

BY BILL COFFIN

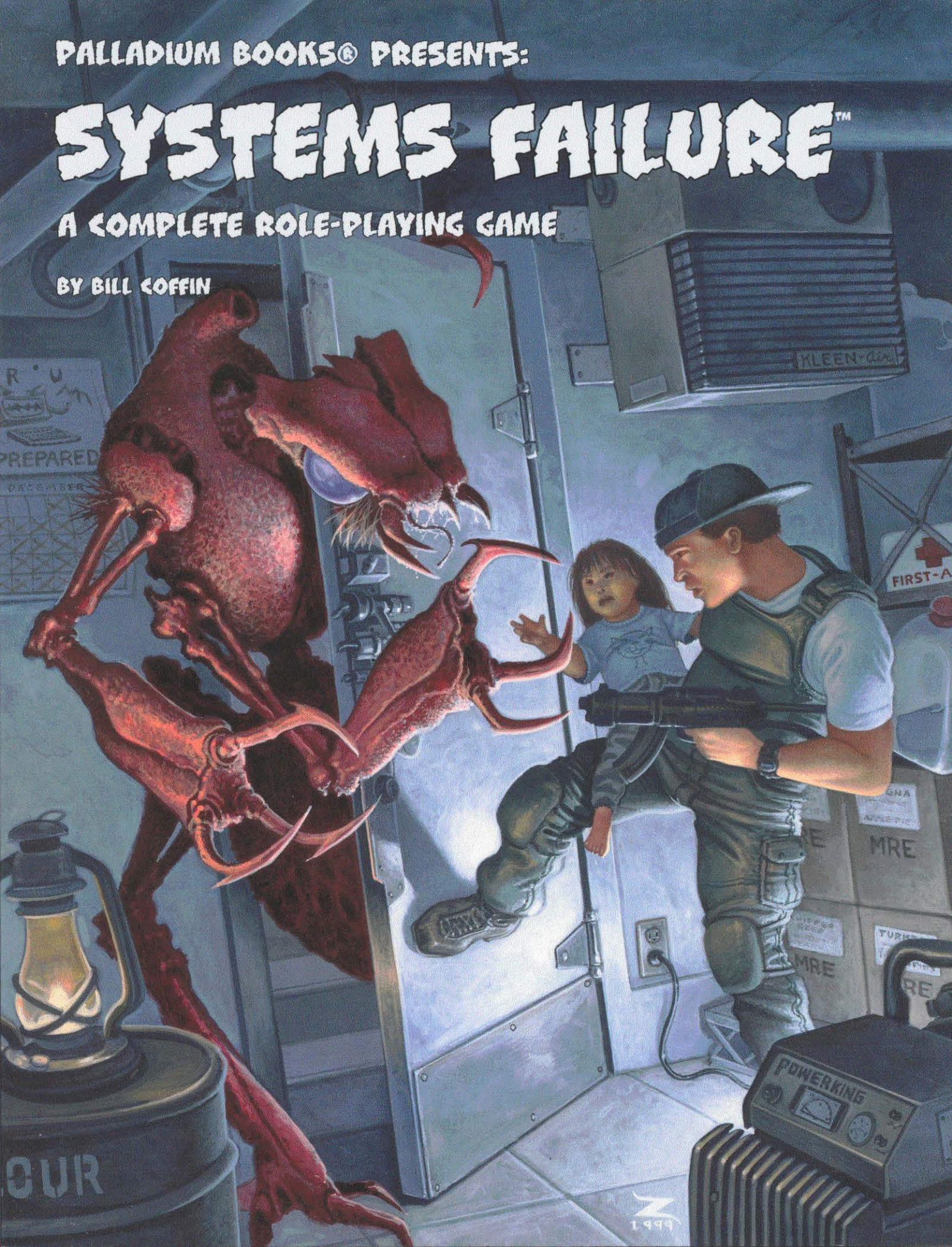

1999

Warning

Violence and the Supernatural

The fantastic world of the Systems Failure™ Role-Playing Game is violent, deadly and filled with monsters and conflict. Other-dimensional beings called "Bugs" threaten to destroy humankind and torment, stalk and enslave humans. Monsters, the collapse of civilization, psychic powers, magic, insanity, war and heroic adventure are all elements of this book.

Some parents may find the violence and supernatural elements inappropriate for young readers/players. We suggest parental discretion.

Please note that none of us at Palladium Books condone or encourage the occult, the practice of magic, the use of drugs, or violence.



A complete, new Role-Playing Game.

Emphasis on action, horror, suspense, heroism and fun.

Dedication

Writing this book has been one heck of a ride. When this project came my way, it was the kind of thing for which I had to drop everything and dive in headfirst. After all, it's not every day you get a chance to write a rock 'em, sock 'em game about survivalism, alien invaders and post-apocalypse adventure in the near future. Now that I've gotten a chance to come up for air, I must say that writing **Systems Failure™** has been my most enjoyable gig yet for my friends in Taylor.

So to that end, let me first thank Kevin and Maryann Siembieda for not only giving me the great chance to develop this game, but for having faith in me that I could do it on a tight deadline.

Second, let me thank my tireless play-testers, Jay Pascale and Tim Warren, for their timely willingness to play-test a half-written game.

Third, I must thank Richard and Jo Thomassen, who graciously critiqued my rough draft (while moving into their new house, no less!).

And finally, special thanks to my wife Alii, who not only gave me endless encouragement, creative feedback and excellent design advice, but who also put up with my many sleepless nights spent hunched over the keyboard.

— *Bill Coffin, July 1999*

First Printing — July, 1999

Copyright 1999 Palladium Books Inc. and Kevin Siembieda

All rights reserved under the Universal Copyright Convention, Worldwide. No part of this book may be reproduced in part or whole, in any form or by any means, without permission from the publisher, except for brief quotes for use in reviews. All incidents, situations, institutions, governments and people are fictional and any similarity, without satiric intent, of characters or persons living or dead, is strictly coincidental.

Palladium Books®, Megaverse®, Palladium Fantasy RPG®, Rifts®, RECON®, Phase World®, After the Bomb® and Nightbane® are registered trademarks owned and licensed by Kevin Siembieda and Palladium Books Inc.

Systems Failure, Heroes Unlimited, Ninjas & Superspies, Beyond the Supernatural, Bugboys, NORAD Splicer, Esper, Organotechnology, Organitech, The Meltdown, Bunkerlords, Bunkerville, Bugland USA, Bugtown, Bughouse, Bugkillers, Bughunters, Meltdown Merchant, Fixemup, Bunker Hermit, Splatterpunk, Bulletboy, Kentucky Headhunters, The Cav, The Armory Matrix, Radio Free America, and other names, titles and likenesses of characters are trademarks owned by Kevin Siembieda and Palladium Books Inc.

www.palladiumbooks.com

Systems Failure™ The Role-Playing Game is published by Palladium Books Inc., 12455 Universal Drive, Taylor, MI 48180. Printed in the USA.

PALLADIUM BOOKS® PRESENTS:

SYSTEMS FAILURE™

A COMPLETE ROLE-PLAYING GAME

Written By: **Bill Coffin**

Based on Original Concepts By: **Kevin Siembieda**

Game Rules & Additional Text: **Kevin Siembieda**

Editors: **Jim Osten**

Alex Marciniszyn

Wayne Smith

Proof Reader: **Julius Rosenstein**

Cover Painting: **John Zeleznik**

Interior Artists: **Michael Wilson**

Scott Johnson

Ramon Perez

Maps: **Bill Coffin**

Art Direction & Keylining: **Kevin Siembieda**

Typography: **Maryann Siembieda**

Base on the RPG rules, concepts and Megaverse® created by **Kevin Siembieda**.

Palladium Books On-Line: www.palladiumbooks.com

Special Thanks to Bill Coffin for taking a few pages of ideas, a title, a couple of telephone conversations and the Palladium universal game rules and turning them into a rollicking fun, action-packed, new role-playing game. Plus Bill and I have a lot more cool ideas in store for the future.

Also thanks to Mike Wilson for a herculean effort on the art, Scott Johnson for his art contributions, Johnny Z for a dramatic cover and the other Palladium Eggheads for their hard work.

— *Kevin Siembieda, 1999*

Contents

Prologue	5	The Bugs-	59
Conversation at the End of the World	5	The Bug Hierarchy	60
Turn On, Tune In, Freak Out	6	Army Ant (Tier 1)	62
From the Diary of Jimmy Gillis	8	Assassin Bug (Tier 2)	64
2009: Let the Hunt Begin-	10	Bombardier Beetle (Tier 2)	67
The Rules of the Game	12	Killer Bee (Tier 2)	68
How to Play a Role-Playing Game	12	Stink Bug (Tier 2)	70
Glossary	13	Silkworm (Tier 1)	73
Character Creation	14	Silkworm Zombies	75
Step One: The Eight Attributes-	14	Lightning Bug (Tier 3)	76
Attribute Bonus Chart	15	The Human Resistance	79
Speed Chart	15	Occupational Character Classes	80
Step Two: Determining Hit Points & S.D.C.-	16	Egghead O.C.C.	80
Armor Rating (A.R.)	16	Exterminator O.C.C.	82
Recovery of Hit Points & S.D.C.-	16	Freebooter O.C.C.	85
Surviving Coma & Death	17	Grease Monkey O.C.C.	87
Optional Damage Rules	17	Peacekeeper O.C.C.	89
Step Three: Determine Background	18	Sawbones O.C.C.	91
How Old You Were Before the Meltdown	18	Splatterpunk O.C.C.	93
Background Occupation Table	19	Survivalist O.C.C.	95
Step Four: Determine Psionics	21	NORAD Psychic O.C.C.	97
Step Five: Pick an O.C.C.	21	NORAD Splicer O.C.C.	99
Step Six: Pick an Alignment	21	The Wacko O.C.C.	102
Experience Points	25	The State of the World	105
Insanity	26	It's Been a Long Ten Years	105
Skills	29	Land of the Free	109
Scholastic Skills	30	An Atlas of Post-Meltdown America	109
Skill Programs	30	Maps of America	109
Secondary Skills	31	Bunkerville	110
Skill Penalties	31	Four Comers	112
Skill Lists-	31	Motown-	113
Skill Descriptions-	32	BuglandUSA-	114
Communications	32	Home of the Brave	115
Domestic	32	The Bug Hunters	117
Electrical	33	NORAD	117
Espionage-	33	Wyoming Free Irregulars	119
Mechanical	34	The Underground Railroad	120
Medical	35	Radio Free America	121
Military	35	The New Warlords	121
Physical-	36	Campaign Ideas & Settings-	123
Pilot: Basic	37	The Survivors-	123
Pilot: Advanced-	37	Search & Rescue	124
Pilot Related	38	Road Trip	125
Rogue Skills	38	The Killer App	126
Science	39	Palladium RPG® Plug-Ins	127
Technical	39	Break Out The Hardware	130
Ancient W.P.	40	Organitechl	130
Modern W.P.	41	Bug Zappers (guns)-	130
Wilderness	41	Bug Bombs	132
Combat-	42	Bug Juice	133
Hand to Hand Combat	42	Bug Motels	134
Combat Terms & Moves	44	Battlesuits-	135
S.D.C. Values-	46	Conventional Guns, Ammo & Explosives	136
Hand to Hand Combat Styles-	47	Body Armor	140
Modern Weapon Combat-	48	Field Equipment & Miscellaneous Gear	141
Psionics-	50	Conventional Vehicles	142
Healing Powers	51	A Final Word-	143
Physical Powers	52		
Sensitive Powers	53		
Super Psionic Powers-	55		

Prologue: Welcome to the Bughouse



Dec. 31, 1999: Conversation at the End of the World

ChatHost: Whomprat has entered the room.

Jabberwocky: Hey, Whomprat.

Galadriel: Whomprat!

lurker100: yo whomprat. Haven't seen you in a while. What's up?

More Beer Please: Dead in here. What's going on?

Whomprat: Happy New Year!!

More Beer Please: Dude, it's not for like another 20 hours or something.

Galadriel: You on EC, MBP?

More Beer Please: Big Apple, baby! Location/Time Check!

Galadriel: Then what the hell are you doing in here this early? Don't you have a job or something?

More Beer Please: Home on break from college, no job, no girlfriend. Thus, chat room and beer.

Jabberwocky: I'm from Hawaii. 1:55 a.m.

Whomprat: I'm in New Zealand. We're 17 hours ahead of you, MBP. Y2K in T-minus five minutes.

Bruce Geering: London. Noon. Hope my boss doesn't catch me here...

Galadriel: Taylor, Michigan. Pushing six in the a.m. I can't believe I stayed up this late.

Bruce Geering: You've been here all night?

Jabberwocky: Yeah, Galadriel is weird like that.

Jabberwocky: He chats too much and misses all his deadlines, right Galadriel?

Galadriel: Don't remind me! ** hangs head in shame **

Bruce Geering: So, anybody here stockpile for the Millennium Bug?

lurker100: no

Whomprat: T-minus 2 minutes!! Haven't prepared at all. Why bother?

Galadriel: Is New Zealand Y2K compliant? Computers, power systems, things like that?

More Beer Please: Who freaking cares? I got three cases under my bed. I'm stockpiled, baby!

lurker100: IGNORING MORE BEER PLEASE

Whomprat: NZ is as compliant as everybody else is, I guess. Hard to say. I read about how a bunch of local power stations might go down though.

Bruce Geering: I don't think the question is if the hardware is compliant, but what people are going to do.

Galadriel: I agree. We had a bunch of runs on the supermarkets because people think there will be no food. Stupid.

Whomprat: One minute until the millennium!!!!

lurker100: actually no the millennium doesn't start until 2001

Galadriel: Oh, be a killjoy, why don't you?

Bruce Geering: Twenty quid says we lose Whomprat.

More Beer Please: What a stupid bet!

Whomprat: 10!

Whomprat: 9!

Whomprat: 8!

lurker100: would you please stop doing that

Whomprat: 7!

Whomprat: 6!

Whomprat: 5!

lurker100: IGNORING WHOMPRA

Whomprat: 3!

More Beer Please: Lurker, you need to chill. **slides him a beer**

Bruce Geering: How did I know you were going to do that?

Jabberwocky: We lost Whomprat.

More Beer Please: Maybe he's kissing somebody Happy New Year.

Galadriel: Look at the status window, moron. He's not here. Wonder what happened?

More Beer Please: Probably just got bumped by the server. Happened to me three times today already.

Bruce Geering: Perhaps you should find a hobby, MBP.

Jabberwocky: This is freaking me out. What if his computer went down?

More Beer Please: **bangs head on keyboard** HE PROBABLY GOT BUMPED. CALM DOWN!!!!!!

Jabberwocky: afk brb

Galadriel: Hello? Everybody still there? It got quiet all of a sudden.

lurker100: still here

Bruce Geering: Still here.

Galadriel: Jabberwocky's been gone a while. So has Whomprat. What's going on?

More Beer Please: Well, he didn't get bumped, if that's what you mean.

Jabberwocky: New Zealand is down! The whole country is totally down!

Bruce Geering: The entire country? That seems odd. I thought most of the electronic infrastructure was Y2K compliant.

Jabberwocky: Check out the cable news if you don't believe me. They were waiting to see what would happen in NZ because it was the first big country to go Y2K.

lurker100: he's right, oh my god he's right

Bruce Geering: afk/brb

Galadriel: Dude, the NZ government site is dead.

Chat Host: ROOSTER has entered the room.
ROOSTER: HEY EVERYONE! NEW ZEALAND JUST WENT BYE-BYE!
Galadriel: Who the hell are you? And stop yelling.
ROOSTER: SORRY. CAPS LOCK KEY BUSTED. I'M WITH THE HIGHTOWER. NONPROFIT INTERNET WATCHDOG GROUP. JUST A FRIENDLY REMINDER THAT WE'RE ALL DEAD MEAT NOW. IF NZ WENT THEN SO WILL EVERYTHING ELSE.
More Beer Please: Yeah, right. Log off, loser.
Jabberwocky: Rooster's cool, folks. I know him. What makes you say that, about NZ, Rooster?
ROOSTER: BECAUSE I'VE BEEN MONITORING THIS WHOLE THING SINCE 1988. I GOT A PROJECTION ON WORLDWIDE COMPLIANCE THAT IF NZ GOES DOWN, WE CAN COUNT ON LOSING 85% OF THE REST OF THE INFRASTRUCTURE MINIMUM.
Galadriel: This is tripping me out. Why did NZ go down? It shouldn't have.
lurker100: hey where did geering go? we lost him.
ROOSTER: DON'T BANK ON IT. HIGHTOWER'S U.K. MIRROR IS DOWN AND DARK.
ROOSTER: THIS IS BAD. WE JUST LOST SE ASIA AND IT'S NOT EVEN MIDNIGHT THERE YET.
ROOSTER: THERE GOES HIGHTOWER RUSSIA, TOO. I THINK WE'RE SCREWED.
Jabberwocky: Oh, man, why are things crashing prematurely?
lurker100: they shouldn't be crashing at all
ROOSTER: THERE GOES LURKER. WHERE WAS HE OUT OF?
More Beer Please: Dunno. I thought he was in Alaska or something. If he went down, how come I'm still up?
More Beer Please: Spoke too soon. Manhattan just lost power. What the hell? It's like rush hour time over here. I might lose service.
Jabberwocky: This doesn't make any sense, Most of the servers out there are totally compliant.
ROOSTER: DOESN'T MATTER. YOU CAN RUN FROM THE CRASH, BUT THE CRASH ALWAYS FINDS YOU.
More Beer Please: So what does ****that**** mean?
ROOSTER: IT MEANS THAT WE HAD ALL THIS TIME TO PREPARE FOR THE APOCALYPSE AND WE STILL FAILED TO MEET THE TEST. YOU GUYS ARE DONE FOR.
ROOSTER: GOODBYE JABBERWOCKY. WE HARDLY KNEW YE.
ROOSTER: ****SINGS**** "I THINK WE'RE ALONE NOW..."
More Beer Please: You seem awfully happy about all this.
ROOSTER: I AM. I'VE BEEN PREPARING FOR THIS FOR YEARS.
More Beer Please: Still no reason to be happy about it.
ROOSTER: IF YOU KNEW ME, YOU'D UNDERSTAND. THIS IS JUST THE BEGINNING. WAIT UNTIL THE FOOD RIOTS KICK UP. THAT'S WHEN THE REAL FUN WILL START.
More Beer Please: Crap! The rest of the borough's out! What are we gonna do?
ROOSTER: UNLESS YOU'VE GOT A CONCRETE BUNKER AND ENOUGH GUNS TO SHOOT TEXAS IN HALF, YOU BETTER LOCK YOUR DOOR AND HIDE UNDER YOUR BED AND NOT COME OUT FOR A YEAR.
More Beer Please: Forget that. I'm gonna get drunk. Signing off.
ROOSTER: ****SINGS**** "ALL BY MYSELF..."
Chat Host: 10101010 has entered the room.
ROOSTER: WHO THE HECK ARE YOU?
Chat Host: 10101011 has entered the room.
Chat Host: 10101012 has entered the room.
Chat Host: 10101013 has entered the room.
ROOSTER: HEY! YOU GONNA ANSWER?
Chat Host: 10101014 has entered the room.
Chat Host: 10101015 has entered the room.
Chat Host: 10101016 has entered the room.

ROOSTER: I AM SO OUT OF HERE.
Chat Host: 10101017 has entered the room.
Chat Host: 10101018 has entered the room.
Chat Host: 10101019 has entered the room.
10101010: Site is secure. Move on to next, secure and deactivate. Await further orders from Swarmlord.
Chat Host: 10101011 has left the room.
Chat Host: 10101012 has left the room.
Chat Host: 10101013 has left the room.
Chat Host: 10101014 has left the room.
Chat Host: 10101015 has left the room.
Chat Host: 10101016 has left the room.
Chat Host: 10101017 has left the room.
Chat Host: 10101018 has left the room.
Chat Host: 10101019 has left the room.



December 31, 2001: Turn On, Tune In, Freak Out

skrik "Anybody out there? CQ, CQ, this Night Flyer calling anybody in Free America, over. If anybody is receiving me, please pick up. CQ, CQ, this is Night Flyer calling anybody in Free America, over."

skrik "So come on down to your good old Uncle Roscoe's, right in the Heartland. We've got more guns and ammo than you can shake a stick at, and with what's been going on lately, you better stock up fast! And we don't take cash, neither. Only trade goods, here. That means gold, silver, canned foods, grain, laying hens and the likes. And if you Bugs are listenin', then come on down too! I got some bullets with yer name on 'em"

skrik "This is WPAL, the voice of Free Michigan. We're coming at you live from the Peninsula, where the land is free and the powder is dry. Happy New Year, 2002! This is the big K-Man on the line, broadcasting until my batteries geek or the Bugs come get me, whichever happens first. And that brings me to the big question of the day: What have you heard about these Bugs? I've got some folks telling me we've got alien invaders running around our electrical and phone lines. I got

other people telling me it's all a big government conspiracy. And I've got some other guy who says that it's just our way of finding *anybody* to blame but ourselves for the mess we're all in.

He's got a point, you know. We hit that big brick wall on Y2K, and once the world went dark, everybody just flipped. I'll bet you a week's worth of D-cells that there isn't a single city that ain't got a serious anarchy festival going on. Or a single country that isn't either at civil war, international war, or just plain hasn't fallen off the deep end. This could be it, you know. This could be the end of everything. And here I am, spending it on the Peninsula, broadcasting to all you fine people from Windsor to Wisconsin."

skrik "The following is a Federal bulletin. Looters, bandits, and revolutionaries will be shot on sight until civil order can be reestablished. A strict dusk-to-dawn curfew is in effect; violators will be shot on sight. Please be ready to present identification to any Federal soldier or National Guardsman who asks you for it.

skrik "Urn, is this thing on? Hmm. I think it's working. Well, here goes. If anybody is listening out there, you should know a few things. This may sound pretty basic, and if it is, I apologize, but there are a lot of people with zero communications now, and all of a sudden, everybody in this country is cut off. When you think about how much we had taken for granted with the phones and cable TV, and the Internet and stuff, it kinds of makes you feel funny to have all that quiet all of a sudden. That's why I think everybody has gone so nuts and are burning their cities and starting big gunfights, and things like that. My Mom says it's all going to blow over in about a year or so. Good thing we built this bunker. Mom says we could hold out here forever, if we have to..."

skrik " ... I say again, have sighted enemy hostiles in vicinity of nuclear facility. Intruders are huge insects of some kind. Have made visual contact. Moving to evade. Enemies are powering what appear to be weapons on their bodies! Taking evasive action ..." *skrik*

skrik "This just in: The street fighting in Los Angeles has escalated into a full blown war as National Guard tanks engage mobs of looters and anarchists armed with everything from molotov cocktails to wire-guided missile launchers. Details at this time are sketchy, but our field correspondents report that one tank has been destroyed already, and civilian casualties are high. Reports of similar fighting in New York, Washington, Dallas, Chicago and San Francisco have also come in. More on this to come.

"But now, this: After remaining out of sight for much of the last three months, the President is giving his first press conference, where he is expected to address the severe downward spiral American society has taken since the Y2K. Blackout. We bring you now to Jane Edmons, in Washington."

"Thanks, Don. I'm speaking to you from the Presidential Briefing Room, where the President will soon make his first National Address since the country's communications were restored, just a few weeks ago. In the time between the Blackout and the widespread restoration of computer systems and communications, almost the entire country, as well as most of the world, has engaged in a nonstop riot of senseless destruction and violence. Many blame The Meltdown on pent-up social ills that went unaddressed for the last several decades, while others attribute it to a 'riot reflex' human society encounters every thousand years."

"Jane, with the military in tatters, cities in utter chaos, and life as we know it hanging by a thread, there seems to be little that the President can say or do at this late date to mollify a scared and desperate public. Is that the consensus there?"

"Yes it is, Don. Most of the press corps and citizens groups here don't expect much out of the President. They have some hard questions for him, but they expect only soft answers. He's coming to the podium now. Let's hear what he has to say."

"Ladies and gentleman, the President of the United States."

"Good evening. As we enter our second hard year since the Millennium Crisis, we find our cities ravaged by anarchy, our technology shattered by disruptions, and our enemies taking up arms against us both at home and abroad. These are trying times indeed, but I am certain that together, we can — no — we *will* prevail. Together ... what the..."

"Mr. President, get down! We — aargh!"

"Look out, it's coming out of the power outlet! It's — Oh god! Nooooo..."

Gunfire echos in the background.

"Jane! What's going on there?!"

"Don, there's some kind of... of creature that has materialized in the room! It ... it came from the electrical equipment and has killed the President's guards. It's horrible! It's complete chaos here. I..."

"Jane, be careful! Maybe you should get out of there!"

"Don! I'm going to aim my directional mike at the stage to ... Good Lord, no!! The creature! It has the President by the throat! Oh, my God!"

"Urghh —"

"What... what... do you want?"

"Beeee sssiilent, humannn. Weee are heeere to reclaim what is oursss."

"I don't know what you're talking about! We ..."

"Sssiilence! Our mission is to feeeed. And for vengeance, yesss."

"Hukk-hukkk — ven-vengeance?"

"You do not remember usss, then, do you, humannn?"

"Uhg, n-no."

"Pity. It would have made our reeevenge sssso much sssweeter. No matter. We ssshall take what we wissssh and leave your world a dead place, as you have left oursss."

** snapping, gurgling sounds followed by a thud **

"Oh, my God! Don, that thing just killed the President! Oh my God, oh, my God. Don, I'm the only one left in here ... a ... alive. I'm ... so scared. It... it's looking right at me."

"Humannn."

** The sound of sobbing, then — silence **

"Jane? Jane? Jane, answer me!"

skrik





2005-2006:

From the diary of Jimmy Gillis

APRIL 11, 2005

MOM SAYS I SHOULD KEEP A DIARY BECAUSE IT WILL BE IMPORTANT TO SOMEBODY ELSE SOMEDAY. I DONT KNOW WHY. SHE SAYS IT HAS SOMETHING TO DO WITH A GIRL NAMED ANNE, BUT I DONT THINK SHE'S IN MY CLASS OR ANYTHING. I HATE WRITING THIS BY HAND. I WISH OUR COMPUTERS WORKED AGAIN, BUT MOM SAYS THAT IT'S TOO DANGEROUS TO USE THEM. I COULDN'T ANYWAY %CAUSE MOM AND DAD SMASHED THEM. THE BUGS MIGHT COME THROUGH THEM AND GET YOU THEY SAID. IT'S TRUE TOO. I DONT KNOW HOW. BUT THEY CAN. I SEEN IT.

SO, THIS IS MY FIRST DIARY. MY NAME IS JIMMY GILLIS AND I AM NINE YEARS OLD. I LIVE IN NEW YORK CITY. MY MOM SAID I SHOULD INCLUDE ALL THAT BUT I THINK IT IS DUMB. I KNOW HOW OLD I AM.

JUNE 9, 2005

I DONT GET OUT MUCH, BUT YOU CAN HEAR LOTS OF SHOOTING AND EXPLOSIONS AND STUFF. MY MOM IS REALLY WORRIED, AND DAD IS JUST QUIET ALL THE TIME. I WISHED HE'D TALK. IT SCARES ME THE WAY HE'S SO QUIET. BUT I GUESS WE'RE ALL SAD. AND SCARED.

THEY SAY THE WORLD JUST MELTED DOWN AFTER THE Y2K THING, AND WHEN THEY FIXED EVERYTHING, THE BUGS CAME AND REALLY MESSED THINGS UP. NOW THE BUGS ARE EVERYWHERE. ALL ANYBODY DOES IS TRY TO FIGHT THEM OR FIGHT EACH OTHER. MOM SAYS THAT THIS IS THE END OF THE WORLD, BUT DAD SAYS

WE CANT GIVE UP HOPE YET. HE SAID THAT THE WORLD HAS BEEN THROUGH WORSE TIMES THAN THIS, BUT I DONT BELIEVE HIM.

FOR A LONG TIME I THOUGHT THIS WAS JUST HAPPENING IN AMERICA, BUT I LEARNED THAT IT'S HAPPENING EVERYWHERE, ESPECIALLY IN COUNTRIES LIKE OURS WHERE THERE WERE LOTS OF COMPUTERS AND FACTORIES AND TELEPHONES AND THINGS LIKE THAT. I ASKED DAD IF EVEN PLACES LIKE THE AMAZON AND AFRICA HAD THE BUGS AND THE MELTDOWN, TOO. HE SAID YES. HE SAID THAT BOTH THINGS HAVE HAPPENED EVERYWHERE. IT'S SUPPOSED TO BE THE WORST HERE AND IN EUROPE AND ASIA, BUT I CANT IMAGINE ANYTHING WORSTER THAN THIS. THERE ARE NO MORE TELEVISION PROGRAMS, SCHOOL, PLAYING OUTSIDE, OR ANYTHING. THERE ARE PEOPLE ON THE RADIO, BUT I NEVER KNOW WHAT TO BELIEVE BECAUSE THEY ALL SAY DIFFERENT THINGS.

DAD KEEPS CHECKING OUR GUN TO MAKE SURE IT STILL WORKS. MOM KEEPS TELLING HIM NOT TO DO THAT, BUT HE DOESNT LISTEN. I THINK HE DOES IT TO TAKE HIS MIND OFF THE BAD THINGS OUTSIDE.

JULY 10, 2005

A LOT OF THE FIGHTING STOPPED ONCE THE NATIONAL GUARD CAME IN. THEY HAD THESE BIG TANKS AND THEY BLEW A LOT OF STUFF UP. ONLY THEY MADE THINGS WORSTER BECAUSE ALL OF THE CITY IS ALL BROKEN UP NOW. EVEN A BUNCH OF THE REALLY BIG SKYSCRAPERS ARE GONE.

I HEARD A TANK SHOT A SPECIAL BOMB AT THE EMPIRE STATE BUILDING BECAUSE THERE WERE ALL THESE TERRORISTS IN IT WHO SAID THEY WERE GOING TO BLOW IT UP ANYWAY AND THAT THE WHOLE BUILDING CRASHED TO THE GROUND. I WANTED TO GO SEE, BUT MOM AND DAD SAID NO. MOM WAS REAL MAD AT ME AND SAID THIS ISN'T A JOKE. I WASNT BEING FUNNY. I JUST WANTED TO SEE. WE NEVER GO OUTSIDE ANYMORE.

I HEARD ON THE RADIO THAT THE SAME THING HAPPENED TO THE WORLD TRADE CENTER AND THE STATUE OF LIBERTY TOO, BUT YOU CANT TRUST WHAT YOU HEAR ON THE RADIO. LOTS OF WEIRD PEOPLE ON IT. DAD SAID IT WAS ALWAYS LIKE THAT, BUT IT REALLY GOT LIKE THAT AFTER TV WENT AWAY.

AFTER THE TANKS BLEW HALF THE CITY UP, SOME SOLDIERS CAME TO OUR HOUSE AND TOLD US TO COME TO A PLACE WHERE WE WOULD BE SAFE. MOM IS REALLY HAPPY ABOUT THIS, BUT I'M NOT. THOSE SOLDIERS WERE WEIRD. I DONT LIKE THEM. THEY ALL HAD THESE WEIRD BRUISES UNDER THEIR NOSES, LIKE THEY GOT PUNCHED IN THE MOUTH OR SOMETHING. MOM DOESN'T CARE, THOUGH. DAD DOESNT LIKE THEM EITHER.

SEPTEMBER 12, 2005

MOM DIED ON JULY 11, BUT I COULDN'T WRITE ABOUT IT UNTIL NOW. I COULDN'T WRITE ANY-

THING FOR A LONG TIME. I MISS HER SO MUCH /CANT EVEN SAX. DAD DOES TOO. I THINK HE IS EVEN SADDER THAN ME, BUT I TRY TO CHEER HIM UP EVEN THOUGH IM STILL REALLY SAD. MORE SCARED THAN EVER TOO.

THE DAY MOM DIED, DAD NOTICED SOMETHING WRONG WITH THE SOLDIERS WHO CAME TO TAKE US TO A CAMP. ONE OF THE SOLDIERS HIT DAD AND HE STARTED FIGHTING WITH THEM. THAT'S HOW MOM GOT SHOT. I FEEL REALLY BAD ABOUT MOM BECAUSE IF I WASN'T SO SCARED I COULD HAVE HELPED HER. DAD SAYS THERE WAS NOTHING I COULD HAVE DONE, BUT I DONT KNOW IF I BELIEVE HIM. HE SAYS THAT SHE IS IN A BETTER PLACE. I BELIEVE THAT, BECAUSE I DONT THINK THE WORLD IS A GOOD PLACE ANYMORE.

IM REALLY SCARED AND LONELY NOW, EVEN THOUGH DAD IS ALWAYS CLOSE BY. I KNOW HE'S TRYING MAKE UP FOR MOM BEING WITH THE ANGELS, BUT IT'S JUST NOT THE SAME. I WISH SHE WAS HERE, ^SPECIALLY NOW THAT WE HAD TO LEAVE HOME. DAD SAID WE HAD TO GO AWAY WHERE THE BAD SOLDIERS CAN NOT FIND US. MOST OF THE STUFF PEOPLE SAID ON THE RADIO IS TRUE. NEW YORK IS ALL SLOWED UP. THE EMPIRE STATE BUILDING IS GONE AND SMOKE RISES FROM JERSEY ALL THE TIME, LIKE IT IS ALWAYS ON FIRE. RIGHT NOW, WE ARE HIDING IN THE BASEMENT OF AN OLD HARDWARE STORE IN CONNECTICUT. DAD SAYS THE PEOPLE WHO OWN IT WILL HIDE US FOR A WHILE, BUT THEN WE HAVE TO MOVE AGAIN. HE SAYS WE ARE GOING TO CANADA. I HOPE IT'S A LOT NICER THERE.

NOVEMBER 28, 2005

WE ARE JUST A FEW MORE DAYS FROM CANADA. DAD KEEPS LISTENING TO THE RADIO TO HEAR WHY THE WORLD IS SO CRAZY. HE SAYS IT IS MORE THAN Y2K THAT DONE ALL THIS. HE SAYS SOME KIND OF MONSTERS OR ALIENS OR SOMETHING CAME OUT OF NOWHERE. IT'S THESE MONSTER THAT HAVE CAUSED ALL THE BAD THINGS. THESE CREATURES EVEN DID SOMETHING TO THE SOLDIER WHO KILLED MOM. THAT THEY ARE TAKING EVERYBODY AWAY AND THAT'S WHAT THEY WANTED TO DO TO US, AND THAT IS WHY WE ARE RUNNING. I STILL MISS MY MOM. DAD SAYS TIME HEALS ALL WOUNDS BUT I STILL HURT INSIDE AND I DONT THINK IT WILL EVER STOP.

WE HAVE TO WALK BECAUSE MOST OF THE CARS DONT WORK ANYMORE AND THE GAS STATIONS ARE ALL CLOSED, BURNED OUT, OR RUN BY BAD PEOPLE, DAD SAYS. HE SAID THAT EVERYBODY WITH A BRUISED NOSE IS BAD. THEY HAVE A WORM INSIDE THEM THAT MAKES THEM DO BAD THINGS, LIKE THE ONES WHO SHOT MOM. WE RAN INTO SOME PEOPLE LIKE THAT YESTERDAY, AND THEY TRIED TO TAKE US SOME PLACE WITH THEM. WHEN WE DIDN'T WANT TO GO, THEY GOT REAL MAD AND ATTACKED US. DAD SHOT THREE OF THEM WITH HIS GUN, BUT THE LAST ONE RAN AWAY, WHICH MADE ME GLAD. DAD SAID THAT WAS BAD BECAUSE NOW HE WOULD TELL THE OTHERS WHERE WE WERE.

I LOVE DAD AND DONT WANT THE WORM-NOSE PEOPLE TO HURT HIM. I THINK WE WILL BE OKAY ONCE WE GET TO CANADA.

DECEMBER 25, 2006

MERRY CHRISTMAS, DIARY.

WE HAVE BEEN HIDING IN A FARMHOUSE FOR ALMOST THE WHOLE MONTH BECAUSE AFTER THE SHOOTOUT, WE RAN INTO SOME MORE OF THOSE WORM PEOPLE AND DAD GOT SHOT IN THE LEG. EVER SINCE THEN, WE CAME TO THIS PLACE, A SMALL TOWN SOMEWHERE UP NORTH. IT'S HARD TO SAY WHERE WE ARE BECAUSE WE HAVE BEEN STAYING OFF THE ROADS, BECAUSE THAT'S WHERE MOST OF THE WORM-NOSE PEOPLE ARE. THEY ARE STOPPING CARS AND TRUCKS AND TAKING PEOPLE WAY WITH THEM. I DONT KNOW WHERE, BUT DAD SAYS IT CANT BE ANYWHERE GOOD. I AGREE. DAD THINKS WE ARE IN VERMONT OR NEW HAMPSHIRE, BUT HE IS NOT SURE.

WE ARE IN A TOWN CALLED TINTAGEL. IT'S GOT LOTS OF FARMS AROUND IT AND NOT VERY MANY BUILDINGS. THERE IS HARDLY NOBODY HERE AT ALL. IT'S LIKE THEY ALL JUST GOT UP AND WALKED AWAY. THEY LEFT LOTS OF GOOD STUFF BEHIND, TOO, SO WE CAN STAY HERE FOR AS LONG AS WE WANT. THAT'S GOOD, BECAUSE IM NOT SURE IF DAD'S LEG WILL GET BETTER BEFORE THE SNOW COMES DOWN REALLY HARD. IT HASNT SNOWED YET, BUT IT PROBABLY WILL SOON. AND UP HERE, IT SNOWS A LOT.

WHEN DAD WAS SLEEPING YESTERDAY, I SNUCK OUT OF THE HOUSE AND EXPLORED THE EMPTY TOWN. IT LOOKS LIKE IT USED TO BE A NICE PLACE, BUT I THINK I WOULD BE VERY BORED TO LIVE HERE. I MISS NEW YORK CITY. IT IS VERY, VERY QUIET HERE. ALMOST LIKE IF YOU TRIED REALLY HARD, YOU COULD HEAR ALL THE WAY AROUND THE WORLD. I WENT INTO THE SCHOOL, AND I FOUND A BUNCH OF CLASSROOMS THAT STILL HAD BOOKS AND PAPERS IN THEM. I FOUND SOME LETTERS KIDS LIKE ME WROTE BEFORE EVERYBODY LEFT TOWN. THEY DIDNT LEAVE TOWN ON THEIR OWN. THE WORM PEOPLE CAME AND GOT THEM. THEY MUST HAVE KILLED A LOT OF PEOPLE TOO BECAUSE I FOUND A GULLY OUTSIDE OF TOWN WITH THOUSANDS OF THEM. I DONT KNOW WHY, BUT I WAS AFRAID. IT MUST HAVE BEEN COLD BECAUSE A LOT OF THE BODIES WERENT HARDLY ROTTEN OR NOTHING. MOSTLY LOOKS LIKE THEY KILLED THE OLD PEOPLE AND A BUNCH OF GROWNUPS. I DIDNT SEE NO KIDS, BUT THERE MIGHT HAVE BEEN SOME. I WASNT GOING TO CLIMB DOWN TO GET A CLOSER LOOK.

THE WAITING AND THE QUIET IS WHAT I FIND REALLY SCARY. NEVER KNOWING IF THE WORM PEOPLE MIGHT BE COMING TO GET YOU OR NOT. SOMETIMES I HAVE BAD DREAMS. I THINK DAD DOES TOO. WE TRY TO BE BRAVE FOR MOMMY. DAD SAYS SHE LOOKS DOWN FROM HEAVEN AND WILL WARN US IF THE WORM PEOPLE COME. I DONT KNOW IF THAT'S TRUE, BUT I HOPE SO. IT MAKES ME FEEL BETTER TO THINK MOM IS

WATCHING US. I DON'T WANT TO HAVE A WORM SHOVED UP MY NOSE AND BECOME SOME KIND OF ZOMBIE OR SOMETHING.

WHEN I WAS LEAVING THE SCHOOL IN TOWN, I THOUGHT I SAW SOME PEOPLE ON THE STREET. IT WAS DARK AND ALL I COULD SEE WERE SHADOWS. REMEMBER HOW I SAID IT WAS REALLY QUIET HERE? I THINK IT WAS SO QUIET THAT I COULD HEAR THINGS REALLY WELL, BECAUSE THERE WAS THIS SOUND OF PEOPLE WHISPERING AND THIS WEIRD BUZZING, LIKE BUGS. XCEPT IT'S TOO COLD FOR BUGS. AND THERE WAS THIS HUMMING, LIKE WHEN YOU PUT YOUR EAR CLOSE TO ONE OF THOSE BIG ELECTRICAL WIRES. I GOT SCARED AND RAN BACK TO THE HOUSE. WHEN I GOT THERE, DAD WAS STILL ASLEEP. THE MEDICINE MAKES HIM SLEEP REALLY LONG, SO I THINK THAT IS WHY HE DID NOT WAKE UP WHEN I RAN BACK INSIDE. I WISH HE HAD BEEN AWAKE, THOUGH, BECAUSE I AM REALLY WORRIED, AND HE'S THE ONLY ONE WHO MAKES ME NOT BE AFRAID. HE'LL BE MAD THAT I WENT TO TOWN, BUT I THINK I WILL TELL HIM AS SOON AS HE WAKES UP.

I THINK IT WILL BE BETTER WHEN WE GET TO CANADA. DAD SAYS IT MIGHT NOT BE ANY DIFFERENT THERE, BUT I THINK IT WILL. ALL THE PICTURES I HAVE SEEN OF CANADA SHOW LOTS OF TREES AND STUFF LIKE THAT. I REALLY, REALLY THINK IT WILL BE OKAY THERE.

OAN. 1, 2007

DAD SAYS I MUST WRITE THIS SO I AM DOING IT REALLY FAST BECAUSE THERE IS NO TIME. THERE ARE WORM PEOPLE ALL OVER THE PLACE AND DAD HAS HIS GUN AND HE SAYS HE IS GOING TO SHOOT THEM, BUT I AM AFRAID THEY ARE GOING TO GET US.

DAD SAYS IT'S OKAY THAT WE WILL EITHER GET AWAY OR WE WILL SEE MOM AGAIN SOON.

I AM REALLY SCARED. PLEASE GOD. SEND SOMEBODY TO HELP US.

MOM, IF YOU ARE AN ANGEL HELP ME AND DAD. PLEASE

PLEASE ANYBODY HELP
PLEASE

2009:

Let the Hunt Begin

Excerpted from the introduction to **The Wyoming Free Irregulars' Trainee Handbook, 3rd Edition**:

Before your real training starts, it's best you know the state of the world you want to fight for. You can't commit to something like the Wyoming Free Irregulars without knowing all the facts. Otherwise, you're just fooling yourself.

So, for all you slowpokes, newbies and greenhorns out there, here's the deal. Take it from me, the old Cowgirl in charge, because nobody else is going to lay it out this plain and straight.

Everybody thought they was ready for Y2K. Maybe they were, but they weren't ready for the Bugs.

When the big date hit, just about everything went down. I mean, we're talking total systems failure. Utilities all went off-line, air traffic control fritzed, military systems geeked out, and that was just the beginning. Most of us can remember the days after, when food riots and looting tore this country and pretty much the rest of the world, apart. The Government did its best to lock things down, but the harder they tried, the worse it got. It was like all the pressures of everyday life had built up this gutful of hate in everybody and now that the system had crashed, they could let their hate take over. This was the beginning of the bad times. What we call "The Meltdown."

Only The Meltdown was just the tip of the iceberg. What nobody knew then, but what we know now, was that somewhere else in the universe was an alien race of intelligent insect-things waiting for their chance to come to this old world of ours and take it over. Yeah, you heard me right, Alien invaders. Seems almost comical to say, but it's true. Y2K caused a big hiccup in the world's energy grid, and somehow, these "Bugs" were able to tap into that and create a doorway between their world and ours. A bridge through space. Millions of them came through. Millions, worldwide.

Seems the Bugs can convert their bodies into pure energy whenever they want, so they were able to enter our electrical lines, telephone lines, cable lines, you name it. So when things started coming back on line, the Bugs had the planet covered.

It was worst in the big cities and around major power plants. It seems our multi-legged friends like to eat raw energy, and the stuff we pump out is like a juicy T-bone to them. What's worse, the Bugs can 100% deactivate any electrical machinery just by zapping it with a beam of bio-electric energy they fire out of small "bio-cannons" growing out of their shells. The machines they don't zap, the Bugs can enter and take over. Within a month, at least 90% of the country's mechanized Armed Forces belonged to the Bugs.

After awhile, the Bugs started rounding people up and bringing them to their nearest MSA (Metropolitan Statistical Area) where they were set up in big camps. Once you go in one of these places, the Bugs hit you with some kind of mind control gas that makes you really numb and docile, so you'll do whatever they say. They make people work for them, but it's like you are sleepwalking. This makes it impossible for prisoners to run away or fight them. Then, it's just a waiting game until the Bugs insert a grubby little subspecies of themselves into your body. A little sweetheart we like to call a Silkworm. They are about the size of a big, fat slug, and they crawl up your nose, into your brain cavity, and pretty much override your brain. The person you were is gone, and your body is now the host for its new Bug pilot. And, the Grub can access your memories and skills. See where this is heading?

Before too long, there were legions of "Bugged" humans running the power plants and old electrical infrastructure, providing a three-course meal to the rest of the invasion swarm in the form of electrical power. As far as we can tell, there are literally millions more humans being held in a drugged stupor, waiting to be "Bugged." That's what we're fighting for, as much as anything. To save the folks who haven't been bugged yet. I hate to tell you, but those bugged are gone. Their brains can not be saved. At least not by any method we know. God knows, we've tried everything. The only hope is to rescue those who have not been bugged yet and get them to Free America — anyplace the Bugs haven't already sunk their claws into. To free the land, we must first free the people. Free the people, and then we can squash every last one of the damned Bugs.

It won't be pleasant or easy. The Bugs are no pushovers. They stand at least six feet (two meters) high, with an exoskeleton tougher than most body armor, claws that can rend steel, and organic energy weapons growing right out of their freaking bodies. Sure, they die if you pump enough lead into them, but if they can get to a working electrical socket or a telephone outlet, they can just convert to energy and escape.

Which brings us to sunny point number two: The Bugs like the fact that they have a worldwide, instant deployment mechanism, and they

aren't afraid of using it. If the Bugs feel like they need help, and if they have access to a hardline somewhere, you've got about five minutes before reinforcements arrive. Typically, the Bugs draw down 10 reinforcement troopers for each hostile that's giving them trouble. If they're feeling their oats that day, maybe they'll draw down only three to one. Or if they are angry, you could see one hundred to one. I can't tell you how many friends I've lost in what were supposed to be successful ambushes, only to have a few hundred Bugs pop up off a hardline we didn't know was there. So if you're gonna throw down, you better make sure you can close the sale, fast. Otherwise, you better make sure you have a clean getaway planned out or your last memory is likely to be a big, fat Grub nestling into its new home between your frontal lobes. Hey, like I said, this is not an easy or pleasant job.

Now, you might also be wondering who can help us out here. Of course, you've probably guessed the answer by now: nobody. Even if the Bugs didn't control most of the old military hardware, they'd still be pretty tough to beat. Sure, there are plenty of other citizen armies



out there. And some of them are almost as tough as us Irregulars, but the fact is, the only way we can all survive is by staying in small groups and moving fast. Nobody has the strength to stand up to the Bugs. They have more firepower and greater numbers than any of us. And forget what you've heard about the loose armies coming together, because it's not going to happen.

Don't expect those G.I. Janes in NORAD to bail us out, either. (NORAD's where we headquartered our nuke command before The Meltdown, for those of you who've been living under a rock.) They got a ton of troops and hardware, but they're biding their time to strike, and I can't say I blame them. As soon as they show their faces, the Bugs are going to swarm them big time, so they're making sure they'll have the weapons and the resources to make it a fair fight when that time comes. Of course, it wouldn't hurt for them to share the wealth with us ground-pounders in the boonies, but that's a subject for another discussion.

You might have heard weird stories about the secret projects NORAD is working on. I can't say if they are for real or not, but you might want to keep your ears open when you're out in the field, just in case you hear something good. We have intelligence reports that NORAD's cooked up a corps of super-soldiers who've got Bug DNA grafted to them, as well as a bunch of special operations people with psychic powers. Be on the lookout for them, since they could be your ticket to getting some significant weapons upgrades, things like plasma projectors, chemical weapons that dissolve the Bugs but are harmless to us, and energy weapons modeled after the Bugs' very own bio-cannons.

But like I said, that's NORAD. As far as you and I are concerned, they might as well be on Mars, because we've got our own backyard to tend to. Until those guys get on their feet, it's up to us to cut every hardline, liberate every Bugtown, and blast every Drone camp until there isn't a single Bugged Territory left in the Land of the Free and the Home of the Brave.

This is it, people. This is the reason why we've been put to the test. Your fellow countrymen, and the people of the world are counting on YOU to deliver them to safety. Let's make sure we do just that. And, of course, kill as many of those damned Bugs as we can put a bullet through.

Now, a final word to all you newbies reading this book for the first time. If you made it through The Meltdown, then you've got the guts to survive. And if you managed to find the Wyoming Free Irregulars, then you've got the smarts to become one of us. If you are willing to fight the Bugs after all the bad things you heard (and believe me, they are ALL true), then you have a head full of bad wiring, and should probably be locked away before you hurt somebody. Which makes you just like the rest of us. Welcome to the Bughouse.

Irregulars, Hyah!

*Commander Sortie McAuliffe,
Wyoming Free Irregulars; May 2009*

2009: The Final Word

"Let me tell you something. You can read all the books you want, let cowgirls like Sortie Mcwhat's-her-name up out in Dakota or someplace tell you how tough and ready they are, whatever. Take it from me, 'cause I got what it takes to be a survivor. I lost my whole family when San Francisco went up in smoke, and I even spent some time in one 'a those Bugtowns you hear so much about. The kind where they put worms in your brain to make you do what they tell you. Oh, yeah. Ain't no picnic.

"And let me tell you, there ain't no trick to getting through it all. There ain't! What it comes down to is there are some folks who can survive and some folks who can't. I'm one 'a the ones who can. Mostly on account 'a me having a bunker and a six-pack of .50 calibers to keep away unfriendlies. If you're one 'a the ones who can't, then don't

bother looking for advice, 'cause it won't do you any good nohow. Might as well have some fun and party until the Bugs get you or some Splatterpunk pops a cap in your butt.

"So go on, git. Stop botherin' me.

"You still here? Fine, if I give you some advice, will you go away? Okay, deal then.

"You want to stay alive a little longer, do the following things:

"**One:** Don't ever use anything electric, especially if it's plugged into a power line or phone line or something like that. That's how the Bugs find you.

"**Two:** Don't never drink any water before you boil it and put some 'a those funny tablets in it that makes it taste bad.

"**Three:** Don't believe all this stuff about the 'Bug Hunt' and all.

Those idiots from NORAD are gonna end up as dead as all the other soldier boys.

"**Four:** Learn to eat canned meat and fruit, and bark and such, but don't grow no garden for the Bugs to locate. Me, I scored a trailer full 'a them Happy Dog suppers in a can. Been livin' off them for about a year an' a half now. Starting to like 'em, too.

"**Five:** Learn how to play dead. It works.

"**Six:** Learn to scrounge in the old ghost towns for stuff you want. The best way is to look around all those places you would never thought 'a touching before The Big Meltdown.

"**Seven:** I forget. That's enough ta git you by. Now go away! You bother me. I got me a manifesto to write and my supper's gettin' cold."

— *Todd Witherspoon, Self-styled "Bunker Lord of Idaho"*

The Rules of the Game

By Kevin Siembieda
with additional material by **Bill Coffin**

Before we get into more of the setting, background and adventure of this game world, we have to delve into the nitty-gritty of the game rules and character creation. It's all pretty simple once you get the hang of it. For those of you already familiar with Palladium Books' role-playing games, you are ready to rock and roll.

For all you *newcomers* to role-playing or to Palladium's games, this section describes all the basic rules you need to play **Systems Failure** — and just about any other game from Palladium Books. Virtually *all* of Palladium's games use the same universal rules, so learn one and you can play them all. This also makes each Palladium game interchangeable with one another and creates a truly expansive gaming Megaverse®.

How to Play a Role-Playing Game

Role-playing games are really just an advanced form of regular board games. In fact, they are so advanced that they no longer use a board. Some of the elements are still the same. You still need paper and pencils, dice and players, but the main thing you need to play a role-playing game is *imagination*. Let's take it one step at a time.

Imagine the Scene

Picture a concrete bunker in the wilderness, somewhere in the Pacific Northwest. The bunker is low and squat, like a World War II pillbox. Outside of it is a sign staked into the ground that says "*Piker's Point Trading post: Ammo, Bottled Water, Beef Jerky. Paper Money Not Accepted.*" And outside the pillbox stands survivalist Jeb Nescheske, wearing a flak jacket and toting a 12 gauge as he scans the roadway for signs of life.

Can you picture the scene? Try to keep the mental image in your head. Don't worry if you forget the details; one of the great things about role-playing is the way your memory is improved with practice. Now you are ready for the next step.

Imagine the Setting

A pair of horsemen gallop down the dirt road toward the trading post. They look like U.S. Army Rangers, heavily armed and fully equipped. As they approach, they slow their horses to a canter and hold

their hands up, showing that they are not holding any weapons. "Greetings from the U.S. Government," one of them says. "We're here on a Compliance Check. Any Bug trouble?"

Despite their official appearance, the soldiers seem like impostors. Their voices are flat and emotionless, their complexion pasty, and, they have unsightly purple bruises underneath their noses. Something sure doesn't seem right about these boys.

Okay, we've established a setting and some atmosphere. Now let's figure out where you, the player, fit into this.

Imagine the Character

Now here comes the tricky part. *YOU* are not standing before these odd-sounding troops, nor are you next to Jeb the survivalist. Instead, there is somebody whose eyes you see through. That person is your *character*, an imaginary alter ego that serves as your playing piece for the game. It is your imaginary character that has met with Jeb at the trading post before the riders showed up. It is this imaginary character who reacts and interacts with the other playing pieces — the other characters — such as Jeb and the U.S. soldiers.

Normally, you will spend an hour or so developing a new player character. Once the character has been created, you will probably continue playing the character for many weeks, months, or even years.

In our example, your character is pulling guard duty with Jeb, and right now, you've got a bad feeling that these U.S. soldiers are not what they appear to be.

Imagine the Action

Actually, you need one, important, extra ingredient to make a role-playing game work: a Game Master (G.M.). The G.M. is another player (a real person) who controls all the other characters in the game not played by the other real-life players. In this example, you are the only player character, and the G.M. stands in for Jeb, the soldiers, and any other *Non-Player Characters* (NPCs) that enter the scenario.

The G.M. says to you, "Jeb doesn't think these soldiers are really human. In fact, he thinks they've been "Bugged," which means they are really alien invaders masquerading as humans to destroy your Trading post. Jeb is thumbing the safety off his shotgun and it looks like the Rangers are slowly reaching for their guns, too. What do *YOU* do?"

At this point, you must decide what your playing piece, your character, is going to do. Does he draw his guns and begin blazing away at the troopers? Does he wait for Jeb to make a move and react to whatever happens? Or does he try to communicate further with the troopers to see if they really are human (and friendly)? The decision is yours.

The G.M. will have your opponent(s) react appropriately to your character's actions. Like improvisational theater, you, your fellow players, and the G.M. all play off each other's actions to build an adventure/story together. That's what role-playing is, at its heart, a form of interactive storytelling. When your gaming session is over for the evening, you and your fellow players will have a complete chapter of a larger story locked in your memory. A story that you helped create.

What You Need To Play

Other than imagination, you will also need the following:

G.M. and players: At least two players plus the G.M. An average-sized role-playing group consists of 4-6 players, although groups of 7-12 are not uncommon. Even groups of 13 or more are possible, but such large groups can be difficult to handle, especially for fledgling Game Masters.

Paper and pen: For taking notes and keeping track of your character's equipment, experience points (a way of recording his deeds and accomplishments), and whatever other data about your character and encounters you might feel is important (like the character's personal history, observations, friends, enemies, etc.).

Character sheets: These can be made from a sheet of paper or photocopied from one of Palladium's supplemental sourcebooks. A "character sheet" should contain all the information about your character, including his height, weight, skills, bonuses, special abilities, equipment, etc.

Dice: Two four-sided, four six-sided, two eight-sided, two ten-sided, and two twenty-sided. These can be purchased at most gaming, hobby or comic stores. Even many mainstream bookstores may carry these multi-sided, or *polyhedral* dice. You can also get them at gaming conventions or order them by mail or over the Internet. Often we let you know how many dice to roll with an expression like, "roll 3D6." This means, roll three six-sided dice and add the results together. Dice are also available with four sides (D4), eight sides (D8), ten sides (D10), and even twenty sides (D20). Dice with more than six sides generally are called *polyhedral* dice.

If You Have Never Played

If you've never played a role-playing game before, you're in for a treat, because there's nothing like it.

New players should follow one golden rule: Relax and have fun. Don't let the size or scope of this game book intimidate you. As a player, you don't need to understand every little thing about the game (That is the G.M.'s job). All you need to know are the basics of how to create a character, how skills and special abilities apply to that character, and which dice to roll when. Other players and the Game Master should offer a helping hand and words of advice to "newbies." If you're all new, well, just hang in there and do the best you can. The more you play, the clearer things will get and the better you'll play.

When you first start playing role-playing games, it's natural if it feels a little odd. The text with "D6" this and "D4" that, and lots of other strange items may seem like some incomprehensible secret language that you can scarcely make heads or tails of. You might need help in rolling up your character, picking out skills and equipment, and lots of help rolling dice. Don't worry! This will pass quickly once you get the hang of it.

By the third or fourth time you role-play, you will probably stop feeling like a fish out of water, if you haven't already. Heck, you might find your first time out that you are a natural at gaming. That's what happened when I introduced my wife, Alli, to role-playing. Within hours of rolling up her character, she had practically mastered the system and was having a great time. Chances are, you will too.

Glossary

When I first tried role-playing, figuring out the lingo was half the battle. So for those of you who are new to the hobby, or just new to the Palladium role-playing system, the following lexicon should help you get your feet wet.

Attributes: These are numbers used to evaluate the strengths and weaknesses of your character. For example: P.P. means Physical Prowess; how smooth and agile a character is in combat. A P.P. of 4 indicates that the character is pretty clumsy. A P.P. of 8-11 indicates a character would be a fairly average, coordinated person. A P.P. of 16 or higher would only belong to characters with exceptional agility and reflexes. Attributes are also called "Statistics" or "Stats."

Adventure: An adventure is the heroic story that the player character engages in. It is the responsibility of the G.M. to create and orchestrate each adventure. To this end, the G.M. acts as a combination of referee, narrator, and interactive story prop.

Bonuses: Many skills and abilities provide characters with bonuses to strike, parry, dodge, save, etc. These bonuses are typically added to a particular combat or melee action. Always be sure to include your character's bonuses, since they may make the difference between life or death, or worse.

Campaign: A word used to describe an ongoing role-playing game. If you play the same character with the same G.M. on a regular basis, then you are in a campaign.

Character: Every player (except the G.M.) has a character that serves as an imaginary playing piece. This is also called the *Player Character* or *PC*. The G.M. has many such imaginary playing pieces.

Death: Just as in real life, characters can die. The death of heroes in role-playing games is usually a fairly uncommon event. The amount of death in a campaign usually depends on the individual G.M. and/or the actions of the player characters. Players should take a fictional character's death calmly. Remember, this is just a game. G.M.s should allow players to roll up a new character and include it in the game as soon as it is appropriate for the ongoing game. However, characters should not be a dime a dozen.

Game Master: Also known as the G.M., this is the person who controls the game "world." All the Non-Player Characters are controlled by the G.M. He or she also establishes the setting and develops the adventures, as well as serving as the general referee and rules interpreter.

Game Session & Adventures: Each time you play is considered a game or gaming session. A session can last a couple of hours or half the day. A typical game runs about 3-4 hours. A game session can be a complete story/adventure in itself, like a single adventure comic book story that begins and ends with that session, or it can be a "chapter" in a much larger, continuing story.

Horror Factor (H.F.): Some creatures are so alien, monstrous-looking and frightening, that they exude what is called a Horror Factor. The first melee round that such a creature is encountered, everybody who sees it must roll to save vs Horror Factor (a 20 sided die is rolled).

A successful save is a roll higher than the monster's H.F., and means the defender is not impressed and may attack without hesitation or penalty. He does not have to roll to save again until their next confrontation/meeting in the future.

A failed roll means the individual loses initiative and one of his melee attacks for that round. He is also the last to attack. He must roll again the next melee round. Another failed roll means the same penalties are repeated. When he finally saves, he manages to gather himself and can fight without penalty.

Megaverse®: The trademark we use to identify the multi-genre family of Palladium role-playing games. There are currently nine game lines that make up the backbone of the Palladium Megaverse: **Rifts®**, **The Palladium Fantasy Role-Playing Game®**, **Nightbane®**, **Teen-**

age Mutant Ninja Turtles® & More Strangeness, Deluxe Revised RECON®, Beyond the Supernatural™, Ninjas & Superspies™, Robotech®, and Heroes Unlimited™. It is to this proud tradition that Systems Failure® belongs.

Melee Round: One melee round equals fifteen seconds of game time. Four melee rounds equals one minute.

Non-Player Character (NPC): A character that is not played by any of the players, including villains, other antagonists, the helpless victim, and other characters played by the Game Master (G.M.).

Percentile Dice: Also referred to as "roll percentile." This means roll two different colored ten-sided dice (2D10). Indicate that one color represents "tens" and the other "ones." If an eight appears on the "tens" die and a three appears on the "ones" die, that's a roll of 83%.

Role-Playing Game: This is the generic term for any game with a Game Master, imaginary characters and direct player interaction. Role-playing games are also called RPGs, fantasy role-playing (FRP), and adventure games.

Run: This is just a term gamers use to describe playing a game. Example: "Kevin runs an excellent campaign," or "I ran in Bill's game last week."

Saving Throw: This is a roll (usually on a twenty-sided die) to avoid some unpleasant event. For example: A character might have to roll a saving throw to avoid being overcome by tear gas or mind control.

Scenario: This is a specific adventure that confronts the characters in a role-playing game. A scenario is usually a story with a beginning (hearing about a trading post that's fallen under attack by alien invaders), a middle (organizing your fellow humans into a rescue party) and an end (riding to the rescue, driving off the aliens, and saving the trading post). Most campaigns are developed around a number of scenarios.

CHARACTER CREATION

At first glance, a role-playing game can look intimidating. Page after page of rules and information — how can you ever learn it all? Well, relax. First of all, you don't have to learn everything there is to know about this game. That's why you have this handy book as a companion and reference. Second, a lot of the material is fun to read, but it's not stuff you must know. Take your time and enjoy.

The creation of a character is relatively simple, requiring six main steps. Each is reasonably straightforward. If anything, players will get bogged down with the large number of choices available to them. To that end, most sections offer the option of rolling on random tables for quick and unpredictable character creation. Of course, the players are always free to choose rather than roll, especially if the group wants to make character creation as fast as possible so you can all get to playing right away.

Step 1: Determining the Eight Attributes & Attribute Bonuses

The first step in creating a character is to roll up the eight attributes: I.Q., M.E., M.A., P.S., P.P., P.E., P.B., and Spd. These represent your character's natural mental and physical abilities. Some of the physical

skills and special abilities available to one's character may increase a character's attributes, so it may be wise to write these numbers down in pencil until all modifiers and bonuses are accounted for.

Three six-sided dice (3D6) are rolled to determine each attribute. The higher the number, the greater the ability. If you roll a 16, 17, or 18, that attribute is considered "exceptional," and an additional six-sided die is rolled and added to the total for that attribute. If another six is rolled (very rare), roll again! This bonus die is only rolled during initial attribute generation and does not apply to attributes raised to 16 or higher from skills, O.C.C.s., or special abilities.

Many of the *physical skills* will provide the character with attribute bonuses. For example, Wrestling offers a +2 to P.S. and P.E., so if the player has already rolled a total of 15 for P.S., he adds another two points for a total of 17. If his P.E. was 8, the +2 would raise it to 10. All physical skill point bonuses are cumulative.

The Eight Attributes

Intelligence Quotient (I.Q.): Indicates the character's intelligence. The exact I.Q. is equal to the I.Q. attribute multiplied times ten. Characters with an I.Q. of 16 or better will receive a one-time bonus to all skill percentages, including Secondary skills.

Mental Endurance (M.E.): Measures the amount of mental and emotional stress the character can withstand.

Mental Affinity (M.A.): Shows the character's personal charm and charisma. Natural leaders, with an M.A. of 16 or higher, have a bonus to invoke trust or intimidation in others. A person with a high M.A. may appear trustworthy to some, but intimidating to others. This may depend on the character himself or the circumstances of the situation. At the player's option, a character with a high M.A. may choose to be only especially trustworthy or only intimidating. This explains how your friendly neighborhood ice cream man and some knife-wielding thug might both have the same M.A., but use it differently.

Physical Strength (P.S.): This is the raw physical power of a character. Any character with a P.S. of 16 or better receives a bonus to damage in hand to hand combat.

Physical Prowess (P.P.): Shows the degree of dexterity and agility of the character. A P.P. of 16 or higher is rewarded with bonuses to dodge, parry and strike.

Physical Endurance (P.E.): Demonstrates the character's stamina and durability. The amount of physical punishment and resistance to fatigue, disease, poison and magic are determined by P.E. Characters with a P.E. of 16 or higher receive bonuses to save vs coma, death and toxins.

Physical Beauty (P.B.): An indication of the physical attractiveness of the character. A P.B. of 16 or better will be rewarded with a bonus to charm or impress.

Speed (Spd): The character's Speed times 20 is the number of yards or meters he can run in one minute. Speed x5 is the number of yards/meters covered in a melee round (15 seconds). Dividing the distance covered in a melee round by the character's number of attacks indicates how far he can move on each attack.

Attributes Beyond 30

Mental Endurance (M.E.), Intelligence Quotient (I.Q.), Mental Affinity (M.A.), and Physical Beauty (P.B.) normally max out at 30. Bonuses do not increase should the character have a number higher than 30.

Physical Strength (P.S.): Some characters will acquire a P.S. attribute beyond the limits of the bonus chart. This is usually reserved for those who have been augmented in some way (either through genetic modification, cybernetics, or some other form of enhancement). Occasionally, even normal (albeit exceptional) humans can exceed a P.S. of 30 through a combination of *very* lucky dice rolls and selecting physical skills that provide P.S. bonuses.

In these cases, the damage bonus for a P.S. beyond 30 continues to accumulate at a rate of +1 per each additional P.S. point. Thus, if a P.S. of 30 provides a damage bonus of +15, then a P.S. of 31 gives a damage bonus of +16, P.S. 32 is +17, P.S. 33 is +18, and so on. A P.S. of 40 is the absolute limit for normal humans. NORAD Splicers, a special kind of character with special powers, are the only human characters in this game likely to have a P.S. of 40 or higher.

Physical Prowess (P.P.): The bonus to strike, parry and dodge stops at 30. But for every four P.P. points beyond 30 (i.e., at 34, 38, 42, 46 and 50), the character gets a +1 bonus to his initiative roll. A physical prowess of 50 is the absolute P.P. limit for any character in this game.

Physical Endurance (P.E.): The bonus to save vs poison stops at 30, but the percentage to save vs coma increases by *one point* per each additional point beyond 30. Thus, a P.E. of 31 provides a 31% chance to save vs coma, a 32 is 32%, and so on.

Speed (Spd): The speed of ordinary humans never exceeds 30. However, augmented individuals (NORAD Splicers) *may* go higher than this.

Different Applications of Physical Strength

Carrying Heavy Weights: Normal characters, with a P.S. of 3 to 16, can carry 10 times their P.S. in pounds (P.S.x10 = total in pounds). For example: A character with a P.S. of 9 can carry 90 pounds (40.5 kg). A character with a P.S. of 15 can carry 150 pounds (67.5 kg). **Strong characters**, with a P.S. of 17 or higher, can carry 20 times their P.S. in pounds. This means a character with a P.S. of 18 can carry 360 pounds (162 kg).

Lifting Heavy Weights: Characters generally can lift TWICE as much as they can carry. Thus, a character with a P.S. of 9 can carry 90 pounds (40.5 kg) but can lift 180 pounds (81 kg).

Movement and Exertion: A character can carry the maximum weight load (see *Carrying Heavy Weights*) for their P.E. times 4 minutes. Carrying the maximum weight while running or fighting can only be done for the equivalent of one's P.E. times two minutes. If a character lifts the maximum weight possible (see *Lifting Heavy Weights*), then it can only be held for as many melee rounds (15 seconds each) as the character has points of P.E. A character can run at maximum speed for one minute (four melees) for each point of P.E.

However, don't let these numbers bog down game play. Keep things simple. Light activity, such as walking, jogging, driving, standing guard, doing repairs and similar activity can be conducted for hours without affecting the character adversely. Both players and the Game Master should apply common sense and logic to the duration of an activity. Even intense activity, such as 20 minutes of combat followed by rest or light action, will not significantly impair the character's efficiency. It's all a matter of pacing.

Prolonged periods of combat or heavy exertion (an hour or more of intense, continual physical exertion) will take its toll on the character. Apply the following modifiers once every hour, accumulatively: Speed: -2; Initiative: -2; Parry and Dodge: -1; Damage: -2.

Speed Chart

The following is a simple conversion table of speed factors into *approximate* miles per hour (mph) and kilometer equivalents.

Speed Factor	Approx. MPH	Kilometers Per Hour
5	3 1/2	5.6
11	7 1/2	12
22	15	24
27	18 1/2	29.7
33	22 1/2	36
44	30	48
50	35	56
55	37 1/2	60
58	40	64
66	45	72
77	53	85
88	60	96
110	75	120
132	90	144
220	150	241
293	200	321



ATTRIBUTE BONUS CHART

	16	17	18	19	20	21	22	23	24	25	26	27	28	29	30
I.Q. add to all skills. This is a one time bonus	+ 2%	+ 3%	+ 4%	+ 5%	+ 6%	+ 7%	+ 8%	+ 9%	+ 10%	+ 11%	+ 12%	+ 13%	+ 14%	+ 15%	+ 16%
M.E. save vs. psionic attack	+1	+1	+2	+2	+3	+3	+4	+4	+5	+5	+6	+6	+7	+7	+8
save vs. insanity	+1	+1	+2	+2	+3	+4	+5	+6	+7	+8	+9	+10	+11	+12	+13
M.A. trust/intimidate	40%	45%	50%	55%	60%	65%	70%	75%	80%	84%	88%	92%	94%	96%	97%
P.S. Hand to Hand combat: damage	+1	+2	+3	+4	+5	+6	+7	+8	+9	+10	+11	+12	+13	+14	+15
P.P. parry and dodge bonus	+1	+1	+2	+2	+3	+3	+4	+4	+5	+5	+6	+6	+7	+7	+8
bonus to strike	+1	+1	+2	+2	+3	+3	+4	+4	+5	+5	+6	+6	+7	+7	+8
P.E. save vs. coma/death	+ 4%	+ 5%	+ 6%	+ 8%	+ 10%	+ 12%	+ 14%	+ 16%	+ 18%	+ 20%	+ 22%	+ 24%	+ 26%	+ 28%	+ 30%
save vs. magic/poison	+ 1	+ 1	+ 2	+ 2	+ 3	+ 3	+ 4	+ 4	+ 5	+ 5	+ 6	+ 6	+ 7	+ 7	+ 8
P.B. charm/impress	30%	35%	40%	45%	50%	55%	60%	65%	70%	75%	80%	83%	86%	90%	92%
Spd. No special bonuses other than the raw, natural ability to run.															

Step 2: Determine Hit Points & S.D.C.

Hit Points might best be thought of as life points because they indicate how much physical damage (cuts, bruises, etc.) a character can withstand before he or she dies. These are the points that are observed during a battle (or melee round) to determine how much damage is inflicted on friend or foe. Each time a character is struck by a punch, kick, weapon, bullet or energy blast he takes physical damage. Each individual player keeps score of how many Hit Points his character has by subtracting the damage from his character's Hit Points each time that character is hit and injured. Likewise, the G.M. keeps score of how much damage the player inflicts upon his opponent. When a character has *zero* Hit Points, he is in a coma and will soon die without extensive medical help. When a character's Hit Points have been knocked far below zero, he is dead and beyond saving.

Determining Hit Points

Now that you have some idea of what Hit Points are about, let us get into the technical aspects of their determination and use.

1. Base Hit Points: Having rolled up your eight attributes, you will recall that one is Physical Endurance (P.E.). The Physical Endurance score indicates your character's base/starting amount of Hit Points. This number means that he or she can lose that many Hit Points before dying.

Some of you will have a character with many Hit Points, but don't get cocky. A laser, machine gun or knife in the right hands can whittle you down to size in a melee round. To those who find themselves with a character who has only a handful of Hit Points, don't despair or feel cheated. You'll just have to use cleverness and cunning in avoiding direct confrontations until you've built up your Hit Points (and S.D.C.; more on that later).

2. Building Hit Points: After determining your base Hit Points, pick up one six-sided die, roll it, and add the number to your Hit Point base. This is your total number of *starting* Hit Points.

As your character grows in knowledge and experience, he will gain more skill and expertise. At the same time he will also mature physically, increasing his Hit Points. Thus each time a character attains a new experience level, roll one six-sided die and add it to the existing Hit Points.

S.D.C. or Structural Damage Capacity

There are two types of S.D.C. The first applies to living creatures and is a sort of supplement to Hit Points. The second applies to inanimate, non-living structures such as chairs, locks, doors, buildings, vehicles, body armor, and so on.

Determining physical S.D.C. is simple. Each of the O.C.C.s automatically provides a base S.D.C. rating. Additional physical S.D.C. is gained from physical skills such as Boxing, Wrestling and Gymnastics. In this way you can build and toughen your character as much as you would like.

When a character is hurt, the damage is first subtracted from his or her S.D.C. points. S.D.C. damage is painful, but not deadly. It's like in an action movie where the hero takes a bullet or is stabbed, but is able to keep fighting as if nothing happened. Later, when the hero tends to his wounds, he just slaps a bandage on them and says something glib like, "It was just a scratch." S.D.C. in action.

It is only after *all* S.D.C. has been depleted that damage is subtracted from Hit Points. By comparison, Hit Point damage is serious and potentially life threatening.

G.M.s should use common sense with S.D.C. and Hit Points. Some situations (diving on a grenade, getting shot in the head at point blank range, falling from a great height such as 1,000 feet/305 m, will do damage "directly to Hit Points," skipping S.D.C. entirely.

S.D.C. Type Two: Inanimate objects, such as the walls of buildings, vehicles, furniture, body armor, and so on, also have S.D.C. In this case, the S.D.C. indicates the total amount of damage that the object can withstand. These S.D.C. points function exactly like Hit Points, except that they apply to non-living things. Any damage sustained is subtracted from the S.D.C. When the S.D.C. is reduced to zero, it is broken or smashed beyond repair.

G.M. Note: The S.D.C. system just described is a standard rule in most Palladium Books games. From time to time we hear the complaint, "How can somebody be bashing or shooting into a door and the door is in perfect condition until all of its S.D.C. is depleted?" The answer is, it's not in perfect condition. Using the example of the door, the G.M. should explain exactly what's happening. "You bash into the door with your shoulder. It's a very solid door and you inflict minimal damage (give S.D.C. damage). You realize that it will take quite a while to gain entry this way and you may hurt yourself." Or "You can feel the door give a little under your great strength (give S.D.C. damage). Another bash and the door's frame cracks and moans, but it still holds (give S.D.C. damage). It will take another couple of attempts (as the door's S.D.C. dwindles), but it's definitely giving." Or, "Your sub-machine gun riddles the wood door with a dozen holes (something the player can look through) but the door is still locked and holding strong."

The point is, attacks on normal objects will scrape, dent, crack, splinter, crumble, punch holes through it, and so on, even if the object is not destroyed. To smash or destroy something may require multiple attacks, and in some cases, like being locked behind an iron door or bulkhead without a weapon, proper tools or a suitable special ability, it will be *impossible* to damage the item at all.

Armor Rating (A.R.)

Artificial armor, such as bulletproof vests and bionic armor, also have an Armor Rating (A.R.) as well as S.D.C. The Armor Rating indicates exactly how much protection is afforded by the armor (or object) and how easily it is penetrated. The higher the A.R. the better. If an attack roll to strike with all bonuses is *less than* the A.R. of the armor or objects (door, shield, etc.), the armor absorbs the attack — subtract the damage from the armor's S.D.C. When the armor's S.D.C. is depleted, it no longer affords protection and is useless. Any future attacks will hit the character's body.

If an attack roll to strike, including all bonuses, is *higher than* the A.R., it penetrates the armor and inflicts damage directly to the character's S.D.C. and/or Hit Points.

Note: The defender always wins ties, so if the roll to strike is 16 against somebody with body armor that has an A.R. 16, the attack hits the character, but damages the body armor because it didn't surpass the A.R. protection. However, if that strike roll had been 17 or higher, the attack would have struck an area not covered by the armor or punched right through it, doing damage to the character underneath it.

Natural Armor: Some forms of armor are vastly superior to simple body armor. Such armors include vehicle armor, cybernetic armor, and *Natural Armor*.

Natural armor applies to aliens (like the Bugs) and augmented creatures who have protective skin or an exoskeleton with an Armor Rating. In these cases, a roll to strike that falls *under* the A.R. does hit, but inflicts no damage. Punches and bullets bounce off harmlessly, lasers are deflected, and combat continues. A roll above the Natural A.R. strikes and *inflicts full damage*, first to the physical S.D.C. and, once the S.D.C. is depleted, then to the character's Hit Points.

Recovery of Hit Points and S.D.C.

After a battle, characters who have sustained physical damage must tend to their wounds. The attending of wounds can be administered by fellow characters, trained medical personnel or by oneself, provided the character has the first aid skill and is not physically impaired.

First aid-type skills include basic and immediate treatment, such as bandaging and cleaning of wounds, stopping bleeding and so on, until the character can receive better medical care. This is fine for minor wounds, but serious injuries, like internal bleeding and broken bones, will require professional treatment (or magic). **Note:** Unless a character stops the bleeding of cuts and stab wounds, he will continue to lose blood and suffer damage at the rate of one Hit Point per minute. When all Hit Points are reduced to zero, the character falls into a coma and hovers near death.

Recovery: Non-Professional Treatment. This is basic, first aid-type treatment by oneself, or non-medically trained people. This type of treatment may be used if the character is not able to seek professional treatment immediately. It is not necessarily inferior treatment, especially for not too serious of an ailment, but just lacks the full facilities and experience of a major medical institution. **Rate of Recovery:** Two Hit Points per day (24 hours) and/or four S.D.C. per day.

Recovery: Professional Treatment. This is medical treatment from a doctor, clinic or hospital. **Rate of recovery:** Two Hit Points per day for the first two days and four per each following day, until the character has regained all of his/her original Hit Points. S.D.C. points are restored at a rate of six per day.



Surviving Coma and Death

When a character's Hit Points are reduced to zero (or less), he collapses and falls into a coma. How much damage below zero a character can withstand is determined by the Physical Endurance (P.E.) attribute. A character can take one point of damage below zero (to negative one, -2, -3, etc.) for each P.E. point. **Example:** A character with a P.E. of 9 will lapse into a coma at zero Hit Points, but still lives up to a negative 9. However, if the character receives more damage (which is very possible) than the P.E., he is dead with no hope of recovery. Thus, if a character with a P.E. of 9 takes 10 points or more below zero, exceeding his P.E., he is beyond medical help and dies. Note that some special abilities may extend the amount of damage below zero a character can endure, and in some cases, continue to function.

The length of time a character in a coma will survive without treatment is again indicated by the P.E. Add one hour for each P.E. point.

Example: P.E. 9 = 9 hours, P.E. 10=10 hours, and so on.

Whether a character survives the coma and is stabilized (brought back to at least one Hit Point above zero), is determined by the roll of percentile dice. If the player rolls two successful recovery rolls out of three, the character breaks out of the coma and is no longer in danger of dying. This also means that he is brought up to one Hit Point above zero. Recovery of Hit Points from that time on is standard; see *Recovery of Hit Points*. **Note:** This can be attempted every hour until the character dies.

Recovery Ratio (roll 2 out of 3)

Treatment from unprofessional individuals with medical skills:	01-18%
Treatment from an intern or nurse (R.N.):	01-32%
Treatment from a doctor without proper facilities:	01-46%
Treatment from a doctor at a clinic (fair facilities):	01-56%
Treatment from a hospital:	01-66%
Treatment from a major, large hospital:	01-70%

Optional Damage Rules

It is not very believable for a character with less than 10 Hit Points and no S.D.C. to be dancing around in the middle of combat with little or no impairment. As the human body takes damage, especially Hit Point damage, it will suffer impairment from pain, blood loss, and fatigue. To emulate this in a role-playing game, we apply penalties to the character's actions. Below are some optional tables that list side effects from physical damage. Each time a character suffers damage equal to 10% of his Hit Points (not S.D.C.), roll on the appropriate table (or pick an appropriate result if a called shot was made).

The effects of the damage are generally temporary and cumulative. Thus, if a character suffers the loss of a great deal of Hit Points within a short time, he will suffer the multiple effects of physical damage. *Roll each time severe damage is endured.*

An optional system that is more generic and simpler to keep track of is to apply a penalty of -1 on initiative, -1 to strike, parry, and dodge, as well as -5% to skills and speed for every 10% of Hit Points lost. With this system, a character with 25 Hit Points will receive these penalties for every three H.P. lost (not applicable to S.D.C.)

Optional: Minor Injury Table

None of these effects are permanent or life threatening. Minuses apply to that one limb (50% chance for right or left). Speed minuses affect the whole body. Remember, symptoms and penalties are cumulative; roll each time the character suffers a fall, explosion, or more than 10% of Hit Points in damage from a single attack. **Duration:** 1D4 days (double or triple for serious injury resulting in the loss of 50% or more of the character's Hit Points).

- 01-14%: Minor bruises and lacerations;** -2 on Spd and -1 to dodge.
- 15-29%: Severely bruised and battered muscles;** -1D4 on Spd, -1 to P.P. and -2 to Dodge.
- 30-44%: Damaged (sprained, pulled, cut, etc.) arm or shoulder;** -3 to P.P. and -2 to parry.
- 45-59%: Damaged leg or hip;** Spd is 1/2 and -2 to dodge.
- 60-74%: Damaged hand and/or wrist;** -1 to P.P., -2 to P.S., and can not lift weights of more than 10 lbs. (4.5 kg) with that hand. The character is -10% on all skills that require that hand.
- 75-89%: Head injury;** -5% on all skills and -2 to Spd.
- 90-100%: Damaged back or pelvis;** -1 to P.E., reduce attacks per melee round by one, and Spd by 50%. Furthermore, the character can not lift or carry more than 10 lbs (4.5 kg) without excruciating pain (double all penalties, due to pain, until weight is put down).

Optional: Side Effects From Serious (Hit Points) Damage

Roll on this table only once, when 75% to 99% of Hit Points are depleted. Impairment is temporary, lasting 1D4 weeks.

01-10%: Severely battered and bruised; Reduce Spd by half, combat bonuses by -2 points, and -3 to dodge.

11-20%: **Torn arm muscle;** -3 to P.P., -2 to P.S., -1 attack per melee round, -2 to strike or parry, and the character can not lift or carry anything more than 10 lbs. (4.5 kg) without excruciating pain (double penalties due to pain).

21-29%: **Torn leg muscle;** Reduce Spd by half and -2 to dodge.

30-39%: **Fractured bone (arm);** Reduce P.P. and P.S. by 40%, -5 to strike or parry, and the character can not lift or carry more than one pound (0.45 kg) without excruciating pain (double penalties due to pain).

40-49%: **Fractured bone (leg);** Reduce Spd by half and -4 to dodge.

50-59%: **Fractured bone (ribs or pelvis);** -2 to P.E., reduce attacks per melee round by one, and Spd is halved. Furthermore, the character can not lift or carry more than 5 lbs. (2.3 kg) without excruciating pain (double penalties due to pain).

60-69%: Broken bone (ribs or pelvis); -4 to P.E., reduce attacks per melee by half and Spd by 80%. Furthermore, the character can not lift or carry anything more than 5 lbs. (2.3 kg) without excruciating pain (double penalties due to pain). Duration is doubled.

70-79%: **Punctured lung;** -4 to P.E., reduce attacks per melee by half and Spd by 80%. Furthermore, the character fatigues three times faster than normal.

80-89%: **Weakened immune system and fever;** In this weakened state, the character catches a virus resulting in constant low-grade fever, chills, and fatigue. Reduce P.E. by half, P.S. and P.P. by 25%, reduce attacks per melee round and all bonuses by half, and Spd by 40%. Furthermore, the character fatigues twice as quickly as normal.

90-00%: Severe concussion; Reduce attacks per melee and all combat bonuses by half, reduce Spd by half, and all skills are performed at -30%.

Optional: Recovery Side Effects From Near Death

For a sense of additional realism, a player can roll on this table when a character has lost all (reduced to zero or below) of his Hit Points and has been near death (in a coma). *Impairment is permanent* as a result of the grave physical damage. **Note:** This is not a mandatory table, but it is left up to the Game Master and player's discretion.

01-10%: No permanent damage.

11-20%: Major stiffness in joints; reduce P.P. by 2.

21-39%: Minor stiffness in joints; reduce P.P. by 1.

40-55%: Legs impaired; walk with a limp, reduce Spd by 2.

56-70%: Major scarring; reduce P.B. by 2 points.

71-82%: Chronic pain; reduce P.E. by 1 point.

83-92%: Minor brain damage; reduce I.Q. by 1 point.

93-00%: Major brain damage, reduce I.Q. by 2 and M.E. by 1.

Step 3: Determine Background

Since this game takes place in 2009, most characters will have had *some* recollection of life before The Meltdown. Even a 19 year old character would have been 10 before the world went haywire. Likewise, it is just as feasible for a character to be 40 or 50 and have had an entire career prior to life as a survivor. To this end, every character must pick or roll their pre-Meltdown background as a way of establishing who they once were.

This aspect of character creation is designed to help craft the personality and personal history of your character. While each background brings with it certain skills, one shouldn't pick their background solely based on how their character might benefit from it. It is okay if your character has a less than heroic background, like being a waitress, ac-

countant, or garbage man. In fact, in the terms of this game, that's a good thing, since it more sharply juxtaposes who your character *was* to who your character is. This enables the player to create some pretty interesting characters with bizarre life stories. Keep in mind, this is a world where everything was suddenly turned upside down and somehow, through the madness, arose a new generation of heroes who never knew they had it in them until the severity of their surroundings brought out their *true* nature.

The following Background Tables are a selection of possible backgrounds to pick/roll from. You will notice that every background brings with it certain skills to the character. The character's background represents who he was nine years ago, so these skills are the core of whatever expertise or experience he had at that time. In the nine years since, the character has built himself into his current O.C.C., so his old skills have atrophied seriously.

For game purposes, the character's background skills are frozen at first level proficiency. That means a 5th level character with 5th level skills in his current persona, still knows his old background skills, but at 1st level proficiency. Even skills they used to know by heart have grown rusty and unreliable. This isn't meant to cripple characters as much as it is to drive home just how far away the character has gotten from his previous life.

If characters wish, they can "reactivate" background skills when they pick additional skills as allowed by their new Meltdown O.C.C. In general, characters can trade one new O.C.C. Related Skill (or two Secondary Skills) to reactivate one old skill. So, a character can use two extra skills to reactivate — keep — two old background skills. Reactivated skills advance in level as the character does in his new post-Meltdown O.C.C.

This means a character who was once a doctor can choose not to pick all the new Meltdown O.C.C. skills but to keep a few old medical skills instead. This is a fair trade-off since the character's old skills *replace* some of those normally associated with the new Meltdown O.C.C. For the sake of simplicity, all skills, new and old, start at level one, but the old skills that were kept (via trade of new skills) increase in level of proficiency as the character grows in experience.

A final note: If you want your character to have a background not listed here, then by all means, please feel free to make one up (with the G.M.'s approval, of course). In general, give your background either one skill program or its equivalent (4-5 skills).

How Old You Were Before the Meltdown

01-10%: Kid. You were only 8+1D6 years old when the Meltdown occurred, making you from 18-23 now. For background skills, select the Physical/Athletics Program (You always *did* throw a wicked dodgeball).

11-30%: High Schooler/Teenager. You were 15-18 when the Meltdown occurred, making you from 24-27 now. For background skills, select one of the following skill programs: Domestic and Physical/Athletic or Technical. Or, select five individual skills.

31-40%: College Student/Young Adult. You were 19-23 when the Meltdown occurred, making you from 28-32 now. For background skills, select any one skill program *except* Criminal, Espionage, Medical Doctor, Robotics, and Professional Thief. Or, select five individual skills.

41-00%: Adult. You were from 19-50 when the Meltdown occurred, making you from 28-59 now. Chances are, you had some kind of career path set up that could be as exotic as a professional thief or as mundane as selling life insurance. To determine background skills, consult the following Background Occupation table. With the G.M.'s approval, you could also make up your own background occupation and assign to it any *one* skill program, or *any five* individual skills, without restriction, as the Background Skills that come with it.



Background Occupation Table

Note: In addition to the skill program listed, the character is literate in English, has Math: Basic, and can pilot an automobile.

01-04%: Executive, Administrative and Managerial. The character held a 9 to 5 white-collar job. He may have been a peon or on top of the corporate ladder. Examples: Accountant, administrator, analyst, auditor, general manager or executive, government chief executive or legislator, inspector/compliance officer, insurance underwriter, loan officer, management analyst or consultant, purchaser. Background Skills: Business Program.

05-08%: Marketing and Sales. This could range from the guy selling papers on the street corner to a big mover and shaker within the financial services world. Examples: Retail or wholesale salesperson, independent shopkeeper, retail store manager, insurance or real estate agent/broker, securities and financial services sales rep, travel agent, marketing/advertising or public relations specialist. Background Skills: Business or Technical Program.

09-12%: Administrative Support. Examples: Bank teller, adjuster/investigator/collector, clerical supervisor or manager, computer

operator, court reporter or stenographer, general office or desk clerk, receptionist or secretary, messenger, dispatcher, stock or shipping clerk, postal carrier, record keeper, telephone operator, typist/word processor or data entry. Background Skills: Technical Program.

13-16%: Professional/Technical. Examples: Engineer or engineering technician, architect/drafter/landscape architect/surveyor, legal (paralegal, lawyer or judge), economist, urban/regional planner. Background Skills: Electrical, Mechanical or Technical Program.

17-20%: Computer, Mathematical, or Research. Examples: Actuary, computer programmer, systems analyst, mathematician or statistician, researcher (scientific, commercial or academic). Background Skills: Business or Technical Program, plus the Math: Advanced and Computer Operation skills.

21-24%: Science. Examples: Biologist, botanist, chemist, geologist or geophysicist, meteorologist, physicist, astronomer, scientific or laboratory technician. Background Skills: Electrical or Mechanical Program or the Science Program.

25-27%: Social and Recreation Worker. Examples: Recreation worker, social and human service assistant, social workers. Background Skills: Domestic and Research/Investigative or Technical program.

28-30%: Clergy. Examples: Minister, rabbi, priest, monk, cleric, missionary, etc. Background Skills: Domestic or Technical Program.

31-33%: Comic Book Collector or Bookworm and/or Dealer or Trader of Comics or Books: Literacy (of course), Computer Operation, Research and either Business & Finance or Art.

34-37%: Educator. Examples: Adult education teacher, archivist/curator, college or university faculty, counselor, librarian or library technician, schoolteacher (Kindergarten, elementary, or secondary), special education teacher. Background Skills: The Research skill plus one of the following: Communications, Journalist/Investigation, or Technical Program.

38-40%: Medical. Examples: Chiropractor, dentist or dental hygienist, optometrist, physician/surgeon, podiatrist, veterinarian, dietitian or nutritionist, medical therapist (occupational, physical, recreational), pharmacist, physician assistant, registered nurse, speech-language pathologist or audiologist, dispensing optician, emergency medical technician, medical/laboratory technologist or technician, mental health (psychologist, psychiatrist, mental therapist). Background Skills: Medical Assistant, Medical Doctor, or Medical Investigation Program.

41-44%: Communications. Examples: Broadcast technician, public relations, radio or TV announcer or newscaster, reporter or correspondent, writer/editor, publisher or producer. Background Skills: Communications or journalist/Investigation, or either a Language or Technical Program.

45-48%: Visual Arts. Examples: Designer, photographer and camera operator, visual artist (painter, sculptor, illustrator, etc.). Background Skills: Technical Program.

49-52%: Performing Arts. Examples: Actor/director/producer, dancer/choreographer, musician. Background Skills: Domestic or Technical Program.

53-56%: Food Service. Examples: Chef, cook, kitchen worker, caterer. Background Skills: Domestic Program.

57-60%: Personal Service or Building/Grounds Service. Examples: Barber or cosmetologist, flight attendant, janitor or cleaner, landscaper or groundskeeper, preschool teacher, child care worker, maid or butler, personal assistant, non-farm animal caretaker. Background Skills: Domestic or Technical Program.

61-62%: Protective Service. Examples: Correction officer, firefighter, security guard or bodyguard, police/detective or special agent, or private detective. Background Skills: W.P. Revolver or Automatic Pistol and one of the following: Journalist/Investigation, Physical/Athlete, Police/Law Enforcement or Weapons Proficiency: Modern Program.

63-64% Computer Nerd/Enthusiast: Computer Operation, Computer Programming, and either Computer Hacking or TV & Video.

65-68%: Mechanical. Example: Automotive body repair, electronic equipment repair, telephone installation and repair, elevator installation and repair, mechanic, heating/air conditioning or refrigeration technician, line installer or cable splicer, millwright, musical instrument tuning or repair, vending machine service and repair. Background Skills: Electrical, Mechanical (General) or Mechanical (Vehicular) Program.

69-72%: Construction. Examples: Bricklayer, stone mason, carpenter, carpet installer, concrete mason or terrazzo worker, drywall worker, electrician, glazier, insulation worker, painter or paperhanger, plasterer, plumber or pipe fitter, roofer, sheet metal worker, structural or reinforcing ironworker, tile setter. Background Skills: The Carpentry and General Repair skills plus Physical/Athlete or Technical Program.

73-76%: Production. Example: Assembler, blue-collar worker supervisor, fisher, hunter, forester/logger, miner, food processor, inspector/tester or grader, metalworker or plastics worker, plant or systems operator, printer, textile/apparel worker, woodworker. Background Skills: Physical/Athlete or Technical Program.

77-80%: Transportation and Material Moving. Examples: Driver, aircraft pilot or air traffic controller, rail engineer, boat or ship captain or crew member, industrial material-mover. Background Skills: Pilot (Basic) Program plus the Radio: Basic skill.

81-84%: Helper, Equipment Handler or Unskilled Laborer. Examples: Freight, stock or material mover, packer/packager, machine feeder/unloader, service station attendant, garbage man, vehicle washer or equipment cleaner, parking lot or toll booth attendant, helper (construction, mechanical or production), construction craft laborer, hazardous waste cleanup, asbestos/lead abatement. Background Skills: Physical/Athlete, or Pilot (Basic), or Domestic Program.

85-88%: Agricultural. Examples: Crop farmer, orchard worker, livestock farmer, migrant worker, field hand, grounds keeper, or worker in a hothouse or nursery. Background Skills: The Botany skill plus Technical or Physical/Athlete, or Survival/Wilderness Program.

89-92%: Military. Examples: Soldier or civilian-style support occupation. Background Skills: Soldiers get the Military (Basic) Program plus one of the following: Espionage, Military Demolitions, Pilot (Basic) or Pilot (Advanced) Program. Those with civilian-style support occupations will have held a job described in one of the other *Background Occupation Categories*, even though he worked for the military; pick any one of the skill programs defined in the other Background Occupation categories.

93-94%: Professional Athlete. Examples: Baseball, football, basketball, ice hockey, soccer, boxer, skier, ice skater, martial artist, race car driver, runner, weightlifter, mountain climber. Background Skills: Physical/Athlete Program for most athletes. *Race Car Drivers* get the Pilot Basic and Advanced programs. *Martial Artists* get the Weapon Proficiency: Ancient Weapons Program and the Hand to Hand: Martial Arts skill. *Marksman/Target Shooter:* Modern W.P. Program.

95-96%: Game Designer: Literacy (of course), Writing, Research, Computer Operation and either Business & Finance or Art.

97-00%: Criminal, Vagabond or Perpetually Unemployed. Criminal: The character has spent his years as a professional crook. Select either the Criminal or Professional Thief Program. At the player/G.M.'s option, the character may have spent 2D6 years in juvenile detention, jail or prison before The Meltdown. The character may still have been in jail during The Meltdown, but escaped. Whether or not the character is reformed is up to the player.

Vagabond/Hobo: The character has never had any kind of formal education or job training. Select either the Physical/Athletics Program (to reflect how the character has had to toughen up to survive) or select 5 Secondary Skills. As an *optional* characteristic, the player may choose or roll one random insanity to give the character some additional color. This mental illness might explain why the character was living on the streets in the first place.

Perpetually Unemployed: For some reason, the character could never hold a job, becoming a Jack-of-all-Trades, and master of none. Select any five skills of choice (any). For kicks, the player might want to make the skills as disparate as possible to reflect the character's wide (but shallow) range of experience.

Note: If the player wishes to use a Background Occupation not listed here, then simply pick *any five* individual skills to reflect the character's past job/training.

Birth Order

01-30%: First Born
31-44%: Second Born
45-55%: Third born
56-65%: Fourth Born
66-80%: Last Born
81-90%: First Born of Twins
91-00%: Illegitimate

Weight

01-10%: Skinny
11-30%: Thin
31-55%: Average
56-74%: Husky
75-89%: Pot-Bellied
90-00%: Obese

Height

01-30%: Short
31-70%: Average
71-00%: Tall

Average heights:

Male: 6 feet (1.8m)
Female: 5 feet, 6 inches (1.7 m)

Disposition

01-10%: Mean, suspicious, vengeful.
11-15%: Shy, timid, tends to be a loner.
16-20%: Gung-ho, guts and glory type who sees himself as a hero.
Likes combat.
21-25%: Worry wart, nervous and cautious.
26-37%: Hot-head, quick-tempered, emotional, but basically nice.
38-45%: Schemer; gambler who likes to take chances.
46-50%: Blabbermouth, nice guy, but too talkative.
51-56%: Wild man, cocky, overconfident, takes unnecessary risks.
57-66%: Nice guy, friendly, courteous and hospitable.
67-76%: Snob, arrogant, feels superior to others.
77-84%: Tough guy, self-reliant, cocky, a lone wolf.
85-89%: Paternal, overbearing, overprotective of others, especially young characters.
90-94%: Complainer, constantly aggravated about something.
95-00%: Paranoid, trusts no one.

Land of Origin

01-10%: Australia
11-20%: Great Britain
21-55%: United States
56-70%: Canada
71-80%: Europe; may speak English or not.
81-85%: Africa; may speak English or not.
86-92%: Mexico, Central America or South America (speaks English?)
93-00%: Asia/Orient (China, Korea, Japan, etc.; speaks English?)

Note: The Land of Origin Table is designed with the assumption that the majority of players in this game will be *North American* (USA, Canada & Mexico) and want to play characters from their native homeland. Furthermore, it is assumed that characters operating in North America were either living there (even born and raised there with only ethnic heritage to foreign lands) or were visiting when The Meltdown occurred.

Players should feel free to *select* whatever country and language they desire as their character's homeland. Characters of non-English speaking ethnic backgrounds can usually speak and understand English and one additional language at 75% proficiency, but are not literate in whichever is considered their "second" language. Add +15% to the foreign language skill if that language is also studied as a separate skill. Those of you not from North America who are adapting this game to your homeland, please feel free to adjust this table to reflect your national neighbors and ethnic makeup.

Childhood Environment

01-20%: Agricultural/Farm Community
21-40%: Countryside, small town or village.
41-60%: Suburb, a small city or a large town.
61-85%: City (population of 200,000 to 500,000).
86-00%: Metropolis (e.g., New York, Los Angeles, Detroit, Toronto, Mexico City, etc.).

Social/Economic Background

01-09%: Military/Middle Class
10-19%: Laborer/Poor
20-29%: Laborer/Lower Class
30-59%: Laborer/Middle Class
60-74%: Skilled/Middle Class
75-84%: Highly Skilled/Upper Middle to Upper Class

85-89%: Political/Upper Middle Class
90-00%: Wealthy

Note: A character's social/economic background typically pertains to his or her life *before* The Meltdown. By 2009, the year of the game setting, most "survivors" are in the same boat, having to survive in a resource-scarce world, getting by on meager weapons, supplies, equipment and trade. The only folks who are truly "wealthy" anymore are those special individuals who belong to any one of the listed O.C.C.s and whose extraordinary actions gain them extraordinary rewards.

Step 4: Determine Psionics

Most people in Systems Failure have psychic potential but not the ability to tap into it. Those gifted few may develop certain extrasensory powers along the way. Extremely gifted individuals may be perfect candidates for becoming a *NORAD Psychic*. Note: Players who do not want their character to be psychic at all, need not roll on this chart. Likewise, it is assumed that NORAD Psychic characters will possess Major Psionics without having to roll for them.

Random Psionics Table

Roll percentile dice. Psychic abilities are described elsewhere in this book.

01-09% Major Psionics can select a total of eight powers from any *one* category (*Sensitive*, *Physical* or *Healer*) or a total of six powers with selections made from all three categories. While the Major Psionic is a natural candidate to become a NORAD Psychic, they may select any O.C.C., however, the extra time the psychic must spend to develop his abilities means that all skill bonuses are reduced by half, and the number of "other" skills are also reduced by half. Base I.S.P. is the character's M.E. +4D6, +1D6+1 per level of experience.

10-25% Minor Psionics may select three powers from any *one* of the following psionic categories: *Sensitive*, *Physical* or *Healer*. In the grand scheme of things, power of this level is considered inconsequential; practically a "parlor trick" psychic. The base Inner Strength Points (I.S.P.) are the character's M.E. +2D6. At each level of experience, add +1D6 I.S.P.

26-00%: Not psychic. Sorry.

Step 5: Pick an O.C.C.

A character's Background determines what he once *was*, but his Occupational Character Class (O.C.C.) determines what he is *NOW*. There are nine basic O.C.C.s and two special ones, all of which reflect a heroic role the character has taken on since The Meltdown.

The nine basic O.C.C. are the *Splatterpunk*, *Grease Monkey*, *Egg-head*, *Survivalist*, *Exterminator*, *Freebooter*, *Peacekeeper*, *Medicine Man* and *Wacko*. The two special O.C.C.s are the *NORAD Psychic* and the *NORAD Splicer*.

Detailed information on each O.C.C. Begins on page 79.

Step 6: Pick an Alignment

All players *must* choose an alignment for their character. This defines a character's attitudes and moral center. There are three basic alignment categories: *Good*, *Selfish* and *Evil*.

Alignments are an important factor in developing a character and the elements of "role" playing. Whether we are consciously aware of it, every person has his or her own code of ethics and morals, as well as a

sense of justice and what constitutes good and evil, right and wrong. It is this sense of right and wrong that helps build our moral fiber, mold our behavior, and dictate our reactions to people, events, and circumstances in the world. It is this code that makes the thought of stealing or hurting somebody abhorrent to one person but acceptable to another.

Alignments should be regarded as a guideline for the character that will indicate how he or she is likely to react to any given situation, violence, good and evil. Try to stay in alignment and act accordingly. However, a player may find himself slipping (or slipped) out of character. The G.M. should stop the game for a moment and, as the referee/director of the story, point out that the player's intended actions go against his alignment. The G.M. should then warn that moving forward will cause the character to change alignment. For example: A principled good character that acts out of hatred and deliberately tortures another being is likely to drop to the *anarchist* or even *miscreant* alignment. A principled character who decides to steal or "bend" the law is likely to drop to an *unprincipled* alignment. Meanwhile, a *miscreant* evil character who has learned the value of friendship and begins to perform acts of goodness and compassion, or forsakes his villainous ways, may go up to anarchist or unprincipled (and eventually, even higher). Playing in character (e.g., in alignment) can be a challenge, but it is always fun.

No Neutral Alignments

There is no such thing as an absolute neutral alignment. A character with an absolute, true neutral position could not make a decision, fight tyranny, hurt others, go adventuring, or take any action of any kind without leaning toward good, evil, or self-gratification. It is humanly impossible, and therefore is eliminated in the context of this game.

There are some philosophers out there who might disagree with this, but that's a topic for another forum and not a factor of this game. Sorry, this is one of the very few definitive, unbending rules.

Good Alignments

Good-aligned characters (*Principled* and *Scrupulous*) are the straight-up heroes of this world. They generally place a high value on life and liberty, as well as law and order. Just because a character is of a good alignment does not make him a saint, however. Good characters can be irritating, obnoxious and arrogant, even prejudiced and full of quirks. Likewise, they may find themselves stepping outside the boundaries of the law in their quest to combat evil and injustice. But when push comes to shove, these characters can *always* be trusted to do the right thing in a life and death situation.

Principled (Good)

Principled characters are upright "boy scout" or "do-gooder" types who put others before themselves. This is the knight in shining armor, with the highest regard for the lives and well-being of others, freedom, truth, honor and justice. Principled characters will always *attempt* to work with and within the law, and have a high regard for (and trust of) authority, as well as for life and freedom. He or she is usually compassionate, merciful, cooperative and sincere.

A principled character will...

1. Always keep his word.
2. Avoid lies.
3. Never kill or attack an unarmed foe.
4. Never harm an innocent.
5. Never torture for any reason.
6. Never kill for pleasure.
7. Always help others.
8. Always work within the law whenever possible.
9. Never break the law unless conditions are desperate. This means no breaking and entering (even in this post-apocalyptic setting), theft, torture, unprovoked assaults, etc.
10. Respect authority, law, self-discipline and honor.
11. Work well in a group.

12. Never take "dirty" money, or ill-gotten valuables or goods. This means any property that belongs to criminals or villains. It matters not how the bad guys got that property themselves; the hero will not touch it even if destitute.
13. Never betray a friend.

Scrupulous (Good)

Scrupulous characters value life and freedom above all else and despise those who would deprive others of them. This type of hero is typically portrayed in many movies as the cop who plays by his own rules, forced to work beyond the law for justice (or retribution) and the greater good of the people. They are not vicious or vindictive characters, but are individuals driven by their sense of justice to right a wrong or take a (bloody) stand. These characters will always attempt to work with or within the law whenever possible.

A scrupulous character will...

1. Keep his word to any other good person.
2. Lie only to people of selfish or evil alignments.
3. Never attack or kill an unarmed foe.
4. Never harm an innocent.
5. Never torture for pleasure, but may use muscle to extract information from criminals or evil characters.
6. Never kill for pleasure, will always attempt to bring the villain to justice alive, no matter how vile he may find him.
7. Always try to help others.
8. Attempt to work within the law whenever possible.
9. Bend and, occasionally, break the law when deemed necessary. This means he may use strong-arm techniques, harass, break and enter, steal, and so on (but only against the bad guys).
10. Distrust authority; fears the law and government may not be an effective weapon against injustice and crime. However, he will try not to flagrantly disregard the law.
11. Work with groups, but dislike confining laws and bureaucracy (red tape).
12. Never take "dirty" money or items.
13. Never betray a friend.

Selfish Alignments

Selfish characters (*Unprincipled* and *Anarchist*) are not necessarily evil, but they always have their own best interests at heart and their opinions in mind above all others. These are the mercenaries, rogues, vigilantes and anti-heroes of the world.

Unprincipled (Selfish)

This basically good person tends to be selfish, greedy, and holds his personal freedom and welfare above almost everything else. He dislikes confining laws and self-discipline and distrusts authority. He views the law and government as well intentioned, but clumsy and ineffective. Keeping his best interests in mind, the character will always look out for himself.

This character is also likely to take "dirty" money and items, with the concept that it will help him in his crusade against evil. He may also destroy the property of known criminals. He will not deal in illegal wares, drugs, or take money from innocent or good people. The unprincipled character may associate with both good and evil characters, and often has paid informants, spies and stoolies.

This is the noble scoundrel, the guy who is always looking for the best deal, associates with good and evil characters, is continually tempted to lie and cheat, and hates himself for being loyal, helping others and ultimately doing the "right thing."

An unprincipled character will...

1. Keep his word of honor.
2. Lie and cheat if necessary (especially to those of anarchist and evil alignments).
3. Not kill an unarmed foe (but will take advantage of one).
4. Never harm an innocent.

5. Not use torture unless absolutely necessary.
6. Never kill for pleasure; will *attempt* to bring the villain to justice alive and ruin him rather than simply kill him.
7. Usually help those in need.
8. Rarely attempt to work within the law.
9. Blatantly break the law to achieve his (usually good-intentioned) goals.
10. Dislike and distrust authority, the law and bureaucracy. Feels they have been corrupted and abused.
11. Work with groups, especially if it serves his needs, is profitable, and/or he is in the limelight.
12. Take "dirty" money.
13. Never betray a friend.
14. Have a high regard for life and freedom.

Anarchist (Selfish)

This type of character likes to indulge himself in everything. He is the insurgent, con-artist, gambler and uncommitted freebooter who adventures because he enjoys the thrill, fame and fortune it brings, rather than for any cause (like defending humanity or rebuilding the shattered country). This character will at least *consider* doing anything if the price is right or the challenge is alluring enough.

Laws and rules infringe on personal freedom and were meant to be broken. He will not hesitate at using strong-arm techniques, breaking and entering, theft, harassment, destruction of private property, and so on. This can also include acting as judge, jury, and executioner. These characters are usually the daring anti-heroes who feel the end justifies the means. The anarchist-aligned person is always looking for the best deal and self-gratification. He will work with good, selfish and evil characters to attain his goals. The anarchist is continually teetering between good and evil, rebelling against and bending the law to fit *his* needs. Mercenaries and thieves often fall into this category.

An anarchist character will...

1. Keep his word, but only if it suits or pleases him.
2. Lie and cheat if he feels it necessary.
3. Not likely to kill an unarmed foe, but certainly will knock out, attack or beat up one.
4. Never kill an innocent, although his rash or self-serving actions may injure or kill bystanders by accident.
5. Use torture to extract information, but not likely to do so for pleasure.
6. Seldom kill for pleasure.
7. Not likely to help someone without some ulterior motive (even if it's only to show off).
8. Rarely work within the law unless it serves his purpose.
9. Constantly break the law to achieve his goals.
10. Have little respect for authority, the law, or self-discipline.
11. Does not work well within groups; tends to do as he pleases, despite orders to the contrary.
12. Takes "dirty" money without hesitation.
13. May betray a friend. Sorry, pal.

Evil Alignments

All evil characters (*Aberrant*, *Miscreant* and *Diabolic*) are not necessarily bent on universal genocide or dominating all other living creatures. Nor are all evil characters sadistic and untrustworthy. Many evil characters may actually seem kind or likeable.

Evil alignments are a step beyond the self-gratification of the selfish alignments. Evil characters are ruthless individuals who are willing to say or do anything to achieve their goals. Most commonly, evil characters have goals that either entail making people suffer or cause suffering as a side effect (a side effect the evil character knowingly and callously disregards). Human life has little meaning to them, and friends tend to be (but not always) people to use and discard when they



are no longer of value. Evil aligned characters do not automatically slay any good-aligned person because of different ethics and philosophy. All the better to use good to achieve their own goals, for the end always justifies the means.

Note: There is nothing wrong with *playing* a fictional, evil character, although he may not survive too long if he betrays or harms too many people. Nor be liked or trusted by his "good" teammates. However, this is role-playing, not reality, so one can play any type of character he desires, just continue to play in character. That having been said, player characters in **Systems Failure** tend to be brave, self-sacrificing heroes.

Aberrant (Evil)

The cliché that there is "No honor among thieves" is false when dealing with the aberrant character. This is an individual who is driven to attain his goals through force, power, and intimidation. Yet the aberrant character stands apart from the norm with his own personal (and twisted) code of ethics. He expects loyalty from his minions, punishing disloyalty and treachery with a swift, merciful death or banishment. An aberrant character will always keep his word of honor and uphold any bargains. He will define his terms and live by them, whether anyone else likes them or not.

If an anti-hero, he will completely disregard the law and deal out justice as he deems fit. He will never be cruel or vindictive, and will always be absolutely positive that the person is guilty before he deals out his brand of justice. However, once he condemns a character, he will see to it that he is destroyed.

Whether a villain or a corrupt or extreme anti-hero, the aberrant character looks upon people without honor or a sense of loyalty as worthless and disgusting lowlives.

Do not think of the aberrant character as a misguided good guy. He or she will break all laws with impunity, harass their victims, destroy property, assault, blackmail, torture and murder. Only their methods and degree of violence may vary.

An aberrant character will...

1. Always keep his word of honor (at least to those he deems worthy of it).
2. Lie and cheat to those not worthy of his respect; good, selfish or evil.
3. May or may not kill an unarmed foe.
4. Never kill an innocent; particularly a child, but may harm, harass or kidnap.
5. Never torture for pleasure, but will use it to extract information and intimidate others.
6. Never kill for pleasure; will always have a reason.
7. May or may not help someone in need.
8. Rarely attempt to work within the law.
9. Break the law without hesitation.
10. Have no use for the law or bureaucracy, but respects honor, self-discipline and the "concept" of laws and order.
11. Work with others to attain his goals.
12. Usually take "dirty" money, although his twisted code of ethics may prevent him from doing so in some instances.
13. Never betray a friend. Never.

Miscreant (Evil)

This self-serving, unscrupulous character is out only for himself. Power, glory, wealth, position, and anything that will make his life more comfortable or pleasurable is his goal. It doesn't matter who gets caught in the middle, as long as he comes out smelling like a rose. The character will lie, cheat, hurt, and kill anyone to attain his personal goals.

If a miscreant character becomes a vigilante, mercenary, or bounty hunter, it will be for some personal reason, a vendetta, money, glory or a love for danger and challenge. This character is a savage misanthrope out for himself.

A miscreant character will...

1. Not necessarily keep his word to anyone.
2. Lie and cheat indiscriminately (good, evil, selfish).
3. Kill an unarmed foe as readily as he would a potential threat or competition.
4. Use or harm an innocent.
5. Will use torture for extracting information and pleasure.
6. May kill for sheer pleasure.
7. Feels no compulsion to help without some sort of tangible reward for him.
8. Have no deference to the law, but will work within the law if he must.
9. Blatantly break the law for his own goals and pleasure.
10. Dislike and distrust authority and the law.
11. Works with others if it will help him attain his personal goals.
12. Take "dirty" money, stolen goods, and illegal items (as well as steal valuables for himself whenever the opportunity arises).
13. Betray a friend if it serves his needs.
14. Have no respect or concern for the lives or welfare of others.

Diabolic (Evil)

This is the category that most megalomaniacs, psychopaths, and violent and despicable characters fall into. This is the cruel, brutal killer who trusts no one and has no value for any life other than his own. A diabolic character will crush anyone that gets in his way. The lowlife will lie, cheat, con, abuse and kill anyone less powerful than he is. Aberrant characters find these dishonorable people more revolting than a good aligned character.

A diabolic character will...

1. Rarely keep his word, and has no honor.
2. Lie to and cheat anyone.
3. Most certainly attack and kill an unarmed foe.
4. Hurt and kill an innocent without a second thought and for pleasure.
5. Use torture for pleasure and information, regularly.
6. Kill for sheer pleasure.
7. Be likely to help someone only on a whim (or to set them up for some evil deed later).
8. Rarely attempt to work within the law.
9. Blatantly break the law and mock authority.
10. Despise honor, authority and self-discipline. Views them as weaknesses.
11. Not work well within a group; constantly disregarding orders and vying for power/command.
12. Always take "dirty" money, drugs, stolen goods, etc., as well as steal from others.
13. Betray a friend without hesitation; after all, you can always find new friends.
14. Associate mostly with other evil alignments.



Experience Points

Except in specially devised scenarios and tournaments, there is no winner in a role-playing game. The accumulation of heroic deeds, friends, prestige, weapons, equipment, knowledge, and skills can be construed to be the results of winning. If a character survives and meets with success in his endeavors, that is winning. However, there are rewards besides the acquisition of material goods and reputation, and those are developing your character's skills, knowledge, and abilities. This is accomplished by earning experience points.

Experience Points & Their Application

The ultimate purpose of experience points and experience levels is to provide a means by which the player's character can grow and develop. Many other role-playing games have their own unique system, charts, equations, and computations for distributing experience points. You may want to adapt one of these systems to this game if that's what you're comfortable with. Still other role-playing games avoid the whole question of experience points by using a system in which points are pumped back into the character's skills, attributes and abilities. If that's how you want to handle it, go for it.

The Palladium game system promotes a subjective method of using observation and logic to determine experience point rewards. Lots of experience systems focus on the "kill factor," but what about the thought process? What about the decisions, plans and motives behind a particular action? Doesn't cleverness and a cool head count? Shouldn't the brilliant medical student playing a character with an I.Q. of 4 (and staying firmly in character, saying and doing things as the dull-witted character would, even though he realizes the stupidity as a player) get experience for playing "in character?" Absolutely! Considering how flexible and subjective most of the other role-playing conditions and rules are, there isn't much logic in having a strict, limited experience point system.

Each player's character involved in a given situation or confrontation should receive the appropriate experience points. The G.M. should make a list of his players at the beginning of the game and jot down each player's experience points as they gather them throughout the course of the game. At the end of the game, the G.M. totals each player's points and gives them the total, so that they can keep track of their growing experience and skills.

The difficulty with this system of determining experience points is its subjectivity. The G.M. must utilize the proceeding experience outline with some thought. For Example: Eight third level heroes armed to the teeth attack and subdue a lone fourth level villain. The eight players should receive experience points for subduing a minor menace. After all, the poor guy had no chance and presented no real threat to the characters. However, if one or two first or second level characters subdued or killed the same villain, they should receive experience for subduing a major, or possibly a great menace, because the danger and the ingenuity involved was much greater for them.

This system should promote imaginative playing instead of mere hacking and slashing. G.M.s, don't feel that you have to shower your players with tons of experience points. Be fair and tolerant. Let your players truly earn their experience points, growing in skill, knowledge and power. If you have a group of players with characters rising rapidly in experience levels, you will know it's because they are clever and imaginative. That's what this game is all about!

Character Experience Levels

An experience table is provided for each Occupational Character Class (O.C.C.). A character involved in an adventure gains experience points for his thoughts, actions and deeds. As these experience points accumulate, the character will reach new plateaus indicating his continual growth, development, and mastery over his abilities and skills. Each time a player's character gets enough experience points to reach the

next "level," his skill increases accordingly. For Example: When a first level Exterminator has accumulated at least 2,201 experience points, he has attained second level, and all of his Scholastic and Secondary Skills become second level, meaning that he can perform them at a higher level of proficiency.

A clever plan, a quick attack, a victorious course of action, all earn experience points. The more experience points a character receives, the greater his abilities become. Players, be sure to keep a careful record of the experience given to you at the end of each game. When a character attains a new level, be certain to tell the G.M. so that the skills, Hit Points, and other elements can be increased accordingly.

The maximum level a player character can reach in Systems Failure® (or any other Palladium game) is 15. We have found characters any higher than that tend to be difficult both to play and to G.M. Plus, given the typical scale of experience points used for this game, a player would have to run his character for years and years to get that high.

Experience & Hit Points

Each time a character reaches a new level of experience, the player gets to roll one six-sided die (1D6) and adds the number rolled to the character's Hit Points. This indicates the physical development and maturity of the character.

Per Level of Experience

"Per level of experience" or similar phrases indicate that the character can perform a skill, power or ability at his personal, highest level of experience. This often indicates the amount of damage that can be inflicted or a duration of an effect.

Experience Points Table

A guide to awarding Experience Points.

Experience Point Reward	Action
25	Performing a skill (successful or not)
25	Clever, but futile idea.
100	Clever, useful idea or action.
100	Quick thinking idea or action.
200	A critical plan or action that saves the character's life and/or a few comrades.
400-1000	Critical plan or action that saves the entire group or many people.
100-300	Endangering the character's own life to help others.
500-700	Self-sacrifice (or potential self-sacrifice) in a life and death situation (like leaping in front of a fireball meant for someone else to save that person, even though he/she is likely to die, or offering his/her own life to save the group or another).
50-100	Avoiding unnecessary violence.
100-200	Deductive reasoning and/or insight.
50	Good judgment.
50	Playing in character bonus.
50-100	Daring or heroic (whether clever or not).
25-50	Killing or subduing a minor menace.
75-100	Killing or subduing a major menace.
150-300	Killing or subduing a great menace.

Insanity

Insanity rules have proven to be a favorite among RPG players for years. However, the inclusion of insanities is entirely *optional* and left up to the Game Master.

In the context of this game, we will assume that all players' characters are mentally and emotionally sound (NPC villains, on the other hand, may be disturbed from the start.) Any insanities developed from this point forward will result from physical or psychological trauma. This trauma may result from a violent or emotional experience, shock, mental abuse, physical damage (blow to the head) or a chemical imbalance in the body. As adventurers, the characters will be *somewhat* prepared and hardened to seeing the horrors of war, social collapse, frightening monsters, and unnatural or bizarre experiences. For a trauma to permanently scar a player character emotionally, it will have to be quite horrible or frightening.

G.M.s may want to use the Insanity tables as an additional means to establish player characters with quirks, but it's not recommended for beginning role-players. Advanced role-players, however, would probably be up to the challenge, and could selectively pick from the Insanity tables to craft some really colorful and off-kilter characters.

A number of insanities are especially well-suited for those living in the Bugged world of **Systems Failure**. For example, *Alignment Reversal* might reflect the character's rebirth after The Meltdown as their old persona became irrelevant and a new persona came to the fore ("I was a lying, cheating, lily-livered coward who took from everybody ... but not any more! I stand up for myself. I help others and I'm taking back my country from the damn bugs!"). Or, the *Invasion of the Body Snatchers* neurosis has obvious applications, as do the forms of paranoia ("Hey, they always did say you were paranoid for building that concrete bunker, right?"). Depending on how tongue-in-cheek you wish to play this world setting (are your heroes hard-bitten, Bug-blasting soldiers fighting for freedom, or are they all fairly nutso fringe folk who have been living underground for a decade and have found themselves in the unlikely role of unconventional adventurers and heroes?), you can really come up with some interesting backstories and playing conditions by creatively using the Insanity tables to your advantage. Beginning to see the possibilities?

Aside from using insanities as an experimental character-building device, it may be appropriate for characters to roll on the Insanity tables after experiencing a terrible or traumatic experience. The G.M. should consider the character's level of experience (at lower levels the character will be less prepared to deal with a traumatic situation) and his M.E. attribute (the higher the Mental Endurance the less likely the character is to succumb to mental and emotional duress and shock). Insanities should not be handed out like candy at a party. The human mind is really quite resilient.

Please note that this section is not meant to be a formal thesis on mental illness, or intended to make light of mental health. It is included to add color and pathos to a campaign.

Trauma

Having a character roll on the Insanity tables after a terrible trauma is both appropriate and realistic. It can also be fun, since it adds a new element to the game and adds dimension to the character. What constitutes a traumatic experience is up to the G.M. and the actual situation. Likewise, the kind of insanity a player develops from any given cause also is ultimately up to the G.M., who can modify, delete or add to this section as he sees fit. The following is a guide to some traumatic situations requiring a roll on the Insanity tables.

Long periods of physical and/or emotional torture: Two to eight weeks: roll once on the *Random Insanity Table*. Nine weeks to months: roll once on the *Random Insanity Table* and once specifically on the *Neurosis table*.

Drug or psychically induced hallucinations that were particularly terrifying, hideous or realistic: roll once on the *Phobia table*. If extremely traumatic, lengthy or reoccurring hallucinations, roll on the *Random Insanity Table*. A real life encounter with the subject of the hallucination is likely to cause more trauma: 01-70% chance of developing another insanity — roll on the *Random Insanity Table* or the *Phobia Table*, whichever seems most appropriate), 71-00% cures the insanity (the character has successfully confronted his inner demon).

Witnessing or experiencing shockingly grotesque atrocity: Roll once on the *Phobia Table*.

Terribly frightening or unusually terrible brush with death: Roll on the *Random Insanity Table*.

Dying and somehow being resurrected: This is as close to death as one can get, and miraculously returning to the living to tell the tale. Roll once on the *Random Insanity Table* and once on the *Phobia Table*.

Severe physical disability: 01-60% chance of alcoholism or drug addiction. 61-80% Neurosis. 81-00% Affective Disorder.

Being the direct or indirect cause for the accidental death of several innocent people: 01-80% chance of insanity for good characters, 01-40% chance of insanity for selfish characters, and only 01-20% chance for characters of an aberrant or miscreant alignment (diabolic characters won't care). In all cases, roll on the *Random Insanity Table*.

Insanity Tables

Random Insanity Table

01-10%: Reborn. Alignment reversal; good becomes evil, evil becomes good and selfish becomes principled or scrupulous.

11-20%: Neurosis. Roll on the *Neurosis Sub-Table*.

21-25%: **Compulsive Liar.** Constantly tells lies and tall tales, even if of a good alignment.

26-30%: Kleptomaniac. A compulsion to steal, even if of a good alignment.

31-40%: Obsession. Roll on the *Obsession Sub-Table*.

41-50%: Phobia. Roll on the *Phobia Sub-Table*.

51-60%: Psychosis. Roll on the *Psychosis Sub-Table*.

61-70%: Fear of Animals. See the "Fear of Animals" entry on the *Neurosis Sub-Table*.

71-75%: **Recluse.** The character prefers to be alone. He is quiet and unobtrusive.

76-80%: Hypochondriac. The character is constantly concerned about sickness, disease and poisoning. He exaggerates the slightest discomfort and illness he may suffer and is constantly under the belief that he is "coming down" with something. He *may* avoid others who are sick even with the common cold, may blame others for his illnesses ("he coughed in my direction yesterday") and is likely to have a half-dozen "quack" cures for every ailment imaginable. Most taste terrible, or are ridiculous, and none of them work.

81-90%: Affective Disorder. Roll on the *Affective Disorder Sub-Table*.

91-00%: Neurosis. Roll on the *Neurosis Sub-Table*.

Affective Disorders Sub-Table

01-19%: Frightened by loud noises to the point of cowering and wetting self.

20-35%: Disgusted by anything sticky and will go to any length to avoid touching it.

36-54%: Obsessed with cleanliness and must clean up any area he is at for more than a few minutes.

55-75%: **Outraged** by acts of violence, becoming violent himself; 72% chance of going berserk and attacking the perpetrator of the violent act without regard for self. Bonuses: +1 to strike and +2 to damage when berserk.

76-88%: Hates music and musicians, and will try to destroy or stop the source of those terrible noises.

89-94%: Hates bugs of all kinds, and will jump up and try to kill them whenever they are noticed within 15 feet (4.6 m) of him. This includes flies, bees, wasps, mosquitoes, moths, butterflies, caterpillars, and spiders and other arachnids. Tends to ignore worms and tiny ants.

95-00%: Intimidated by spoken language; cannot speak meaningful sentences (must use sign language or written communication); has difficulty understanding long sentences.

Neurosis Sub-Table

Neurosis is any of a variety of illnesses that affect the mind or emotions without an obvious physical/organic reason, and involves depression, phobia/fear, compulsion, anxiety, hysteria and other abnormal patterns of behavior.

01-10%: Fear of Animals. More than a simple phobia, this character has been so traumatized (perhaps chewed on by the family pet while a little nipper) that he avoids all animals, will push away the cutest pet, run away when confronted even by tiny animals like a mouse, and will kill them whenever he feels cornered by them. Insects, fish, sea-life and humanoids (i.e., the Bugs or other aliens) are not included in this irrational fear.

11-20%: Fear of the Dark. Spent too much time locked in closets, to the point that the character becomes a gibbering zombie when locked or placed in dark, confined areas (only one attack/action per melee round, no bonuses, no skill capabilities, speed is reduced by *half*). Will collapse (unconscious) after 2D4 melee rounds and will remain catatonic until removed from the darkness or a light is lit. Has trouble sleeping at night.

21-30%: Cannot Tell the Truth. Compulsive liar, even if of a good alignment. Most lies are harmless, but they can be annoying and can get the character and his fellow adventurers into trouble.

31-40%: Personal Cleanliness: Compulsive need to be clean. In fact, the character will wash his hands and face 2D4 times in a row before he "thinks" he is clean. He will also wash his clothes whenever he can, and bathes frequently. He hates being dirty or engaging in something that will make him dirty and tries to avoid it (changes into clean clothes whenever he can and apologizes for being dirty).

41-50%: Invasion of the Body Snatchers. Acute anxiety and paranoia towards just about everybody, but especially towards anyone who looks "unusual." The character is known for saying things like, "They're out to get you! They could be anybody, even ... you!?!?" The character is nervous, a bit jumpy and suspicious of anyone who is not of his same race. This condition is made worse by the fact that the alien Bugs who have invaded the planet actually do take over human bodies and use them as hosts to infiltrate the ranks of human freedom fighters.

51-60%: Fear of Heights. Uncle Goober used to dangle the character by one foot, out of windows. Now the character is terrified of heights to the point of being frozen when above the second story. The character is fine as long as he can't see how high up he may be.

61-70%: Thinks He's Being Followed. Another compulsion motivated by an unfounded fear that one is being followed. The character finds himself frequently stopping to look and see whether or not he's being followed. This includes checking behind himself, looking around, constant sideways glances, checking to see if doors are locked (checking the same doors 1D6 times each) and similar compulsive paranoid behavior. **Note:** The character is not paranoid in the sense that he thinks people are out to get him or are conspiring against him (the character is likely to have numerous trusted friends). He just has this constant feeling or anxiety that he may be followed or is being watched.

71-80%: Fear of Success. "Mom always said I wasn't any good." The character will sabotage himself at critical moments. The following minuses apply during critical, or high pressure moments (battle, danger, watched by others, etc.): -15% to all skills, -3 to strike, parry, initiative and damage.

81-90%: Psycho-Reliance (Luck Fixation). The character becomes convinced that his "good fortune" is because of a particular item, a "lucky charm." The character touches, taps or kisses the charm for good luck before entering a battle or tackling any difficult situation. If the character loses the item, he suffers the following penalties until either the item is recovered or he can find a replacement "good luck" charm, which won't be easy (this is all completely psychosomatic).

Penalties: -5% on all skills, -3 to save vs Horror Factor, -3 on initiative and -1 to combat bonuses. Any other coincidental misfortune will be attributed to the loss of the lucky charm.

91-00%: Hysterical Blindness. When under pressure (battle, an important opportunity, watched by others, etc.), the character loses his sight until the pressure is removed; 01-89% likelihood of happening — roll for each situation. -9 to strike, parry and dodge while blind; no initiative and skill performance is half.

Psychosis Sub-Table

A psychosis is any severe mental disorder in which the person partially or completely withdraws from reality and becomes delusional. Their behavior is often anti-social and violent.

01-15%: Fascination with death in all its forms. The character examines and studies ways one can die and kill, as well as implements of death, how the human (and non-human) body reacts/responds to the threat of death/fear reactions, tolerance to pain, survival responses, and even the philosophical concepts of death, the soul, life after death and so on. It is interesting to note that the character is not afraid of death and is not morbid about it. He is simply fascinated by it. Others may find him to be disturbingly callous and ghoulish.

16-20%: Paranoid. A general suspicion that everybody is out to get you, so therefore, nobody can be trusted. The character is a bit secretive and careful about what he says in front of whom, and keeps to himself.

21-30%: Manic Depressive. Alternate severe depression one week (nobody loves him; he is a loser, incompetent and is going to die if he is not careful; -10% on all skills and reduce combat bonuses by half), followed by a manic episode the next week (everything is great, he is the best there is, life is grand! +5% on all skills and +2 on initiative; all bonuses are normal).

31-40%: They're out to get me (paranoid schizophrenic)! Voices tell the character that most everybody hates and/or fears him. Thus, he believes, "they" are out to get him (torture, kill, imprison, hurt, cheat, discredit, etc.). As a result, he has trouble sleeping (because he knows that would make him vulnerable to "them"), is constantly jumpy/nervous and is suspicious of others, sometimes even long-time friends. The character blames all of his misfortune on others and sees conspiracies everywhere. Tends to be a loner and distrusts everybody except his closest comrades.

41-45%: Superman syndrome. The character thinks he is stronger, faster, smarter, and more handsome than anybody else. He tends to respect only brute strength, power and ruthlessness. As a result, the character accepts foolish challenges, takes dangerous risks and often underestimates his opponents or the chance of failure/defeat. If it is any consolation, the character is usually cheerful, helpful and positive.

46-50%: God syndrome. The character believes he is a divine being because the voices in his head tell him so. As such, the character believes he is above the law, judgement, and the comprehension of all creatures. Consequently, he ignores the laws of any place he visits. The character is not necessarily mean about it, nor blatant or deliberate about breaking the law. He just does not think about them and refuses to pay the consequences when accused of breaking them.

The least offensive characters are cocky, arrogant, bossy, condescending and trivialize everything that does not directly involve them (they are the center of their universe). The most extreme believe they are truly deities and act accordingly as directed by their alignment. Some are reasonably benevolent "gods" while others are cruel, vengeful or malicious.

51-60%: Hysterical aggressive reaction. The character reacts in anger and violence to a particular thing or occurrence. This "trigger" is usually a response to accusations and criticism about his appearance, courage, honor and virtue, such as being called a coward, sissy, wimp, cheater, ugly, stupid, crazy, etc. However, the reaction may also be a response to the actions of others that reminds the character of something that was traumatic in his own life (may tie to other insanities). This can include things like a child being beaten, acts of torture or cruelty, seeing someone attacked by an animal, a particularly threatening monster, and so on.

In most cases, the character flies off the handle, ranting and raving like a lunatic, shoving, threatening or challenging his accuser or the perpetrator of the "trigger" action (i.e., "How would you like it if I slapped you around like that, punk?!"). The slightest act of antagonism, aggression or intolerance toward him, like pushing him away, a smart remark, ignoring him, etc., will send the character into a fury against whomever or whatever set him off.

61-70%: Hysterical aggressive reaction to fear/phobia. In this case, the "trigger" is something the character has a phobia about, except instead of cringing in fear, he lashes out to destroy the object of his fear. This is usually a tangible thing like spiders, snakes, a particular monster, etc. For example, a character with a phobia about insects sees an itty bitty ant crawling on the shelf behind the bar in a club. He's likely to shout something like, "Oh my god! Look out! Get out of my way!" Then he leaps over the bar and swings at the ant with his beer bottle, chair, etc., shouting, "Did I get it? Did I get it? God, I hate those things!" Of course, in the process he may have caused a panic (after all, what is it that has frightened this person to such a degree?) or caused damage by his extreme actions.

If the phobia is something like a fear of the dark, he will fight anybody (to the death) who tries to put him someplace dark or who tries to take away his light, and he will do just about anything to get out of it. Likewise, a phobic character might turn to unreasonable behavior if confronted by his fear. If the hero who is afraid of ants spies an alien Bug, he might hysterically attack it even though the Bug has no clue the hero is there. Obviously, this can draw his fellow adventurers into some serious (and pointless) conflicts (and the reason why this phobia should not include very common things, like people).

71-80%: Mindless aggression. Roll percentile dice again.

01-94%: Semi-functional mindless aggression. When frustrated, angry or upset, there is a 01-72% likelihood of going berserk and lashing out at anybody who gets in the way. The character pushes, beats and lashes out (stands and fights anybody who opposes him) until physically restrained, rendered unconscious or killed! It takes 3D4 minutes of restraint or unconsciousness before the character regains his composure.

95-00%: Non-functional, homicidal maniac! Continually going berserk at the slightest provocation as well as when frustrated, angry or upset. He fights to severely injure or kill those who upset or oppose him. The character must be confined constantly (or killed). He has only one lucid day a week during which time he appears completely normal and rational, and will probably spend his time trying to talk his way out of confinement.

81-85%: Jekyll and **Hyde**. The character hears a voice in his head and feels powerful emotions contrary to his original alignment. There will be moments, especially when under stress, angry or drunk, that the voice speaks so loudly and convincingly that the character will respond to it. The response is the opposite of the character's normal, original personality and can be frightening, as if he were a completely different person! When he returns to normal, the character may regret his actions and try to make restitution, but there is little he can do when his other personality takes over. This means if the character is a principled or scrupulous good character, his opposite Hyde persona will be one of the evil alignments. As a result, in the heat of combat, or under stress, the Hyde persona may surface and engage in acts of cruelty, intimidation, torture, belittlement of others, random homicidal violence, and so on.

86-00%: Become a psychiatrist. The character thinks he is a psychiatrist and sees ordinary quirks, legitimate fears and concerns as a serious psychosis, neurosis, phobia or obsession. They are all sick (even if only he can recognize this)! The character will try to help people by counseling them and offering his "expert" or "professional" services; tends to charge stiff fees. He is especially fascinated with people who he considers extremely insane (have real insanities), but he can not help himself, let alone anyone else.

Random Phobia Table

01-03%: Blood

04-06%: Reptiles (may limit to a specific type)

07-10%: Boats

11-13%: Spiders (or all arachnids)

14-15%: Water

16-19%: Warehouse or other large, abandoned buildings.

20-22%: Ghosts/Entities

23-24%: Sewers or basements.

25-28%: Confining enclosures (claustrophobia)

29-30%: Cats

31-32%: Dogs

33-35%: Contamination (radioactive or otherwise)

36-40%: Priests or other holy figures

41-45%: Churches and other places of worship

46-48%: Heights

49-51%: Flying (by any means)

52-55%: Graveyards, tombs, burial mounds, and other places of the dead

56-58%: Darkness

59-62%: Snakes and snake-like creatures

63-64%: Open spaces (agoraphobia)

65-66%: Aliens of any kind, but Bugs especially!

67-68%: Cyborgs, robots and anybody in an Organitech battlesuit.

69-70%: Insects (this could include alien Bugs).

71-73%: Computers

74-75%: Dead bodies, corpses and skeletons (any type)

76-77%: A particular type of vehicle (e.g., car, truck, boat, plane, bicycle, etc.)

78-80%: Anything related with the number 13 (triskaidekaphobia)

81-85%: Police, Govt Soldiers, or other authority figures

86-90%: Drugs (even medicine)

91-94%: Hospitals/doctors

95-96%: Bats and bat-like creatures (or rats or mice).

97-98%: Slimes and goopy substances

99-00%: Strangers

Note: Characters who suffer from a phobia will become terrified when the object of their fear is encountered. If the character is surrounded by friends who can talk and soothe away his fears, the person may be able to contain himself long enough to safely avoid it (40% chance). However, if the character is alone, already nervous, or feels threatened, he will be overcome by fear. This *is phobic panic*.

Upon reaching the breaking point, the character's mind will defend itself by responding in one of the following ways:

01-25%: Pass out/fall unconscious for 2D4 minutes.

26-80%: Flee/run away at top speed! Panic-stricken, the character will ignore the outcries, pleas or needs of his companions. All the terrified person knows is that he must escape. The character will run and run until he is certain he has escaped the object of his fear or until he is subdued/restrained. The person will fight only if there is no other way to escape, and then only until he can get away and run.

81-00%: Paralyzed with fear, the character can only whimper, sob or scream as he faces the horror. Physically, the character will stand completely rigid or huddled in a corner, immobilized with fear. He can not run, fight, use skills or move in any way (no attacks per melee) until the object of the fear is removed or destroyed, or he is dragged away from it.

Random Obsession Table

01-05%: Opposite sex: The character will either love to be around members of the opposite sex or finds fault in everything they say or do and avoids them.

06-12%: Secrecy: Either prizes his secrecy above all else, or abhors even the thought of keeping a secret.

13-20%: Timeliness: Either a fanatic about being on time or always late.

21-27%: Wealth: Either wants it or gives it away.

28-35%: High Technology: Either loves to acquire/use or loathes it.

36-43%: A specific individual: Hates or loves a particular NPC or player character.

44-50%: Specific object/item or animal: Wants or hates it.

51-55%: Appearance: A fashion plate or a slob.

56-63%: Danger: Either loves the thrill of danger, which usually means throwing caution to the wind (the more deadly the better), or despises danger and is overly cautious; a jumpy worry wart.

64-69%: Food: Covets and pays for only the finest foods and drink (complains about common or plain food; prefers not to eat it). Or eats any slop put down in front of him; the cheaper and nastier, the better.

70-75%: Alcohol: Either a heavy drinker with a keen taste for the finest liquors, or a fanatical teetotaler.

76-80%: Specific person: Either desires that person's love, attention or friendship so much they will go to any lengths to impress them, or is obsessed with humiliating or bringing that person down or ruining them. Depending on their alignment, even violence would be considered. This obsession typically involves somebody the character does not really know.

81-85%: Gambling: Either loves it and bets everything even when on a losing streak, or is an anti-gambler who never bets on anything and looks down upon those who do.

86-90%: Solitude: Either loves peace and quiet, and being alone to the point of growing irrationally angry and frustrated if continually bothered or interrupted, especially during quiet times, or can't stand the thought of being left alone even for short periods of time.

91-96%: Crime-busting: If of a good or unprincipled alignment, the character loves to be a hero and is obsessed with stomping out crime and evil everywhere. If an anarchist or evil alignment, the character likes to think of himself as a master con-man or criminal mastermind and engages in criminal activity and undermining law and order whenever he can.

97-00%: Power/Leadership: Either craves power and wants to be a leader of others, or could not care less and prefers to be a follower (even if cheering throngs of people are calling out for him to lead them).

Note: Obsessions are either an intense, irrational love/desire of something or an intense hatred/loathing of it. The former is likely to motivate the obsessed person to obtain the object of his desire while the latter is likely to cause the character to avoid or destroy it. The G.M. can decide which is most appropriate under the circumstances or roll percentile dice to see which way the obsession manifests itself (50%/50% between love and hatred). Obsessive characters typically will go to almost any length to satisfy their irrational feelings.

Cures for Insanity

1. Affective **Disorders & Neuroses**: Therapy and counseling by a psychologist. Requires a minimum of three months of therapy with the following results:

01-29%: No effect; requires longer therapy (roll again in another three months).

30-69%: Half cured. The character feels the occasional return of the old neurosis or disorder when under stress; 1-48% chance).

70-00%: Total cure! The insanity is gone.

2. Curing Psychoses: Therapy and possible use of hypnosis and drugs are known to control mood swings, depression, schizophrenia, paranoia and stress. Treatment by a psychologist requires 4D4 months of therapy with the following results:

01-33%: No effect; requires another six months of therapy to roll again.

34-68%: Psychosis is replaced by a phobia (this could be an improvement).

69-00%: Total cure.

3. Curing Phobias and Obsessions: There is no known cure for these conditions, but prolonged or repeated exposure to the object of one's fears in a controlled environment, along with counseling, can lessen the intensity of the fear, making it less irrational and manageable (scared but can still function). Treatment by a psychologist requires 1D4 months of therapy, with the following results:

01-39%: No effect; requires 1D4 more months of therapy.

40-88%: Fear is lessened so that the character can function normally, but still does not like the object of the phobia — ugh!

89-00%: Fear is intensified so that there is a 50% likelihood that the character will become completely paralyzed until the source of the fear is removed or the person is physically removed from its location.



Skills

In **Systems Failure**, a character's skills are initially determined by his Background Occupation and his O.C.C. Aside from *Background Skills*; which were detailed in the Character Creation section, there are three other basic skill categories: *Scholastic Skills*; *Skill Programs* (which are bundles of individual *Scholastic Skills*) and *Secondary Skills*.

As the character advances in level of experience, his chances of performing skills successfully (his *success ratio*) will increase. Likewise, as the character advances, he will also learn additional skills along the

way. All new skills begin with a 1st level success ratio. Thus, if a 5th level character learns a new skill, that new skill is performed at 1st level proficiency while all other skills are performed at 5th level proficiency. When the character reaches 6th level, his new skill will be at 2nd level while all of his others will be at 6th.

The maximum success ratio for any skill is 95%, regardless of how far the character advances or what modifiers he may enjoy. There is *always* a margin of error.

Fundamental (common) Skills: Regardless of Background Occupation and O.C.C., *all* characters know the following skills:

Pilot Automobile, Mathematics: Basic, Speak Native Language (+25%), and Read and Write Native Language (+20%).

Throughout a character's history, he will probably train in some form of hand to hand combat. *Only one form of hand to hand combat may be selected.* In cases where more than one type is available, the player must select only one and disregard the others.

Characters also are likely to pick up **physical skills**. It is important to note that physical skill *bonuses are accumulative*. It is perfectly acceptable within the confines of this game for players to pick numerous physical skills in order to beef up their character. Many physical skills provide some kind of combat bonus or a bonus to a physical attribute. *All* of these bonuses are cumulative. **Note:** *Acrobatics and Gymnastics* provide similar abilities and bonuses. If both are selected, add the bonuses and pluses to your overall character as explained. However, the abilities such as back flip, climb rope, etc., are not added together, nor is the educational bonus added twice. The "best" proficiency of a duplicated skill is taken, and the normal educational bonus is applied. Also note that the Prowl and Climbing skills given under Acrobatics and Gymnastics are a part of these skills and do not increase with level unless they are selected as separate, additional skills.

Technically, a character can go back to school to learn or improve skill knowledge. However, with the world in tatters, there are very few schools and learning institutions left. Various survivalist, militia and trader enclaves might have the equivalent of a trade school where one can learn Secondary Skills, or might have access to learning skills of one particular Skill Program, but that is about it. The only exceptions are the remaining major centers of human resistance, such as NORAD, Silicon Valley, Fort Knox and others described later.

Assuming characters make it to a training facility, the following rules for learning new skills apply:

To learn a new *Scholastic Skill* or *Skill Program*, the character must attend the post-Meltdown equivalent of a college, such as a survivalist or military training camp. This kind of "education" usually requires hefty payment in tradable goods, precious metals, or a dedication of services (offer to provide 4-6 months of manual labor in return for learning an Electronics skill, for instance). The G.M. should assign time requirements for such training courses or classes. A good rule of thumb is 4-8 hours a week in class (regular hours — not at the character's discretion) per each subject/skill, and another 6-10 hours per week spent on self-study per each subject/skill. Three missed classes means the character fails to pick up that skill. Characters may try again, but they will have to pay additional tuition.

It should be noted that the teaching of skills is a primary means of bartering in the world of **Systems Failure**. Another is offering one's services (i.e. skills/ability to fight/protect, guard, make repairs, etc.) in exchange for food, a place to sleep, supplies, information or a different service (like repair or medical treatment). In many cases, characters might teach one another skills for services rendered, or to purchase a particular item. In such cases, the learning is more like an intensive tutorship. Of course, how often the student can get to the tutor may be a problem. Sometimes the student might be kept from going to another class for weeks or months if the teacher is away or dealing with something more pressing. In general, if a student is kept from his studies for more than three weeks, he loses a week's worth of class time put in towards learning a new skill. If he misses six weeks straight, he loses all previous skill knowledge and must begin learning the skill anew.

Successful scholastic studies means the character now knows the skill at 1st level proficiency. That means if a 4th level character learned a new skill, he would perform it at 1st level. When that character reached 5th level, the skill would increase to 2nd level.

Scholastic Skills

These skills can only be learned as part of O.C.C, training or by receiving instruction at a special training camp or other "educational institution," or by long and intensive one-on-one study with a bona fide expert (effectively a trade school). Characters typically get Scholastic Skills by selecting *Skill Programs*, which essentially are groups of Scholastic Skills bundled together around a common theme. However, characters may learn individual Scholastic Skills as part of their O.C.C, training, or simply by learning them during the course of their adventures.

For a full list of all Scholastic Skills, see the Skill Descriptions section that follows.

Skill Programs

Systems Failure™ uses the Skill Program system because it makes character creation easier and faster and it helps define a character's overall theme or motif. A character's Background Occupation and O.C.C, gives him a certain *Skill Program* — a collection of skills bundled together as part of his old life and work. Remember, "old" Skill Programs from the past life are performed at first level proficiency regardless of the character's experience level, unless that skill (or bundle of skills) is taken again, as part of the character's "new" life.

Each *current O.C.C.* will indicate the selection of new Skill Programs. These reflect the character's current and regularly used area of knowledge and training. These improve with experience.

The following is a list of all available Skill Programs and the individual skills they consist of:

Business Program: Basic or Advanced Mathematics, Business & Finance, Computer Operation, Law (General), and Research.

Communications Program: Basic Electronics, Radio: Basic, Radio: Scrambler, T.V./Video, and one Communications or Computer skill of choice.

Computer Program: Basic Electronics, Computer Operations, Computer Programming, and Computer Hacking or Computer Repairs.

Criminal Program: Streetwise, Pick Locks and three Rogue skills of choice. **Note:** If a second Criminal Program is selected, pick a total of four skills from the Rogue and/or W.P. categories.

Domestic Program: Basic Mathematics and three Domestic skills of choice.

Electrical Program: Electrical Engineer, Basic Mechanics, Computer Operation and one electronic skill of choice.

Espionage Program: Hand to Hand: Martial Arts, Detect Ambush, Intelligence, Wilderness Survival and two Espionage skills of choice.

Gambler & Huckster: Advanced Math, Streetwise, Card Sharp, Palming, and Seduction or Anthropology (the study of human nature and customs; very useful).

Journalist/Investigation Program: Computer Operation, Research, Photography or Surveillance Systems, Writing (Journalistic style). **Note:** If a second Investigation Program is selected, pick a total of four skills from the Communications, Espionage, Rogue and/or Technical skill categories.

Language: Select four Language skills of choice.

Mechanical Program (General): Mechanical Engineer, Basic Electronics, Locksmith.

Mechanic Program (Vehicular): Automotive Mechanics, Aircraft Mechanics, Basic Electronics and one Mechanical skill of choice.

Medical Assistant Program: Business & Finance, Computer Operation, Biology, Paramedic.

Medical Doctor Program: Biology, Chemistry, Pathology, Medical Doctor.

Medical Investigation Program: Criminal Science/Forensics, Biology, Chemistry, Pathology, and Advanced Mathematics.

Military Program (Basic): Hand to Hand: Basic, Running, Climbing, Military Etiquette, Radio: Basic, W.P. Rifle.

Military Demolitions Program: Basic Electronics, Basic Mechanics, Demolitions, Demolitions Disposal, Underwater Demolitions.

Pilot: Basic: Select five Basic Piloting skills of choice.

Pilot: Advanced Program: Navigation (Air, Land, Water), Read Sensory Equipment, Weapon Systems or one Pilot-Related skill, two Basic Piloting skills of choice and two Advanced Piloting skills of choice.

Physical/Athletic Program: General Athletics and four Physical skills of choice.

Police/Law Enforcement Program: Hand to Hand: Expert, W.P. Automatic Pistol or Revolver, Radio: Basic, Criminal Science (does not include Forensic Medicine skill), Law (General) and one of the following: Intelligence, Surveillance Systems, or Streetwise. **Note:** If a second Police/Law Enforcement program is selected, pick a total of four skills from the Espionage, Rogue, and/or W.P. skill categories.

Robotics Program: Computer Operation, Computer Programming, Robot Electronics, Robot Mechanics.

Science Program: Computer Operation, Advanced Mathematics, Chemistry and three Science skills of choice.

Technical Program: Select five Technical skills of choice.

Professional Thief Program: Locksmith, Prowl, Climbing, Surveillance Systems. **Note:** If a second Professional Thief Program is selected, pick five skills from the Rogue skill category.

Weapon Proficiency: Ancient Weapons Program: Paired Weapons and three Ancient W.P.s of choice.

Weapon Proficiency: Modern Weapons Program: Select three Modern W.P.s of choice.

Survival/Wilderness Program: Wilderness Survival, select four Wilderness skills of choice.

Secondary Skills

Secondary Skills are additional areas of knowledge that the character has learned through experience. They may be related to the person's occupation, but often relate to other interests, hobbies and entertainment. Secondary skills usually are self-taught and generally do not command the same degree of expertise as if that same skill were acquired as a Scholastic Skill. **For example:** If a character took the Art skill as a Scholastic Skill, he would have the ability of a professional artist. If a character took the same skill as a Secondary Skill, however, he would only have the ability of a talented amateur. Even if a Secondary artist had a higher chance of success than a Scholastic artist, the Scholastic Artist's work would *always* look better. That is the essential difference between Scholastic and Secondary Skills, other than the fact that not all skills are available as Secondary Skills (i.e. the average person can not self-teach surgery, espionage, etc).

Below is a list of skills that can be selected as Secondary Skills. Because these skills are self-taught and do not include intensive training, certain skills (e.g., most Military skills) cannot be learned as a Secondary Skill.

Communications: Radio: Basic and TV/Video only.

Domestic: Any.

Electrical: Basic Electronics only.

Espionage: Wilderness Survival only.

Mechanical: Basic Mechanics and Auto Mechanics only.

Medical: First Aid or Holistic Medicine, but the latter counts as two skill selections.

Military: Camouflage and Recognize Weapon Quality only.

Physical: Any, excluding Acrobatics, Gymnastics, Boxing and Wrestling. Hand to Hand: Expert counts as two skill selections and

Hand to Hand: Martial Arts (or Hand to Hand: Assassin, if evil) counts as three skill selections.

Pilot: Basic: Any.

Pilot: Advanced: None.

Pilot Related: None.

Rogue: Any except Computer Hacking, Find Contraband, and Safecracking.

Science: Astronomy and Math skills only.

Technical: Any.

W.P. Ancient Weapons: Any.

W.P. Modern Weapons: Any, except Energy Weapons skills.

Wilderness Skills: Any.

Skill Penalties

Ordinarily, a character's chance of performing a skill successfully is determined by his success ratio for that skill. However, when alien technology or pressure situations are involved, one's success ratio for *any* skill is lowered.

Alien or Super-Advanced Technology: As a rule of thumb, there should be a skill penalty of -30% or -40% when trying to figure out, operate, repair, or use such mechanisms and technologies. In some cases (G.M.'s discretion), the technology may be so different that the character will be unable to use the simplest of devices (-80% to -95% penalty). The G.M. should always use his or her discretion when dealing with alien or futuristic sciences.

Pressure Situations: Executing a skill when calm, cool and collected is one thing. Doing it under the gun is something else. For the following pressure situations, negative modifiers apply to characters trying to execute any Scholastic or Secondary Skill (excluding Hand to Hand combat skills).

Pressure situation, but no big deal: -5% to -10%.

Pressure situation, deadly: Time is running out, with dire consequences! -15% or -30% penalty if a life and death situation, especially if thousands of lives hang in the balance.

Countermeasures, traps and alarms are in place: Depending on their level of complexity and sophistication, -10% or -15%.

Difficult, complex or unfamiliar task: -10% to -15%.

Trying to do something while moving: -5% to -40%, depending on the situation and how bumpy the ride is.

Frightened or jumpy: -5% to -10%.

Seriously wounded: When a character's Hit Points are down by 50% or more, all skills have a -15% penalty.

Note: The G.M. may also impose a reasonable penalty to any situation where the character faces an unusual or difficult task. A reasonable penalty will range between -10% and -30%, but sometimes lower or dramatically higher penalties may be appropriate. G.M.s, use your discretion and be fair.

Skill List

Communications: Cryptography, Laser, Optic Systems, Radio: Basic, Radio: Satellite, Radio: Scramblers, Surveillance Systems, T.V. & Video, Read Sensory Equipment

Domestic: Cook, Dance, Fishing, Play Musical Instrument, Sewing, Sing

Electrical: Basic Electronics, Computer Repair, Electrical Engineer, Advanced Electronics

Espionage: Detect Ambush, Detect Concealment, Disguise, Escape Artist, Forgery, Imitate Voices and Impersonation, Intelligence, Interrogation, Pick Locks, Pick Pockets, Sniper, Tracking, Wilderness Survival

Mechanical: Aircraft Mechanics, Automotive Mechanics Basic, Locksmith, Mechanical Engineer, Advanced Mechanics, Weapons Basic Engineer

Medical: Criminal Science & Forensics, First Aid, Holistic Medicine, Paramedic, Medical Doctor, Pathology

Military: Armorer (Field), Camouflage, Demolitions, Demolitions Disposal, Find Contraband & Illegal Weapons, Military Etiquette, Nuclear, Biological & Chemical Warfare, Parachuting, Recognize Weapon Quality, Trap/Mine Detection, Underwater Demolitions

Physical: Hand to Hand: Basic, Hand to Hand: Expert, Hand to Hand: Martial Arts, Hand to Hand: Assassin, Acrobatics, Athletics (General), Body Building & Weight-lifting, Boxing, Climbing, Gymnastics, Prowl, Running, Swimming, S.C.U.B.A./Advanced Swimming, Wrestling

Pilot: Basic: Airplane, Automobile, Boat: Sail-Type, Boat: Motor and Hydrofoils, Boat: Ship, Horsemanship, Motorcycle, Race Car, Truck, Water Scooters

Pilot: Advanced: Helicopter, Hovercraft, Jet Aircraft, Jet Fighter, Jet Packs, Submersibles, Tanks and APCs, Warships and Patrol Boats

Pilot Related: Navigation, Read Sensory Equipment, Weapon Systems

Rogue: Cardsharp, Computer Hacking, Concealment, Find Contraband and Illegal Weapons, Palming, Pick Locks, Pick Pockets, Prowl, Safecracking, Seduction, Streetwise, Ventriloquism

Science: Anthropology, Archeology, Astronomy, Astrophysics, Biology, Botany, Chemistry, Chemistry: Analytical, Mathematics: Basic, Mathematics: Advanced

Technical: Art, Business & Finance, Computer Operation, Computer Programming, General Repair, Law (General), Language, Literacy, Photography, Research, Writing

Wilderness: Boat Building, Carpentry, Hunting, Identify Plants & Fruits, Land Navigation, Preserve Food, Skin & Prepare Animal Hides, Track Animals

Ancient Weapon Proficiencies: W.P. Archery & Targeting, W.P. Battle Axe, W.P. Blunt, W.P. Chain, W.P. Knife, W.P. Paired Weapons, W.P. Pole Arms, W.P. Shield, W.P. Spear, W.P. Staff, W.P. Sword, W.P. Throwing Weapons, W.P. Targeting, W.P. Whip

Modern Weapon Proficiencies: W.P. Revolver, W.P. Automatic Pistol, W.P. Bolt-Action Rifle, W.P. Automatic and Semi-Automatic Rifles, W.P. Sub-Machinegun, W.P. Shotgun, W.P. Heavy Weapons, W.P. Light Energy Weapons, W.P. Heavy Energy Weapons

Skill Descriptions

Communications

Cryptography: Skill in recognizing, designing, and cracking secret codes and messages. The character must study the code for two hours to attempt to break it successfully. A failed roll means the individual must study the code for an additional two hours before he can try to break it again. The character may attempt to break the code sooner, after only 10 minutes of study, but suffers a penalty of -30%. **Base Skill:** 25% +5% per level of experience. **Requires:** Literacy.

Laser: This skill provides the character with an in-depth knowledge of sophisticated laser communication systems and fiber optic communications. **Base Skill:** 30% +5% per level of experience. **Requires:** Radio: Basic, Electrical Engineer, and Computer Operation. **Note:** Almost all *Debugger* Eggheads will take this skill.

Optic Systems: Provides expert training in the use of special optical enhancement equipment such as telescopic lenses, laser targeting, thermo-imagers, passive light intensifiers, infrared and ultraviolet systems, polarization, light filters, optical scanners, and related devices. **Base Skill:** 30% +5% per level of experience. Adds a special one-time bonus of +5% to T.V./Video skill if both are selected.

Radio: Basic: This is the rudimentary knowledge of the operation and maintenance of field radios and walkie-talkies, wire laying, installation, radio procedure, communication security and visual signs/com-

munications (i.e., semaphore), as well as Morse code. It does not include repairs. **Base Skill:** 45% +5% per level of experience.

Radio: Scramblers: This is training in the use of electronic masking, scrambling and unscrambling equipment, and codes for the transmission of radio signals. **Base Skill:** 35% +5% per level of experience.

Radio: Satellite: This is an understanding of the methods and operations of satellite relay technology. A vital skill in the modern world where nearly all communications and video are transported by satellite. (Especially since nearly all hardware communications in this world are down or Bug-infested. While many satellites are out of commission, there are a few still working. Whoever gains control of them will have a huge communications advantage.)

Surveillance Systems: This is the study and understanding of the operation, methods, and techniques in the use of surveillance systems. Includes motion detectors, simple and complex alarm systems, audio/visual recording and display equipment, recording methods, amplified sound systems, miniature listening devices ("bugs"), line tapping, and some optical enhancement systems (specifically as they relate to camera lenses).

Tailing, or following someone without their knowledge, is another form of surveillance. This also includes stake-out procedures. A failed surveillance roll indicates that the subject has spotted the tail and is aware that he is being followed/observed.

A failed roll in the use of surveillance equipment means that the equipment does not function as desired, impairing or preventing surveillance; i.e., a "bug" does not transmit, a recording is garbled, film is blurred or fails to record, etc.

A failed roll when hiding listening devices means the "bug" does not function and is easily discovered through the course of casual activity.

Base Skill: 30% +5% per level of experience. **Requires:** Electronics: Basic or Electrical Engineering. For complex, high-tech surveillance systems, Computer Operation and Literacy are also required.

TV & Video: In-depth training in the use of video and audio recording equipment, filming, editing, dubbing, title-making, duplication and transmission. Includes the use of field equipment (i.e., portable video cameras) and studio equipment (i.e., editing and transmission equipment), etc. **Base Skill:** 25% +4% per level of experience.

Read Sensory Equipment: Same skill as described under Pilot Related skills.

Domestic

Note: Characters with Secondary Domestic skills can attain *professional* quality by selecting the same Domestic skill twice. Secondary Domestic skills enhanced in this way are the equivalent of a Scholastic Domestic skill, but with a +10% bonus.

Cook: Skill in selecting, planning, and preparing meals. A cooking roll failure means that the cooked food is not properly prepared. At best, it tastes terrible; at worst, it is inedible. **Base Skill:** 35% +5% per level of experience.

Dance: A practiced skill in the art of dancing. The character is especially smooth and graceful, a joy to dance with. Can learn new dance steps/moves much more quickly than somebody who can not dance. **Base Skill:** 30% +5% per level of experience.

Fishing: The fundamental methods and enjoyment of the relaxing sport of fishing. Areas of knowledge include the use of lures, bait, poles, hooks, lines, and the cleaning and preparation of fish for eating. Also includes a basic knowledge of freshwater fish, their habits, and taste. **Base Skill:** 40% +5% per level of experience.

Play Musical Instrument: The individual has learned to play a particular musical instrument with a fair amount of skill. The sound is generally pleasant (except when a bad roll is made). Note that selecting this skill trains the character to play only one type of instrument. A character wishing to play the guitar, violin and harmonica would need to select this skill *three* times. **Base Skill:** 35% +5% per level of experience.

Sewing: The practiced skill with needle and thread to mend clothing, do minor alterations and layout, cut and sew simple patterns. This is not a tailoring ability, but can become that if the character selects this skill twice. **Base Skill:** 40% +5% per level of experience.

Sing: The simple ability to read music and carry a pleasant tune. **Base Skill:** 35% +5% per level of experience.

Electrical

Basic Electronics: This is a rudimentary understanding of the principles of electricity, simple circuits, wiring, and so on. This person can do basic wiring, repair appliances, and read schematics. **Base Skill:** 30% +5% per level of experience.

Computer Repair: Knowledge of the internal electronics of computers and related devices (terminals, printers, modems, etc.). The character can attempt to repair or sabotage computers. Note that figuring out the repair or sabotage procedure counts as one roll, and the actual repair is a second roll. A failed roll means the repair is faulty and does not work (try again). No computer operation or programming skills are included nor required to fix computers. **Base Skill:** 25% +5% per level of experience.

Electrical Engineer: The character can diagnose and locate electrical problems, repair complex electrical devices, wire entire buildings or vehicles, and build electrical equipment. The character can also attempt to bypass security systems, alarms, and surveillance systems, but at a penalty of -20% for simple systems and -50% for complex systems (reduce these penalties by half if the character also has the Surveillance Systems skill). **Base Skill:** 30% +5% per level of experience. **Requires:** Advanced Mathematics and Literacy.

Advanced Electronics: A specialized area of knowledge as it directly relates to micro-circuitry and robotics or bionic parts. Given the lack of spare parts and technology of this world, this skill will have little application unless the character has the Biology skill as well and access to an Organotechnology facility, like the NORAD labs in Colorado Springs. Then, the character could use this skill to repair, maintain and upgrade Organitech weapons, armor and devices. Working on Organotechnology counts as alien technology, however, and carries the usual negative modifier. Note that to design and build Organitech devices from scratch, one must have this skill, Biology, and Advanced Mechanics; the success ratio would be equal to the lowest among the three skills held. **Base Skill:** 30% +5% per level of experience.

Espionage

Detect Ambush: Training which develops an eye for spotting locations and terrain suitable for ambushes and being ambushed. It also provides a rudimentary knowledge of guerilla tactics used by the enemy. **Base Skill:** 30% +5% per level of experience.

Detect Concealment: This is a skill which enables the individual to spot and recognize camouflage; concealed structures, buildings and vehicles; and the ability to construct unobtrusive shelters, use camouflage and blend into the environment. It can also be used to detect secret or hidden doors and panels. **Base Skill:** 25% +5% per level of experience.

Disguise: The character knows how to apply make-up, wigs, skin putty, dyes, and other special effects in order to alter his appearance or that of somebody else. This skill is especially useful for making a normal human look like a "Drone" (human bodies that have been "Bugged" or implanted with a Silkworm and taken over). **Base Skill:** 25% +5% per level of experience.

Escape Artist: The methods, principles, and tricks of escape artists. Includes muscle control (tensing and relaxing muscles), flexing and popping joints, knowledge of knots, and the ability to conceal small objects on the person. The character can try slipping out of handcuffs, ropes, straitjackets, etc. **Note:** Picking locks is a separate skill and is not an ability conferred by Escape Artist. **Base Skill:** 30% +5% per level of experience.

Forgery: The technique of making false copies of official documents, signatures, passports, IDs, and other printed material. The forger

must have an original or photocopy to work from in order to make an accurate copy. Skilled forgers can recognize other counterfeits at -10%. This skill has far fewer applications than it did in the pre-Meltdown world, but cagey individuals can still figure out ways to implement it, especially in towns where a semblance of civilization has been restored. **Base Skill:** 20% +5% per level of experience. **Prerequisites:** Computer Operation, but only for forging electronic documents.

Imitate Voices and Impersonation: The ability to imitate the voice, accent and expressions of another person or regional dialect. The skill is common among thieves, assassins and secret agents. The first number indicates the character's ability to change his voice and imitate accents, inflections and expressions from other regions. A successful roll means he has disguised his normal/true speaking voice and accent, and convincingly sounds like he is from another region or part of the world.

The second number indicates the character's ability to accurately imitate the voice, inflections and attitude of a specific person! This is very difficult. The character will need to know the person being imitated very well, having spent hours studying him in person or on a high-quality recording.

Impersonation note: When combined with the Disguise and Intelligence skills, the character is able to completely impersonate a specific person or person of a particular occupation (soldier, mechanic, reporter, police officer, etc.). This is likely to include knowledge of the subject being impersonated, military procedure, dress, rank, etc., and will usually require speaking the language fluently. This means the person can convincingly impersonate a general type of person/soldier/advisor with an accurate disguise, proper action and language. A failed roll means some element of the impersonation is flawed, such as incorrect behavior, wrong character trait, or lack of information about the person being impersonated ("Tell me again what you said that night," etc.). Such "holes" will give the character away sooner or later. So the longer a character remains under the eyes of others, the more likely that something will happen to reveal him as an imposter. This is fun to role-play, so take advantage of it. **Base Skill:** 16% +4% per level of experience for a regional disguise of an average local person (farmer, laborer, vagabond, etc.). 12% +4% to impersonate a person in a specific occupation (sheriff, guard, inspector, messenger merchant, priest, etc.). 10% +4% per level of experience to impersonate a specific, known person. If the character also possesses the Intelligence, Disguise and appropriate Language skills, a one-time bonus of +20% is applied. The success of one's impersonation can only be determined by exposing oneself to those whom you wish to trick. A successful impersonation requires the player to roll under his skill for each of the first *three* encounters. Afterward, the character only needs to roll under his skill for each encounter with an officer/authority figure. If interrogated/questioned, he must roll for every other question or be revealed as an imposter. A failed roll means his impersonation has failed, he is recognized as an imposter, and probably is in immediate danger!

Intelligence: This is the specific training in the practices and principles of recognizing and analyzing sources of information about the enemy, observation techniques, counter-intelligence measures and proper procedure. This includes the practical assessment of sights and sounds, estimation of ranges, what to report, handling prisoners of war, and handling captured documents and equipment (tagging and reporting to a group leader or proper authority). This means the character will be able to accurately estimate ranges, the number of enemies, direction, purpose, and assess the importance of specific information.

Further intelligence training includes a working knowledge of indigenous guerilla warfare, enemy practices, appearance, and current activities. This enables the intelligence officer to recognize suspicious activities as guerilla actions and identify guerilla operatives. For example, a particular booby trap, weapon or operation may be indicative of guerilla activity in the area. It may be up to the character to confirm the existence of the enemy and their strengths, number and location.

Another area of training made available to Intelligence is the identification of enemy troops, officers, and foreign advisors. This means the person learns the many distinguishing ranks and marks that identify specific military units, special forces, groups, and leaders of the enemy. Such identification can pinpoint and confirm enemy operations, goals, and movement, as well as confirm outside intervention/aid.

Note: A failed roll in any of the areas of Intelligence means that evidence is inconclusive, or that the character has incorrectly assessed the information/situation and is uncertain. A failed roll involving individual clues may mean the person has dismissed it entirely as being meaningless (G.M.s, use your discretion). Intelligence can be applied to an urban environment and used to identify and keep track of gangs, politicians and their helpers, villains and their cronies, and other organizations, but such rolls are made at -10%. **Base Skill:** 32% +4% per level of experience.

Interrogation: This skill is learned by policemen, intelligence officers, etc. The character knows the techniques to get information from (typically unwilling) subjects. This includes such old methods as "good cop, bad cop" (one interrogator is threatening and intimidating while the other is sympathetic and friendly), deceiving and misleading the subject into giving away information, and similar methods. The character can also judge if the subject is lying (the G.M. might assess bonuses and penalties depending on how good a liar the subject is). The skill also includes some basic knowledge on methods and torture, from basic tactics like depriving the subject of sleep, to the old "medieval" instruments and new sophisticated techniques like sensory deprivation, partial electrocution, and drugs. **Note:** Only evil characters will engage in torture routinely. **Base Skill:** 40% +5% per level of experience.

Pick Locks: The character knows the methods and tools for picking/opening key and basic tumbler-type locks. This does not include sophisticated computer or electronic locks. It takes 1D6 melee rounds for each attempt to pick a lock. A failed roll means the lock holds; try again. **Base Skill:** 30% +5% per level of experience.

Pick Pockets: An ability to remove items from a person without their being aware of it. On a failed roll, the item has not been removed and there is a 67% likelihood of the intended victim recognizing the intent of the action. **Base Skill:** 25% +5% per level of experience.

Sniper: This skill represents special training in long-range rifle firing and marksmanship. Only rifles that can be made to fire a single round or blast can be used for sniping (no automatic/multi-firing rifles). Adds a bonus of +2 to strike on an *aimed* shot.

Tracking: Visual tracking is the identification of tracks and following the path of men or animals by the signs they leave on the ground and vegetation. Tracking is a precise art, requiring much practice. The skill includes the evaluation of tracks, indicating whether the person being tracked is loaded down with equipment, running, moving slowly (by measuring the space between steps), and so on. By this means, the tracker can estimate the person's rate of movement, apparent direction, the number of persons in the party, and whether the person knows he is being followed. Other methods of tracking require recognizing other telltale signs, such as blood and other stains, broken and displaced vegetation, overturned rocks, litter (such as cigarette butts, ration cans, candy wrappers, soiled bandages and campfire remains), and even odors carried by the wind.

Tracking also includes the recognizing of dangerous animals by their tracks, habits and feces. Likewise, the tracks of vehicles can reveal much, such as size and type of the vehicle, the weight of its load, etc.

Counter-Tracking techniques are also known, such as covering one's trail, misdirection, parallel trails, and avoiding obvious pitfalls like littering and others.

A failed roll means that the signs are inconclusive, vague or misleading. Additional signs must be found to verify or clarify (roll again). Three consecutive failed rolls means the tracker has completely lost the trail. Roll once every 40 yards (13.3 m) when following a trail. Persons

attempting to follow a skilled tracker are -25% when following his trail, if he is deliberately trying to conceal that trail (however, his rate of travel is reduced by half). **Base Skill:** 25% +5% per level of experience.

Wilderness Survival: Techniques used for getting water, food, shelter, and help when stranded in wild forests, deserts or mountains. Characters without this skill will not be able to stay healthy for more than a few days in the wilderness once their supplies run out. **Base Skill:** 30% +5% per level of experience.

Mechanical

Aircraft Mechanics: The understanding of aerodynamics and the training to repair, rebuild, modify, and redesign conventional aircraft, including single-engine planes, twin-engine planes, jets, helicopters and hovercraft. Organitech battlesuits and high-tech military vehicles are not included (see Advanced Mechanics). **Base Skill:** 25% +5% per level of experience.

Automotive Mechanics: The ability to repair, rebuild, modify and redesign conventional vehicles with internal combustion (gasoline) engines. It also includes body work, turbine engines, methanol, ethanol and diesel truck engines. Working on hover jet systems for ground vehicles is possible, but with a -20% penalty. When working on reactor engines, there is a -40% penalty. **Base Skill:** 25% +5% per level of experience.

Basic Mechanics: A general familiarity and understanding of basic mechanics. This character can fix a toaster, repair a bicycle, replace a belt on a motor, repair or replace a switch, handle or a knob, replace a spark plug, change oil, assist in automobile repairs, maintain machinery, read a schematic and similar fundamental tasks. **Base Skill:** 30% +5% per level of experience.

Locksmith: The study of lock designs and the ability to repair, build, modify and open locks. The methods, techniques, and tools of lock picking include the old-style key and tumbler, combination, and modern electrical locking systems. Time requirements: 1D4 melees to open an antiquated key-type lock or simple tumbler/combination type; 1D4 minutes to open an elaborate tumbler-type lock; 2D4 minutes to open a simple electronic lock (usually by patching in a bypass system); and 1D4 hours to break a complex, state of the art electronic lock system such as those used in high-security and restricted areas. Super high-tech systems, such as those used by the military and government, will require 3D4 hours and have a skill penalty of -20%. **Note:** that much quicker times on the electronic locks are possible with pass codes or plans of the locks (both of which can be rather difficult to obtain).

If an unsuccessful skill roll is made, the lock is not opened and the process must be repeated. If an attempt to open an electronic lock fails, roll again. A second failed roll means that the lock is irreparably damaged and can not be opened! **Base Skill:** 25% +5% per level of experience. **Requires:** At least Basic Electronics skill (-5% penalty when working on complex or high-tech locks) or Electrical Engineer (+5% bonus instead).

Mechanical Engineer: Training, understanding, and knowledge of how machinery is designed, operated, built, and maintained. Characters can attempt to redesign, modify, repair, construct, or sabotage mechanical devices. The player must first roll to see if his character can figure out how to operate, analyze or design a machine. When a successful diagnostic roll has been made, roll again to determine when the character can fix, change or build the mechanism. **Base Skill:** 25% +5% per level of experience. **Special Bonus:** Add a one-time bonus of 5% to the Locksmith and Surveillance Systems skills if Mechanical Engineering is also known. There is a -30% penalty when working on alien or extremely unfamiliar mechanics. **Requires:** Basic or Advanced Mathematics, at least Basic Electronics, and Literacy.

Advanced Mechanics: A comprehensive knowledge and ability to repair, maintain, build, and modify advanced mechanical devices, such as spaceship components, nuclear weapon detonators and other highly complex bits of machinery. When coupled with the Biology skill, this

lets characters repair and maintain Organitech weapons, armor and devices. This skill does not, however, enable a character to design brand new Organitech hardware unless he also has the Advanced Electronics skill. The success ratio for designing and building Organitech devices from scratch will be equal to the lowest of the three prerequisite skills.

Base Skill: 30% +5% per level of experience.

Weapons Engineer: This skill is usually reserved for military personnel. The character can maintain, repair, modify, mount, and figure out most weapons systems. He can repair an assault rifle and install a missile system into a vehicle. The engineer can also add and repair body armor (but not make or modify it) and is an expert welder. Constructing/modifying weapons is done at -15%. **Base Skill:** 25% +5% per level of experience. **Requires:** Mechanical Engineering and Basic Electronics.

Medical

Criminal Science & Forensics: Criminal Science entails basic knowledge of police skills, including basic criminal law, fingerprinting, ballistics (matching bullets to weapons and angles of impact), and general investigative techniques. Criminology or police etiquette would be technical skills, but are not included because of their specialized nature. Forensic Medicine entails the methods and techniques used to determine the cause of death, time of death and other details when examining a corpse. **Base Skill:** 35% +5% per level of experience. **Requires:** Biology, Chemistry, Chemistry: Analytical, Advanced Mathematics and Literacy.

First Aid: Rudimentary medical treatment which includes how to bandage wounds, stop bleeding, administer CPR/artificial respiration, and use antiseptics and common anti-inflammatory drugs and painkillers. **Base Skill:** 45% +5% per level of experience.

Holistic Medicine: Training in the recognition, preparation, and application of natural medicines usually made from plants and their parts (roots, leaves, fruit). The holistic doctor is basically a naturalist who creates drugs from vegetation and studies common ailments. He can find and use plants to create salves, balms, ointments, and lotions to soothe bums, boils, rashes, and insect bites, reduce swelling, and to heal wounds faster (twice as quick as normal), as well as create local anesthetics. Potions and tonics are created to settle upset stomachs, and induce drowsiness, or hallucinations. The individual can also make alcohol and poison (hemlock and mandrake for example).

The student of herbology also has a good knowledge of plant lore and when and where to find healing plants, edible fruit, berries, roots and bark, as well as how to use and/or avoid dangerous flora. The character can also preserve foods and knows how to set and mend bones, and bandage, and suture cuts. **Note:** Plants are seasonal and the right root or leaf may not be readily available in certain times of the year/season, or may be found only in remote regions. G.M.s should use a certain amount of common sense and drama with this skill. **Base Skill:** 20% +5% per level of experience. A failed roll means the treatment did not work.

Paramedic: An advanced form of emergency medical treatment which includes all first aid techniques, the setting of broken bones, suturing of wounds, use of oxygen and emergency medical equipment, administering of drugs, knowledge of how to move a critically injured person, and other life-saving techniques.

A failed roll means the patient has not responded to treatment or that the treatment has been improperly administered. **Note:** For serious injury or coma, roll three times, consecutively, on percentile dice. Two successful rolls out of three means the wound has been properly treated or the condition has stabilized. Failure means the patient's condition is unchanged. Another character can immediately attempt to apply medical aid or the same player can try again, but only after the character has spent six minutes re-examining and/or concentrating on the problem. **Base Skill:** 40% +5% per level of experience.

Medical Doctor: The medical doctor is a trained surgeon and has a doctorate in the medical sciences. Some specific areas of training in-

clude: clinical skills, medical discipline, code of ethics, physiology (muscle, respiratory, blood, body fluids), pathology (diseases), rudimentary pharmacology (use, reaction and interaction of drugs), laboratory skills, and techniques and methods of data collection. **Base Skill:** 60%/50% +5% per level of experience. The first percentage number is the doctor's ability to accurately diagnose the problem. The second percentage number is the doctor's skill at successfully treating the problem. **Requires:** Biology, Pathology, Chemistry, Basic or Advanced Mathematics and Literacy.

Pathology: This branch of medicine deals with the nature of diseases, their causes and symptoms, and the functional and structural changes caused by disease. Training includes anatomy, physiology, cell biology, manifestation of disease, tissue injury and repair, abnormal cell structure, metabolism, diagnosis of human disease, tissue culture methods and applications, analysis of drugs in biological samples and laboratory research, investigative methods, and use of instruments, tools and equipment. **Base Skill:** 40% +5% per level of experience. **Requires:** Biology, Chemistry, and Literacy.

Military

Armorer (Field): A competent field armorer character can maintain, fix, modify, mount, reload ammunition, and figure out most small arms. They can repair all types of small arms, and minor damage to body armor (20 S.D.C. maximum), adjust targeting sights, use and repair optical enhancements, reload missiles and ammo drums, and even service most high-tech or Organitech hardware. **Base Skill:** 40% +5% per level of experience. Note: Automatically gets Basic Mechanics at +20% as part of this package.

Camouflage: The skill of concealing a fixed base position, vehicle, boat, equipment or individual using natural or artificial materials. A fair amount of time is involved in the preparation of a larger position. Large cargo nets, cut branches or underbrush are used most often in camouflage. This skill is also useful to conceal traps. **Base Skill:** 20% +5% per level of experience.

Demolitions: This skill provides the character with an advanced knowledge in the use and workings of explosives and detonation devices for the purpose of blowing up bridges, buildings, and sabotage. This includes all types of explosives, such as mines, dynamite, plastics, nitroglycerin, blasting caps, etc. It also includes a basic understanding of the strategic placement of mines and booby traps. This will increase the character's awareness of suspicious rope, string and wire. **Base Skill:** 60% +3% per level of experience. A failed roll results in an explosion! As a general rule, an accidentally detonated charge will hit body armor first, so characters may wish to suit up before using this skill.

Demolitions Disposal: This skill enables the character to safely defuse unexploded mines, bombs, explosive booby traps, dud artillery rounds, dud explosive charges, or any other explosive device. **Base Skill:** 60%+3% per level of experience. A failed roll results in an explosion (A full bomb suit provides A.R. 13 and S.D.C. 120).

Find Contraband & Illegal Weapons: The character with this skill knows where to find arms dealers, smugglers, black market shops/dealers, forgers, fences and illegal medical treatment. It also enables the character to acquire illegal items (guns, ammunition, explosives, false identification, drugs, etc.) and services (fences for stolen goods, forgers, etc.). He is also familiar with their hangouts, gang or criminal ties, general practices, code of conduct, pricing structures, and modes of operation. Likewise, the character has a good idea of what black market and illegal items and weapons should cost and what these people pay for contraband items (typically only 20% of the retail market price). The character also knows the penalty for being caught with an illegal weapon or item. (Granted, there are precious few places anymore where there is *any* law, much less those willing to enforce it...) This skill is especially appropriate in large cities around the world where some semblance of law and order still exists. **Base Skill:** 26% +4% per level of experience. Note: This skill should be considered separate and apart from Streetwise.

Military Etiquette: This skill grants a clear understanding of the way the military works, including rules of behavior (when to salute, how to address superiors/subordinates, etc.), military procedures and routines, standard issue of equipment, special ordering procedures, proper display of rank and medals, advancement in rank (and the duties that come with it), proper troop formations, how to deal with military bureaucracy, the chain of command, proper channels, who to contact to get things done, and other useful information in matters of military protocol and bureaucracy. **Base Skill:** 35% +5% per level of experience. Note: All soldiers have a fundamental knowledge of Military Etiquette (base skill of 30% with no improvement), but this skill is much more complete, with a strong knowledge of what is expected, correct and the formal, "by the book" way of doing things.

Military: Nuclear, Biological and Chemical (NBC) Warfare: This is the knowledge of safety procedures to protect oneself and others from the effects of nuclear, biological or chemical warfare, waste and contamination. The character is also knowledgeable in the safe handling and "clean-up" and containment of such hazardous materials. Note: Knowing this skill and having the equipment to actually perform this skill are two very different conditions. Many characters will have one but not the other. **Base Skill:** 35% +5% per level of experience.

Military: Parachuting: The skill of parachuting includes the methods, procedures and techniques of parachuting, packing a chute, skydiving techniques, precision landing, landing without injury, and practice of jumping from a high altitude aircraft. The advantage of parachuting is secrecy, since the trooper's insertion into enemy territory is silent and often goes unnoticed. The following three methods are the ones most commonly used by modern paratroopers:

High-Altitude-High-Opening (HAHO) jumps take place from a height of 25,000 to 30,000 feet (7,620 to 9,144 m). As the paratroopers drop, they travel laterally to the desired drop zone (DZ) where they wish to land. This technique is used to "throw off" enemy units since they will probably search for paratroopers directly beneath the path of the aircraft.

High-Altitude-Low-Opening (HALO) operations also begin at 25,000 to 30,000 feet (7,620 to 9,144 m) but the paratrooper does not pop the chute until an altitude of 4,000 feet (1,220 m), or even less. The jump takes place so rapidly that there is little chance for the paratroopers to be viewed after the chutes open.

Low-Altitude-Low Opening (LALO) are the most dangerous, made at a mere height of 300 to 500 feet (91 to 152 m). If there are any complications (a failed roll) the paratrooper is likely to be injured (broken bones) or even killed (30% chance)! Even if the jump goes off without a hitch, there is a 20% chance of taking 6D6 S.D.C. from an awkward landing, even if wearing body armor.

Failure on a Parachuting roll indicates that there are complications somewhere along the jump. This might mean an improperly packed chute, tangling of lines, etc. On a high altitude jump, the character gets a second roll for their reserve chute. If the second roll also fails then the character falls to his death! There is not enough time on a low altitude drop to use a reserve chute, so a failed roll means the character hits the ground and dies without a second chance. Parachuting can be selected as a Military or Pilot Related skill. **Base Skill:** 40% +5% per level of experience.

Recognize Weapon Quality: The ability to accurately determine a weapon's function, durability, reliability and quality by physically examining it. This includes knowing which manufacturers are reputed to have made the best weapons, the ability to recognize damage or signs of misuse, modifications/customization or wear and tear, whether the weapon can be made as good as new with a little repair work and/or cleaning, whether it is a cheap (or quality) "knock off" (copy/imitation) and so on. The character can also recognize if the weapon is stolen (serial numbers filed away, etc.), new, old, and if it has any other special features or properties, as well as what the fair price should be. **Base Skill:** 25% +5% per level of experience. Note: Reduce the skill ability

by half if the item is not actually handled (seen but not touched, examined); likewise if it is of an alien origin.

Trap/Mine Detection: Knowledge of the strategic placement of booby traps and mines, the telltale landmarks and indications of traps and mines, how to avoid them, and the use of mine and explosive detection equipment. The character has been trained to watch for suspicious objects, dirt mounds, trip wires and camouflaging materials that may denote the presence of a trap. Simple snare traps and trip wires can be easily disarmed by the character, but the Demolitions Disposal skill is required to disarm mines/explosives. **Base Skill:** 20% +5% per level on visuals alone. Add +50% when using special detection equipment to locate mines or explosives, or +10% to locate other types of traps with detection equipment.

Underwater Demolitions: Fundamentally the same basic skills and training as Demolitions, but with an emphasis on using explosives in an underwater environment, including underwater techniques, area effect, sound wave damage, different types of explosives, as well as arming, disarming, and repairing torpedoes and depth charges. **Base Skill:** 56% +4% per level of experience. Note: Any character with the Demolitions skill can use explosives underwater, but at -10%.

Physical

Hand to Hand: Basic: Provides elementary fighting techniques and methods of attack and self-defense as taught in basic military training or in self-defense classes. It costs one of the character's skill selections to learn. *See the Combat section for a listing of specific abilities.*

Hand to Hand: Expert: An advanced form of self-defense and unarmed combat usually taught to commandos. It costs two of the character's skill selections to learn. *See the Combat section for a listing of specific abilities.*

Hand to Hand: Martial Arts: This is usually some form of Oriental fighting skill (e.g., karate, kung-fu, etc.) that teaches advanced hand to hand combat. It costs three of the character's skill selections to learn. *See the Combat section for a listing of specific abilities.*

Hand to Hand: Assassin: This is an advanced form of combat with an emphasis on immobilizing or killing one's opponent quickly. It costs three of the character's skill selections to learn. *See the Combat section for a listing of specific abilities.*

Acrobatics: Aerial feats of agility or strength, such as walking a tightrope, high wire, trapeze, and stunts performed above ground. **Bonuses:** +2 bonus to roll with punch, fall or impact. +1 to P.S., +1 to P.P., +1 to P.E., +1D6 to S.D.C. Also provides the following abilities: Automatic kick attack at first level; 2D4 damage. Sense of balance (60% +2% per level). Walk tightrope or high wire (60% +3% per level). Climb rope (70% +2% per level). Back flip (50% +5% per level). Basic climbing ability (40%; or adds +15% to Climbing skill). Basic prowling ability (30%; or adds +5% to Prowl skill).

Athletics (General): Training in, and enjoyment of, vigorous exertion for competitive sports, exercises and contests of strength, endurance and agility. **Bonuses:** +1 to parry, dodge and roll with punch, fall or impact. +1 to P.S., +1D6 to Spd., +2D4 to S.D.C.

Body Building & Weight Lifting: The building of muscle tone and body strength through weight lifting and exercise. **Bonuses:** +2 to P.S., +10 to S.D.C.

Boxing: The classic art of fighting with fists. Training helps build the body and reflexes. Skilled boxers will *automatically* knock out opponents on a roll of natural twenty when fighting with their fists. The victim of a knockout will remain unconscious for 1D6 melees. Characters in full body armor or who have a natural A.R. will only be stunned (-4 to strike, parry and dodge for 1D4 melees) instead of knocked out. Unlike normal knockouts/stuns, the player does not have to announce that he is trying to knock out his opponent before making a die roll to strike. **Bonuses:** +1 additional attack per melee. +2 to parry and dodge. +1 to roll with punch, fall or impact. +2 to P.S., +3D6 to S.D.C.

Climbing: Knowledge of the tools and techniques for climbing up sheer surfaces. Players should roll once for every 20 feet (6 m) of a vertical climb. If the roll fails, it means he is losing his grip. However, every "skilled" climber gets a chance to regain his grip, so roll again. Two consecutive failed rolls means the character falls. **Base Skill:** 40% +5% per level of experience.

Rappelling is a specialized rope-climbing skill used to descend from helicopters, and for scaling walls and cliff facings. For game purposes, rappelling will include ascending and descending climbs. **Base Skill (Rappelling):** 30% +5% per level of experience.

Gymnastics: Learning to do falls, rolls, tumbles, cartwheels, somersaults, and to work the parallel bars and rings. This sport builds great upper body strength, grace and balance. **Bonuses:** +2 to roll with punch, impact or fall. +2 to P.S., +1 to P.P., +2 to P.E., +2D6 to S.D.C. Also provides the following abilities: Automatic kick attack at first level; 2D4 damage. Sense of balance - 50% +3% per level. Work parallel bars & rings - 60% +3% per level. Climb rope - 60% +2% per level. Back flip - 70% +2% per level. Basic climbing ability - 25% (does not increase); or adds +5% to Climbing skill. Basic prowl ability - 30% (does not increase); or adds +5% to Prowl skill.

Prowl: This skill helps the character to move with stealth; quietly, slowly and carefully. Techniques include balance and footing, short steps and pacing, rifle positioning, prone positions for low visibility, and crawling. A failed prowl means that the character has been seen or heard. If the prowl roll is successful, then the character is not detected and may make a sneak attack. G.M.s should use some common sense with this skill. A character can successfully prowl when there is no cover to hide behind, but in such a case he is only moving silently and can be seen easily. **Base Skill:** 25% +5% per level of experience.

Running: A regular routine of running and exercise to build speed and endurance. **Bonuses:** +1 to P.E., +4D4 to Spd., +1D6 to S.D.C.

Swimming: The rudimentary skill of keeping afloat, diving, swimming and lifesaving techniques. The percentile number indicates the overall quality of form as well as skill of execution. A character can swim a distance equal to 3x his P.S. in yards/meters per melee. This pace can be maintained for a total of minutes equal to his P.E. **Base Skill:** 50% +5% per level of experience. **Note:** The act of swimming on the surface of the water has the same fatigue rate as running and/or medium to heavy exertion.

S.C.U.B.A. (Advanced Swimming): The letters S.C.U.B.A. stand for Self-Contained Underwater Breathing Apparatus. Individuals learn the methods and equipment needed for skin diving, snorkeling and underwater swimming. A character can swim a distance equal to 2x his P.S. in yards/meters per melee. This pace can be maintained for a total of minutes equal to his P.E. **Base Skill:** 50% +5% per level of experience. **Note:** Swimming underwater with S.C.U.B.A. equipment or other underwater gear is considered to be light activity, unless extremely active, involved in combat or fast swimming (in which case it is considered strenuous or heavy activity). The buoyancy of water reduces the weight of most items by 30% when used/carried underwater. This means the fatigue rate for carrying a heavy load is reduced by 30% — meaning 30% more can be carried at the normal fatigue rate. Characters can also lift 30% heavier weights. The maximum safe depth without getting the bends is about 120 feet (36.5 m). Greater depths are possible with depressurization, special suits and submarines. **Requires:** Swimming.

Wrestling: Taught as a sport in high school and college, and as an integral part in certain forms of self-defense, this skill provide some useful combat moves. **Bonuses:** +1 to roll with punch, fall or impact. +2 to P.S., +1 to P.E., +4D6 to S.D.C. Also provides the following abilities: Body block/tackle does 1D4 damage and the opponent must dodge or parry to avoid being knocked down (lose one melee attack if knocked down). Pin/incapacitate on a roll of 18, 19 or 20. Crush/squeeze does 1D4 damage per squeeze attack.

Pilot: Basic

Airplane: Includes old propeller, single- and twin-engine types, including biplanes and modern Cessna-type aircraft. **Base Skill:** 50% +4% per level of experience.

Automobile: Manual and automatic transmission, including dune buggies, jeeps, and pickup trucks. Anyone can drive a car without the Pilot Automobile skill. As long as the unskilled character drives at reasonable speeds and is following the road, they are fine, but attempting any kind of stunts, combat, or trick driving will result in a crash. **Base Skill:** 60% +2% per level of experience.

Boat: Sail-Type: Small and medium-sized sailing vessels. **Base Skill:** 60% +5% per level of experience.

Boat: Motor and Hydrofoils: These include all types of small motor-driven boats and yachts, including jet skis. Anyone can drive a small motorboat without this skill. As long as the unskilled character drives at reasonable speeds or on a moderate course, they are fine, but attempting any kinds of stunts, combat or trick driving will result in a crash/capsizing of the craft. **Base Skill:** 55% +5% per level of experience.

Boat: Ships: This includes large sailing (more than one mast) and motor-driven seafaring vessels longer than 45 feet (13.5 m). Note that this skill only covers the actual driving of the boat. A crew will be needed to sail the craft. **Base Skill:** Sailing ships: 45% +5% per level of experience. Motor-driven ships: 44% +4% per level of experience.

Horsemanship: The skill includes the basic principles of riding, the care and feeding of the animal, recognizing breed and quality, charging and jumps. The percentile number is used whenever the character tries to determine breed, or quality, special jumps or maneuvers. **Base Skill:** 50% +4% per level of experience. **Special Bonuses:** The horseman has the advantage of height, leverage, and velocity when attacking on a horse. This provides the following bonuses when charging on horseback: +1 to parry and dodge, +4 to damage. Note that a person can not shoot a projectile weapon of any kind (bow and arrow or gun) with any degree of accuracy. An aimed shot is impossible on a moving animal! Bursts are possible if the horse is moving quickly, but not at a full gallop. At full gallop, the shooter can only fire wild.

Motorcycle: This skill includes the piloting of all two- and three-wheeled vehicles such as motorcycles of all types, dirt bikes, and mopeds. Anyone can drive a motorcycle without the pilot skill. As long as the unskilled character drives at reasonable speeds and follows a road, they are fine, but attempting any kind of stunts, combat, or trick driving will result in a crash. **Base Skill:** 60% +4% per level of experience.

Race Car: This is a specialized skill for vehicles that can travel at regular speeds above 120 mph (192 km). Characters without this skill are at -15% to pilot rolls at speeds above 125 mph (200 km). Maximum speed is typically around 220 mph (352 km). Characters with no driving skill can not drive at these speeds and they will crash. **Base Skill:** 55%+3% per level of experience.

Truck: This piloting skill specifically applies to large cargo and transport vehicles like eight- to sixteen-wheeled commercial trucks and multi-ton transports. **Base Skill:** 40% +4% per level of experience.

Water Scooters: The knowledge and skill of piloting all types of one- and two-man water sleds (underwater) and jet skis (surface sleds). **Base Skill:** 50% +5% per level of experience.

Pilot: Advanced

Note: Advanced Piloting skills involve vehicles and training that are not normally available to ordinary people. Most have highly specialized purposes or are used for military applications. For all military vehicles, the Weapon Systems skill is needed to effectively use mounted armaments.

Helicopter: The specialized skill required in flying all types of rotorcraft, including armed gunships. **Base Skill:** 35% +5% per level of experience.

Hovercraft (Ground): The knowledge needed in piloting hover cycles and other hover vehicles used for ground transport. These vehicles can be tricky, because they utilize several air jets and directional thrusters that push the craft along, above the ground, on a cushion of air. The vehicles can usually attain great speeds and are capable of driving over incredibly rugged terrain and making sensational jumps over craters and ravines. **Base Skill:** 50% +5% per level of experience.

Jet Aircraft: Includes large and small commercial transport jets, like Lear's and the giant DC models. **Base Skill:** 40% +4% per level of experience.

Jet Fighters: Training includes flying, maneuvering and aerial combat strategies. **Base Skill:** 40% +4% per level of experience.

Jet Packs: This is the piloting skill of backpack-like units that can carry an individual aloft. The typical jet pack is a one-person unit capable of hovering 300 feet (91.5 m). Most people can not use a jet pack at all, and the skill is absolutely necessary for other maneuvers like high and low altitude flight, controlled movement (between buildings or trees), stunts, and especially combat. **Base Skill:** 42% +4% per level of experience.

Submersibles: The knowledge and skill of piloting all types of submersibles, including underwater sleds, mini subs and most types of submarines, military and otherwise. **Base Skill:** 40% +4% per level of experience. **Note:** -20% when using highly unusual submersibles. Does not include power armor or deep-sea diving suits.

Tanks and APCs: Military vehicles often have unconventional controls and handle differently than conventional vehicles, especially the many ton, armored, combat vehicles such as tanks and armored personnel carriers (APCs). Thus, special training is required to pilot them. **Base Skill:** 36% +4% per level of experience.

Warships/Patrol Boats: Special training in the use of military warships, combat hydrofoils, patrol boats and amphibious beach craft/transports. Includes a basic idea of how to use sonar and targeting equipment, depth charges, torpedoes, and other common weapon systems, as well as evasive maneuvers and piloting. **Base Skill:** 40% +4% per level. **Note:** Characters with the Boat: Motor and Hydrofoils or Boat: Ships skills can also pilot these vessels but at a -12% penalty.

Pilot Related Skills

Navigation: Training in map reading, star charts, course computation, following landmarks, and use of navigational equipment. Includes land, air and water navigation, as well as piloting by instruments alone. A failed roll means the pilot is off course. Roll 2D6x100 for most aircraft, 4D6x100 for jets and 2D6x10 for ground vehicles to determine how many miles/kilometers they are off course. Roll for every hour that one is off course. **Base Skill:** 50% +5% per level of experience. **Requires:** Basic Math, Read Sensory Equipment, and at least minimal Literacy.

Read Sensory Equipment: Individuals with this training can operate, maintain, understand, and "read" or interpret sensory data from all types of conventional sensor devices. These devices include radar, sonar, motion detectors, surveillance equipment, optical enhancements, instrument panels and so on. Note that characters without this skill can not understand nor operate aircraft, radar, or detection/surveillance equipment (including thermo-imagers and ultraviolet sights). **Base Skill:** 30% +5% per level of experience.

Weapon Systems: This is the complete understanding of weapon units and systems incorporated in military vehicles, power armor, and robot vehicles. It includes machineguns, missile and grenade launchers, cannons, and other heavy weapons systems. Adds a special bonus of +1 to strike when using these types of weapons; this does not include hand-held weapons (*see Weapon Proficiencies*). The skill percentage is rolled when a character first attempts to familiarize himself with a specific vehicle's weapon systems. If the roll is failed, he can not figure out/find the controls and will be at -1 to strike instead of +1. He can roll once every five minutes of study. **Base Skill:** 40% +5% per level of experience.

Rogue Skills

Cardsharp: The character can perform various sleight-of-hand tricks with playing cards. This includes dealing from the bottom or middle of the deck, stacking a deck (to the cardsharp's favor), hiding cards up his sleeve (and elsewhere), fancy and impressive methods of shuffling and dealing the cards, marking cards, counting cards, and understanding the odds.

A failed roll means the character has fumbled the trick, missed (or misread) one of his secret markings, or was too obvious and is caught cheating. **Base Skill:** 24% +4% per level of experience. Add +4% if the character also has the Palming skill.

Computer Hacking: This is a computer skill similar to computer Programming, however, the emphasis of the skill is breaking computer access codes to gain illegal access to other computer systems and steal or sabotage their data. The character is an expert in tracing computer data, bypassing defense systems, and breaking ("hacking") codes; add a one-time bonus of +5% to Cryptography, Surveillance, and Locksmith skills if the character has this skill also. **Base Skill:** 30% +5% per level of experience. **Requires:** The ability to read and write, Computer Operation, Computer Programming, and at least Basic Mathematics.

Concealment: The practiced ability to hide small items on one's body or in one's hand, usually by continually moving it around from hand to hand or place to place unnoticed. Objects *must* be no larger than 14 inches (36 cm) in height or length, and six inches (15 cm) in width. The weight also must be 10 pounds (4.5 kg) or less. The smaller and lighter the object, such as a knife, gem, key, credit card, etc., the easier it is to conceal (add a bonus of +5%). Hiding handguns and knives under clothes is also done at +5%. Larger items such as a book, scroll, club, statue, or similarly large and heavy object are more difficult to conceal on one's person for obvious reasons. **Base Skill:** 20% +4% per level of experience.

Find Contraband & Illegal Weapons: See skill description under Military skills.

Palming: Simply the ability to pick up and seemingly make a small object, such as a coin, key or credit card, disappear by concealing it in one's hand. Adds a bonus of +5% to the Pick Pockets skill and +4% to the Cardsharp skill.

Pick Locks: See skill description under Espionage skills.

Pick Pockets: See skill description under Espionage skills.

Prowl: See skill description under Physical skills.

Safecracking: This is a specialized skill in which the character studies the strengths, weaknesses, and construction of safes and how to open them without damaging the contents inside. The fingers of the safecracker are so sensitive that they can "feel" the subtle calibration of combination locks and other locking mechanisms. When using explosives, they can use their abilities to such precision that they can "blow" the lock off a safe, security door or safe deposit box without creating a big area effect explosion or damaging the contents. A failed Safecracking roll or Demolitions roll means the explosion was too much and the contents are damaged. **Base Skill:** 20% +4% per level of experience. **Bonuses:** Adds a +5% bonus to the Pick Locks and Demolitions skills. **Penalties:** Requires focus, concentration and keen hearing, so characters with an M.E. under 15 are -10% on this skill.

Seduction: This is the ability to make the opposite sex melt with desire. This skill is somewhat similar to the Interrogation skill in that the seducer knows how to ask the right questions to get information without being obvious. The seducer usually seems attentive, sympathetic, and alluring/sexy. Men and women who are seduced tend to have loose lips and will spill secrets. They also lose track of time, spend big money to impress and please their seducer, and lavish her or him with their affection, time and attention, while oblivious to everything else around them.

Anyone who has been successfully seduced is distracted, skill performance is half and takes twice as long to perform, the character does-

n't notice people and events around him/her, and is easily caught off-guard; no initiative and all bonuses are at half when attacked by a character other than the seducer. Worse, the victim(s) of seduction is completely vulnerable to the seducer! The seducer always gets the first attack/strike/action. The victim has no chance at self-defense against that first attack, plus loses one attack/action from surprise or horror. In addition, the seducer is +5% to pick the pockets of, palm, or plant things on his/her victim of seduction, as well as adds +5% to the Cardsharp, Sing and Dance skills. Also, seduction victims who are intoxicated are easier to seduce (+5%). Note: This skill does not work on Drones (Bugged humans). **Base Skill:** 20% +3% per level of experience. **Skill Bonuses:** +1% for every one M.A. attribute point over 20, and every two P.B. points over 17 (round up). So a character with a P.B. of 23 (+3) and M.A. of 24 (+4) would be +7% to successfully seduce. The seducer can influence more than one person at a time; one additional victim per every three levels of experience.

Streetwise: This skill instills an understanding of the more lawless aspects of life. The streetwise character can recognize members of a particular gang, crew or warlord army by their actions and philosophies, "colors" (emblems and clothing that denote membership to a particular organization), gang symbols, hierarchy, mannerisms, etc. The individual will also recognize potentially dangerous situations, like when a brawl or gunfight might break out. (This is not the same as the Detect Ambush skill, however.) In those rare places where law and order have been reestablished, Streetwise also includes the ability to recognize and locate black market dealers/organizations, illegal clinics, drugs and arms dealers, and similar criminal outfits. **Base Skill:** 20% +4% per level of experience.

Ventriloquism: The practiced ability to throw one's voice. This can be used to create the illusion of not speaking while making a voice or verbal noise appear to be coming from someone or something else, such as a puppet, tree, box, chair, etc. Maximum range is 10 feet (3 m) away. A failed roll means the voice is not well thrown or the ventriloquist's mouth is seen moving, so the trick does not work. **Base Skill:** 16% +4% per level of experience.

Science

Anthropology: This is the behavioral study of man and other intelligent life forms and their environments. Studies include societies, customs and beliefs, religions and political structure, as well as rudimentary history and archaeological backgrounds. It is important to note that Anthropology is more concerned with the study of modern races and societies than it is with ancient ones. This is especially important when dealing with other races and cultures in the present time to avoid accidentally breaking taboos or codes of behavior. It will also tell the anthropologist whether he may be dealing with a dangerous people (fear technology, are cannibals, worship demons, etc.).

This skill can also be used in the examination of items/artifacts and ruins to identify the probable people/race, purpose and technological level. The character can identify the period in which the item was used (contemporary or ancient), but is not skilled enough to tell whether an item is an authentic artifact or a forgery without much research and possibly a laboratory. **Base Skill:** 20% +5% per level of experience.

Archaeology: This is the scientific study of relics of ancient civilizations by excavation and analysis of artifacts. Studies include proper excavation (digs) techniques, preservation, restoration, and dating methods (including carbon dating), as well as rudimentary history and anthropological backgrounds. **Base Skill:** 20% +5% per level of experience. Note: Adds +5% to the Anthropology skill.

Astronomy: The study of the stars and other celestial bodies, their movements, positions, cycles, alignments, and inter-relations with the Earth and each other. This knowledge can also be used to determine direction, approximate distances, identify seasons, and tell the time of day. **Base Skill:** 25% +5% per level of experience.

Astrophysics: Includes a working knowledge of the Astronomy skill and can be used to determine direction, approximate distances,

identify seasons, and tell the time of day, but more importantly, it is used to study the universe and how it relates to nuclear physics, quantum mechanics, relativity, and other explanations of deep space phenomena like quasars and black holes. The skill combines astronomy and physics and also includes a working knowledge of the theories of time and space. **Requires:** Basic and Advanced Mathematics. **Base Skill:** 25% +5% per level of experience.

Biology: Basic understanding of cells, anatomy, physiology, evolution, and genetics. The character will know how to use a microscope, cultivate bacteria, and how to classify new organisms. **Base Skill:** 30% +5% per level of experience.

Botany: Plants, their categories and functions, are studied extensively. Characters will know the basics of cross-fertilization and germinating, as well as growing experimental plants. **Base Skill:** 25% +5% per level of experience.

Chemistry: The basic understanding of chemical principles and formulae. Characters know enough chemical laboratory procedures for analyzing and synthesizing chemical compounds in order to be competent assistants. Propellants for bullets can be made with this skill, but not explosives. **Base Skill:** 30% +5% per level of experience.

Analytical Chemistry: Training in chemical engineering theories useful in the analysis of compounds and their practical applications. Characters will be highly skilled in the use of laboratory equipment and can analyze and synthesize chemicals (including explosives, but their use still requires the Demolitions skill). **Base Skill:** 25% +5% per level of experience. **Requires:** Chemistry, Advanced Mathematics, and Literacy. Computer Operation is highly suggested but not required.

Basic Mathematics: Knowledge of basic math, including the ability to count, addition, subtraction, multiplication, division, and fractions. **Requires:** Literacy. **Base Skill:** 45% +5% per level of experience.

Advanced Mathematics: Knowledge of all basic and advanced mathematics including algebra, geometry, trigonometry, calculus and techniques for advanced mathematical formulae. **Base Skill:** 45% +5% per level of experience. **Requires:** Basic Mathematics.

Technical

Art: The ability to draw, paint, or sculpt or do craft-work. Scholastic art training indicates a professional quality, while a Secondary Skill indicates a talented amateur. **Base Skill:** 35% +5% per level of experience.

Business and Finance: This skill, possessed mostly by merchants and entrepreneurs (who were far more common before The Meltdown than they are now), enables the character to cut financial deals for himself. When buying or selling something, the character can use this skill to haggle on the price. On a successful roll, this skill will award the character with anywhere from a 01-33% price modifier (roll percentile dice to determine) in his favor. A failed roll means the character must settle on the "listed" price. At the G.M.'s discretion, if the character misses his skill roll by a wide margin, he may end up getting a *worse* than usual deal. **Base Skill:** 35% +5% per level.

Computer Operation: A knowledge of how computers work, along with the skills to operate peripherals like keyboards, printers and modems. Characters can follow computer directions, enter and retrieve information, and similar basic computer operations. However, this does NOT include programming and hacking. **Base Skill:** 40% +5% per level of experience. **Requires:** Literacy.

Computer Programming: Advanced computer knowledge that includes designing, programming, debugging, and testing computer programs and software. Hacking is possible, but at a penalty of -40% unless the character also has the Computer Hacking skill (see Rogue skills). **Base Skill:** 30%+5% per level of experience. **Requires:** Computer Operation and Literacy.

General Repair: Not everyone can be a mechanic or an electrician, but many are good with their hands and are capable of doing satisfac-

tory repairs on simple mechanisms, gears, pulleys, wheels, rope, and so on. The General Repair/Maintenance skill includes: sharpening blades, minor repairs on weapons, packing their own bullets/ammunition, sew torn clothing, replacing a wagon wheel, changing a tire, shoeing a horse, repairing furniture, painting, varnishing, nailing, basic woodworking, and minor patchwork on armor (restores 2D6 S.D.C).

Roll once to see whether the character can figure out what's broken, what must be done to fix it, and whether it's beyond his meager abilities. Roll again to determine success or failure in making the actual repair. If failure, the player may try again, but only twice. **Base Skill:** 35% +5% per level of experience. Reduce skill proficiency by half if the item is extremely damaged, complex, or high-tech.

Law (General): This general study of law provides the character with a basic understanding of laws and customs and a rudimentary understanding of legal procedures, crimes and punishment throughout the Western parts of the world (U.S., Canada, Mexico, Britain, Europe). **Base Skill:** 25% +5% per level.

Language: Characters with a Language skill can understand and speak in a language other than their own native tongue. Language is one of the few skills that can be taken repeatedly, in order to select several different languages. Each selection gives the character knowledge of a different language and costs one skill selection each time. **Base Skill:** 50% +5% per level of experience.

Literacy: It is assumed that most characters in this game are literate. Only those poor unfortunates that dropped out of school, grew up on the streets or in the backwoods somewhere will not have basic Literacy. Depending on the setting of the campaign, however, the G.M. may require all characters to purchase Literacy as a skill rather than get it automatically. **Base Skill:** 30% +5% per level of experience, but educated individuals will have 98% Literacy in their native tongue.

Photography: Training in the art of still photography, the use of lighting, cameras, lenses, and other camera equipment, as well as storage, development, enlargement, and duplication of film/photos. **Base Skill:** 35% +5% per level of experience.

Research: Training in the use of methods, techniques, and locations for finding information, including public records, libraries, federal information services, data bureaus, interviews, surveys, demographics, trade journals, clipping services, computer services, and legal searches. This skill is helpful in locating information about people, places and things. The G.M. will ultimately regulate the availability of accessible, known information regarding a particular subject. Any character can do research and ask questions, but the Research skill will reduce the amount of time needed by half and the character is trained to notice relevant data that an untrained character is liable to overlook. Thus, for truly mysterious, secret or difficult information, have the character with the Research skill try to uncover it. Only roll to determine success on these difficult or hushed up bits of information, including addresses, unlisted telephone numbers, car license plate numbers, obscure and suppressed data. **Base Skill:** 50% +5% per level of experience.

Writing: The ability to write stories, poems or journalism (articles, reports, news). Scholastic training indicates professional quality while the Secondary Skill indicates a talented amateur. A failed roll means an awkward and poorly written work that is boring and/or difficult to understand. Try again. **Base Skill:** 25% +5% per level of experience. **Requires:** Literacy.

Ancient Weapon Proficiencies

Ancient weapon proficiencies cover all forms of hand-held or projectile weapons common before the advent of firearms, even if the weapon being used is a modern version, like a compound bow or a Bowie knife. Needless to say, ancient weapons have become very popular in the post-Meltdown world, where firearms and ammunition sometimes are in short supply.

Each ancient W.P. provides combat training with a particular type of weapon. The result is hand to hand combat bonuses to strike and

parry whenever that particular weapon is used. All bonuses are cumulative. Each W.P. counts as one skill. The character may select several W.P.s or few. **Note:** Characters without a W.P. can use any weapon, but without the benefit of the W.P. bonuses.

W.P. Archery and Targeting: This is an expertise with thrown and bow weapons. It includes throwing spears, forks, slings, short bow, long bow, cross bow, and modern bows. **Bonuses:** Add 20 feet (6.1 m) to the normal effective range per level of the character; +1 to parry with that weapon (effective at level one); and +1 to strike at levels 2, 4, 6, 8, 11 and 14. **Note:** The character loses all bonuses and rate of fire is half when riding on horseback or a moving vehicle. **Rate of Fire:** Two at level one, +2 at level three, +1 at levels 5, 7, 9 and 12.

W.P. Battle Axe: Training in all types of axes and picks. **Bonuses:** +1 to strike at levels 1, 4, 8 and 12. +1 to strike at levels 3, 8 and 12.

W.P. Blunt: Training with all types of blunt weapons, including maces, hammers, cudgels, pipes, staves and clubs. **Bonuses:** +1 to strike and parry at levels 1, 4, 8 and 13.

W.P. Chain: Training with all types of chain weapons, including ordinary lengths of chain, nunchaku, flails, and ball and chain, or mace and chain. **Bonuses:** +1 to strike and parry at levels 1, 4, 8 and 13.

W.P. Knife: Training with all types of knives. **Bonuses:** +1 to strike when thrown at level 1, +1 to strike and parry at level 2, add another +1 to parry at level four, add another +1 to strike and throw at level 7, add +1 to parry at level 8, and +1 to strike, parry and throw at levels 11 and 15.

W.P. Paired Weapons: This skill is automatic at 7th level for those with Hand to Hand: Expert and Martial Arts, but it can also be taken as a separate skill. The effects are identical (see Combat Terms), but when taken as a skill, only two specific kinds of paired weapons are included. For example, the character may be skilled in paired short swords or paired axe and short sword, but not both (that would require two Paired Weapons skill selections). When the skill is acquired under Hand to Hand: Expert or Martial Arts, it represents a high level of achievement and any two single-handed weapons can be used together in a pair.

W.P. Polearm: Training in the large spear-like weapon known as the polearm. Also includes tridents. **Bonuses:** +1 to strike at levels 1, 5, 9 and 14. +1 to parry at levels 1, 3, 6, 9 and 12. +1 to strike when thrown at levels 2, 5, 9 and 14.

W.P. Shield: Combat skills with large and small shields. **Bonuses:** +1 to parry at levels 1, 3, 6, 9, 12 and 15. +1 to strike when thrown at levels 2, 5, 9 and 14. Shields can be used as paired weapons.

W.P. Spear: Combat skill with large and small spears (the use of a rifle with a bayonet also falls into this category). **Bonuses:** +1 to strike and parry at levels 1, 3, 5, 8, 11 and 13. +1 to strike when thrown at levels 3, 6, 10 and 14.

W.P. Staff: Combat skill with large and small staffs. **Bonuses:** +1 to strike at levels 1, 3, 7, 10 and 13. +1 to parry at levels 2, 5, 8, 11 and 14. +1 to strike when thrown at levels 5, 10 and 15. Not designed for throwing.

W.P. Sword: Combat skills with large and small swords, including fencing-type training. Includes rapiers, sabers, two-handed swords and short swords. **Bonuses:** +1 to strike and parry at levels 1, 3, 7, 11 and 14.

W.P. Throwing Weapons (Small): See *W.P. Targeting*. Includes throwing knives, throwing axes, throwing sticks/irons, darts, bolas and similar.

W.P. Targeting (Throwing/Missile Weapons): Expertise with a thrown weapon and proficiency with missile weapons such as the sling, slingshot, bolas, throwing sticks, throwing axes (small), throwing knives, shuriken, javelins, and spears. The use of a bow is a separate skill; see *Archery*. **Bonuses when thrown or slung:** +1 to strike at levels 1, 3, 5, 7, 10 and 13. Characters who select both W.P. Targeting and W.P. Archery, W.P. Knife or W.P. Spear get the usual bonuses for that W.P. plus a bonus from W.P. Targeting of +1 to strike at levels 2, 5 and

10. **Rate of Fire:** Equal to the character's normal number of hand to hand combat attacks. Note: The character loses all bonuses and rate of fire is half when riding on horseback or in a moving vehicle.

Typical Effective Range & Damage per Projectile Weapon Type:

Blowgun: 30 feet (9 m) - 1D4 damage
Boomerang: 60 feet (18m)- 1D6 damage
Bow, Short: 340 feet (104 m) - 2D6 damage
Bow, Long: 640 feet (195 m) - 2D6 damage
Crossbow, Small (pistol size): 120 feet (36.5 m) - 1D6 damage
Crossbow, Light (rifle size): 340 feet (104 m) -2D4 damage
Crossbow, Heavy (rifle size): 600 ft (182 m) - 2D6 damage
Dart: 30 feet (9 m) - One point of damage.
Javelin: 300 feet (91 m) - normal javelin damage +1D4
Throwing sticks and knives: 40 feet (12.2 m) - 2D4 damage
Spear: 100 feet (30.5 m) - normal spear damage +1D6 damage
Sling or Slingshot: 80 feet (24 m) - 1D6 damage

Note: Swords, large axes, (non-throwing) knives, hammers, clubs, maces, polearms, and most other hand-held weapons are NOT designed to be thrown. Consequently, the average throwing range is a mere 20 feet (6 m) and the character is -1 to strike. An attacker can try to throw such weapons farther, but will be at -3 to strike for every additional 10 feet (3 m) beyond the initial 20 feet (6 m).

Spears, javelins, slings, throwing sticks/knives/axes, and bows can be thrown or fired by anybody without penalty at the typical ranges listed above.

W.P. Whip: Skill at whipping or snapping with long, flexible light weapons. Bonuses: Start with +1 to strike at levels 1, 3, 5, 7, 9, 11 and 13. +1 to damage at levels 4, 8 and 12. +1 to entangle at levels 2, 6, 8, 10 and 14. A typical whip or "cat-o-nine-tails" inflicts 1D6 damage. A bullwhip inflicts 2D6 damage.

Modern Weapon Proficiencies

Modern weapons include firearms and energy weapons, but they do not cover modern versions of ancient weapons (see Ancient Weapon Proficiencies). These are areas of training and practiced skill with a particular class of modern weapon. Each W.P. counts as one skill selection. Modern W.P. bonuses are found in the Combat section under Modern Weapon Proficiency Explanation. Characters with no knowledge of modern weapons can fire loaded weapons, but will take twice as long to reload and always shoot "wild" with no bonuses to strike.

W.P. Revolver: All cylinder-style handguns, like a .38 Special or .357 Magnum.

W.P. Automatic Pistol: All modern clip-fed pistols, like a Beretta 9mm or a Colt .45 ACP. The name is something of a misnomer; these weapons fire only one bullet per each squeeze of the trigger.

W.P. Bolt-Action Rifle (Hunting & Sniping): Includes most hunting rifles, like a .303 Lee-Enfield, not automatic firing weapons.

W.P. Automatic and Semiautomatic Rifles: Includes all assault rifles like the M-16 and AK-47.

W.P. Sub-machinegun: Includes all automatic and semiautomatic small arms like the Uzi, H&K MP5 and the Skorpion.

W.P. Shotgun: All types of shotguns.

W.P. Heavy: Includes light and heavy machineguns, rocket/missile launchers and mortars. Also includes flamethrowers, Bug Juice spray guns and Bug Repellent spray guns.

W.P. Light Energy Weapons: Includes the Z9 "Bronson" Light Energy Pistol, Z10 "Eastwood" Heavy Energy Pistol and Z23 "Ventura" Energy Carbine/SMG.

W.P. Heavy Energy Weapons: Includes the Z41 "Stallone" Energy Assault Rifle, Z60 "Schwarzie" Light Energy Cannon and Z88 "The Duke" Energy Support Cannon.



Wilderness

Boat Building: This skill enables the character to build a variety of rafts, small rowboats, large flatbed boats, and canoes. A small raft (two man) can be made within 1D6+1 hours if lumber or other suitable materials are present. A large raft will take about 4D6 hours, a canoe 2D6 days, a rowboat 4D4 days, and a large flatbed raft 1D4X10 days to construct. Time is doubled or tripled if trees must be cut down and wood prepared. Of course, the time can be reduced if several knowledgeable people are working on the construction. A failed skill roll means the boat has leaks. Trying to patch it requires 4D4 hours. **Base Skill:** 25% +5% per level of experience.

Carpentry: A fundamental knowledge of working with wood. The character knows how to prepare, treat, and preserve wood, recognize quality craftsmanship, can repair damaged wood and wood items, and build chests, chairs, tables, cabinets, houses, etc. Adds a +5% bonus to the Boat Building skill if taken. **Base Skill:** 25% +5% per level of experience.

Hunting: The skill of killing and preparing an animal for food. **Special Bonuses:** Add the following bonuses to the appropriate skills: +2% to Prowl, +5% to Track Animals, +5% to Skin Animals, +5% to Wilderness Survival, and +5% to Cook the catch only. **Base Skill:** None. Merely an enhancement to other skills.

Identify Plants & Fruits: Training in the recognition of the many different types of plants and vegetation and where they grow. The emphasis is placed on edible, herbal and poisonous plants. **Base Skill:** 25% +5% per level of experience.

Land Navigation: This skill enables the person to stay on course while traveling over land by means of observation. It includes mentally marking/recognizing geographic landmarks, estimating distance and movement, recognizing sounds, night travel, and other navigational tricks. The player should roll once for approximately every three miles (4.8 km) traveled. A failed roll means the character is drifting off course; 2D10x100 yards/meters. Consecutive failed rolls means the individual does not realize that he's off course and continues in the wrong direction.

Note: A group of average adults can cover about five miles (8 km) an hour at a brisk, but relaxed, pace through grassland, along dirt roads or on pavement. Travel through dense forest or jungle at a cautious pace, with eyes open for danger, is about one mile (1.6 km) an hour. Heavy rain or snow, fog, swamps, etc., will also reduce speed. **Base Skill:** 36% +4% per level of experience.

Preserve Food: Knowledge in the preparation of foods for storage and later consumption. Includes canning fresh fruit, vegetables, herbs, drying meat and fish, plus various smoking, salting, and pickling methods. **Base Skill:** 25% +5% per level of experience.

Skin and Prepare Animal Hides: Training in the methods and techniques in skinning, tanning, stretching, and preserving animal hides as fur or leather. Adds a +5% bonus to the Sewing skill. **Base Skill:** 30% +5% per level of experience.

Track Animals: This skill enables the character to identify and follow an animal by its tracks, scent, spoor, and habits. This means he can estimate how fresh the tracks are, what direction the animal is heading, whether the animal is hurt or sick, and a rough guess at its age. The habits and habitats of animals and animal behavior are also learned. Tracking humans with this skill is also possible, but is done at -20%. **Base Skill:** 20% +5% per level of experience.



COMBAT

The Palladium combat system is relatively quick and simple. All combat moves (strikes, parries, dodges, etc.) are resolved by rolling a twenty-sided die (D20).

Hand to Hand Combat

Hand to hand combat between two parties essentially consists of each combatant going through the following five steps repeatedly until one is dead, unconscious, has surrendered or has fled from battle.

Step 1: Determine Initiative

Any time opponents square off for battle, the G.M. must determine who has the initiative. In other words, who will attack first. Successful *Sneak Attacks* or *Long Range Attacks* will always have initiative for that melee round (15 seconds). Otherwise, whoever *rolls highest* on a twenty-sided die will attack first. In the case of a tie, re-roll. Initiative is

rolled only once per melee round. That roll will determine the pace for the entire round.

Step 2: Attacker Rolls Strike

The next step is for the first attacker to roll a twenty-sided die. If the result is a four or less (counting bonuses), the attacker misses. *Any roll above a four will hit the opponent*, unless the defender can parry or dodge the attack. If the target is wearing body armor or has natural armor, then the roll to strike must exceed the A.R. of the armor or it will not hurt the target. The strike will either damage the body armor, or if the character has natural armor, the strike will do no damage at all.

Step 3: Defender May Parry, Dodge or Entangle

Any time an attacker rolls a successful hit, the defender can choose to parry, dodge or entangle.

Parrying blocks the attacker's strike, preventing damage from being inflicted. **For example:** A punch can be blocked by the character's hands or arms. A weapon attack (sword, axe, mace, etc.) can be parried/blocked by a shield, sword or other weapon or object held in the defender's hand. A weapon should only be parried with another object. Trying to parry a weapon with one's hand or arm will result in a failed parry and the usual amount of damage being inflicted by the weapon. Parrying a weapon bare-handed is dangerous (and usually entails parrying the attacker's weapon arm(s) rather than the weapon itself), and all such attempts are without the benefit of the character's parry bonuses.

Characters formally trained in hand to hand combat (e.g., have any of the Hand to Hand skills: Basic, Expert, Martial Arts or Assassin) may "automatically" try to parry any incoming attack without using a melee attack/action of their own. In essence, they get one "free" attempt to parry incoming attacks. Characters with no hand to hand combat training will lose their next melee attack every time they parry.

Disarming means an attack designed not to injure, but to knock a weapon out of an opponent's hand(s).

Entangle means the character actually pins or snares an opponent's weapon(s) or arm(s). Any character who uses this defense must forfeit their next melee attack/action.

A **dodge** means the character physically moves out of the path of the attack. With only a few exceptions, each dodge uses up one of the character's attacks per melee round. So constantly dodging means the character has no opportunity to attack.

Dodging missile attacks. Characters can attempt to dodge incoming energy blasts, bullets, arrows, and other fast-moving missile attacks, but it is rather difficult.

The problem is, dodging these attacks means timing the evasive move just right. Even if a character can see a bad guy pointing a gun right at him, he doesn't know if or when he is going to shoot. Such a *guess* is based on a response to the assailant's body language and often subtle movement, such as the tensing of his trigger finger, or the shifting of his stance. In that split second, the character must make his move and hope his attacker doesn't compensate fast enough to hit.

This also involves split-second timing because bullets, energy blasts, etc., move so fast that it is virtually impossible to move out of the way in time, even if one knows the attack is coming. Unless listed otherwise, characters dodge energy blasts, bullets, arrows, rockets and other such missile attacks *without* their usual dodge bonuses (straight die roll) and with a penalty of -4. To be successful, the dodger must roll higher than his attacker's roll to hit. So as you can see, this kind of dodge is no mean feat. **Note:** This -4 penalty can be ignored if the would-be assailant really doesn't want to hurt anybody or if the dodger has the initiative.

Parrying missile attacks. Parrying energy blasts, bullets, and other missile attacks is even more difficult. Characters may try but must roll without any of their usual parrying bonuses, and at -8. And, the parry roll must be higher than the incoming attack roll. Further, the character must have something like a shield, piece of metal, or weapon to parry

the attack. One simply can not parry bullets or energy blasts with his hands!

Note: In all cases, the defender can only parry and dodge against attacks that are within his line of vision. Attacks from the rear and long-range attacks (especially from a concealed assailant or sniper) cannot be parried, dodged or entangled. Likewise, the first shot from any long-range attack is a surprise attack and can not be dodged or parried. After the first shot, the characters) can try to dodge, run or leap to take cover and to try to figure out where the attack is coming from.

Except for when noted otherwise, the *defender always wins ties* when parrying, entangling or dodging.

Step 4: Attacker Rolls Damage.

If a successful strike is not parried, dodged or entangled, the attacker hit his target and rolls for the amount of damage inflicted. Each weapon description will indicate the type and number of dice to roll to determine damage. For example, a knife does 1D6 damage while a claymore sword does 3D6 and a war club does 2D4.

In addition to the weapon damage, the attacker may also get damage bonuses from hand to hand combat skills, P.S., quality craftsmanship of the weapon, etc. All bonuses are cumulative, so if a character has a P.S. of 20, he adds +5 to damage. If he is also using a weapon that is +2 to damage and has a +2 damage bonus from his hand to hand combat skill, his total damage bonus would be +9.

Critical strikes do double damage. So the example above, if it were a critical strike, would inflict 2D6+9 x2. Combined critical strikes, like a Natural 20 and a jump attack, do *triple* damage. Add the damage bonus to the roll before doubling or tripling damage. A natural, unmodified 20 is always a critical strike.

A **pulled/punch or strike**, whether with fist or weapon, inflicts as little damage as the attacker desires (down to one point), provided that in addition to his attack roll, he makes a separate die roll and gets a natural 11 or higher. A failed attempt to pull a punch means full damage, bonuses and all, has been inflicted. Note: Characters can also try to "pull punch" when using firearms or other missile weapons. This is like in cowboy movies when you see gunmen just skin their enemies to show them they mean business, or shoot specifically to wound/disable.

Step 5: Defender May Attempt to Roll with Impact/Punch

If the attack is a physical impact from things like a punch, kick, mace, hammer, staff, thrown rock, fall, explosion, etc., the defender can attempt to *roll with the impact/punch/fall*. In order to roll with the impact, the defender must roll a D20 and *match* or better the attacker's roll to strike. Successfully rolling with a punch/impact or fall means the character only takes *half* damage. Successfully rolling with a knockout punch means the character takes double damage but is not knocked unconscious or stunned. Rolling with a death blow results in the loss of half of all remaining S.D.C. (or Hit Points if all S.D.C. have been depleted). Failing to roll with impact means the character has used up one of his melee actions/attacks and still takes full damage from his attacker. Roll with impact/punch/fall counts as one melee action/attack.

Step 1: Start all over again. Now that the person with the highest initiative has gotten a chance to attack (and his opponent a chance to defend), the person with the next highest initiative roll initiates the same five-step sequence. When everybody in the fight has gotten a chance to go through this once, that "phase" of the melee round has ended and a new "phase" begins, starting from the character with the highest initiative roll.

One on one combat goes back and forth like this for the entire melee round. First, one strikes and the defender tries to parry or dodge, then the defender retaliates, hitting his attacker back. This goes on until one yields or surrenders; is beaten into submission, unconsciousness or is captured; or is slain.

The melee round ends when each character has used up all of his attacks.

In many cases, one combatant will have more attacks than the other. That's okay. When the fighter with the least number of attacks uses them all up, all he can do is parry. Yes, this is fair. Watch a boxing match; the boxer who is faster will throw more punches than a slower or less experienced opponent. When both combatants have used up all their attacks (and all other pairs of combatants in the group have done likewise), the melee round is over and the next one begins. A melee round lasts approximately 15 seconds in fictional game time, but can last several minutes in real, player time, especially if the player group is large.

Next melee round: Start again by having everybody roll for initiative (Step 1) and repeat Steps 2-5. This continues until one set of combatants is triumphant over the other. This can be when one side or the other are all slain, surrender, are captured, or flee.

Combat Clarification on Group Combat: In group combat, each player character pairs off with an opponent. The G.M. should handle it so that one player has strikes and parries against an opponent, then the next player, and the next, and so on. In some cases, there is a dramatic effect in having the entire Combat sequence fought out between one or two players, and then the next one and the next, but as a rule, it is best to divide the action up so everybody has something to do and feels like they are contributing to the outcome of the battle.

Since villains fight dirty and heroes are frequently outnumbered, a player character is likely to find himself under attack from two or more enemies. Depending on the character, his abilities and his opponents, this may or may not be a serious problem. (Remember, running away is, sometimes, the better part of valor.) However, facing multiple foes means the character must either ignore some of his attackers while he focuses on the most dangerous or important one (giving those he ignores a free shot at him without the benefit of parrying or dodging them), or divide his attacks. Of course, this gives his enemies the advantage, and that's exactly why they would gang up on him. The character can attempt to parry all hand to hand attacks that he can *see* coming at him.

Combat Terms & Moves

Note: The following combat maneuvers are applicable to many forms of hand to hand combat and martial arts. A specific move like Disarm or Jump Kick will be indicated under the particular hand to hand skill description and may not be available until higher levels.

Armor Rating (A.R.): The A.R. indicates what an attacker must roll above in order to strike and do damage to the character's physical body (Hit Points or physical S.D.C.). Any roll above the A.R. of the body armor will penetrate the armor and directly damage the person underneath. The higher the A.R., the better the protection. Any roll above four but below the A.R. hits and damages the armor only. When the armor is destroyed (all S.D.C. has been depleted), so is the A.R. protection. All subsequent attacks will hit the character's body; subtract damage first from the character's physical S.D.C. and then, when all the S.D.C. is gone, from Hit Points.

Natural A.R.: Some characters may possess a naturally protective skin or armor (like NORAD Splicers and Bugs). Any attack rolls below the character's Natural A.R. might scuff or scratch the body, but they do no substantive damage. Attack rolls that exceed the character's A.R. inflict full damage to S.D.C. first and then to Hit Points.

Attribute Bonuses: Combat and saving throw bonuses gained through physical or mental strengths that give a character an extra added degree of agility, strength, endurance, etc.

Automatic Dodge: Characters with this ability can "automatically" dodge incoming attacks. That is, they move so fast that they get a "free" attempt to dodge each incoming attack without having to use a melee attack/action. When a character is trying an automatic dodge, only the automatic dodge bonuses and his P.P. attribute bonuses (if any) are used. The automatic dodge and regular dodge bonuses are not cumulative. The two maneuvers rely on different techniques and thus

have separate bonuses. The use of the word "automatic" is something of a misnomer in that the dodge is not automatic. Dice still need to be rolled for a successful dodge. It is automatic in the sense that it is a quick, reflex movement that does not burn up a melee attack/action.

Back Flip: The back flip involves throwing oneself backwards with the arms and shoulders, flipping the legs completely up, over and back down on the ground into a standing position. The result is that one quickly moves backwards by a full body length. This skill also enables one to perform cartwheels as well. Doing a back flip (or cartwheel) counts as one melee attack/action and can be used as a dodge or for entertainment.

If used in place of a dodge, the character must roll higher than his opponent's strike roll, using only the natural die roll (do not include any dodge bonuses). Failure to beat the strike means taking full damage without a chance to roll with punch. Success means avoiding the attack, like a dodge.

Body Block/Tackle: This is a combination of moves that involves a body block and a knockdown attack (counts as two melee attacks). A successful body block strike does 1D4 damage plus P.S. damage bonuses, and the opponent is likely to be knocked down. A successful strike always inflicts damage (from a shoulder, elbow, or tucked head), unless his opponent dodges (no damage and no knockdown), but the victim who is hit can avoid being knocked down only by trying to maintain his balance; roll percentile dice. Characters with no special balancing abilities must roll a 01-40% or be knocked down. Those with a special balancing ability like those from Acrobatics or Gymnastics must roll under their current skill level. A successful maintain balance means the victim is not knocked down but loses one melee attack, and takes full damage. Being knocked down causes the character struck to lose initiative (if he had it) and one attack/action for that melee round, plus he is knocked 1D6 feet away from where he was standing at the moment of the attack. A roll with impact can reduce damage by half, but counts as one melee action.

Body Flip/Throw: A judo-style throw or flip that uses an attacker's own momentum and leverage to "flip" or "throw" him off his feet and onto the ground. Damage is 1D6 points plus P.S. damage bonus (if any), and the victim also loses initiative (if he had it) and one melee attack. A body flip counts as one melee attack. A victim of a throw can try to roll with impact/fall to diminish the damage (half if successful), but other penalties are unchanged.

Critical Strike: A powerful, special or nerve-shattering strike that inflicts *double* the usual amount of damage. Critical strike damage can be inflicted with bare hands or with a weapon.

Death Blow: A special attack designed to kill an opponent in one or two strikes! This attack is often limited in hand to hand combat to the roll of a "natural" strike number, e.g., "Death Blow 19-20." Whenever the words "death blow" are presented without limitation, the character can use a death strike whenever he desires. However, he must announce his intention to use this attack. This devastating attack counts as two melee attacks.

A death blow attack does double the normal damage (including all bonuses) direct to Hit Points! This attack can be used with punches and kicks or hand-held weapons such as swords, clubs, etc. It is not applicable to thrown or missile weapons, and it does not work through body armor; the armor must be removed or penetrated (by rolling above its A.R.). Likewise, against opponents with a Natural A.R., the attack must be higher than the natural A.R. to affect Hit Points, but even if beneath the Natural A.R., the death blow *will* inflict S.D.C. damage.

Disarm: The disarm move is a strike, hold, or grappling maneuver that causes an opponent to drop his weapon or whatever it is he's holding. This defensive maneuver counts as one melee attack/action and can be done in place of a dodge/parry or as an attack/strike. Disarm does not give the weapon to the character making the disarm move. The weapon or item has merely been knocked from the victim's hand and falls to the ground. A failed disarm roll does no damage and means one's opponent remains armed and ready (and willing!) to strike.

Entangle: A defender can attempt to trap the weapon or arm of an attacker. This is done instead of parrying or dodging, and counts as one melee attack/action. An entangle is successful if the defender rolls above the attacker's strike roll. It takes one attack and a roll to entangle to keep an opponent's arm or weapon trapped/pinned every melee round. In order to get free, the entangled opponent must roll a dodge against the entangle roll; high roll wins. The character using the entangle move cannot attack without releasing his entangling hold.

Hand Attacks: The following are some of the typical damage amounts inflicted by the various types of punches. Remember to add P.S. bonuses to damage.

Backhand Strike-1D4

Body Flip-1D6

Human Fist (Punch) - 1D4

Karate Strike/Punch - 2D4 (Only available to characters with Hand to Hand: Martial Arts, once they reach third level)

Elbow/Forearm - 1D6

Power Punch - Does double damage, but counts as two melee attacks. Applicable to all hand strikes.

Hand to Hand Combat: Fighting skills that provide the character with attacks per melee round, bonuses, techniques and special moves. Characters without combat training only have one attack per melee round and have no automatic chance to parry or to make special moves.

Hold (Optional): Using both hands, the attacker grabs on to some part of the opponent's body and attempts to immobilize him. If the strike is successful, then the victim is helpless until released. Holds do no damage and neither the attacker nor the victim can attack, parry or dodge while the hold is working. It's easy for the attacker to hold the victim so that a third character can attack unopposed.

To get out of a hold, both the victim and attacker roll a D20 and add in their P.P. attribute scores. The person doing the hold also gets to add in all his bonuses to strike from the P.P. attribute (if any). High roll wins! If the attacker wins, then the hold continues. If the victim wins, then the hold is released and combat can continue. Holds are available to characters skilled in Wrestling at first level. Hand to Hand: Martial Arts can use them at third level, Hand to Hand: Expert can use them at fourth level, and Hand to Hand: Basic gains them at fifth level. Common types of holds include arm holds, leg holds, body holds and neck holds.

Kick Attack & Flying Jump Kicks: There are a whole range of kick attacks, each of which works differently.

Kick Attack: This is a conventional, karate-style kick. It starts with bringing the knee, folded, up to chest level, then the foot is completely extended. Damage: 2D4.

Snap Kick: A very short, very fast kick. Usually delivered low, striking the opponent somewhere below the waist. It works well in confined spaces and in grappling range but does relatively little damage; only 1D6.

Roundhouse Kick: By turning the body and swiveling the hips, this kick packs tremendous power. Can be used only once per melee round and no other kicks can be used in that round, either. Damage: 3D6.

Wheel Kick: A damaging kick that involves sweeping the leg completely around the body. Cannot come right before or right after another kick. Damage: 2D6.

Crescent Kick: A swivel-hipped kick that sends the foot out on a sweeping arc. Damage: 2D4+2.

Axe Kick: A very high kick that goes up and over the opponent, coming down on the neck or shoulder. Can't be used in the same melee round with any other kicks. Damage: 2D6.

Backward Sweep: Used only against opponents coming up behind the character. Does no damage; it's purely a knockdown attack. Cannot be parried, only dodged.

Tripping/Leg Hook: An attack on the opponent's legs. Does no damage, it's purely a knockdown attack. Also cannot be parried, only dodged.

Horror Factor (H.F.): Horror Factor represents the overwhelming and paralyzing feeling people can get when faced by something that is too horrible, bizarre or amazing for their mind to behold (at least until the initial shock has passed). Whenever a character encounters a monster, alien, or simply something extremely horrifying, the player rolls a D20 to see whether or not the character is momentarily stunned by what is seen. This Horror Factor roll might be thought of as a saving throw or mental parry. Fortunately, the character only needs to roll for the first melee round of each encounter, not every round of combat.

To save vs Horror Factor, the player must roll a D20. Just like a parry, the roll must be equal to, or higher than, the Horror Factor of whatever it is the character has just encountered. **For example:** An alien Bug with a Horror Factor of 12 emerges from an interdimensional nexus in the middle of a power plant. In this case, a successful save is 12 or higher. Everybody in the group but poor Bill rolls above a 12 and saves. Bill rolls a six, so his character is momentarily stunned with horror. (In this game, characters usually refer to this phenomenon as "Bugging out," as in, "Whoa! Bill just Bugged out!")

A failed roll to save means the character is so overwhelmed that he or she is temporarily stunned. In game terms this means the character loses initiative (doesn't even roll for it), loses one attack/action, and cannot defend himself (no parry or dodge) against the creature's *next* attack of that melee round. Fortunately, the character snaps out of his shocked stupor quickly, and can join the combat that same melee. By the second melee round, the character has completely recovered his senses and is functioning as normal; roll for initiative and combat as usual.

Knock Out/Stun: This special attack will momentarily knock out or stun/daze its victim for 1D4 melee rounds. Usually available on an unmodified strike of 19 or 20 and can be used in place of a critical strike, but the player must announce his intention to use a knock out attack before he rolls to strike.

Victims of a successful KO/stun attack must roll above a 15 on a D20 (P.E. bonuses apply) to remain conscious. Failure to save results in being knocked unconscious for 1D4 melee rounds! A successful save means the character remains conscious but his head is full of cobwebs. It will take 1D4 melee rounds for his head to clear, during which time he loses two melee attacks and all combat bonuses are reduced by half.

Jump Kicks: Performed by leaping completely off the ground and landing foot-first on the opponent. Jump kicks can only be used by those skilled in Hand to Hand Martial Arts (and only at higher levels).

Jump Kick: 6D6 damage plus any P.S. or Hand to Hand damage bonuses! The advantage of a jump kick is that if it connects, it inflicts crushing damage. The disadvantage is that no other attacks may be performed in that melee round, and the jump kick must be the character's first attack of the melee round. For the rest of the round, the character can only parry, dodge and move into position.

Flying Jump Kick: Must be made from at least 6 feet. (1.8 m) away. The character launches into the air, taking a position that will smash one foot into the opponent. Does 4D6 damage plus any Hand to Hand or P.S. damage bonuses, but counts as two melee attacks.

Leap Attack: An airborne assault where the weapon and/or fists or feet are wielded in mid-leap. An attack must be made only at the beginning of a melee round and, like a jump kick, uses up all attacks for the melee round. Usually a leap attack affords just one strike on an opponent. But if a character manages to leap between two opponents, he can try to hit them both simultaneously. Roll to strike for each attack. After a leap attack, a character may only parry, dodge and move around for the rest of the melee round. During a leap attack, characters may use automatic parries, but dodging will be impossible.

Maintain Balance: When some kind of knockdown attack has succeeded, and while the character is starting to fall over, this is his last chance to attempt to recover. A successful roll (1-40% or under current skill percentage from Acrobatics or Gymnastics) means that the character will immediately regain his balance and remain standing. He can

continue to fight but the act of regaining balance means he used up one melee attack/action. When "Maintain Balance" is used, "Roll with Punch, Fall or Impact" can not be used.

Melee Action: Instead of attacking, a character can elect to do something else, i.e. look for something in his backpack, run to a different position, use a medical kit, hide, climb a tree, etc. Each action counts as one melee attack.

Melee Attack: During combat, every attack action (strike, dodge, entangle, etc.) counts as one melee attack or action unless otherwise noted.

Multiple Attackers: There will be times when a character is besieged by more than one opponent. Unfortunately, he can only attack one at a time and may elect to divide the number of his attacks per melee between the attackers or concentrate on only one, attempting only to parry the others. The lone defender can parry all attacks that are within his *line of vision*. If an opponent slips far to one side or behind him, the defender cannot parry the strike because he is concentrating on the assailants in front of him.

Natural Twenty: The outcome of combat is determined by the roll of a twenty-sided die (D20). The higher the roll, the better. Many combat "rolls" get bonuses to strike, parry, dodge, etc. These bonuses are added to the roll of the die. For example, if a 12 is rolled, but a character has cumulative bonuses of +4 to strike, then the roll is *modified* to 16.

A *natural twenty* is rolling the highest possible number (a 20) without adding any bonuses to the number rolled. A natural 20 never misses unless one's opponent also rolls a natural 20 while attempting to parry or dodge (it's rare, but it happens). Yes, a natural 20 will hit even if an opponent's roll is higher than 20 after bonuses are added to it. A natural 20 also does double damage.

Number of Attacks: All characters start out with two attacks per melee plus any gained from Hand to Hand and the Boxing skill. Thus, a level one character who has taken Hand to Hand: Martial Arts will start *with four* attacks per melee, whereas a first level character with no formal hand to hand training starts with only *two* attacks per melee. Additional attacks may be acquired as one advances in Hand to Hand combat skill and experience. In some special cases, characters may have particular abilities that grant them extra attacks/actions. Experienced, trained fighters will have an average of 4-7 attacks per melee, if not more!

Paired Weapons: Certain kinds of weapons, such as sai, nunchaku, knives, clubs and swords, can be used as paired weapons. Users of paired weapons can strike and parry simultaneously, can do twin strikes upon a single target or against a pair of targets, and can parry two different opponents at the same time. In other words, warriors skilled in paired weapons can often do two actions for every one of their melee attacks (i.e., strike and parry). However, a twin, simultaneous strike with both weapons means losing the automatic parry and leaves the character open to his opponent's next attack without the benefit of a parry (dodging is an option but costs one attack/action). Characters who select the Paired Weapons skill under the Ancient Weapons Skill Program must choose which two weapons they are skilled at using paired (i.e., sword and knife, sword and sword, or sword and axe, etc.) but seventh level characters skilled in Hand to Hand: Martial Arts or Expert are able to use *any* two single-handed weapons in a pair because they have taken so much time to build up their skill.

Pull Punch: The ability to control the force of a hand to hand attack, whether it be a punch, kick, or with a weapon. The character can choose to inflict half damage, quarter damage or just a single point of damage. A character must declare a pulled punch and the player must roll an 11 or better on a D20 to successfully pull his punch. A failed roll to pull means full damage is accidentally inflicted.

Saving Throws: Occasionally, characters must roll to save against exotic attacks like poison, gas, disease, psionics, etc. The following are the minimum or base saving throws needed in each category.

Coma/Death: (see *Coma and Hit Points*, in the Character Creation section)

Harmful Drugs/Toxins: 15 or better.

Poison, Lethal: 14 or better.

Poison, Non-Lethal: 16 or better.

Insanity: 12 or better.

Psionics: 15 or better for *Non-Psionics*; 12 or better for Latent, Minor and Major Psionics; and 10 for Master Psionics.

Simultaneous Attacks: Combatants can parry or dodge each others attacks or they can forfeit any type of defensive maneuvers (probably by taking damage from the opponent's strike) and strike back simultaneously. The advantage of a simultaneous strike is that, while opening oneself to damage, it deprives one's opponent from parrying or dodging the counterstrike. The reason the attacker loses his opportunity to parry when the defender attacks simultaneously is that he cannot both attack and defend at the same time. Thus, both combatants may take damage from each others blows. The tactic can be used by any character, regardless of their combat training (or lack thereof).

Sneak Attacks or Attacks From Behind: *No initiative roll for the first melee round.* When someone sneaks up (prowls or attacks from behind or above), using the element of surprise on his opponent, the attacker has the initiative. The opponent is unaware that he is about to be attacked and has no time to prepare. The sneak attacker has the first strike. His victim is totally unaware and does not even get to parry the first strike. Afterwards, he can gather his wits and strike back or parry the next incoming attack, but he still lacks initiative for that melee round in which combat was begun.

S.D.C. Values

The following list contains the basic S.D.C. values for a variety of objects and items. When an object's S.D.C. is reduced to zero, it is considered broken and worthless. G.M.s should exercise common sense in applying these values. For example, a normal human cannot break through a metal vault door no matter how long he bangs on it with his fists, even if rolling natural 20s each time.

The S.D.C. of different weapons is applicable only if someone is specifically trying to break one (average weapon has 50 S.D.C.) A properly wielded sword can inflict and parry many times its S.D.C. without fear of breaking. On the other hand, using the sword to wedge open a door could easily snap the blade in half. **Note:** See the *Heroes Unlimited™ GM's Guide* for more details about S.D.C. in the Rampage and Brawling section.

Box, Cardboard: 2 S.D.C.

Box, Wooden Shipping Crate: 12 S.D.C.

Box, Metal Shipping Crate: 48 S.D.C.

Chain (To Cut or Snap): 30 to 50 S.D.C.

Door, Interior, Wood: 100 S.D.C.

Door, Exterior, Wood: 170 S.D.C.

Door: Metal Grille: 350 S.D.C.

Door, Solid Metal: 600 S.D.C.

Door, Metal Safe: 800 S.D.C.

Door: Bank Vault: 5,000 S.D.C.

Handcuffs, Regular: 60 S.D.C.

Handcuffs, Heavy: 120 S.D.C.

Handcuffs, Super-Alloy: 300 S.D.C.

Leather Strap, Light: 1-4 S.D.C.

Leather Strap, Heavy: 10 S.D.C.

Leg Irons, Light: 120 S.D.C.

Leg Irons, Heavy: 200 S.D.C.

Leg Irons, Super-Alloy: 500 S.D.C.

Lock, Common Latch: 40 S.D.C.

Lock, Deadbolt: 100 S.D.C.

Lock, Heavy Padlock: 75 S.D.C.

Rope, Light (to cut): 6 S.D.C.

Rope: Heavy (to cut): 12 S.D.C.

String/Twine (to cut): 1 S.D.C.

Wall, Interior Plaster: 75 S.D.C., per sq. 10 feet (0.9 m)

Wall, Exterior Wood: 150 S.D.C., per sq. 10 feet (0.9 m)

Wall, Exterior Brick: 200 S.D.C., per sq. 10 feet (0.9 m)

Wall, Cinder Block: 300 S.D.C., per sq. 10 feet (0.9 m)

Wall, Reinforced Concrete: 400 S.D.C., per sq. 10 feet (0.9 m)

Wall, Super-Alloy: 1,000 S.D.C., per sq. 10 feet (0.9 m; used mostly by military)

Weapon, Hard Wood: 40 S.D.C.

Weapon, Metal Sword: 100 S.D.C.

Weapon, Small Pistol: 35 S.D.C.

Weapon, Assault Rifle: 75 S.D.C.

Weapon, Artillery Piece: 1, 500 S.D.C.

Window, Ordinary Glass: 20 S.D.C.

Window, Plexiglas: 35 S.D.C.

Hand to Hand Combat Styles

The basic moves of initiative, strike, parry, entangle, dodge, disarm, body block/tackle, and roll with impact are automatic to all Hand to Hand combat styles. Remember, all characters in this game, heroes and villains alike, automatically have *two* attacks per melee round even before they acquire any combat training. Thus, the two attacks a character starts out with, plus the two one gets, from, say, Hand to Hand: Expert at 1st level, comes to a total *of four* hand to hand attacks per melee round.

Hand to Hand: Basic

Level 1: +2 attacks per melee round. +2 to roll with punch/fall/impact. +2 to pull punch.

Level 2: +2 to parry and dodge.

Level 3: Kick attacks: Karate-style kick (2D4) or Snap Kick (1D6)

Level 4: +1 attack per melee.

Level 5: +1 to strike and +1 to initiative.

Level 6: Critical Strike on natural 19 or 20 (double damage)

Level 7: +2 to damage.

Level 8: Body Throw/Flip and +1 to disarm.

Level 9: +1 attack per melee.

Level 10: An additional +2 to pull punch and roll with impact.

Level 11: An additional +1 to parry and dodge.

Level 12: An additional +1 to strike.

Level 13: Critical strike or knockout from behind.

Level 14: An additional +2 to damage.

Level 15: +1 attack per melee.

Hand to Hand: Expert

Level 1: +2 attacks per melee round. +2 to roll with punch/fall/impact. +2 to pull punch.

Level 2: +3 to parry and dodge.

Level 3: +2 to strike and +2 to initiative.

Level 4: +1 additional attack per melee.

Level 5: Kick attacks: Karate-style kick (2D4) and any two of choice, excluding jump kicks.

Level 6: Critical strike on a natural 18-20.

Level 7: Paired weapons.

Level 8: Body throw/flip and +2 to disarm.

Level 9: +1 additional attack per melee.

Level 10: +3 to damage and an additional +2 to pull punch.

Level 11: Knockout/stun on a natural 18-20.

Level 12: An additional +2 to parry and dodge.

Level 13: Critical strike (triple damage) or knockout from behind.

Level 14: +1 attack per melee round.

Level 15: Death Blow on a natural 19-20 (if desired).

Hand to Hand: Martial Arts

Level 1: +2 attacks per melee round. +3 to roll with punch/fall/impact. +2 to initiative, and +3 to pull punch.

Level 2: +3 to parry and dodge. +2 to strike and disarm.

Level 3: Kick attack (2D4) plus any four other kicks of choice, except jump kicks.

Level 4: +1 attack per melee round.

Level 5: Jump kicks (all).

Level 6: Critical strike on a natural 18-20.

Level 7: Paired weapons and +2 to disarm.

Level 8: Leap attacks.

Level 9: +1 attack per melee.

Level 10: Body throw/flip and +1 to initiative.

Level 11: An additional +4 to damage.

Level 12: An additional +2 to parry and dodge.

Level 13: Knockout/stun on a natural 18-20.

Level 14: +1 attack per melee round.

Level 15: Death Blow if desired; must announce his intention.

Hand to Hand: Assassin

Level 1: +1 attack per melee round. +1 to initiative, +2 to strike, and +2 to pull punch.

Level 2: +2 attacks per melee round.

Level 3: +3 to roll with punch/fall/impact and +3 to pull punch.

Level 4: +4 to damage, +3 to disarm and +2 to initiative.

Level 5: +1 attack per melee round.

Level 6: +3 to parry and dodge, and body flip/throw.

Level 7: Death Blow if desired; must announce his intention.

Level 8: +1 attack per melee round.

Level 9: Kick attacks: Karate kick (2D4) and any two of choice, except jump kicks.

Level 10: Critical strike on a natural 18-20.

Level 11: Knockout/stun on a natural 17-20.

Level 12: +2 to initiative, +2 to strike, +1 to disarm.

Level 13: +1 attack per melee round.

Level 14: +2 to damage, and roll with impact, punch or fall.

Level 15: +2 to strike and +1 to initiative.





Modern Weapon Combat

Modern Weapon Proficiencies (W.P.) are areas of training and practiced skill with a particular type of weapon, such as a revolver, automatic pistol, or sub-machinegun. This skill provides special bonuses to strike when you're using that weapon. Do not add this strike bonus to your character's hand to hand combat skills; it applies only to the use of modern weapons. That means all types of guns, rocket launchers, energy weapons, and so on. Bows and crossbows are considered ancient weapons. **Modern W.P.s provide the following bonuses:**

Aimed Shots: +3 to strike with all guns except the revolver, which gets +4.

Firing a Burst: +1 to strike.

Shooting Wild: No bonus or penalty.

Add a bonus of +1 to strike at levels 4, 7, 10 and 13.

Training also enables the character to easily reload, disassemble, unjam, clean and otherwise maintain the weapon. Recognizes weapon quality — 30% at level one and +6% per each additional level of experience.

Combat Range & Rolls to Strike

A roll of five or higher strikes its mark in hand to hand combat. The same is true of combat with firearms at *close range*, within a 60 foot (18.3 m) distance. For firearms combat at *medium range*, within a 60-200 foot (18.3 to 61 m) distance, combatants must roll an 8 or higher to strike. For firearms combat at *long range*, within any distance greater than 200 feet (61 m), combatants must roll a 12 or higher to strike. The G.M. may also consider the limitations of one's vision, the movement of a target, use of protective cover, and a weapon's effective range for determining further modifiers to strike.

Aimed Shots

An aimed shot means a person takes the time to carefully aim and squeeze off one well-placed shot. Each individual shot counts as one melee attack/action. Thus, if a character has four attacks per melee round he can only shoot *four* aimed shots. This applies to all modern weapons. Roll to strike for each shot.

Bonus to Strike: +4 with a revolver, +3 with all other firearms.

Firing a Burst

A "burst" involves shooting three or more rounds at once. All "automatic" pistols, sub-machineguns and assault rifles, as well as certain shotguns, are designed for burst firing. The act of firing a burst makes aim more hasty and the recoil much greater, reducing overall accuracy. The concept is that, while accuracy is reduced, the odds of hitting one's target are much greater anyway because of the number of rounds fired. **Note:** Roll to strike once for the entire burst. Do not roll for each individual bullet/energy blast. If the burst misses the target, then all the rounds in that burst miss.

Bonus to Strike: +1 with all weapons.

Damage From a Short Burst: Roll the damage for ONE round, x2. Fires 20% of the entire magazine; i.e., a short burst from a weapon with a 30-round magazine (or "clip") would use 6 bullets. Uses up one attack. Can be fired only at one target.

Damage From a Long Burst: Roll the damage dice for ONE round x2 for clips with 15 shots or less rounds of ammunition, ONE round x3 for firearms that are capable of burst firing 16-29 rounds of ammunition, ONE round x5 for clips with 30-50 rounds. A long burst fires 50% of the weapon's magazine; i.e., a long burst from a weapon with a 30-round clip would use 15 bullets. Uses up one attack. Can be fired at only one target.

Damage From an Entire Magazine: Roll the normal damage for ONE round x3 if the clip has 15 rounds or less. ONE round x5 for firearms that are capable of burst firing 16-29 rounds of ammunition. ONE round x7 for clips with 30-50 rounds. And x10 damage on an entire clip with more than 50 rounds. Shooting off the entire clip within an entire melee round is possible (100% of the rounds are fired). Uses up three attacks that melee round and can be fired at only one target. Machineguns are the only exception to this rules.

Spray: Shooting a burst at several targets at once is possible, but is the same as *Shooting Wild*. You must fire a long burst or an entire magazine in order to spray. See *Shooting Wild*.

Note: Semi-automatic weapons fire a bullet each time the trigger is pulled, which means a pretty high rate of fire can be achieved by rapidly pulling the trigger. However, this rate is not as fast as automatic fire. Consequently, semi-automatic weapons require an extra melee action/attack in order to squeeze off a long burst (counts as two attacks), or to empty the clip in a full melee burst (counts as four attacks).

All automatic pistols and double-action revolvers are semi-automatic, as well as all commercial versions of assault weapons and some hunting rifles. Most military weapons, automatic rifles, and

sub-machineguns are fully automatic weapons, although some have a switch to change them from full automatic to semi-automatic or even single-shot.

A normal burst that uses the *entire clip* takes up three melee attacks/actions (about 7 seconds), other bursts use one attack. Bursts from a semi-automatic weapon use two attacks for a long burst and four for an entire clip.

Shooting Wild

Shooting wild occurs when a trained character shoots without taking time to aim. This usually happens when the person is blinded, angry, running, rolling, leaping, shooting from a moving vehicle, etc.

Bonus to Strike: If the character has a W.P. for that particular type of weapon (i.e., W.P. Pistol or W.P. Sub-machinegun, etc.) there is no bonus or penalty for shooting wild, just a straight, unmodified roll of the dice to strike (the G.M. may add impose a -1 to -4 penalty for extenuating circumstances or extreme difficulties).

Characters with no W.P. skill in that type of weapon can shoot bursts from it, but all shots are -6 to strike, and no other strike bonuses apply, not even P.P. bonuses. Aimed shots by somebody without a W.P. for that type of weapon get no bonuses or penalties; they go with a straight, unmodified D20 roll.

When shooting wild, either *long bursts* or the *entire magazine* must be fired, and counts as two attacks if the clip has less than 30 rounds or as three attacks if the clip has more than 30 rounds.

Wild shooting can be fired at one target or in a wild spray.

Shooting at a single target: Roll to strike as usual, but at -6. If the primary target is hit, roll damage dice for ONE round x2 if under 30 shots were fired, or for ONE round x5 if 30-100 rounds were fired. In addition, there is a 01-20% chance that any innocent bystanders within 20 feet (6 m) of the target will be hit as well. Damage to bystanders is equal to ONE round.

Spraying indiscriminately: There is a 01-50% chance of hitting *everyone* in the line of the spraying attack who is not under cover. Generally, this can be as wide as a 180 degree arc before the shooter. Anybody within that arc is subject to the spray fire. Those who are hit take damage dice from ONE round.

Bursts or Sprays From Machineguns

Machinegun burst firing is different from other burst firing because of higher rates of fire, greater stopping power behind each shot, and greater ammo capacities.

Short burst directed at one target: Approximately 6-10 rounds. Damage: ONE round x3. Counts as one melee attack.

Short burst, spray: Approx. 8-12 rounds. Damage: ONE round per individual struck; 01-40% chance of hitting everybody in the line of fire. Player Characters can see the direction the gunner is sweeping in, so they can try a normal dodge without the benefit of their normal bonuses.

Long burst directed at one target: Approx. 20-50 rounds. Damage: ONE round x8. Counts as two melee attacks.

Long burst, spray: Approx. 30-50 rounds. Damage: ONE round x2 per individual struck; 01-50% chance of hitting everybody in the line of fire. Player Characters can see the direction the gunner is sweeping in, so they can try a normal dodge without the benefit of their normal bonuses.

Emptying the entire magazine or belt at one target: All rounds fired (50-300 depending on the weapon and ammo feed system), and counts for all attacks for one full melee round. Damage: 50-99 rounds fired do ONE round x10. 100-190 rounds fired do ONE round x20. 191-300 rounds fired do ONE round x30.

Emptying the entire magazine or belt in a spray: All rounds fired (50-300 depending on the weapon and ammo feed system), and counts for all attacks for one full melee round. A full magazine spray has a 01-70% chance of hitting *everybody* in the line of fire. This is a devas-

tating attack capable of wreaking enormous damage, especially to massed troops, or, more unfortunately, to innocent bystanders. Player Characters can see the direction the gunner is spraying in and can try to dodge, but without any of their usual bonuses. Damage: 50-99 rounds fired do ONE round x2 per individual hit. 100-190 rounds fired do ONE round x3 per individual hit. 191-300 rounds fired do ONE round x5 per individual hit.

Note: Triple damage against giant, slow-moving or stationary targets the size of a tank or bigger since they are much easier to target and hit. Reduce the damage (i.e., the likelihood of hitting a target) by half if the machine-gunner is moving or if his target is fast-moving (over 40 mph/64 kph).

It takes one full melee round to reload a belt-fed machinegun but only three melee actions to reload a magazine-fed machinegun.

Natural Energy Blasts

Characters who can emit energy blasts can use this attack as often as they like, with each blast typically counting as one attack/action. Characters can mix and match blasting attacks with hand to hand and weapon attacks within the same melee round.

Firearm Tactics & Penalties

Called Shot: A "called shot" is required to shoot a specific target or a specific small and difficult target to strike. **For example:** Attempting to shoot a weapon or object out of somebody's hand, or to shoot somebody in the arm, leg, head, etc., shoot a specific part of a vehicle, or to make any other kind of sniper shot requires a called shot. A called shot is always an *aimed shot*, so it gets a +3 bonus to strike in addition to the character's other bonuses to strike. That final bonus, however, is then halved because called shots are generally very difficult to make. A natural 20, of course, always hits and does double damage. Called shots are especially useful for taking out heavy vehicles. A character will get smeared if he takes on an assault helicopter in a straight fight, but if he targets the chopper's relatively weak main rotor, he could take it out with only one shot from a strong enough weapon.

Ricochet Shot: This shooter can try to bounce bullets, arrows, slings, and other fired projectiles off of one surface and angle the shot in such a way that the projectile hits a different or second target! The first target takes only one point of damage while the second takes full damage. This can only be attempted as a called shot, but without the benefit of any strike bonuses; a straight, unmodified D20 roll only. To make a ricochet shot, the character must roll a 15 or higher when rolling to strike! Like we said, these are very tough shots to make, but if the character makes the shot, his target will have no opportunity to parry or dodge it.

Shooting a rifle one-handed: The shooter loses all strike bonuses and he cannot make aimed or called shots. If shooting one-handed while moving, all shots are considered shooting wild. Machineguns and heavy weapons cannot be fired one-handed unless the character has a P.S. of 35 or higher.

Shooting from a moving vehicle or while running: Considered a wild shot. Aimed shots and called shots are impossible.

Trick Shooting: Shooting over the shoulder at targets behind the character, shooting while hanging upside down, etc., are done without the benefit of any bonuses when a revolver, bolt-action rifle, semi-automatic weapon or energy weapon is used, but considered wild if shooting a burst with a semi-automatic or automatic weapon. Aimed and called shots are impossible. Trick shooting cannot be attempted with machineguns and heavy weapons.

Volleys & Bursts

Vehicle pilots usually have several modes of attack available to them, such as lasers, machineguns, grenade launchers, missiles and hand to hand combat. Weapons or modes of attack can be used in any combination. You are limited only by the number of attacks per melee and possible payload and rate of fire restrictions. **For example:** A char-

acter piloting an armed helicopter has five attacks per melee. The character fires a volley of four rockets (Attack #1), fires a single shot from his nose-mounted grenade launcher (Attack #2), fires two long bursts of machinegun fire (Attacks #3 and #4) and then fires a single air-to-ground missile (Attack #5).

Wait a minute! This character has five attacks, but in the example, he fires four rockets and then attacks four more times. Isn't this EIGHT attacks? No, and here's why. One volley or burst counts as one attack, even if a dozen missiles or bullets are launched. How? Because it requires only one attack/action to fire off a burst or volley of bullets or missiles simultaneously. Roll to strike and dodge as usual. However, volleys and bursts do have their disadvantages.

First, the entire volley or burst must be directed at only ONE specific target. The character cannot divide a volley or burst between several targets. To attack more than one target, the pilot must take time to aim and fire at each, which means each counts as an individual attack that melee round. **For example:** A soldier in a battlesuit is up against four armed motorcycles. The pilot decides to launch four of his 12 missiles at one of the cycles. That's one attack, leaving three more for that melee. He cannot fire each of the four missiles at a different motorcycle; each motorcycle must be attacked separately. Unless, of course, the pilot chooses to fire off his weapons in a spray, as described in the *Shooting Wild* section.

Second, the character must roll to strike for the entire volley or burst as if it were one unit. This generally means that the entire volley or burst either strikes and does multiple damage or it missed. Do not roll to strike for each individual round or missile.

Third, volleys and bursts usually deplete one's weapon payload (ammo capacity) quickly, so such weapons should be used sparingly.

Explosives, Rockets & Missiles

Aside from ballistic and energy weapons, rockets and missiles also are common armaments found on the battlefields of **Systems Failure™**.

Rockets and Missiles. Rockets generally are unguided and get no bonuses to strike. Missiles generally are guided by the operator or are self-guiding. In either case, missiles get a bonus of +3 to strike; none of the operator's other personal bonuses apply.

Rolls to strike are made on the usual D20. Rockets and missiles can be launched one at a time (roll to strike for each), or in volleys of two or more (roll once to determine whether the entire volley strikes its target). If the roll to strike is successful, the weapon scores a **direct hit** and inflicts full damage. If a volley scores a direct hit, then full damage from each and every rocket, missile or explosive in that volley inflicts full damage. If the target successfully rolls with impact, of course, he will take only half damage from the volley. At the G.M.'s discretion, explosive weapons that miss their mark may only do so narrowly and will still catch their target in the peripheral blast. These **near misses** do half damage to anyone or anything caught in the blast area. Characters who successfully roll with impact from a near miss take only a quarter of the weapon's normal damage.

While a character can dodge a volley of two or three rockets or missiles, a volley of four or more is impossible to dodge. The only defensive option is to shoot the incoming projectiles down before they strike. Shooting and depleting the S.D.C. of a missile can detonate and destroy it. However, there are restrictions.

First, the character must have an attack(s) available to him/her that melee to assail the missile. If all the attacks for that melee have already been used up, the character can not shoot at the missiles(s).

Second, the character can shoot at only one missile within the volley at a time. Therefore, a volley of six missiles would require six attacks to shoot down entirely. Given how fast missiles fly, this would be impossible. Usually, characters can only target one or two missiles of an incoming volley, no more. A called shot is necessary to hit incoming missiles, but their small size and tremendous speed imposes a strike

penalty of -3. If one missile in a volley is detonated, there is a 01-45% chance that the explosion will detonate the rest of the volley. If a character uses missiles to intercept an incoming missile volley, then there is a 01-70% chance of detonating the entire volley.

Third, regardless of how badly damaged an incoming missile may be by defensive fire, if its S.D.C. is not depleted entirely, it will inflict full damage if it hits its target. The only way to shoot down a missile is to destroy it utterly.

Fourth, attacks on a missile count as a normal attack.

Psionics

Inner Strength Points

Every use of a psionic ability temporarily expends a certain amount of psychic energy we call **Inner Strength Points (I.S.P.)**. Each specific psionic power indicates exactly how many I.S.P. are required to perform that ability. When a psionic has exhausted all of his I.S.P., he is unable to perform any more psionic feats until he acquires sufficient rest. See Step Four of Character Creation to determine if a character has psychic powers and his amount of I.S.P.

Meditation & Recovery of I.S.P.

Meditation is a skill/ability that all psychics automatically know. It is the only ability that can be done at any time and costs no I.S.P. to perform. Meditation is not so much a psionic power as it is a mental discipline that enables the psychic to concentrate deeply and focus one's abilities and thoughts. The exact techniques for meditation may vary from focusing on a mental object or notion to chanting or humming a mantra. The result, regardless of technique, is a deep relaxation, insight into one's self and becoming one with the world around him.

Meditation offers the following benefits to psionics: one hour of meditation restores six I.S.P. and is the equivalent of two hours of sleep/rest for the physical body.

Inner Strength Points can also be restored during sleep and/or total relaxation at a rate of two per hour.

Saving Throws Against Psionic Attacks

Psionic attacks which assail the mind, emotions, or physiology of a person can always be fought off through the force of one's own will and mental endurance. Psionic attacks that fall into this category include *Empathy*, *Empathic Transmission*, *Mind Wipe*, *Telepathy*, *Hypnotic Suggestion*, and *Bio-Manipulation*, among others. Some psionic attacks for which there is no saving throw include *Levitation*, *Pyrokinesis*, *Telekinesis*, *Presence Sense*, *Healing Touch*, *Force Field*, and *Mind Bolt*. However, a parry or dodge may be appropriate in some cases, like dodging a Mind Bolt or Telekinetic attack.

All saving throws are made with a D20. Non-psionic characters must roll a 15 or higher to save vs psionic attack. Major & Master Psionic characters only need to roll a 10 or higher to save. Minor Psychics need to roll a 12 or higher. **Note:** Be certain to add any possible bonuses from the M.E. attribute and/or any other sources of psychic protection.

Attacks per Melee

Psionic powers may be used as often as the psychic has melee actions/attacks per round.

Psionic Powers

There are four categories of psionic powers: *Healing*, *Physical*, *Sensitive*, and *Super Psionics*. Each of these categories offers a number of abilities that psionic characters may choose from.

Healing

Attack Disease (12 I.S.P.)
Bio-Regeneration, Self (6 I.S.P.)
Deaden Pain (4 I.S.P.)
Detect Psionics (4 I.S.P.)
Healing Touch (6 I.S.P.)
Increased Healing (10 I.S.P.)
Induce Sleep (4 I.S.P.)
Lust for Life (15 I.S.P.)
Mask I.S.P. and Psionics (7 I.S.P.)
Psychic Diagnosis (4 I.S.P.)
Psychic Purification (8 I.S.P.)
Psychic Surgery (14 I.S.P.)
Resist Fatigue (4 I.S.P.)
Suppress Fear (8 I.S.P.)

Sensitive

Clairvoyance (4 I.S.P.)
Empathy (4 I.S.P.)
Mind Block (4 I.S.P.)
Object Read (6 I.S.P.)
Presence Sense (4 I.S.P.)
See Aura (6 I.S.P.)
See the Invisible (4 I.S.P.)
Sense Evil (2 I.S.P.)
Sense Time (2 I.S.P.)
Sixth Sense (2 I.S.P.)
Speed Reading (2 I.S.P.)
Telepathy (4 I.S.P.)
Total Recall (2 I.S.P.)

Physical

Alter Aura (2 I.S.P.)
Deaden Senses (4 I.S.P.)
Death Trance (1 I.S.P.)
Float (8 I.S.P.)
Impervious to Cold (2 I.S.P.)
Impervious to Fire (4 I.S.P.)
Impervious to Poison/Toxin (4 I.S.P.)
Levitation (I.S.P. cost varies)
Mind Block (4 I.S.P.)
Nightvision (4 I.S.P.)
Resist Fatigue (4 I.S.P.)
Resist Hunger (2 I.S.P.)
Resist Thirst (6 I.S.P.)
Spontaneous Combustion (6 I.S.P.)
Telekinesis (I.S.P. cost varies)
Telekinetic Punch (6 I.S.P.)
Telekinetic Leap (8 I.S.P.)
Telekinetic Push (4 I.S.P.)
Teleport Object (10 I.S.P.)

Super Psionics

Advanced Trance State (10 I.S.P.)
Bio-Manipulation (10 I.S.P.)
Bio-Regeneration, Super (20 I.S.P.)
Cure Insanity (30 I.S.P.)
Empathic Transmission (6 I.S.P.)
Group Mind Block (22 I.S.P.)
Hypnotic Suggestion (6 I.S.P.)
Insert Memory (25 I.S.P.)
Invisible Haze (30 I.S.P.)
Mental Illusion (20 I.S.P.)
Mentally Possess Others (30 I.S.P.)
Mind Block Auto-Defense (Special I.S.P. cost)
Mind Bolt (I.S.P. cost varies)
Mind Bond (10 I.S.P.)
Mind Wipe (Special I.S.P. cost)
Pyrokinesis (I.S.P. cost varies)
Telekinesis, Super (10+ I.S.P.)
Telekinetic Force Field (30 I.S.P.)
Telemechanics (10 I.S.P.)

Healing Powers

Attack Disease: **Range:** Touch. **Duration:** Special. **I.S.P.:** 12. **Description:** The psychic can reduce the symptoms of disease in a debilitating psionic melding. The psychic touches the patient, linking himself to the sick individual, and draws part of the illness into his own body (takes 1D4 minutes of concentration). Once the sickness has been drawn into the psychic, it reduces the effects, penalties and normal duration of the disease in the sick individual by half. Likewise, the psychic also exhibits the symptoms and penalties of the disease but also at half the normal severity and his symptoms last only 1D4 hours. This power does not work against lethal and chronic diseases like cancer, tuberculosis, polio, Alzheimer's, Parkinson's Disease, multiple sclerosis, Ebola, et al.

Bio-Regeneration: **Range:** Self. **Duration:** Permanent. **I.S.P.:** 6. **Description:** The ability to mentally heal oneself of disease, poison, or physical damage. Unfortunately, this ability is limited to the healing of oneself and cannot help others. The process requires one full minute of concentration, meaning the psychic cannot use any other power during that time. Bio-regeneration does not restore missing limbs, but it does restore 2D6 Hit Points or 3D6 S.D.C., per melee round. In addition, when cuts and scrapes are healed through bio-regeneration, there is no

scarring. The psionic can regenerate as often as once every other minute.

Deaden Pain: **Range:** Immediate proximity; touch or within 3 feet (0.9 m). **Duration:** One hour per level of experience. **Length of Trance:** Two minutes (8 melee rounds). **I.S.P.:** 4. **Description:** This ability temporarily negates existing pain; effective as an anesthetic for surgery, or to enable one to keep going after being hurt badly.

Detect Psionics: **Range:** Self; sensing range is 30 feet (9 m) per level of experience. **Duration:** One minute per level of experience. **I.S.P.:** 6. **Description:** This is a mental probe that will indicate the presence of psionic energy within the immediate area. The probe can not be used to pinpoint the exact location of the psychic energy nor the level of power other than a vague sense of weak, medium or powerful. However, it will indicate whether an individual is psychic when the probe is directed at a specific person (does not reveal the type or strength of the person's powers other than low, medium or high). It will also indicate whether a group mind block is in effect or if a person is psionically possessed.

Healing Touch: **Range:** Touch. **Duration:** Permanent. **Length of Trance:** Two minutes (8 melee rounds). **I.S.P.:** 6. **Description:** The healing touch is a remarkable healing ability that can instantly heal cuts, bruises, burns, and similar wounds. The touch restores 2D4 Hit Points or 2D6 S.D.C. The healing touch can only be used on other living creatures, but never on the psychic himself (see Bio-Regeneration).

Increased Healing: **Range:** Touch or within 3 feet (0.9 m). **Duration:** 2D4 days. **Length of Trance:** 1D6 hours. **I.S.P.:** 10. **Description:** The healer is able to stimulate *another* person's healing energies, dramatically increasing one's recuperative powers. Hit Points and S.D.C. are restored at double the normal professional treatment rate.

Induce Sleep: **Range:** Touch or within 6 feet (1.8 m). **Duration:** One hour per level of experience (or until awakened). **Length of Trance:** Two minutes of preparatory meditation. **I.S.P.:** 4. **Saving Throw:** Standard, plus unwilling victims are +5 to save vs psychic attack. **Description:** This power is intended to bring relief, rest, and to help the recuperative powers of those who are ill, exhausted, or suffering from insomnia. Those affected by this power fall into a normal, restful sleep from which he or she can be easily roused. Induce Sleep cannot be used against an opponent in combat or who is presently on his feet, alert and active.

Lust for Life: **Range:** Touch. **Duration:** Three rolls vs coma recovery. **I.S.P.:** 15. **Description:** By the laying of hands, the psychic can instill a lust for life into someone who is in a coma and apparently dying. This adds a bonus of 6% per each level of the psychic's experience to the comatose character's *recovery from coma* rolls. Thus, a 2nd level psychic could add +12% to a comatose character's chance to recover from the coma.

Mask I.S.P. & Psionics: **Range:** Self. **Duration:** 10 minutes per level of experience. **I.S.P.:** 7. **Description:** This is a psionic power that enables the character to completely mask all spiritual aspects of his psionic energy and powers. Even the psychic's aura is temporarily altered. As a result, other psychics will not detect psionics in a character who is masked. However, the masked psychic must "block" himself from the world, which means he cannot use any of his psychic senses or abilities, nor receive any empathic or telepathic impressions until he lets the mask go.

Psychic Diagnosis: **Range:** Touch or within 3 feet (0.9 m). **Duration:** Immediate knowledge. **Length of Trance:** 2D4 melees of meditation. **I.S.P.:** 4. **Saving Throw:** None. **Description:** The psychic healer can sense physical pain, external and internal injury, disease and possession with absolute clarity. This pinpoint accuracy enables the character to suggest treatment or to conduct psychic surgery.

Psychic Purification: **Range:** Touch. **Duration:** Immediate. **Length of Trance:** 6D6 minutes of meditation. **I.S.P.:** 8. **Saving Throw:** None. **Description:** The healer can use his abilities to destroy chemicals, drugs, poisons, and toxins in the body. The effects of the

toxins are immediately halted at the beginning of the trance, and are entirely destroyed by the end of it. Damage sustained prior to the psychic's intervention still exists.

Psychic Surgery: **Range:** Touch. **Duration:** Varies with injury. **Length of Trance:** 2D6 minutes of preparatory meditation, plus the duration of the surgery, which is half the time of conventional modern medicine; as is the recovery time of the patient. **I.S.P.:** 14. **Description:** Psychic surgery is used to repair broken bones and internal injuries, the removal of foreign objects (e.g., bullets, shrapnel), or when a character has lapsed into a coma (at zero or less Hit Points, but not yet dead). This power grants a 01-66% chance of reviving a person from a coma. Psychic surgery leaves no scarring and minimal pain (or none if the Deaden Pain ability is also used). The psychic needs no tools to use this ability, merely the laying of hands. **Note:** A Psychic Diagnosis must be made before surgery is possible.

Resist Fatigue: **Range:** Self. **Duration:** One hour plus 20 minutes per level of experience. **Length of Trance:** 1D6 melees of preparatory meditation. **I.S.P.:** 4. **Description:** A mind over matter discipline which enables the character to engage in physical activity without suffering from exhaustion. Although fatigue is temporarily suspended, the psychic will feel extremely tired and may even collapse when the psi-power's time limit elapses.

Suppress Fear: **Range:** Self or others by touch. **Duration:** One minute per level of experience. **I.S.P.:** 8. **Saving Throw:** None. **Description:** This power temporarily suppresses the chemical and psychological components of fear in the subject. As a result, the character is unable to feel the emotion, even if intellectually he realizes he is in danger or faces a terrifying situation. This enables the character to take perfectly rational actions rather than respond when the typical "fight or flight" response kicks in. While this power is activated, the character automatically succeeds any checks to resist Horror Factor.

Physical Psionic Powers

Alter Aura: **Range:** Self. **Duration:** One hour per level of experience. **I.S.P.:** 2. **Saving Throw:** None. **Description:** This power enables the psychic to manipulate his physical energy in such a way that it changes his aura. The altered aura will send the wrong message to any psychic reading the individual's aura. Alterations include making the general level of experience seem 1-2 levels lower or 2D4 levels higher than it really is, and concealing fatigue, sickness or injury (seems fit and healthy).

Deaden Senses: **Range:** 160 feet (48.8 m); line of sight. **Duration:** 2D6 minutes; roll for random determination of duration. **I.S.P.:** 4. **Saving Throw:** -1 to save. **Description:** The psychic is able to induce a physical influence on a single person to make him or her less alert. This is typically used on guards, sentries and searchers to escape their notice. The victim of this psionic attack momentarily becomes less alert and attentive to the things around him, usually unaware that he is under psionic attack. Small sounds, odors, movements, and details go unnoticed (+10 to the following skills against this befuddled character: Camouflage, Prowl, Palming, Pick Pockets, Cardsharp, Forgery and Disguise). The deadened character also is slow to react; reduce Spd by 10%, -1 on initiative, and -5% on skill performance.

Death Trance: **Range:** Self. **Duration:** As long as the psychic senses he must feign death, up to a maximum of four days. **I.S.P.:** 1. **Description:** A state of mind over matter that slows the metabolism to such a degree that it creates a temporary state of suspended animation, simulating death. Even a medical doctor has a 01-89% chance of being fooled. The effects of drugs, toxins and chemicals are slowed to a crawl, doing no damage or effect, but will take full effect the instant the death trance is stopped (unless treatment is administered first). While in the death trance, the psychic can not be roused nor respond to any stimulation, including psychic probes. This means he is incapable of attacking or defending himself in any way until the trance is broken.

Float: **Range:** Self. **Duration:** 2 hours. **I.S.P.:** 8. **Saving Throw:** None. **Description:** This ability creates a mild telekinetic field which

enables the psionic to float on water or one foot of air per level of experience. Using this ability, the character can sit or lay comfortably above the ground, as if on a cushion of air. Float can also be used to break a fall by slowing the rate of descent until the character is gently hovering over the ground. Roll D20 to roll with fall/impact; a successful roll means no damage while a failed roll means half damage. Counts as two melee actions.

Impervious to Cold: **Range:** Self. **Duration:** 20 minutes per level of experience. **Length of Trance:** 1D4 melees for preparatory meditation. **I.S.P.:** 2. **Description:** A mind over matter discipline which enables the character to suffer absolutely no harm or discomfort from exposure to extreme, freezing cold.

Impervious to Fire: **Range:** Self. **Duration:** 3 minutes per level of experience. **Length of Trance:** 2D4 melees for preparatory meditation. **I.S.P.:** 4. **Description:** Another mind over matter discipline enabling the psychic to endure intense heat, fire, boiling water, hot coals, and so on, without suffering pain, damage or scarring.

Impervious to Poison/Toxin: **Range:** Self. **Duration:** 2 minutes (8 melees). **I.S.P.:** 4. **Description:** The character can negate the full effects of poisons and toxic chemicals which he has ingested or introduced to his bloodstream, as long as he has advance knowledge of the substance's deadly qualities. A poison, toxin or drug which has been unknowingly ingested (and starting to take effect) can be negated too, but will do half damage before it can be negated. **Bonuses:** Identify Poisons: 30% +4% per level of experience, +2 to save vs poisons/drugs.

Levitation: **Range:** Up to 60 feet (18.3 m) away. **Duration:** 2 minutes per level of experience. **I.S.P.:** **Small** (2 lbs/0.9 kg or less): 2; **Medium** (3-20 lbs/1.4 to 9.1 kg): 6; **Large** (over 20 lbs/9.1 kg): 6 plus another 6 per every 10 pounds (4.5 kg) of additional weight. **Saving Throw:** None. **Description:** Levitation is a limited form of telekinesis that can raise an object (or a person) straight up into the air and suspend it there. Maximum height for small and medium objects is six feet (1.8 m) plus one foot (0.3 m) per level of experience. Maximum height for large objects is four feet (1.2 m) plus one foot (0.3 m) per level of experience.

Mind Block: **Range:** Self. **Duration:** 10 minutes per level of experience. **I.S.P.:** 4. **Description:** This is the ability to completely close or block oneself from all psychic/mental emanations. When intentionally closed to psychic forces, the character cannot sense anything and can not be influenced by others. A Mind Block will prevent Telepathy, Empathy, Hypnotic Suggestion and Empathic Transfer. It also adds +1 to save vs psionic attacks.

Nightvision: **Range:** Self; visual range about 600 feet (183 m). **Duration:** 10 minutes per level of experience. **I.S.P.:** 4. **Description:** This ability boosts the character's ability to pick up ambient light, allowing him to see in near-total darkness. **Note:** If suddenly exposed to bright light, the psychic will be temporarily blinded for 3D4 melee rounds.

Resist Fatigue: This power is identical to the Healing power of the same name.

Resist Hunger: **Range:** Self. **Duration:** 6 hours. **I.S.P.:** 2. **Description:** Another mind over matter discipline that allows the character to function at full effectiveness, despite his lack of nourishment. The character still loses weight, however, as much as 3 pounds (1.4 kg) a day. A psychic can only hold out like this for 60 days, maximum. On the 61st day, the character will lapse into a coma. Under this extreme condition, having been active all this time, the character will be at -20% to save vs coma/death.

Resist Thirst: **Range:** Self. **Duration:** 6 hours. **I.S.P.:** 6. **Description:** The same basic ability as Resist Hunger, except it applies to the consumption of water. It does not negate the long-range damage from dehydration and can cause a coma after 20 days of dehydration.

Spontaneous Combustion: **Range:** Touch or 10 feet (3 m) and must be in the line of sight. **Duration:** Instant. **I.S.P.:** 6. **Saving Throw:** None. **Description:** The psychic can cause combustible mate-

rial to spark and ignite. This is like holding a match or lighter to material; it does *not* instantly conjure a roaring fire. It works best on dry wood, paper, oil-soaked rags, hot coals, etc. It cannot be used to set a person's hair, clothes, etc., on fire.

Telekinesis: **Range:** 60 feet (18.3 m). **Duration:** 2 minutes per level of experience. **I.S.P.:** Small (Under 2 lbs/0.9 kg): 3; Medium (3-20 lbs/1.4 to 9.1 kg): 8; Large (over 20 lbs/9.1 kg): 8 +1 per every 10 lbs (4.5 kg) of additional weight. **Description:** This is the ability to move objects by using mental energy alone. In order to move an object by telekinesis, the item must be clearly visible, within the psychic's range, and be the point of his focus. The psychic must concentrate on what he's doing, so each telekinetic feat is considered a single melee attack or action. The total number of telekinetic actions available per round is equal to the character's number of hand to hand attacks. However, a character can only manipulate one object at a time.

Combat Bonuses for Telekinetic Attacks: +3 to strike with telekinesis; physical/skill bonuses do not count towards a telekinetic strike, however. +4 to parry with telekinesis, by using a controlled object to parry or by employing sheer telekinetic force to block an attack. Counts as a medium heavy object; costs 8 I.S.P.

Damage From Telekinetically Hurlled Objects: Very Small (Under 1 lb/0.45 kg; baseball size): 1D4. Small: (1-2 lbs/0.5 to 0.9 kg): 1D6. Moderate (3-4 lbs/1.4 to 1.8 kg): 2D4. Medium (5-10 lbs/2.3 to 4.5 kg): 3D4. Large (11-25 lbs/4.8 to 11.3 kg): 3D6. Very Large (26-40 lbs/11.7 to 18.1 kg): 4D6. Add 1D6 for each additional 20 lbs (9 kg) of weight. Note: Telekinesis is not a force field, and thus, while it can be used to parry a punch, kick, club, knife or other melee weapon, it cannot stop projectiles, gas/fumes, and similar attacks.

Telekinetic Punch: **Range:** By touch or one foot (0.3 m) per level of experience. **Duration:** Instant. **I.S.P.:** 6. **Saving Throw:** None. **Description:** This enables the psychic to deliver a powerful force through telekinetic energy that feels like a punch or a kick. A telekinetic punch inflicts 4D6+P.S. bonus, while a telekinetic kick does 5D6+P.S. bonus. The I.S.P. for the power is spent regardless whether or not the character actually hits his target. This attack *can* be parried. Whenever the psychic uses this power, he must make a saving throw of 14 or higher. Failure means he has wrenched his muscles or hurt a joint and takes 1D6 damage.

Telekinetic Leap: **Range:** Self — leaping range is increased by 3 or 5 feet (0.9 or 1.5 m) per level of experience. **Duration:** One melee action/attack (leap). **I.S.P.:** 8. **Saving Throw:** None. **Description:** This telekinetic application boosts the person's leaping ability, propelling the psychic an additional 3 feet (0.9 m) for high jumps and 5 feet (1.5 m) for long jumps per level of experience. This power can be used in conjunction with a leap kick (damage: 6D6+6 plus P.S. bonuses), but the character will take 2D6 points of damage himself from the hard impact. An Acrobatics or Gymnastics roll, or a roll with punch, fall or impact, may be needed to land safely after one of these leaps.

Telekinetic Push: **Range:** By touch or one foot (0.3 m) per level of experience. **Duration:** Instant. **I.S.P.:** 4. **Saving Throw:** None. **Description:** The psychic can effectively create a telekinetic force that pushes away an attacker or anything within range (a door, chair, statue, etc.). The pushing force has the rough equivalent of a P.S. 16, +1 per level of the psychic. The telekinetic push is roughly equal to a body block and does 1D4 damage and will knock most ordinary humans back two yards/meters and has a 01-60% chance of knocking the person off his feet, so that character loses initiative and one melee action. Characters weighing more than 200 lbs. (90 kg) or who possess enhanced or supernatural P.S. are shoved back only a foot or two, and have only a 01-12% change of being knocked off their feet. Inanimate objects weighing under 50 lbs. (22.6 kg) are "pushed" or slid along the ground for roughly four yards/meters.

Teleport Object: **Range:** Touch. **Duration:** Immediate. **I.S.P.:** 10. **Saving Throw:** None. **Description:** This is the ability to cause physical matter to disappear and reappear at a different location. Such tele-

portation is limited by the level of the psychic. A psionic character can teleport one pound (0.45 kg) per level of experience a maximum distance of 50 feet (15.2 m) per level of experience. This is a one-way teleportation; once sent, the psychic cannot call the object back.

Notes:

One: Teleporting small objects to any place in one's clothes (i.e., purse, sack, backpack, saddlebags) is automatically successful.

Two: Teleporting it into somebody else's pocket, sack, etc., who is within clear line of sight has an 01-80% chance of success. If in a thick crowd, there is a -20% penalty. A failed roll means the item could have been teleported onto somebody else's person! Three: Teleporting the object to any open location that the psychic can see clearly has a 01-88% chance of success.

Four: Likewise, teleporting an object to a location well-known to the psychic also has a 01-88% chance of success.

Five: Teleporting an object to an unfamiliar place (the psychic has been there only a few times and/or has not paid close attention to it) only has a 01-60% chance of success.

Six: Teleporting the object to a completely unknown place has a 01-45% chance of success.

Seven: A failed success roll generally means the psychic has no idea of where the object went. It could be anywhere within the character's range.

Sensitive Powers

Clairvoyance: **Range:** Self; although the image could pertain to people or places thousands of miles away. **Duration:** 6D6 melee rounds. **I.S.P.:** 4. **Base Skill:** 58% +2% per level of experience. **Description:** Clairvoyance enables the psychic to see or feel glimpses of the possible future. This is achieved through meditation or intense concentration in which the psychic thinks about a particular person, event or place. Add +5% to the base skill if the person involved is a friend or loved one. Clairvoyance is unpredictable and cannot be turned on and off like a light bulb. Sometimes it works and sometimes it does not. A failed base skill roll means the psychic receives no insight to the future, despite his expenditure of I.S.P. A clairvoyant trance can be attempted as often as *twice every day*. The message can be a sudden feeling that somebody is in need ("Something's wrong. It's ... it's ... Maryann! I think she's in trouble!"). Or more often, it is a sudden flash of insight that races through the mind. The image is like a brief snippet of footage of the future, or a dream. Often, all the details are not clear, but the potential danger is. **For example:** The psychic character is in a trance or meditation, thinking about his friend Maryann. Suddenly his mind is flooded with an image of Maryann rushing down a crowded street in Peru. It's twilight. She seems very upset. Maryann races into the street, ignoring the traffic. There's a gang of evil-looking thugs nearby, perhaps pursuing her. There is a squeal of car brakes just as Maryann enters the street, and the image ends, Is Maryann hurt? Killed? Unknown, but the danger is clear. There are other hints of information: the time of day, Maryann upset and running, etc. The glimpse into the future can be 20 minutes, eight hours, three days, a week or more into the future; the psychic has no way of knowing. Of course, he has the advantage of recognizing the potential danger as it unfolds and may be able to avoid it, stop it, or change the outcome. It is important to note that sometimes a clairvoyant image will occur unintentionally, without the psychic trying. These most often manifest themselves as dreams or nightmares during sleep. The precognitive flash of the future may also occur unbeckoned while awake, but this is extremely rare. These brief glimpses of the possible future happen because the clairvoyant is acutely attuned to his world. Anything that might hurt or change that world (including people and places) will often be foretold in a flash of insight. **Game Masters:** Be careful not to reveal too much. Use the examples provided as a guide. Remember, these are only brief glimpses of a possible future. The psychic cannot engage in any actions, combat or otherwise, during a moment of clairvoyance, or the image will in-



stantly stop. It usually requires 2D4 melee rounds of concentration or meditation before the image occurs. Remember, a failed skill roll means absolutely nothing happens, but the psychic still uses I.S.P.

Empathy: **Range:** 100 foot area (30.5 m). **Duration:** Two minutes (8 melees) per level of experience. **I.S.P.:** 4. **Saving Throw:** Standard; a save vs empathy means the psychic cannot get a clear sense of the emotions of that particular person. To save vs empathy, the person must roll once per melee round while the psychic is using this power. **Mind Block** will prevent any empathic emanations from the blocked person. **Description:** Empathy is a psi-ability that makes the psychic aware of the emotions of other people and animals. The strongest emotions are easiest to sense: hate, anger, terror, love, etc. Probing for emotions can often be used to establish that somebody or something is nearby, but cannot be used to pinpoint an invisible or hiding person/creature. Questioning a person while using empathy can be very handy in establishing how they are reacting to you. In a limited sense, empathy can be used like a lie detector to see if emotions match a verbal response. Also, remember that although the empathic psychic is feeling the person's real emotions, he is interpreting their significance. A very nervous person may always radiate fear or anxiety, while a cold-blooded killer may always radiate pure calm.

Mind Block: This power is identical to the Physical power of the same name.

Object Read: **Range:** Touch. **Duration:** Varies; usually 2D6 minutes. **I.S.P.:** 6. **Saving Throw:** None. **Base Skill:** **Impressions:** 56% +2% per level of experience. **Images:** 48% +2% per level. **Present:** 38% +2% per level of experience. **Description:** Also known as "psychometry," this uncanny ability enables the psychic to receive impressions and images from an object regarding its use, history and last owner. This is done by holding the object and concentrating on a spe-

cific line of thought, or by opening up to a general impression (the latter is always more vague and random). Just as a psychic must open himself to sense evil, he must open himself to an object. If successful, he will receive impressions and/or images revealing bits of information.

Impressions include: General alignment and emotional state of mind of its last owner, the object's general purpose and whether the last owner is living or dead.

Images: The psychic can also see images of isolated events which have happened in the past. This will provide glimpses of the previous owner and others close to him. Traumatic and emotion-filled events are the easiest to see. Impressions will accompany the images, adding to the story as it unfolds, such as the previous owner's physical characteristics, occupation, and the events that led to the previous owner's loss of the item being read. Often, event images are fragmented and jumpy, like a movie clip edited by a madman. The event will always be one in which the item was involved.

The present can also be glimpsed, but costs an additional 4 I.S.P., with no guarantee of success. Sometimes the psychic can focus in to see and feel the last owner at that very moment. This will provide an idea of what is his current state of mind/emotion, appearance/dress, general location, general features, etc. The psychic may be able to identify a place or person by its features, provided he has seen it before or sees it in the near future.

The success or failure of Object Read: Failing the Base Skill roll means that the psychic learns nothing but still expends I.S.P. Also, reading impressions and images are two different things; roll for each. The psychic may get no impressions but see images, and vice versa. The present cannot be seen unless the psychic was successful on at least one of the previous readings of impressions or images. Once an object has been read it cannot be read again by the same psychic, even

if he did not see or feel a thing. Of course, the psychic can attempt to object read other items, but each attempt will cost 6 I.S.P.

Presence Sense: **Range:** 120 foot (36.6 m) diameter. **Duration:** 2 minutes (8 melees) per level of experience. **I.S.P.:** 4. **Saving Throw:** None. **Description:** This is a sixth sense which will alert the character to the presence of inhuman creatures (i.e., Bugs and Splicers) in the area. The ability cannot pinpoint the location of the presence but will give the psychic the impression of whether it is near (within 50 ft/15.2 m) or far (beyond 90 ft/27.4 m). It will also give the character a vague idea of how many presences there are. The psychic will also be able to tell if any of these presences are extremely powerful (such as a Lighting Bug).

The psychic can sense the presence of normal humans and animals, too, but with much less accuracy. Typically, the sensation is one of "We are not alone." The person's distance is undeterminable and the number of people is limited to a sense of one, two or many (and that is only right 50% of the time).

See Aura: **Range:** 60 feet (18.3 m) and must be visible. **Duration:** 2 melees (30 seconds). **I.S.P.:** 6. **Saving Throw:** None, but a Mind Block will hide the presence of psychic abilities. **Description:** All things, organic and inorganic, have an aura. The aura has many distinctions and can be used to see or sense things invisible to the human eye.

Seeing an aura will indicate the following: General level of experience — low (1-3), medium (4-7) or high (8+), as well as the presence of psychic abilities, general state of health, presence of a possessing entity (Note: Silkworms count in this regard, even though the original personality of the host body is no longer there), and any presence of an unusual aberration which includes a serious illness, non-human, mutant, or supernatural being in disguise, but does not identify which.

See the Invisible: **Range:** 120 feet (36.6 m). **Duration:** One minute per level of experience. **I.S.P.:** 4. **Saving Throw:** None. **Description:** The character can see that which is invisible, namely psychics using the Invisible Haze ability. This ability can also be used to detect those with chameleon powers, such as Assassin Bugs and certain NORAD Splicers.

Sense Evil: **Range:** 140 foot (42.7 m) radius. **Duration:** Two minutes (8 melees) per level of experience. **I.S.P.:** 2. **Saving Throw:** None. **Description:** A psychic with this power will automatically detect any supernatural evil forces (i.e., Bugs, evil psychics) without spending a single I.S.P. However, to get a clearer picture of the evil force(s), the character must open himself and use the Sense Evil ability. This power indicates the general number of supernatural evil individuals within range. It also registers the intensity of the evil and pinpoints their general location(s). It can also indicate distance, i.e., very near (within 15 ft/4.6 m), near (within 50 ft/15.2 m), or far (60 to 140 ft/18.3 to 42.7 m). The character can track the source of the supernatural evil, like a bloodhound, sensing how close it is to him. The stronger the sensation, the closer the creature. Evil emanations from humans are much less distinct than those coming from Bugs, and cannot be felt unless the source/person has an immediately evil intention or possesses psychic powers (which magnifies the evil aura). A Mind Block will prevent sensing an evil alignment and mask evil intentions.

Sense Time: **Range:** Self. **Duration:** 15 minutes per level of experience. **I.S.P.:** 2. **Description:** The psychic is able to accurately measure the passage of time, down to within 1D4 seconds. This can be useful when in an environment where the passage of time can be lost, and especially when the character must meet with someone or do something at a precise moment in time, like gauging exactly when a bomb will detonate, when a switch must be flipped, etc.

Sixth Sense: **Range:** 90 feet (27.4 m). **Duration:** Until the danger passes or happens. **I.S.P.:** 2. **Saving Throw:** None. **Description:** This power gives the psychic a precognitive flash of imminent danger to himself or somebody near him (within 90 ft/27.4 m). The character will not know what the danger is or where it will come from, nor who it will be directed at within a group. All he will know is that something like

threatening will happen within the next 60 seconds (4 melees)! Sixth Sense is triggered *automatically*, without the consent of the psychic, and is only triggered by an unexpected, life-threatening event which has already gone into motion and is about to happen. Sixth Sense cannot be called upon at will to sense traps or an ambush. Instead, it works like an automatic reflex. If the character has used all of his I.S.P., then this power is temporarily rendered inoperative. This power confers the following bonuses to the psychic during the first melee round when the attack or danger occurs: +6 to initiative roll, +2 to parry, +3 to dodge, and the character cannot be surprised by a sneak attack from behind.

Speed Reading: **Range:** Self. **Duration:** Three minutes per level of experience. **I.S.P.:** 2. **Description:** This is the ability to read and comprehend the written word extremely quickly. Reading speed is 30 pages per minute. The psychic will retain the information as he would normally. Highly technical texts will reduce the speed reading by half (15 pages per minute) and may require two readings. The character must be literate to use this power.

Telepathy: **Range:** Read surface thoughts up to 60 feet (18.3 m) away or two-way telepathic communication up to a distance of 140 feet (42.7 m). **Duration:** Two minutes per level of experience. **I.S.P.:** 4. **Saving Throw:** Conditional. When a person suspects that he is being telepathically probed, he can resist. For that, he gets a normal saving throw versus psionic attack. Mind Blocks will completely prevent telepathic probes or communications as long as the block is up. **Description:** Telepathy allows the psychic to eavesdrop on what a person is thinking at that moment. This is done by focusing on that one person and picking up his surface thoughts, those thoughts and musings that are uppermost in the person's mind. A deep probe into memory is not possible. Although the psychic can read the thoughts of several people, he can only do so by focusing on one person at a time. Simultaneous, multiple mind readings are impossible. Limited telepathic communication is also possible. The telepath can send a directed message to one person at a time. The message must be as brief and clear as possible, like "Kevin, come here! Hurry!" or "Stop! Don't do that!" Two-way telepathic communication is impossible except between two psychics who both have this power.

Total Recall: **Range:** Self. **Duration:** Permanent. **I.S.P.:** 2. **Description:** The character remembers every word he reads or hears, or everything he sees. Specific blocks of information can be recalled in perfect detail at will. Each block of information (such as a book the psychic read, a speech he attended, a program he viewed, the layout of a cockpit, operating instructions for equipment, etc.) costs 2 I.S.P. to recall in absolute detail.

Super Psionic Powers

Advanced Trance State: **Range:** Self. **Duration:** Up to 8 hours per level of experience. **I.S.P.:** 10. **Saving Throw:** None. **Description:** This meditative state puts the psychic into a deep trance in which he can heal at double the normal rate and recover 12 I.S.P. per hour. While in the advanced trance state, the psychic actually hovers in mid-air, in either a sitting or prone position. Alternately, the psychic can put himself in a state of suspended animation or "stasis sleep" in which the character's metabolism slows to a crawl. In this state, the character appears comatose or even dead; he does not need to eat or drink, and he can survive on one-tenth the normal amount of breathable air. The effects of any drugs, toxins or poisons in the character's system stops; if the psychic stays in stasis for two days or more, the pathogens are fully neutralized; if not, then they resume effect the moment the psychic reanimates. Furthermore, while in this state, the psychic can sense danger and extreme changes around him, and can wake up in an instant to defend himself.

Bio-Manipulation: **Range:** 160 feet (48.8 m). **Duration:** 4D4 minutes (16-64 melee rounds). **I.S.P.:** 10. **Saving Throw:** Standard for humans and animals; Bugs have a +3 to save vs this power due to their alien physiology, something with which most psychics are unfamiliar. **Description:** The psychic is able to induce physical trauma to the ner-

vous system of others (including Bugs) by sheer force of will and psychic energy. This psi-power is often referred to as the "evil eye." There are seven types of bio-manipulation effects. Each affects only one person per attack and can be used in any combination. Intended victims must be within the line of vision or their exact location known to the psychic. Each costs 10 I.S.P. to inflict. The duration of these effects can be extended another 4D4 minutes for an additional expenditure of 6 I.S.P.

Blindness: Temporarily knocks out the victim's optic nerves. Victims are -9 to strike, parry and dodge.

Deafness: Impairs the victim's eardrums, making them unable to hear anything. Victims are -6 to parry or dodge attacks from behind. In addition, the shock of suddenly becoming deaf makes them -3 to strike, parry or dodge *any* attacks, and they automatically lose the initiative while deaf.

Mute: Impairs the victim's vocal cords, making speech impossible. Victims are likely to be shocked and panicked, making them -2 to strike, parry and dodge, but only for that first melee round.

Pain: By manipulating the nerve centers, the psychic can induce terrible pain that shoots throughout the body. Victims are -6 to strike, parry and dodge, and take one point of damage directly to their Hit Points while affected.

Paralysis: Immobilizes the motor part of the brain, causing legs and arms to stop functioning. Victims are completely incapacitated for the duration!

Stun: This attack disorients and confuses its victim. Victims forfeit one attack per melee, Spd is cut in half, and all combat bonuses are reduced by -4.

Tissue Manipulation: Affects the tissues connecting nerve fibers which can cause a variety of effects. By irritating the nerve fibers, a victim will suddenly feel itchy, as if suddenly breaking out in a severe rash. Through endothermic manipulation, the victim can be made to suddenly feel cold or hot while everyone around him feels fine. Effects such as these are more annoying and frightening than physically impairing, making the victim -1 to strike, parry and dodge, and -1 to initiative.

Bio-Regeneration, Super: **Range:** Self. **Duration:** Permanent. **I.S.P.:** 20. **Saving Throw:** None. **Description:** Another bio-manipulation power that enables the psychic to direct his psionic energies to immediately heal himself. The character must concentrate for one full minute while his body simultaneously restores 4D6 Hit Points and 4D6 S.D.C., points. There is no scarring and this power may be used every minute. Hit Points and S.D.C. cannot be restored beyond the character's normal maximums.

Cure Insanity: **Range:** Others by touch. **Duration:** Special. **I.S.P.:** 30. **Saving Throw:** Special. **Description:** Most types of insanity can be cured at least temporarily. Only schizophrenia, organic retardation and insanity caused by brain damage cannot be cured with this power. Since the subject's insanity is beyond his control, he rolls to save vs psionic attack whether he wants to be cured or not, whenever this power is applied. A successful save vs psionic attack means no cure, but the 30 I.S.P. are expended anyway. If the insane character fails to save vs psionic attack, he is temporarily cured of that particular insanity. There is a 01-10% chance that the insanity will resurface; roll at the end of every week (7 days) or when the character faces a traumatic situation similar to the one that caused the insanity in the first place. Once it resurfaces, the insanity stays until it is cured again in some way. Each specific insanity must be targeted and attacked individually. Thus, if a character has three phobias, the psionic must use this power three times and expend 90 I.S.P., provided the subject doesn't successfully save. The psychic can make the cure permanent by permanently spending 2D6 of his I.S.P. base.

Empathic Transmission: **Range:** 60 feet (18.2 m). **Duration:** 2D6 minutes. **I.S.P.:** 6. **Attacks Per Melee:** Equal to the individual's physical attacks per melee. **Saving Throw:** Standard. **Description:** Enables the psychic to instill a powerful emotion into another living creature. Each psychic attack/transmission can only affect one creature at a time.

Despair or Sorrow: Invokes great emotional upheaval, deep sorrow and a sense of loss. There is a 01-50% chance of the victim surrendering or leaving without a battle. Furthermore, victims are -2 to parry and dodge.

Confusion: Disorients the person so badly that he has no sense of direction, time, or of what exactly is going on. Victims are -3 to strike, parry and dodge, and lose initiative completely.

Fear: Invokes unreasoning terror. Victims are -3 to strike, parry and dodge, plus there is a 01-66% chance that those affected will turn and run.

Hate or Anger: Will prompt those affected to act rashly, charge, attack, argue violently, etc. Victims are likely (01-60%) to attack, kill, harm, or betray those they dislike; +1 to strike, -1 to parry and dodge.

Love/Peacefulness: Induces a deep feeling of serenity, dispelling anger, hatred, sorrow and so on. Hostile opponents are likely (01-60% chance) to reconsider their actions, deciding to not attack, show mercy, leave without being overtly cruel or destructive, halt a rampage, and so on. It does not, however, make its victims docile sheep. It merely curbs one's hostility.

Trust: Makes its victim believe everything the psychic tells him, but only while under empathic influence. Life threatening suggestions that go against deeply rooted fears or ideals provide an additional saving throw against the suggested action, with a bonus of +3 to save.

Group Mind Block; Range: 120 feet (36.6 m) radius. **Duration:** 10 minutes per level of experience. **I.S.P.:** 22. **Description:** The psychic can instantly erect a mental barrier or mind block to protect himself and those within range. The group mind block works just like the individual mind block power. It can be a means of protecting those around the psychic from psionic probes and mind attacks, but it can also be used to prevent outside forces (good or evil) from communicating via telepathy or empathy.

Hypnotic Suggestion; Range: 12 feet (3.6 m), plus requires eye contact. **Duration:** Varies with each circumstance and subject; rarely more than a few hours maximum. **I.S.P.:** 6. **Saving Throw:** Standard. **Description:** The power of suggestion is a psionically boosted form of simple hypnosis. The power is limited to relaxing/calming somebody down, putting a person or animal in a light sleep, helping a person to relax and focus on a particular thought (good for helping someone to remember things), and implanting subtle ideas. The implanting or "suggestion" of an idea must be subtly worked into a comment. The suggestion must be kept simple and clear, such as "You know you can trust me," or "You feel like you have a fever. Maybe you should lie down," or "Trust me, you don't want to go in there." The power of suggestion can also be made to make the victim imagine sounds and images. Those who fail their saving throw will be made to see or believe whatever image or sound the psychic suggests, such as "There's a tank on the other side of that ridge!"

Insert Memory; Range: Touch. **Duration:** Permanent. **I.S.P.:** 25. **Saving Throw:** Standard; although innocuous false memories or ones that deal with something the character wanted to know/remember may not be resisted at all (G.M./player option). **Description:** An artificial memory can be implanted into the mind of the subject. This memory is completely convincing and will affect all related actions of the victim. **For example:** The psionic could tell the victim, "Your brother was captured and tortured by the Bugs seven years ago." This would mean that the subject might now have a good reason to join the war against the Bugs. However, there is no guarantee that the subject will react in any particular way. In our example, the subject might hate his real brother, or he may still believe that it isn't worth his while to help fight the Bugs. Implants that are seemingly unimportant or not strongly defined (rumors, hearsay, etc.) are the easiest to implant in a character's mind because the memory doesn't conflict with *real* memories or the character's alignment or ethics. Things like, "We met at the armory last night," or "I heard a rumor about ...," and similar. When asked where he heard that, the character won't remember, but will react with "I know that's what I heard, and I don't want to deal with anybody like

that." Even rumors and little things can affect a character's feelings or judgement. The only chance that the victim has of detecting an artificial memory is when it conflicts with obvious reality (i.e., the character never had a brother), strong beliefs, strong emotions, or alignment. But even if the victim disbelieves the memory or realizes it is false, it still remains.

Invisible Haze: **Range:** Self. **Duration:** Six minutes. **I.S.P.:** 30. **Saving Throw:** Standard. **Description:** The psychic transmits a powerful hypnotic suggestion that telepathically tells *all* who look upon him that they cannot see him! Thus, one moment he is there, and the next second, he is gone. The character and everything on his person disappears. The victim of this psionic attack will either think he was mistaken about what he saw or realize that the character has turned invisible before his very eyes. All who see the psychic while this power is active must roll to save vs psionic attack. Those who fail will not see the character for the power's duration. The only things not fooled by this power are automated visual systems, such as cameras, electric eyes, laser security systems, thermographs, etc., because they have no mind that can be tricked psionically. Those who make a successful save vs psionic attack roll can see the character without difficulty. The psychic can use this power again the next melee round if he wants to, forcing those around him to make another save vs psionic attack. Attacks against psionically invisible foes are at -6 to strike, parry and dodge, and are also at -6 to initiative, unless the invisible character picks up a visible object.

Mental Illusion: **Range:** 90 feet (27.4 m). **Duration:** Special. **I.S.P.:** 20. **Saving Throw:** Standard. **Description:** This powerful hypnotic suggestion causes the victim to see, hear, feel and interact with an illusionary being. This being can be a horrible, attacking monster, a friend, a family member, a seductive member of the opposite sex, or anything else. Only the character affected sees this mental image, although it may, in his mind, seem to react to others around him. **For example:** A character is made to think that there is a Bug before him. As one of this character's friends approaches, the afflicted character will act as if there is a real Bug present, and will likely shout at his approaching friend to take cover, much to the puzzlement of the friend, who sees no Bug to be worried about.

Illusory beings may look at or point to other characters who are within the afflicted person's line of vision. However, it directs all its actual attacks or efforts toward the one who is afflicted. The being reacts as the character would expect it to, which may rely entirely on how *he* thinks it should act. To instill a mental illusion, the psychic must implant some basic ideas and imagery. **For example:** "Don't look now, but there's a Bug behind you!" Or, "If you don't believe me, ask your friend, for he is here now and will answer your questions." Or, "You should have heeded my warning to stay out. Now, my attack dogs will tear you to pieces!"

It is important to note that when a psychic uses this power to make a victim think he is under attack by an illusory creature or person, the monster will react and have the abilities that the victim believes that it has. This can be especially effective when implanting images of attacking Bugs, since many people have only heard horror stories about these creatures and may believe them to be far stronger than they actually are. When "fighting" imaginary opponents, have the victim conduct combat just as if it were against a real opponent, only, of course, there is no opponent there. But, the victim doesn't realize it! Any damage the imaginary creature does to the victim is not real, but the victim can't tell the difference. So, if an imaginary creature makes the character think he is down to zero Hit Points or less, the resulting shock to his brain and his heart will knock him out for 1D6 minutes. If an imaginary creature *kills* the victim (knocks him to negative Hit Points below his P.E. attribute), then not only is the victim knocked out, but he also must save vs psionics. A failed roll means the character goes into cardiac arrest, and unless resuscitated, will die from the shock. Keep in mind that a good or even selfish character is unlikely to assault another in this way.

The psychic can also use this power to make another person believe he is somebody else. The victim will react to the psychic just as if he were who he wishes to be perceived as. Thus, a villain could use this power to assume the form of a little old lady to prevent a hero from attacking him. Or he could make himself look like the hero's friend to distract him. ("What are you attacking me for? The traitor went *that way!*") This ploy is especially effective if the victim could not clearly see who the psychic was before this power kicked in. Of course, the psychic must act the part he assumes, or the victim will become suspicious that some kind of trickery is afoot.

Mentally Possess Others: **Range:** Touch. **Duration:** Five minutes per level of experience. **I.S.P.:** 30. **Description:** This power enables the psychic to take over and completely control another person. The psychic essence of the controlling mind is transferred into the body of another individual. While in the victim's body and mind, the psychic retains all his own knowledge and identity. He cannot read the mind of the person he now possesses, nor access any knowledge from the victim's memory. Only the physical body can be controlled, like a living robot, but the psychic still retains all his own skills and psionic powers. During the period that the victim is possessed, the person goes into a trance state and remembers nothing about the things that happen while he is possessed. Meanwhile, the psychic's natural body falls into a coma-like state and is vulnerable to attack unless protected by others. The possessing character can return to his own body at any time regardless of distance. When his essence leaves the body of the possessed, the victim suddenly becomes conscious again, as if suddenly being woken up.

Mind Block Auto-Defense: **Range:** Self. **Duration:** Special. **I.S.P.:** Special. **Description:** The moment the psychic is being mind probed, a personal mind block automatically snaps into place. It also alerts the psychic to the fact that he or she is being probed or attacked by empathy or telepathy. The character must consciously and willingly lower the mind shield and open himself to the psi-probes in order to receive a telepathic or empathic message. Otherwise, the automatic defense mind block will stay in effect until the probe/attack is over. The I.S.P. cost is different in that the character must permanently give up 14 I.S.P. when this power is initially selected. However, whenever this power kicks in, it will cost no I.S.P.

Mind Bolt: **Range:** 100 feet (30.5 m) per level of experience. **Duration:** Instant. **I.S.P.:** Varies. **Description:** The psychic can focus his psionic energy into a powerful bolt of mental force and hurl it at a visible target with amazing accuracy. The amount of damage the bolt inflicts depends on the amount of energy expended. Every 6 I.S.P. does 1D6 damage, so spending 12 I.S.P. does 2D6, 18 does 3D6, 24 does 4D6, and so on. The only limit to how powerful a mind bolt may be is the amount of I.S.P. the psychic cares to spend. All mind bolts are +4 to strike, but adding an additional 10 I.S.P. increases the strike bonus to +8. Of course, if the mind bolt misses its target, the psychic will still have spent his I.S.P. in making it.

Mind Bond: **Range:** Touch. **Duration:** Special. **I.S.P.:** 10. **Saving Throw:** Standard. **Description:** This creates an instant mental link between the psychic and another person. When this happens, each will learn *everything* there is to know about the other. This includes all skills, secret knowledge, fears or phobias, etc. Both individuals retain a complete memory of this knowledge for 3D4 hours. After that, the characters have only a 01-15% chance to recall any particular item. After one month, *all* memories from the other person completely disappear. **Note:** Skills and skill bonuses are also temporarily absorbed, meaning that the psychic possesses all of his victim's skills and skill bonuses. Physical attributes, S.D.C., and hand to hand combat ability, and attribute bonuses gained through physical training are *not* acquired. Mind bonding with an insane or Bugged human (one whose mind has been overwritten by a possessing Bug parasite) can permanently impair the psychic's mind. Roll on the following table:

01-40%: No Insanity.

41-80%: Phobia (usually of whatever the victim is afraid of, or of Bugs, if acquired through a Bugged human).

81-90%: Affective Disorder.

91-00%: Neurosis.

Mind Wipe: **Range:** Touch. **Duration:** Special. **I.S.P.:** Special.
Saving Throw: Standard; a successful save means the person is unaffected and still retains his memory. **Description:** To mind wipe an intelligent creature, the psychic must make physical contact, touching the victim's temples. This is done by verbal suggestion and can erase any past event, knowledge, skill, etc., the psychic desires. The process takes about three minutes to complete. The loss of memory is temporary, lasting 1D4 days for every 10 I.S.P. expended. The memory can be erased permanently if the psychic expends 50 I.S.P. at once. A psionic can also permanently wipe a mind completely blank by expending 50 I.S.P. and permanently expending 4 M.E. points. This is an extremely gruelling process for the psychic, and the permanent M.E. loss occurs even if the victim successfully saves against the mind wipe and is unaffected.

Pyrokinesis: **Range:** Varies. **Duration:** Varies. **I.S.P.:** Varies. **Description:** Pyrokinesis provides the psychic various means of manipulating and controlling fire.

1. Fire Resistance: The psychic takes half damage from all fire and heat attacks. **Range:** Self. **Duration:** 5 minutes per level of experience. **I.S.P.:** 2.

2. Spontaneous Combustion: The ability to create a spark that will ignite combustible material. (Note: Human hair should not be considered a combustible material.) This is a slow fire, starting with a tiny spark and grows at a normal rate. Initially, it is not a roaring blaze. **Range:** Can be ignited up to 30 feet (9 m) away. **Duration:** Instant combustion; the fire will last and spread until it is put out or there is nothing to burn. **I.S.P.:** 2.

3. Fuel Flame: The character can feed the fire with psychic energy, doubling it in size. Affects a 10 foot (3 m) area. **Range:** Up to 30 feet (9 m) +5 feet (+1.5 m) per level of experience. **Duration:** instant reaction. **I.S.P.:** 4.

4. Extinguish Flames: The power to instantly put out an area of fire. Affects a 15 foot (4.6 m) diameter of fire. **Range:** Up to 30 feet (9 m) +5 feet (+1.5 m) per level of experience. **Duration:** Instant reaction. **I.S.P.:** 4.

5. Create Flame: The psychic can create fire out of thin air! Can be an 8 foot (2.4 m) pillar of fire 4 feet (1.2 m) in diameter, or it can be a six foot (1.8 m) wall of fire stretching 6 feet long (1.8 m) plus 1 foot (0.3 m) per level of experience. **Damage:** 5D6 from the pillar, 6D6 from the wall, plus both have a 72% likelihood of setting any combustibles they touch on fire (including cloth, rugs, curtains, furniture, etc.). **Range:** Cast up to 30 feet (9 m) +2 feet (0.6 m) per level of experience. **Duration:** Two minutes per level of experience; longer if it sets other things on fire. **I.S.P.:** 20.

6. Fire Ball: The ability to create and hurl a fire ball from out of thin air. **Damage:** 6D6. **Range:** 30 feet (9 m) +2 feet (0.6 m) per level of experience. **Duration:** Instant. **Bonus:** +2 to strike. **I.S.P.:** 25.

7. Sense Fire: The psychic can sense or feel the presence of fire and pinpoint its exact location. **Range:** 100 foot (30.5 m) radius +10 feet (+3 m) per level of experience. **Duration:** Two minutes. **I.S.P.:** 2 per every 2 minutes.

Telekinesis, Super: **Range:** 100 feet (30.5 m) per level of experience. **Duration:** Two minutes per level of experience. **I.S.P.:** 10 to lift/move/hurl an object that weights 100 pounds (45 kg), +10 I.S.P. per each additional 100 pounds (45 kg). **Damage:** !D4x10 per 100 pounds (45 kg) of weight. **Description:** This power is basically the same as the ability described in the *Physical Category* of psionic powers, but greatly enhanced. Differences are increased range, dramatically increased weight, and damage. The character can use this power to simultaneously manipulate as many as one object per level of experience, as

long as the combined weight does not exceed the total weight capacity. Combat Bonuses are the same as the non-Super Telekinesis power.

Telekinetic Force Field: **Range:** Self or 40 feet (12.2 m) per level of experience. **Duration:** 10 minutes per level of experience. **S.D.C. of the Field:** 30 S.D.C. per level of experience. **I.S.P.:** 30. **Description:** The psychic can instantly erect a force field around himself or others in the blink of an eye. If the creation of the force field is to parry an attack, the psychic must roll a successful parry to see if he was able to create the field before the attack strikes. A successful parry means the force field beat the attacker's strike and it absorbs the damage. The force field can be made so that it only encircles its creator or as large as a 10 foot (3 m) area per level of experience. Once a field is created, the psionic can create as many others as his I.S.P. will allow. All must be in the character's line of vision. The force field(s) will remain in place until all its S.D.C. is destroyed or its creator dispels it. If the psychic is rendered unconscious or killed, the force fields instantly vanish. However, the psionic can leave the area and the force fields will remain in place until the duration time limit expires. People may be able to move around inside a force field, but the force field itself cannot be moved. The field is actually an airtight force bubble.

Telemechanics: **Range:** Touch or 5 feet (1.5 m) away. **Duration:** 10 minutes plus 2 minutes per level of experience. **I.S.P.:** 10. **Saving Throw:** None. **Description:** This ability allows the psychic to mentally communicate and understand machines. This power is a bizarre combination of object read and telepathy, except that it applies to mechanical devices only. By touching any artificial machine (this includes "Organitech" devices, which are explained in the equipment section), the psychic will instantly have a complete (although temporary) knowledge of exactly how the machine operates. That means the psychic will know the complete schematics of the device, how to conduct repairs, and all aspects of operation. The level of skill expertise is 80%. When touching an artificially intelligent machine, such as a computer, the psychic not only understands everything about its operation, repair, access codes, etc., but can actually communicate with it telepathically. This means he can tap into a computer's memory bank without using a terminal because the information is sent directly into his mind. Remember, the telepathic link and memory are temporary abilities (although using Total Recall, the psychic could call up small but important bits of info). The psychic's skill knowledge of intelligent machines through this power is 88%.



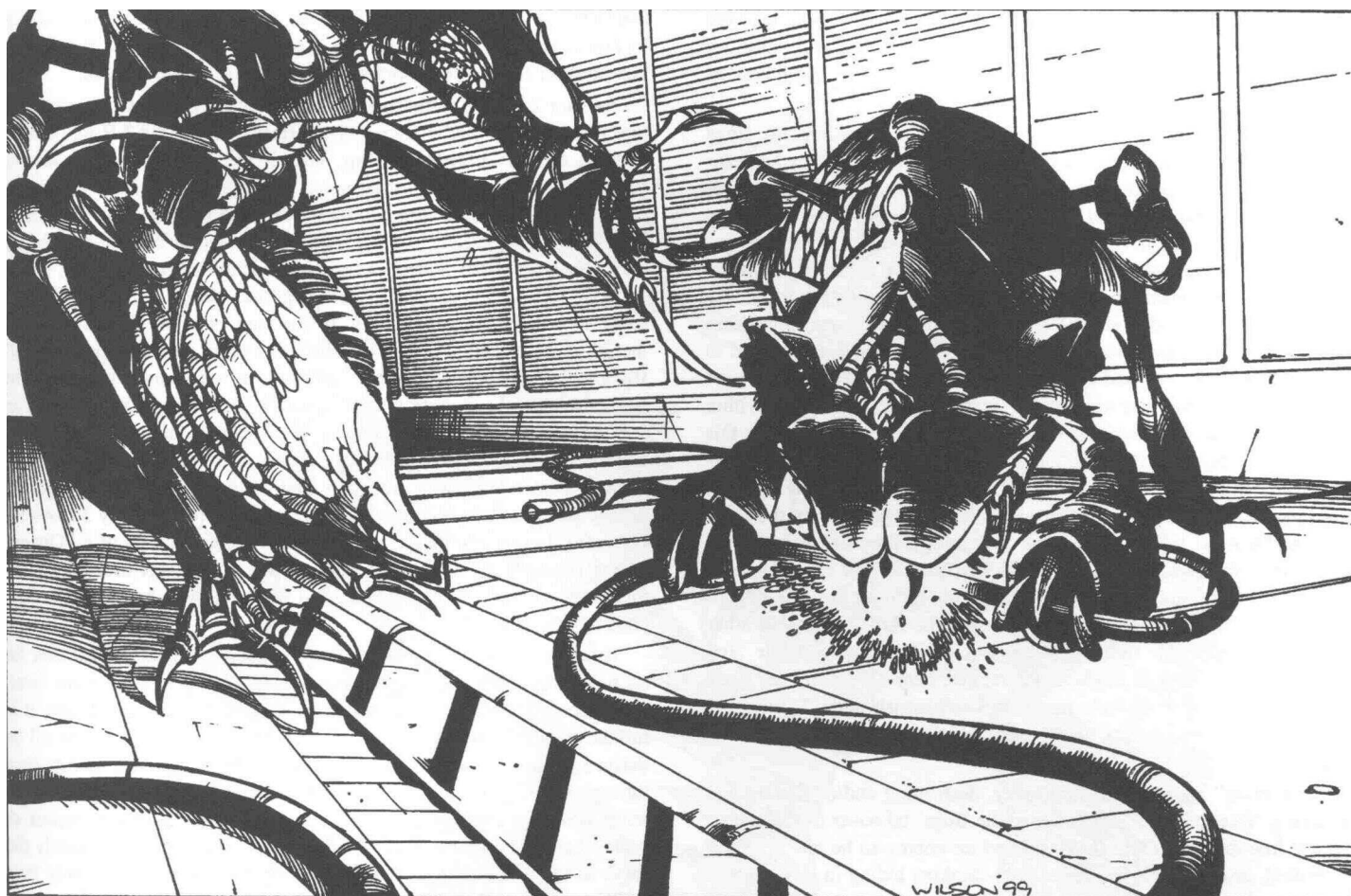

THE BUGS

By Bill Coffin & Kevin Siembieda

Little is known about these strange, alien energy beings. Their purpose, goals, desires, and dreams are as mysterious and diabolical as the creatures themselves. The only truths evident about them are that they are cold-hearted creatures with no concern for human life and that they clearly plan on enslaving the people of Earth as a long-term energy (food) source.

Essentially, these "bugs" are like intelligent, giant, evil locusts from another dimension who prey on worlds that are within a certain window of technological achievement — advanced enough that they have lots of power-generating capability, yet not so developed that they have the supertechnology to make their electronic infrastructure Bug-proof. Unfortunately for Earth, at the time of the Y2K Meltdown, Earth fit their target profile perfectly. Part of that "profile" is the inability to offer much in the way of resistance — an easy conquest.

The true horror and evil of it all is that the Bugs don't really *need* to enslave people or rape a planet to find sufficient energy to eat. They are quasi-photosynthetic, so they can get most of the energy they need to survive from sunlight and from absorbing ambient heat, electromagnetic energy and background radiation. However, devouring high-powered energy, like tapping into an electrical line or gorging in a fusion reactor, is sheer bliss for these malignant gluttons. Consequently, they travel from world to world, taking it over, sucking it dry, and moving on in order to get this food-high. When the planet has no (or little) energy to give, the fiends go off in search of a new energy source to plunder, leaving behind a spent planet with a devastated pop-

ulation. Earth is only the latest in a long, long line of worlds that the Bugs have laid to waste.

These alien invaders are called "Bugs" because they resemble giant, monstrous insects, but in reality they are not an insect life form at all, nor do they have a collective, insect consciousness or a hive mentality. They are sentient and intelligent, but largely non-technological because they are naturally equipped with the tools they need to devour pure energy, travel from dimension to dimension, and destroy all opposition.

Most impressive among their natural abilities is the power to convert their bodies into surges of pure bio-energy. It is this energy state that enables all Bugs to travel through electrical conduits and to enter electronic devices and take them over. In energy form, the Bugs can enter a "hardline" (electrical lines, telephone lines, cable lines, fiber optics, etc.) and travel at nearly the speed of light along its length. On a world like Earth, where the entire globe is covered by a rich network of electronic infrastructure, the Bugs can travel to almost any region of the planet within seconds. They also use their energy form and transmission ability to breach the dimensional wall between our world and theirs through a fluke dimensional portal that opened only for a few brief seconds. It is important to note that all adult Bugs (Silkworms are not included) have the ability to transform into energy to cruise the electronic highways, however, they cannot maintain this form for a long period. There must be an electrical line through which they can transmit themselves or they turn back *to physical* form in 1D4 seconds. While in energy form, they have no solid form and no mode of attack (although touching one will inflict 3D6 points of damage). Nor can the energy Bug move (other than hover suspended in mid-air) without an open electrical circuit/line to "hop" into and travel along.

When using their energy form to "hop" dimensions, the creatures are at something of a loss, because the majority of them do not actually know how to travel to other dimensions and worlds. They must rely on the *Lightning Bugs* (as humans call them) to coordinate and lead all

interdimensional travel. Likewise, without a Lightning Bug to lead the way, some Bugs will even get lost while traveling electrical hardlines unless it is a direct connection from one place to another (no junctions or interconnecting lines to confuse the traveler).

Despite the cunning and natural abilities of the invaders, the Bugs must still learn and adapt to the technology of the world they have invaded in order to draw upon its "man-made" energy resources. It is imperative that whatever world they invade will be able to continue to produce energy for their voracious appetites. Ultimately, this means enslaving the "native" population to maintain (if not improve upon) the energy generating infrastructure that attracted them to that world in the first place. To this end, a subspecies of Bug, the **Silkworm** (also commonly known as *Brain Grub* or simply, the *Grub* or *Worm*), is used to impregnate human host bodies and turn them into zombies to serve the other Bugs. Each Silkworm is able to impregnate one host body within its life cycle and seize control of that human body. It is through this strange union between Bug and human that the Grubs are able to operate Earth technology (through their human hosts), but they do not have any genuine knowledge of it themselves. It also explains why the Bugs don't really need to understand the technology they use to maintain their energy-food supply. The primary function of their zombie slaves is to keep power plants running and energy distribution flowing, as well as helping to protect these energy sources. The Army Ants and other Bugs do most of the fighting to defend power centers, while Bug Zombies (also known as Silkworm Zombies, Bug People or Bug Nose People, because of the telltale purple bruise/blemish under the nose of all host bodies) engage in luring out unsuspecting free-thinking humans.

"Protection" includes keeping away, destroying and/or finding and enslaving "free-thinkers" who oppose the Bugs' takeover of the planet. Even a free-thinking child is considered an enemy to be captured and controlled, or destroyed. However, free-thinkers hiding in remote, wilderness regions, where "hardlines" are few (or nonexistent) and which are reasonably far from the Bugs' main energy centers (i.e. cities and power plants), are considered a *minimal threat* and *low priority*. In fact, they are often ignored until their activities draw the attention and/or ire of the Bugs. The lazy invaders would much rather spend their time in an energy/food-induced stupor than actively hunt down "potential" threats. Their tactic is to seize control of the energy centers (cities and power plants) and defend them — thus establishing both a global network of operation and maintaining a strong holding action that gives them everything they need. Generally, whatever free-thinkers remaining at large are small, unorganized groups scattered across the countryside or scurrying around the city at night or underground like rats. Note: The Bugs vastly underestimate humankind's resilience, ingenuity and ability to adapt, regroup and work together even when scattered apart. With any hope, this will be their undoing.

The Bug Hierarchy

All Bugs, with the exception of the Silkworm, seem to begin life as an **Army Ant**. This is the primary tier of the Bug life cycle. As they get older, certain individuals discover within them a capacity for change. As they embrace this change, they are able to transform into one of the specialized **Tier 2** life forms: *Assassin Bug*, *Bombardier Beetle*, *Killer Bee*, or *Stink Bug*.

It is the **Stink Bug** that produces the curious Tier 1 sub-specie Bug known as the *Silkworm* or *Brain Grub* — a small, worm-like parasite that turns human hosts into zombie-like "Drones." It is the Silkworms who provide the frightening "interface" and control mechanism be-

tween the Bugs and their human slaves. Most *Army Ants* never make it to Tier 2, however. They either die in combat or simply lack the genetic potential for further development and physical metamorphosis.

As Tier 2 Bugs get older, a small percentage of them (regardless of type) undergo another change and transform into a **Tier 3 Bug**, or what humans call the **Lightning Bug**. This is the strongest of the known sub-species encountered by humans. Its greatest ability is to remain converted into a being of pure energy for long periods of time without having to jump directly into an electrical device or a hardline. Unlike the other Bugs, the Lightning Bug can function in energy form, attack and kill. Needless to say, this makes Lightning Bugs extremely difficult to destroy. They are presumed to be the leaders of the Bug legions, although there is some sketchy evidence that there *maybe* other "Tier 3" Bugs that either humans haven't seen yet, or which have not yet come to Earth. This also suggests there could be Tier 4 or perhaps even Tier 5 Bugs, too. Indeed, nobody knows where the initial Army Ants come from! They do *not* develop from the Silkworms, because once the Grub enters a human host, it cannot leave that body without dying (or does it simply take decades to gestate into its adult form? Nobody knows for certain). This leaves the question: Is there the equivalent of a "Queen" hiding somewhere? So far as humans know, the "progenitor(s)" of this race has not yet been discovered, and may not even be on Earth. Perhaps in time, it will be.

Another odd aspect about the Bugs is that the physical attributes for each particular sub-species — Army Ant, Killer Bee, etc. — are virtually identical. There are no variations among the species (if any, it is minuscule and virtually undetectable). This suggests they might all be derived from the same, unchanging, genetic templates, rather than through a "pool" of genetic information like most Earth organisms. In other words, it may be possible that *all* Bugs are identical copies of each other, like a vast race of identical twins or clones, each exactly the same as the one before it. If there are any variations, presumably they are discovered and destroyed in order to preserve the purity of the race. To complicate matters for humans, since Bugs exhibit little "personality" or emotion, it is difficult to say if they have independent thoughts, individual personality traits, desires or motivation.

Bugs communicate with each other by sending and receiving some kind of unique radio frequency. Human telepaths are only successful at picking up fragments of these communications 25% of the time when it is between Bugs, but they have 100% accuracy when the communication involves a "Bugged" human (i.e. someone under the control of a Grub/Silkworm). In general, the Bugs do not communicate with humans unless it is to issue an order or to entreat humanity to lay down its arms and surrender. Since the Invasion, the Bugs have gained virtually complete control over the world's communication systems, and they use them to relay information to one another, monitor "free human" activities, and intercept (and pinpoint when possible) "free human" transmissions. Most Bug broadcasting is generally used to send information to Bugged humans in the field (their slave labor and infiltrators). Periodically, Bugged humans will make "public service announcements" directed at freedom fighters who may be watching or listening, to describe how pointless their continued resistance is, and that they should surrender or go into isolation, and forget about trying to liberate their world. The Bugs are not gloating (or are they?), but merely emphasizing what they believe is the truth (at least from their perspective) — that this world is now "theirs," and that ultimately, they will control it all. Time will tell.

This is all anybody really knows about the Bugs, other than the obvious: They are a dangerous and devious enemy that will stop at nothing short of the complete subjugation of the Earth's proud and free people. They have already destroyed most nations and work to rob man of independent thought. They are intent on consuming as much of the Earth's energy as they can, for as long as they can (Decades? Centuries?), and then moving on. They care not one whit about Earth's people or the ecosystem — they are parasites after all, so they have little regard for the host (planet and people) that they are slowly eating away.

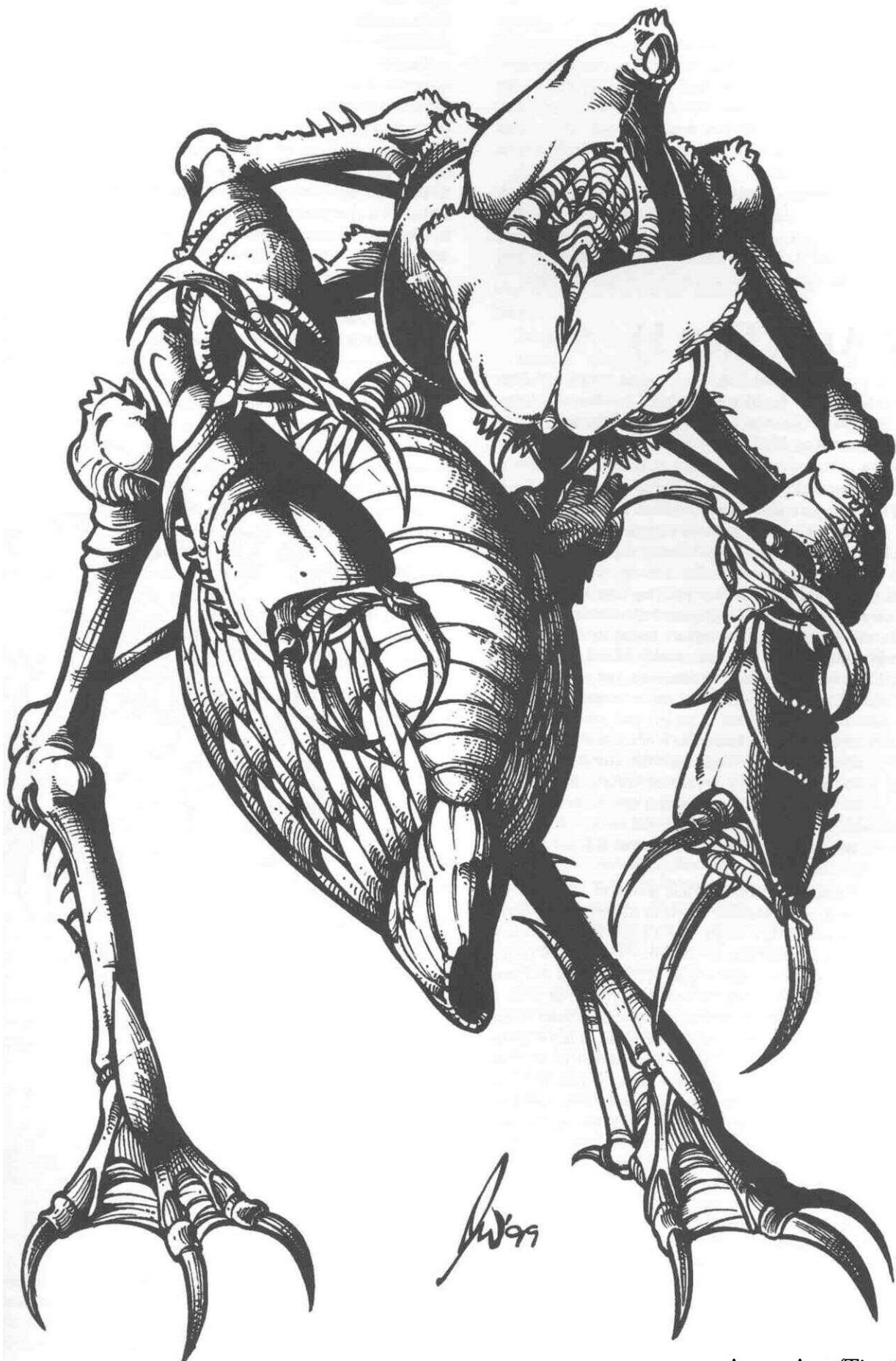

Army Ant (Tier 1)

Many free humans have speculated that the Swarm to hit Earth may not be the only one in existence. For if the Bugs came from another world or dimension to plague this one, then might it also be possible that there are thousands of Swarms infesting the infinite Megaverse? Monsters who may have been a scourge to countless worlds and peoples since the beginning of time! If so, then humanity's problems are far greater than simply reclaiming their world and rebuilding civilization as it once was. Humans will have to prepare for the next Swarm. And the next one. And the next. Until there are no more Swarms — or no more people left to fight them.

A Few Conversion Notes: In *Rifts*® and other Mega-Damage settings, Hit Points and S.D.C. should be turned into M.D.C. and the P.S. becomes *Supernatural*. Supernatural P.S. (or at least Superhuman) may also be appropriate for the *Heroes Unlimited*™ setting. The G.M. may also want to increase the number of attacks by one or two per round.

Army Ant (Tier 1)

This is the all-purpose combat Bug, the frontline troops who have spearheaded the invasion and function as the Bugs' first line of defense. Eighty percent of all of the Bugs on Earth are Army Ants, with the various Tier 2 Bugs comprising 17% and the Tier 3 Lightning Bugs making up the final 3%.

Like humans, Army Ants (and all Bugs, for that matter) are individuals capable of free thought and self-determination. They are *not* a hive organism and they do not possess a group consciousness. That said, they are very closely bound by the overwhelming urge to gorge themselves on high doses of energy, much like an army of drug addicts might be united (if chaotically so) in their unifying urge to get another fix. Army Ants are the same way. As long as they have strong leaders to help organize and direct them, they happily cooperate and work together as a finely tuned military machine capable of defeating almost any opposition. However, remove their leaders, and Army Ants quickly lose direction, suffer from indecisiveness (-2 melee attacks/actions and no bonus for initiative when without a leader) and are more easily bluffed and intimidated. Without a leader, be it of a small squad or the commander of an entire legion, the Bugs under that command become disoriented and unfocused, and lose confidence without him. In this confused state, Army Ants can be turned against one another, tricked, bluffed and intimidated into leaving the scene, and so on. This is their one critical weakness, something wily human freedom fighters use time and again to their advantage.

In general, Army Ants are coordinated into groups of 6-10, led by a single Tier 2 *Assassin Bug*, *Bombardier Beetle* or *Killer Bee*. For every 10 battle groups there usually is a single Tier 3 *Lightning Bug* leading them all. This makes for a total force of 100 Army Ants and 10 Group Leaders (110 total), although a single or pair of Tier 2 Bugs can lead such a large group. A Battle Group of this size is referred to as a "swarm." This term is also used, however, to collectively refer to the total population of Bugs that have invaded Earth. Thus, a battle group of 110 Bugs is "a" swarm while all Bugs are referred to as "The Swarm." A Bug "squad" or "patrol" is a lone Battle Group of 11, or any group of Bugs under 11 (i.e. a small squad of 3-8 Army Ants plus one leader). It is these small squads or a single Battle Group that may be led by an Elder Master Army Ant (see *Life Span* for details about the Elder).

Army Ant (Tier 1)

Alignment: Diabolic.

Attributes: I.Q. 7, M.E. 9, M.A. 13, P.S. 25, P.P. 17, P.E. 20, P.B. 5, Spd. 25 running (18 mph/29 km), but can travel thousands of miles in only a matter of a few seconds as an energy being inside a hardline.

Hit Points: 32

S.D.C.: 100

Natural A.R.: 12

Horror Factor: 10

P.P.E.: 4D6 +P.E. attribute number.

I.S.P.: 50 +M.A. attribute number.

R.C.C. Skills (or Instinctual Equivalents): Climb 85%/80%, Swim 50%, Prowl 50%, Tracking (humans/humanoids, not animals) 60%, Land Navigation 50%, and Detect Concealment 40%. Also see Natural Abilities.

Natural Army Ant Abilities:

L Bio-Energy Conversion: Army Ants can transform their bodies into a coherent pulse of concentrated bio-energy. When in this form, the Bug can enter any conventional electric or electronic interface (like an electrical socket on a wall, or the modem, disk drive, or headphone socket on a computer, etc.) and enter into the device. Army Ants use this ability to access electrical, cable or telephone hardlines so they may travel along their lengths at nearly the speed of light. Or they may enter an electrical device and control it from the inside (they especially love doing this to high-tech vehicles like jet fighters and tanks); see *Machine Union*. Once converted to bio-energy, an Army Ant *must* enter a device or hardline or it will dissipate (and die) within 1D4 melee rounds. Its only other option is to turn back into its physical form.



It takes only one melee action/attack for an Army Ant to convert into bio-energy, and another melee action to enter an electronic device or electrical hardline. It can remain in a hardline indefinitely and zip all over the place, however, the Bug quickly gets frustrated, hungry and bored so most like to exit as soon as possible.

When a hardline is used to travel to a new destination, the Bug reaches that destination within 1D4 seconds if within 5000 feet (1585 m) or one melee round (15 seconds) per 1000 miles (1600 km). It needs an outlet or receiver (open telephone line, modem, electrical outlet, etc.) to exit. Furthermore, unless there is a Tier 2 Bug to lead the way, Army Ants are likely to get lost when travelling more than 100 miles (160 km) or if there are many intersecting lines. This means Army Ants left on their own could travel hundreds, even thousands of miles out of their way and in the wrong direction in a matter of 15-30 seconds. **Note:** Multiple Army Ants can interface the same socket or hardline simultaneously. Thus, a couple to a hundred Bugs could enter or exit the same wall socket at once. This tends to make them a very difficult enemy to defend against en masse, since they can replenish their numbers almost instantly, sending waves of hundreds of Army Ants to besiege an opponent in a matter of seconds. The trick to fighting them, then, is to eliminate their leaders and divide them up so they become confused and frightened. Under these conditions, the disoriented, dim-witted monsters will scatter and think only to escape, not to regroup and work as a team, nor to call for help.

I Machine Union: The moment the Bug merges with an electronic device or machine, it instantly becomes one with it. That means it instantly understands everything about it and has complete control over it. Thus, each action of the Bug inside the machine is a response by the machine/device, because it is, temporarily, the Bug's body. Each subsequent melee action is used to control the device, so each response or action of the machine (changing channels, refusing to respond, turning off or on, displaying incomplete or erroneous information, etc.) counts as one of the Bug's melee actions/attacks. This complete mastery and union with the device lasts only as long as the Bug remains inside (only one Bug per device unless it has linked systems — i.e. a network of computers could allow one Bug in each computer, with each Bug telepathically transmitting data and coordinating their actions; or in complex machines, one Bug can control the guidance/pilot system, another the communications and/or sensor system, etc.). **Note:** As soon as the Bug leaves the machine, its union and understanding of its workings is instantly severed and lost. To use the device again, the alien must again bond with it in its energy form.

A Bug can stay inside a machine indefinitely, but most start to feel claustrophobic after 24 hours and will want to leave. Typically, most Bugs leave as soon as there is no reason to be inside the device. Bugs sometimes hide and wait in ambush by entering electronic machines.

3. Energy Attack as an Energy Being (very limited): A free floating energy-Bug can only hover or enter an electrical device, it has no other types of attacks, save one. It can launch itself as a super-powerful energy blast at one specific target, but is limited to a range of 300 feet (91.5 m) and this feat can only be performed once per transformation (not once per round, but once per transformation into energy form). !D6x10 damage is inflicted to whatever is struck (+6 to strike with this attack; includes all bonus considerations), but the Bug must immediately reassume its physical form (counts as one melee action) and loses half its attacks and initiative for the immediate next melee round, plus it can not turn back into energy form for at least ten minutes!

This energy ram or projection attack can also be used as a suicidal Kamikaze strike. Everything is basically the same as previously described, except the damage is 2D6x10+10 and the Bug is killed! Its entire life's energy is channelled into one devastating, suicidal assault. Note: Army Ants do have a sense of self-preservation, and will not resort to this suicide attack unless they feel they have no other option or are so provoked that they don't care if they die as long as they take their enemy with them.

4. Limited Invulnerability: When in pure energy form, the Bugs are invulnerable to physical harm — bullets, thrown rocks, fire, and punches pass harmlessly through them. However, explosions (and for those adopting the Bugs to other Palladium RPGs, magic and energy blasts) do one third normal damage.

While inside an electrical device, the Bug can be hurt if the containment medium it is in (e.g., the device or hardline) is destroyed. Destroying the device forces the suddenly disgorged energy Bug to jack into something else before they dissipate or to resume its physical form. It has one melee round (15 seconds) to do so. The usual loss of initiative and reduced attacks apply for the next melee round whenever a Bug goes from energy to physical form. Note: There is a 01-20% chance that the monster is instantly killed/dissipated when its containment medium is destroyed (G.M.s, roll for each such situation).

In physical form the Bug has a natural A.R. of 12, which means all attack rolls of 12 and under have no effect on the creature (do no damage).

5^ Bio-Energy Blaster (1): Ironically, this attack is possible only when the Bug is in its physical body. Army Ants can fire an energy blast from their Bio-Energy Blaster, a strange vent-like growth on their back.

Range: 1000 feet (305 m).

Damage: 5D6 from a standard blast, but can also fire a double-strength bio-energy blast for 1D6x10, but which counts as two attacks. Instead of causing physical damage with their Bio-Blaster, Army Ants can modulate their blasts for *electrical disruption*. Any electrical or electronic system hit by one of these blasts is rendered inert for 1D6 minutes, regardless of its size or complexity. Thus, a toaster, with only one electrical system in it, would be totally fritzed (won't work). A jet fighter, on the other hand, has numerous electrical systems, so only *one* of those would be knocked out per blast. Of course, if the flight controls are temporarily fritzed, then the jet is basically done for (G.M.'s choice as to what goes out, but it is best for dramatic effect to knock out two to several secondary systems before affecting something absolutely critical and life threatening — "We've lost radar ... now we've lost the radio ... damn, weapon systems are off-line. We can't take much more of this!" The same applies to elaborate computer systems or control rooms, like a command center or a nuclear reactor's monitoring and control system.

Psionics (special): All Bugs are considered Minor Psychics and can communicate with fellow members of their own race via telepathy (as well as conventional radio when they choose). I.S.P. Cost: None when communicating with other Bugs, because this is as natural for them as humans talking to one another, but standard when trying to telepathically communicate with non-Bugs. Range: 2000 feet (610 m) in physical form, double in energy form and, when part of a "hardline" they can communicate with every Bug "hooked in" on that line and any connecting lines.

The alien nature of the Bugs' brain and different wave patterns makes it difficult for human psychics to receive and understand these Bug communications. Typically, a psychic has only a 01-25% chance of successfully intercepting Bug telepathy or reading their minds (double for the Mind Mage/Mind Melter/Master Psychic of other game settings), but even then, non-Bug psychics only see and hear broken fragments of the telepathic communication. This is rather like trying to watch a television that only blinks on in short spasms with picture or sound only (rarely both) in between long periods of cracking interference and electronic snow. Furthermore, a Bug sending or receiving a telepathic transmission must be within the psychic's normal range, and even touching the alien will not improve reception. **Note:** The Bugs have the same trouble reading the thoughts and emotions of human telepaths.

The only time a human psychic can tap into a clear Bug telepathic transmission is from the Silkworm/Brain Grub inside a human host. The Grubs' physical link to their human zombies somehow serves to convert the wavelengths or brain frequencies to something that makes Bug conversations received by and transmitted from the Silkworm Zombies clear and readable by psychics with telepathy (normal conditions apply).

Other Psionic Aspects of Note: The alien nature of the Bugs and their limited psionic abilities make them less susceptible to hypnosis, most types of mind control, possession and illusions (+5 to save and half the normal duration if the Bug should fall under its influence).

Attacks Per Melee: Four physical/hand to hand attacks or four energy blasts (each blast counts as one attack).

Damage: Army Ants can stab and slash with their short-sword-like claws to inflict 3D6+13 (includes the P.S. Bonus) or strike with a closed fist or forearm to inflict 2D4 +10 with P.S. bonus. A bite does 2D4 damage.

The Army Ant can also fire a blast from its bio-energy cannon, a strange vent-like growth on the back, for 5D6 damage. Army Ants can also fire a double-strength bio-energy blast for 1D6x10, but it counts as two attacks. *See the description under Natural Abilities for full details.*

Bonuses (including attribute bonuses): +2 on initiative, +4 to strike, parry and dodge, +10 to damage, +3 to save vs poison/toxin (and magic), impervious to disease, +6 to save vs Horror Factor. **Note:** Without a leader, the Bugs are -2 melee attacks/actions, lose their initiative and H.F. bonus, and R.C.C. Skills are -15%.

Average Life Span: The exact life span for any Bug is unknown to humans. Presumably, these energy beings could live for centuries, however the aggressive, combative nature of the Army Ant and their duty as "soldiers" give them a short life expectancy; typically, 7-20 years.

The few (roughly 15-20%) that survive beyond the age of 25 often progress to the next level or "tier" of the Bugs' evolution, and turn into one of the Tier 2 Bugs. Those that do not possess the ability (or will/desire?) to make the transformation live on as increasingly cunning and deadly Army Ants (+1 to initiative, +2 to strike, parry and dodge, +1 attack per melee round, +2 to save vs Horror Factor, and +10% to R.C.C. Skills). These "Elder Masters" often serve as sergeants or lieutenants in the Bugs' army, typically leading small squads and patrols. Such Elders rarely commit suicide.

Size: 7-8 feet (2.1 to 2.4 m).

Physical Appearance: Army Ants are huge, bipedal humanoids that have a bizarre, insect-like appearance. They have a blotchy red body, and a blocky carapace (exoskeleton) with serrated spines along their limbs. Their protruding eyes are large and insect-like but smooth purple orbs mounted into a flat, wedge-like face. The mouth is a small beak with a pair of sharp pincers on the sides. Their arms are crooked and skeletal, with small, sharp spines and ending in a set of three-fingered claws that can be used either for straight-out combat or crude manipulation of objects. Although they can climb, crawl and run on all six appendages, they stand and walk on a single pair of legs ending in clawed, webbed feet. Army Ants stand hunched over, with their head and neck extending straight out from their "thorax," allowing their back-mounted bio-cannon to fire over their heads. The top and middle set of "arms" are both used as hands.

Notes: It is rumored that some survivalists have found a way to remove the carapace from slain Army Ants in order to strip and cure them, and use the plates to form a kind of organic body armor. NORAD is investigating this, but has come up with nothing conclusive so far.

Assassin Bug (Tier 2)

NORAD Eggheads believe that Assassin Bugs rank the lowest among the Tier 2 Bugs, perhaps because their specialization is not added firepower but the ability to perform stealth missions using natural camouflage. As their name suggests, they are most commonly found as an advance group reconnoitering an area or laying an ambush against free-thinking humans and militiamen. Assassin Bugs are almost never sighted in or near "Bugtowns" (power centers) or with large battle for-

mations. Rather, they often form small units of their own, using whatever Army Ants they may command as purely expendable decoys to flush out their quarry in order to better ambush them. In this regard, Assassin Bugs are truly unique, for they are the only Tier 2 Bugs known to prefer congregating amongst themselves rather than with their subordinates. It is also widely believed that Army Ants that serve Assassin Bugs are more genetically inclined to advance into an Assassin Bug formation if and when they evolve into a Tier 2 organism.

To date, NORAD Psychics and Splicers have made it a priority mission to determine if there is greater independence among Assassin Bugs, or a social rift between them and the rest of their brethren. If so, they hope to somehow use this against the Bugs. What better ally to help fight the Bugs than disenfranchised Bugs themselves? And the Assassin Bug *maybe* such a potential ally. Unfortunately for now, this is pure conjecture and wishful thinking. Still, the intelligence arms of NORAD are intensely interested in developing and exploiting this possible weakness, and they will richly reward *anybody* who can deliver solid, verifiable information regarding the feasibility of turning Assassin Bugs against their own kind.

Assassin Bug (Tier 2)

Alignment: Diabolic (or can they also be Miscreant and Anarchist?)

Attributes: I.Q. 13, M.E. 13, M.A. 15, P.S. 28, P.P. 19, P.E. 23, **P.B. 5**, Spd. 30.

Hit Points: 45

S.D.C.: 120

Natural A.R.: 13

Horror Factor: 12

P.P.E.: 4D6 + P.E. attribute number.

I.S.P.: 60 + M.E. attribute number.

R.C.C. Skills (or Instinctual Equivalents): Climb 95%/90%, Swim 50%, Prowl 60% (+30% when hiding and/or using Chameleon ability and staying still or moving very slowly), Tracking (humans/humanoids, not animals) 65%, Land Navigation 65%, Detect Ambush 60%, Detect Concealment 60%, Escape Artist 60%, and Intelligence 70%.

They are cunning hunters and skilled in the art of deception, trickery, ambush, and luring prey out of hiding. This includes the use of "live bait" — using other humans held as hostages, particularly loved ones, women and children.

Also see Natural Abilities.

Natural Abilities:

1[^] Bio-Energy Conversion: Identical to the Army Ant ability.

2. Machine Union: Identical to the Army Ant ability.

3. Energy Attack as an Energy Being: Identical to the Army Ant ability. These independent hunters and secondary leaders rarely use the suicide energy attack except in the most dire of circumstances.

4. Limited Invulnerability: Identical to the Army Ant ability. 5. Bio-Energy Blasters (4): Fundamentally the same as the Army Ant ability, but see the second paragraph under *Damage* for different use and number of attacks.

6. Chameleon: This ability enables the Assassin Bug to change color and texture in order to blend into his environment. A kind of bio-aure surrounds the creature so even any body covering and personal equipment changes to blend in with the Bug and its surroundings.

Movement destroys the effectiveness of the chameleon ability. Chances of remaining unseen are 90% if the Bug remains completely still, 70% if moving two feet (0.6 m) per melee round or less, 20% if moving six feet (1.8 m) per melee round or less, and totally ineffective if moving any faster than that.

Magic: None.

Psionics: Identical to the Army Ant's abilities.

Attacks Per Melee: Five physical/hand to hand attacks or five energy attacks (each single or double blast counts as one attack).

Damage: Assassin Bugs can stab and slash with their short-sword-like claws to inflict 3D6+16 (includes the P.S. Bonus) or strike with a

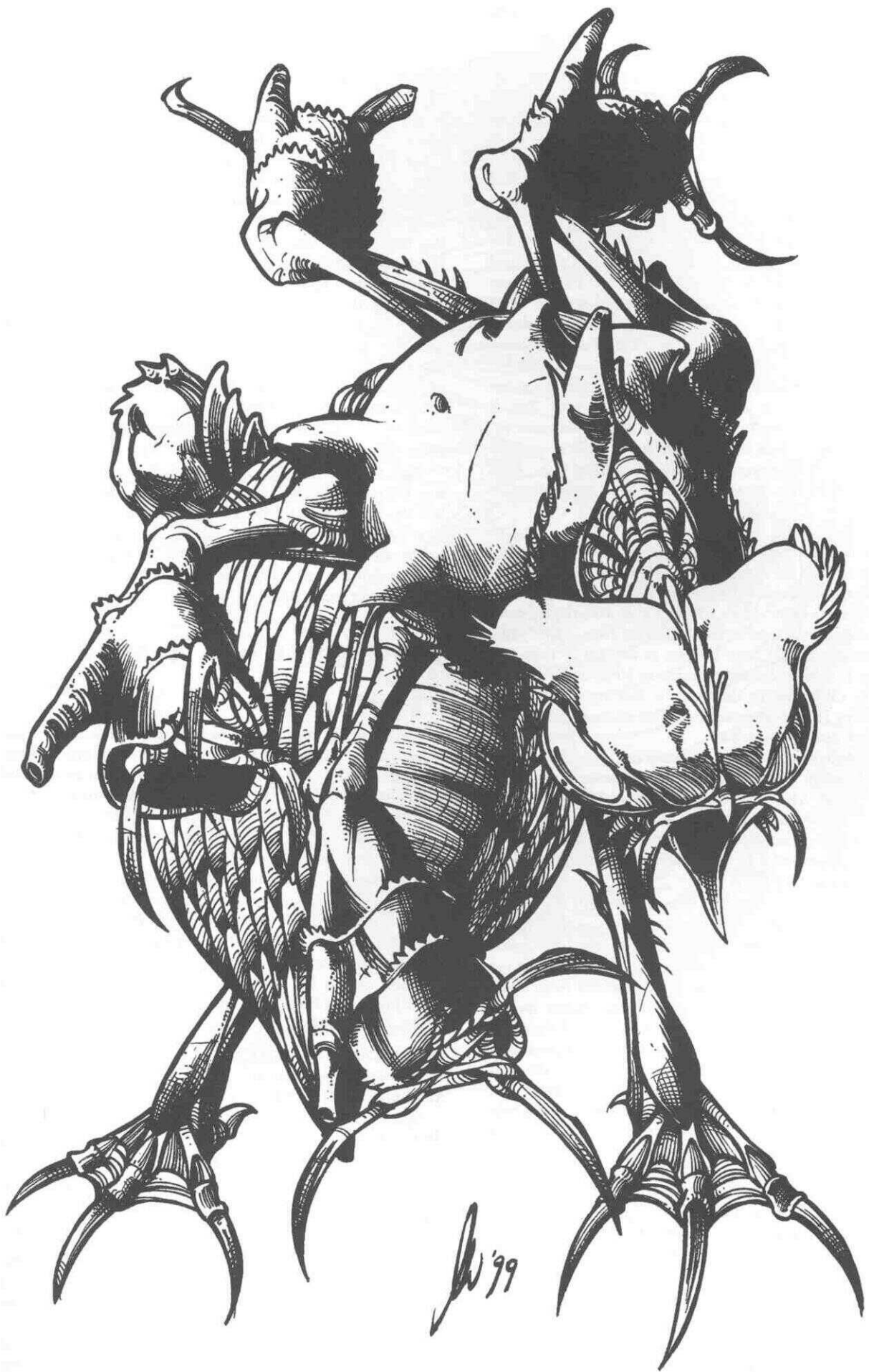

closed fist or forearm to inflict 2D4 +13 from its P.S. bonus. A bite does 2D4 damage.

The Assassin Bug can also fire an energy blast from its bio-energy housing, a strange horn- or tube-like growth located on each of its four arms. A single blast does 5D6 damage, but the Assassin Bug can choose to fire twin, simultaneous bio-energy blasts at the same target to inflict 1D6x10 damage! Such dual blasts count as *one* melee attack, but are only +2 to strike! See the description for Bio-Energy Blaster under *Natural Abilities of the Army Ant* for more details about this natural weapon. This attack is possible only when the Bug is in physical form.

Bonuses (including attribute bonuses): +4 on initiative, +5 to strike, parry and dodge, +13 to damage, +4 to save vs poison/toxins (and magic), impervious to disease, +6 to save vs Horror Factor. **Note:** The Assassin Bug is a leader and suffers no penalties when on its own. In fact, this particular Bug likes to operate alone, in pairs or small groups (3-10) of its own kind or in conjunction with Army Ants (grunts under their command).

Average Life Span: The exact life span for any bug is unknown to humans. It is believed that Assassin Bugs, like other Tier 2 sub-species, keep their Tier Two form for at least 30-50 years before they are able to advance to Tier 3, and some never change. Of course, humans don't have any idea how old the Bugs were when they arrived, so they can not anticipate when the creatures might evolve to Tier 3.

Size: 6-7 feet (1.8 to 2.1 m).

Physical Appearance: The Assassin Bug has the same fundamental shape as the Army Ant but is more hunched over, making it slightly smaller. Their jagged carapace flanges are also a bit larger and more noticeable than those of the Army Ant, and their natural body color is more of a deep purplish red or dark Alizarin Crimson with violet eyes. Of course, their body color changes as dictated by their chameleon ability to change color/appearance to blend with their surroundings. The most startling difference is that the Assassin Bug has a Bio-Energy Blaster appendage on *each* of its forearms (four total) rather than just one on its back.

Rumor: Some Exterminators and Splicers have reported that Assassin Bugs have the ability to mimic human voices perfectly. NORAD suspects that it was Assassin Bugs that infiltrated NORAD voice communications during the Battle of St. Louis, leading to the massacre of the 103rd Exterminators, but until another Assassin Bug is captured alive and remanded to NORAD for study, there is no way of telling this for sure.

G.M. Note: It is true, the Assassin Bug can perfectly imitate the sound of human speech (but not exact voices) and use ventriloquism as two of its secret abilities, both primarily used to trick, deceive, confuse and lure humans into a trap. Because these abilities are kept secret (no Assassin Bug can be forced to reveal them), they are not listed under the Natural Ability section. The monster can mimic human speech, words and any language and accent after hearing it just once! However, the alien's comprehension and understanding of human language is at best, poor (roughly equal to a skill level of 40%). This means the creature will learn and master certain key words, phrases and sayings like, "Please help me," "Don't let them Bugs git me," "Please ... please help me before it's too late," or "Don't come any closer, it's a Bug trap" (a ploy used to make the situation seem genuine), and so on. They are also likely to learn and use military jargon, call signs, curse words and common slang, like, "Ten-four," "Hey Dude," "Bro," "Buddy," etc. However, most Assassin Bugs do *not* understand the spoken language well at all. Thus, they tend to speak in short, simple, often choppy sentences, and answer questions with "yes, no, maybe, I don't know, could be, down the road a piece," and similar simple answers whenever possible.

Consequently, if forced into a conversation that lasts more than a few minutes and requires more than simple answers, the Assassin Bug can be identified by mistakes in its speaking. In addition to the speech pattern being suspiciously choppy or stilted, the creature will use the

wrong words, or respond with the wrong meaning. For example, in response to a human who says something like, "Don't worry pal, you'll be feeling better once we get some grub in your belly," the Bug might answer, "Oh, no, there is no grub in me. I am a free-thinker like you." Mistaking the slang word, "grub," meaning food, for the Brain Grub they implant to turn a human into a zombie. They have a particularly hard time with slang and specific details about Earth culture (i.e. "Boy, I sure miss baseball. I used to love those Cincinnati Yankees." To which the Bug responds, "Oh yes, I liked them too." Even people who don't care about sports, or who have grown up after The Meltdown, are likely to know about the "New York" Yankees). Likewise, a confused Bug may answer "yes" when the correct response should be "no," and vice versa, or give a completely wrong or a nonsensical response ("Oh man, there ain't nothin' like some delicious nuts an' bolts," or "love home cooked crap," or, "Yeah friend, I love to drink gasoline (or turpentine, or mud, etc.)," or "Yeah Dude, I can not wait to make some lovin' to my horse," or "Let's wipe (or lick or kiss) some Bug butt" — instead of "Let's wipe out some Bugs," or "Kick some Bug ass," and so on). Note: Silkworm controlled zombies have the same problem, but to a lesser degree. Their interfacing with the human brain gives them a much better understanding of human language, roughly equal to a language skill of 70%.

Such fake conversations will take place when the Bug pretends to be a fellow human on the radio (to lure out, track down, trick or confuse the human enemy) or a prisoner or injured victim that is out of plain sight (tied to a tree, locked in a room, concealed by debris or vegetation, etc. — often just partially visible but with the head obscured so it's impossible to see the face and if he or she is really doing the talking, or is even really alive).

Bombardier Beetle (Tier 2)

These frightful juggernauts are the Bugs' equivalent of a heavy tank or artillery piece, devoted to causing physical damage to hard targets and smashing through enemy defenses rather than stealth, trickery or infiltration. They care nothing for subtlety or tactics, preferring brute strength, raw firepower and wholesale destruction. They are killing machines on legs and will attack most problems head-on with little regard for how many Army Ants get butchered in the process or even how much damage it may take itself. Of all the Bugs, Bombardiers have the least sense of self-preservation. They also are the least inclined to communicate with anybody, even other Bugs. They are remarkably driven creatures obsessed with the defense of Bug holdings (their power centers and Bugtowns) and destroying the enemy. Perhaps they see themselves as stronger than any other members of their species, or even as nearly indestructible that they are so straightforward and aggressive. Or maybe they just delight in wholesale slaughter and wreaking carnage.

Bombardier Beetle (Tier 2)

Alignment: Always Diabolic.

Attributes: I.Q. 13, M.E. 11, **M.A. 9, P.S. 40, P.P. 14, P.E. 30, P.B. 5, Spd. 9.**

Hit Points: 80

S.D.C.: 250

Natural A.R.: 14

Horror Factor: 12

P.P.E.: 4D6 + P.E. attribute number.

I.S.P.: 40 + M.E. attribute number.

R.C.C. Skills (or Instinctual Equivalents): Climb 70%/50%, Swim 50%, Prowl 10% (+10% when hiding and staying motionless), Tracking (humans/humanoids, not animals) 75%, Land Navigation 65%, Detect Ambush 50%, and Detect Concealment 60%.

They are savage and relentless fighters and hunters often assigned to ferreting out and raiding free-thinking humans (especially



those hiding or operating in Bugtowns) and Seek and Destroy missions.

Also see Natural Abilities.

Natural Abilities:

1. **Bio-Energy Conversion:** Identical to the Army Ant ability, but cannot perform *Machine Union*.
2. **Energy Attack** as an **Energy Being:** Identical to the Army Ant ability, except their suicide attack will inflict 4D6x10+20.
3. **Limited Invulnerability:** Basically the same as the Army Ant ability, but has greater S.D.C. and A.R. in physical form.
4. **Bio-Energy Bombs:** The Bombardier does not have "Blasters" like most Bugs, but possesses the unique ability to create Bio-Energy

Bombs! The creation of each bomb counts as two melee attacks/actions and involves creating a sphere of energy out of thin air! The sphere of swirling blue or violet energy appears between the Beetle's two opened claws. Each sphere is about the size of a grapefruit and can be handled by the Beetle (juggling or carrying as many as four at a time) without them going off, but will instantly explode when touched by most non-Bug life forms. The Bombardier can throw, roll, or drop the energy sphere and allow it to go off on impact like a hand grenade, or place them like a shaped charge and made to go off with a mental command from the Beetle or upon being touched by a non-Bug life form (insects and plant life not included). Note that these Bio-Energy Bombs can be

created and given to other Bugs to use, except that most Bombardier Beetles don't trust "lower Bugs" (i.e. Army Ants, Assassin Bugs or Silkworm Zombies) to use them, and rarely give bombs to other Bugs (other than Tier 3) for any reason.

- Throwing Range: 200 feet (61 m).
- Duration of the Sphere: If not used, it harmlessly dissipates after 10 minutes.
- Damage per Bomb: 1D6x10 to the target it directly impacts and 2D6 damage to everything in a 10 foot (3 m) radius.
- Creation Time: Two melee actions.

Magic: None.

Psionics: Identical to the Army Ant's abilities.

Attacks Per Melee: Five physical/hand to hand attacks or two energy bomb attacks.

Damage: Beetles can stab and slash with their short-sword-like claws to inflict 4D6+30 (includes the P.S. Bonus) or strike with a closed fist or forearm to inflict 2D6 +25 from its P.S. bonus. Anybody or anything caught in a Bombardier's grasp will be crushed for 4D6+12 (half the P.S. damage bonus) *squeeze/crush attack* (each application of crushing pressure counts as one melee action). A bite does 1D6 damage. Note that the Beetle has two legs and two (not four) arms. Also see Bio-Energy Bombs under *Natural Abilities*.

Bonuses (including attribute bonuses): +2 on initiative, +4 to strike and parry, +1 to dodge, +5 to strike with Bio-Energy Bomb, +25 to damage, +8 to save vs poison/toxins (and magic), impervious to disease, +10 to save vs Horror Factor and +40% to save vs coma/death.

Note: The Bombardier Beetle is a leader and suffers no penalties when on its own. In fact, this particular Bug likes to lead Army Ants (grunts under their command) and other Bugs.

Average Life Span: The exact life span for any Bug is unknown to humans. It is believed that the Bombardier Beetles, like other Tier 2 sub-species, keep their Tier 2 form for at least 30-50 years before they are able to advance to Tier 3, and some never change (In fact, some believe that the Beetles can never change form, but whether that's true or not is unknown). Of course, humans don't have any idea how old the Bugs were when they arrived, so they can not anticipate when the creatures might evolve to Tier 3. Furthermore, some Tier 2 Bugs may evolve to a higher Tier faster than others.

Size: 12 feet (3.66 m) long, 7-8 feet (2.1 to 2.4 m) tall, and weighs 4-6 tons.

Physical Appearance: Bombardier Beetles look like a cross between a huge black beetle and a gorilla. They are partially bipedal, with a pair of short but powerful legs that look unable to hold up the rest of the Bombardier's substantial bulk. However, when running (and often even when standing) the Beetle supports its upper body by running on all fours and walking on its hands; adding to its resemblance to a gorilla. The pincers on their hands are long, sword-like claws that add to their damage capacity in hand to hand combat. This creature's head is much smaller and rounder than those of other Bugs.

Notes: Because of their bulk, Bombardiers tend to shake the ground or flooring as they walk. Anyone with a working seismograph can detect their presence within one mile (1.6 km). Inside buildings, their pounding footsteps and the creaking of support beams and flooring clearly announces their location and direction of travel (no prowling is possible). Their size and bulk also limits their ability to enter many buildings, especially those with small windows, doors, and openings, and their great weight means some floors cannot support them. However, Bombardiers will push, smash or chop their way in or roll one of their bombs into places they can't enter, or they'll send in Army Ants or other Bugs smaller than themselves to do their dirty work.

Killer Bee (Tier 2)

Not only are Killer Bees combat leaders and aerial specialists, but they possess a vicious streak unusual even for Bugs. It is common knowledge that the Bugs are here purely to feed. For most bugs, the war against humanity is only because humans refuse to let them take the planet without a fight, making combat a necessity (If we simply left the planet and all moved to Mars, none of this fighting would be happening). Killer Bees, however, are different. They hunt and kill humans as both part of their job as defenders of Bugtowns and power centers, and for the pure thrill of bloodletting. They love to kill and take a perverse pleasure in terrorizing and torturing any creatures weaker than they.

As a psychological weapon, just one Killer Bee often has as much impact as an entire Swarm of Army Ants. Initially, a Killer Bee's Horror Factor is 12, but once a human witnesses these terrors in combat, their Horror Factor spikes up to 16, and all humans must make another H.F. check when this happens. These monsters fight so viciously, so mercilessly, that to see them rip people to shreds is enough to make even the hardest soldier tremble.

Killer Bees also are different from their fellow Bugs in that they enjoy leading strikes deep into the wilderness and remote regions of the Free World where Bugs are at their most vulnerable (minimal access to electric hardlines and machines, meaning no energy as food surplus or pleasure, plus wilderness/survivalist humans are usually better armed and prepared for combat than Bugtown refugees). The Killer Bees don't care about the risks or hardships, and seem to find fun and challenge in hunting down and killing these most resourceful of the human enemy. Since much of the rural countryside is relatively safe from the Bugs because there are few (if any) hardlines and easy energy sources to gorge on, most Bugs tend to avoid these places, content that the pitiful human refugees cower among nature in terror and live like animals. However, the Killer Bees will brave any terrain or environment to find "sport" or to extract revenge. Thus, it is the Killer Bees who lead (unhappy) squads and larger Battle Groups of Army Ants and other Bugs into the hostile wilderness to locate and destroy humans. The very fact that humans are hiding *anywhere* is reason enough for Killer Bees to hunt and slaughter them.

Where this becomes problematic for the Bugs at large is sometimes Killer Bees go into thrill-killer frenzies or obsessive revenge. An angry or vengeful Bee will sacrifice an entire legion of Army Ants and a dozen Tier 2 Bugs to root out and destroy even a single human that has earned its lasting enmity. Killer Bees are easily provoked to combat and hate to lose. They will never forget those who best or trick them in combat and escape, so when the two enemies meet again, the Killer Bee will fight like an insane demon to extract a terrible vengeance. Some even fall prey to the Mindless Aggression form of insanity, making them just as dangerous to friend and foe alike. In general, a Killer Bee can control itself in combat, but after, if victory is sweet (a slaughter) or if the human enemy has made a successful strategic strike and flees (hit and run tactics are the best against Bugs), and/or if the Killer Bee is humiliated, there is a 01-50% chance it will fly into a fit of temporary Mindless Aggression, attacking anybody (including other Bugs) who gets in its way! Witnessing delicious acts of torture or violence can also send the creature into a blissful, euphoric killing frenzy. Such a psychotic episode typically lasts for 2D10 minutes, lashing out at everyone in sight and killing or maiming most.

If a Killer Bee attacks another Bug, the Bugs will fight back. Given how Killer Bees are usually vastly outnumbered when they go into a frenzy, it's not uncommon for them to die at the claws of their subordinates. Ironically, then without a leader, Tier 1 Bugs become disoriented and much easier to defeat.

NORAD Eggheads have found it interesting that Killer Bees do not go into a frenzy when killing animal life forms, such as cattle or guard dogs. Only humans. This implies that the Killer Bees have a particular hatred for humans (and other intelligent beings?), almost as if they are



taking revenge against the people of Earth for some past transgression of which we have no recollection. Or it may be that they simply see all intelligent beings outside the Bug race as their inferiors to be subjugated or destroyed. As super efficient killing machines, they may simply feel compelled (instinct?) to relentlessly destroy all who remain outside their direct control. Thereby eliminating even the potential threat of sabotage and opposition from those whose world they have stolen.

Killer Bee (Tier 2)

Alignment: Diabolic! Diabolic! Diabolic!

Attributes: I.Q. 13, M.E. 13, M.A. 13 (among other Bugs, 3 when it comes to humans), P.S. 25, P.P. 20, P.E. 25, P.B. 8, Spd. 22 (15 mph/24 km) running, and 77 (53 mph/85 km) flying.

Hit Points: 50

S.D.C.: 150 (the wings have an additional 60 S.D.C. each)

Natural A.R.: 13

Horror Factor: 12 — 16 after seeing them in action.

P.P.E.: 5D6 +P.E. attribute number.

I.S.P.: 50 +M.E. attribute number.

R.C.C. Skills (or Instinctual Equivalents): Climb 85%/80%, Swim 40%, Prowl 50% (not applicable when flying), Tracking (humans/humanoids, not animals) 75%, Land Navigation 85%, Detect Ambush 50%, Detect Concealment 60% and Sniper (with blasters).

They are savage and relentless fighters and hunters often assigned to ferreting out and raiding free-thinking humans (especially those hiding or operating in Bugtowns) and Seek and Destroy missions.

Also see Natural Abilities.

Natural Abilities:

1. **Bio-Energy Conversion:** Identical to the Army Ant ability, but can not perform *Machine Union*.

2. **Energy Attack as an Energy Being:** Identical to the Army Ant ability.

3. **Limited Invulnerability:** Basically the same as the Army Ant.

4. **Bio-Energy Blasters (2):** Fundamentally the same as the Army Ant ability, but the Killer Bee has two articulated Weapon Stalks over its shoulders that house the Blasters. These stalk-mounted shoulder blasters can move up and down in a 180 degree arc of fire and side to side in a 220 degree swing of fire. They can also be positioned to shoot around or over walls and obstacles (shooting blind) without the Killer Bee showing its body.

Superior Range: 2000 feet (610 m).

Damage: 5D6 from a standard blast, but can also fire twin, simultaneous blasts at the same target to inflict 1D6x10 damage (counts as *one* melee attack), or to fire simultaneously at two different targets (no strike bonus, unmodified strike roll to hit; counts as two melee attacks). Instead of causing physical damage with the Bio-Blaster, the Killer Bee can modulate his blasts for *electrical disruption*, the same as the Army Ant.

5. **Winged Flight:** Killer Bees are the only (known) Bugs to have large insect wings and the ability to fly at will. This form of winged flight is rather loud, and makes it virtually impossible for a flying Killer Bee to sneak up on anyone while flying (prowl only applies when crawling on the ground). The buzz of its mighty wings is impossible to miss within 600 feet (183 m) unless there is some other constant, loud noise, and, if quiet, can be heard up to 2000 feet (610 m) away; triple if there are two or more flying together. Dogs and other creatures with acute hearing will pick up an approaching Killer Bee at triple the distances noted above. This is one reason freedom fighters and survivalists often keep one or more canine companions.

6. **Bio-Regeneration:** A Killer Bee will regrow a wing, weapon stalk or appendage that is lost in combat. However, it takes 1D4+4 weeks to regrow a stalk, 2D4+6 to regrow a limb and 1D6+12 to regrow a wing(s).

Magic: None.

Psionics: Identical to the Army Ant's abilities.

Attacks Per Melee: Four hand to hand or energy attacks on the ground, six when flying — and these nasties are almost always aloft.

Damage: Killer Bees can stab and slash with their short-sword-like claws to inflict 3D6+13 (includes the P.S. Bonus) or strike with a closed fist or forearm to inflict 2D4 +10 from P.S. bonus. A bite does 1D6 damage.

The Killer Bee can also fire bio-energy blasts from one or both of its weapon stalks. See *Natural Abilities* for damage and details.

Bonuses (including attribute bonuses): +4 on initiative, +4 to strike, parry and dodge when on the ground (+5 to strike and parry when airborne and +7 to dodge when flying), +10 to damage (+4 additional to hand to hand damage for every 20 mph/32 km of flying speed), +5 to save vs poison/toxin (and magic), impervious to disease, +20% to save vs coma and death, and +8 to save vs Horror Factor. **Note:** The Killer Bee is aggressive and a natural born leader, so it suffers no penalties when on its own. In fact, this particular Bug loves to lead Army Ants (grunts under their command) and other Bugs.

Average Life Span: The exact life span for any Bug is unknown to humans. It is believed that Killer Bees keep their Tier 2 form for at least 30-50 years (possibly much longer) before they are able to advance to Tier 3, and many never change (presumably because they enjoy their role as Killer Bees too much to give it up). Of course, humans don't have any idea how old the Bugs were when they arrived, so they can not anticipate when the creatures might evolve to Tier 3. Furthermore, some Tier 2 Bugs may evolve to a higher Tier faster or slower than others.

Size: 6-7 feet (1.8 to 2.1 m); very hunched over.

Physical Appearance: Killer Bees are roughly the same size and shape of Army ants, except their carapace is smoother and sleeker, and where an Army Ant has its bio-energy cannon vent, the Killer Bee has a carapace housing for a pair of wings and two weapon stalks to fire bio-energy blasts, one on either shoulder. In addition to the extra flexibility provided by the weapon stalks, they also enable the monster to fight with, or carry things in, its claws and still blast away while walking or flying. Killer Bees are an orange-red color with a black lightning bolt-like pattern on their lower abdomen. Their eyes are an eerie yellow-green. The wings, a translucent yellow with orange veins.

Stink Bug (Tier 2)

The Bug Invasion is a two-pronged offensive. The most dramatic and first noticed was the outright capture of the global electronic nervous system of hardlines and communications lanes, as well as the deactivation or capture of most of the world's military hardware. As devastating as this was, humans could fight it and had a reference for the conflict. It was not until a few years after The Meltdown that people began to understand that the Bugs were not just hijacking our technology or energy resources, but our very bodies as well! The Bugs responsible for this insidious aspect of the war are the reviled *Stink Bugs*.

These creatures are Tier 2 Bugs that vaguely resemble a Praying Mantis. They are not particularly well suited for direct combat themselves, but are perfectly evolved for the mass pacification of humans. The Stink Bug is able to generate or lay what humans call the *Silkworm* — a worm-like parasitic sub-species that can be implanted in human beings (and most humanoids) and turn them into zombies under the Bugs' complete control.

The creature gets its name from its natural defense mechanism, a foul smelling chemical spray that incapacitates its opponents.

Alignment: Diabolic.



Attributes: I.Q. 14, M.E. 16, M.A. 13, P.S. 16, P.P. 16, P.E. 16, **P.B. 4**, Spd. 16.

Hit Points: 30

S.D.C.: 50

Natural A.R.: 8 (soft carapace).

Horror Factor: 10

P.P.E.: 6D6 +P.E. attribute number.

I.S.P.: 120 +M.E. attribute number.

R.C.C. Skills (or Instinctual Equivalents): Climb 95%/90%, Swim 60%, Prowl 40% (+15% when climbing or hanging from the ceiling, wall or other high place, and +25% when trying to hide someplace high and out of easy sight), Tracking (humans/humanoids, not animals) 55%, Land Navigation 65%, Intelligence 75% and Acrobatics 75%.

Stink Bugs tend to be elusive plotters and organizers who stay in the background and try to avoid direct physical conflict and physical confrontation with non-Bug life forms. Their job is to survive, give birth to Silkworms and supervise the implantation of human victims with the Silkworms to create zombies to serve their race.

Also see Natural Abilities.

Natural Abilities:

1. Bio-Energy Conversion: Identical to the Army Ant ability, but can not perform *Machine Union*.
2. Energy Attack as an Energy Being: Identical to the Army Ant ability.
3. Limited Invulnerability: Basically the same as the Army Ant ability, but has lower S.D.C. and A.R. in physical form.

4 Climb and Adhere to Surfaces: The Stink Bug is able to attach itself to any solid surface by its fingers, hands, toes and feet. This means that the Bug can walk on walls or ceilings, and can climb most surfaces effortlessly and at full running speed. The only limits to this ability are the Bug's own strength and speed. Attempting to carry a weight greater than its P.S.x10 in pounds (0.45 kg), will cause it to immediately fall off. Climbing and crawling speed along walls and ceilings is equal to half the running speed when carrying a heavy load (P.S. x5 in pounds).

Restrictions: Loose rocks, crumbling plaster, ice, oil or other slippery substances will prevent the creature from adhering to a surface (polished metal, chrome, and glass are not considered slippery substances and can be held on to and climbed).

5⁺ Chemical Attacks: Nearly 40% of the Stink Bug's physiology is devoted to the production and storage of toxins that can be unleashed as a chemical spray or gas.

Mind-numbing gas: A potent, mind-numbing agent that is particularly effective against humans. When the Stink Bug expels this gas through its lower abdomen, the agent expands and disperses in the air, creating a huge cloud that can eventually billow out to cover approximately a 100 foot (30.5 m) radius. It has the smell of rotting garbage but the stink is not overwhelming. Any human who breathes this agent must save vs non-lethal poison (16 or higher).

A successful save (16 or higher) means the character feels momentarily lightheaded, but the sensation passes in seconds and there are no penalties.

Failure to save (a roll of 1-15) causes the victim to immediately feel lightheaded and thinking becomes difficult. The character becomes sluggish and has great difficulty concentrating; reduce speed by half, skill performance by half (and takes twice as long normal to perform), all combat bonuses by half, and attacks per melee round by one. These penalties remain in effect as long as the character remains in the gaseous cloud and for 1D4+3 minutes after exiting the cloud. **Note:** This gas can be released as often as once per hour and the cloud will linger in the air for 3D6+6 minutes. This gas defeats conventional gas masks, although NORAD has developed an Organitech gas mask that will stop the agent.

Stink Spray: This is a chemical spray secreted from glands in the mouth. It is sometimes used to mark a trail or territory (in the latter

case as a warning), as well as a defensive weapon. The spray has the potent stench of a hundred rotten eggs! The stench can be smelled for a 20 foot (6 m) radius and affects everyone in its range. Any human who breathes/smells this agent must save vs non-lethal poison (16 or higher).

A successful save (16 or higher) means the character gags, his eyes water and he is struck by a wave of nausea, but manages to hold down his lunch and work through it. However, he or she is distracted by the powerful stench, feels sick and is -2 on initiative and -10% on the performance of skills. Penalties apply as long as the character remains in the foul smelling area and for 1D6 melee rounds after leaving it. **Note:** The stench remains at full effect for 2D4x10 minutes, with a faint smell (easily detectable by dogs and other animals with a keen olfactory sense) that lingers for another 1D4x10 hours. The Stink Bug can use this spray attack twice per hour. Duration of penalties lasts for as long as an opponent remains in the stench zone and for 1D6 melee rounds after leaving it.

Failure to save causes the victim to be overwhelmed by the gut-wrenching stench and stopped in his tracks to vomit. This causes the character to lose initiative and two melee attacks. Furthermore, the character's eyes water profusely and he feels dizzy and sick — reduce attacks per melee by one, all combat bonuses are negated and skill performance is reduced by half. Worse, there is a 01-75% likelihood that the character finds the stench so overwhelming that he must flee the area and cannot bring himself to enter the "stench zone." Plus there is a 01-70% chance of starting each melee round by throwing up (losing initiative and two melee attacks).

If the stink chemical was sprayed directly on the character, he will spend all his next several melee actions frantically discarding his clothing and seeking some means of washing the putrid stench from his body (suffering its full penalties until the stench is washed away). In the future, such victims will regard the Stink Bug with disdain and a Horror Factor of 12.

Anesthetic Spray: An incredibly potent and concentrated spray that will knock out humans and effectively anesthetized them for 1D4 hours! The spray comes from a gland in the mouth and must be directly sprayed in the potential victim's face. A save vs non-lethal poison (16 or higher) is necessary to fight off its effects.

A successful save (16 or higher) means the character feels woozy for 1D4 melee rounds, the initiative bonus is half and skills are performed at -10% until the wooziness passes, but he or she is otherwise okay.

A failed save means the character immediately collapses in an anesthetized state (can not be roused without treatment from a Medical Doctor or Anesthesiologist, and even then will be out cold for at least 2D4x10 minutes). This attack is typically used to prep victims to receive the dreaded "Silkworm" or "Brain Grub" without resistance. The poor sleeping individual is quietly invaded and turned into a zombie. **Note:** This attack can only be performed once every four hours, maximum.

6. Silkworm/Grub generation: Producing Silkworms is the second part of the Stink Bug's purpose. The average Stink Bug can produce 2D6x50 Silkworms every three months. Each Silkworm is a small, wormy or larva-like thing that can fit in the palm of a hand. They are parasitic creatures that can invade a human body by entering the nose or ear, crawling into the skull, attaching itself to the brain, and taking over that one human being.

Since there is only one Stink Bug for every 2,000-3,000 other Bugs, and since there are literally tens of millions of human survivors/free-thinkers, it will be some time before the majority of humans are placed under the Silkworms' influence. Until then, the Stink Bugs command and direct the Silkworm Zombies as well as thousands of free-thinking slaves kept in line by doses of the Bug's other chemicals, intimidation and the zombies. Indeed, most of the big cities (nicknamed "Bugtowns" or "Bug Centers") have essentially turned into overcrowded holding pens for human prisoners/slaves waiting to be turned

into zombies. This slow, but methodical process of creating zombies coupled with the frightfully high numbers of people who died during The Meltdown and at the hands of the Bug invaders, explains why there are so (comparatively) few free people in Free America or the rest of the world. **Note:** This spray attack can only be done four times per 24 hours (so many victims of the Silkworm are zombitized without benefit of anesthesia).

Magic: None.

Psionics: Identical to the Army Ant's abilities.

Attacks Per Melee: Three hand to hand attacks. A gas/spray attack can be substituted for a hand to hand attack, but each spray counts as one melee action/attack.

Damage: The Stink Bug can stab and slash with its knife-like claws to inflict 2D6+2 points of damage (includes the P.S. Bonus). A strike with a closed fist or forearm does 1D6+1 with P.S. bonus. A bite does 1D6 damage.

Also see chemical attacks described under *Natural Abilities* for damage and details.

Bonuses (including attribute bonuses): +1 on initiative, +1 to strike, parry and dodge (+2 to strike and parry, and +3 to dodge when climbing on a wall or ceiling), +1 to damage, +2 to save vs poison/toxin (and magic), impervious to disease, +4% to save vs coma and death, +1 to save vs psionic attack, and +4 to save vs Horror Factor. **Note:** The Stink Bug is a planner, strategist and leader, so it suffers no penalties when on its own. In fact, this particular Bug is often behind the scenes, coming up with strategies and tactics that the other Bugs implement. They are also the ones in charge of creating, commanding and distributing the Silkworm Zombies as well as free-willed slaves.

Average Life Span: The exact life span for any Bug is unknown to humans. It is believed that the Stink Bugs keep their Tier 2 forms for at least 30-50 years (possibly much longer) before they are able to advance to Tier 3, and many never change. Of course, humans don't have any idea how old the Bugs were when they arrived, so they can not anticipate when the creatures might evolve to Tier 3. Furthermore, some Tier 2 Bugs may evolve to a higher Tier faster or slower than others.

Size: 9-10 feet (2.7 to 3 m) tall.

Physical Appearance: Stink Bugs are tall, spindly and mantis-like, with a bloated abdomen where their womb and gas sacs are located. They stand more erect than most other Bugs, and they move slowly and deliberately, as opposed to the jerky, hyper activity of most other Bugs. Their claws are small and less pronounced than the body weaponry of their counterparts. Those humans who have encountered a Stink Bug and lived to tell of it report that they definitely seem more intelligent than other Bugs. NORAD Psychics have also noted that they seem to have higher rates of success when trying to monitor Stink Bug communications.

Silkworms (Tier 1)

The Silkworm is also known as a "Brain Grub," "Grub," "Nose Slug" and "Worm." They are the parasitic offspring of the Stink Bugs. However, they do not grow into Silkworms or even Army Ants, but live out their lives in the body of a human host. Silkworms differ from other Bugs in a variety of ways. First, their tiny size and worm-like appearance speaks for itself. More importantly, Silkworms require only a minuscule fraction of the energy compared to the amount the large Bugs consume daily. Within 72 hours after its "birth," the horrid parasite must find a suitable host body to inhabit for the rest of its life. On Earth that means humans, but on other worlds it's any intelligent, non-Bug life form. If a host can not be located (the Stink Bug usually makes certain there are a number of prisoners waiting to be zombitized), within 72 hours, the Silkworm dies. Furthermore, these basic creatures lack the ability to transform into or transmit energy.

They are by nature parasitic symbiotes who burrow into the brain of their host and seize complete control of it. The human body then becomes the monster's vessel — the vehicle or puppet it controls. Any human possessed by a Brain Grub is forever lost — NORAD and independent scientists have been unable to find a way to remove the Silkworm without killing both the Grub and its human host. Likewise, kill the human body and the Silkworm dies, that's how complete the union between this Bug and its human host becomes. Consequently, they are very protective of their host bodies, and exhibit the same degree of self-preservation that a Bug does. The human brain and body also produces more than enough energy for the Silkworm to live in blissful comfort for decades. As a symbiotic organism (and in an act of self-preservation), the Silkworm can stimulate the brain and the production of body chemicals to dramatically slow the aging process of the host body as well as fight off disease. This means the typical human host body can survive in good health for up to 150 years! Of course, it's life as a zombie, with the Silkworm controlling the mind and body.

Evidence shows that they voluntarily obey their Stink Bug commanders, rather than act in accordance with some irresistible urge to comply with their superiors. However, there may be a psionic link (empathic, telepathic, or something) between the Silkworms and their creators (and all Stink Bugs) that keeps them steadfastly loyal and obedient, even in the face of death. After all, by human standards, one would think Silkworm Drones must tire of being used as expendable workers, spies and frontline troops. The degree to which they serve the Bug ecology makes them little more than a slave race to be used and ultimately abandoned when the Bugs have finished with that world. If they were humans, they would be primed for rebellion, yet they do not seem to resent or dislike their life in the least. The question is why? And can they be subverted? (It does not seem so.)

Silkworm — A.k.a. Worm, Brain Slug, Brain Grub, & Grub.

Alignment: Aberrant in regards to their loyalty to their fellow Bugs. It is widely believed among humans that once they "Bug" a human host, the Silkworm's alignment will become anarchist or unprincipled if the host was previously of a good or selfish alignment and that buried deep somewhere inside the Silkworm Zombie is some remnant of the person's old identity — certainly the Brain Grub seems to possess some of





the memories. Sadly, there is absolutely no clinical evidence to support this strongly held belief. This rumor is probably nothing more than the desperate hope clung to by survivors who want to believe that loved ones turned into Silkworm Zombies may someday be rescued and "debugged" — returned to normal.

Attributes: I.Q. 10+1D4, M.E. 10+1D4, M.A. 10. All physical attributes are those of the possessed human; roll as normal. The physical attributes of the Silkworm before it seizes control of its host are all one.

Hit Points of the Silkworm itself: 1D6, but once linked to a human host, it relies on the H.P. and S.D.C. of its host body. Kill the body and the Bug dies. Remove or kill the Bug and the body dies.

S.D.C. of the Silkworm itself: Zero. Under its influence the host body gets an extra 2D6 S.D.C.

Natural A.R. of the Worm itself: 4

Horror Factor: 10

P.P.E.: 1D6 +P.E. attribute number.

L.S.P.: 80 +M.E. attribute number.

Skills: Whatever skills the human host once knew, the Silkworm now knows and draws upon. It cannot learn new skills nor do the old skills once known to its human host improve with experience. Furthermore, an 85% skill proficiency is the maximum available to the Silkworm

Natural Abilities:

Host Interfacing (Possess & Usurp Host Body): Silkworms crawl into the ear canal or up the nasal passage of a human and burrow through to the brain. There, the parasite nestles in between the frontal lobes and takes over the host body's brain functions entirely, controlling the body like a pilot inside a vehicle, or a master puppeteer. In taking control of the brain, the Silkworm destroys certain vital links to higher thought processes, namely those involving creative thought, self-identity and personality. For all intents and purposes, this leaves the host body devoid of a personality, rendering the person effectively dead. Thus, hosts have no means of resisting once a Silkworm takes them over. Whatever consciousness is left is completely supplanted by the Brain Slug — truly, nobody knows what one is aware of, if anything, once a Silkworm has moved in and taken control. It is believed nothing of the original person remains, although many pray otherwise.

A Silkworm controlling a host body benefits from the body's physical abilities, skills and bonuses but they do not improve under the Worm's control (Note: If adapted to worlds where superhumans exist, the creature will be able to use super abilities and special abilities. Likewise, if a spell caster is taken over, the Silkworm can cast magic, but only *one* spell per round). The implantation process can only occur on a willing, indifferent or unconscious (sleeping) participant. Those who are awake, alert and opposed to being impregnated cause the Silkworm to back off. Furthermore, a Silkworm can *not* invade the host body of anybody who is a Major or Master Psionic! Why this is the case remains a mystery, but powerful psychics are generally considered to be the Bugs' greatest enemy and are systematically destroyed whenever they are discovered. Minor Psychics can be used as host bodies but can resist the initial domination process for twice as long as usual.

The Silkworm seizes control over its host in a matter of minutes, however, it takes approximately 8+1D6 hours for the Silkworm to completely destroy its host's personality and individuality. This is the only window of opportunity in which the hellish thing can be removed without killing its host, namely because its control is not yet absolute. If removed in under four hours, the victim suffers no significant brain damage, reduce I.Q. by one point. If removed 4-8 hours after being impregnated, reduce I.Q., M.E., and M.A. by 1D4 points (the player can roll once with the result being the same for all attributes, or roll for each). Double the penalties (2D4) if removed after eight hours but before the Silkworm's link is complete (severe brain damage is likely). P.B. may be reduced by 1D4 points to depending on the skill of the surgeon or type of (effectively) lobotomy performed (or "Bugotomy" as it is sometimes called). There will be at least a small scar.

Silkworms use their host bodies for a variety of purposes. During the initial invasion, they took over vast numbers of military and police to subvert and eventually seize control. Later, they began to round up other humans under the pretense of taking them to safety while The Meltdown raged throughout the country. Once gathered together, of course, these folks were subjected to Silkworms to form a legion of loyal, humanoid workers, spies and defenders. Their primary purpose is to secure and maintain Bugtowns/Power Centers and the all important generating, flow and distribution of delectable energy. It is the Silkworm Zombies that operate all power plants and handle all electrical work (under the supervision and protection of Army Ants and other Bugs). They also run the various industries needed to keep the millions upon millions of human captives alive and healthy. Free human slaves (dominated by Silkworm Zombies, Stink Bugs and other Tier 1, 2 and 3 Bugs) perform only the most menial tasks, typically hard labor. Ultimately they too are scheduled for Bug "interfacing" — i.e. becoming Silkworm Zombies, and are regularly taken away in groups of hundreds at a time, only to return a day later as Bug masters rather than slaves.

Note: Although "interfaced" with their human host, the Silkworm Zombie's understanding of human languages is roughly equal to a language skill of 70%. The creature will know all the languages once known to the body it inhabits. The damage to the brain in order to destroy the original consciousness/personality and the creature's own alien nature are probably both responsible for the Bug's incomplete understanding of human languages.

Magic: None.

Psionics: Identical to the Army Ant's abilities, and may use any Minor Psionic abilities that the host may have possessed.

Attacks Per Melee: As per human: Three for the average human, four for those with military or physical training.

Damage: As per human hand to hand combat or hand-held weapon. Human weaponry, particularly knives and guns, are commonly used by Silkworm Zombies; body armor and vehicles may also be used, particularly by the police and military. Note that the Bugs keep the icons and uniforms of Earth society, so police and soldiers wear the uniforms and identifying insignias, and such, that they always did. This helps with easy identification and defense (i.e. all police and the military used by the Bugs are Silkworm Zombies).

Bonuses: Limited. Silkworm Zombies tend to move a bit slower (reduce the host's Spd by 25%) and stiffer than "free thinking" humans. Only the bonuses from attributes and those from physical skills (other than hand to hand combat) known at the time of impregnation apply. Bonuses from hand to hand combat skills are *not* applicable to Zombies.

The host body is also +1 to save vs psionic attacks and illusions, +3 to save vs poison and disease (+1 to save vs magic), +4 to save vs Horror Factor, +20% to save vs coma and death, heals twice as fast as normal humans and is impervious to possession.

Note: Without a leader, the Silkworm Zombies are -2 melee attacks/actions, lose their H.F. bonus, and skills are -15%.

Average Life Span: On their own, the Silkworm perishes in three days (72 hours), but inside a host body, they will live at least 50% longer than the average life span of the typical human; 105 years, but many can reach the ripe old age of 140-150. The oldest don't appear to be more than 50-60 years old.

Size: About the size of an Earth slug, some 2-3 inches (50-75 cm).

Physical Appearance: These foul creatures bear an unsettling resemblance to large wood grubs or housefly maggots. They are soft, white, somewhat slimy, and with a darkened head. Tiny legs are located near the front quarters.

Silkworm Zombies also have a unique appearance. Most noticeable is the purple bruise that appears under the nose (and sometimes, about 30% of the time, the nose is discolored by popped blood vessels giving it a purple, W.C. Fields appearance as well). This bruise is constant, and never fades or goes away (ironically, the Bugs don't even consider covering it with make-up). They also

move in a comparatively wooden and slow, deliberate motion, occasionally, a little bit jerky (especially when confused or without leadership). Furthermore, as noted earlier, Silkworm Zombies lack personality, thus they tend not to react strongly to events around them and speak in a slow, monotone voice that doesn't show much sign of emotion or personality. However, the Zombies do show some basic hints of emotion, a furrowed brow, a tinge of anger in the voice or words, and fear (or anger) when they are concerned for the safety of an important Tier 2 (or higher) Bug, plan or place like a power generator. They don't usually show much, if any, fear for their own life or other Zombies or Army Ants (fellow Tier 1 bugs). That having been said, they have absolutely no sense of humor (they don't even understand the concept), a sure giveaway. Moreover, whenever under extreme stress or extremely angry (though not outwardly noticeable), the Silkworm Zombie will spontaneously nose-bleed.

Furthermore, psychic individuals, even Minor Psychics, will immediately sense a Silkworm Zombie the moment he lays his eyes on one. If there is any doubt, looking at the individual's aura or a quick empathic or telepathic probe will confirm the alien nature of the seemingly human person before them.

Note: As the Great American Bug Hunt is kicking into high gear, the Bugs have decided to take to the offensive against free humans and particularly resistance cells. For a few years, human survivalists and freedom fighters were virtually ignored, for as long as they did not seriously interfere with the Bugs' colonization and feeding, they did not really care what they did. However, when it became apparent that the humans were organizing and growing more aggressive against the Bugs, the alien insects decided to take action. This includes Killer Bee led seek and destroy teams, outright assaults on obvious human settlements or bases (military or not), and setting traps, ambushes, and such to lure free-thinkers out into the open. Silkworm Zombies are used as infiltrators, spies, assassins, and saboteurs as well as for reconnaissance, intelligence, and extermination. After all, fellow humans (especially from a distance) are a much less obvious threat and might even be allies, enabling the Zombies to get in close to locate, observe, and even infiltrate human camps. Furthermore, the human appearing Zombies can more easily access human architecture and operate human equipment than their bulky and inhuman brethren. Don't forget, they are likely to understand and use human weapons, machines and vehicles, which may also enable them to sabotage them. Once an individual or group of humans is located, the Silkworm simply calls for Bug troops to wage an attack. Otherwise, Silkworm Zombies function as the "human interface" as the Bugs call it, working as technicians, mechanics, machine operators, and as an auxiliary military.

Zombies dispatched on such military duty often work with Army Ants, Assassin Bugs, Bombardiers and Killer Bees. These forces are striking freedom fighters and survivalists deeper and deeper in rural areas where there are no (or few) nearby hardlines or accessible power sources. While the Bugs are most vulnerable in this setting, they are still dangerous in the extreme. As the Bugs mount their own version of guerilla warfare against survivors, Free America might find the war with the Bugs taking a more unpredictable and deadly turn.

Lightning Bug (Tier 3)

These are the toughest Bugs of The Swarm, spending much of their time feeding/interfaces directly with large energy sources like the hearts of power plants and nuclear reactors. They are the only ones that can maintain pure energy conversion and function outside of a containment medium (e.g., a hardline or device), which makes them very, very difficult to kill.

Lightning Bugs usually lead their own swarm (1,000-100,000, sometimes as many as five times more) and are almost never sighted in

the company of other Lightning Bugs. Some Eggheads speculate that there are only a relative handful of Lightning Bugs on Earth, and they must remain dispersed in order to command the rest of the Swarm. Others speculate that the Lightning Bugs are actually highly antagonistic with each other, and that if in the same vicinity, might even attack one another. Neither theory has been seriously examined.

What is known is that Lightning Bugs are basically the generals of The Swarm. Each commanding his own army or swarm of all lesser Bugs, with the majority being Army Ants and (over time) Silkworm Zombies.

Lightning Bug (Tier 3)

Also Known as the "Command Bug" or "Warlord."

Alignment: Diabolic.

Attributes: I.Q. 20, M.E. 20, M.A. 20, P.S. 30, P.P. 25, P.E. 30, P.B. 5, Spd. 30 running (roughly 22 mph/35 km) or by electric flight (see Natural Abilities, below).

Hit Points: 85

S.D.C: 250

Natural A.R.: 16

Horror Factor: 15

P.P.E.: 3D6x100 +P.E. attribute number.

I.S.P.: 120 +M.E. attribute number.

R.C.C. Skills (or Instinctual Equivalents): Climb 95%/90%, Swim 60%, Prowl 60%, Tracking (humans/humanoids, not animals) 85%, Land Navigation 90%, Navigation (hardline, flying and dimensional travel) 90%, Detect Ambush 80%, Detect Concealment 60%, Interrogation 70%, and Intelligence 90%.

They are cunning military leaders with a good head for strategy, tactics and organization. They are also skilled in the art of deception, trickery, ambush, and luring prey out of hiding like the Assassin Bug.

Also see Natural Abilities.

Natural Abilities:

1. Super Bio-Energy Conversion: Fundamentally the same as the Army Ant ability, except unlike the other Bugs, the Lightning Bug can function in energy form — hover, fly, strike out with their claws and fire their bio-energy blasts! And a suicide energy attack/ram does 1D4x1000!

This energy form can be maintained for a total of 1D4x10+60 minutes per 24 hours. It takes two melee actions to adopt this energy form and the Bug must retain this form for at least two melee rounds (30 seconds) at a time.

2. Limited Invulnerability: Basically the same as the Army Ant ability. While converted to pure energy, Lightning Bugs are invulnerable to physical harm — bullets, thrown rocks, fire, and punches pass harmlessly through them. Likewise, they are impervious to gases, fumes, radiation and disease. However, explosions (and for those adopting the Bugs to other Palladium RPGs, magic and energy blasts) do one third normal damage.

The only known ways to defeat these terrors while converted to pure energy is to trap them in an Organitech "Roach Motel" or blasting the living heck out of them with explosives/missiles or rare energy weapons! A Natural 20 will with such a weapon will do its full, normal damage.

3. Machine Union: Basically the same as the Army Ant ability, except when the containment medium (machine or hardline) is destroyed, there is no chance of killing the Lightning Bug. However, the monster will be disoriented for 1D4 melee rounds, fighting with half its normal bonuses and number of attacks.

4. Bio-Energy Flight: While converted to energy, the Lightning Bug can hover and fly through the air. Maximum flying speed is 750 mph (1200 km/Mach One). Maximum Altitude is 20,000 feet (3096 m; in applicable settings: double along ley lines).

5. Bio-Energy Blasters (1): Fundamentally the same as the Army Ant when in physical form, enabling the Lightning Bug to fire an en-



ergy blast from its Bio-Energy Blaster, a strange vent-like growth on its back.

Range: 2000 feet (610 m).

Damage: 6D6 from a standard blast, but can also fire a double-strength bio-energy blast that inflicts 1D6x10+12 damage, but it counts as two melee attacks. Instead of causing physical damage with the Bio-Blaster, the creature can disrupt electronics the same as the Army Ant. **Note:** When in energy form, the slightest touch from the energy being does 2D6 damage (this damage is also inflicted upon those who touch it), and a claw strike does 5D6 damage. Moreover, it can fire energy blasts from its four hands! A single blast does 6D6 damage but the Bug can also fire a pair of simultaneous blasts at the same target to inflict 1D6x10+12 damage (three or four simultaneous blasts are not possible). This dual blast counts as one melee action/attack. In addition, the Bug can fire a single strength or double strength energy blast (counts as one melee attack when in energy form) from its Blaster at double the usual range!

6. **Dimensional Breach:** The most powerful yet least understood Lightning Bug ability is its power to sense existing dimensional portals, look through them to other worlds and travel through them. The only time several Lightning Bugs gather (5 or more) is to use their combined dimensional abilities to open a dimensional portal to another world (typically at a ley line junction or known place of magic like Stonehenge, the Pyramids at Giza, the Wyoming Medicine Wheel, and so on). When the portal is opened, they and all their Bug legions (with the exception of Silkworm Zombies), in unison, turn into their energy form, blast into the portal and vanish in the blink of an eye. This is how they travel to other worlds, with the Lightning Bugs leading them to their new destination (all of them temporarily linked via Bug telepathy and linked energy).

Some survivalists claim to have seen Lightning Bugs create miniature breaches themselves and teleport either themselves or a group of Bugs (no more than 200) from one place to another without using hardlines, but this is unconfirmed. If it is true, then humanity's troubles might not end when they finally cut America's hardlines (and it is true, but two or more intersecting ley lines are required and the Bugs can only travel to another point on that line of natural energy or a connecting junction line, or to another place of magic/ley line nexus not more than 2000 miles/3200 km away).

Note: Lightning Bugs can also sense their exact location, all connecting lines, and outlets when traveling along any line of energy, including hardlines. This means they rarely get lost (01-90% likelihood of traveling to exact location) and can lead thousands of bugs with them. All Tier 2 bugs are limited to leading roughly one hundred cohorts and only have a 01-75% likelihood of perfect travel.

Magic: None (some may consider their dimension hopping ability to be magical in nature).

Psionics: Identical to the Army Ant's abilities.

Attacks Per Melee: Five physical/hand to hand attacks or five energy attacks (each energy blast counts as one attack when in physical form). Six attacks/actions in energy form.

Damage: In physical form the Lightning Bug can stab and slash with its sword-like claws to inflict 3D6+30 (includes the P.S. Bonus) or strike with a closed fist or forearm to inflict 2D4 +25 including its P.S. bonus. A bite does 2D6 damage. It can also fire energy blasts from its back mounted blaster (see *Bio-Energy Blaster* described under Natural Abilities).

Bonuses (including attribute bonuses): +3 on initiative, +5 to strike, parry and dodge, +25 to damage, +5 to save vs poison/toxins (and magic), impervious to disease and possession, +10 to save vs Horror Factor. **Note:** The Lightning Bug is a leader and suffers no penalties when on its own. It typically leads or directs thousands to tens of thousands of Bugs like a General. It may go off on its own or with a small group of Bugs (11-110) on special missions. They are most often encountered in or around Power Centers and Bugtowns.

Average Life Span: Unknown! It may live for decades, centuries or even thousands of years. Nobody knows if the Lightning Bug (or any Tier 3 Bug) can evolve into a higher Tier (4 or 5) form. They may represent the top end of the Bug evolutionary process.

Size: 8-9 feet tall (2.4 to 2.7 m) tall.

Physical Appearance: Lightning Bugs are structured along similar lines to the Army Ant and the Killer Bee, only bulkier and blocky. They are blue with a yellow underside and deep purple eyes. They are crackling blue in their energy form.



THE HUMAN RESISTANCE

Perhaps 95% of the world population in **Systems Failure** is comprised of ordinary folks who wouldn't think they have a heroic bone in their body. Nearly half of these are in the thrall of the Bugs, either turned into Silkworm Zombies (or awaiting to be) or kept in work camps and prisons.

The rest of the surviving free folk find that the struggle just to stay alive is an epic challenge. Except for a few key human strongholds and para-military compounds (militia men and survivalists), there are no human cities and very few towns. People eke out their existence on their own or in pairs, families, clans or small groups and enclaves. Most have fled into the wilderness, away from the Bug occupied cities, although an estimated 20% still run free in the cities and towns of the USA and Canada, living like rats underground and/or in abandoned buildings and ruins, and using the cover of darkness to move around.

The majority of free people (referred to as "free thinkers" by the Bugs) struggle to make a new life in the wilderness. Only the most fortunate (less than 15%) have a permanent place to live (it is best to keep on the move) or the simplest modern conveniences. Most live like the Indians and settlers of old, living off the land and keeping on the move. Small trading posts and camps (hopefully too small to be noticed by the Bugs) are located in caves, abandoned mines, old missile silos and other concealed places. The largest are what passes for towns these days, although a few real pre-Meltdown towns still exist (inhabited by the bravest, boldest and most heavily armed survivors, or those who refuse to accept just how bad the Bug Invasion really is, or those who are just plain stupid). Tiny homesteads and concealed huts, houses and hiding places used by individuals and small groups are scattered across the wilderness in the hope that being so far apart, one won't be discovered even if the Bugs find one of their neighbors miles away. To this end there has been a mass exodus to the American Northwest and all mountainous and remote regions (upper Michigan, the southern swamp and marshlands, the parks and forests of the Carolinas, Pennsylvania, etc. — Canada's population has doubled with refugees from the US fleeing into its most desolate regions). For all these people, refugees and freedom fighters alike, there is only fear, dread, endless manual labor, harsh elements, and a chronic lack of food, resources and medical supplies. And somewhere, crawling in the background, the Bugs are slowly (and perhaps unstoppable) taking over the rest of the world. To the average person, life in the Badlands of Free North America looks bleak indeed.

It is a different story for the player characters of this game. They may have once been "ordinary" people before The Meltdown. Heck, many of them were the disenfranchised. They've always been nerds of one kind or another, outcasts, eccentric, unconventional (and unappreciated), extreme or out in left field (some would say crazy). They may still be eccentric — heck, who are we kidding, half of them are more wacky, loony, driven and fanatical than ever — but somehow the alien invasion, collapse of civilization, and the resulting challenges and hardships have brought out their inner hero! Some even thrive on it! For many, their strength lies not so much in their muscle or great genius, but in their *heart*. They possess an undying love for their country and its people. They refuse to quit, hide, commit suicide or surrender. In-

stead, they fight against an overwhelming enemy and help their lost and frightened fellow men find their way. They organize and help others while undermining and destroying the hell spawned invaders at every opportunity. In America, they share a dream to see their nation restored and its people free. Its a dream they vow to make a reality even if it means spilling their own blood. As impossible a task as this may be, their dream doesn't stop there. They vow that their Canadian and Mexican neighbors shall also be free and then, together, will fight to free the rest of the world. Madness? Perhaps, but the people of Mexico and Canada share that dream (delusion?). They've lost contact with the rest of the world for several years now, so they don't know how good or bad things are in other nations, but they believe, in their hearts, that all free people share their spirit and do what they can to fight the monstrous invaders. For those of more inscrutable virtue, there lies the absolute conviction to survive (and perhaps prosper), no matter what it takes. And if that means blasting a bunch of Bugs or Warlords along the way, then so be it.

Ironically, this resolve keeps spirits high and instills in these freedom fighters a relentless drive to extract blood revenge upon the Bugs, restore society, and make sure the fires of freedom never die! As a result, many have adopted a positive, seemingly cavalier or matter of fact, swashbuckling attitude and demeanor. Some have likened it to the gunfighters or frontiersmen of the Old West (the large number of horse riding Yahoos and self-proclaimed Cowboys only adds to this impression; horses are quickly becoming the preferred mode of transportation). Others compare it to comic book or film heroes who take the worst in stride and come out better for it, or die trying.

In a Bug-ridden and broken down world, this is the stuff of heroes. And like it or not, most player characters will find themselves considered champions of righteousness and justice, and the defenders of the weak. This goes for most selfish and even evil characters who, though self-serving and profiting from the situation (glory, power, wealth, etc.), offer (perhaps inadvertently) shelter, protection and hope!

Keep in mind, this is the Bugs' world now, and they have no use for free humans whatsoever. To them, there are three kinds of humans: "Bugged" humans (Silkworm Zombies), dead ones, and humans they would like to put in either of those two previous categories. While some survivors might prefer to hide and run from the Bugs, sooner or later, they will run afoul of them. That's just a fact of life. Consequently, these self-made heroes elect to take the fight to the Bugs and, hopefully, save and free scores of humans from their bondage and get them to stand up for themselves and join the good fight. For the time being, it comes down to Man or Bug, and that's that.

In game and story terms, players are looking at hard-hitting adventures filled with action, death-defying raids, combat, espionage, sabotage, rescue and heroics. That's one of the fun things about **Systems Failure**. It is a setting in which good, selfish, or evil folks from all walks of life might come together to work together for a common cause. The unusual alliance between good, Selfish and evil (evil joining the side of the angels, for the moment) to battle a common enemy is a dynamic plot thread. One that should be full of petty betrayals, lies, cheating, stealing and backstabbing along the way, but the bottom-line

is in this world, //humans are in this together. Of course, there will be those who try to make a profit and work some angle to become rich or powerful (for example, a trading post that charges exorbitant prices for their goods and services, or a band of thieving cutthroats who prey on Bugs and humans alike), but even they will stand on the side of humanity and goodness when push comes to shove. It will be the truly diabolic human who will let innocent people or heroes fall prey to Bugs when he or she could stop it or save them, and it is only a soulless fiend who will turn people over to the Bugs or willingly work for them.

The only other option, of course, is to give it all up to the Bugs. And any heroic character will be double-damned before they even *consider* that. So lock and load, everybody, and forget your differences (race, creed, wealth, pre-Meltdown position, etc.), no matter how severe. The Great American Bug Hunt is on!

Occupational Character Classes

In the Character Creation section, players determined their characters' pre-Meltdown background, back when they were "zero level" characters like most everyone else. Now, they have become superheroes by comparison. Exactly what *kind* of superhero depends on which one of the following eleven, basic ways of life, or Occupational Character Classes (O.C.C.s), one chooses. The options are the **Egghead**, **Exterminator**, **Freebooter**, **Grease Monkey**, **Peacekeeper**, **Sawbones**, **Splatterpunk**, **Survivalist**, **NORAD Psychic**, **NORAD Splicer**, and finally, the **Wacko**.

Egghead O.C.C.

Also Known As: Einstein, Professor, Bookworm, and Space Cadet

Even in a world as devastated as this one, invention, resourcefulness, and cutting edge scientific research continues — and the "Eggheads" are the ones doing it. Most "edgework" is sponsored by NORAD, one of the free Silicon Valley enclaves, or by a hidden, independent research facility (perhaps even one cut off deep within Bugged territory). Many Sponsored Eggheads generally stick close to their labs, crunching numbers and running experiments with little inclination to go out into the field. Besides, their sponsoring organization probably values them too highly to let them wander the Badlands looking for trouble. However, there are "Field Scientists" who use the idea of testing new designs or gathering first-hand research in the field as an excuse to go adventuring and kick some Bug behinds. Moreover, there are plenty of independent Eggheads (natural geniuses, scientists, engineers, and the self-taught curious and inventive souls) in the world. The major difference is that these "independents" are often self-made geniuses who get by with minimal equipment and laboratory facilities, typically making do with jury-rigged equipment and whatever's at hand. Their greatest source of grief is primitive and insufficient equipment and constantly running short of supplies. Most have to hire or work with adventurers to scavenge what they need or want. This makes many field scientists surprisingly rugged individuals who can handle themselves in the wild and in combat. Of course, others are absent-minded and/or clumsy. Sponsored or not, most Eggheads fall into one of two basic categories: *Debuggers* and *Professors*.

Professors are like those tweedy, pipe-smoking G-man scientists of the old monster movies who invariably save the day by designing some kooky device to defeat the evil monster menacing the nation. In Sys-



terns Failure™, this is no different. While the Debuggers figure out how to make the Net and phone lines clean, Professors work on developing conventional weapons and devices to make the Bug Hunt winnable. The most dramatic results so far have come from NORAD, which has pioneered Organotechnology, a means of genetically engineering Bug DNA to make fabulous weapons and equipment. Other research efforts are underway elsewhere, however, and the next major Bug Hunting invention might very well come from some bunker lab out in the Badlands.

G.M. Note: Space restrictions prevent us from laying out specific invention rules here, so for the time being, G.M.s and players will have to work out their own system for governing how and what kinds of devices Eggheads are capable of designing, building and jury-rigging. The simplest solution is to have beginning Eggheads doing work on existing technology, like trying to modify real life machines, soup up vehicles, modifying weapons, figuring out a way of boosting Organitech weapons' ammo capacity, or how to build a more efficient solar converter, and so on. For those of you really eager for some kind of invention rule system, check out the *Hardware section of Palladium's* superhero RPG, *Heroes Unlimited™*, 2nd Edition, which has extensive rules on the time and difficulty of inventing new weapons, vehicles, robots and gadgets.

Debuggers are the computer hackers and electronics experts of the Systems Failure™ setting. Not only can they run just about any piece of software out there, but they can probably build a system better than most pre-fab setups. These characters usually make it their life's work to free the Net, communications and the other electronic byways of the modern world from the Bugs (who control most of the world's communication and computer networks). Since Bugs have such an easy time

moving about the billions of miles of wires and cables of this world, simply snipping all the hardlines can never be enough (besides, Silkworm Zombies can repair them). To that end, Debuggers constantly toil for the "Killer App," that piece of software or gadget that will somehow make the planet's electronic nervous system uninhabitable to the Bugs. If a Killer App is ever designed (not likely, and some insist those who chase after it are on a fool's mission), it would be the first major step to cleaning the planet of all Bugs. For once they lose their ability to zap around the planet instantaneously, then they will become just as isolated as the humans they are fighting. The battlefield could finally tilt back in humankind's favor.

Egghead O.C.C.

Alignment: Any, but frequently Scrupulous, Unprincipled or Anarchist.

Attribute Requirements: I.Q. 13 or higher.

Base S.D.C.: 20

O.C.C. Abilities and Bonuses: Brainstorm (special): Once a day, the Egghead can come through with an incredible burst of inspiration or understanding that gives him some new insight or keen analysis. Most of the great inventions, solutions and revelations Eggheads have come up with are the results of a Brainstorm. Everybody has them, but not with the frequency and intensity of these guys. When faced with a problem, an Egghead character can use a Brainstorm to come up with a solution, no matter how impenetrable the problem may seem. A Brainstorm lasts for one hour +10 minutes per level. During this time, *all* intellectual skills, such as Science skills, Mechanical skills, and certain Technical skills will enjoy a +15% bonus! When in this mode, the Egghead is an intellectual giant. At the G.M.'s discretion, Brainstorming Eggheads may also learn certain secrets or "behind the scenes" information that the character might



not have been privy to otherwise, thanks to his extremely acute powers of deduction ("I don't know why I didn't see it before, but those scratches on the helicopter mean a Bug attacked it! And given the current wind trajectory and ambient magnetic energy in the air, thanks to the alignment of the planets this month, this means that the Bugs would have come from the south, no more than 20 miles from here! Let's go!").

O.C.C. Skill Programs: Debugger: Computer and Electrical Skill Program (+20% to all skills) and one other Skill Program of choice (+10%), but excluding Criminal, Military (Basic), Military Demolitions, Physical/Athletic or Weapons Proficiency.

Professor: Science and Communications or Mechanical Skill Program (+20% to all skills) and one other Skill Program of choice (+10%), but excluding Criminal, Military (Basic), Military Demolitions, Physical/Athletic or Weapons Proficiency.

O.C.C. Related Skills: The character may pick five additional skills from the following:

Communications: Any (+10%)

Domestic: Any

Electrical: Any (+10%)

Espionage: None

Mechanical: Any (+10%)

Medical: Any (+10%)

Military: Armorer (Field), Demolitions, Demolitions Disposal, Nuclear, Biological & Chemical Warfare only (+5%).

Physical: Any except Hand to Hand: Martial Arts, Assassin, Acrobatics, Boxing, Gymnastics and Wrestling. Hand to Hand: Expert may be taken, but at a cost of two skill selections.

Pilot, Basic: Any

Pilot, Advanced: Any

Pilot Related: Any (+5%)

Rogue: Computer Hacking only (+15%).

Science: Any (+20%)

Technical: Any (+15%)

Wilderness: Boat Building and Identify Plants and Fruits only.

W.P.: Any.

Secondary Skills: None initially. The character may select one Secondary Skill at levels 2, 4, 6, 8, 10, 12 and 14.

Standard Equipment: Sponsored Eggheads start with \$5D6x1,000 in research equipment and supplies, and \$500 in personal belongings or cash. Many do not own a personal weapon to start.

Independent Eggheads will start with \$3D6x1,000 in scientific gear, supplies and miscellaneous equipment and 2D6x\$10 in personal belongings and cash. 50% chance of having some kind of vehicle, be it a horse, bicycle or a beaten up car, jeep or motorcycle.

Both may have a pistol or SMG of choice and 100 rounds of ammo.

Money: Sponsored Eggheads almost never have more money than noted above nor precious metals or trade commodities on them because their sponsor takes care of that for them. Independent ones usually do not have anything much or extra because they immediately trade it for scientific equipment and supplies.

The Upside: Flat out, you're the most intelligent (and resourceful?) character of the group, and one day you might develop a secret weapon against the Bugs.

The Downside: You don't feel very comfortable with the outdoors, combat or physical fitness (even if rugged) — all the things you need to survive in this world. Better find some tough friends.

Experience Point

Requirements For the Egghead:

Level 1: 0,000 - 2,140

Level 2: 2,141 - 4,280

Level 3: 4,281 - 8,560

Level 4: 8,561 - 17,520

Level 5: 17,521 - 25,520

Level 6: 25,521 - 35,520

Level 7: 35,521 - 50,520

Level 8: 50,521 - 71,000

Level 9: 71,001 - 96,100

Level 10: 96,101 - 131,200

Level 11: 131,201 - 181,300

Level 12: 181,301 - 231,400

Level 13: 231,401 - 281,500

Level 14: 281,501 - 341,600

Level 15: 341,601 - 401,700

Exterminator O.C.C.

Also Known As: Flyswatter, Bugkiller, Pest Control

Every war has its soldiers, and the Exterminators are the best of the best when it comes to fighting Bugs. Most were soldiers during The Meltdown, but others are simply super-tough survivors who have received some training a formal military unit (such as a NORAD field command, militiamen, survivalists, etc.). Exterminators are a step up from Survivalists in terms of their military quality, for these guys aren't just scrappy gunslingers. They are specially trained killing machines who work very well in a team and can handle all sorts of military equipment, including the vaunted new Organitech Bug Zappers, Bug Bombs, and other ultra-powerful weapons.

Exterminators also have another edge: Almost every one of them has a personal grudge against the Bugs and is fanatical about destroying them. Maybe they lost a friend or family member to them (highly likely), or maybe they are super-patriots or simply have trained themselves to view the Bugs as disgusting vermin that need to be destroyed. Whatever their motivation, Exterminators hate Bugs with a passion, and that, more than anything, gives them the fire to take the battle to them. This tends to work against solo Exterminators who find themselves with a group of adventurers, for while the others may wish to go on a salvage run or to protect a small town from local bandits or Warlords, an Exterminator finds it hard to care unless it involves putting one of those "hardline hoppers" in his sights.

This also makes it difficult for NORAD Splicers and Exterminators to get along. Even though Splicers are just as committed to the Bug Hunt (perhaps even more so, since they *do* sacrifice their very humanity for the cause), Exterminators question their humanity and loyalty. After all, how can you have Bug blood in your veins and still call yourself human, let alone a freedom fighter? No, Splicers are not much better than the Bugs themselves, goes Exterminator wisdom, and the Splicer feels he knows it. Just as Exterminators would rather not work with Splicers, Splicers tend to avoid Exterminators for fear of getting clipped by "friendly fire."

Like any other military unit, each Exterminator has his or her own area of specialty, such as recon, demolitions, heavy weapons, etc., but those skilled in the use of Organitech hardware command the greatest respect and fear. Nearly all Exterminators, despite their disdain for anything to do with the Bugs, have great respect for the sheer destructive power of their hated enemy and never underestimate them. Likewise they can appreciate Organitech hardware and other high-tech gadgets used in the war against the Bugs. To the Exterminator mind set, the thought of using the Bug's abilities against it smells like sweet revenge, so they accept Organitech weaponry (Never mind that the same should be true of Splicers — Exterminators don't like having to explain their way through *that* contradiction).

Exterminators formerly affiliated with NORAD or some other fragments of the US Military will act on orders and are not likely to spend extended periods of time adventuring unless they have been given a mission to accompany, work with or recruit troops from the Badlands. Typical missions for these super-commandos include search and destroy runs on Bugged territory, raids on Bugtowns, Power Centers and supply depots, and rescue missions from "Bughouses" (where ordinary humans are either held captive and forced to serve the Bugs as slaves or awaiting Silkworm implantation), or refugees trapped in hostile Bug territory where they manage to survive but cannot escape (it's only a matter of time before the Bugs get them). Exterminators will also consider attempts at capturing Bugs for interrogation, torture, observation and research purposes, although many don't like it unless they are assured the "specimen" will be destroyed.

The vast majority of Exterminators are "independent" warriors who travel the land alone or in small groups of like-minded freedom fighters and adventurers, to wage their own personal Bug Hunt. These intense,



gun-toting heroes will fight Bugs at every opportunity short of a suicidal raid and will allow others who hate the Bugs to fight at their side. Exterminators are most famous for appearing out of nowhere to rescue people from the clutches of the Bugs (this is one of their personal, prime directives and an unspoken code among these warriors. Nothing makes a Bugkiller sadder than seeing innocent people turned in to Silk-worm Zombies). Some are also willing to help refugees find a safe haven and even give them some very basic training to fend for themselves.

Exterminator O.C.C.

Alignment: Typically good or unprincipled, rarely anything else.

Attribute Requirements: P.S. 12, P.P. 12, and P.E. 12 or higher. A good I.Q. and M.E. are helpful but not required.

Base S.D.C.: 40

O.C.C. Abilities and Bonuses: Paired Weapons, Modem (special):
The Exterminator has the Paired Weapons skill, but for modern weapons only. To get Paired Weapons for ancient weapons, the character must use a skill selection.

Using paired modern weapons, the character simply gets two firearm attacks for each melee action. Only one-handed weapons, such as pistols, machine pistols and sub-machineguns may be used for this. Shotguns, automatic rifles and single-shot rifles may be used, but they will have a -6 penalty to strike. Heavy weapons like multi-shot grenade launchers, flamethrowers, light and heavy machineguns and rocket launchers may *not* be used because they require two hands to fire with any measure of accuracy. Organitech energy weapons, however, *may* be used, but the same size restrictions apply. Only energy pistols and carbines may be used without penalty. Note: If used in the **Rifts**® setting or if the G.M. would like to include it in the **Systems Failure**™ setting, it is appropriate to give the Exterminator the special Gunfighter O.C.C. skills of *Quick Draw Initiative: Handguns & Rifles* and *W.P. Sharpshooting Specialty (but limited only to Handguns or Rifles)* as described on page 91 of **Rifts**® New West.

O.C.C. Skill Programs: Military Basic Program (+20%), Espionage Program (+10%), and Modern Weapons Program.

O.C.C. Related Skills: The character may pick five additional skills from the following:

Communications: Any (+5%)

Domestic: None

Electrical: Basic Electronics only.

Espionage: Any (+10%)

Mechanical: Any. Organitech Mechanics is fairly unusual and is only taken by those who work with or have ties to NORAD and have Organitech battlesuits.

Medical: First Aid only (+5%).

Military: Any (+20%)

Physical: Any

Pilot, Basic: Any (+10)

Pilot, Advanced: Any (+5%)

Pilot Related: Any

Rogue: Streetwise, Concealment, Find Contraband and Illegal Weapons, and Prowl only.

Science: Mathematics: Basic only.

Technical: Computer Operation, Language, Law, Photography and Literacy only.

Wilderness: Any

W.P.: Any

Secondary Skills: None initially, but the character may select one Secondary Skill at levels 3,6, 9,12 and 15.

Standard Equipment: Survival knife, one heavy weapon of choice (may be an Organitech energy weapon), and one weapon for each W.P. plus 500 rounds of ammo for each, a suit of body armor, and \$1,500 in miscellaneous military equipment.



Money: \$1D4x100 in precious metal. Exterminators like to travel light, and rarely carry tradable commodities with them, other than precious metals, guns, explosives and ammunition.

The Upside: Nobody knows and fights the Bugs better than you. And nobody is as dedicated to their destruction and the rescue of innocent humans.

The Downside: You have a bit of a Superman complex and tend to pick fights you might not be able to finish. That's okay when you're backed up by a Bugkiller platoon or gunships or heavy weapons (including explosives), but when you're on your own or with an inexperienced team of adventurers in the middle of Bug territory, being gung-ho can be a problem. Sometimes discretion is the better part of valor; a lesson rarely learned by Exterminators.

Experience Point

Requirements for Exterminators:

Level 1: 0,000 - 2,140

Level 2: 2,141 - 4,280

Level 3: 4,281 - 8,560

Level 4: 8,561 - 17,520

Level 5: 17,521 - 25,520

Level 6: 25,521 - 35,520

Level 7: 35,521 - 50,520

Level 8: 50,521 - 71,000

Level 9: 71,001 - 96,100

Level 10: 96,101 - 131,200

Level 11: 131,201 - 181,300

Level 12: 181,301 - 231,400

Level 13: 231,401 - 281,500

Level 14: 281,501 - 341,600

Level 15: 341,601 - 401,700

If anybody is going to make some money off this whole Meltdown and Bug Hunt thing, it will be these opportunists. Think of them as well-armed (and sometimes well-intentioned) merchants and snake oil salesmen who travel the Badlands looking for two things: 1) Any potentially valuable merchandise they can salvage or acquire cheap to trade for a profit (preferably of the free variety), and 2) Somebody to unload it on, preferably of the paying variety.

Freebooters are one of the few O.C.C.s that are welcomed by just about everyone because they almost always have something worth buying or trading for, as well as offering news, rumors, and entertaining yarns (usually, but not always, for free). And they know it, too. That's why you can find these hard-bitten hucksters all over Free America, pulling "inventory runs" (a.k.a. scrounging) in city ruins, burned out wreckage, ghost towns, and battle sites, on the road, and making sales stops at any crossroads, homestead, bunker, village or fortified town that will let them set up shop. Most of the time, they only stay in one place for a week or two before moving on to the next stop on their "circuit." A circuit is a pre-arranged itinerary of locations they travel to in a never-ending cycle (the best and most lucrative places to trade). Freebooters usually set up a circuit after scoping out a territory for a long while and figuring out where the choicest places for inventory runs and trading are found. Establishing a good circuit is a fast way to incredible riches, which is what being a Freebooter is all about.

Freebooters will also travel to new places, especially if rumors suggest there is an excellent opportunity for those clever enough to exploit it. Some are extremely nomadic and go wherever the wind (and smell of profit) carries them. To these wanderers, a regular circuit seems too restrictive, especially since they believe great riches and fantastic opportunity lays just beyond the next hill.

Of course, this life of travel, scrounging and meeting people can be a good thing, and it can be a bad thing. Good news first. With their ex-

Freebooter O.C.C.

Also Known As: Carpetbagger, Huckster, and MeltdownMerchant



tensive knowledge of local economics, likely scrounge sites, the best places and groups to trade with, and how and where to avoid unpleasant bandits, gangs and Warlords (not to mention Bugs), Freebooters are easily the most affluent, bold and impudent characters of the game. Their detailed knowledge of a particular geographic region (most stick within a 300 mile/480 km radius) can make them excellent scouts, guides, spies and reconnaissance agents.

Now, the bad news. A Freebooter's wealth makes him an attractive target for all kinds of trouble. And not just the garden variety highway robbers, either. Naturally, gang lords and Warlords of every stripe like to shake Freebooters down for "gratuities" and/or information or forced services ("get me this or that"), but they don't hassle them too badly. After all, they trade with these guys, too, and they want them to return some day. No, the worst danger Freebooters face, ironically, are the few remaining big fortified towns and villages they visit. Freebooters, with all their wealth and their slick talking, make enemies all over. Most of it is pure jealousy from people who are far worse off, but a good deal of it stems from losses to the Freebooter in gambling, unfair or bad trades, rip-offs, and other sleazy behavior that has made all Freebooters look bad. Most Freebooters only add to this reputation because they constantly engage in (and usually win) battles of wits and games of one-upmanship. As a result, these characters must be on their toes and try to be on their best behavior wherever they engage in trade, lest the local populace decide that they are being cheated and respond with violence. Just about every Freebooter has had his entire load confiscated and spent a few years in prison for crimes he didn't commit. Being released to the world and having to start all over is practically worse than death for these people.



Although Freebooters generally try to avoid combat, theirs is a dangerous way of life, and no self-respecting Meltdown Merchant would try making a sale without knowing how to handle himself first. As the old saying goes, "The distance between an eager customer and an armed robber is only 9 mm." As a result, these characters tend to be cool under fire and reliable in a fight. Although, if circumstances permit, they would just as soon talk or bribe their way out of trouble than go for their guns.

Most Freebooters are irrepressible hucksters, traders and gamblers. They see every item and service as having a price, and can be con-

stantly heard saying things like, "what's it worth to you?," "what will you pay?," "what will you sell it for?," "do I have a deal for you," and "I'll play you for it" (rolling dice or playing cards).

Freebooter O.C.C.

Alignment: Any, but frequently Unprincipled or Anarchist.

Attribute Requirements: M.A. 12 or higher.

Base S.D.C.: 30

O.C.C. Abilities and Bonuses: 1. **Fast Talker (special):** With this ability, the Freebooter can charm an individual or a small group of people (2D6) by temporarily boosting his powers of Mental Affinity (M.A.). This ability is used most often to get people to buy things, pay more than it's worth and to let the Freebooter out of a sticky situation. It can also be used to enable the Freebooter to weasel information out of people (usually without them knowing it) or to cut a fast deal before the other party realizes who got the best part of the deal. **Note:** This is an ability that is best "role-played" — meaning the player should act out and do some fast talking. If his character's pitch is excellent the fast talking worked, if it was pretty good but the G.M. isn't sure it was a complete sell, this is when to consider the Fast Talker skill and give the Freebooter the benefit of the doubt. If the spiel was poor and unconvincing, the Fast Talker skill does not help a bit. **Fast Talker Bonuses:** +5% to the following skills: Gambling, Seduction, Disguise and Impersonation.

2. **Appreciate True Value (special):** Freebooters make their living from scavenging, cleaning and trading or re-selling things, often for more than they are worth. Consequently, they are *very* aware of how much things should really cost, what their true condition is, and how well they will clean up (or be repaired). As such, Freebooters are -30% to be fast-talked by other Freebooters, con-artists and sales people, and they also can tell instantly what the "fair price" and "true value" of a given object is, regardless of how dirty, rusty or broken it "appears" to be. This skill also helps them know how to clean it up and repair the item to get the most value from it. So while an Exterminator might see a working jeep, a Freebooter would instantly realize if the jeep is old, broken down and likely to overheat minutes after the sale. Or in the alternative, see a grim-covered, banged up, broken down junker and recognize what will be required (and how much it will cost) to clean it up and get it working. It's just a gift Freebooters have. **Base Skill:** 60% +4% per level of experience. A skilled mechanic or mechanical engineer can also have this ability if the G.M. allows it, but the base skill starts at half for them (30% +4% per level of experience).

O.C.C. Skill Programs (special): Gambler & Huckster (+20%) plus the following skills: Armorer (Field), Basic Mechanics, Basic Electronics, Recognize Weapon Quality, Find Contraband, and Business and Finance, all at +20%.

O.C.C. Related Skills: Pick eight skills from the following:

Communications: Any (+5%), except Cryptography, Laser and Optic Systems.

Domestic: Any (+10%)

Electrical: Computer Repair only.

Espionage: Any (+5% to most, but plus 10% to Forgery, Intelligence and Disguise).

Mechanical: Automotive Mechanics, Locksmith and Weapons Engineer only (+5%).

Medical: First Aid only.

Military: Any, except Trap/Mine Detection.

Physical: Any except Acrobatics and Wrestling. Hand to Hand: Expert costs two skill selections and Hand to Hand: Martial Arts or Hand to Hand: Assassin costs three skill selections.

Pilot, Basic: Any (+10%)

Pilot, Advanced: Any except Jet Aircraft, Jet Fighter and Jet Packs.

Pilot Related: Any

Rogue: Any (+10%)

Science: Astronomy, Chemistry, and Mathematics: Advanced only.

Technical: Any (+15%)

Wilderness: Any (+5%)

W.P.: Any

Secondary Skills: None initially, but the character may select one Secondary Skill at levels 2,4, 6, 8,12 and 15.

Standard Equipment: A survival knife, pocket knife, a rifle or shotgun and one weapon for each W.P., plus 1D4x100 rounds for each. The character will also have a backpack, large duffel bag or satchel, several sacks (large and small), sunglasses, pocket signal mirror, two canteens, 1D4 bottles of whiskey or moonshine, a gas mask and \$1D6x100 in personal gear.

01-50% chance of having a horse, mule or beaten-up vehicle of some sort to haul his "inventory." Pack animals, jeeps and light trucks or vans are most popular.

Money: \$3D6x100 in tradable goods, from soaps and colognes to food and cigarettes, to tools, guns and ammo. Actually, just about anything he thinks he can sell or trade. This is the character's starting "inventory."

The Upside: You're the only guy who's going to make any money off this sorry mess and people love you because you're the candy man. The clever and charming (at least in his own mind) scrounger and trader. The guy or gal with what they need and want. Everybody's friend (at least when they need something).

The Downside: Most people see you as a necessary evil. Not necessarily a bad guy, but a gambler and an opportunist who trades on the misfortune and desperate needs of others. You're not known for your loyalty either, so people don't really trust you. Consequently, you're the big man (or lady) when you have what people need, and a low life bum that is ignored and shoved aside when down on your luck. Even in the best of times, your relative affluence makes you a prime target for the many brigands and thieves who populate the world or those jealous of your good fortune or cunning. Better find some bodyguards or traveling companions (some adventurers you can charm into being your buddies, at least for a while, are always handy).

Experience Point

Requirements for Freebooters

Level 1: 0,000-2,000

Level 2: 2,001 - 4,000

Level 3: 4,001- 8,200

Level 4: 8,201 -16,400

Level 5: 16,401 - 24,500

Level 6: 24,501 - 34,600

Level 7: 34,601 - 49,700

Level 8: 49,701 - 69,800

Level 9: 69,801 - 94,900

Level 10: 94,901 - 129,000

Level 11: 129,001 - 179,100

Level 12: 179,101 - 229,200

Level 13: 229,201 - 279,300

Level 14: 279,301 - 329,400

Level 15: 329,401 - 389,500

Grease Monkey O.C.C.

Also Known As: Handyman, Motorhead, Tommy Toolbox

After The Meltdown, a lot of available machines, electronics, and devices became scarce. Worse, what little technology that still worked suddenly became unusable for an entirely unforeseen reason: electronics were susceptible to the Bugs. Able to deactivate or take control of *any* electrical device, the high-tech tatters of the Information Age were all too primed for Bug infiltration and control.

Nearly ten years later, Free America must survive on low technology — the kind of machinery that was prevalent before the electronic age exploded after World War II (what little advanced electronics and vehicles that exist are used with great risk and much care). The problem became, how did one find technology that's 60 years old, much less service it? Survivors of The Meltdown and Bug Invasion had to be tough and resourceful, but initially, they didn't know all that much about retro-technology. That's where the Grease Monkeys came in.



In the old days, they were something of a quirky anachronism. But today, they have become real life-savers. These guys are those crusty old mechanics who have always been around, and young, hands-on do-it-yourselfers who seem to know how to fix just about every old device there is, and somehow, they always manage to have, or can get, the right spare part or improvise and jury-rig something. "Oh, yeah," they say, tilting their head back so they can examine some doohickey through the bottom of their bifocals. "I got the part you need. Lemme get it from my truck." Lo and behold, 10 minutes later, the Grease Monkey retrieves some weird component nobody has ever seen before, let alone ever used, and uses it to fix whatever it was that was broken.

Like Freebooters, Grease Monkeys are constantly on the go, but unlike Freebooters, most are actually welcomed where they go. After all, lots of times, a person's machinery stays broken until a Grease Monkey happens by and fixes it. Consequently, people have learned to appreciate these guys. They are also one of the few O.C.C.s who bandits and Warlord gangs won't usually hassle too badly, mainly because they probably have need of the Grease Monkey's skills. Moreover, traveling mechanics rarely have much of genuine value other than some tools, their truckload of spare parts, food and basic survival gear — mostly stuff bandits have little or no need for, or wouldn't know what to do with if they had them. Better to leave the 'Monkey alone and pay him a little for his trouble.

Which isn't to say that these characters don't find their fair share of trouble; they do. For whatever reason, Grease Monkeys have an uncanny knack for finding themselves in the wrong place at the wrong time, perpetual victims of bad timing. It's probably the same force that enables them to find the myriad spare parts they collect that consistently puts these affable folk in the line of fire. While some learn how to handle themselves in a firefight as a contingency, others (particularly the older Grease Monkeys) simply shake their heads at all the chaos around them and wonder how they're *ever* going to fix all the broken things that will be around when the fighting is over.

Grease Monkeys are like the country doctors of mechanics. They travel the Badlands in their trucks filled with spare parts, servicing machines for fair trade. Fair trade can include precious metals, supplies, tools, food, a safe place to sleep and spare parts — they are always scrounging for spare parts (and often stuff that other people might consider to be junk). The skills and talents of the Grease Monkeys are in high demand. While they use them to survive and make a reasonably good living, most charge fair prices, often much less than their service is really worth. Most realize that people are on hard times, so they try to be fair, often working for what somebody can honestly afford to pay rather than what the job is really worth. Sometimes they do it for free, just to be nice or to lend a hand, or to support the freedom fighting cause, or just because they like somebody. Ultimately, working on machines is what they like to do, so if their stomach is full and there isn't paying work, they'll tinker and putter around to fix things.

The uncommon generosity and kindness displayed by most Grease Monkeys has earned them a special place in the hearts of most good common folk (as well as manipulative people). If the Grease Monkey fixed a generator or tractor in the past for free, or for very little, the person/family/group he helped is likely to forever remember his kindness. For getting a vehicle, farm machinery, generator, radio or other machine fixed can often be the difference between prosperity or hardship; sometimes life and death. As a result, they will often give him little tokens of their appreciation for months, even years to come. Things like a bottle of jam, some freshly picked fruits or vegetables, a sandwich, drinking water, a place to sleep (even if it's only the barn), and spare parts they happened to come upon. The Grease Monkey politely accepts it all (even spare parts that are nothing more than junk), with a smile and a the tip of his hat (dumping any junk where it won't be found). In turn, this endears the people the mechanic has helped and creates something of a symbiotic relationship between them, because the Grease Monkey is more likely to help those who have shown him *genuine kindness* in the future, at low prices or for free.

Of course, not all are helpful and compassionate. Some are extremely mercenary and use their abilities and the desperate needs of others to extort huge payments or positions of power. They are not well liked nor given small gifts or shown favors, but they are a necessity so their greed and demands must be met (or another mechanic found). Occasionally, such hard bitten and mercenary characters find themselves battling with rivals, and some will lie, cheat and kill to hold on to their power base.

While many Grease Monkeys are a little older than other adventurers (42 +2D6 years of age), not all of them are. Indeed, as the dust from The Meltdown clears, a new breed of Grease Monkeys have emerged, learning almost all of their abilities to analyze and fix uncooperative retro-tech from the old masters themselves. These new mechanics do not remember the old days before the Information Age, but they have adapted quickly to the old technology, so as the older Grease Monkeys fade away, their legacy shall live on.

Most Grease Monkeys have something of a Luddite attitude towards "modern" technology, and as such, they don't like to use Organitechology or salvaged computers or other electronics. They consider that stuff "new-fangled," "buggy" and "untrustworthy." After all, none of it survived the crash, did it? Not without being "bugged" or waiting to be bugged. "And you never saw no Bug crawl out of a flat-head screwdriver, did you?" This attitude can also extend to include people of particular O.C.C.s too, like the Egghead and the Exterminator. The Egghead is viewed with distrust because many scientists are prone to lose sight of what's important and/or take foolish risks in their pursuit of knowledge ("Don't study or admire the damn Bugs, kill 'em"). Grease Monkeys aren't usually too thrilled with some of the new-fangled mechanisms these guys whip up either ("It's back to basics, boys. You're just making things more difficult than they need to be"). The NORAD Exterminators are of concern because they are using fire to fight fire when it comes to Organitech and it only encourages people like the Eggheads to make more. Grease Monkeys don't cotton to the idea of cozying up with the Bugs or anything about them ("Kill 'em, don't try to be like 'em"). Thus, the typical Grease Monkey watches himself around them the same as he would a brigand or gangster, and often just shakes his head and keeps on driving in search of the next town or village or way station that needs something fixed.

Grease Monkey O.C.C.

Alignment: Any, but the majority lean toward good (40%), unprincipled (20%), and anarchist (20%).

Attribute Requirements: I.Q. 10 and P.P. 10.

Base S.D.C.: 30

O.C.C. Abilities and Bonuses: Jury-Rigging (special): Grease Monkeys typically carry with them large collections of spare parts, wire, duct tape and components to use in fixin' — enough to fill the cargo bay of a wagon or small truck. As long as they have access to their stockpiles, Grease Monkeys have a +15% bonus to any Mechanical or Electrical skill roll (in addition to the +20% bonus Grease Monkeys already get to their O.C.C. Skill Programs). When these guys are in their element, they are the best at what they do. Note: A Grease Monkey's collection of spare parts and pieces have little value to anyone except another Grease Monkey. Self-respecting mechanics never part with their component stockpiles. It would be like a soldier giving up his gun. Another facet of this ability is that Grease Monkeys can all perform the General Repair skill at 85%. This success ratio does not go up as the character advances.

Scrounging (special): Grease Monkeys also have a base chance of finding any spare part they need (or alternatively, \$1D6x100 in salvage) whenever they come across a deserted town, the ruins of a city, or destroyed mechanical hulk. If there's something of worth, these guys will find it, strip it, and chuck it in the back, with all their other stuff. **Base Skill:** 50% +5% per level of experience.

O.C.C. Skill Programs: Electrical Program (+20%), Mechanical (General) (+20%) and Mechanical (Vehicular) (+20%).



O.C.C. Related Skills: Select six others from the following categories:
 Communications: Any except Laser and Optic Systems (+5%).

Domestic: Any

Electrical: Any (+15%)

Espionage: Detect Concealment and Pick Locks only.

Mechanical: Any (+15%)

Medical: First Aid only.

Military: Armorer (Field), Camouflage, Demolitions (all), and Recognize Weapon Quality only (+10%).

Physical: Any, except for Hand to Hand: Assassin, Acrobatics and Gymnastics. Hand to Hand: Expert costs two skill selections and Hand to Hand: Martial Arts costs three skill selections.

Pilot, Basic: Any (+10%)

Pilot, Advanced: None

Pilot Related: None

Rogue: Any except Computer Hacking, Prowl, Seduction and Ventriloquism (+5%).

Science: None ("Never was any good at that New Math").

Technical: Business & Finance, General Repair (Maintenance), Law (General), Literacy and Photography only.

Wilderness: Any

W.P.: Any except energy weapons ("I don't want nothin' to do with those doohickies, no-how").

Secondary Skills: None initially. The character may select one Secondary Skill at levels 3, 6, 9, 12 and 15.

Standard Equipment: Some kind of basic ground vehicle, usually a jeep, light truck or van, with the cargo area loaded with a motley assortment of spare parts and mechanical junk. The character also starts with one weapon of choice (excluding Organitech and heavy weapons) and 100 rounds of ammunition (shotguns and basic rifles are a preferred choice), a portable tool kit, a large tool kit and acetylene torch kept in the truck, flashlight, utility belt, work overalls, and \$1200 in equipment and personal gear.

Money: The character also begins with \$1D4x100 worth of precious metal and \$3D6x100 in tradable goods.

The Upside: You can fix just about anything (or so you'd like to think), provided it's not electronic or too advanced. Which is just as well, because you never trusted that new-fangled stuff anyway. Peo-

ple need and respect you, and many treat you like a celebrity. Money and trade is excellent too, but mainly you like being needed. The Downside: You're not particularly combat-oriented and people often expect miracles from you when you're only human (well, mostly). This can make people ornery when you can't help them (amazing how many folks can not take no for an answer). And a lot of unsavory types regard you jealously and sometimes abuse or steal from you. Your favorite topics are mechanics, cars, racing and sports, which can limit your range of conversation.

Experience Point

Requirements for Grease Monkeys:

Level 1: 0,000-2,000

Level 2: 2,001 - 4,000

Level 3: 4,001-8,200

Level 4: 8,201-16,400

Level 5: 16,401-24,500

Level 6: 24,501 - 34,600

Level 7: 34,601 - 49,700

Level 8: 49,701-69,800

Level 9: 69,801-94,900

Level 10: 94,901 -129,000

Level 11: 129,001 -179,100

Level 12: 179,101-229,200

Level 13: 229,201 - 279,300

Level 14: 279,301 - 329,400

Level 15: 329,401 - 389,500

Peacekeeper O.C.C.

Also Known As: Wyatt Earp, John Q. Law, Gunfighter, Law Man and Boonie Cop

The world is in ruins, that's for sure, but it isn't anarchy everywhere. There are plenty of small fortified towns that have held out against the casual incursions of the Bugs as well as the various bandits and Warlords of the land, especially in the West. Most "civilized" places keep things that way through the efforts of a Peacekeeper — a self-made lawman, usually elected or appointed by the people, who stands for truth, justice, and restoring social order to the Badlands. Most Peacekeepers have little interest in the Bug Hunt. They figure while freedom fighters, militias and NORAD are taking the battle to the Bugs, somebody needs to keep an eye on the people of small town America. Free America is plagued by all sorts of vermin other than the Bugs, like hundreds of petty Warlords, thousands of gangs, thieves and cutthroats, and all manner of lawlessness. Thus, while a Peacekeeper won't back down from a Bug, their duty is to the people and their dream is to restore justice, peace and civilization. Being poor and even homeless is no excuse for doing evil. It is the Peacekeeper's personal mission to see that justice is served, evil is punished, and those who would prey upon the weak and innocent are rooted out. This world has gone without law and order for too long, and it's time the banner of justice flies proudly once again.

There are two basic types of Peacekeeper; *Town Marshals* and *Badland Vigilantes*. Town Marshals are the more common type of Peacekeeper. They have probably lived in one particular region most of their lives, and now that they have become a hero, they have taken up arms to enforce the law and protect their fellow citizens from would be kings, looters, brigands, thieves, madmen, and Bugs. Most Town Marshals fall into their job, usually by finding themselves in a dangerous situation (such as watching marauders attack their town) and having both the guts and the ability to stand up to the villains and send them packing. After that, there is no turning back, for once the people know they have a true hero in their midst, there is little else to say. Not surprisingly, Town Marshals are devoted to keeping their jurisdiction safe and sound. Most of the time, a Marshal merely makes sure all travelers



know what the rules are as they go by. Any troublemakers are rooted out and brought to justice or sent packing, provided they aren't intercepted and driven off before they ever hit town.

What these characters lack in formal training, they make up for with passion and pure guts, and it's a rare Warlord who will want to pick a fight with a seasoned Marshal. In a world where respect can only be bought at the business end of a gun, Town Marshals still have what it takes to make even the hardest survivor tremble with respect or fear. Maybe it's their no-holds-barred attitude, or maybe their tendency to respond to danger quickly and with extreme prejudice. Many shoot first and ask questions when they feel like it. Or maybe it's the aura of confidence they exude, a certainty that somehow, someday, things *will* return to normal, starting with their jurisdiction.

The second type, **Badland Vigilantes** or **Gunfighters** are something of an offshoot from the Town Marshal, but are more like the Gunfighters of the Old West. A great number of Vigilantes are ex-Marshals who for one reason or another, have given up that role to become something of a wandering Paladin or gun-for-hire. Chances are, they were either kicked out of their position or they lost it when their town got destroyed. Those kicked out of their job are often dismissed for being too aggressive and brutal, or extreme in the execution of their duties. Others may have simply violated the people's code of conduct or sense of ethics one too many times. For still others, the Badlands Vigilante or Gun-for-Hire becomes the wandering hand of vengeance after losing their community to the Bugs, bandits or Warlords. And some were once bandits, mercenaries or budding, young Warlords themselves when some event or revelation changed their dispassionate view of life and made them better (though often tortured) souls.

Whatever the circumstance, such men and women tend to be hard-bitten, post-apocalypse ronin — Peacekeepers who failed to protect the people who placed their trust in them or have lost face, and who now hope to make amends for their past transgressions or failures. They hope to erase their disgrace by riding throughout the land and helping those in need. Many are tragic figures searching the world and fighting their own inner demons as well as the Bug invaders and desperados in an attempt to make peace with themselves and find some measure of redemption for their past.

As Vigilante Peacekeepers wander the land looking for wrongs to put right, they often fall in with adventurers, patriots, defenders and other gunfighters. These affiliations can last the breadth of an afternoon, week or years depending on the circumstance and the people involved. Sometimes, small groups of Vigilante Peacekeepers band together for brief periods of time, like knights-errant of old, taking on the worst evils of the land as a small, elite strike force of great courage and power. Whenever crews like these form, Warlords and even remote Bug outposts get nervous, because you never know when they might come looking *for you*.

Even when working solo, Vigilante Peacekeepers often pick fights with tyrant Warlords and brigands, just as they often help those in need, regardless of the odds. While some would regard this as bravery, others might more accurately describe it as a kind of death wish shared by most of these vigilantes. It is almost as if some feel they can not find redemption or make amends for past failings unless they make the ultimate sacrifice of their lives. Provided they meet their maker in the performance of their sworn duties to uphold truth, justice, and honor.

Peacekeeper O.C.C.

Alignment: Good or Selfish alignments only! Marshals tend to be predominantly Principled and Scrupulous, while Vigilante Peacekeepers are more likely to range from Scrupulous and Unprincipled to Anarchist.

Attribute Requirements: M.A. 12 and P.P. 12 or higher. A high I.Q., M.E. and P.E. are helpful too, but not a requirement.

Base S.D.C.: 35

O.C.C. Bonuses: +1D4 to M.A., +1 on initiative, +2 to disarm, and +3 to pull punch.

O.C.C. Abilities: Intimidation & Reputation (special): The occupation comes with a certain stigma and creates an element of fear, particularly among Bugs, criminals and evildoers. This aura of fear and violence gives the *known* Gunfighter a Horror Factor of 9 +1 to the H.F. at levels 4, 6, 8, 11, 13 and 15.

Moreover, three times a day, the character can boost his powers of *Mental Affinity (M.A.)* for the purposes of intimidating others. When the Peacekeeper uses this force of will and stern glare (often referred to as "eye-balling" somebody), his chances to intimidate others as dictated by his M.A. are +30%. If the character's M.A. is not exceptional to begin with, then he gets the equivalent of an M.A. of 20. Those intimidated by a Peacekeeper will seriously consider backing down (most will). Those who press forward will be unnerved and lose initiative for a melee round as well as their next melee attack. Plus, anybody unfriendly toward the Peacekeeper who witnesses this ability being used must save vs Horror Factor.

Quick Draw? Note: If used in the **Rifts®** setting or if the G.M. would like to include it in the **Systems Failure™** setting, it is appropriate to give the Peacekeeper the special Gunfighter O.C.C. skills of *Quick Draw Initiative: Handguns & Rifles* and *W.P. Sharp-shooting Specialties (all 3)* as described on page 91 of **Rifts® New West**.

O.C.C. Skill Programs: Police/Law Enforcement Program (+20%), Modern Weapons Program, and one other Skill Program of choice (often the Military, Espionage, Gambler or Criminal Program).

O.C.C. Related Skills: Select six skills from the following:

Communications: Any (+5%)

Domestic: Any

Electrical: Basic Electronics and Computer Repair only.

Espionage: Any (+10%)

Mechanical: Basic Mechanics only.

Medical: First Aid only.

Military: Any (+10%)

Physical: Any except Hand to Hand: Assassin. Hand to Hand: Martial Arts costs only one skill selection.

Pilot, Basic: Any (+5%; +10% to Horsemanship).

Pilot, Advanced: Helicopter only.

Pilot Related: Any

Rogue: Any (+10%; "It takes a thief to catch a thief).

Science: Math and Astronomy only (+10%).

Technical: Any (+5%)

Wilderness: Any (+5%)

W.P.: Any

Secondary Skills: None initially. The character may select a Secondary Skill at levels 3, 6, 9, 12 and 15.

Standard Equipment: A rifle or shotgun, survival knife, and one weapon for each W.P. plus 100 rounds for each. The character also starts with \$1D6x1,000 in miscellaneous gear, including such items as a suit of body armor, mace or pepper spray, handcuffs/manacles and a truncheon/billy club. He also has a motorcycle, jeep or horse provided he has the appropriate Piloting skill.

Money: \$2D4x100 in precious metal and/or tradable goods.

The Upside: You're a good fighter, honorable, dedicated to helping others, got plenty of weapons, and have a reputation that bad guys actually fear. The common folk think of you as a hero, and wherever you go, good folks are likely to offer you food, basic supplies, help and shelter.

The Downside: That reputation thing also makes you a likely target for bandits, Bugs, gang lords, and Warlords. Wherever you go, there is likely to be somebody who sees you as trouble to be eliminated. All too often there is a punk with a gun who wouldn't mind jumpstarting his own rep by being the guy who bumped you off, either. You're tired of fighting and killing, but you press on, because you represent hope to thousands. Wherever you go, the innocent and downtrodden are likely to plead for you to help them right some wrong, avenge some injustice or fight some terrible evil. The silver lining: You think of that as job security.

Experience Point

Requirements for Peacekeepers:

Level 1: 0,000-2,140

Level 2: 2,141-4,280

Level 3: 4,281-8,560

Level 4: 8,561-17,520

Level 5: 17,521 - 25,520

Level 6: 25,521 - 35,520

Level 7: 35,521-50,520

Level 8: 50,521-71,000

Level 9: 71,001 -96,100

Level 10: 96,101-131,200

Level 11: 131,201- 181,300

Level 12: 181,301-231,400

Level 13: 231,401-281,500

Level 14: 281,501-341,600

Level 15: 341,601-401,700

Sawbones O.C.C.

Also Known As: Medicine Man, Fixemup, & Frankenstein

There always is a need for doctors, especially in a world as savage and war-torn as this one. Without many hospitals or clinics to use, medical care has declined seriously in the last decade, but the heroic efforts of these field medics and travelling healers keep many people alive when they would have otherwise given up the ghost. Sawbones are one of the few O.C.C.s valued equally by humans and Bugs, for both have a need to keep humans alive.

Most Sawbones practice medicine for the love of helping the sick and wounded, and as such, they tend to perform their skills on whoever needs them at little or no cost. It hasn't taken long for news of this general code of conduct to spread throughout the Badlands, making a Sawbones an enthusiastically greeted visitor to nearly any community. As a show of appreciation, most people, even those who don't currently have need of a doctor, will give their (potential) benefactor what they can to earn his favor or pay for his services. This ranges from a hot meal and a warm bed for the evening (or as long as he or she would like to stay), to jars of preserved food, fresh fruit or vegetables, a horse and buggy (or vehicle), free repairs, and highly tradable goods, such as gasoline, ammunition, or even small bits of Organitechnology, depending on how wealthy the patient was and how much care the Sawbones provided. On the flip side, seeing that they need to make a living somehow, Sawbones have learned how to accept such offerings gracefully, but only the most mercenary expect or demand payment for their services.

The downside to being a Sawbones is that the Bugs are also interested in them to help maintain slaves and tend to Silkworm Zombies injured in combat or on the job. Thus, Bugs patrol the Badlands specifically looking for Sawbones to capture and condemn them to a life of constant medical service to an army of Drones. What makes this really difficult is that Silkworm Zombies usually retain most of their memories, so if a zombie was visited or knows about a Sawbones in its past life, then the Bugs will use that information to track down the doctor. That is why, as much as a Sawbones would love to stay in one particular place and serve its people, he or she must move on or risk bringing the Bugs upon him and the people around him.

The most common type of Sawbones out there are **General Practitioners** who can treat most any malady, but are limited by the equipment and facilities they have access to. There are a few advanced centers of medicine here and there throughout Free America, where a Sawbones can really do some wonders (like treat pneumonia or reattach a lost limb) but for the most part, these characters are restricted to mostly field medicine, the kind of care one might expect to find during the Vietnam War — treat most diseases, deliver babies, stop bleeding,

basic surgery, remove shrapnel, amputate a limb, set broken bones, administer drugs, and perhaps offer some words of comfort. It is a lonely and frustrating life for these characters, knowing that there is so much more they could do for their patients if only they had the medicine, proper equipment and the opportunity. Still, they keep on healing, never quitting the struggle to make life more bearable and pain more transitory.

A specialized offshoot of the Sawbones is the **Wormkiller**, doctors who specialize in surgery (+10% to surgeon skill, but -10% to diagnostic abilities) and the study of Bugs (only about 20% of the doctors are Wormkillers). These characters have devoted themselves extensively to the study of the subspecies of Bug known as Silkworms, the "Brain Grub" used to overwrite the human brain and turn people into zombies. Such unfortunate victims are considered Bugs, not humans, since their original personality (some say soul) is destroyed and replaced by the Silkworm riding in the skull. The human body is nothing more than a shell to provide nourishment and movement. Most of the captured human populace has not yet been "Bugged," but, there are millions of humans who have been and millions more await the grim fate. Wormkillers find this aspect of the Bug invasion particularly vile, and they are convinced that there must be some way to remove a Silkworm from its human host without killing the individual person. It was a Wormkiller who discovered that the vile Silkworm can be removed with minimal brain damage if done within the first eight hours of being impregnated, and sometimes up to 14 hours after impregnation. Unfortunately, after that, all attempts to remove the Grub without lobotomizing or killing the human have proved impossible, but these Sawbones keep trying. Consequently, Wormkillers often organize kidnapping parties to venture into Bugged territories and capture as many Bugged humans as they can for study and experimentation. Some find this gruesome, but to the Wormkillers, there is no other way to save these poor, Bugged humans. As their dedication to life suggests, *any* human (Bugged or not) is worth saving. The doctors of the world owe them at least that much. Note: Most General Practitioners can also remove a Silkworm thanks to medical literature shared and distributed by other Sawbones, but they are less comfortable with the procedure and scarring is more likely (another -1 to permanent P.B.).

Sawbones O.C.C.

Alignment Restriction: Good or Selfish alignments only. Evil characters generally are more interested in causing suffering (or are indifferent to it) than they are in relieving it and may include torturers and field doctors for criminal gangs and Warlords, occasionally traitors willingly working for the Bugs.

Attribute Requirements: I.Q. 12 and M.E. 12 or higher. A Wormkiller must also have a P.P. of 12 or higher.

Base S.D.C.: 20

O.C.C. Abilities and Bonuses: Walking Sanctuary (special):

Sawbones are one of the truly treasured people in this world, by Warlords and Bugs alike. Thus, there is a general understanding that Sawbones are not to be hurt unless they decide to take part in a fight. As a result, enemies who know the character is a Sawbones will be unlikely to attack or molest him. Only diabolic characters or those who don't realize the character's vocation will take a shot at him. Many will try to avoid killing a Sawbones even if he is actively fighting them; they are just too uncommon and valuable a resource. This applies to Bugs, too, who need Sawbones to keep their zombies alive. However, this also makes Sawbones very attractive targets for capture and extortion ('help us or these people die or will be turned into zombies'). Note: Most Sawbones are unlikely to abuse their privileged status by using it to take cheap shots at the enemy, so if they engage in combat they know full well that they could be killed. Those who try to exploit their unofficial special status quickly become branded as cowards and find their Walking Sanctuary status curiously revoked as word spreads like wildfire of a lily-livered Sawbones who likes to cap people off with impunity.

O.C.C. Skill Programs: Medical Doctor Program (+20%), Medical Assistant Program (+10%) and one other Skill Program of choice (typically Science).

O.C.C. Related Skills: Select six skills from the following:

Communications: Radio: Basic and Read Sensory Equipment only.

Domestic: Any (+10%)

Electrical: Basic Electronics only.



Espionage: None

Mechanical: Basic Mechanics and Automotive Mechanics only.

Medical: Any (+15%)

Military: Nuclear, Biological and Chemical Warfare only (+10%).

Physical: Any except Hand to Hand: Martial Arts, Hand to Hand: Assassin, Acrobatics, Gymnastics or Boxing.

Pilot, Basic: Any (+5%)**Pilot, Advanced: Helicopter only.**

Pilot Related: Navigation and Read Sensory Equipment only.

Rogue: Cardsharp, Palming, Streetwise and Seduction only.

Science: Any (+10%)

Technical: Any (+10%)**Wilderness: None**

W.P.: Any except for W.P. Heavy and W.P. Energy Weapons ("You know, if there were fewer of *these* things around, there would be less need for people like me").

Secondary Skills: None initially. The character may select one Secondary Skill at levels 2, 4, 6, 8, 10, 12, and 14.

Standard Equipment: Full medical and surgical kit, 1D4 boxes of disposable surgical gloves and surgical masks (Four Corners is the only place that still manufactures them in Free America), survival knife, hand axe, and pistol with 100 rounds.

Money: \$2D4x100 in precious metal and \$2D6x100 in tradable goods.

The Upside: You're a healer and a bringer of life respected by all. Your skills are in extreme demand, so wherever you go, you're likely to receive V.I.P. treatment.

The Downside: The wrong people also need your skills. Maybe those Warlords you are treating don't want to pay you. Maybe they'll just capture you and force you to perform free medical work forever. Guess that's better than working as a slave helping the Bugs. Maybe they will let you go. Most do ... or so you tell yourself.

Experience Point**Requirements for Sawbones:**

Level 1: 0,000-2,000

Level 2: 2,001 -4,000

Level 3: 4,001-8,200

Level 4: 8,201-16,400

Level 5: 16,401-24,500

Level 6: 24,501 -34,600

Level 7: 34,601 - 49,700

Level 8: 49,701 -69,800

Level 9: 69,801-94,900

Level 10: 94,901 - 129,000

Level 11: 129,001- 179,100

Level 12: 179,101 -229,200

Level 13: 229,201 - 279,300

Level 14: 279,301 - 329,400

Level 15: 329,401 - 389,500

Splatterpunk O.C.C.

Also known as: Bulletboy, Gunslinger and Anarchist.

The words "splatter" and "punk" pretty much sum up these lowlifes. The worst are murderous criminals, the majority wild, gun-toting yahoos who don't think law and morality applies to them. They have thrived on the chaos and have had a ball the last 10 years. They first came out during The Meltdown, when the wave of anarchy that swept the world seemed to bring out the worst in everyone. The anarchists of the world never seemed to get the "rioter" mentality out of their system, and now they have become the brigands, mercenaries and would-be petty kings (Warlords) of this shattered world. Heavily armed and with nobody to tell them what to do, Splatterpunks engage in intimidation, extortion, racketeering, looting, pillaging, murder and generally terrorizing Free America. Anarchists generally fall into one of three categories: *Warlords*, *Vultures* and *Drifters*.

Warlords are the least numerous but most dangerous type of Splatterpunk. They are the tyrant kings and gang lords who claim a stretch of land as their "turf" and rule it through brutality. All who live or travel on their "turf" must answer to the Warlord and his men, paying tribute and showing respect (i.e. groveling before them). They are especially active in rural areas where the Bugs are not active and where there are not many fortified towns or freedom fighter patrols. Here, they tend to gather together in large groups of 50-500 and establish small kingdoms for themselves. They enforce their rule with an iron fist, using intimidation, strong-arm tactics, torture, violence and murder (often wholesale slaughter). Those who dare to defy or disrespect them are targeted as enemies who must be made to pay (beaten, humiliated and robbed or destroyed).

As dangerous and cruel as Warlord armies can be, they are no match for a properly trained force of NORAD soldiers or independent militia, and will run or disperse if faced with such hardcore opposition. Warlord gangs can also be found on the highways of the Western states in souped-up vehicles salvaged from the hundreds of war and riot ravaged cities and towns that dot the landscape, or on horseback. These mobile raiders attack travelers, homesteaders, towns, and even well armed adventurers, mercenaries and NORAD squads or platoons. They represent the single greatest reason for why so few merchants and military patrols use the major roadways in the west anymore — tangling with Highway Warlords simply isn't worth the risk. Not when you can take back roads, country trails, or go by air.

Vultures live among the ruins of a once-proud America, usually sticking to the burned-out cities and ghost towns, where they pick through the rubble in search of worthy salvage. Ace scroungers and packrats, Vultures are by nature thieves, con men, and bandits. While most would rather fleece their victims by guile and subterfuge, or rob them in their sleep, rather than use outright force, most are not afraid to use violence to get what they want. These career criminals are not to be trusted. They will rob, steal, cheat, backstab and betray strangers at the drop of a hat if it is profitable for them (betraying a friend usually gets a momentary qualm of conscience before the Vulture shoves it aside and moves forward with his treachery). Vultures are brigands and cutthroats who make the ultimate thug mercenary, willing to sell anybody out for a price or consider any job if it pays well enough. Their sly methods and treacherous nature make them well suited for slipping into Bugged territory to obtain something of value, or to engage in spying, and getting out without being noticed. This makes them excellent, if untrustworthy Bugtown scouts, a skill they will gladly sell to the highest bidder. (Helpful Hint: Be sure to tip these guys well along the way, lest they decide to leave you high and dry in the middle of your quest.)

Drifters are typically spirited, devil-may-care adventurers (often under the age of 25) who see the world as one big free-for-all. They tend to ignore laws, have low moral fiber and do as they please, come hell or high water. Others are burnt-out gunmen or loners who have lived through enough mayhem and destruction to last ten lifetimes, but it's the only life they know. Most have little to no respect for the law and authority and don't like having any obligation to anyone or anything, living purely for themselves (although not necessarily at the expense of others). Thus, they drift from place to place, living by cunning and getting along by the seat of their pants. While most will consider doing whatever they can to stay alive, the majority are *not* criminals or cutthroats. Some sell their combat skills as mercenaries, guards, and even (temporarily) as lawmen. Others work odd jobs for a meal and housing or some fair trade goods, and then move on. Of course some do fall into a life of crime and villainy like Warlords and Vultures, but few are rapists and murderers. Ironically, Drifters generally have a high regard for life (if not their own) and many live by their own code of honor, similar to the Cowboy's Code of the Old West. Many have seen so much pain and injustice that they simply refuse to contribute to it, and many Drifters find themselves unable to turn down a person in need. Although many put on a cavalier or tough-guy front, they remember what it was like to care about others and more often than they'd

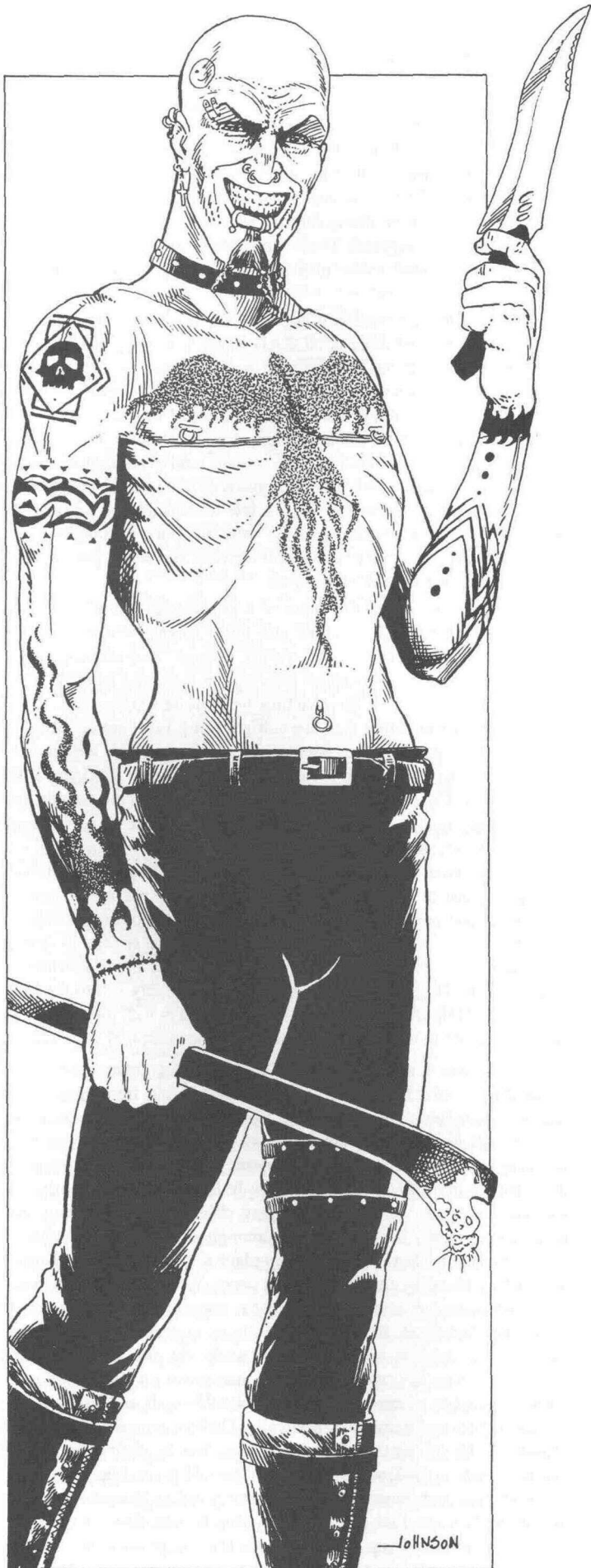

like, find themselves unlikely heroes fighting for people and justice on the back roads of America.

No self-respecting Splatterpunk, from Warlord or Vulture to Drifter, has any love for Bugs. Most gladly kill these inhuman invaders whenever the opportunity arises, and Drifters, in particular, often find themselves drawn into the crusade to drive the Bugs from the Earth, and rescuing innocent people in their clutches.

Splatterpunk O.C.C.

Also Known As: Bulletboy, Gunslinger and Anarchist.

Alignments: Warlords: Anarchist or Evil (typically the latter). Vultures: Anarchist or Evil (usually the latter). Drifters: Any, although the majority are Unprincipled (30%), Anarchist (33%) or evil.

Attribute Requirements: Quick reflexes (P.P. 10 or higher) and a liking for anarchy and personal freedom.

Base S.D.C.: 55 (includes Roughneck S.D.C.)

O.C.C. Abilities and Bonuses: **Roughneck (special):** Years of rough and tumble living has given the Splatterpunk +20 S.D.C., and +1D4 to his P.S. and P.E. attributes.

Contacts (special): Splatterpunks are likely to be on good terms with 2D6 fellow Bulletboys who will be roughly the same level (no more than two levels higher or lower) as the player character. The chances of the character randomly bumping into an old acquaintance are up to the G.M. but should be about 15% when the player calls for it; roll percentile dice.

Note: If used in the Rifts® setting or if the G.M. would like to include it in the Systems Failure™ setting, it is appropriate to give the Warlord and Drifter Splatterpunk the special Gunslinger O.C.C. skills of *Quick Draw Initiative: Revolvers & Pistols*, *Paired Weapons: Revolvers & Pistols*; and *W.P. Sharpshooting Specialty (both)* as described on page 94 of *Rifts® New West* (maybe *Reputation & Horror Factor* too).

O.C.C. Skill Programs: Warlords and Vultures: Professional Thief (twice so it includes the five Rogue skill selections), Modern Weapons Program, and one other Skill Program of choice.

Drifters: Criminal Program (+20%), Modern Weapons Program, and one other Skill Program of choice.

O.C.C. Related Skills: Warlords and Vultures select two skills from the following — Drifters select six:

Communications: Radio: Basic, Surveillance Systems and Read Sensory Equipment only.

Domestic: Any for the Vulture and Drifter (+5%), but NONE for the Warlord. No self-respecting Warlord would be caught dead doing any of these skills.

Electrical: Basic only.

Espionage: Any (+5%; +10% to Forgery only).

Mechanical: Basic mechanics or automotive only.

Medical: First Aid only (+5%).

Military: Any (+10%)

Physical: Any

Pilot, Basic: Any (+10%)

Pilot, Advanced: Any

Pilot Related: Read Sensory Equipment and Weapon Systems only.

Rogue: Any (+10%)

Science: Mathematics: Basic and Chemistry (for making pipe bombs) only.

Technical: General Repair and Literacy only.

Wilderness: Any

W.P.: Any

Secondary Skills: None initially. Characters may select one Secondary Skill at levels 3, 5, 7, 9, 11, 13 and 15.

Standard Equipment: One weapons of choice for each W.P. plus 100 rounds for each. Most anarchists do not have access to heavy weapons or Organotechnology. They also start with \$1D6x100 in additional gear, clothing and supplies. Has a 50% chance of owning some kind of beaten-up motor vehicle (motorcycle, car, jeep, light truck and a full tank of gas) or a horse.

Money: \$1D4x100 in precious metals and/or tradable goods.

The Upside: The shattered, anarchistic world is your playground. The most evil of you take what you want and stomp on anybody who gets in your way. You are the top dog and people respect you.

You like the chaos and enjoy surviving by using your wits and a gun. It comes naturally to you. You're armed to the teeth and as rough as they come. You're also very skilled at scrounging or taking whatever you need. Yep, no rules or restrictions apply to you. You are as free as a bird and do as you please.

The Downside: Let's face it, the worst of you Splatterpunks confuse "respect" with "fear," not that most of you would care about the difference. You are hated, and live and die by the gun; often at a young age. You're something of a scumbag, rebel and outlaw. You care only for Numero Uno, and you are generally a killer and a thief. Others won't be likely to trust/help you, and for good reason. Chances are, your propensity for starting gunfights will make you the enemy of humans and Bugs alike. Not like you care though — you're either too wicked or burned out to notice or you probably won't live long enough to regret it.

Yep, you're free as bird alright, and often lonely and alone.

Experience Point

Requirements for Splatterpunks:

Level 1: 0,000 - 2,140

Level 2: 2,141 - 4,280

Level 3: 4,281 - 8,560

Level 4: 8,561 - 17,520

Level 5: 17,521 - 25,520

Level 6: 25,521 - 35,520

Level 7: 35,521 - 50,520

Level 8: 50,521 - 71,000

Level 9: 71,001 - 96,100

Level 10: 96,101 - 131,200

Level 11: 131,201 - 181,300

Level 12: 181,301 - 231,400

Level 13: 231,401 - 281,500

Level 14: 281,501 - 341,600

Level 15: 341,601 - 401,700



Survivalist O.C.C.

Also Known As: Militia-man, Gun-Bunny, Bunker Lord, and Badlander

These characters got their start with the wave of people who just *knew* Y2K was going to bring hard times and began preparing early on. The more extreme ones built heavily defended compounds and/or bunkers in the wilderness, so when The Meltdown took most of society down, the Survivalists were some of the few who were still sitting pretty. Where once they were the laughingstocks of their peers, now they had the advantage. While the rest of the world suffered food shortages, rioting and tyranny from Warlords, the Survivalists had plenty of supplies, gear and a position of strength, so they had to bow to no one.

Then the Bugs came and ruined everything.

Had this all just been a collapse of government and society, the Survivalists would have been content, since they were never overly fond of them anyway. All those rules and regulations, bosses and the government breathing down your neck — who needs it? But with the Bugs taking over the planet, things are more complicated. No Survivalist wants to become a slave to the Bugs, but at the same time, they also don't want to join some big, faceless organization like NORAD, either. What's a freedom-loving anti-socialite to do?

The answer is in the two basic types of Survivalist commonly found in Free America: *Bunker Hermits* and *Militiamen*.

Bunker Hermits are the more reclusive type of Survivalist. A fair number of them lived in log cabins, tents, armed camps and concrete

bunkers well before Y2K came, simply because they disliked society and people in general. The thought of being drafted into a big war against the Bugs is repugnant to Hermits because they can not digest the notion of being bossed around by anybody for any reason. The average Hermit would make it five minutes in the military before he ended up pulling KP for a century or going AWOL, and they know it. So they figure they'll do everybody a favor and shrink back from center stage as far as they possibly can, deep into the Badlands. Unfortunately, as the things heat up with the war against the Bugs, many humans take the stance that either you are with them or against them. Hermits, with their obvious aversion to working with others and helping "the cause," fall into the latter camp. This doesn't make them very many friends, but they actually prefer it that way; after all, they have no desire to reestablish the old government and they are doing fine on their own. Even friends get annoyed with these hoarding isolationists after awhile.

Although anti-government isolationists, these anarchists have no love for the Bugs and do battle them whenever they threaten the Hermit's land, family or friends. Sometimes the Hermit will even come to the aid of a neighbor, and those living in a small commune or military encampment with like-minded isolationists will always fight to defend the camp and all its inhabitants. Likewise, they may raid a Bugtown or slave pen to save "one of their own." Freedom, after all, is their credo.

Militiamen are Survivalists who have decided that the best way to stay alive is to take out the Bugs, but they sure as heck aren't going to join up with some formal army, like what NORAD's got cooking out in Colorado. No sir, these guys would much rather form a "Citizen's Army" of their own — for the people, by the people. What they lack in training they make up for with passion, and most are well armed enough to give the Bugs a serious fight. Many Militiamen spent the last few years before The Meltdown buying as much heavy weaponry as they could at gun shows and through arms dealers. They also spent most of The Meltdown itself raiding Federal Armories, like National Guard depots. They know how to use guns and are prepared to use them against the enemy.

The most famous militia army, of course, is the **Wyoming Free Irregulars**, a hardcore band of guerrillas who have been near the top of the Bugs' hit list for years. But, for every band of Survivalists like the *Irregulars*, there are a dozen others who are not as skilled, well organized or dedicated, and they ultimately buy the farm by picking a fight with the Bugs that they can't win. Still, any Militiaman considers this a good way to "check out," so it doesn't deter others from replacing the fallen.

Regardless of where one stands on the Bug Hunt, any Survivalist is as rough as they come, able to survive in almost any wilderness condition, and fairly handy with conventional weapons. Their gruff and anti-social demeanor doesn't ingratiate them with other groups, but their incredibly detailed knowledge of their particular neck of the woods, including their deadeye shooting accuracy, makes them a valuable addition to any war party.

On a final note, it is interesting that the Bugs hate these characters more than any other. To the Bugs, Survivalists represent the common denominator of hostile humans, and given how much trouble Survivalists tend to give the Bugs (and everybody else), the aliens are realizing just how much they have in front of them if they truly want to pacify the entire world. Every human has the innate urge to resist tyranny. To the Bugs, Survivalists are practically the living embodiment of that principle, and as such, they must all be destroyed.

Survivalist O.C.C.

Attribute Requirements: None, although a high P.E. is helpful.

Base S.D.C.: 35

O.C.C. Abilities and Bonuses: +1D4 to P.E.

Deadeye (special): Survivalists gain additional bonuses to strike with any ranged weapon, thanks to their years of hunting, target shooting, and the occasional firefight with Bugs, trespassers, Warlords, and anybody else who gives them grief. This means that Survivalists get

one additional attack per melee round, are +1 on initiative, and +1 to strike when using a rifle (of any kind), shotgun or heavy weapon.

Survivalists can also make aimed or called shots from a moving vehicle or horseback. Note that these Deadeye bonuses and abilities apply only to when the Survivalist is firing a single-shot weapon. Burst and volley firing do not get Deadeye bonuses. Now, a Survivalist can benefit from Deadeye bonuses if he fires just one bullet from an automatic rifle, but once the gun goes to autofire, the Deadeye bonuses stop until single-shot firing resumes. **Note:** If used in the **Rifts®** setting or if the G.M. would like to include it in the **Systems Failure™** setting, it is appropriate to give the Survivalist the special Gunfighter O.C.C. skill of *W.P. Sharpshooting Specialties (Rifle only)* as described on page 91 of **Rifts® New West**.

Sense Bugs (special): Survivalists have this funny way of knowing when Bugs are nearby and about, they call it "their knack." Whenever a Bug or Silkworm Zombie is within 250 feet (76.2 m), the Survivalist will *just feel* that they are around, thus, they are rarely surprised by the creatures. Likewise, the Survivalist is never fooled by the tricks of an Assassin Bug or a Silkworm Zombie. **Base Skill:** 50% +5% per level of experience (+15% when there is evidence of the Bugs' handiwork and in urban settings, including ghost towns).

O.C.C. Skill Programs: Survival/Wilderness (+20%), Military Basic (+10%) and one Skill Program of choice.

O.C.C. Related Skills: Select five skills from the following:

Communications: Any (+5%)

Domestic: Any (+10%)

Electrical: Any except Organitech Electronics.

Espionage: Any (+5%)

Mechanical: Any except Organitech Mechanics.

Medical: Holistic Medicine and Paramedic only (+10%).

Military: Any (+10%).

Physical: Any. Hand to Hand: Martial Arts or Hand to Hand: Assassin costs only one skill selection.

Pilot, Basic: Any (+10%)

Pilot, Advanced: Helicopter, Tanks and APCs only (+5%).

Pilot Related: Any

Rogue: Concealment, Find Contraband and Illegal Weapons, Pick Locks, Safecracking and Streetwise only.

Science: Any (Some of the greatest Eggheads from before The Meltdown became ardent Survivalists when they realized what a mess Y2K could be or shortly after The Meltdown began.).

Technical: Any (+5%)

Wilderness: Any (+15%)

W.P.: Any except W.P. Energy Weapons.

Secondary Skills: None initially. The character may select one Secondary Skill at levels 3, 5, 7, 9, 11, 13 and 15.

Standard Equipment: One weapon of choice for each W.P. with 1,000 rounds for each, plus one rifle or shotgun, hatchet, survival knife, a suit of light body armor, basic survivalist gear (knapsack, backpack, sleeping bag, canteens, etc.), and \$2D6x1,000 in gear or tradable goods. These guys are the best-equipped characters in the game, bar none! They also have a cross-country motorcycle, jeep or horse. The family lives in a bunker at as a well fortified (and probably hidden) homestead.

Money: \$1D6x1000 in precious metals and \$1D6x1000 in trade commodities, like seed, grain, gasoline, or livestock.

The Upside: Nobody was more prepared for The Meltdown than you. Consequently, you are very skilled and well supplied.

The Downside: You're a bit paranoid and have something of a hair trigger. Since you trust nobody, nobody really trusts you, either.

Experience Point

Requirements for Survivalists:

Level 1: 0,000-2,000

Level 2: 2,001 - 4,000

Level 3: 4,001-8,200

Level 4: 8,201-16,400

- Level 5 16,401-24,500
- Level 6: 24,501 -34,600
- Level 7: 34,601-49,700
- Level 8: 49,701-69,800
- Level 9: 69,801-94,900
- Level 10: 94,901 - 129,000
- Level 11: 129,001 -179,100
- Level 12: 179,101-229,200
- Level 13: 229,201 - 279,300
- Level 14: 279,301 - 329,400
- Level 15: 329,401 - 389,500

NORAD Psychic O.C.C.

Also Known As: Esper, Captain Cranium, and Think Tank.

One of NORAD's special strategic initiatives is the development of a Psychic Combat Corps that can support the other troops as well as conduct reconnaissance and surgical strikes themselves deep within Bugged territory. The untapped potential of the human mind is one thing the Bugs can not control, and NORAD aims to exploit that weakness to the maximum. As a result, they are actively recruiting or drafting any psychic they can find. "Candidates" undergo intense training, and if needed, indoctrination, to hone their minds and their will into razor-sharp psychic engines of destruction, finely tuned to a specific military purpose.

NORAD training falls along the three basic lines of psychic power: *Physical*, *Sensitive* and *Healing*, with *Super-Psionic* being a rarity (most NORAD psychics are Minor and Major Psychics). Thus, most characters will learn all powers of a single category before they diversify. **Healers** are super-medics who provide support for combat and field teams. Ironically, they find actual conventional surgery crude and distasteful, and will not be party to it, if possible. **Sensitives** use their abilities to locate Bugs and to sniff out Silkworm Zombies (who often try to infiltrate human installations), and to perform high-risk reconnaissance. These psychics are also sometimes known as "Bloodhounds" and have become one of the most revered and respected of the NORAD Psychics. **Physical Psychics** are trained largely for pure combat. While this makes them super-soldiers, it also makes them deficient in other psionic disciplines that can be just as vital for survival. The rare **Master Psychic** is typically trained in espionage and combat as a Special Ops agent and is a true super-soldier.

Most NORAD Psychics are considered "Company Men" (regardless of their gender, the nickname sticks) who live at and are devoted to NORAD. Their strong loyalty comes from having lived with NORAD for years and seeing things their way. The way they see it, it's only fair that they serve NORAD in its attempt to restore the government and free America not only because it's the right thing to do, but in return for NORAD helping them to develop their psychic powers. Company Men usually have similar motivations and obligations as the NORAD Exterminator O.C.C. They are elite soldiers who act on orders from NORAD. Or, less frequently, they are NORAD sanctioned free operators who do their thing deep in the bush, reporting back home periodically.

There are those candidates unwilling to go with the program, however. These troublemakers often undergo severe subliminal indoctrination, a process NORAD finds distasteful but necessary. After 1D6 weeks of intensive "recalibration" training, the psychic returns to mainstream training, mysteriously bereft of his previous feelings of rebellion. It is widely believed that one of NORAD's Master Psychics simply performs a permanent Mind Wipe on these subjects and reconstructs their personalities somewhat to make them far more loyal and receptive to authority.

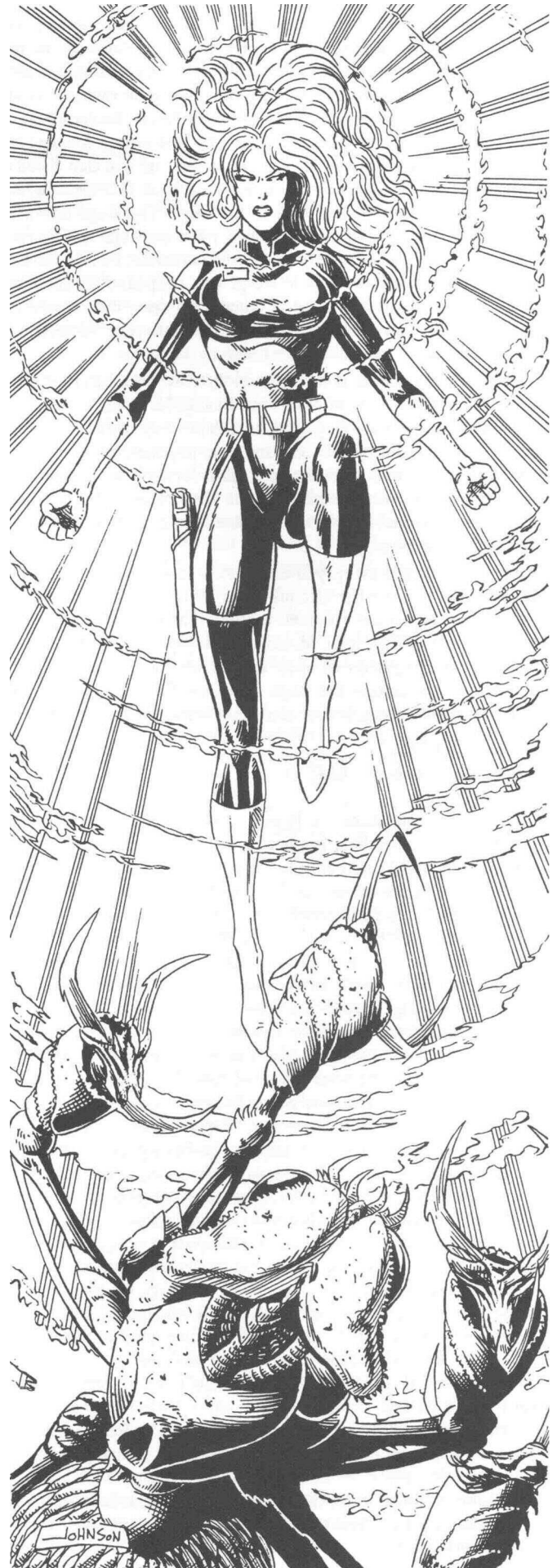

Independent or Renegade Psychics. There are those who are not willing to become a NORAD flunkie, nor do they undergo indoctrination. These cagey rebels usually avoid discovery by NORAD or skip out of training midway to develop their powers on their own and to live a free life. Called "Renegade" Psychics by NORAD who sees them as disloyal to their country, these characters are rare among humans and live a dangerous life. For one, they may have to stay one step ahead of NORAD who wants *very* badly to bring them back into the fold, and two, they are Enemy Number One to the Bugs! The Bugs kill every psychic they encounter because psychics are impervious to Silkworm impregnation, can easily identify Silkworm Zombies, and because they can use their psionic powers to intercept Bug telepathic transmissions (at least in part) and thwart them in other ways using their powers. In fact, this is a big reason many psychics willingly turn to NORAD who can offer them some measure of protection.

Being an independent is not an easy life, but then again, being a psychic never was. At least this way, Renegades believe they have some choice as to how they live and how they battle the Bugs. Ironically, many ordinary folk fear and shun psychics, but they realize that with their bizarre powers they are misunderstood and loneliness is something that sometimes comes with the territory. Still they eke out a living as best they can and most try to use their powers to help others and to combat the Bugs.

Only anarchist and evil psychics use their power to control and manipulate others, or for a life of crime or to lord over others. These cretins often view non-psionic humans as inferior and rather contemptible, barely deserving of their help. Meanwhile, all psychics, but particularly the most self-serving and evil ones, wonder what will come of them if humanity actually defeats the Bugs. After the fighting, what purpose would the psychics serve, except as a threat to the new world order?

Psychic O.C.C.

Attribute Requirements: M.E. 15.

Base S.D.C.: 30

O.C.C. Abilities and Bonuses: *Psionics (special)*: Intensely trained in harnessing the incredible powers of the mind, those recruited and trained by NORAD are typically Major (46%) or Minor (50%) Psychics. Only 4% are the impressive Super-Psychic. See Step Four in the Creation Rules for determining the type and number of powers and the amount of I.S.P. Note: All NORAD trained *Minor Psychics* get the additional abilities of Mind Block and one of choice from whatever category has been designated as that character's area of specialty: *Healing, Physical, or Sensitive*.

All NORAD trained *Major Psychics* get the additional abilities of Mind Block and two of choice from whatever category has been designated as that character's area of specialty: *Healing, Physical, or Sensitive* — or one *Super-Psionic Power*.

Master Psychics, also known as "Super-Espers," are incredibly uncommon and available only as a special Psychic O.C.C., and only if the G.M. allows it (an optional player character). Such individuals get six powers from one of the three common psionic categories: *Healing, Physical, or Sensitive* and one *Super Psionic Power*. Unlike the others, this character gains additional psionic powers as he or she grows in experience. Select two powers from any of the three common categories or one Super Psionic Power for each level of subsequent experience (starting at level two). Base I.S.P. for the Super-Esper starts at +1D6x10 +M.E. attribute number plus another +10 I.S.P. per level of experience (start at level one).

O.C.C. Skill Programs: NORAD psychics get one skill program, typically Military Basic, Wilderness Survival or Technical. Independent Psychics get none! Whether a NORAD Psychic or Independent, the character has spent much of his time honing his mental powers, not learning skills.

O.C.C. Related Skills: NORAD Psychics select two, Independent Psychics select 10 skills from the following skill categories.

Communications: Any

Domestic: Any

Electrical: Basic Electronics only.

Espionage: Any except Sniper.

Mechanical: Basic and Automotive Mechanics only.

Medical: First Aid or Paramedic but the latter counts as two skill selections.

Military: Military Etiquette only (+5%).

Physical: Any except Wrestling. Hand to Hand: Expert costs two skill selections and Hand to Hand: Martial Arts or Hand to Hand: Assassin costs three skill selections.

Pilot, Basic: Any (+5%)

Pilot, Advanced: None

Pilot Related: Any

Rogue: Any (+2%)

Science: Any (+5%)

Technical: Any (+10%)

Wilderness: Any

W.P.: Any

Secondary Skills: None, initially. The character may select one Secondary Skill at levels 2, 4, 8 and 12.

Standard Equipment: Pistol of choice (whether the character knows how to use it or not) plus 100 rounds of ammunition, one weapon for any two W.P.s, a knife, basic survival gear and clothing. NORAD Psychics also get a field and dress uniform, and basic military gear. Plus, they have access to NORAD facilities, a military base as their home, and basic supplies and special equipment is usually supplied by their NORAD Commander per assignment.

Independents get the same basic gear and \$1D4x100 in personal items and additional items. Most feel they don't need much else; they're kind of cocky like that.

Money: Company Men will have maybe \$100 in personal wealth, since NORAD takes care of all their basic needs. Renegades will have up to \$1D6x100+100 in precious metals and/or tradable commodities.

The Upside: Your psychic powers give you a unique edge in survival and the war against the Bugs. You can sense where they have come and go, and you can also detect Bugged humans better than anybody else, making your abilities very much in demand. Independent Psychics can profit greatly from careful use of their abilities.

The Downside: Many people (not all) consider you to be abnormal and a little bit frightening. Some Warlords and Bunkerlords regard you as a "mutant freak," while others try to exploit you for their personal gain. And the Bugs hunt you relentlessly.

NORAD Psychics, your benefactor has gone through great expense and time to train you in your abilities, and they expect to get their money's worth. Military life is restrictive and not always personally rewarding. You have to follow orders whether you like them or not. In the field and undercover, there is only so much protection your precious NORAD can provide.

Experience Point

Requirements for Psychics:

Level 1: 0,000 - 2,300

Level 2: 2,301-4,600

Level 3: 4,601 - 9,200

Level 4: 9,201 -18,400

Level 5: 18,401-26,500

Level 6: 26,501-36,600

Level 7: 36,601-51,700

Level 8: 51,701-71,800

Level 9: 71,801-96,900

Level 10: 96,901-137,000

Level 11: 137,001-188,100

Level 12: 188,101-229,200

Level 13: 229,201 - 279,300

Level 14: 279,301 - 340,400

Level 15: 340,401 - 400,000

NORAD Splicer O.C.C.

Also Known As: Bugboy, Superfly, Grasshopper

Four years ago, NORAD Commanders held a top-level conference to address the gaping difference in firepower between human forces and the Bugs. While Bugs are susceptible to conventional weapons, their ability to blitz an opponent by travelling through hardlines and invade and take over any electronics renders advanced weaponry, including most types of missiles, tanks, jet fighters, helicopters and even electric powered firearms (e.g., certain heavy weapons), radar, and electronic guidance and targeting systems useless (or at best, vulnerable to invasion and subversion). If humanity was to have a decent shot at beating the Bugs, then they would have to beat them at their own game. That was why NORAD green-lighted the **Gideon Directive**, a multi-pronged scientific research effort that has developed the various Organitech weapons, armor and equipment used by Special Ops and frontline NORAD troops. The Top Secret wing of the Gideon Directive is known to few, and it is they who are working on **Operation Doppleganger**.

In short, this is a process in which Captured Bugs have samples of their genetic material extracted, modified, and spliced into the DNA structure of a human volunteer. Those who survive the process (which currently has an alarming 65% mortality rate — down 20% since the beginning) are transformed into a hideous fusion of human and Bug, an insectoid hybrid that is neither and both of the human or Bug races. While they appear monstrous, these so-called "Splicers" or "Bugboys" possess an amazing array of superhuman powers that make them the most effective killing machines in the entire NORAD arsenal. From super-strength to firing energy blasts, to chitinous armor, these characters surpass all others in front-line offensive capability.

Unfortunately, all that power comes at the cost of their humanity. No Splicer can pass for human, and with Operation Doppleganger so secret, not even NORAD allied militia forces, scouts and friendlies know these brave souls exist. For the time being, NORAD is keeping them a secret, both to ease their introduction to the rest of NORAD forces, and to see if these Splicers can be completely trusted.

While Splicer units have proven themselves time and again as incredibly brave and able combat units (Splicer Team *Spider Zulu*, the first such combat unit, has amassed over 5,000 enemy kills in just two years), there are those who fear that their Bug "heritage" might allow them to be "turned" to join the enemy. Just as bad are fears that the isolation from their fellow humans will cause the Splicers to lose touch with their humanity and become cruel or mutinous. Until all of NORAD's High Command is convinced such possibilities are not likely, the Splicers will remain a dark secret and used in a very limited capacity.

If and when Operation Doppleganger goes public, then NORAD will consider moving the project to its second phase, perfecting the Splicing technique so that its subjects gain powers but retain their human form (or most of it). Of course, lowering the mortality rate of the process itself is top priority. NORAD scientists predict that within three years, the process can be fine-tuned so that mortality rates are at only 5%, and virtually anybody could undergo the process. They also hope to make the process fully reversible, although there has been no success in this area thus far. Promises like these are what really have NORAD leaders drooling over Operation Doppleganger. Just imagine — if *anybody* could become a Splicer to fight the enemy and then be returned to normal, it would be fantastic.

For the moment, all of this is just blue sky talk. For now, the 100 or so "Bugboys" currently pioneering Operation Doppleganger live hard and isolated lives, cut off from their fellow patriots, knowing full well that the rest of the world will consider them monsters. Still, this is a price all super-patriots have chosen to pay to become Splicers. Despite their many hardships, this is something they would all do again if they had the choice. To them, there is no higher honor than making the ulti-

mate commitment in the Great American Bug Hunt. **Note:** To test the mental endurance of the Splicers, and the potential for their acceptance by normal humans, roughly two dozen have been sent into the world where they are to make contact with freedom fighters and adventurers and work with them as part of a team to combat the Bugs.

Super Powers

The Splicer is the only O.C.C. in **Systems Failure** besides the Psychic that has bonafide super-abilities. These are the Splicers' trademark, and what make them such an awesome weapon in the arsenal of freedom against the Bugs. All Splicers may pick *three* abilities from the following table, or they may roll randomly for them (if a power is duplicates, ignore it and re-roll).

01-06%: Adhesion. Characters with this power are able to attach themselves to any solid surface by their fingers/hands and toes/feet. This means the person can walk on walls or ceilings and can climb any surface effortlessly. Maximum speed while climbing or crawling along walls is half the character's Spd attribute. Attempting to carry a heavy load greater than his P.S. x10 in pounds (0.45 kg) will cause the character to immediately fall off. Restrictions: Loose rocks, crumbling plaster, ice, oil or other slippery substances will prevent the character from adhering to a surface. Polished metal, chrome and glass are not considered slippery and can be held on to or climbed. Related Abilities and Bonuses: Automatic Climbing skill equal to 90% proficiency (does not include rappelling); -15% when the character is wearing shoes and/or gloves. Add +10% to the Prowl skill but only when climbing on the ceiling, wall, or other high place. +15% to Palming Pick Pockets and Concealment skills. +5% to Acrobatics and Gymnastics skills. +1 point to P.P. attribute.

07-12%: Body Weapons. The character has some form of insectoid body weapon, such as biting mandibles, hooked claws, crushing pincers, or a stinger. The exact type of body weapon is up to the G.M. and the player.

Damage: Mandibles: 3D6, can choose to lock onto the target and automatically inflict 3D6 each round until forced to let go. A good combination with various wrestling moves.

Claws: 3D6 +P.S. bonus.

Pincers: 3D6 +P.S. bonus, plus can lock onto the target like mandibles, above. But, the character has no hands and cannot manipulate objects.

Stinger: The character has a stinging weapon that inflicts 1D6. The stinger may or may not be retractable, at the player's option. If the target fails to save, he takes an additional 3D6 in poison damage for the next 1D4 melee rounds. (At the G.M.'s option, the poison may inflict harmless paralysis instead for 1D6 melee rounds.)

13-18%: Chameleon. Identical to the ability possessed by the Assassin Bugs.

19-25%: Bio-Energy Expulsion. The character can fire energy blasts from his hands or a vent-like protrusion on each of his forearms. These blasts are very similar to the bio-energy blasts the Bugs use as their primary weapon. Each blast counts as one melee attack/action. Both hands can be pointed and fired simultaneously at the same target to do double damage and counts as one melee action, however, there are no bonuses to strike.

Range: 500 feet (152.5 m) +25 feet (7.6 m) per level of experience.

Damage: 2D6 +1 point per level of experience.

Special: At 3rd level, characters with this power gain the ability to regulate the strength of these blasts in 1D6 increments. This is useful for sending warning shots, or simply wounding but not killing opponents.

26-32%: Energy Resistance. This power makes the character extremely resistant to all energy-based attacks, including Bug bio-cannons, and Organitech energy weapons. Characters with this power take no damage from the first 20 points of energy attacks in a melee round. Energy attacks beyond the 20 points do only half damage.

The character's resistance to energy includes fire, electricity, lasers, and most other forms of pure energy, including blasts from Bug bio-cannons and Organitech energy weapons. This power is not effective against radiation damage, kinetic energy (punches, kicks, bullets, explosions) or psionic mind bolts.

33-39%: Tough Exoskeleton. The character has an unusually thick, chitinous exoskeleton that provides him with a natural A.R. of 15, and +100 S.D.C. However, the character's P.B. drops to 4, and his P.P. and Spd are also reduced by 1D6. Skills requiring dexterity, such as Acrobatics, Gymnastics and Prowl, have a -10% penalty.

40-45%: Extraordinary P.E. The character is a superhuman workhorse, fatiguing at only 1/10th the normal rate and able to withstand incredible physical punishment. Bonuses: +1D6+5 to P.E., +4D4x10 S.D.C., +3D6 Hit Points with an additional +1D4 per level of experience (on top of the normal +1D6 all other characters get).

46-51%: Extraordinary P.P. Phenomenal dexterity and reflexes. Bonuses: +3D4 to P.P., +3D4 to Spd., +1 attack per melee round, and automatic dodge at +3 (can dodge an incoming attack without using a melee action). +10% to skills requiring dexterity, such as Prowl, Gymnastics, Acrobatics, Climb/Scale Walls, etc.

52-58%: Extraordinary P.S. The character possesses amazing strength capable of lifting 200 times his P.S. and carrying 100 times his P.S. in pounds (one pound equals 0.45 kg). Bonuses: Increase P.S. to 20 +2D6. If P.S. is already 20 or higher, then add +2D6+6 to it.

59-64%: Increased Running Speed and Agility! Can run at 1D6x10+66 for a minimum speed of 53 mph (85 km). Bonuses: +20 to S.D.C., +1 attack per melee round, +3 to initiative, +1 to strike, +2 to parry, +2 to pull punch, +4 to roll with impact, punch or fall and +6 to dodge. +2 damage to hand to hand attacks for every 20 mph (32 km) the character is moving at.

65-70%: Flight: Winged. The character has large, insectoid wings that when not in use, are housed beneath the character's carapace. When in use, the carapace flips open like that of a beetle or retracts into the character's back (player's option) and the wings can be put to use. Some Splicers' wings have no covering whatsoever, and lay folded on their back when not in use. These are virtually impossible to conceal, but given the generally freakish appearance of most Splicers, concealing their wings would be like putting perfume on a pig. Each wing has the equivalent of 35 S.D.C. (the character can not use them to shield himself). Attacking a wing requires a called shot. If one wing is reduced to 10 or fewer S.D.C., flying speed is halved. If one wing is crippled (zero to one S.D.C. point) the character cannot fly until the wing(s) can heal. Wings regenerate 1D4 S.D.C. per day and will regrow if completely destroyed, but that takes 4D6+6 weeks.

Flying Speed: 1D6x10+66 for a minimum speed of 53 mph (85 km). Maximum altitude is 8,000 feet (2439 m).

Bonuses While in Flight applicable only when the character has room to use his wings: Note that the character can hover just a few inches off the ground to enjoy these bonuses: +1 attack per melee round, +2 to strike and parry, +4 to dodge while flying or hovering, +2 to hand to hand damage for every 20 mph (32 kph) of flying speed.

71-76%: Healing Factor. This power provides the character with incredible recuperative abilities. The Splicer recovers 3 S.D.C. every 10 minutes, and 1 Hit Point every 15 minutes. He can also instantly regenerate 4D6 Hit Points or S.D.C. twice daily, he never fatigues, fire and cold inflict only half damage, and any damage inflicted by drugs, toxins or poisons is one-third normal. (This applies to Bug Juice chemical weapons as well, to which Splicers are unfortunately vulnerable.) And finally, any wounds the character recovers from with this ability leave no scars. Bonuses: +2D4 P.E., +2D6 +6 Hit Points, +25 S.D.C., +20% to save vs coma/death, and +3 to save vs poison and toxins (in addition to P.E. bonuses).

77-82%: Leaping Ability. As per the Physical Psionic ability Telekinetic Leap, only it can be performed at will at no I.S.P. cost, and with no chance of self-harm. Each leap counts as one melee action/attack.

83-88%: Multiple Limbs. The character has an extra set of arms or legs. Given the overall insect-like appearance of many Splicers, this power will make the character even less distinguishable from a Bug. Bonuses from an extra pair of arms and hands: +1 attack per melee round, +1 to parry, paired weapons, +15% to Climb/Scale Walls, +5% to Pick Pockets, Pick Locks, Palming and other sleight of hand tricks.

Bonuses from an extra pair of legs and feet: +1D6x10 to Spd, can leap 10 feet (3 m) from a standstill or 20 feet (6 m) from a running start, +4 to dodge, kick with rear two legs does 3D6, +20% to maintain balance, +20 S.D.C. Note: This power may be taken twice, giving a character a total of four arms and four legs, with full bonuses for each. The downside, of course, is the character will look like a monster, and will have an even tougher time convincing humans otherwise than his fellow Splicers.

89-94%: Radar. This ability sends out high-frequency radio waves which bounce off objects, returning and indicating the direction and distance of the reflecting objects. This power provides the character with a crude ability to see in the dark, as well as other benefits. Range: 400 feet (122 m) +100 feet (30.5 m) per level of experience.

Radar Attributes Include:

Interpreting Shapes: 50% +5% per level of experience.

Estimating Distance: 60% +4% per level of experience.

Estimating Direction: 60% +4% per level of experience.

Estimating Speed: 40% +4% per level of experience.

Estimating Exact Location: 50% +4% per level of experience.

Radar Bonuses: +4 on initiative, +2 to strike, parry and dodge, +1 attack per melee, no minuses apply when blinded or in darkness. Note: Radar does not go through cloth, wood, glass, metal or people. Consequently, the character cannot see or sense through walls or doors. Likewise, while he may sense a car, estimate its speed, direction and distance, he cannot tell how many people are inside. **Disadvantages:** Radar is fouled in the rain, snow, and dust or sandstorms. No bonuses apply under such conditions. Smoke and fog also foul radar, but not as severely; all abilities to estimate speed, direction, distance, shape and location are at -30%, and all bonuses are cut in half. (The character still has +1 attack per melee.)

95-00%: Super-Vision: Bug Eyes. The character has large, round, purple eyes that provide him with extreme peripheral vision and excellent depth perception as well as nightvision (100 feet/30.5 m). Bonuses: +2 on initiative, +1 to parry and dodge.

Splicer Bug Hybrid O.C.C.

Attribute Requirements: P.E. 14, M.E. 14. Anyone with lesser attributes will either be killed or driven insane by the splicing process. Base S.D.C.: 1D4x10+60 and those from physical skills.

O.C.C. Abilities, Weaknesses & Bonuses:

1. Horror Factor. All Splicers have a Horror Factor of 10 +1D4. This can be a good thing or a bad thing, depending on where the character is. Note that Bugs are immune to the effects of Horror Factor, just as no Splicer is going to be freaked out by the appearance of another Splicer. This characteristic affects only humans.

2. Natural Armor Rating: A.R. 8+1D4; there is a range of armor protection among the Bugboys.

3. Chemical Susceptibility. Because Splicers share the Bugs' genetic structure, they are vulnerable to the chemical weapon nicknamed "Bug Juice," an Organitech insecticide that causes a Bug's cellular structure to break down upon contact. This weapon is cheap and easy to produce and has become a Number One Bugkiller on the front lines, largely because it has zero effect on humans. Unfortunately, it *has full* effect on all Splicers, which makes friendly fire a very deadly possibility. Especially since many NORAD front-liners and militiamen will not recognize a Splicer for what he is and will Juice him just to be safe.

4. Rapport with Bugs. Splicers can hear the telepathic conversations and transmissions of other Bugs and can speak to them with their own Bug Telepathy (half the range as the normal Bugs, see description under Army Ant).



NO Going Back! The Doppelganger process is a one-way trip. Those who undergo it will never be fully human again. Perhaps this is something that will change with future revisions of the process, but for now, Splicers undergo a permanent transformation.

O.C.C. Skill Programs: Military Basic. Splicers spend most of their time honing their newfound abilities.

O.C.C. Related Skills: Pick seven "other" skills from the following categories:

Communications: Any

Domestic: None

Electrical: Basic Electronics only.

Espionage: Any except Sniper.

Mechanical: Basic and Automotive Mechanics only.

Medical: First Aid only.

Military: Any (+5%)

Physical: Any. Hand to Hand: Expert costs one skill selection and Hand to Hand: Martial Arts or Hand to Hand: Assassin costs two skill selections.

Pilot, Basic: Any (+5%)

Pilot, Advanced: None

Pilot Related: Any

Rogue: Any

Science: Any

Technical: Any (+5%)

Wilderness: Any

W.P.: Any

Secondary Skills: None initially. The character may select one Secondary Skill at levels 2, 4, 8 and 12.

Standard Equipment: Splicers tend to work for and within NORAD, so they are issued their equipment on an as-needed basis. If the G.M. allows the character to be a free Splicer who has left NORAD for some reason, then begin with one weapon of choice (excluding heavy weapons), 100 rounds of ammunition, a basic survival kit and gear, and \$1D6x100 in miscellaneous gear.

Money: Again, NORAD Splicers have no need for money. Free Splicers will have \$1D4x100 in precious metals and/or tradable goods.

The Upside: You are one of the most powerful creatures on Earth! Your abilities make you an awesome Bug-killing machine and give America a real fighting chance against the Bugs!

The Downside: You are a "creature" — an inhuman monster! Splicers generally are considered freaks and monsters even by most of the humans who they fight for. Chances are, a Splicer's death will not come from a Bug but from a jittery human who thinks The Splicer is one of the bad guys (Nobody ever said being a hero meant being popular or appreciated). Plus, Splicers are vulnerable to the Bug Juice, so these characters must take special care to avoid it on the battlefield. And finally, Bugboys have few skills, relying on their natural abilities and wits.

Special Notes on the NORAD Splicing Process: Adventurers who get in good with NORAD and prove their desire and worthiness, may be allowed to undergo the Splicing process and allowed back into the world (requires an M.E. and P.E. of at least 14). Outsiders who undergo the process run a serious risk of going insane from it, since they lack the extreme conditioning that NORAD military volunteers have.

Anyone who has been another O.C.C., and undergoes the Splicing process must make a save vs insanity, at -4. Those who fail will contract 1D4 random insanities from the Splicing process. Pick or roll on the random tables in the Insanity section of this book. For game purposes, we can assume the character survives. This is a rarity.

Adjust skills. Any character who has been a different O.C.C., can only keep one Skill Program and seven other skills. The skill proficiency of the old O.C.C., is frozen until the character reaches the same level of experience as his old O.C.C., at which points skills can again grow in experience. No new Splicer O.C.C., skills can be selected.

Experience Point

Requirements for Splicers

Level 1: 0,000-2,300

Level 2: 2,301 -4,600

Level 3: 4,601-9,200

Level 4: 9,201 -20,400

Level 5: 20,401 -30,000

Level 6: 30,001 -40,000

Level 7: 40,001 -55,000

Level 8: 55,001 -70,800

Level 9: 70,801-100,000

Level 10: 100,001- 140,000

Level 11: 140,001-190,000

Level 12: 190,001-240,000

Level 13: 240,001 - 300,000

Level 14: 300,001 - 400,000

Level 15: 400,001 - 500,000

The Wacko

Who knows what motivates and drives these strange individuals. Most are poorly educated, superstitious, and narrowly focused or obsessed. All have strange and often annoying habits, personal rituals, idiosyncrasies, and twitches. How and why they are the way they are is anybody's guess. Some suffer from physical trauma, others from a chemical imbalance, some from mental or emotional trauma, still others are a product of their environment, the horrors of war, or unique philosophy and/or outlook at the world, and so on.

Despite all this, they are basically good-hearted people dedicated to helping others and willing to stand against the Bugs. Most are vagabonds with only one narrow area of expertise and a hodgepodge of other skills, but they use what they know to the best of their ability.

Wacko O.C.C.

Alignment: Any, but typically good, unprincipled or anarchist.

Attribute Requirements: M.E. 10 or *lower*: Often surprisingly intelligent.

Base S.D.C.: 30

Special Characteristics:

Obsessions: Killing and/or undermining the Bugs, plus roll for one random obsession (or pick one).

Wacky Luck: Most are superstitious and will have a lucky medalion, coin, jacket, shirt, hat, scarf, socks, etc. This item has a special significance and is always worn or carried, especially into dangerous or important situations, even if it is battered, broken, filthy, and/or smelly. In addition or in the alternative, the character may have a little superstitious ritual he engages in (i.e. spits in his hand or on the ground when preparing to go into battle; cracks his knuckles before a fight or when nervous; slaps his head, chest or weapon three times before attacking/shooting; rubs or scratches his chin, nose or butt; will only use a particular weapon or vehicle; knocks on wood; avoids stepping over the body of a dead Bug; always shouts, mumbles or whispers a particular word, phrase or sentence when scared, nervous or before opening a door; always stops to sniff flowers or pet a dog for luck, etc.).

Annoying Habit and/or Mind Set: Pick one of the following or roll randomly.

01-06 Taps/drums his fingers all the time or picks his nose or teeth.

07-12 New Age metaphysicist. Believes in ghosts, spirits and the power of crystals, pyramids, herbs, and magic. Believes that The Melt-down happened because humankind lost touch with its inner-self and the spiritual world. Tends to be compassionate and caring, but also has some strange ideas and wild theories. Ironically, +1 to save vs possession, illusion and magic!



13-18 Conspiracy theorist and mild paranoid. Sees a plot and underlying meaning in everything. Is loyal to friends, but is leery of and accusatory toward strangers.

19-24 Dislikes and distrusts technology. Sees it as the root of all evil and avoids using it (would rather walk or ride on a goat than in a car).

25-30 Refuses to use anything that is electric powered, even a battery powered wristwatch.

31-36 Computer or technology nerd, loves everything about the subject, is fascinated by new technology, wants to own as much of it/them as possible and talks about it way too much. Is easily distracted (no initiative) by it.

37-42 Poor personal hygiene, i.e. hates to bathe, use deodorant or wash his or her clothing. Consequently, the character is usually fairly "ripe" most of the time and has a noticeable body odor.

43-48 Can't hold his liquor, but won't admit it and gets drunk on a single drink, even if it's only wine or beer.

49-54 Gun Nut! Loves them, knows everything about them, and has several with him constantly (add two W.P.s and the corresponding weapons to this character's skills and equipment).

55-60 Chews bubble gum constantly and likes to pop the bubbles he makes (sometimes even when silence is important; oops).

61-66 Likes to exaggerate and always embellishes his stories, but doesn't necessarily do so to make himself more important. He just likes to tell dramatic stories.

67-72 Hates handguns and will only use them under the most desperate of circumstances, however, the character may love and use explosives or have a favorite heavy weapon (bazooka, LAW, etc.) or an ancient weapon (sword, bow and arrow, sling, boomerang, etc.).

73-78 Practical joker or tells bad puns.

79-84 Acts like a goofy, fawning or shy adolescent around the opposite sex, especially around attractive people. Is easily distracted (no initiative), confused, seduced and manipulated by them.

85-90 Gung-ho warrior bent on destroying the Bugs. Always up for battle and willing to take dangerous or outlandish chances.

91-96 Hypochondriac who is either feeling sick or worried about germs and getting sick. Frequently wears an air filter or, better yet, a gas mask and gloves, especially when visiting an unknown community (50 or more people) and when fighting Bugs (who knows what kind of alien germs these monster are carrying?).

97-00 Outspoken and says what he feels regardless of the consequences. Doesn't have a diplomatic bone in his body.

O.C.C. Skill Programs: Any one of choice (+20%).

O.C.C. Related Skills: The character may pick eight additional skills from the following:

Communications: Any (+5%)

Domestic: Any

Electrical: Basic Electronics only.

Espionage: Any

Mechanical: Basic Mechanics and Automotive only. Organitech Mechanics is rare and is only taken by those who have ties to NORAD and have one Organitech item (counts as two skill choices).

Medical: Any (+5%; +10% to Holistic Medicine).

Military: Camouflage and Demolitions skills only (+10%).

Physical: Any, except Wrestling.

Pilot, Basic: Any (+5%)

Pilot, Advanced: Any

Pilot Related: Any

Rogue: Any (+5%)

Science: Any (+5%)

Technical: Any (+5%)

Wilderness: Any

W.P.: Any

Secondary Skills: The character may select one Secondary Skill at levels 1,3, 6,9, 12 and 15.

Standard Equipment: Survival knife and one weapon for each W.P. (one may be an Organitech weapon), plus 200 rounds of ammo for each and \$1,000 in miscellaneous equipment.

Money: \$1D4x100 in precious metal and trade goods. Many Wackos travel light, but some are laden down with gear and junk.

The Upside: Nobody takes you seriously, so they (and the enemy) tend to underestimate you. Sometimes you feel like a cunning secret agent or super-hero who saves the day.

The Downside: Nobody takes you seriously, and you are often treated like the village idiot and/or avoided for being strange or a little scary. Sometimes you feel alone and sad.

Experience Point

Requirements for Wackos:

Level 1: 0,000-1,900

Level 2: 1,901-3,800

Level 3: 3,801 -7,600

Level 4: 7,601-15,200

Level 5: 15,201-22,300

Level 6: 22,301 - 32,400

Level 7: 32,401-45,500

Level 8: 45,501-60,000

Level 9: 60,001 -90,100

Level 10: 90,101 -120,200

Level 11: 120,201- 170,300

Level 12: 170,301 - 220,400

Level 13: 220,401 -270,500

Level 14: 270,501 - 330,600

Level 15: 330,601 - 390,700



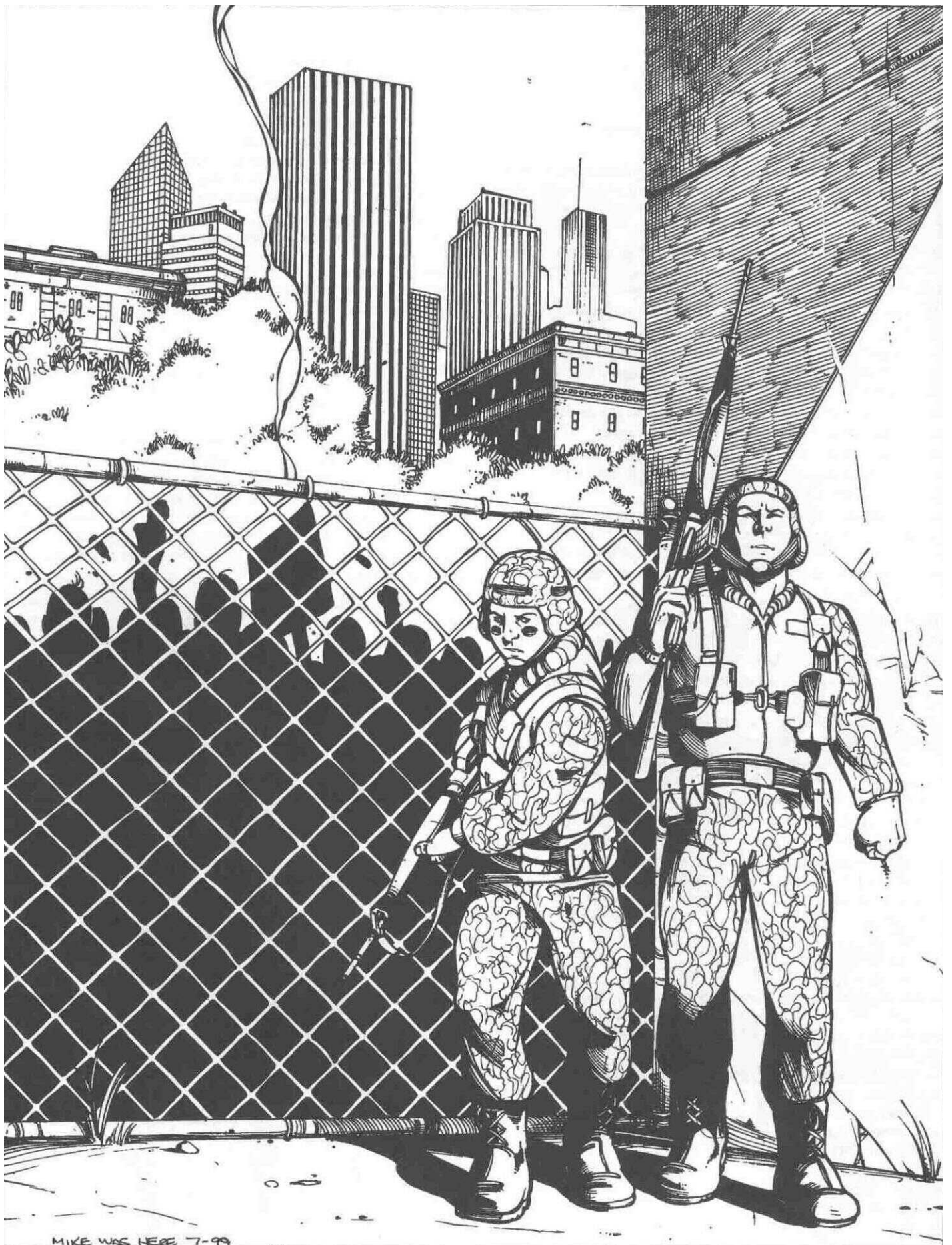

MIKE WAS HERE 7-99

THE STATE OF THE WORLD

It's Been a Long 10 Years

The following is a brief chronology of events, year by year.

1999: By this time, the whole world knows about the Y2K crisis, and is struggling to cope with it. Most governments and corporations throw incredible amounts of time and money into trying to fix an impending problem that should have been rectified years before. Software companies collectively stick their heads in the sand when asked why nobody thought to address the topic sooner. Meanwhile, out in the hinterlands, survivalists have prepared stockpiles of weapons, food, water, fuel, seed, livestock, and other supplies in anticipation of what they expect to be a very, very rough winter.

By the second half of the year, those who have done nothing to prepare for a possible Y2K crisis either simply brush the whole possibility of a Y2K crisis off and prepare to ring in the New Millennium or spend the last one to three months frantically trying to brace for impact (just in case).

But few honestly believe anything cataclysmic will happen and nobody is *really* prepared for what is to come. Nobody even has a clue.

2000: Y2K. The Year of The Meltdown. By noon, Greenwich Mean Time, New Zealand (which has the unfortunate duty of walking point on Y2K patrol) crosses over into the new year. The moment the country's clocks tick over, *everything* goes down. Computers, cars, planes, power grids, even simple electronic appliances stop working. It takes less than an hour for the rest of the world to hear about it, and when they do, people freak. Riots break out at retail and wholesale locations as folks hoard goods of every kind. Financial markets collapse both as Japan's Nikkei Exchange stops working and massive sell-offs deflate value faster than governments can suspend trading. Meanwhile, the handful of nations with nuclear weapons are busy handling the many false alarms their systems have sent to each other. Although world leaders had established nuclear security staff at each other's installations, hours of tense diplomacy are still required as the superpowers convince each other that no surprise nuclear attacks are underway.

Not that it matters much, for while the leaders of the world talk, their constituents are busy going mad, rioting and killing in a frenzy of fear. As the shadow of Y2K crosses over the world, nation after nation goes dark. And when they do, the anarchy only worsens. It is not as bad in less developed countries, where the land is not so dependent on an electronic nervous system, but no country is spared entirely. By the time the U.S. enters the new year, the country is a madhouse. Tanks are in the streets, martial law is declared, but looting and gang warfare still fills the air with bullets while hysterical mobs burn down entire cities.

The rest of the year is spent trying to get the lights back on and society back together again. Once people get their taste of anarchy, many of them are reluctant to give it up. Revolutions, rioting and assassinations spark off everywhere and overwhelm police and military forces. Even where martial law and heavy-handed riot suppression (e.g., shoot on sight) quell the worst disorder, crime remains rampant as heavy industries are unable to get back on line and severe cash shortages linger in the face of worldwide bank collapsing. Shortages of food and most other goods only make matters worse. With starvation and widespread disease very real problems, the average person bears little fear from

armed cops, especially when it concerns breaking curfew to steal bread or killing some punk to get his gold watch (which was probably stolen in the first place).

By year's end, fully 20% of the world's cities are destroyed (30% in the USA, Germany and France). Most burn during the riots and street wars of The Meltdown, while others are blown to pieces by localized civil wars and insurrections. Still others are said to have been devastated by a mysterious alien menace that people are only beginning to talk about. But there is a lot of crazy talk and wild rumors, so tales of alien invaders and monsters are mostly ignored. The Bugs arrived on the eve of the New Millennium. They are responsible for the worst of The Meltdown. And now they are on the move. People are finally beginning to realize the true horror of the global collapse of civilization. Multitudes of them try to spread the word and send a warning, but for some reason, they can not get the news out over the phone or the Internet. Could these monsters — these Bugs — have seized control of communications? Are they preventing the signals from getting through?

2001: Across the world, national governments collapse under the weight of social dissolution. Millions of people died in the winter of 2000, thanks to acute food and heating shortages coupled with severe weather. Millions more died in the violence that has carried over into 2001, and which shows no end in sight. Shattered communications networks have shut down and isolated people everywhere. They are on their own and don't know how their neighbor is doing fifty miles away (80 km). Rumors carried by word of mouth and the occasional ham radio operator suggest the government has completely collapsed and that dozens, if not hundreds, of American cities have burned and all are cut off from the rest of the nation. The fate of the Union (and the world) is in doubt. Terror reigns.

Meanwhile, it seems that talk of "alien invaders" is real. Some sort of intelligent "Bugs" have established a foothold on Earth. Coming from an alien dimension, these voracious predators somehow used the global surge in energy consumption as the catalyst for breaching the dimensional barrier between their world and ours. Millions of alien Bugs poured through in that initial invasion, converting their bodies into pure energy and infiltrating the world's electrical, cable, and telephone hardlines. Traveling along their lengths, the Bugs have captured power stations, communications networks, government installations, military bases, and other critical hardpoints in the span of minutes. Using commandeered military hardware and their own formidable abilities, the Bugs devastated the remaining free armies of the world in huge, multi-pronged strikes carried out with surgical precision.

By year's end, the Internet and the world's phone lines are back up and running, but they are completely controlled by the Bugs, who use them both as a means of instantaneous transport, and to disseminate lies and half-truths to the people of the world. With the power of mass communication and military force in their claws, the Bugs launch a massive campaign to pacify the world's cities of all resistance, and to bring as many humans to urban centers as possible. There, the Bugs employ a form of mind control to enslave millions of people and/or hold them

prisoner for the insidious purpose of implanting them with small, maggot-like creatures that erase their personalities and makes them willing zombie-like servant of the aliens. These "Bugged" humans are better known as "Silkworm Zombies" — a fate worse than death.

The world has no clue what the Bugs real intentions are, for there are few (accurate) news reports or reliable radio broadcasts (the vast majority are lies from the Bugs), nor a reliable national Military or authority one can turn to. Indeed, millions of people refuse to admit the Bugs even exist, so they welcome the propaganda that their respective government is valiantly struggling to pull itself back together and working to restore order.

2002: The Bugs' ploy does not work everywhere. The world's military forces, especially, are not fooled, and many units deployed in the field are not captured in the Bugs' first invasion wave. They regroup and launch counterattacks to reclaim their cities and free the growing droves of people held prisoner and having their minds permanently taken from them. In the U.S., *Operation Clean Sweep* intends to sever the Bugs' lines of communication along the Northeastern Seaboard so that the cities of Boston, New York, Philadelphia, Washington, D.C. and Baltimore can be surrounded and recaptured. New England and the Tri-State area are transformed into utter "craterzones" as the Air Force carpet bombs "Bugged" towns and cities in a desperate scorched-earth campaign. Navy subs and carriers hit the shorelines as the army moves in close on the heels of the bombing campaigns. Laying down tremendous firepower, the military slays hundreds of thousands of Bugs and human Drone soldiers.

None of it works.

Too late, the military realizes that the Bugs can draw on reinforcements from anywhere on the globe, at a moment's notice. And since the aliens' weapons are biological in nature, the Bugs also have no supply or logistics problems. But most importantly, the troops learned the hard way that not only can the Bugs travel through hardlines and take over electric and electronic devices, but they can also discharge beams of energy that render such technology inert. Entire bomber wings are knocked from the sky by tiny groups of flying Bug shock troops. Tank columns are halted and cut to pieces as their crews frantically try to restart their war machines. Without heavy armor and air support, the huge formations of ground troops sent into the "hot zones" are torn to pieces.

The people finally realize that the aliens are real and that human beings are no longer fighting to repel an invasion. They are fighting purely to stay alive.

2003: Decimated by the disaster of Operation Clean Sweep, the shattered remains of the American Northeast Military Command turns tail and flees. Casualties are estimated in excess of 80%. Most of the Coast Guard and Navy's fleets are captured or destroyed, but an undetermined number of nuclear submarines and a few surface craft (including at least one aircraft carrier) make it to deep water, where it is assumed they have managed to remain operational and Bug free. Virtually the entire northeast US and Canadian Air Force is destroyed, as are all Army and Marine forces. Elsewhere in the country, the Bugs launch fresh offensives against known military positions to prevent another Operation Clean Sweep. While the Bugs are victorious, they also sustain incredible losses (of both Bugs and Bugged humans, as well as hardware and resources). They are not eager to repeat the experience. By year's end, the U.S. Military orders all field personnel to disband.

Fully 80% of America's cities and towns are either destroyed or under complete Bug control.

2004: One city that remains free is Colorado Springs, Colorado, home of NORAD, the U.S.'s Supreme Nuclear Command Center. Early in 2001, NORAD commanders saw the writing on the wall and cut all hardlines to Colorado Springs and the outlying areas. As Operation Clean Sweep prepared for action, NORAD assumed control of the Rocky Mountain Command Center and recalled all troops to Colorado Springs amid great controversy. Numerous units refused to withdraw

from their posts and secede, forming their own commands. Of the units NORAD recalled, only 50% actually obey. Once they arrived, NORAD sealed the area and prepared for the worst.

For reasons unknown, the Bugs never hit the city. Most likely, because they are busy eradicating or capturing all opposition on both coasts and throughout the Midwest. By June, NORAD writes off every Metropolitan Statistical Area (MSA) as "Bugged Territories." These include any county with a large town or city in it that has fallen into enemy hands, unless NORAD receives information to the contrary. Since the Bugs seem primarily interested in holding onto sites of major electrical consumption and generation, they do not foray into rural areas very much. Thus, anywhere outside of an MSA is considered "Free America." Going by this strategic assessment, the U.S. and southern Canada are riddled with Bugged Territories. Certain areas, like New England and California, are considered entirely Bugged, as well as all of Canada from Windsor to Ottawa. Much of the American West, Central and Northern Canada and Mexico remain free largely because of a lack of hardlines, MSAs and power generation stations. But NORAD figures things will not stay that way for very long.

2005: By this time, North America's population has dropped an estimated 40% (possibly as much as 50%) since 1999, due to massive fighting, disease, starvation and exposure. Of the survivors, nearly 60% are in Bug custody, either refugees in Bug Territory, turned into zombies or held as prisoners and slave labor. Most are herded into urban centers. Slowly and methodically, the Bugs continue to turn humans into Silkworm Zombies. Fortunately, the rate at which the Bugs can actually produce Silkworms is far slower than the rate at which they can corral refugees. Thus, cities (now called "Bugtowns") become vast cattle yards where millions of stupefied humans await Silkworm implantation or are forced into hard labor. Silkworm Zombies (or "Bugged humans") use and deploy captured military technology as an expendable frontline against any future replays of Operation Clean Sweep and maintain/operate the existing power grids that the Bugs use for transport, food and getting high.

Outside of the Bugtowns, much of America lies in ruins, with deserted, bombed-out cities dotting a scarred landscape. Amid the wreckage, free survivors begin to rebuild tiny settlements using what little technology they can salvage or build. The legion of survivalists who took cover before The Meltdown are a kind of new nobility, with more weapons and supplies than most anyone else. However, thanks to their harsh treatment by society at large (who mocked them as mentally unstable misfits; which certainly applied to certain individuals before The Meltdown), most survivalists keep to themselves and refuse to share their supply hoards. Some act as supply depots and trading posts for those willing to trade in the new barter-based economy, while others simply live in isolation unwilling to deal with *anybody*. At the same time, bandits, thugs and thieves come out of the wreckage, preying on the weak and making Free America a dangerous playground of killers and despots. No place is safe anymore, and for many, the hopes of survival dwindle with each passing day.

2006: Generally considered "The Quiet Year," life continues much as it did in 2005. The Bugs consolidate their hold on the cities, with minimal expansion into the outlying areas. Several million additional people are lost to the Silkworm implantation process, bringing the estimated number of Bugged humans up to nearly 10 million, which is not even 10% of the total captured population of nearly 110 million.

Another hard winter, coupled with the tail end of the "Triplicate Plague" (a three-headed wave of disease started sometime during The Meltdown and widely believed to be the deployment of some kind of biological weapon), reduces North America's population by another 10 million. By now, Free America's population is estimated at somewhere between 40 and 60 million people, just a tiny fragment of the nearly 300+ million that existed before The Meltdown. However, during this time, the first of the "Bugtowns" is hit hard by armed resistance. The fighters claim to be members of the *Wyoming Free Irregulars*, an inde-

pendent army of militiamen and survivalists operating somewhere in the Great Plains. Throughout the country, other free armies form, initiating low-level guerilla warfare against the Bugs everywhere. While there are very few major engagements, and certainly no fighting on the level of Operation Clean Sweep, the militia movement lets the rest of Free America know that all is not yet lost.

2007: After a year of stockpiling, rebuilding and hardcore research and development, NORAD initiates the *Great American Bug Hunt*, a massive guerilla campaign to undermine the Bugs' hold on the nation's hardlines and population centers. At this stage, NORAD's activities are largely confined to scouting missions, pinpoint military strikes, and linking up with various militias and free armies to exchange hardware, training and information.

In the Badlands, those stretches of Free America ruled by droves of anarchists, bandits and Warlords, the first "bunker cities" are formed — large walled-off farming settlements armed well enough to hold off all but a large, concentrated attack. For the first time, the signs of civilization are returning to the wildlands, but there is much work yet to be done. Almost all of America is a chaotic combat zone where death and hardship are in abundant supply. Still, there is a grassroots movement of patriots and freedom fighters sweeping the land. Ordinary people are rising up, learning to become warriors and taking a stand. While it may seem impossible, they whisper that one day the Bugs will be destroyed or pushed off our planet and things will be made right again.

Meanwhile, Eggheads working at NORAD's underground laboratories make their first breakthroughs with *Organotechnology*, a form of bio-engineering and genetic manipulation that uses samples of Bug DNA to craft bizarre yet highly effective weapons, armor and equipment. Organitech devices are 100% invulnerable to the electrical disruption/neutralization of the Bugs and can not be controlled or rendered useless like conventional hardware. At the same time, NORAD also "graduates" its first class of *combat psychics* as well as its first platoons

of "Exterminators," hardcore commandos skilled in killing Bugs. Some Eggheads float the theory that the Bugs' intention has been to strip the Earth of its non-renewable energies, such as fossil fuels, all along. They believe that once the Bugs are finished with eating all readily available energy, they will most likely move on to the consumption or destruction of all bio-mass (people) on the planet, which they view as the dregs of what Earth has to offer in terms of food. And then they will move on to another planet to plunder. This theory contends that they are like locusts, moving from world to world in a never-ending cycle of consumption and conquest. If left alone, the Bugs are likely to leave the refugees and patriots of Free America unmolested, while they literally suck the planet dry, eventually leaving humanity with a broken and spent world barely capable of supporting life. If humanity is to survive, it has no choice but to fight. It must defeat the Bugs now, or surrender itself to a slow death. Note: This theory does not take into consideration widespread reports concerning the Presidential Assassination of 2001, in which the chief executive was killed on live television by a Bug who spoke cryptically about some kind of revenge. What exactly this means, nobody can say. It may have been a ploy to add to the confusion and chaos, or simply a wrong choice of words (except for Silkworm Zombies, the Bugs have a very poor understanding of Earth languages).

For all humanity, NORAD and its allies declare war on the Bugs. The Great American Bug Hunt is on.

2008: The first Bug counterstrikes are made in California, the Midwest, New England and Southeast Canada. The Bugs have grown tired of the ever increasing number of hit and run attacks being waged against them from the "free thinkers" (as they call free men) in the wilderness. Killer Bees, Army Ants and other Bugs leading small squads to legions of 100 to 1000 Bugs are sent to fight, as well as Silkworm Zombies deployed to lure humans out into the open to be captured or destroyed. More and more, the Bugs are becoming intolerant of those





who dare to resist and fight them, with the Killer Bee, Assassin Bug, Bombardier and Army Ant the most aggressive and murderous of the lot.

The race is on to save the planet. If the bugs are not stopped, all of humanity will eventually perish. The so-called Bug Hunt is unlike a conventional war with battlefronts and moving lines of captured territory, and it is unlike Operation Clean Sweep, in which a massed force tried to retake an entire city. No, this is the largest guerilla conflict in history, with millions of fighters striking here, there and everywhere, forcing the Bugs to spread themselves thin, to leave critical hardline nexuses open and to lower their guard at all of their Bugtowns. Hit and run attacks keep the enemy guessing, confused and angry — and an angry opponent is more likely to make mistakes and allow new opportunities for the freedom fighters.

The fighting is hardly easy, and human losses are high, but the Bugs finally begin to understand that the people of Earth are not going to take this invasion lying down. Through a network of radio operators, word of mouth and good old-fashioned couriers traveling on foot and horseback, the many militia groups, large and small, spread the word of their triumphs, sketchy plans for future strikes, enemy activity and weaknesses, and other bits of news and strategic information. NORAD confirms that similar offensives have begun in every other nation, with the fiercest activity in Europe, the Middle East, Northern Africa, Southeast Asia, the Pacific Rim, Australia, Southern Mexico, and coastal South America. The commitment is total, the fighting merciless, the stakes ultimate. This is the big one, a signal event that will write a new chapter in human history, or pen its sad, broken epilogue.

2009: Now! The battle continues, new heroes and adventurers appear on the scene, and your characters add to the saga being written for the pages of history.



An Atlas of Post-Meltdown America

The America of Systems Failure™ is a "Swiss cheese" battleground, where large patches of Bugged territory riddle the country as a reminder of the weird way in which the Bugs have decided to wage their war against humanity. With the virtual destruction of the government and wide-scale social meltdown, America 2009 scarcely resembles the country it was 10 years before. Now, the nation is broken into several smaller territories, and the old borders with Canada and Mexico mean little aside from a geographical landmark. Where there used to be cities and towns now lie huge "Bugtowns" — Bug Power Centers, bases of operation and human cattle yards where droves of one's fellow citizens are held captive by the alien menace, awaiting a fate worse than death. Outside of those terrible places lie the "patrol areas" en-

Land of the Free

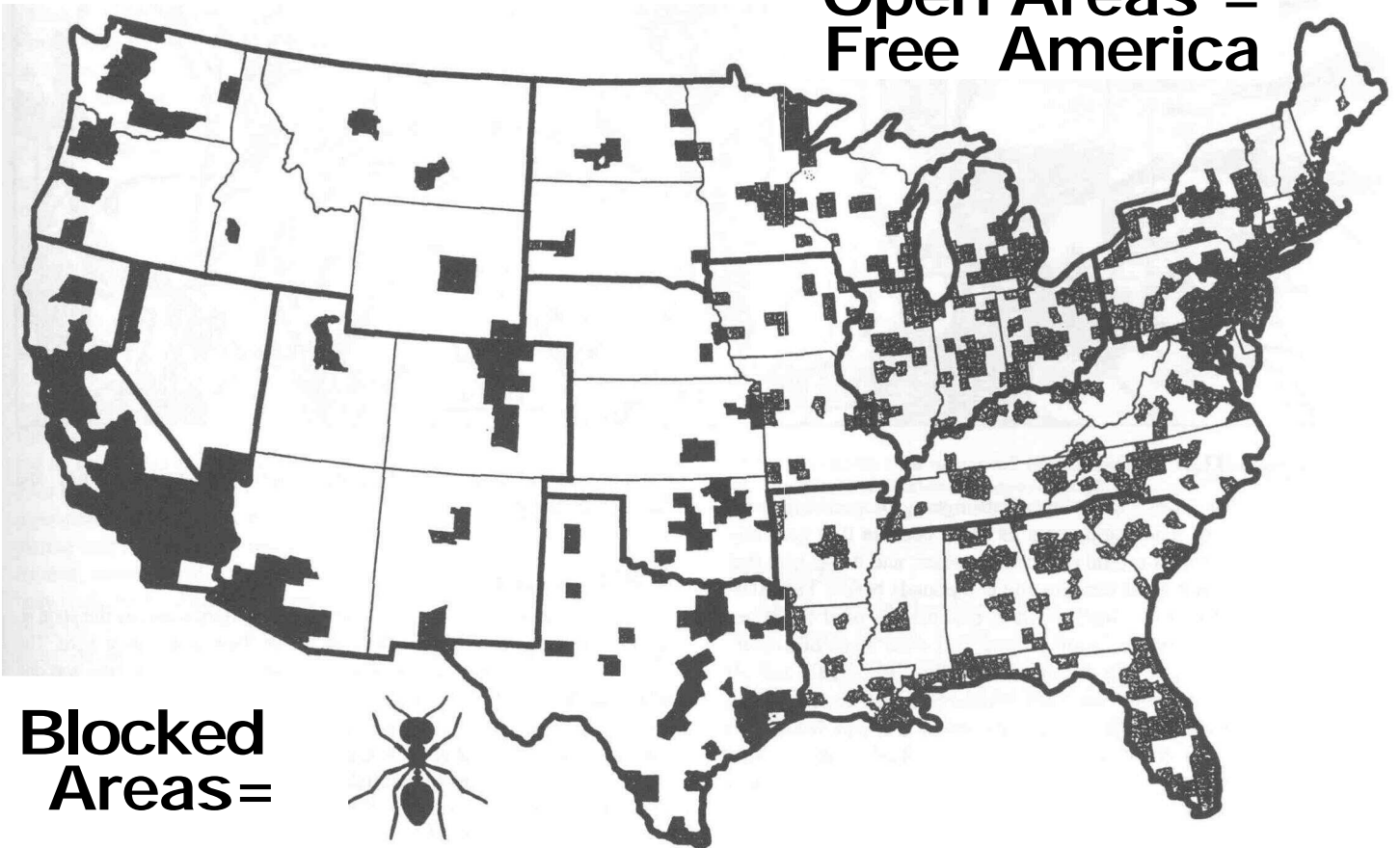

Bunkerville

forced by roaming Bugs and Silkworm Zombie patrols, and where bands of freedom fighters and militia armies (sometimes known collectively as "Irregulars," in reference to the famed *Wyoming Free Irregulars*), NORAD strike forces, and independent survivalists, farmers and never-say-die folks of all walks of life have taken up arms in the fight of their lives.

Beyond that lies the remnants of **Free America**, the places where the Bugs seldom go, and where chaos reigns. There is no law left, no social order to enforce acceptable behavior. Away from the military camps of the Great American Bug Hunt, away from the Bugtowns themselves, the land belongs to those strong enough to take it and hold it — all too often a seemingly infinite number of bandits, cutthroats, Warlords and thieves who have turned this nation into nothing but Badlands. Exactly how one patch of Badland differs from another is up to the player characters to see first-hand as they travel and adventure in a world gone mad. A nation controlled by sinister predators, both human and alien alike.



Note: Bugged areas likely to also house significant Bughunter activity.



Bunkerville

The Pacific Northwest, including Washington, Oregon, Montana, Idaho and Wyoming. This region gets its name because it is generally considered the survivalist capital of North America, and it was here that many survivalists built stout bunkers and compounds before The Meltdown. Now, many of these bunkers have become the seed for larger communities, loose networks, trading posts, and other signs of a resurgent civilization. Not that the original survivalists necessarily had all that in mind when they built their cozy catastrophe shelters, but thanks to their often-mocked foresight, life in this region is a little better than elsewhere. Thanks to the lack of hardlines, the Bugs rarely venture here, and Warlords have a hard time picking on the well-armed and sharp-sighted survivalists, militiamen and bunker hermits populating the region. Bunkerville is also home of the famous *Wyoming Free Ir-*

regulars as well as a half-dozen other noteworthy militias and Bughunter groups.

California

The whole state is Bugged. As extensively hardwired as the state is, it took the Bugs no time at all to establish their dominance here. The cities of California are in particularly bad shape since this state was one of the hardest hit during The Meltdown, when rioting and streetfighting were at their worst. Plus, a major earthquake rocked much of southern California in 2003 and another crushed San Francisco in 2005. All the Bugs cared about was reestablishing hardline operability and saving and rebuilding power plants. They have not rebuilt the cities at all, leaving buildings reduced to rubble where they lie. This has made the

California



Note: Bughunters generally consider the entire state bugged.

rains (and subterranean basements, tunnels and cave-like compartments hidden within collapsed buildings) into shabby sanctuaries where free human refugees (and to a lesser degree, freedom fighters) can hide. The few urban areas cleared of wreckage have been turned into *huge* holding areas for enslaved humans and those awaiting *Silkworm* implantation. Already, vast legions of Zombies operate key manufacturing plants, and large conventional fleets of vehicles, including tanks and gunships, and even some Navy and Coast Guard vessels along the coast. Some people believe that a portion of the California Fleet, also known as the "Losandiego Armada" remains free and un-Bugged, and roams the deep ocean, returning to the coast on hit and run missions to shell Bugtowns and liberate their human captives. However, like many stories circulating in Free America, one does not know if this is true or pure fantasy — wishful thinking.

The only spot of freedom in the state is an enclave of programmers from Silicon Valley who got out when The Meltdown first got serious. These guys have been on the run ever since, trying to stay free, alive and to gather together as many programmers as possible. The lot of them have hid out in the northlands of the state for a few years, using super-powerful notebook computers on the sly to do research and exploring ways to bypass, usurp and countermand Bug control of the Internet, communications and electronic networks. Now, if only somebody could be kind enough to escort these beleaguered programmers to NORAD or some other safe haven, they might be able to share some really interesting observations, ideas and new software applications they have designed. Things that they insist could help push the Bugs off this planet within a decade, tops. Rumor has it that they have developed some kind of experimental, radically advanced photovoltaic technology, a cheap form of Bugproof technology, and a way to hack into Bugged machines and regain control of them remotely. If true, these represent tremendous breakthroughs in combating the Bugs.

Area 51

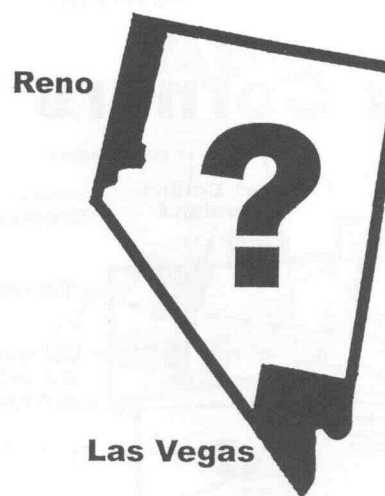

Note: This entire state is a mysterious dead zone from which no scouts ever return.

Note: Reno and Vegas are assumed to be bugged but have not been verified as such. Both cities are silent.

Area 51

Nevada. *Everybody* who enters this place, Bug and human alike, is said to never return. Word is a top secret pre-Meltdown government project is responsible, but nobody knows exactly what it is or who it involves. If NORAD knows anything about it, it is not letting on.

Dakota

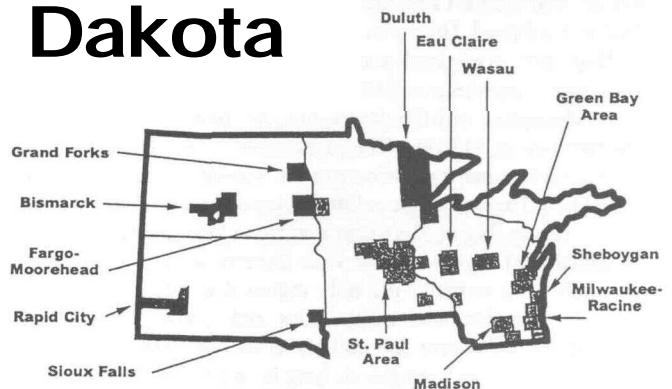

Note: Dakota has some of the heaviest free militia activity in the United States. Numerous groups use old missile silos as secret underground bases safely hidden from the Bugs.

Dakota

Also known as "Northern Fargo," this underpopulated region consists of North Dakota, South Dakota, Minnesota and Wisconsin. It is a weird mix of survivalists, woodsmen, hunters, farmers, anarchists and a surprisingly high number of small, friendly towns who have remained largely untouched by the madness around them. They are heavily armed to keep away marauders, and some have completely forsaken modern technology (steam power is the best one can expect). However, for genuine Bughunters and trustworthy adventurers, every door in Dakota is open and inviting. Sadly, outside of these small rural communi-

ties, all the big towns and cities have either been destroyed (about 50%) or Bugged!

The Twin Cities of Minnesota and large parts of Wisconsin are heavily Bugged, but because there is not much militia activity going on here, the region currently plays a relatively small role in the Great American Bug Hunt and the Bugs here feel snug and secure.

Four Corners

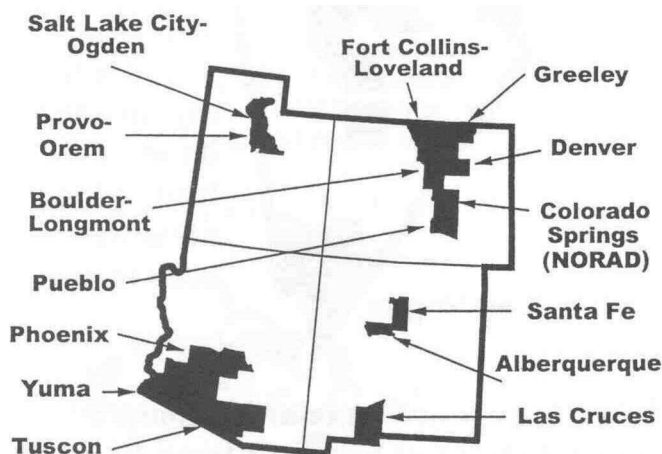

Note: The areas surrounding Colo. Springs remain bugged, but NORAD has cut their hardlines. Fierce street wars have all but reduced these zones to rubble.

Four Corners

Utah, Colorado, Arizona and New Mexico. Just before The Meltdown, Arizona became a popular destination for retirees, so by the time the Bugs showed up, vast stretches of this otherwise undeveloped state were freshly hardwired. However, with few major sources of energy to tap, the Bugs kept a minimal presence here and have been relatively easy to contain. Elsewhere in Four Corners, particularly in and around the Rocky Mountains and the desert, one can find some of the most Bug-free territory in America. The presence of NORAD headquarters in Colorado Springs helps contribute to the minimal presence of Bugs. Between NORAD and all of the military units and volunteers who have come to join it, any Bug or Silkworm Zombie in the vicinity is immediately squashed hard. This has made Four Corners an oasis in an America gone mad. It is virtually the only region that still resembles old pre-Meltdown America with many cities and towns functioning at 70-85% capacity. Of course the military is an omnipresent force and numerous precautions and safeguards have been taken to keep the Bugs from invading (or quickly contained and destroyed if they come). Moreover, gang activity is sparse to non-existent because even the boldest bandits have the sense not to take on a huge, heavily fortified military community.

Still, with all of the military activity and vulnerable electrical machines and (amazingly) free power plants, most people from outside the region are reluctant to settle here for fear of a Bug counterattack that seems inevitable. So while some people have taken to the desert and mountain wilderness to live, many stay out of Four Corners entirely. Those who do pass through usually keep their distance from the wonderfully advanced and well equipped communities and military outposts of the region.

Flatland

Note: Nebraska and Kansas host the highest numbers of Bughunters in Flatland, due to the sheer lack of hardlines and Bugtowns.

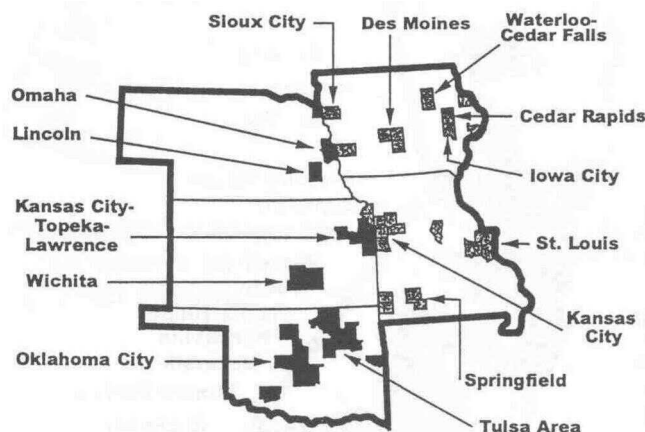

Flatland

Consisting of Nebraska, Kansas, Oklahoma, Iowa and Missouri, Flatland represents a huge portion of Free America with a sprinkling of fortified towns, tiny farms, scattered homesteads, the occasional bunker, and trading posts. There are, throughout the region, a large number of old ICBM silos that various survivalists have claimed and refurbished as underground homes, secret hideouts, storage depots, and command bunkers (as many as 100 people can live comfortably in most retrooled missile silos). The most impressively refurbished and comfortable silos are the ones bought from the government and refinished before The Meltdown (there were over 150 sold in these states before the year 2000). It is rumored that the *Wyoming Free Irregulars* have a network of silo bunkers they keep just for the purpose of quickly hiding from the Bugs.

Flatland also is wide open wilderness to militiamen, adventurers, mercenaries, anarchists, bandits, gangs, and Warlords, as well as one of the regions coming under fire by Bug swarms and infiltration from Silkworm Zombies. The high quality of the land makes food plentiful, which is one of the reasons so many groups are willing to fight over who controls the region. So far, the bulk of Flatland's "fruited plains" have remained unscarred by The Meltdown, Bug Invasion and the Bug Hunt, with the hardest hit and shattered areas being cities and towns (most of which, roughly 80%, have been destroyed rather than Bugged). With any luck, it will continue to go untouched as the war continues and will play a large role in the survival and success of Free America. But you never know, some rogue militia or an especially mean-spirited Killer Bee might find some good in destroying the millions of acres of farmland here and causing a massive famine. These are crazy times, and people and Bugs are willing to consider anything.

Texas

The Lone Star State has major Bug problems. The Dallas/Fort Worth metroplex as well as Houston and most cities and towns along the coast of the "Golden Crescent," where the world's highest concentration of oil refineries and petrochemical plants can be found, are completely dominated by the Bugs. The invaders also find rural Texas valuable property because of the prospect of hitting oil and as grazing land for cattle required to feed its growing legion of Silkworm Zombies and human slaves.

Not ones to give up easily, Texans have responded to the heavy infestation with a special kind of pride and passion. Consequently, the Bug Hunt rages more fiercely in Texas than just about anywhere else.

Note: Texas Bughunters reportedly plan on declaring the state a sovereign nation once it is Bug-free. Until then, city fighting remains vicious & intense.

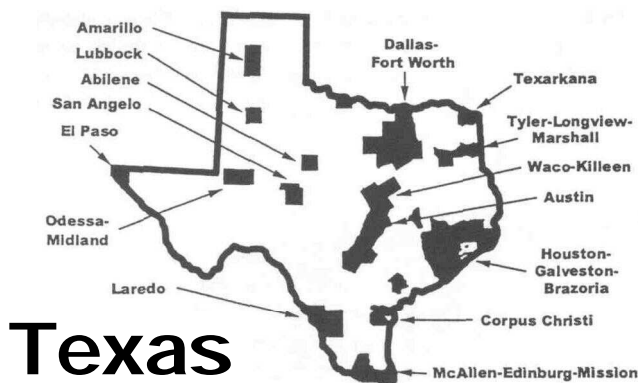

Texas

Many free armies routinely raid Bugged facilities and, from time to time, retake particular installations, if only for a short while. One militia reportedly has commandeered a number of mobile exploratory oil drilling rigs and uses them as offshore attack platforms to launch gunship and patrol boat raids on the Golden Crescent and elsewhere. With no hardlines leading to these miniature cities on the water, the many oil platforms in the Gulf of Mexico are held by human resistance fighters and have formed a loose coalition of Bughunters and survivors that refer to themselves loosely as the "Gulf States."

It is interesting to note that the battle to seize control of these "strategic" platforms and oil fields is constant and rigs change hands regularly. The reason is that neither the humans or the Bugs want to destroy these valuable resources, and both sides take great pains to prevent them from being seriously damaged. From the human point of view, better to retreat and escape to fight another day and let them fall into enemy hands (just for the moment) than risk losing them forever. Oil, gasoline and petroleum products are scarce enough as it is; this way, human resistance fighters keep getting the chance to get control this valuable resource to literally fuel their war. The Bugs share a similar view and need for fuel.

Dixie

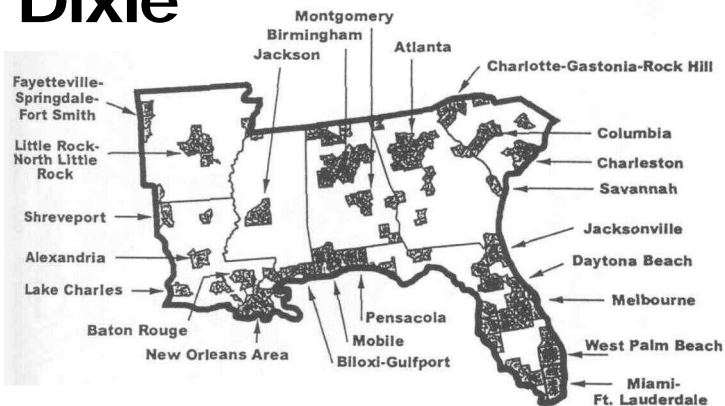

Note: A massive haven for Bugs, militia, bandits and warlords.

Dixie

The Deep South: Arkansas, Louisiana, Mississippi, Alabama, Georgia, South Carolina and Florida. What isn't Bugged is the province of self-proclaimed Warlords, kings and militias, most of whom fight each other more than they fight the Bugs. This provides for a balkanized semblance of social order, as the various militia-led bunker towns feud incessantly.

The **Swamp Rats** of Florida, the **Gendarmes Rouge** in Louisiana and the **Razorbacks** of Arkansas are notable militias in both the Great

American Bug Hunt as well as internecine fighting among human factions. Coastal Dixie also receives helpful fire assistance from the Gulf State offshore attack platforms, which periodically hit targets in Louisiana (the northern tip of the "Golden Crescent," and coastal Bugtowns like Gulfport), and numerous settlements on Florida's west coast.

Appalachia

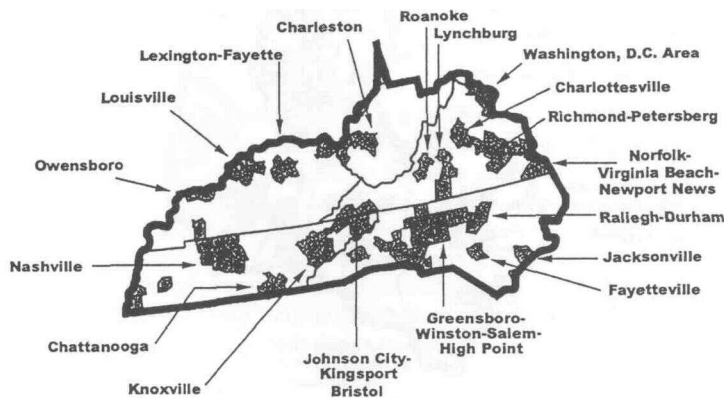

Note: This region is home to numerous militias of note, as Fort Knox and several other secured government sites.

Appalachia

Kentucky, Tennessee, North Carolina, Virginia and West Virginia. Largely Bugged along the coast, especially near the District of Columbia and the larger cities of North Carolina, but once you head west a little bit, you enter Bughunter Central, where *very* heavily armed patrols of militia, freedom fighters, mercenaries, adventurers, gangs and over-eager survivalists stake their claims amid the mountains and valleys. Since so much of this region was never developed, the lack of hardlines has given Bughunters and patriots plenty of refuge in which to hide. Most major cities and large towns have been destroyed or turned into Bugtowns. Nashville is a major Bug Power Center and the primary base from which Bug swarms, hunter-killer squads, and Silkworm Zombie spies and saboteurs are mercilessly launched on military missions to destroy the Appalachia and Dixie free thinkers. These Bugs are incredibly vengeful and murderous, preferring to kill rather than take captives, and destroying farms, homesteads and bands of humans wherever they are encountered.

The **Kentucky Headhunters** are a particularly famous Bughunting militia that hails from these parts as are a number of lesser known "Critter Posses."

Motown

Illinois, Indiana, Ohio and Michigan. This is one of the most heavily Bugged regions in the country with virtually every major town and city along the Great Lakes under Bug domination. It is also one of the regions with the largest number of Silkworm Zombies (believed to be well over three million) and contains the largest number of human slaves as well. The large number of Silkworm Zombies — human in their appearance — are so prevalent that entire small towns are inhabited by them and it is easy to mistake one for a fellow free man until it is too late. This heavily industrialized region, from lower Michigan and Chicago, sweeping south, has been infested with Bugs and Zombies, making this one of the few regions where even the rural areas are not safe.

None of this has deterred the more staunch freedom fighters from operating in "Motown." In fact, many see it as a challenge. And while there are hundreds of Bugtowns scattered throughout the area, there are also large areas of wilderness and hundreds of lakes, rivers and marsh-

Motown

Note: This area is very heavily bugged.
Aside from numerous pirate radio operators,
Motown has little organized human resistance.



lands where one can hide or use to make good an escape. Thus, Motown is under constant attack from hit and run raids, surgical strikes, sabotage, and rescue missions ("Free the slaves!").

A maverick militia known only as the **Cadavers** reputedly plans to attempt to deploy biochemical weapons in the region, hoping to devastate its crop production and cause the thousands of human zombies here to starve to death. Of course, that action would also result in the deaths of the several million human slaves in Bug custody that have not yet been brainwashed, but to the **Cadavers** (predominantly anarchist and

evil extremists), they feel the sacrifice is worth it. This group of "freedom fighters" (and we use the term loosely) is hated and feared by many refugees and other militia groups in the area and have been known to engage in banditry and to attack, bully, cheat and extort adventurers, travelers and other patriots. The leaders of the group are fascist power-mongers who seek personal fame and power (they hope to one day claim the Detroit or Chicago area as their own independent Kingdom).

Bugland U.S.A.

Maryland, Delaware, The District of Columbia, Pennsylvania, New York, New Jersey, Connecticut, Rhode Island, Massachusetts, Vermont, New Hampshire and Maine. This entire region is the most intensively and extensively Bugged part of the U.S.

New York City is considered the Bug Capital of the country because there are over six million humans held captive there and an estimated 2-3 million Silkworm Zombies, along with at least a million Army Ants and swarms of other Bugs in the city alone. Numerous militias assume that Bugs in other regions receive their orders from New York, but in reality, nobody really knows where or how the Bugs' informational and command hierarchy is structured.

In Bugland U.S.A., central Pennsylvania, eastern Long Island, Cape Cod, and parts of Vermont, New Hampshire and Maine are the only places where any significant Bug hunting is carried out. But, the groups active here must remain small and always on the move, due to the insanely high presence of Bugs and their zombies.

Much of this region has an eerie, "ghost town" feel to it as the Bugs have pulled most of the survivors into one of the major cities in New Jersey and other places near New York City. This has left hundreds of thousands of abandoned houses, farms and buildings — often entire in-



Note: Virtually this entire region is bugged. New York City is the defacto HQ for all Bug activity in the U.S., Canada and Mexico. HUGE Silk-worm camps sighted in this region.



Bugland, U.S.A.

dustrial towns left to slowly crumble away. Scavengers and Freebooters are generally too afraid to risk discovery from the Bugs to go scrounging around these places, and Killer Bees are seen buzzing these ghost towns on a regular basis looking for prey.

The Great White North

Canada and Alaska. Intelligence on Canada is sketchy, but it is widely assumed that most of southern Canada, especially Ontario, Quebec and the Atlantic Provinces, are heavily Bugged. NORAD generally considers the following Canadian cities to be Bugtowns, although intelligence on many of them (especially north of the 60th parallel) is incomplete: Windsor, Hamilton, Toronto, Ottawa, Montreal, Victoria, Vancouver, Calgary, Saskatoon, Regina, Winnipeg, Thunder Bay, Quebec, Fredericton, Halifax, Prince Rupert, Prince George, Edmonton, Moosonee, Charlottetown, Sydney, Whitehorse, Watson Lake, Hay River, Yellowknife, Churchill, Chisasibi/St. George, St. John's, Dawson, Echo Bay, Kangiqcliniq (Ranklin Inlet), Iqviq, Schefferville, Happy Valley - Goose Bay, Inuvik, Cambridge Bay, Repulse Bay and Iqualuit (Frobisher Bay).

Juneau, Alaska is known to be Bugged, although Kodiak is thought to remain free. All other major Alaskan settlements — Valdez, Anchorage, Fairbanks, Bethel, Nome, Barrow and Prudhoe Bay are also written off as being in enemy hands, but they are only assumed to be "Bugged" and have not been verified as such. It is possible that they are relatively free.

Big Sur

Mexico. As far as NORAD can tell, what organized resistance there was in Mexico was crushed in the Battle of Mexico City, in 2002, when the Federal Mexican Government launched an Operation Clean Sweep of its own, with similarly unwelcomed results. Since then, the population centers of the country have pretty much all fallen to the Bugs, and the rural areas have become the domain of bandits, nomads and gangs.

Cities either confirmed or strongly suspected to be Bugged include: Tijuana, Mexicali, Ciudad Juarez, Hermosillo, Chihuahua, Matamoros, Monterrey, Torreon, La Paz, Mazatlan, Tampico, Leon, Guadalajara, Mexico City, Veracruz, Puebla, Acapulco, Oaxaca, Merida, and Cancun. Despite the fairly grim overall picture in Mexico, NORAD is

beginning to receive reports that there are actually a high number of freedom fighters organizing in the mountains and wilderness areas, as well as the jungles of the Yucatan Peninsula. There are unconfirmed reports that these patriots have discovered, in an ancient crater in the Yucatan, some kind of artifact or archaeological evidence that suggests this is not the Bugs' first visit to our world.

Home of the Brave

Life is radically different now than it was before The Meltdown. The entire network of communications and technology we had grown so dependent upon is gone entirely, almost overnight. Just think about that for a second. When was the last time you went without Internet access for a month? Or when was the last time you went without television for three weeks? Or the last time you had no power for more than an evening? When was the last time you cooked your food over an open fire because you had to? When was the last time you actually raised your food yourself? Washed your clothes by hand? Built a shelter? Defended yourself from looters? Went without medicine, regardless of how sick you got? Walked *everywhere* you went? Bartered for goods and services?

Without any warning and virtually no preparation, the ordinary, non-adventuring folk of this world have been thrust back over a century in time, technology-wise. Many people could not handle the change and died or went mad. Those tough enough to stick it out found themselves living the life that their great-great grandparents lived. Nowadays, most ordinary folk are farmers, hunters, scavengers, or simple craftspeople, living simple, difficult lives full of long hours of labor and hardship. Of course, they are the lucky ones, because they are free.

Day to day survival and making a living raising crops or livestock is the least of their worries. Most of these folks are caught squarely in the crossfire of roving gangs, would be Warlords, Splatterpunk gangs, NORAD strike teams, militia armies, and Bug swarms. Those who are not must still contend with the elements, a lack of resources and technology, and physical and emotional isolation from their fellow citizens. This is not only a dangerous time, but a lonely one, as nearly all lines of communication are too dangerous to use, lest they bring the Bugs.

There is virtually no mail service. There are no telephones. Some radio operators let folks use their equipment to get in touch with family or newly made Bunker Towns and other settlements, but even this flirts with danger, for the Bugs may try to triangulate multiple transmissions and come calling when least expected.

Having grown used to instant communication to anyone in the world, people had to adapt to comparative isolation, seclusion and word of mouth. Current news may be weeks old, definitive facts are hard to come by and rumor and outright falsehoods are commonplace.

Among the common folk, some have become hard or angry people, others bitter, and most are pragmatic. Unfortunately, the "survivalist" attitude combined with old Y2K. paranoia and the trauma of The Meltdown has provided fertile ground for people to find something, anything to blame for their ills. Thus, many people believe in some freaky and convoluted conspiracy theory that explains why they are in this dire predicament. While most folks do not use this as an excuse to persecute racial and religious groups (strangely enough, the threat of the Bugs has largely united American society, eliminating nearly all past religious and racial intolerance — the one good thing that was born out of The Meltdown), some do use it as an excuse not to join wilderness communities, not to offer assistance to militias or NORAD strike teams, or to help strangers. Better to not get involved at all, even if it's the right thing to do.

While a survivalist and loner mentality has pervaded the national consciousness, most people also feel proud and independent. There remains an air of positivity and strong sense of purpose. Some have likened it to pioneer courage, ethics and hard work. Thus, although



scattered across the country with miles of wilderness between one person and the next, there are surprisingly few (in the big scheme of things) who are hoarders, cutthroats or indifferent. It is the rare individual who believes one must, "hoard what you find, refuse to share, don't stick your neck out, shoot trespassers first and ask questions only if you feel like it." Most are compassionate and quick to lend a helping hand, a kind word and at least some meager provisions, even to a stranger in need, especially if that stranger seems to be (or even looks like) a good person or is clearly a freedom fighter.

The changing tide

The reason it has taken roughly eight years for Americans to gather their wits and begin to seriously reorganize and oppose the enemy, is that the American psyche was shattered.

America stood as an economic and military superpower before The Meltdown. Without warning, it was suddenly all gone. From riches to rags. From superpower to slave or refugee in their own homeland. The American psyche was simply unprepared for the traumatic change. The shock was tremendous, and for years people lived in denial. National pride and a sense of security was replaced with the ultimate humiliation: occupation by a seemingly unstoppable enemy. Never in her history did the United States have to contend with a serious foreign invader, and to many, the very notion of it seemed impossible. Monstrous invaders from another world changed all that overnight. When the Bugs came and finished destroying an America in turmoil, her people felt completely defeated and lost. Without the government to lead them or technology to help them, chaos reigned and the inky clouds of fear and desperation settled over the Home of the Brave. A great sadness and overwhelming sense of loss permeated the land. It took years for most people to come to grips with these cataclysmic changes, and to adapt and respond.

Now that a few heroic and scrappy individuals have dared to challenge the genocidal tyranny of the Bugs, new rays of hope appear every day. Hope carried by unlikely heroes has broken through the gloom and doom, bringing light to those lost in darkness and sparking a new sense of strength and empowerment. The general consensus is that Americans have suffered and survived the worst. That they currently sit at the bottom of the barrel — their fate to be lobotomized and turned into zombies, enslaved, or killed unless they stand up and do something about it. And standing up they are. Every success, no matter how small, fuels their spirits, renews their pride, and gives them the will to resist. Every Bunker Lord of the Northwest who repels a Warlord army and sets things straight shows what can be accomplished when people set their minds to it. When a fortified town can repel a Bug attack, or a scraggly band of freedom fighters slays a Bug squad or rescues a prisoner, and secretive NORAD forces can rout an entire Bugtown and free its enslaved people from oblivion, then there is hope for all.

The really scary thing for most people is that they believe in themselves again. They engage in a mounting guerilla war against an inhuman enemy with superior resources, and yet they can taste pride and freedom on the passing wind. They lust to reclaim their homeland and dream of saving the world. In some ways it was easier before, when there was no hope, because there was nothing left to lose. Now, that America has found itself again, and freedom is more precious than ever, most can not bring themselves to consider that they might not succeed. Americans have always reveled in the role of the underdog. It is a role that seems to inspire and motivate. It is a role they accept now with renewed vigor and determination. "America *shall* be free," is the cry that rings across the land.

The Bug Hunters

For now, there is no one unified army of human freedom fighters. Instead, resistance is splintered between hundreds of small factions, some of whom spend as much time fighting each other as they do fighting the Bugs. Cultural differences, lack of communication (leading to misunderstandings and clashes), and the desire not to grow too big and vulnerable (being bigger makes it easier for the Bugs to find you) are what keep the resistance so splintered and diverse.

For the most part, the majority of actions against the Bugs are carried out by tiny militias, gangs, clans, and groups of independent patriots and adventurers. The odd NORAD strike team is the exception, not the rule, but all take part in the Great American Bug Hunt, and contribute to the war effort. Ironically, these independent individuals and groups of guerilla fighters are likely to succeed where Operation Clean Sweep failed, and may be a prelude to a massive, more conventional war in the future (spearheaded by NORAD?).

NORAD

The North American Aerospace Defense Command was originally a bi-national command involving the United States and Canada that provided warnings of missile and air attacks against both nations. It was also responsible for safeguarding the air sovereignty of both countries and for providing air defense forces for defense against an air attack. Based in a vast underground complex in Colorado Springs, Colorado, NORAD is one of the most fortified military installations in North America.

During the first phases of the Bug Invasion, NORAD cut all of its hardlines to the outside world and fortified Colorado Springs against any Bug attack. After Operation Clean Sweep, many Army, Marines and Air Force units retreated to Colorado Springs, making NORAD the new supreme command post for the U.S. military.

For the next several years, NORAD made extensive plans for what has now become the Great American Bug Hunt, a nationwide wave of guerilla warfare against the Bugs. Pending the success of the Bug Hunt, NORAD will move out its heavy armor and air units to begin a widespread conventional war against Bugged territories in a no-holds-barred bid to free the continent from its alien invaders. However, still mindful of the crippling disaster that was Operation Clean Sweep, NORAD is extremely (even painfully) conservative with what forces it will deploy, so for the moment, most of its activity consists of sending small strike teams against carefully selected Bug targets, or to fortify independent militias and Bug hunting groups.

Most importantly, NORAD Eggheads have spearheaded a number of radical research and development programs aimed at providing humanity with unstoppable secret weapons. The first is the **NORAD Psychic Program**, a regimen of recruiting and training that has turned out a small legion of psionic warriors whose incredible mental powers make them invaluable Bug hunting personnel. The second is **Operation Doppelganger**, an ultra-secret directive to create the NORAD Splicers, a group of genetically modified commandos whose infusion with Bug DNA makes them superhuman Bug hunters and killing machines. The third, and most publicized, is the **Consortium of Organotechnology Projects** which have produced a wide range of new weapons, armor and equipment that resembles a cross between conventional technology and genetic engineering. Using Bug DNA and several secret processes, the NORAD Eggheads have created a "breed" of organic, living devices that use bio-energy as their power source, and as such, are invulnerable to deactivation or infiltration by the Bugs (e.g. impervious to Machine Union). Plus, the high power and versatility of these devices gives the average NORAD trooper in the field a distinct advantage against humanity's insect adversary.

NORAD represents the primary hope for reestablishing government and society in North America. To anyone's knowledge, there is no other Bug hunting organization so large, well-equipped and organized

in this part of the world. Most Meltdown survivors consider NORAD a hero organization that will one day kick the Bugs off the continent, if not the planet. While NORAD might not see itself through such romantic eyes, it realizes that its efforts stand the greatest chance of reclaiming North America, and perhaps the world, thus saving humanity from extinction. To that end, NORAD has several strategies in mind.

1. The Great American Bug Hunt. As mentioned before, this is a wave of guerilla warfare instigated by NORAD to strike the Bugs everywhere in an endless barrage of low-level insurrections. The goal of this is to stretch the Bugs' resources so thin that important targets, like certain hardline nexuses or Bugtowns, become vulnerable. The secondary goal of the Bug Hunt is so NORAD can study how the Bugs react and launch surgical strikes and countermeasures to exacerbate their losses (and decline). It is the hope of NORAD's Supreme Commanders that they will learn the Bugs' command and informational structure, so that they might also find a weakness in it and exploit it.

The tertiary goal of the Bug Hunt is simply to get ordinary North Americans to take up arms and fight the alien menace. Whether or not this actually hurts the Bugs seriously, NORAD feels that by galvanizing the continental populace to defend its homeland, people in general will support any future conventional war against the Bugs and will be happy to give the offensive whatever support it needs. To fuel the "Bug Hunt," NORAD has helped to supply (but not usually train) militia groups and even individuals who attract their notice with basic military ordnance, ammunition and fundamental supplies. As part of this campaign to arm America, trading posts in *Four Corners* offer guns, namely .45 automatics, revolvers and a few types of rifles and the corresponding ammunition and gear such as canteens, fatigues, blankets, utility belts and backpacks at amazingly low prices. Four Corners also supplies numerous Freebooters at fair prices in hopes they will help to get weapons and gear to freedom fighters elsewhere in Free America as well as those operating deep in Bug Territory.

NORAD also tries to encourage insurrection against the Bugs by supporting independent radio operators and spreading stories of human triumph by word of mouth. They have found such lines of communication help to inspire Americans to take arms and build morale.

2. The Killer App. In conjunction with numerous Silicon Valley Eggheads who escaped California before it fell entirely to the Bugs, NORAD is working on developing a single means of neutralizing the Bug menace everywhere in a single blow. Code-Named the "Killer App" project, it was begun in the aftermath of Operation Clean Sweep and continues today in a variety of forms. None of them are particularly promising at the present time.

The most prominent directive focuses on developing a means of rendering the world's hardline infrastructure uninhabitable to the Bugs, thereby cutting off their primary source of communication, transportation and attack. If this can be done, NORAD feels that a conventional war against the Bugs could actually work. Until then, however, the Bugs maintain a supreme advantage over human forces.

Another Killer App project involves developing a biological warfare agent that would affect only Bugs, and no native Earth flora or fauna. The development of the **Bug Juice** Organitech weapon was a promising start, but now, NORAD Eggheads seek to create a virus or bacteria that will target Bugs as ruthlessly as Ebola does humans. The idea is that as fast as Bugs travel through their hardlines, they would be able to infect millions of other Bugs who they encounter after they pop out of hardlines (disease is not likely to have any effect on them in energy form). The problem is, that the Bugs appear to be impervious to all known Earth disease. Moreover, for this to work, a virus must be engineered that can survive the bio-energy conversion process. So far, none of NORAD's viruses have been even remotely successful. Clearly, this project has a long way to go.

An equally long-shot idea is a rekindling of the old SETI (Search for Extraterrestrial Intelligence) project, except instead of looking to the stars, NORAD Eggheads are trying to peer into the

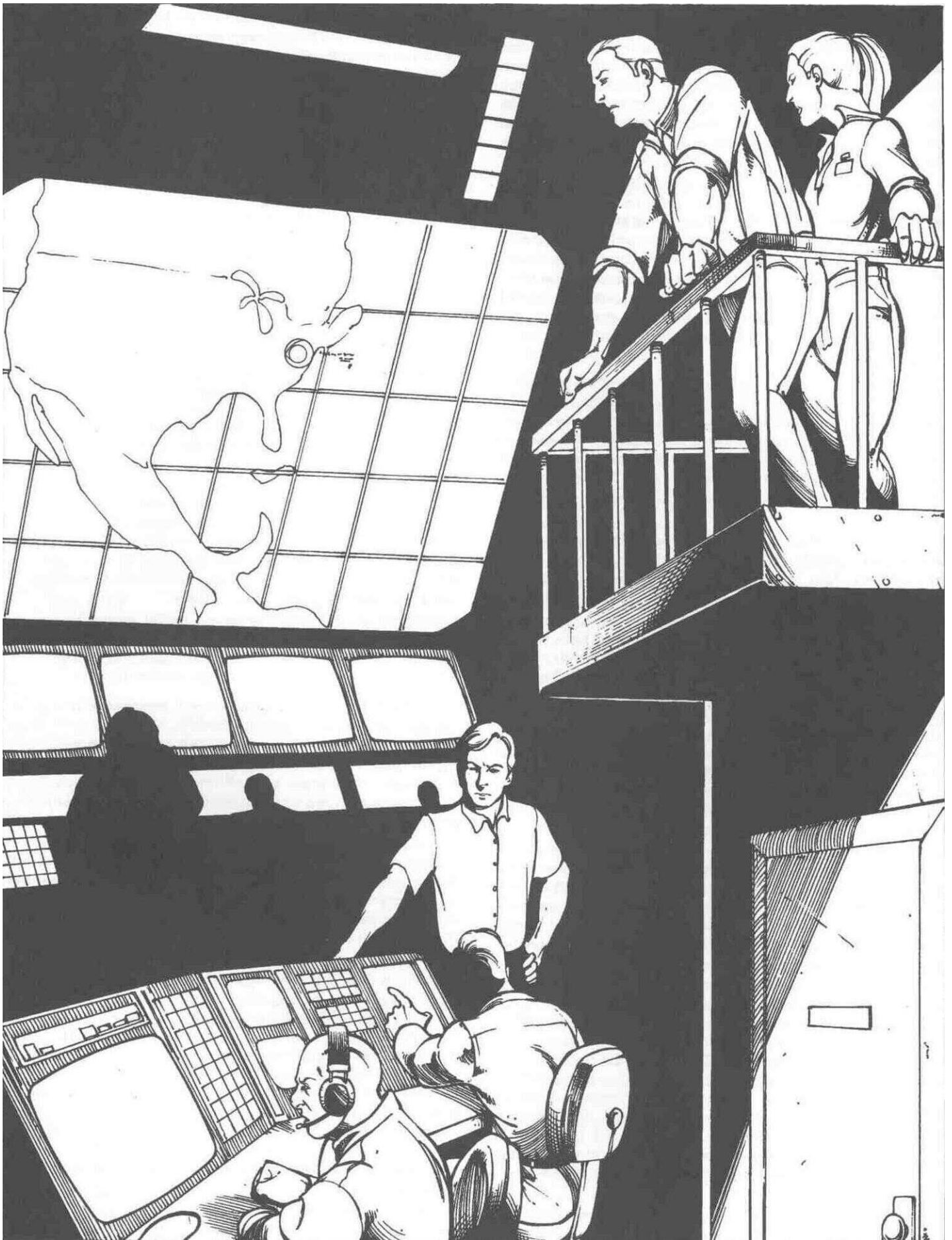

interdimensional fabric through which the Bugs launched their invasion. They hope that somewhere in another dimension, or on the other side of the dimensional wall, the Bugs have an enemy (albeit another race of aliens) who we could persuade to help fight the Bugs. This project is very controversial and only in its infancy (NORAD has yet to even break the dimensional barrier).

The final Killer App project is the most dramatic one, **Operation Spoilsport**. In a nutshell, it involves a simultaneous detonation of all nuclear weapons still in their storehouses throughout the U.S. as a way of rendering the world undesirable for the Bugs to occupy it any further. Operation Spoilsport is a "final option" plan designed for implementation only if NORAD looks like it will fall, or if the rest of the world has been undeniably conquered by the Bugs. The plan got its start when NORAD locked down all nuclear silos and had their hardlines deactivated so the Bugs could not gain access to America's nuclear arsenal. While NORAD assumes the Bugs probably have some nukes, they have not accessed the majority of the U.S. nuclear stockpile, especially its ICBM fleet. One of NORAD's most pressing responsibilities is making sure the Bugs never get the launch data to those missiles, either by hacking into the silos themselves or by taking out NORAD. As NORAD's commanders made plans for safeguarding its nuclear information, it decided that Operation Spoilsport had to be set up as a contingency. A grim contingency, to be sure, but if it is ever used, it will be because the Bugs have conquered the world, and NORAD figures the last act of human defiance should be its most powerful one, for by that time, we will have nothing left to lose.

3. Operation Landslide. This is the conventional phase of NORAD's long-term strategy. Provided that the Great American Bug Hunt works well, or if one of the Killer App strategies (aside from Operation Spoilsport, of course) works out, launching a massive conventional military attack will be necessary to liberate the largest Bugtowns and to establish large Free Zones where freed human prisoners can be relocated. If given the green light, Operation Landslide would begin with an all-out land and air attack against the major cities of California, which is a major center of Bug activity in the west. The hope is that by hitting California, the Bugs will draw down reinforcements from the East Coast and elsewhere to defend the State. NORAD hopes to draw as many Bugs as possible using normal conventional weaponry, and then launch a carpet bombing attack with planes loaded with Bug Juice bombs as well as conventional explosives. Other goals of this operation include the destruction of key power facilities, the cutting of hardlines and the liberation of the Bugtowns in San Francisco, Fresno, Los Angeles and San Diego. Meanwhile, bugged human forces from the east will be met by NORAD reserves and the federated militia forces of Bunkerville, Dakota and Texas. With any luck, those forces will provide a defensive wall that will repel the Bugs advance long enough for an assault on California to work. They will also encourage and coordinate simultaneous, independent freedom fighter attacks across the country, hopefully catching the Bugs by surprise and unprepared because they are focused on the California assault.

Pending the success of Operation Landslide in California, NORAD hopes that the Bugs' losses will be so great that outposts in Motown and Flatland will be severely downgraded, allowing for a successful movement to recapture those areas over the next three years (probably culminating in additional, regional Operation Landslides). After that, an assault on *Bugtown U.S.A.* would be in order, which NORAD concedes would require virtually every phase of Operation Landslide to work perfectly, if they are to have enough forces to root the Bugs out of New England and the Tri-State area.

This is, tentatively, a ten year plan, with Operation Landslide California set to be implemented sometime in the next 18 months, barring any setbacks or other considerations.

The Wyoming Free Irregulars

Led by the rough and tumble cowgirl, Sortie McAuliffe, the Irregulars are a rowdy army made up of freedom fighters, survivalists, and militia who have perfected the art of strike and fade guerilla warfare. As far as anybody knows, they are the first major "free army" to declare war on the Bugs, and their very high rate of success has inspired the formation of dozens of similar groups (all of which are smaller and less experienced), including the **Kentucky Headhunters**, the **Bughunters Union Local 12**, the **Ancient and Honorable Order of Roughnecks**, the **Copperheads**, the **Texas Longriders**, the **Apache Nation**, the **Arkansas Razorbacks**, the **Swamp Rats** of Florida and the mysterious (and strangely well-armed) religious cult known as the **Hand of Argent**.



In the relatively short time they have been active, the Wyoming Free Irregulars have earned legendary status, and no small amount of rumors and tall tales abound about them. The truth is the Irregulars number no more than 1,600 dedicated Bughunters (often divided into smaller companies), most of whom have moderate military training, if any. They have survived and succeeded by their intense knowledge of the landscape, their unwillingness to engage the Bugs in large firefights, a habit of picking their targets very, very carefully, and more than their fair share of luck.

Over the years, the Irregulars have successfully raided a number of Bugtowns and armories, which have added both to their personnel and their offensive capabilities. In recent months, NORAD has dealt extensively with this group, providing it with considerable support personnel, conventional hardware, and even a small amount of Organitech weapons and armor for support (and extensive field testing). After NORAD, The Irregulars are the largest, most organized, and most influential enemy the Bugs have in the United States of America. They have even gone so far as to issue public death threats against Sortie McAuliffe, the only known effort by the Bugs directed at any particular individual. This is an honor Sortie herself carries with noticeable pride.

The Free Americans' Air Cavalry

"The Cav," as most survivors call it, is a fleet of combat pilots who have banded together to form a roving strike force consisting entirely of air power. Mostly, The Cav uses assault choppers and a few fixed-wing aircraft fitted with weapons. While there are rumors that The Cav has some kind of stealth chopper or fighter jet that never saw official military service, such talk is ballyhooed as hype and nonsense. However, NORAD is interested in The Cav because they somehow have cashed in on a huge fuel supply to keep all of their aircraft flying. Either they have connections to a big gasoline supply somewhere, or they have figured out how to home-brew their own fuel. Either way, NORAD figures they could benefit from chatting with these fellows, and is prepared to handsomely reward whoever can arrange a meeting between them.

The Cav currently commands some 28 fighting aircraft (18 are choppers) and who knows how many other ground vehicles. One would think they would be easy for the Bugs to track down, but somehow they haven't. The Cav keeps moving thanks to the large support teams following them on the ground. Somehow, the entire force has managed to elude Bug contact and capture, but most people figure it is only a matter of time before they get caught. One growing (and completely unfounded) rumor is that The Cav is secretly allied to or part of a secret military operation from Area 51.

The Cav's greatest victory to date is their Raid on Chicago, in which over a dozen gunships whopped into the Windy City from over the lake and rocketed several power stations in the city. The Bugs not only failed to shoot down more than a single chopper, but they were also reportedly unable to neutralize or infiltrate any of The Cav's avionics systems. This suggests that either The Cav has somehow made their electronics to be Bugproof, or they are powering their craft by something other than conventional means. Who knows? Maybe a rogue Egghead from NORAD hooked up with them and converted their craft

to Organitech hybrid models. Or maybe, they really do have connections with a secret military group at Area 51 or someplace else.

Whoever these daredevil air pirates are, they are quickly becoming popular folk heroes whose bold and reckless tactics and surprising successes serve to boost the morale of humans everywhere. When not striking Bug installations, they drop leaflets on free towns to spread news, and encouraging words about the Bug Hunt (triumphs against the enemy by them and other freedom fighters), as well as tips on how to evade or defend themselves against further encroachment by the alien menace.

The Underground Railroad

This shadowy group operates in the middle of Bugged Territory, especially **Motown** and **Bugtown** U.S.A., specializing in rescuing people and getting them to Free America. Occasionally, they also perform intelligence gathering, acts of sabotage, and other clandestine activities on behalf of, or in conjunction with, NORAD affiliated strike teams, and other freedom fighter groups.

The Underground Railroad's success rate is second only to the Wyoming Free Irregulars, but to date, nobody knows exactly who these freedom fighters really are, where they are based, how long they have been active, how well equipped they are, or who their leader(s) is. Rumors abound about them. Some say they are a unit of ex-US Military who have decided to fight their own style of war, while others offer an infinite number of other possibilities.



The League of Free Cities

There are dozens of Bunker Towns, armed compounds, hermits and isolationist communities in the Badlands, but nowhere are they as developed and well known as in the western U.S., particularly in the Pacific Northwest (considered by many to be the Golden Land of Survivalism). Rumor has it a **League of Free Cities** has established rudimentary trade routes, a mutual defense pact, and even a network of cellular relay towers for wireless communication.

NORAD has only recently learned of this so-called League, and has sent scouting dispatches to check it out. It indeed exists, although these "cities" are more like medium to large towns. The League has repelled a few sorties by both Bugs and fairly organized bands of Warlords. They have modeled their defensive structure around the way the Bugs fight. When one city is attacked, they send out a distress call on their cellular burst transmitters. All the nearest other cities come running and jointly smash the aggressors. The League reportedly has a large cache of small arms, pre-Meltdown armored vehicles, and even a rudimentary air force consisting mostly of old propeller airplanes, gyrocopters and unpowered gliders used to drop conventional explosive and *Bug Juice* bombs on the Bugs. Of course, where the League scored Bug Juice is anybody's guess, and something that concerns NORAD. (Could NORAD have a rogue agent or cell of agents secretly releasing its secrets to the outside world?)

The core of the League consists of nine fairly substantial fortified towns, with a handful of small towns (under 300 residents) and numerous tiny settlements, armed camps, independent homesteads and bunkers scattered throughout Montana, Wyoming and Idaho. The cities themselves are **New Billings, New Hope, Little Big Horn, Yellowstone, Enclave, New Jericho, Independence Station, Tin Man Junction, and Fearless Falls**. Each "city" boasts a population of over 5,000 and is extremely well-stocked for a post-Meltdown settlement. Thriving trading posts are present at all towns, as well as mercantile exchanges where survivors can run in trade-worthy goods for gold and silver or other basic supplies. The Free League is also one of the few places that openly sells firearms and ammunition, too, although it is generally on a "preferred customer" basis, which means that only "friends of the League" and those who are vouched for by a resident or known "friend" may purchase them. To earn such a distinction, one usually either offers a sizeable donation to the League or has done some kind of service on its behalf (typically fighting for or with it). Numerous adventurers have run missions or taken special jobs for the League just for the privilege of buying hardware from them. Considering the breadth of their retail arsenals, it is worth the effort.

Radio Free America

To most Americans, the Bug Invasion brought with it a number of jarring culture shocks. The first was the loss of technology and communications. The second, facing a serious invasion of their homeland, which had never occurred before. The third had been the complete and utter defeat of the U.S. military, which also had never happened in the 20th Century, at least, not to the extent that it did in Operation Clean Sweep. And fourth, the collapse of civilization and the isolation that followed — no government, no police, no military, no public transportation, no manufacturing or distribution of goods, and near total communications blackout.

To American culture in particular, communications have always been a hot topic. From the frontier days of the Pony Express to the Internet-dominated late 1990s, keeping in touch had always been important. By 2002, the Bugs had commandeered virtually all forms of mass communications, and free citizens realized that the only reliable news was the kind you got yourself. All of a sudden, people were cut off, isolated in a way they had never imagined.

In part, this is what sparked the movement to come together and build new fortified communities in the western U.S., but for those unable or unwilling to establish new settlements, radio was the one thing

they could turn to. Sure, the Bugs had captured the stations in the big cities, but radio has always been notoriously low-tech, the communications tool for anybody and everybody who wanted to get the news out on their own. So, when the Bugs took the U.S. off the air, that's when **Radio Free America** entered the scene.

Operating throughout Free America right up to the edge of Bugged Territories, the RFA, as Radio Free America is more commonly known, is a loose federation of pirate radio operators and the first source of Bug intelligence, news, information, and even some entertainment. Most RFA broadcasters are reckless adventurers who travel the badlands in converted vans and trucks that act as mobile transmitters as they take any risk to find out what is going on in the country and report it to the rest of Free America. RFA operators pass their reports along to whoever wants to pick them up. NORAD relies heavily on the RFA for advanced field reconnaissance, and fortified towns depend on them for news on roving Bug, bandit and Warlord activity.

It was Radio Free America that first publicized how millions of people were being herded together to be lobotomized and turned into zombies, so anybody who has ever been rescued from that fate has Radio Free America to thank. Since the Great American Bug Hunt has gone underway, the RFA has been on top of all of the breaking developments, broadcasting casualty counts, relaying encoded messages, refuting Bug propaganda, and other valuable wartime services. And, of course, the RFA also spares no effort to use its medium to broadcast music, entertainment, and other kinds of programming to inspire and remind people that there still is a shred of their old lives to cling to. For the average survivor, the greatest dream of all is for the world to go back to the relative "salad days" of before The Meltdown. The RFA, in its quirky, maverick way, lets people know that it still could happen and that whatever the cost, people must not give up hope.

The RFA has very few permanent installations deep in Free America, since they become prime Bug targets, but Four Corners is one such broadcast refuge transmitting into Texas and other neighboring places for about a thousand miles. Most RFA transmitters are mobile, which makes reception problematic sometimes and even broadcast towers find their transmissions blocked by mountains and fouled by bad weather. With no regulations on how strong a transmitter one may operate, RFA field units employ the most powerful broadcast arrays they can haul. Top-secret military technology made public during The Meltdown included radio broadcasters the size of portable stereos that could send signals out for 200 miles (320 km). Many of these have found their way into RFA hands.

In the few years the RFA has been active, it has spawned a host of imitators — smaller radio operators who basically do the same thing as the RFA, but prefer to remain independent. Most of these free operators do not compete with the RFA, and indeed, often exchange news and information with it freely. As a common courtesy, no free operators broadcast on 100.1 MHz, which has been claimed by Radio Free America as its default frequency. (Certain Bugged areas broadcast anti-RFA propaganda on 100.1 to drown out the pirate radio jockeys, which inevitably leads to an "air war" in which RFA field personnel recruit whoever they can to blow up the Bugs' transmitters.)

The few permanent RFA stations that do exist are run by regional station managers whose job it is to disseminate technical advice to would-be broadcasters, and to keep track of the various field units in operation. RFA field broadcasters are required to check in daily to assure their managers that they have not been captured. For the RFA, there is no greater insult or injury than to have a transmitter fall into Bug hands, or to have those aliens use the RFA's name to send out false news and propaganda.

The New Warlords

Throughout the Badlands, gangs of cutthroats, bandits and Splatterpunks have banded together to form small armies bent on dominating others through force and intimidation. These are the New War-



lords of the land, and they are the single greatest threat to society outside of the Bugs. They got their start during The Meltdown and have grown stronger ever since. There are literally hundreds of Warlord armies throughout North America, of varying size, power and motif. Some are stationary and have established petty kingdoms. Examples of these include the **Millennium Brotherhood**, the **Army of Stone**, and the **Dakota Minions**. Others remain on the go, like the Mongol hordes of ancient times. Examples of these include the **Asphalt Nomads**, the **Human Swarm**, and **Convoy 99** (who reportedly roam the western highways in heavily armed and armored tractor-trailers). However they package themselves, Warlord groups are deadly, unpredictable, and a dark reminder that Bugs are not the only ones capable of evil.

Despite their villainous ways, the Warlords also play their part in the war against the Bugs. After all, these guys might be black-hearted, but they are still human, and they don't like the thought of a Bugged world any more than NORAD does. So when confronted with the alien menace, the Warlords do what they do best — throw everything they have at whoever their enemy of the moment is. Sometimes, these crews and gangs hand the Bugs a surprise defeat, but most of the time, they are routed and destroyed or forced to flee because they lack the discipline to fight as a single unit, as well as the nobility to stick around when the going gets tough.

The Armory Matrix

Before The Meltdown, the United States was the strongest conventional military power in the world. And while much of that power was deployed worldwide (and consigned to fates unknown), hundreds, if not thousands, of armories and munitions stockpiles remained State-side. Most of these were pillaged or destroyed during The Meltdown and the early years of the Bug Invasion, but perhaps 10-15% of them are still undiscovered and could hold anything from minor caches of small arms and ammunition to light armored vehicles, fuel, and even low yield nuclear weapons. Periodically, news of an untapped armory surfaces, sending every Warlord, militiaman, freedom fighter, adventurer, NORAD trooper, and Bug swarm on a mad dash for the goods. What usually results is a bloody, no-holds barred firefight that leaves only one party standing with the booty, and the surrounding countryside laid to waste.

There exist persistent rumors that somewhere in Free America lies an underground computer complex that has no hardlines, but an on-site generator (Topside solar panels? Geo-thermal?) and an active mainframe that contains the location of every remaining armory in the country. This mainframe, known as the **Armory Matrix** is something of a Holy Grail that NORAD, and several militias (including the Wyoming Free Irregulars) have been searching for since Operation Clean Sweep. Whoever finds the Armory Matrix (and whatever may be protecting it) will inherit a double-edged sword; the weapon caches it leads to will make anyone incredibly powerful and wealthy, but it will also make them a target of acquisition or destruction by the Bugs, as well as by Warlords and others.

Campaign Ideas and Settings

By Bill Coffin & Kevin Siembieda

The world of **Systems Failure™** offers many unique and exciting opportunities for the kind of high adventure and interactive storytelling that makes role-playing games so much fun. These are some basic campaign ideas that will be offered to give the first-time gamer some ideas for storylines they can run their games along, and also to give veteran gamers some quick and easy adventure options to explore.

The Great American Bug Hunt

For the last year or so, NORAD and numerous militias have finally declared the first major counteroffensive against the Bugs. All over the country, humans are striking back, and striking back hard. Before long, any group of characters could find themselves either part of the "Hunt" or in the crossfire. Exactly how they decide to handle this situation is the focus of this particular campaign. Basically, this one boils down to two choices: Do the heroes join the Great American Bug Hunt, or do they decide to sit this one out?

If the heroes decide to get involved in the Bug Hunt (and there aren't many who won't), they have a number of ways they can do this.

The most flexible situation is for them to **form their own crew of Bughunters** and wage war on the Bugs however they please. Since they probably won't have lots of military hardware or more than 6-12

freedom fighters in their group, the heroes will have to pick their targets wisely, opting for sneaky guerilla strikes rather than straight-up firefights. The real downside of this is that the heroes will have to go after the really risky targets, like disabling a power plant or severing a major headline nexus or freeing a bunch of Gassed humans if they want to make any difference. The chances for failure here are great, but the payoff, both in heroic satisfaction, and the kind of booty the heroes might get, could make it all worthwhile. Meanwhile, every action against the Bugs that saves human lives, causes confusion, kills even a few and generally puts the hurt on the Bugs, is a good one. And there are places a small group can go and things they can do, that a large army can not.

The heroes could also join, or be hired by, a **local militia**, but this requires some deference to their superiors as they carry out their missions under a loose framework of authority. Some militias are more rigidly controlled than others, and not all characters will like having somebody tell them what to do or a leader to answer to. However, most militias are fairly loosely structured and small groups sent on missions in the field usually have a great deal of freedom in the execution of their duty and specific mission. For those willing to bow to a superior officer, fighting with a militia offers better access to weapons, vehicles and equipment, as well as better intelligence. Most militias have a network of spies and contacts that provide them with reasonably good information and breaking events. Working with or for an organization also gives the player group better chances to take part in bigger operations. For the serious Bughunter, there is no satisfaction like taking out an entire swarm, something any group smaller than a militia is not likely to accomplish on their own.

For the truly hardcore, there is always **NORAD**. Signing up as an Exterminator soldier or an Egghead offers the same kinds of benefits as a militia, only on a larger and more professional scale. NORAD is the last "known" remnant of the US Military and splintered Government. As such, it has enviable resources at its fingertips and (probably) the most firepower in the country. It is the only group that offers access to Organitech hardware, as well as advanced repair, medical, science and communications facilities with access to numerous safe houses and bunkers throughout the west and central America. For the ultimate commitment, characters could come to NORAD seeking psychic training or to volunteer for Operation Doppelganger and become Splicers. Of course, NORAD won't just accept anybody into its ranks. One must first prove he is a dedicated Bughunter of indisputable loyalty and willing to follow orders. Working under NORAD means military structure, regime and hierarchy of command that's a hundred times worse than any militia. Obey orders or get drummed out. Joining and fighting with NORAD will require a great deal of work and self-sacrifice, but this is where many of the best of the best have decided to place their loyalties. If North America is to ever be free of Bugs, it will probably be due in large part to NORAD, and there are plenty of fighters who would rather be part of its large and impersonal war machine than fight on their own and accomplish little wins.

The Survivors

Systems Failure™ is about surviving in a world gone mad, and in this campaign, that is the only goal. Perhaps the characters are keeping watch over a bunker or compound they have established and are assailed from all sides from those who would take over or destroy their little parcel of freedom. Who the bad guys might be depends somewhat on where the campaign takes place. If it's in the eastern half of the country, the characters might be under siege by the Bugs, which would make for an interesting campaign as the invaders' attacks increase exponentially in strength. Under such circumstances, the heroes will have to decide what is more important: dying to defend what is theirs or knowing when to run and take revenge later.

In the western half of the country, the big threat could be roving bands of Warlords and Splatterpunks looking to lay claim to the



heroes' hard work for themselves. Fighting a crew of Warlords would probably be infinitely easier than declaring a one-party war on the Bugs, but with victory could come additional trouble. Surrounding towns that hear about the heroes' success could come to them pleading for their help and/or protection against scores of other brigands and problems. And, where one gang of Warlords fell, ten others will take its place, all eager to blitz the heroes who took out the last gang, so they can make a name for themselves. There are hundreds of other Warlords and cutthroats in the Badlands. Hey, nobody said staying alive was easy, but it sure is the one battle worth fighting.

Of course, there is always the local militia who might want to recruit the heroes into its ranks (and might not take no for an answer), or hire the group for a special mission.

Search & Rescue

Regardless of who the heroes are aligned with — themselves, a militia or NORAD — they have dove headfirst into the Great American Bug Hunt and have no intentions of looking back. Over the course of their exploits, they have become aware of the millions of humans held prisoner by the Bugs, many awaiting a fate worse than death as recipients of Silkworm implantation. The characters have dedicated themselves to freeing as many free-thinking people from the Bugs' clutches as they can, and at every opportunity.

There is something especially noble and selfless about this kind of campaign, because it generally doesn't focus purely on killing Bugs or on boosting one's own reputation. It is about freeing those who are helpless before a cruel and merciless legion of monsters. Of all the heroes in **Systems Failure™**, these guys command the highest respect from their peers for their bravery, dedication, and efforts to prevent human extinction. Of course, there might be selfish motivations, too, like seeing this as a quick way to become famous or perhaps accepted by NORAD. Or, one could be in search of a friend or loved one believed

to be stuck in a Bugtown somewhere. Or, on a darker note, the character might have already lost a friend or loved one to the Silkworms (and maybe even had to do battle with them!) and has turned to rescuing others and killing Bugs and zombies in the process as a way of dealing with their loss.

Rescue campaigns can consist of the heroes hitting one Bugtown or village after another, or it can revolve around them planning one single, spectacular rescue attempt, like freeing the six million or so humans still held captive in New York City! Regardless of the scope of a rescue operation, they all have some common elements.

One: Gathering intelligence. Before a crew can blitz their way into a Bugtown, they had better know everything they can find out about the place, like the layout of the buildings and streets, the level of Bug presence, the number of prisoners to liberate, and where they are likely to be found. Getting this information won't be easy, for it usually entails running numerous high-risk intelligence gathering operations in the Bugtown itself. If at any time the heroes alert the Bugs to their presence, not only will the heroes have a major fight on their hands, but they will cause security to tighten, making any rescue after that all the more difficult. The methods of intel could include aerial reconnaissance, hacking a secure patch onto the Bugtown's hardlines and monitoring it electronically, first-hand observations, or capturing some Bugs from the town (preferably one of the Stink Bugs or Silkworm Zombies) and making them give up what they know.

Two: Making the rescue. This is where the heroes must neutralize the Bugs and get the prisoners the hell out of Dodge. For a small Bugtown, a large and well-prepared human strike force could conceivably cut the town's hardlines and launch a murderous raid using ambush, surprise and confusion with their assault. Once the Bugs are taken care of (be sure none get away, lest they get to another hardline and call for help) or are distracted long enough to effect an escape of the slaves, the heroes will have all too little time to round up as many

prisoners as they can and get them out of town. For this, the characters will need plenty of vehicles, which they can either liberate from the Bugtown or obtain prior to the raid. Just getting the hardware for this phase of the operation could entail many adventures and be a mini-campaign on its own.

Smaller operations might involve much more subtly and secrecy. It may involve rescuing a specific individual or family, or only a handful of prisoners at a time (the Bugs may not even notice them missing). Such operations typically involve a secret entrance and exit into the holding area, and a secured escape route, or perhaps even the digging of an underground escape tunnel. These operations are much more suspenseful and, if they go off without incident, double without firing a shot.

Three: Heading to safety. Once a "raid" is initiated, the characters must get their people and those they are rescuing somewhere safe, preferably deep in Free America. The problem is, the Bugs won't appreciate having lost even a few prisoners, let alone half the free-thinking prisoners of one of their Bugtowns. Thus, it is a sure bet that they will send no small number of swarms to investigate, recapture their slaves, and get some serious payback on the meddlesome humans responsible for the escape. The latter can lead to a long campaign of searching, harassment and attacks to get their revenge.

Now the heat is really on the player characters, since the Bugs can travel at lightning speed through cables and conduits and have scouts, zombies and Army Ants everywhere. If the heroes do not have a secure drop site in place for the liberated humans, they will soon find most of them rounded up and taken back to the Bugtown with a number of them made examples of, tortured and/or slain. To properly end a prison raid, it helps to have arrangements with a fortified town or NORAD site where a lot of people can be stashed and adequately defended, should the Bugs trace them there and attack. Converted missile silos, caves, forgotten underground basements and sewer systems are all excellent for this, since they are easy to conceal, usually have no hardlines and are very easily defended. Many militiamen and survivalists are happy to help too, if the price is right or because they believe in the cause.

Four: The aftermath. If the heroes pull enough rescues off, they will eventually gain a reputation as serious Bughunters and compassionate heroes, which can be both a good and bad thing. Strong militias and even NORAD might try to become very friendly, which might lead to some kind of alliance or cooperative and/or coordinated effort. This is good in that these outside groups might help stock the heroes with weapons, ammo, vehicles and supplies, but it also associates the heroes with the organization which might have negative connotations (other independent freedom fighters, Freebooters, Traders and common folk may not trust them or suspect them as being spies or informants, or worse, the pawns of these organizations). Furthermore, even politely declining to work with them might get the outside organization or group angry with the player heroes. This could lead to a sudden discontinuation of all relations and petty retaliations (won't offer the simplest aid, refuses to trade goods or charges more for them, will no longer share even tiny bits of information, bad-mouths them, engages in foolish rivalry, and so on).

The Bugs will also take notice of these vaunted "heroes" and will stop at nothing to capture the characters and make very grisly examples out of them. Of course, if the characters were *really* afraid of that, they would have found a quieter line of work to begin with.

Road Trip: From Bugtown, U.S.A. to Free America

As the latter parts of a Rescue campaign illustrates life on the run from the Bugs can be a very trying situation. One, in fact, that could be spun out into an entire campaign of its own. The reasons why the

heroes are on the run are myriad. Maybe they have just liberated a few hundred (or a dozen) prisoners from anywhere in Bugtown U.S.A. and they have to get them to safety. Maybe they took part in a raid deep behind enemy lines and have lost their transportation and must find their own way home. Maybe they have been hiding in Bugged territory for a long while and have finally decided it's time to leave. Maybe they have racked up enough Bug "kills," a few at a time, that the Bugs have launched an all-out manhunt to find and destroy them. Whatever their reason, the goal of this campaign is simple enough: stay one step ahead of the Bugs and reach a safe haven (or die).

Something else to consider for this campaign is where the characters are at its start, where they plan to go, and what places they will hit along the way. For those players and G.M.s fond of integrating real-world details into their game, this kind of campaign can offer lots of fun opportunities by simply opening up an atlas or checking out the Internet and doing a little research on the characters' travel route. Figure out what things along the way might be fun to spin into adventures. Are there any military bases? Nuclear testing sites or power plants? Any big patches of wilderness? Cities that are likely to be Bugged? Abandoned towns? Old mines? Industrial belts past their prime? And so on. The U.S. is a big place, chock full of interesting sites that could provide an imaginative G.M. with nearly endless fodder for adventure.

Then cross-reference this with the world information provided in this book. Will the character's escape route skirt close to any Bugged territories? Common battlegrounds? Known turf of Warlord anarchists? Militia strongholds? If all goes well, you might find a simple road trip to freedom will provide more adventure ideas than you thought possible.

The only problem with this campaign idea is what to do once the heroes have reached their destination. Do they simply settle down and forget their adventuring pasts? Do they go adventuring and/or freedom fighting in some other part of the country (and against some other faction of the Swarm) — there are certainly hundreds of places where they can do so. Or do they find themselves embroiled in other activities for a while? The alternatives are many. Or they could become wandering lawmen, town Marshals and/or deputies, helping a community fight off Bugs or Warlords, go exploring — to Canada or Mexico, perhaps, and so on. Sooner or later the Bug faction hunting them down is likely to give up, although the group will become a prime target if they ever return to that part of the country or they cross paths with a squad or swarm from that faction. The Bugs of that faction will never forget them.

A third concept is if, along the way, the heroes pick up some others who have decided to come along for the ride. This could possibly lead to people flocking under the banner of our heroes, and building a large militia. If this is the case, the army could consider making a stand against the Bug faction that hounds them, or even go back and attack the Bugtown where their problems began! Or they can continue to move away in search of a (relatively) safe place to settle. However, while active player characters may serve as the catalysts for starting a small community or militia group, they are not likely to stay and lead them. Adventure beckons elsewhere for them. Still, they will have made a haven where they should always be welcomed. Note: Player characters building a town or militia are extremely rare and difficult to achieve.

Dogs of War

So far, these campaign ideas have focused on relatively selfless, heroic campaigns, but what of those characters and parties who don't feel like playing the part of a crusading freedom fighter (no matter how fun)? Isn't there room in this game for those who simply want to make a little money, get into a few gratuitous gunfights, and maybe become king for a day? You bet your 12-Gauge there is!

The Great American Bug Hunt may be the most recent development since The Meltdown, but it by no means dominates the entire landscape. Especially in Canada, Mexico, and the western U.S., there are



huge stretches of land that are not Bugged and up for grabs to whatever settlers, survivalists, heroes, and Warlords who feel like trying to take and hold on to it. One would think that there would be enough land for everybody, but as history has shown time and again, as long as there are people with something of value, there will always be others who want to take it away from them. Moreover, there are those chaotic and fiendish Splatterpunks who simply live by plunder and enjoy destroying what others have built. Thus do we have innumerable thugs, bandits, and Warlord raiders and warmongers across the land looking for trouble and taking from others. Simple folk need leaders and protectors willing to stand against these forces, even if they are not much better than those they fight against. Turf wars and rivalry between Splatterpunk gangs, bandits and power-hungry Warlords are commonplace. Where one Warlord takes on another, often fighting over strategic parcels of land or resources, there are companies of mercenaries and other hired guns. Gunmen and brigands who find freelance fighting a much better way to spend their time than fighting Bugs. Such skirmishes are also where heroes and adventurers can throw their hats into the ring, and tip the scales one way or another.

This is one of those campaign scenarios where it might be fun to play the sympathetic bad guys, scoundrels, opportunists or anti-heroes who are interested only in saving their own hides and, with some luck, maybe get rich in the process. Ultimately, they find themselves up against a much worse lot of killers, brigands and all-around unpleasant people. Or, maybe the characters could play the part of Drifter soldiers, or guns for hire, fighting on behalf of whoever pays them the most, perhaps hoping in the back of their minds that they are doing the right thing (if indeed they care at all). Or, the characters could take the role of a lone group of outcast heroes wandering through a patchwork battleground full of brigands and tyrants, just trying to get by and maybe taking down some bad guys or Bugs along the way.

This is also a good setting for Freebooters to simply make their rounds, salvaging battleground leftovers as fodder for a buying and selling circuit that includes every heavy hitter in the Badlands. Handling the diplomacy, guts, timing and sharp gunplay needed to be a successful businessman in this "market" is no mean feat, but those who do will become rich and powerful. Enough, perhaps, that they can afford to live someplace where the Bugs won't be their concern, or where other people can do their worrying for them — like a private army of freelance Exterminators and Splatterpunks who keep the world at bay while they live a life of relative luxury.

Of course, role-playing is all about stepping outside of your real-world self and assuming a role you might never have the chance or inclination to play otherwise. So in that vein, this campaign setting could be the perfect opportunity to play a flat-out villain. You know the type: A selfish Splatterpunk looking to add a few more notches to his gun belt, or a would-be ruler bent on building an army and ruling some corner of the world, or a black-hearted schemer or revenge-driven maniac. Or maybe just a nihilist who thinks the Bugs have the right idea and does what he can to help them along (Just think of the bragging rights you could get by being the hardcase who gave NORAD a black eye or who gave the Wyoming Free Irregulars to the Bugs). If everybody's going to die, thinks the nihilist, why not die being remembered for something? For a while anyway. Hey G.M.s, this psycho and the other characters noted above can make great Non-Player Villains too.

The Killer App

The Debuggers in Silicon Valley and the Eggheads at NORAD have come up with the different sides of a plan that could purge the world's hardlines of Bugs forever. With that crucial edge, the Bugs will be infinitely easier to squash, and the field will fall back in our favor. First, there must be a meeting of the minds, and the player characters must help facilitate this. Maybe they're escorting the Debuggers to Colorado, or the Eggheads to California, or laying down a unique and secure hardline between the two places so some teleconferencing can go down, or hired to guard a particular secret component, bit of informa-

tion or scientist. If the heroes succeed in this, they'll be credited with helping to pave the way for a final victory. If they fail, humanity might lose its greatest minds to the Bug War.

Fort Knox

Sometime during the early days of The Meltdown, the Federal Government realized that paper money was no longer worth the paper it was printed on, so it took measures to keep its gold stockpiles from falling to the Bugs. Over a year and a half, its gold and silver stockpiles were transported to a hidden location(s) where they are rumored to sit in a vast underground fortress that has no hardline access and is manned by a full battalion of Marines who have sworn to protect the precious metals with their lives. Of course, they haven't been heard from in years and many people claim that "The Knox Treasure" is either nothing more than an urban legend or that the troops are dead but the gold and silver remains hidden someplace. Whoever finds "The Knox" (which isn't old Fort Knox in Kentucky) would control an unimaginable amount of the nation's wealth and in doing so, the national economy, provided humans defeat the Bugs and send them packing. And provided that the treasure hunters who *may* find it, could actually hold on to it.

Similar stories are told about hidden weapon caches, secret Military depots and bases (like Area 51), hidden stockpiles of uranium, gems, technology and government secrets and even hidden armies said to be locked in suspended animation. Undoubtedly, there are some shreds of truth to some of these tall tales, but the vast majority are nothing more than myths and legends.

Palladium RPG®

Plug-Ins

Although **Systems Failure**™ has been designed as a stand-alone game, it is also part of the Palladium Megaverse, a constellation of role-playing games that all utilize the same system of rules, and therefore, are largely interchangeable. As a result, it shouldn't be hard at all to incorporate characters, Bugs, settings and ideas from this game into other Palladium products. Or conversely, to import things you like from other Palladium games into this one.

In that spirit, we present to you a bunch of campaign ideas for using the **Systems Failure**™ game setting for other Palladium RPGs. As always, feel free to use, tweak, or modify these as you like. In the end, your campaign world is *what you* decide it should be, so don't be afraid to change things to fit your liking!

For the last decade, **Rifts**® has remained one of the most popular role-playing games on the role-playing market. This powerhouse game and **Heroes Unlimited**™ are probably the most natural matches for running an integrated **Systems Failure**™ campaign.

Like *Systems Failure*™, **Rifts**® is a post-apocalypse setting where the world has been ravaged (and continues to be) by war, and supernatural phenomena of every kind. This world also features incredible interdimensional portals known as *Rifts* that enable creatures and people from any dimension or alien world to come into this one, or to let somebody from Earth travel across the Megaverse® to destinations unknown.

In this setting, it would be feasible to say that the Bugs are just another group of hostile interdimensional beings (or demons) who have come to Rifts Earth intent on wreaking havoc. With so much of the Earth's power systems and communications in ruins, the Bugs will have a much harder time conquering the planet, which might make for

a more localized campaign. Of course, if the Bugs get their bio-electric claws into one of the more developed parts of the world, like the Coalition States, the New German Republic, or parts of Australia or Japan, some serious mayhem could result. Given the amount of hardware and mecha present on Rifts Earth, the Bugs could become an extremely powerful and widespread force in a relatively short period of time. And if they manage to get to *Phase World*, well, there's no telling what the extent of the damage might be.

Something else to consider is that the **Rifts**® game setting is crisscrossed with powerful lines of magical energy called *ley lines*. At the G.M.'s discretion, the Bugs could be able to enter and travel along ley lines just as they would through power cords and phone lines in **Systems Failure**™ (it's even hinted at in the description of the Lightning Bug). This would easily make the Bugs a worldwide menace, perhaps the kind that would force those who are ordinarily enemies into a temporary truce as they join to battle a greater evil.

There is already a race of warrior insectoids on Rifts Earth, known as the Xiticix. Is it possibly the two are somehow connected? Is one the mortal enemy of the other? Could this result in a devastating war between the two? Or are the Bugs one of the Splugorth's allies or trade partners? If so, a few individual Tier 2 or 3 (or higher?) Bugs could be found visiting Atlantis, or trading at the Dimensional Market at Splynn.

With all the other power bases on Rifts Earth, it is very likely the Bugs will have no interest in trying to conquer it, however, individuals and small groups, to a swarm or two (100-1000 Bugs with Silkworm Zombies to follow), might want to carve out their own niche someplace (as noted earlier), while the Bug race will find the planet appealing, if for nothing else, as a stepping stone to countless other worlds and dimensions. Don't forget, the Lightning Bugs know how to use ley lines, so they can open a dimensional portal with ease on Rifts Earth by drawing upon the incredible mystic energy that covers the globe.

Heroes Unlimited™, 2nd Edition

Palladium's game of comic book superheroes is also a natural match for **Systems Failure**™. Rather than running the post-apocalypse scenario presented in this book, one could easily take the Bugs and bring them into a contemporary **Heroes Unlimited**™ campaign, where the heroes must fight to stop their initial invasion. The invasion doesn't have to coincide with the Year 2000, either. Mad scientists and Wizards are messing with dimensional nexuses all the time in comic books. **Heroes Unlimited**™ should be no different. Thus, a mad scientist or mage could have inadvertently brought an advanced scouting party of Bugs (10-100 strong) who are preparing to open a portal and summon their brethren. Or the bozos could have opened a portal that will bring the main invasion Swarm to Earth unless our heroes can close the dimensional gate before it's too late (requiring them to battle the small group of Bugs noted earlier and maybe some Silkworm Zombies and a few supervillains or mad scientists). Once a small army of Bugs arrive on Earth, a city quickly falls under siege as a swarm of the invaders pour through the portal and only our heroes have the opportunity to save the Earth from certain doom. Now *this* is the stuff comics were made for! The ol' "stop the alien invasion: scenario is always fun, and the Bugs offer some interesting twists to the "bug-eyed alien." It *is* quite feasible for superhumans to stop the invasion, although we leave the details to you.

Or, if you want to bring a **Heroes Unlimited**™ element into your **Systems Failure**™ game instead, simply have the game take place in a world that has *superhuman* heroes, but they were simply unable to prevent the Bug onslaught. Now, heroes and villains alike might find themselves putting aside their differences as they try to survive. Or, perhaps there are villains who are working in league with the Bugs, and may even be responsible for bringing them to Earth. As the larger Bug War rages around the characters, Earth's superheroes battle to restore the government, justice, freedom and peace to their world. Meanwhile,

supervillains fight to seize land and build their own petty kingdoms in hopes of keeping such power bases as their own after the Bugs are eliminated. These villains may fight the Bugs, but most do so with their own self-interest at stake.

Will Earth's superhumans be able to help put the Bugs away once and for all? Or will Earth's supervillains crush their nemeses and help bring the world under the electric claw of the Bugs?

Another option is to have the heroes swept away to an alien world that is already dominated by the monsters. In this setting, they fight to help freedom fighters of that world establish a foothold from which they can launch an extended campaign against the Bugs. After a handful of adventures, our heroes return to Earth. The only question being, did they bring any Bugs back with them? Were the Bugs able to trace them and now know where Earth is (a potential target for a future invasion)? Or maybe a squad or swarm follows the heroes on a campaign of revenge rather than conquest. Their goal is to make the heroes suffer and pay for their deeds on the alien world. Whether they save their efforts entirely to battle the heroes or they strike at them by hurting innocent humans, is up to the G.M.

Regardless of how you establish the game setting, the **Systems Failure™** O.C.C.s of the Psychic and the Splicer were created partially with **Heroes Unlimited™** in mind (and drawing on super abilities from that game). The Splicer, in particular, could stand in as an Experimental Hero, Alien visitor or Mega-Hero, just as the Psychic could stand in for a Psionic hero. Even if you don't wish to use the Bug "War" as a backdrop, either of these O.C.C.s would be right at home in almost any **Heroes Unlimited™** game.

Ninjas & Superspies™, Revised

By and large, **Ninjas & Superspies** is a contemporary setting, filled with international intrigue and high-tech gadgetry. It really isn't set up for alien creatures from another dimension any more than a James Bond or Bruce Lee movie might be. That's not to say that it can't be done — certainly, if you'd like to use **Ninjas & Superspies™** as an add-on to **Heroes Unlimited™** (the two games are *very* compatible), then an alien invasion campaign will fit right in. But if your **Ninjas & Superspies™** campaigns are more orthodox, then perhaps a lower-key approach is the way to go.

Anybody who has seen the underground martial arts flick *Six String Samurai* should have no problem figuring out how to fuse a bizarre post-apocalyptic game setting with high-kicking martial arts action. For those who haven't seen this debatable gem of cinema, or who wish to keep their game in a contemporary, pre-Meltdown setting, here are a few thoughts on how to make **Systems Failure™** and **Ninjas & Superspies™** work together.

Giving the Bug invasion a supernatural aspect could work, especially if you did it in the style of the **Ninjas & Superspies™** companion book, **Mystic China™**. Surely, a plot by the *Yama Kings* to open the Infernal Gates and let loose a horde of "Iron Bugs" on the world could be done. And, it sure would give even the toughest martial arts warriors a run for their money. Or maybe the numerological significance of the evening of Sept. 9, 1999 (9:09, 9/9/99) could have some mystical significance that a *False Immortal* has decided to harness for his own maniacal plots that entail the rending of the world, the involvement of the Yama Kings, and the introduction of a swarm most foul into the world.

On the superspies side, you might wish to play up the entire Y2K aspect of this, and how it plays into worldwide communications, energy, and information infrastructure. Perhaps the Bugs are not alien invaders, but the bizarre offspring of a top-secret bio-electric weapons program developed by an underground, villainous society. Either the Bugs got loose, or their unleashing on the world may have been a deliberate plot started by the scoundrels who designed them. Remember, there are plenty of secret, evil societies out there. Any one of them could have a reason to use or create these Bugs. Perhaps after being

thwarted so many times in their quest to control the world, these villains have simply decided to destroy it instead.

For those who want a souped-up version of **Systems Failure™** without going completely "superhuman," any and all of the Superspies or martial artist characters can be used as additional character classes for it. Instead of playing an Exterminator or NORAD soldier, you could use a Worldly Martial Artist or Spy. Both would be adept at sneaking into Bugtowns to help free-thinking humans escape and/or to sabotage power plants and Bug operations. As well as lead militias and strike forces, and join freedom fighters.

Teenage Mutant Ninja Turtles® RPG

Mutant animals are a part of the **Heroes Unlimited™** landscape as well, so all of the ideas presented in the **Heroes Unlimited™** section also apply here. On top of that, **Teenage Mutant Ninja Turtles® & More Strangeness** has even more ways in which that game can work with **Systems Failure™**.

Most importantly, the **TMNT RPG** already has the **After the Bomb®** scenario, an excellently designed and detailed post-apocalyptic setting in which mutant animals inherit a shattered world courtesy of self-destructive humans.

In an **After the Bomb®** campaign, the Bugs could easily be part of the reason why the world fell to pieces. Of course, with so little of the old power generators and hardlines still working, the Bugs will be few in number, found in clusters, and perhaps even starving to death. This might make them much more easy to handle. It could also make them the unwilling test subjects of one of the various evil human empires of this world, who may use the Bugs to begin their own Splicer program or to develop the Organitech devices described in the back of this book. Either development would bode most ill for the brave mutant animals who are struggling to restore order to their battered world.

In addition, the **TMNT** sourcebook **Road Hogs** has got all sorts of great information for running any kind of post-apocalypse campaign where survivors tool around in souped-up combat cars as they battle for dominance over the freeways. It's not hard to see how this material could easily fit into a **Systems Failure™** campaign, especially if you want to incorporate roaming Warlord gangs as a recurring opponent for the survivors and patriots.

To make the Bugs better fit into a contemporary **TMNT & MS** or an **After the Bomb®** campaign, the G.M. could have them simply be ordinary Earth insects that have been mutated into their current form! Perhaps whatever it was that mutated the other animal characters in the game is what has given *birth* to these insectoid predators that threaten to grow into a menace that could endanger every living thing on the planet! For the heroes, fighting the "mutant" Bugs not only means a chance to save the world, but it also offers them the rare opportunity to examine something that shares their type of origin. This "mutant" scenario also works for **Heroes Unlimited™**.

Beyond the Supernatural™, 1st or 2nd Edition

This game could be modified to be more arcane, as with the suggestions for **Palladium Fantasy**, or it could also be modified to be a scenario taking place over a much longer period of time in the modern (e.g., 1999) world. That way, the paranormal investigators of **Beyond the Supernatural™** might slowly find out that the energy disturbances in their neck of the woods are indeed the work of something sinister and strange, alien beings (or supernatural Bugs) from another dimension slowly chipping cracks into the energy barrier that separates our world from theirs! At this point, the heroes might find themselves either fighting the human servants of the Bugs, dupes who for whatever reason wish to see the Bugs come over (maybe they are part of a

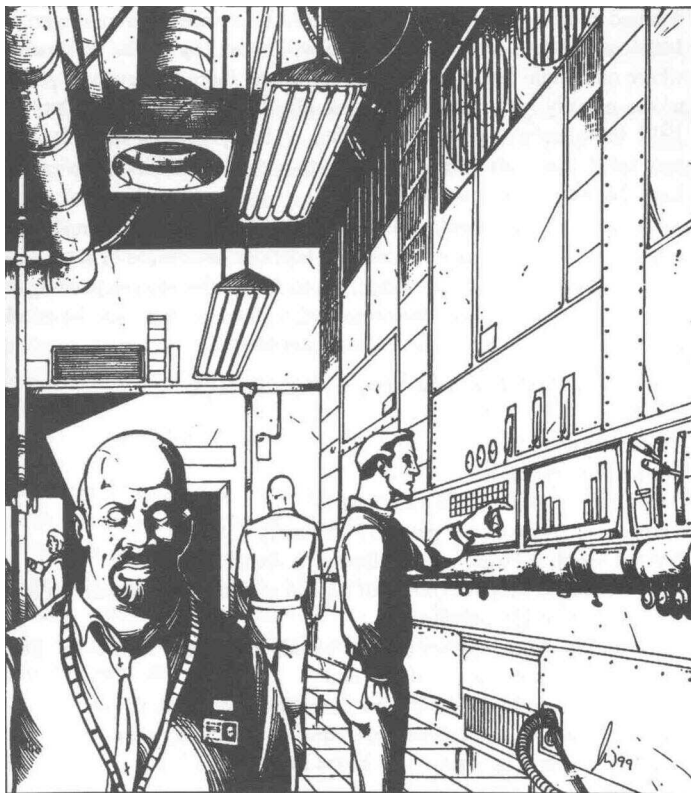

doomsday cult), as well as Silkworm Zombies created by a Stink Bug who has already gained access to our world. Or they might battle a few Bugs who have already slipped through to our world and wish to open the gate for a few million buddies. The fun here is the nature of the scenario. Sharp investigators will realize that for a variety of reasons, Y2K will provide these Bugs with the perfect invasion opportunity. But if the heroes publicize this they will be dismissed as doomsday wackos who are obsessed with Y2K. Heck, maybe even *other* extremist doomsday wackos would brush them off as too weird to take seriously. In such a situation, the heroes would find themselves isolated, under-funded and fighting an uphill battle against the secret Bug invasion as the rest of the world turns a blind eye to events unfolding in front of them.

Those **Beyond the Supernatural™** players who are into "victim gaming," whereby the player characters are all essentially doomed because they are fighting a vastly superior foe, might wish to take this approach when playing **Systems Failure**, too. The Bugs *are* rather tough, and the average person will probably not survive tangling with one. Any humans who oppose them are going to face really high casualty rates.

Nightbane®

This game could work with **Systems Failure** in a number of ways. First, in a more conventional **Nightbane®** game, the Bugs could simply be one more piece of the large and horrifying puzzle that is the **Nightbane** world. The bug invasion could be more covert, along the lines of how the Nightlords came in during the Dark Day and secretly established themselves atop the world's power structure. The Bugs may have done a similar thing, infiltrating the Internet and the global power, telephone and cable grids, biding their time and multiplying, waiting for the go-ahead to spring forth from their bio-electric hiding places and strike.

In this context, how the Nightbane heroes and the Nightlords themselves see these unwanted guests might be fun. If the Nightlords and the Bugs are ancient rivals, then as the two duke it out for supremacy of the Earth, things might not stay secret for very much longer. It would mean that with these two forces of evil at each other's throats, it would

make it all the easier for the heroic Nightbane to operate without the constant enemy surveillance they have grown used to and exploit each warring side's weaknesses. Of course, if this turns into an open war on Earth, then a full-blown societal "meltdown" could occur that would be every bit as devastating and complete as the wreckage facing society in **Systems Failure™**.

In the alternative, the Bugs could be much less numerous and function as one of the Nightlord's many supernatural minions. Whether subservient minions or allies employed by the Nightlords, the Bugs are used as a means of subverting worlds that have grown heavily dependent on the kind of power and communications infrastructure that characterizes modern-day Earth. Under the combined weight of the Nightlords and their Bug minions, the world faces a dark future indeed. This goes double for the various Nightbane, who will remain just as hunted as ever, being now pursued also by creatures that can transport themselves electrically, instantaneously, from anywhere to anywhere. Under such circumstances, only the most wily and powerful have a chance of surviving. The point in such a campaign might not be to save the world, but to escape it. To add some spice to things, the Nightbane are impervious to the Silkworms, and since they can not be subverted, the Nightbane must be destroyed.

Palladium Fantasy Role-Playing Game®, 2nd Edition

For this, the least technological of the Palladium game worlds, **Systems Failure™** would probably work best converted to a supernatural feel, where the Bugs have come to this world through a dimensional nexus and cavort in the world's ley lines, feeding on magical energy and creating widespread mayhem. Given the numbers of interdimensional creatures on this world, as well as the abundance of magic and ley line nexuses (which can serve as a kind of dimensional portal), it should not be hard to explain how and why the Bugs have come here to feed. In fact, any number of Summoners, whose very occupation is to bring creatures from other worlds into this one, could be responsible for the presence of one to several Bugs. Remember, too, even without electrical energy the Bugs can survive, and are formidable monsters.

As a global threat, not since the Age of Chaos, when the Old Ones reigned supreme, will the Palladium Fantasy world face such a universal threat as this one. Remember, the Bugs can travel along their feed lines (in this case, ley lines) instantaneously. Given how many of the largest cities and strongholds of this world are built on or near ley lines and ley line nexuses, the strongest defenders of the planet are placed squarely in harm's way. Once those cities fall, defending the world will be up to those unincorporated heroes and hardcases who have laid low and now can strike. For the freebooting adventurers that so many players create for this game, this is the perfect chance to fight a war worth winning, and for rewards greater than gold or magic.

Something else to consider is the developing theme of global war that has become prevalent with the Palladium Fantasy World within the last few years. The Western Empire, evil state of tyranny that it is, has risen from the ashes and threatens everybody. The Eastern Territories and the Wolfen Empire threaten war as well. And the Nimro Kingdom of Giants also is eyeing the warpath, spurred on somewhat by the ongoing war between monsters in the Baalgor Wastelands. Into this mix come the Bugs, threatening everybody at once. Crafty G.M.s might wish to make this threat one that brings former enemies together. Or, perhaps, this could be the catalyst that sets it all off, causing a major world war while the voracious Bugs gorge themselves and delight amid the ruins. The choice, dear G.M.s, is yours!

Another interesting alternative is if the Bugs (whether used as rare demonic monsters and minions, or a global threat) feed on all forms of magic energy, including Practitioners of Magic! If this is the case, the

Bugs will try to enslave Wizards, Warlocks, Diabolists (especially to force them to make power circles), Summoners and creatures of magic of all kinds. This could mean that it is only (or mostly) the magic users of the world and magic creatures like the Faerie Folk and dragons who are in real danger. A turn of events that would change the balance of power and threaten to remove magic from the world!

Under this scenario, the Bugs would be impervious to magical weapons, spells, wards, circles and most mystic attacks, but would be vulnerable to conventional weapons (it may be prudent to reduce the Bugs' natural A.R. and S.D.C. by 20-30% for some balance). They would see practitioners of magic as cattle — living reservoirs of mystic energy to be enslaved and tapped like living batteries. So instead of Bugs feeding off an electrical cable, one would see 2-4 feeding on a sorcerer, leaving him used, abused and drained of magic, but physically healthy (though his spirit is likely to be broken). Likewise, the Bugs might cage Faerie Folk or keep them in charms worn around their necks to feed upon at will. Dragons and other creatures of magic would be covered by swarms of the damnable creatures like flies on a dung heap, rendered docile and weak from both physical beatings and the constant drain of the mystic energy that is part of their very being. Such a scenario could be widespread or limited to an isolated locale like an underground tunnel network or secluded village in the Old Kingdom, Yin-Sloth Jungles, or Land of the Damned. Likewise, a single or pair of magic draining Bugs could be the object of worship by a secret cult in the Land of the South Winds, Yin-Sloth Jungles or Western Empire — or anywhere, really.

BREAK OUT THE HARDWARE

Trading vs Money

In this section, dollar prices are given for all items, but don't let that fool you into thinking that characters can simply pay cash for such goods. In this world, the economy has crashed, and paper money is worthless. Precious metals are scarce but the favored monetary mediums. Gold goes for about \$500 an ounce (28.3 g) and silver goes for about \$250 an ounce (28.3 g). For those who do not have precious metals on hand, trading is the only way to go. Furthermore, while some people and businesses prefer precious metals, some won't even take that, insisting on trading for resalable (tradable) goods. This is especially true in the most remote towns and homesteads where gold and silver have little practical value and they need things to survive now, not hoard for the questionable future. The trade of goods also applies to services; repairs, medical treatment, the sending of messages, hauling cargo, tending to a horse, etc.

Most folks trade the items they have on them. For this reason, many free adventurers end up looking like pack mules, laden with all sorts of stuff that might be traded elsewhere for some vital supplies or equipment. Needless to say, pack animals have once again become very, very popular.

Typically, used equipment and similar booty can get 30%-60% (ID4x10+20%) of its listed book value. However, prices will vary dramatically depending the condition of the item(s), the availability, and the need for it (i.e. in the desert, a canteen of water may be worth its weight in gold to a man dying of thirst). Especially beaten up gear and spare parts and pieces might get only 10% or 20% of its original worth. New or "like-new" items can often, but not always, fetch premium dollars, anywhere from 90% to 140% its listed book value (106x10+80%). Again, this will vary widely depending on the item for sale, the need,

demand and the buyer — for example: At one place the item might get 140%, at another, somebody may be willing to pay 200%, while elsewhere one might not even get 50% for it, and there will even be places where nobody will want the item at all. ("Thank you friend, but my 1910 Winchester serves me just fine. I don't have no need for that new-fangled assault rifle. It's purdy though. Looks like it jus' come from the factory.")

Certain commodities have become a kind of *de facto* currency because they are traded so often that their prices have more or less stabilized, although prices may swing 10% to 40% either way depending on local supply and demand. Not surprisingly, food products and livestock are "hot" commodities that are always in demand.

Going Rates for Trade Commodities

Alcohol, per pint (0.47 liter): \$100

Box of matches: \$5

Refillable cigarette lighter: \$20

Gasoline, per gallon (3.78 liters): \$100

Kerosine or lamp oil, per gallon (3.78 liters): \$50

Bottled, sterilized water, per gallon (3.78 liters): \$10

Simple medical supplies (bottle of aspirin or antiseptic, package of bandages, etc.): \$15 per unit.

Advanced medical supplies (bag of blood, specialized medicines, fresh surgical equipment): \$150 per unit.

Battery (AAA to D & 9 Volt; new & working): \$8 each.

Rechargeable battery: \$15-40 depending on its size & type.

Grain/flour, per 25 pounds (4.54 kg): \$150

Seed, per pound (0.45 kg): \$50

Sugar, per pound (0.45 kg): \$50

One chicken or duck: \$40

One goose or turkey: \$100

One pig: \$250 (may vary up or down depending on size).

One sheep: 300 (more valued for its wool than for food).

One cow or ox: \$1,000 (+\$600 for a quality breeding steer)

One pony/palomino (small horse for riding): \$ 1,500

One horse (large; for riding or work): \$2,500

One mule: \$1,000

One donkey: \$500

Organitechnology

NORAD's **Consortium of Organitechnology Projects** has produced a wide range of new weapons, battle armor and equipment to use against the Bugs. They are a combination of old and new technology involving genetic engineering. Using Bug DNA and several secret processes, the NORAD Eggheads have created a "breed" of organic, living devices that use bio-energy as their power source, and as such, are invulnerable to deactivation or infiltration by the Bugs (e.g. impervious to Machine Union). Plus, the high power and versatility of these devices gives those who use them a distinct advantage against humanity's insect adversary. NORAD represents the primary hope for re-establishing government and society in North America.

Rifts® Conversion Note: TW weapons, rune weapons and the Splugorth's Bio-Wizard weapons and devices (as well as the Anti-Monster Cyborg of South America) are all effectively powered by bio-energy (and magic) of one kind or another, so they inflict full damage to the Bugs and can not be controlled by them. On the other hand, the Bugs also feel very comfortable using such items and will intuitively understand their operation.

Bug Zappers

These ingenious energy weapons are the first line of Organitech hardware to see full deployment in the Bug War. Based on the bio-electric cannons that grow from many of the Bugs' carapaces, NORAD geneticists have figured out how to replicate the internal fusion process of the Bug cannons and splice it with various strains of

plant DNA. The result is an "organic" energy weapon that is "grown" in an incubation vat (incubation time: 6 months) and is extremely easy to maintain.

Like certain species of plants (tillandsia, for example), Zappers get all the nutrients they need from sunlight and exposure to the atmosphere (from which it filters essential nutrients). All Zappers are inert when first created. Once they are fired for the first time, the guns "blossom," and will remain active for approximately one year. After that, the weapon's life cycle ends and the unit ceases to function.

All Zappers have a finite payload after which the weapon needs to recharge; they regenerate one charge to their payload every hour. Once a Zapper's primary payload is exhausted, they do have a reserve payload that may be tapped, but doing so will initiate the unit's death cycle prematurely. When this happens, the weapon will no longer recharge and, within 2D4 hours, it will die and begin to decompose. If a Zapper is left to recharge once its primary payload is exhausted, however, it will recharge on its own. A "healthy" Zapper feels slightly warm to the touch and heats up a little upon firing.

The energy beam is similar to a Bug's bio-blasts but upgraded somewhat for extra range and firepower. However, the trade off is that to score a direct hit, one must roll an 11 or higher on a D20. Shooters who roll between a 5 and 10 will only "nick" their target, inflicting less (roughly half) damage.

NORAD is currently working on Zappers capable of bursts and autofire, but none exist yet. Other upgrades in the works are models with greater payloads, faster recharge times, a hip or backpack recharger (effectively a battery pack that the living weapon can draw extra energy from), and a "charge dump" option that would allow shooters to dump multiple charges into a single shot, making for super-powerful blasts. All of these features are under development, and a few are in the prototype stages, but are unpredictable and unlikely to be found in any Zappers used in the field, except perhaps in experimental models being field-tested or that have somehow slipped out of NORAD's hands.

Note: Although Zappers are organic and in a sense, alive, they are not truly living organisms, and will not respond to psionic powers such as Bio-Regenerate and Bio-Manipulation. Also note that while these weapons are becoming more and more common as NORAD produces and distributes ever-increasing "crops" of them, they are still extremely rare, highly valued and difficult to obtain. Their cost below is a somewhat arbitrary figure pegged by NORAD; their actual cost in terms of trade is likely to range some 200% to 1,200% (2D6x100%) higher than their listed price, assuming one could even find somebody willing to part with weapons of this magnitude.

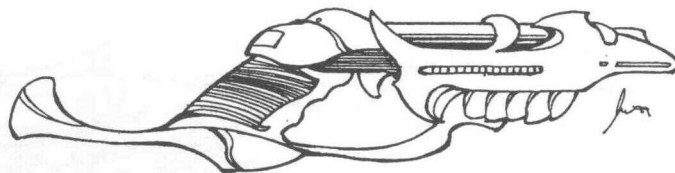

Z9 "Bronson" Light Energy Pistol

Relatively small and easy to conceal.

Weight: 1 lb (0.45 kg)

Damage: 2D6 nick, 4D6 direct hit.

Rate of Fire: Single shot, each blast counts as one melee attack.

Effective Range: 200 feet (61 m).

Primary Payload: 20 shots. **Reserve Payload:** 8 shots.

Cost: \$30,000

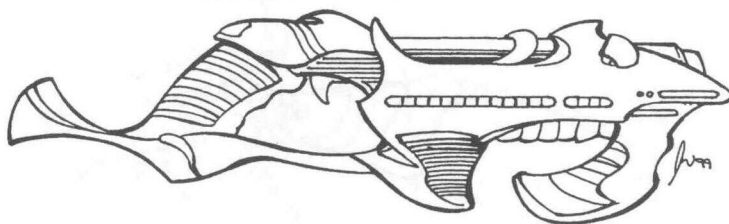

Z10 "Eastwood" Heavy Energy Pistol

A larger, heavier weapon with a bigger bang.

Weight: 2.5 lbs (1.13 kg)

Damage: 2D6+3 nick, 5D6 direct hit.

Rate of Fire: Single shot, each blast counts as one melee attack.

Effective Range: 262 feet (80 m).

Primary Payload: 16 shots. **Reserve Payload:** 5 shots.

Cost: \$40,000

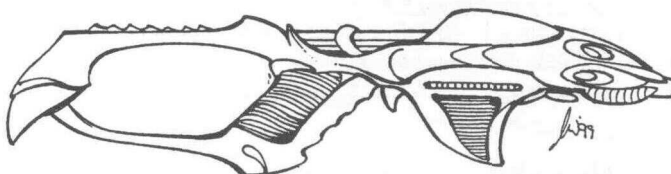

Z23 "Ventura" Energy Carbine/SMG

Weight: 4 lbs (1.8 kg)

Damage: 4D6 nick, 1D4x10 direct hit.

Rate of Fire: Single shot, each blast counts as one melee attack.

Effective Range: 700 feet (213m).

Primary Payload: 35 shots. **Reserve Payload:** 10 shots.

Cost: \$60,000

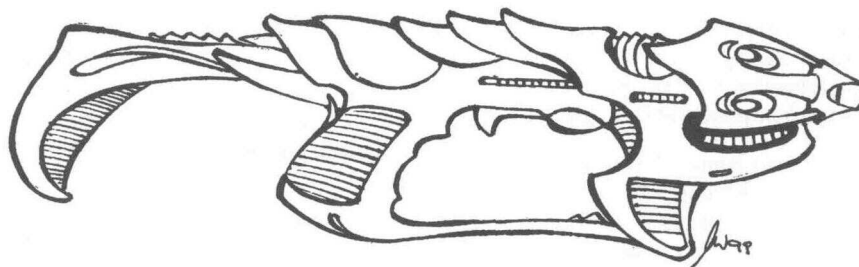

Z41 "Stallone" Energy Assault Rifle

Weight: 5.5 lbs. (2.5 kg)

Damage: 4D6 nick, 1D6x10 direct hit.

Rate of Fire: Single shot, each blast counts as one melee attack.

Effective Range: 1000 feet (305 m).

Primary Payload: 30 shots. **Reserve Payload:** 10 shots.

Cost: \$100,000



Z60 "Schwarzie" Light Energy Cannon

This weapon is the Zapper equivalent of a light machinegun. Those with a P.S. under 19 are -2 to strike.

Weight: 15 lbs (6.8 kg)

Damage: 5D6 nick, 1D6x10+10 direct hit.

Rate of Fire: Single shot, each blast counts as one melee attack.

Effective Range: 1,400 feet (427 m).

Primary Payload: 50 shots! **Reserve Payload:** 15 shots.

Cost: \$250,000

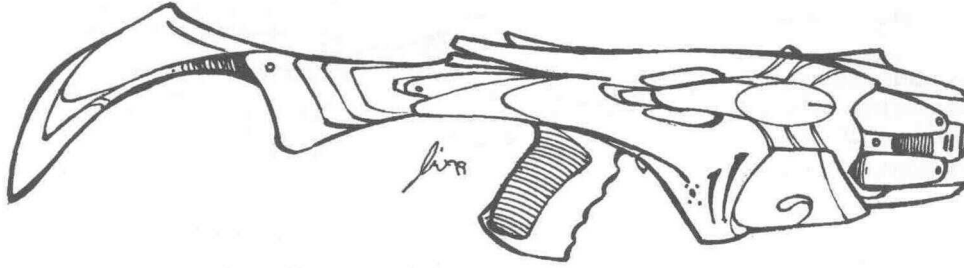

Z88 "The Duke" Energy Support Cannon

This weapon is the Zapper equivalent of a heavy machinegun or a bazooka. There are both an over the shoulder, bazooka-style model and hip-shooting heavy machinegun-style model. This and the Schwarzie are favorites of NORAD's mutant Bugboys/Splicers. They may also be mounted on vehicles or used on a tripod by a two-man team. A P.S. of 22 or higher (or superhuman P.S.) is required to use this weapon effectively. Those with a lower P.S. are -4 to strike and can not make an aimed shot unless the gun is braced.

Weight: 25 lbs (11.25 kg)

Damage: 6D6 nick, 2D4x10+12 direct hit.

Rate of Fire: Single shot, each blast counts as one melee attack. **Effective Range:** 2000 feet (610m)!

Primary Payload: 60 shots! **Reserve Payload:** 20 shots.

Cost: \$375,000.

Bug Bombs

After Bug Zappers, Bug Bombs are the most ubiquitous piece of Organitech in service. Actually, these weapons predate the Bug Zappers and are considered a piece of "stepping stone" technology that made the Zappers a reality. Some would argue that the advent of self-recharging energy weapons makes these one-shot explosives obsolete. Not so, say the various NORAD soldiers and Exterminators who have made repeated use of Bug Bombs. Coming in varying sizes and strengths, these weapons are a favored part of any Bughunter's arsenal. In fact, so many Exterminator squads have objected to phasing these weapons out that NORAD maintains regular production of them. The only Bug Bombs currently in production are high explosive weapons, but there are consideration for the development of a wider variety of munitions, including those filled with thermite plasma or Bug Juice.

Needless to say, Bug Bombs are one-shot items. Most often, they are thrown; with miniature stabilizing fins on them, the bombs will extend one's throwing range by a whopping 50%! Or, they can be fitted to the barrel of any Bug Zapper and fired like a conventional rifle grenade. Simply firing one shot will launch the Bug Bomb, which will have a range equal to the Zapper's energy blast. In addition, there are reports of some militia groups fitting conventional rocket heads with one, two, or even three Bug Bombs as a makeshift multiple warhead. Meanwhile, NORAD is exploring the development of Organitech Bug Bombs and multi-rocket launchers that would be able to launch volleys.

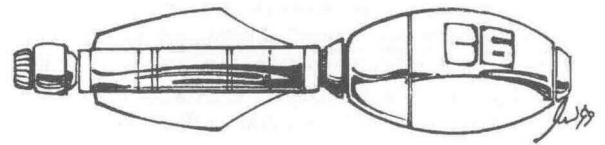

B6 "Quarterstick": **Weight:** 1 lb (.45 kg), **Damage:** 1D4x10, **Blast Radius:** 25 feet (7.6 m), **Cost:** \$1,000

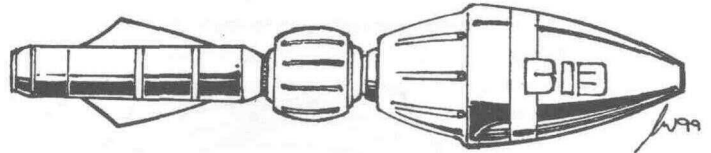

B13 "Crater Maker": **Weight:** 1.5 lb (1.68 kg), **Damage:** 1D6x10, **Blast Radius:** 50 feet (15.25 m), **Cost:** \$2,000

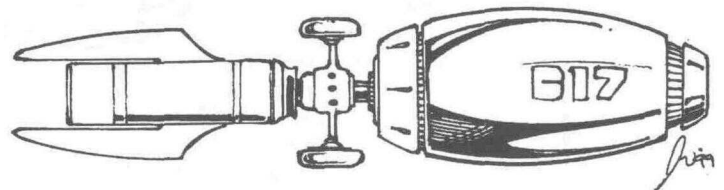

B17 "Big Bang": **Weight:** 2lb (.91 kg), **Damage:** 3D4x10, **Blast Radius:** 75 feet (22.9 m), **Cost:** \$4,000

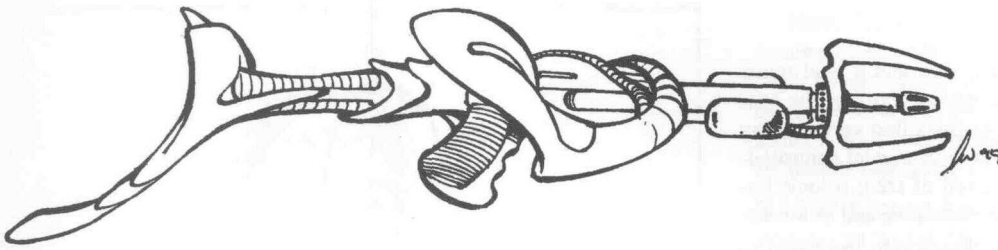

Bug Repellent

This is a termite plasma concoction that burns much hotter than napalm. Thanks to Bug Repellent's unique chemical composition, it will not stop burning once ignited until it has burned itself out (2D6 minutes). Naturally, this makes it a very dangerous and sometimes unpredictable weapon for infantry who use Repellent in conjunction with the R-140 Spray Gun. The extremely thin consistency of this stuff gives a Spray Gunner a much larger payload than your average flamethrower troop, making this weapon a favored "hive cleaner." NORAD has big plans for deploying Bug Repellent-filled warheads for portable rocket launchers and heavy aerial bombs.

R-140 "Heat Treatment" Spray Gun

Weight: 40 lbs (18.2 kg)

Fuel Capacity: 4 gal. (15 l) storage tank worn on back or a 1 gal. (3.75 l) canister magazine.

Payload: 20 bursts (backpack tank) or 5 bursts (canister magazine).

Rate of Fire: Five bursts per melee round, maximum.

Range: 200 feet (61 m)

Damage: 1D6x10 on initial contact. *Anything* combustible hit by this will ignite and take an additional 4D6 damage per melee round for the next 2D6 minutes (8-48 melees). Even noncombustible materials, like concrete or steel take half damage during that time from heat stress.

Cost: \$5,000 for the R-140, \$500 per gallon (3.75 l) of Bug Repellent.

Note: Bug Repellent is not suitable as a fuel.

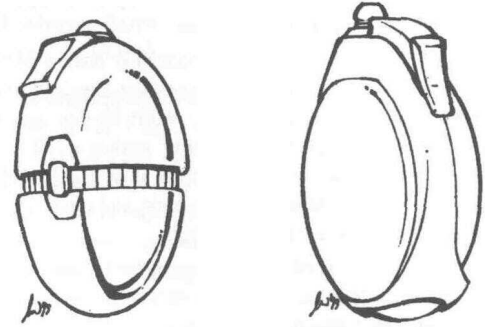

J1 and J2 "Water Balloon" Bug Juice Grenades

Weight: 1 pound (0.45 kg)

Range: Thrown (J1) or by grenade launcher (J2).

Damage: 1D6x10 on initial contact. 5D6 the following melee round, 2D6 the third melee round. After that, the chemical becomes inert.

Cost: \$30(J1) or \$50(J2)

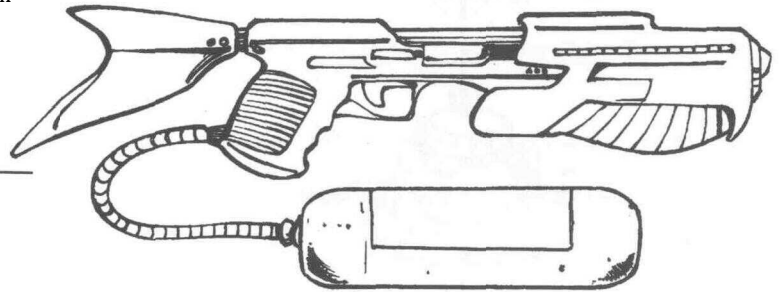

J140 "Mega Soaker" Spray Gun

Weight: 40 lbs (18.2 kg)

Fuel Capacity: 4 gallon (15 liter) storage tank worn on back or a 1 gal. (3.75 l) canister magazine.

Payload: 60 bursts (backpack tank) or 20 bursts (canister mag).

Rate of Fire: Five bursts per melee round, maximum.

Range: 200 feet (61 m)

Damage: 1D6x10 on initial contact. 5D6 the following melee round, 2D6 the third melee round, per each burst.

Cost: \$5,000 for the J-140, \$25(!) per gallon (3.75 liters) of Bug Juice.

Note: It is widely rumored that some courageous NORAD Eggheads have gone rogue/AWOL to teach non-NORAD militia groups how to "home-brew" Bug Juice. Such groups reportedly have done well making crude molotov cocktails (same as J1 or J2 grenades) and "Juice Balloons" with the stuff, made from real balloons (does 5D6 damage, +2D6 and 1D4 damage the following melee rounds; 40 ft/12 m maximum throwing range and -3 to hit unless 20 ft/6 m or closer), as well as spray weapons similar to the Mega-Soaker and loading large squirt guns with it (does 3D6, 1D6 and 1 point damage per squirt; 20 shots, 60 ft/18 m range).

Bug Juice

This is NORAD's other liquid munition, a chemical weapon with effects so graphic that had it been developed for use against humans, no civilized nation would have considered its use. Bug Juice is based on ordinary organic pesticides that kill normal insects by *dissolving* their cellular structure — a Bug acid! NORAD simply took this, cross-engineered it with Bug genetic material and boosted the effects dramatically. The best part about Bug Juice (aside from it being extremely cheap to produce) is that it's completely harmless to all Earth organisms (unless ingested) — it harms only Bugs.

Bug Juice grenades (hand thrown or 40 mm) and spray guns (variants of the R-140 Bug Repellent unit) are routinely deployed to combat units everywhere. Any Bugged human who *ingests* Bug Juice will quickly die. No save, no second chance. Once Bug Juice enters the bloodstream of a Zombie, the human body takes damage from its poisonous nature, but more importantly, the Silkworm inside it will die in 1D4 minutes and take the rest of the host body with it. **Note:** The damage listed is the damage done to Bugs, bypassing A.R. and doing damage first to S.D.C., and then Hit Points. If drunken by a human, it is poisonous and does half damage.

Bug Motels

These devices are a combination of a Bug trap and a land mine. Placed anywhere on an electrical, cable or telephone hardline, the Motel will begin emitting an energy signature that Bugs find very alluring and difficult to resist — effectively a roll to save vs mental control/allure that requires a 14 or higher to save on a roll of D20; psionic bonuses do NOT apply (only the Tier 3 bugs are +5 to save and Silkworm Zombies are immune). Failure to save means heading to the Motel to investigate and feast. The Bug must turn into energy to enter the Motel, at which point it locks the Bug's own energy signature into a passive defense matrix, making it impossible for the Bug to escape, and also blocks the Bug's telepathic communications.

Damage: Where the land mine part comes in is once a Motel has at least one Bug trapped inside it, it then can use the Bug's stored energy to detonate, killing the Bug and inflicting 4D6x10 damage to everything inside and 6D6 damage to everything within a 10 feet (3 m) radius of it. For each additional Bug trapped inside a Motel when it blows, add another 1D6x10 damage to the blast and another 10 feet (3 m) to the blast radius due to increased energy.

Bug Motels can be detonated by remote control (requiring an operator) or set to detonate once it has been activated by a single Bug or after several (from a few to maximum) have entered it.

If the Bug Motel is destroyed from the outside, either by accident or by a Zombie or Tier 3 Bug, all those contained inside will be set free. The smallest Motels have 15-30 S.D.C. The two largest have 80 S.D.C.

Note: NORAD reportedly has plans for building a massive motel that would be capable of holding, trapping and destroying Bugs in their physical form or trapping as many as one hundred Bugs and delivering an incredibly powerful blast. Whether or not NORAD will pursue this technology or even deploy it if they did make Motels this size, is debatable.

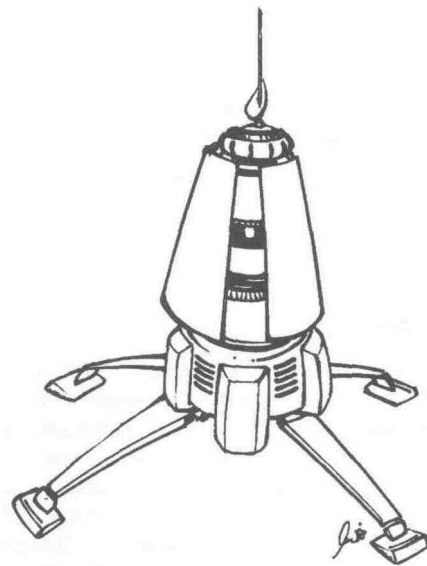

M30 "Tourist Trap": Weight: 5 lbs. (2.3 kg). Transmission Range: 75 miles (120 km). Storage Capacity: 10 Bugs. Cost: \$2,000

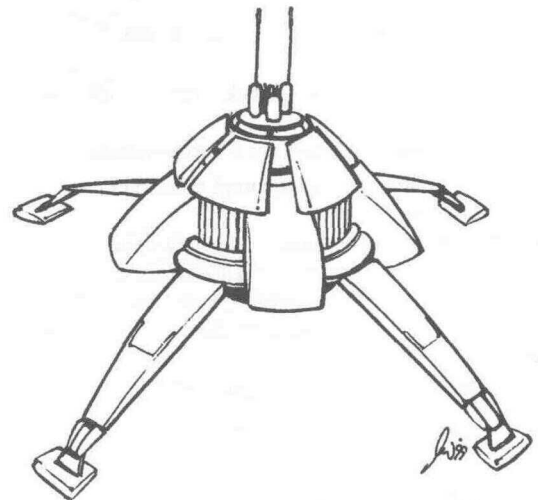

M50 "Convention Center": Weight: 15 lbs. (6.8 kg). Transmission Range: 150 miles (240 km). Storage Capacity: 20 Bugs. Cost: \$5,000

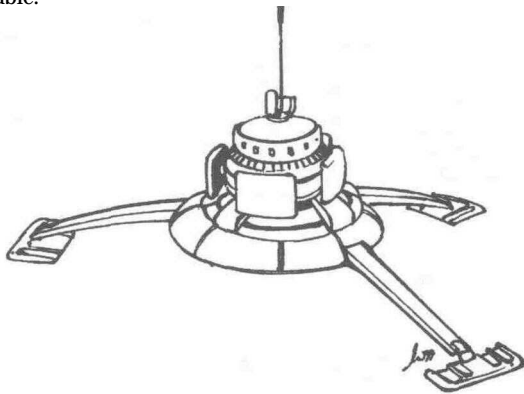

M3 "Micro Motel": Weight: 1 lb. (.45 kg). Transmission Range: 50 miles (80 km). Storage Capacity: 1 Bug. Cost: \$500

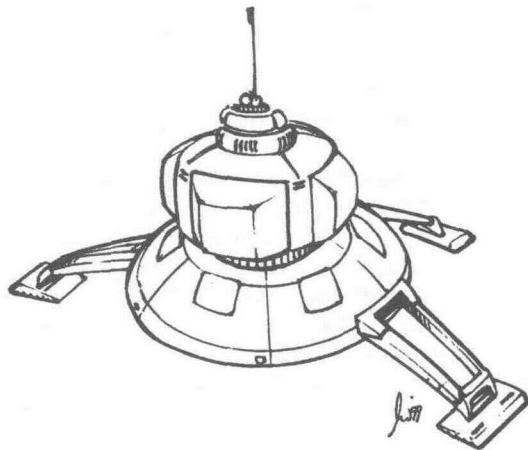

M11 "Fleabag": Weight: 2.5 lbs. (1.13 kg). Transmission Range: 50 miles (80 km). Storage Capacity: 5 Bugs. Cost: \$1,000

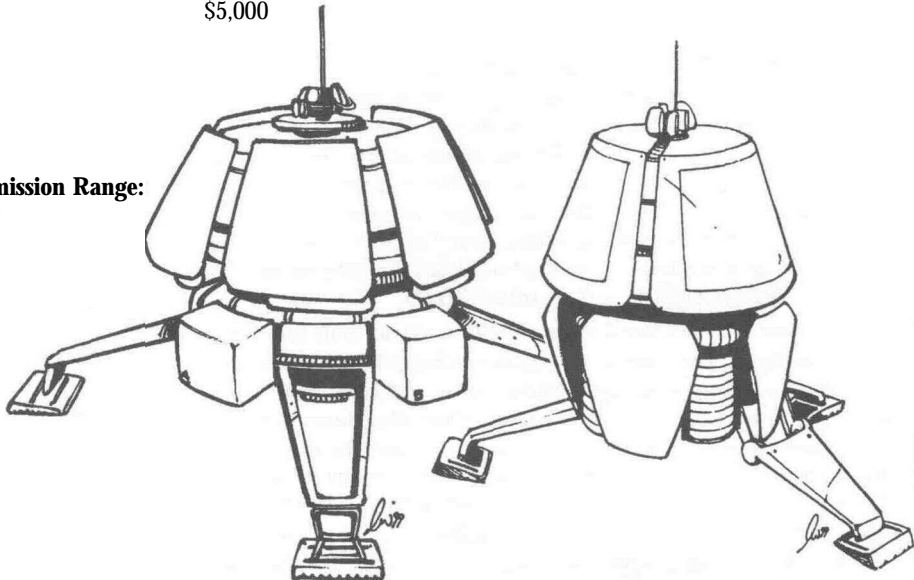

M76 "Club Dead": Weight: 25 lbs. (11.25 kg). Transmission Range: 200 miles (320 km). Storage Capacity: 30 Bugs. Cost: \$7,500

M99 "Ritz-o-Matic": Weight: 50 lbs. (22.7 kg). Transmission Range: 300 miles (482 km). Storage Capacity: 40 Bugs. Cost: \$10,000



Battlesuits

The final major weapon in NORAD's Bughunter arsenal is its line of prototypical Organitech Battlesuits. These suits of combat armor are their own self-recharging power source, and if destroyed (reduced to zero S.D.C.), will "die" and slowly decompose. While operational, Organitech battlesuits give off zero additional heat signature, so the wearer blends in perfectly with his surroundings as far as infrared and thermographic imaging are concerned.

These weapons are extremely rare and will not be issued casually. If a Battlesuit was reported for sale on the open market, NORAD will go to *considerable* lengths to retrieve it. No cost is given for these items, as they are effectively priceless and rarely available to anyone but NORAD operatives and, occasionally, their most trusted and favored allies (i.e. militia leaders, special freelance agents/adventurers who frequently work with NORAD and others who have built strong ties to them).

Note: The A.R. for these suits is considered *natural*/A.R., so any incoming attack rolls that are equal to or less than the A.R. will do *absolutely no damage*. Attacks that go above the A.R. will damage the suit, but the wearer will be unhurt. At the G.M.'s option, Natural 20s may inflict normal (or half) damage directly to a suit wearer. All Organitech Battlesuits regenerate 10 lost S.D.C. per hour!!!

N125 "Grunt Tuxedo"

Weight: 25 lbs (11.25 kg).

A.R.: 13, **S.D.C.:** 100.

Life Span: 3 years.

Armaments: None.

Other Features: Enhances Reflexes and Dexterity of the wearer (+2 to initiative, +2 to strike and parry, +3 to dodge, +1 attack per melee).

N250 "Bugthumper"

Weight: 50 lbs (22.5 kg).

A.R.: 15, **S.D.C.:** 250.

Life Span: 5 years.

Armaments: 2 forearm-mounted Z23 Energy Carbines/SMGs; Effectively unlimited payload; consider the normal Z23's payload when determining burst firing.

Other Features:

Enhances Reflexes and Dexterity of the wearer: +3 to initiative, +3 to strike and parry, +1 attack per melee round, autododge (can dodge without it counting as a melee action).

Enhanced Strength: +12 to wearer's P.S.

N375 "Hoosier Daddy"

Weight: 100 lbs (45.4kg).

A.R.: 17, **S.D.C.:** 500

Life Span: 10 years.

Armaments: 2 forearm-mounted Z41 Energy Assault Rifles; Effectively unlimited payload.

2 forearm-mounted R-140 or J-140 Spray Guns; Internal 4 gallon (15 liter) canister drums.

Other Features:

Enhanced Reflexes and Dexterity: +4 to initiative, +3 to strike, parry and autododge, +2 attacks per melee, and autododge (can dodge without it counting as a melee action).

Enhanced Strength: Double wearer's P.S. to a minimum of 30.

Jump Vents: Enable wearer to take jet-assisted leaps up to 300 feet (91.5 m) in any direction.

Other Organitechology

Organitech Batteries and Electronics: Organitech batteries and electronics systems are being developed to upgrade existing conventional technology, making it Bugproof. **Cost:** \$200-\$1000 for Organitech batteries, depending on their size. \$2,500-\$25,000 for Organitech electronic systems, depending on their complexity. \$30,000-50,000 for small to large generators. These items are almost exclusively limited to sale to people NORAD approves of and to their allies in Four Corners.

Shrieker: A transmitter that emits a piercing wail that is painful to all Bugs within 500 feet (152.5 m), but is completely inaudible to humans and most other Earth life forms. Bugs within range are lose initiative and are -4 to strike, parry and dodge. No saving throw. **Weight:** 21 lbs (9.5 kg). **Cost:** \$3,500.

Organitech Breathe Mask: Renders the wearer immune to all man made gas weapons (including nerve gas) and the Bug's mind numbing gas and sprays. **Weight:** 1 lb (0.45 kg). **Cost:** \$1,000.

Conventional Guns, Ammo & Explosives

Due to space limitations (expanded to 144 pages at 9 pt), we still can't squeeze everything we want into this book, we are listing approximate damage per caliber, rather than by weapon type (we list only a few choice examples). Revolvers, automatic pistols and sub-machineguns take approximately the same type and caliber of ammunition.

Prices are per box of 100 rounds and are **pre-Meltdown** costs. Consequently, prices will vary greatly from those listed below from place to place. Weapons and ammo are especially hard to come by and cost 20-500% more at Bugtowns and other places dominated by the Bugs. In Free America, the cost will usually range from the list price to 50% higher, rarely more than double. Base price for most items available from Four Corners. Remember that most of these items can be traded for only. Big-ticket items, such as rocket launchers and grenade belts, may require the trade of something worth significantly more than the item being traded for. After all, when it comes to weapons in Systems Failure, it truly is a seller's market.

For scores of firearms listings and stats, see the **Heroes Unlimited G.M.'s Guide**. For hundreds of firearms from around the world, each illustrated, plus body armor, and much more, see Palladium's **Compendium of Contemporary Weapons**

.22 caliber, \$15.00 — 2D4 damage
.32 A.C.P. caliber, \$18.00 — 2D6 damage
.32 Long, \$20.00 — 3D6 damage
.38 caliber, \$24.00 — 3D6 damage
.38 Power caliber, \$28.00 — 4D6 damage
.45 A.C.P., \$30.00 — 4D6 damage
.41 Magnum, \$32.00 — 5D6 damage
.44 Magnum, \$35.00 — 6D6 damage
.357 Magnum, \$35.00 — 4D6 damage
9mm & 7.65mm (pistol) \$30.00 — 3D6 damage
10mm (pistol), \$35.00 — 4D6 damage
5.56mm (rifle), \$40.00 — 5D6 damage
7.5mm (rifle), \$45.00 — 5D6 damage
7.62mm (rifle), \$45.00 — 4D6 damage
.30 caliber (rifle), \$40.00 — 4D6 damage
.50 caliber (rifle), \$50.00 — 6D6 damage
Tracer Cartridge add \$45.00
Hollow Point add \$20.00
Full Metal Jacketed add \$25.00
Teflon (armor piercing, not available to the public) add \$100.00
Exploding Shell (not available to the public) add \$200.00 and +2D6 to damage.
Dum Dum (hand-made, black market, any caliber) add \$10.00 to \$30.00, and +1D6 to damage.
40mm Grenade Cartridge, \$800.00 (per 100)
.30 Caliber Machinegun, \$80.00 — 1D4x10 damage
.50 Caliber Machinegun, \$100.00 — 1D6x10 damage

Some Special Cartridge Types

Tracer: This cartridge contains a compound that ignites and burns when the cartridge is fired which creates a visible flight path from the gun to the target. This makes it easy to adjust fire, especially at night and during automatic burst fire. Cartridge range is reduced by 10-20%. When used in machineguns, these rounds are placed once every 10 rounds along the belt, giving a bonus of +1 (single-shot) or +2 (burst fire) to strike. **Cost:** Add \$45 to ammunition cost.

Hollow Point: The bullet of this cartridge is hollowed out and scored so that it expands (or "flowers") on impact, causing a large wound (+3 to damage). Against hard structures, such as vehicles, doors, walls, and personal body armor, reduce the normal cartridge damage by one die. **For Example:** A gun that does 3D6 normally, does 3D6+3

versus a person, but only 2D6 against a car, wall, or armored person. **Cost:** Add \$20 to ammunition cost.

Full Metal Jacket: These rounds are coated with a tough metal jacket that adds +1D6 damage. Full metal jacket rounds exist for all small arm calibers. **Cost:** Add \$25 to ammunition cost.

Armor Piercing/Teflon (KTW Rounds): These rounds add +1D6 to damage and lower the target's A.R. by 2. **Cost:** Add \$100 to ammunition cost.

Exploding/Mercury-Tipped Shells: Primarily used in pistols because burst fire has a 40% chance of prematurely rupturing the shell. These bullets do not actually have an explosive charge in them, but rather contain a small mercury-filled chamber. Upon impact, the shell shatters, filling the victim with tiny shrapnel. Adds +2D6 to damage, but reduces range by 10%. **Cost:** Add \$200 to ammunition cost.

Some Common Firearms

King Cobra (Colt .357 Magnum) Revolver

Country: U.S., **Cartridge:** .357 Magnum, **Feed:** 6 chamber side-loading cylinder, **Weight:** 2.9 lbs (1.3 kg), **Barrel Length:** 6 inches (153 mm), **Muzzle Velocity:** 1155 ft/s (352 m/s), **Approx. Effective Range:** 165 feet (50 m), **Damage:** 5D6, **Cost:** \$600-800.

Anaconda (Colt .44 Magnum) Revolver

Country: U.S., **Cartridge:** .44 Magnum, **Feed:** 6 chamber side-loading cylinder, **Weight:** 3.7 lbs (1.7 kg), **Barrel Length:** 8 inches (203 mm), **Muzzle Velocity:** 990 ft/s (302 m/s), **Approx. Effective Range:** 150 feet (45 m), **Damage:** 6D6, **Cost:** \$600-850.

Automag (AMT) Pistol

Country: U.S., **Cartridge:** .22 Magnum to .50 AE, **Feed:** 9 round magazine (.22) and 7 round magazine (.44), **Weight:** 2 lbs (0.9 kg), **Barrel Length:** 4.6 inches (117 mm), **Muzzle Velocity:** 1188 ft/s (362 m/s), **Approx. Effective Range:** 165 feet (50 m), **Damage:** 2D4 (.22 magnum) up to 6D6 (.44 magnum and .50 AE), **Cost:** \$750-900.

Officer's ACP .45 Colt Automatic Pistol

Country: U.S., **Cartridge:** .45 ACP, **Feed:** 6 round mag., **Weight:** 2 lbs (0.9 kg), **Barrel Length:** 35 inches (88.9 mm), **Muzzle Velocity:** 1155 ft/s (352 m/s), **Approx. Effective Range:** 165 feet (50 m), **Damage:** 4D6, **Cost:** \$750-900.

9 mm Mini Uzi Machine Pistol

Country: Israel, **Cartridge:** 9 mm Parabellum, **Feed:** 20, 25 or 32 round box mag., **Weight:** 5.9 lbs (2.67 kg), **Barrel Length:** 7 inches (178 mm; 600 mm overall), **Muzzle Velocity:** 1155 ft/s (352 m/s), **Approx. Effective Range:** 500 feet (15.2 m), **Damage:** 3D6, **Cost:** \$800-900.

TEC-9 Machine Pistol

Country: U.S., **Cartridge:** 9 mm, **Feed:** 20 and 32 round magazine, **Weight:** 2.75 lbs (1.3 kg), **Barrel Length:** 5 inches (127 mm), **Muzzle Velocity:** 604 ft/s (183 m/s), **Approx. Effective Range:** 135 feet (41 m), **Damage:** 3D6, **Cost:** \$480.

9 mm Uzi Sub-machinegun

Country: Israel, **Cartridge:** 9 mm, **Feed:** 25, 32, or 40 round box mag., **Weight:** 7.7 lbs (3.5 kg), **Barrel Length:** 10.4 inches (264 mm; 650 mm overall), **Muzzle Velocity:** 1320 ft/s (400 m/s), **Approx. Effective Range:** 660 feet (201 m), **Damage:** 3D6+1, **Cost:** \$1,000.

M-960A Calico Sub-machinegun

Country: U.S., **Cartridge:** 9 mm Parabellum, **Feed:** 50 or 100 round helical mag., **Weight:** 4.8 lbs (2.17 kg), **Barrel Length:** 13 inches (330 mm), **Muzzle Velocity:** 1320 ft/s (400 m/s), **Approx. Effective Range:** 615 feet (187 m), **Damage:** 3D6, **Cost:** \$950.

McMillan M87R Rifle

Country: U.S., **Cartridge:** 12.7 x 99 mm (.50 Browning), **Feed:** 5 round box mag., **Weight:** 21 lbs (9.45 kg), **Barrel Length:** 30 inches (762 mm), **Muzzle Velocity:** 1257 ft/s (381 m/s), **Approx. Effective Range:** 660 feet (201 m), **Damage:** 1D4x10, **Cost:** \$4,000.

M16 & M16A1 Automatic Assault Rifle

Country: U.S., **Cartridge:** 5.56 mm, **Feed:** 20 or 30 round box mag., **Weight:** 6.8 lbs (3.1 kg), **Barrel Length:** 20.4 inches (518 mm), **Muzzle Velocity:** 3300 ft/s (1,005 m/s), **Approx. Effective Range:** 1,320 feet (402 m), **Damage:** 5D6, **Cost:** \$2,400.

G11 (Heckler & Koch) Automatic Assault Rifle

Country: Germany, **Cartridge:** 4.7 mm x 33 mm caseless, **Feed:** 50 round mag. (200% ammunition for bursts), **Weight:** 8 lbs (3.65 kg), **Barrel Length:** 20 inches (508 mm; 1025 mm overall), **Muzzle Velocity:** 2650 ft/s (807 m/s), **Approx. Effective Range:** 1,320 feet (400 m), **Rate of Fire:** Cyclic: 500-600 rounds/minute; Auto: 100 rounds per minute. **Damage:** 3D6, **Cost:** Not available in civilian markets. Prices would start at \$8,000-\$10,000 on the black market. **Note:** This advanced weapon was designed to fire a three round burst with no applicable recoil (the recoil takes affect after the rounds leave the gun). This weapon can fire short bursts with no penalty, so the burst is +3 to strike, like an aimed shot! Ammunition for this weapon costs \$200 for 50 and special ammunition types cost ten times the normal costs. This ammunition leaves no spent brass casings behind when it is fired.

Shotguns

The effective range for all shotguns is 150 ft (45.7 m). Buckshot and similar fragmentation rounds will spray a 3 feet (0.9 meter) area. A sawed-off shotgun has a dramatically reduced barrel size which increases the width of the buckshot "spray" (covers a 1.5 m/5 foot area), but reduces the effective range to 60 ft. (18 m).

Semi-automatic/self-loading shotguns can fire a three-round burst that acts as a short burst, but it is -1 to strike.

Typical Damage: 4D6 for Buckshot (Scatters to cover a 3 ft/0.9 m area at 30 feet/9 m and a 10 ft/3 m area at 60 feet/18 m); 5D6 for solid slug.

Firearm Accessories

Ankle Holster: Padded for comfort, with velcro closure. Fits a snub-nosed revolver or any *small* frame automatic. Can be concealed under pant leg. \$40.

Inside Trouser Holster: Clips on belt or waistband of pants. \$20.

Side Holster (fits onto belt). \$50.

Belt Slide Holster. \$50.

Belt Thumbbreak Holster. \$50.

Patrolman, Police-Style Belt and Holster, 24 bullet loops. \$80.00.

Police-style Shoulder Holster. \$90.

Military-style Shoulder Holster. \$70.

Horizontal Shoulder Holster. \$85.

Scoped Shoulder Holster. \$90.

Concealed Wallet Holster for *small* automatic weapons; fits easily into back trouser pocket. \$60.

Web Belt with holster, ammo pouches (2) and accessory attachment clips (4). \$60.

Magazine Clip Pouch: Each of these specially designed ammo pouches is designed for 2 (slimline) or 4 (heavy-duty) ammo clips.

Choice of camouflage, green, khaki or black colors.

Automatic Pistol: 2 clips, \$10; 4 clips, \$20

Sub-Machinegun: 2 magazines — \$15; 4 mags — \$20

5.56mm Assault Rifle, 20-rnd: 2 clips, \$20; 4 clips, \$35

5.56mm Assault Rifle, 30-rnd: 2 clips, \$25; 4 clips, \$40

7.62mm Assault Rifle, 20-rnd: 2 clips, \$28; 4 clips, \$50

7.62mm Assault Rifle, 30-rnd: 2 clips, \$28; 4 clips, \$45

Magazine Ammo Bags. \$40.

Assault Rifle Case. \$90.

Rifle Case. \$80.

Sub-Machinegun Case. \$80.

Shotgun Bandoleer: Bandoleers are made of brown leather, with a heavy-duty, brass belt buckle. Shotgun version will hold 56 rounds. 40mm grenade version holds 18 rounds. \$30.

Wrist Cartridge Bandoleer: Perfect for concealing 3 extra cartridges. \$20 each.

Metal Ammunition Boxes: These waterproof ammo boxes are designed for easy storage and carrying. .50 caliber size: \$18. .30 caliber size: \$12

Field Gun Cleaning Kit: A complete cleaning kit contained in its own pouch. \$35.

Gun Repair Kit: This is a 4 pound (1.8 kg) gun repair kit. Each tool is fitted into a separate loop and there's plenty of room for spare bolts, screws, springs and cleaning rods. Contained in a 12 inch by 8 inch by 2 inch (30x20x5 cm) case. Can be attached to a harness or worn over the shoulder with strap, which is included. \$250

Magazine Clips: Any weapon, any size, from 7-round pistol to 30-round rifle. \$1.00 each.

Web Belt: Classic military belt complete with buckle and pouch fasteners. Choice of camouflage, green or khaki. \$20.

Battle Harness: Combination of suspenders and belt designed for distributing the weight of ammo pouches and accessories. In choice of camouflage, black, grey, brown, cream or khaki. \$130.

Battle Pack: Lightweight frame, heavy-duty, water resistant canvas. Multiple interior and exterior compartments. Fasteners for exterior pouches/grenades. Choice of camouflage, green or khaki colors. \$350.

Multi-Purpose Pouch: All around, useful utility pouch designed for attachment to web belt or battle harness. \$10.

Silencer: An attachment which fits over the barrel of a gun to muffle the sound of the report. Perception rolls require a 10 to detect silenced shots from 20 ft away; outside of that, silenced shots are inaudible. Silencers reduce a weapon's range by 10%. **Cost:** \$400 (pistol or SMG) or \$1,000 (rifle).

Flash Suppressor: An attachment that fits over a gun barrel to mask the muzzle flash during firing. Characters within 100 ft. (30.5 m) of a suppressed shot have only a 25% chance of seeing it. Outside of that, suppressed shots are not visible. **Cost:** \$400 (pistol or SMG) or \$1,000 (rifle). **Note:** Combined silencers and flash suppressors cost \$1,000 (pistol or SMG) or \$2,000 (rifle) and reduce a weapon's range by 25%.

Recoil Diminishers: A small tube filled with mercury and ball bearings and mounted along the length of the firearm to counter recoil during firing. The system is custom built for each class and type of firearm. Adds +1 to strike when burst firing. Not usable with heavy weapons. Cost: \$1,000.

Optics

Binoculars and Telescopic sights magnify an image area through a system of lenses.

Binocular, Telescopic Sights & Cost:

Binocular (2000 feet/610 m), best magnification: \$1600.

Binocular (1600 feet/487 m), medium magnification: \$1000.

Binocular (1600 feet/487 m), low magnification: \$600.

Weapon Sight, best magnification: \$1200.

Weapon Sight, medium magnification: \$600.

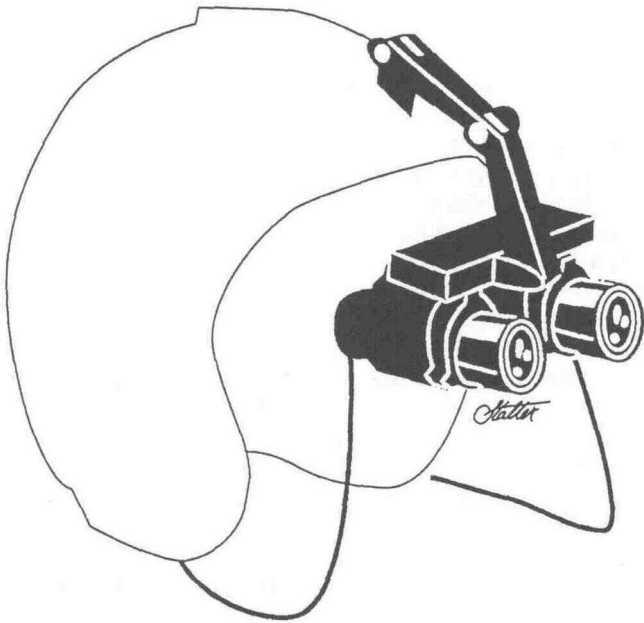

Infrared Optic System: **Range:** 1200 feet (365 m). This type of optical enhancement device relies on a source of infrared light, usually a pencil-thin beam of light projected from the goggle or binoculars, to illuminate its targets. The narrowness of the beam severely limits the scope of one's view to a small area of about 18 square feet (two square meters). This can make surveying a large area a problem. Another drawback is that the infrared light beam is clearly visible to another infrared optic system, giving away the operator's position. These drawbacks are inherent to ALL infrared systems. **Cost:** about \$1000; fair availability.

Infrared (range: 1200 feet/365 m) & Cost:

Goggles (mercury battery type) — \$550.

Goggles (new superior type) — \$880.

Binoculars — \$2100.

Monocular Eyepiece — \$800.

Weapon Sight — \$1200.

Infrared Distancing Binoculars: A high-powered optical enhancement device with infrared adjustments, cross hair indicator lines, and digital readout of estimated distance and rate of travel. **Range:** 2 miles (3.2 km). The I.D. binoculars enjoy extreme popularity among spies, being used for field work and exploration, and are also used by the military. **Cost:** \$6700. Not commercially available.

Illuminating Peglight: Designed for military use as markers for routes and minefields. Emits beta light which gives off no heat and no infrared emissions. Can be seen from distances of up to 150 feet (45.7 m). **Cost:** \$50 each.

Laser Sights: These small targeting systems fit on all firearms. They project a laser beam that produces a red dot on the target, showing approximately where the bullet will hit. Laser sights add +1 to all firearms rolls, including bursts, but their range is limited to 200 feet (61 m). **Cost:** \$200.

Nightsight: **Range:** 1600 feet (480 m). A passive night vision optics system is an image intensifier, meaning that it is a passive system that does not emit any light of its own, but electronically amplifies existing, ambient light to provide a visible picture. **Cost:** \$1,600; fair availability.

Passive Nightvision Optics (range: 1600 feet/480 m) & Cost:

Goggles — \$5,200.

Binoculars — \$6,400.

Monocular Eyepiece — \$1,900.

Weapon Sight — \$3,500.

Pocket Night Viewer (800 feet/240 m range) — \$1500.

Large Tripod Mount — \$14,000.

Pocket Night Viewer: **Range:** 800 feet (240 m). This is a mini-night sight, usually a monocular style, easily concealed and portable. **Cost:** \$800; poor availability.

Pocket Range Finder: An optical range finder that is compact and easy to use. Just look through the viewfinder and adjust the focus knob until the image is clear. The range in feet AND meters will appear below the target. **Cost:** \$58.

Thermo-Imager: **Range:** 1600 feet (480 m). Basically an optical heat sensor, it converts the infrared radiation of warm objects into a visible image. This device allows its operator to see in darkness, shadows and through smoke. Battery powered and electrically cooled. A typical running life is 16 hours. **Cost:** about \$1400; poor availability.

Thermo-Imager (range: 1600 feet/480 m) & Costs:

Goggles — \$22,000

Binoculars — \$20,000

Monocular Eyepiece — \$18,000

Weapon Sight — \$18,000

Ultraviolet Systems: **Range:** 400 feet (120 m). Enables its wearer to see into the ultraviolet range of light radiation. It's usually integrated into a larger optics package rather than used alone. **Cost:** \$500.

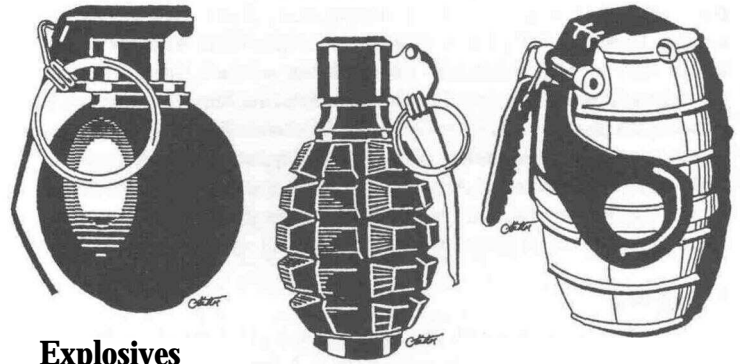

Explosives

Explosives are generally restricted to industrial and military use and difficult to obtain even for heroes and villains. Unless stolen or provided by a sponsoring organization, characters will be forced to purchase them illegally. Prices on the black market are generally quite steep and circumstances or the individual seller may increase the prices listed by 100%.

Black Market Prices

Cost & Availability in Systems Failure's America:

Dynamite: \$30 per stick — 60%

Detonation Caps/Fuses: \$30 each — 42%

Homemade Bomb: \$10-\$20 for components — 70%

Plastic Explosive: \$100 for two ounces (56 grams) — 15%

Gelatin Explosive: \$140 per ounce (28 grams) — 18%

Liquid Nitroglycerin: \$200 per ounce (28 grams) — 20%

Hand Grenades: \$150 each — 30%

Smoke Grenades: \$60 each — 40%

Rifle Launched Grenades: \$200 each — 20%

Mortar Shells: \$300 each — 10%

Note: There is always a 20% chance that the item is fake or a dud.

Descriptions will include two damage ratings. The first is the blast center, where most damage is done. The second is the extended blast radius and damage caused from flying particles of debris.

Dynamite is a nitroglycerin based explosive widely used in mining and road construction. It can be detonated with blasting caps, fuses and timing devices. Wick fuses were rarely used before The Meltdown, but about half use them today. **Damage:** *One stick: D4x10*. **Effective Casualty Radius:** 10 feet (3 m). **Note:** Good availability at Four Corners.

Homemade Bombs: Any variety, usually incorporate chemicals or gunpowder or dynamite. **Damage:** *One Bomb:* 5D6. **Effective Casualty Radius:** 10 feet (3 m).

Liquid Nitroglycerin is an extremely dangerous, unstable, chemical explosive concentrate. A severe jar, jerk or bump can cause it to detonate; 30% chance. **Damage:** *One ounce (28 g) is equal to four sticks of dynamite:* 4D4x10. **Effective Casualty Radius:** 20 feet (6.1 m).

Plastic and Gelatin explosives are very localized blast explosives that can be molded and formed like putty. Inert — you can slam a plastic explosive into a wall and nothing will happen. It can only be activated/ignited by an electrical blasting cap that will pass an electrical charge through it, causing it to explode. Any electrical charge, blast or bolt is also likely to detonate it; 55% chance. **Damage:** 2 ounces (56 g) is equal to one stick of dynamite: 1D4x10. Area effect of blast is exactly where the plastics or gel has been placed; about one foot (30 cm). Of course, depending on what is being exploded, it could cause much more additional destruction and damage. These are the types of explosives used to open safes and for sabotage. They are not effective area effect weapons.

Incendiary Weapons

M-2A1-7 Portable Flamethrower: With a solid stream of fire, a soldier could clear out an entire enemy machinegun nest. In confined spaces (inside a bunker, foxhole or building), everyone in the target area is affected equally. **Damage:** 5D10, plus ignition of all combustible material. **Weight:** 42.5 pounds (19.3 kg). **Feed:** Manual. **Effective Range:** 70 feet (21.3 m), unthickened; 150 feet (45.7 m), thickened. **Cost:** \$400.00 (mostly illegal).

AN-M14 TH3 Incendiary Hand Grenade: This is one of the most dangerous weapons and not just for the enemy. It is difficult or impossible to throw it far enough to avoid getting hit with fragments. **Damage:** up to 12 feet (3.6 m) from impact — 2D4x10+20 S.D.C. (or 1 M.D.C.); 12-24 feet (3.6 to 7.3 m) away — 1D6x10; 25-36 feet (7.6-11 m) away — 5D6; 37-120 feet (11.3-36.6 m) away — 2D6. Burns for 10 melee rounds. **Weight:** 24 ounces (0.7 kg). **Time Delay Fuse:** 4-5 seconds. **Effective Casualty Radius:** Lethal up to 60 feet (18.3 m), dangerous to 120 feet (36.6 m). **Cost:** \$30.00

Molotov Cocktail: A classic incendiary weapon, since it is so easy to make from commonly available materials. **Range Thrown:** 30 feet (9.1 m). **Damage:** 3D6 damage — up to a 12 foot (3.6 m) area. Burns for 4 melee rounds. **Cost:** \$15.00.

Flare Gun: The flare gun has not changed much over the decades and is basically like those we use today. It is generally used as a signal or to light up an area. *Used for Luminescence:* Lights up a 300 foot (91.4 m) area for about five melees (75 seconds). It is not intended to be a weapon, thus it is not balanced for aiming; W.P. handgun skill bonuses do NOT apply. **Range:** 300 feet (91.4 m). **Damage:** 2D6 per melee ignited (5 melees). **Attacks Per Melee:** Two. **Weight:** 2 pounds (0.9 kg). **Cost:** \$200 for the gun only; flares cost \$10 each. Wide availability.

Hand-Held Flares: The hand-held flare is generally used to mark an area or for signaling. They are similar to those used by present day truck drivers. **Range:** Hand Held. **Damage:** One point. **Attacks Per Melee:** Equal to hand to hand attacks. **Weight:** 6 ounces (170 grams). **Cost:** \$3 each; wide availability.

Rocket Flare: This hand-held flare has a disposable, one time, launch mechanism which fires the flare gun. Commonly used for expeditions in the wild. A (minus) -3 to strike penalty applies if used as a weapon. **Range:** 300 feet (91.4 m) straight up. **Damage:** 2D6. **Attacks Per Melee:** One. **Capacity:** One. **Weight:** 5 ounces (140 grams). **Cost:** \$10 each; wide availability.

Rocket Parachute Flare: A signal flare that is fired from a single hand launch tube or flare gun and deploys a parachute-support star. No visible rocket trail is left behind in its launch wake to give away the firer's position. **Maximum Height:** 1000 feet (305 m). **Duration of Illumination:** 30 seconds. **Power:** 200,000 candela. **Cost:** \$10 per

flare, plus \$300 for the launcher. **Available colors:** White, red, green, and yellow.

Distress Signal Kit: Consists of a tube launcher and six red flares.

Maximum Height: 900 feet (274 m). **Duration of Illumination:** 30 seconds. **Power:** 10,000 candela. **Cost:** \$120.

Mini-signal Cartridges: A lightweight signal cartridge designed for the military special forces. Fired from a single-handed, lightweight, pen-type launcher. **Maximum Height:** 320 feet (97.5 m). **Duration of Illumination:** 10 seconds. **Power:** 150,000 candela. **Colors available:** Green, red or white. **Cost:** \$250.

Gas Grenades

Tear Gas: This extremely potent irritant temporarily impairs vision and respiration, causing eyes to burn and water profusely, skin to burn (a sensation, not in actuality), and making breathing very difficult. **Victims** are -6 to strike, parry, dodge, and lose any chance for initiative. Effects are immediate. **Saving Throw:** None (gas masks counter the gas effectively). **Cost:** \$50.00 each.

Knockout Gas: These are tranquilizers; anesthesia-type mists that will induce drowsiness within 1D4 melees and sleep within 1D4 minutes. **Saving Throw:** If a character makes a successful saving throw vs toxins, his body has successfully fought off the effects of the gas and is unimpaired. However, the player must roll once for every minute (four melees) that the character is exposed to the gas (gas masks counter the gas effectively). **Cost:** \$100.00 each; rare.

Nerve Gas (paralysis): This is a gas that attacks the person's nervous system; in this case, causing paralysis. Takes effect within 2D4 melees (two minutes). **Saving throw:** If a character makes a successful saving throw vs toxins, his body will have luckily fought off the effects of the gas (and should get out quick). Roll a saving throw for each minute (four melees) exposed to the gas. Gas masks are useless against most nerve agents; however, Atropine Injectors, an anti-nerve gas agent, will negate the gas's effects. **Cost of Injectors:** \$400.00 per dosage. One injector is needed for every ten minutes of exposure and must be administered immediately. **Cost of Gas:** \$200.00 each; super-rare.

Explosive Grenade: **Weight:** 10 ounces (283 grams). **Effective Radius:** 20 feet (6.1 m). **Effective Range:** 100 feet (30.5 m). **Damage:** 2D4x10, (illegal).

Smoke Grenade: **Weight:** 10 ounces (283 grams). **Effective Radius:** 20 feet (6.1 m). **Effective Range:** 100 feet (30.5 m). **Damage:** *None;* creates a smoke filled area to provide protective cover (opponents can not see into or through the smoke) or as a signal. Opponents whose vision is obscured by the smoke are *-8 to strike, parry and dodge*. **Colors:** Black, grey, red, yellow.

Rifle Launched Grenades: Explosive or smoke grenades fired from an assault rifle. The previous stated damage and effects apply. **Rifle Range:** 1150 feet (350 m). *Single shot*, **Damage:** 2D4x10 to 20 foot (6.1 m) area.

Miscellaneous Modern Weapons

Black Jack: A small hand-held club, usually handmade, 10 inches (25 cm) long, weighing 2 to 4 pounds (0.9 to 1.8 kg). **Cost:** \$20. **Damage:** 1D6.

Brass Knuckles: **Cost:** \$20. **Damage:** 1D6.

Cattle Prod: An electric rod, operated on "C" cell batteries, that emits a 4500 volt shock when it is touched to the skin. 12 or 22 inch (30 or 56 cm) lengths. **Cost:** \$20. **Damage:** 1D4.

Itching Powder: Range varies with applications; can be used as a powder, launched in a grenade, housed in a pellet that ruptures on impact, and similar devices. Victims are very uncomfortable, distracted and are -3 on initiative. **Duration:** 1D4 hours or until washed off. Affects only bare skin. **Costs:** Only a couple of bucks per ounce (28 g) from a novelty shop.

Hair Spray: Can be used to temporarily blind an opponent. Victims are -6 to strike, parry and dodge. **Effective Range:** 3 feet (0.9 m).

Duration: 1D4 melees. **Cost:** \$3.

Mace: A stinging chemical spray that blinds one's opponent (much better than hair spray). Victims are -6 to strike, parry and dodge. **Effective Range:** 4 to 6 feet (1.2 to 1.8 m). **Duration:** 4D4 melees. **Cost:** \$16.00, with about 20 sprays before empty.

Modern Crossbow with rifle stock, 150 pound (667 Newton) draw weight. **Range:** 500 feet (152 m). **Damage:** 2D6. **Cost:** \$180.

Sap Glove: Six ounces (0.2 kg) of powdered lead is built into each glove just above the knuckles, padding the wearer and adding weight and strength to the force of one's blow. *+2 to damage.* **Cost:** \$30.

Fiberglass Nightstick: **Cost:** \$10. **Damage:** 1D4.

Steel Rod Encased Nightstick: **Cost:** \$20. **Damage:** 1D6.

S.W.A.T. Entry Tool a.k.a. Hooligan Tool: A long, one inch (2.5 cm) thick, stress-proof bar, heat treated for durability and strength. On one end is a large chisel, spike-like, pry bar. On the opposite end is a claw/chisel-point (crowbar-like). Used to pry open security doors and grilles. **Cost:** \$240. **Damage:** 1D8 (either end). Pops normal door locks on a roll to strike of 8-20; pops heavy locks and security door locks on a roll to strike of 12-20.

Modern Knives

Combat Bush Knife: Heavy-duty, all-purpose survival knife. The best carbon steel 7in/177 mm blade. **Cost:** \$200. **Damage:** 1D6.

Slimpack Throwing Knife: With a flat, lambskin sheath, this knife is perfect for concealment. Also a perfectly balanced 6 inch blade (0.15 m). **Cost:** \$50. **Damage:** 1D6.

Belt Throwing Knife Set: 4 ultrathin throwing knives in a single belt sheath designed for an easy, fast draw. **Cost:** \$135. **Damage:** 1D6.

Polycarbonate Knife: This 7 inch knife (with silk sheath) is guaranteed not to show up on metal detectors. Balanced for throwing, yet with a keen edge for slicing. **Cost:** \$300. **Damage:** 1D6.

Small Boot Knife: For easy concealment. **Cost:** \$20. **Damage:** 1D4.

Bayonet: Attaches to combat rifles. **Cost:** \$140. **Damage:** 1D6.

Grappling Hook & Line: This is your typical grappling hook and line for scaling surfaces. **Range:** 100 feet (30.5 m). **Damage:** 1D4. **Attacks Per Melee:** Equal to hand to hand attacks. **Weight:** 2 pounds (0.9 kg). **Cost:** \$150 for hook and 300 feet (91.4 m) of line.

Swords and other Melee Weapons: For illustrations and statistics for *hundreds* of swords, axes, polearms, and other ancient weapons from many different cultures and ages, check out Palladium's **Compendium of Weapons, Armour and Castles**. Trust us — you'll be glad you did.

Body Armor

Note: Ancient types of armor can be hand-made, but takes weeks to make. Prices listed are pre-Meltdown, but ancient types will range from 30% less to 30% more. Modern armor is scarce in most places coveted and typically 50-100% more expensive, but sometimes list price.

Ancient Armor Types

Cost, Style/Type, A.R., S.D.C., & Weight
\$175.00 — Padded or Quilt; A.R. 8, S.D.C. 15; 6.6 lbs (3 kg)
\$300.00 — Soft Leather; A.R. 9, S.D.C. 20; 8 lbs (3.6 kg)
\$600.00 — Studded leather; A.R. 12, S.D.C. 38; 20 lbs (9.1 kg)
\$900.00 — Chain Mail; A.R. 13, S.D.C. 44; 40 lbs (18.1 kg)
\$1500.00 — Scale Mail; A.R. 15, S.D.C. 75; 45 lbs/20.4 kg
\$2000.00 — Plate and Mail; A.R. 15, S.D.C. 100; 52 lbs (23.6 kg)
\$2800.00 — Plate; A.R. 16, S.D.C. 150; 58 lbs (26.3 kg)
\$3000.00 — Plastic Plated; A.R. 13, S.D.C. 80; 28 lbs (12.7 kg)

Note: The costs reflect the rarity of manufacturers/builders and the time involved in the construction. Homemade armor is possible, reduce cost by half, A.R. by 2 and S.D.C. by 20%.



Modern Light Armor (half suits)

Cost, Style/Type, A.R., S.D.C., & Weight
\$1200.00 — Concealed; A.R. 10, S.D.C. 50; 12 lbs (5.4 kg)
\$900.00 — Riot Jacket; A.R. 10, S.D.C. 60; 12 lbs (5.4 kg)
\$800.00 — Vest; A.R. 10, S.D.C. 50; 10 lbs (4.5 kg)
\$1100.00 — Point Blank Vest; A.R. 10, S.D.C. 70; 14 lbs (6.4 kg)
\$1400.00 — Hard Armor Vest; A.R. 12, S.D.C. 120; 15 lbs (6.8 kg)

Modern Heavy Armor (full suits)

Cost, Style/Type, A.R., S.D.C., & Weight
\$1400.00 — Frag. Cape/Vest; A.R. 13, S.D.C. 120; 16 lbs (7.3 kg)
\$1600.00 — Riot Armor; A.R. 14, S.D.C. 180; 17 lbs (7.7 kg)
\$2200.00 — Hard Armor; A.R. 16, S.D.C. 260; 20 lbs (9.1 kg)
\$2800.00 — Class 4 Armor; A.R. 17, S.D.C. 280; 20 lbs (9.1 kg)

Note: Half Suits or vest types usually protect the upper body front, back, side, waist and groin. Concealed are tough, thin styles designed to be sewn into clothes or hidden under clothes (shirts, jackets, etc.). The others are all generally bulky or worn atop clothes.

Full suits are all bulky suits worn on top of clothes and provide the greatest protection.

All modern armor is designed for flexibility and mobility and does not interfere with movement, prowl or speed. Many types of armor are constructed of reinforced plastic, strengthened with woven glass fibers, and are thicker than metal, yet lighter. Other common types use steel or lightweight alloys, typically 1/4 inch (6 mm) thick. These two types of armor can stop all pistol, revolver, sub-machinegun and low caliber rifle shells.

Hard armor is composed of ceramics, a form of opaque glass made from pure alumina or boron carbide. They are often combined with steel. Hard armor types provide the most effective protection and can even stop 7.62mm NATO and 5.56mm rifle bullets.

Gas Powered Generators & Electronics

Small Electric Generator: Uses 8 horsepower to generate 4 kilowatts of energy. **Weight:** 115 lbs. (52.2 kg). **Cost:** \$600.

Medium Electric Generator: Uses 15 hp to generate 8 KW. **Weight:** 230 lbs. (104.4 kg) **Cost:** \$1,200.

Heavy Electric Generator: Uses 25 hp to generate 15 KW. **Weight:** 460 lb. (208.8 kg) **Cost:** \$1,800.

Electricity requirements for common appliances: Electric Range: 12,000 watts (12 KW). **Cost:** \$400.00

Washing Machine: 500 watts (0.5 KW). **Cost:** \$350.00

Space Heater, Electric: 1,200 watts (1.2 KW). **Cost:** \$75.

Space Heater, Kerosine: Cost: \$50.

Toaster: (1,200 watts/1.2 kW), **Cost:** \$15.

Hot Water Heater: (250 watts/0.25 KW) per gallon (3.75 liters), for an average of 10,000 watts (10 KW). **Cost:** \$200.

Tape Recorder — 30-60 min. recording time; pocket size \$30.00

Personal Computer (Value Priced) \$700.00

Personal Computer (High End) \$4,000.00

Laptop Computer (Value Priced) \$1500.00

Laptop Computer (High End) \$6,500.00

Monitor — Basic Color \$200.00

Monitor — Large Console \$800.00

Monitor — Flat Screen \$2500.00

Basic Printer \$200.00

Laser Printer (good quality) \$500.00

Laser Printer (color) \$1000.00

Modem \$150.00

Note: As you can see, running a generator to live a pre-Meltdown lifestyle requires a lot of generating power, and enormous fuel stores. This is why so many post-Meltdown survivors simply go without most electric conveniences of yesteryear. As the old Survivor saying about electricity goes, "When in doubt, go without."

Field Equipment & Miscellaneous Gear

Basic Hardware Kit: Hammer, adjustable wrench, multi-bit hand drill/screwdriver, nails, screws, saw, tape measure. 10 lbs. (4.5 kg) **Cost:** \$100

Binoculars: 2,000 feet/610 m (best magnification), 1,600 ft./480 m (medium magnification), 1,200 ft./365m (low magnification) **Cost:** \$1,600 (best magnification), \$1,000 (medium magnification), \$600 (low magnification).

Camouflage Paint Kit: 4 spray cans plus 6 stencils allow for easy camouflaging of vehicles, bunkers, and any field equipment. One kit will cover approximately 100 square feet of surface. Available in jungle, forest or arctic. **Cost:** \$35.00

Camouflage Tape: The ever popular duct tape. Comes in rolls 26 feet (7.9 m) long and two inches (5 cm) wide. Available in jungle, forest or desert camouflage, or in olive drab. **Cost:** \$6.00 per roll.

Camouflage Compact: A one-man kit for camouflage or night operations. Includes enough face and hand paint for 6 applications. Mirror, brush and disposable cleaning pads are also included in a neat, black case, 4 inches in diameter and 1/2 inch high (10x1.3 cm). **Cost:** \$18.00 each.

Climbing Kit: A complete set of equipment for rappelling, rock scaling or climbing. Includes 3,600 foot (1100 m) reels of 4500 pound (20,000 Newton) test rope (each reel weighs 40 pounds/18 kg). An adjustable harness with clamps, 6 pairs of canvas climbing gloves. 48 clamps, 48 fasteners, 48 pitons, 3 hammers, 2 grappling hooks, and one pulley. Weight with shipping crate is 190 pounds (86 kg). **Cost:** \$1100.00

Ear Protector Headphones: The answer to the Demo expert's and grenadier's dreams. The same model is used by airport workers to preserve hearing in noisy environments. **Cost:** \$35-60.00

Flashlight — Small \$5.00

Flashlight — Medium \$10.00

Flashlight — Large \$15.00

Flashlight — Unbreakable (Kel-lite): Small \$24.00; Medium \$28.00; Large \$32.00; Very Large \$35.00.

Rechargeable, unbreakable flashlight that's 10 times brighter than most conventional types; quartz-halogen bulb, 12 inches (30 cm), 1.8 pounds (0.8 kg), 20,000 candle power. **Cost:** \$130.00, or 35,000 candle power — **Cost:** \$160.00.

Portable Halogen Spotlight: 50,000 candle power \$30.00

Treated Torch \$8.00

Candle Stick — Per Doz. \$8.00

Oil Lantern — 6 hours/1 pint \$20.00

Oil Lantern — 12 hours/2 pints \$30.00

Oil Lamp — 6 hours \$30.00

Padlock — Light — 25 S.D.C. \$5.00

Padlock — Medium — 50 S.D.C. \$8.00

Padlock — Heavy — 75 S.D.C. \$15.00

Padlock — Burglar proof, 60% to be picked — 80 S.D.C. \$30.00

Handcuffs — Regular — 60 S.D.C. \$25.00

Handcuffs — Heavy — 120 S.D.C. \$50.00

Medical Bag/Kit: This 8 pound (3.6 kg) bag is a complete Medic's field kit. Included are adhesive pads, bandages, gauze pads, adhesive tape, splints, sterile gloves, scissors, forceps, thermometer, needle, razor blades, pins, medicine, ointment, and salt tablets. Bag has backpack and shoulder straps, and is available in choice of camouflage, green or khaki. **Cost:** \$275.00.

Machete: Complete with canvas sheath. 1D6 damage. **Cost:** \$30.00.

Wire-cutters: 8 inch (20 cm) wire-cutter has nonconducting handles to avoid the nasty "shock" of electrified fences. Complete with belt sheath. **Cost:** \$65.00.

Rations: Dry field rations; each 15 pound (6.8 kg) case includes 12 meals. Crate is stocked with 12 cases, and has a total shipping weight of 200 pounds (91 kg). **Cost:** \$470.00.

Gas Mask will filter out CS, smoke and a variety of military gases. Note: Not recommended as protection against nerve gas or radiation. **Cost:** \$50.00.

Sunglasses — Light Adjusting \$25.00

Sunglasses — Aviator \$45.00

Shooting Glasses: Change color and density in response to changes in light and weather. Also reduces glare and improves visibility. **Cost:** \$72.00.

Protective Goggles \$10.00

Nylon Cord: A variety of heavy-duty, all-purpose, nylon rope or cord is available. Average tension strength is 600 pounds (2670 Newtons). Average length is 300 feet (91 m). **Cost:** about \$100. Good availability.

Hunting, Trapping, Hiking & Camping Gear

Back Pack — Large — \$210.00

Back Pack — Small — \$120.00

Bear Trap —\$180.00

Beaver Trap — \$60.00

Blanket — Heavy — \$20.00

Blanket — Light — \$10.00

Bow Hunter Accessory Bag — \$40.00

Canteen: Aluminum — \$30.00

Canteen: Plastic — \$20.00

Climbing Platform — Used by deer hunters to help climb and stand in trees. Gets them above the line of sight and reduces the chance of being scented. Portable; 100% high carbon steel.

Small — 16x19 in/41x48 cm platform — 200 lb/91 kg capacity — \$40.00

Medium — 17x24 in/43x61 cm platform — 250 lb/113 kg capacity — \$60.00

Heavy — 20x26 in/51x66 cm platform — 1000 lb/454 kg capacity — \$80.00

Compass — \$50.00
 Fishing Line — Per 50 feet/15 m — \$5.00
 Fishing Net — \$20.00
 Fishing Rod and Reel — \$50.00
 Flashlight — \$15.00
 Grappling Hook and Line — 250 feet/76 m — \$80.00
 Hammock — \$50.00
 Heavy Chain — Per foot/0.3 m — \$6.00
 Insect Repellent — \$4.00
 Knife: Large — \$20.00
 Knife: Small — \$10.00
 Knife: Survival — \$120.00
 Light Chain — Per foot/0.3 m — \$2.00
 Mosquito Netting — Per square yard/meter — \$12.00
 Pillow — \$10.00
 Rabbit Trap — \$40.00
 Rappelling Equipment — Including spikes, mallet, hooks, pulley, straps, harness, gloves, boots, black pack, etc. — \$1100.00
 Rope Ladder — Per 10 ft/3m — \$40.00
 Rope — Per 20 ft/6m — \$20.00
 Sleeping Bag — \$150.00
 Snare Cord — Per sq yard/meter — \$5.00
 Tackle Box — \$20.00
 Tent Canvas — Per square yard/meter — \$20.00
 Tent — Four Man — \$260.00
 Tent — One Man — \$110.00
 Tent — Military Command Post (25 pounds/11 kg, 8x8 foot floor, 5 foot ceiling/2.4x2.4x1.5 m; camouflage, green or khaki) — \$400
 Tent — Two Man — \$180.00
 Utensil Kit (knife, fork, spoon set with sheath) — \$25.00
 Wolf Trap — \$160.00

Containers

Back Pack — \$60.00
 Belt Purse (attaches to belt) — \$10.00
 Cask, Wooden — 10 gallons/38 l — \$40.00
 Cask, Wooden — 25 gallons/95 l — \$60.00
 Cask, Wooden — 4 gallons/15 l — \$30.00
 Cloth Handle Bag — \$10.00
 Crate, Large Wood — \$50.00
 Crate, Medium Wood — \$30.00
 Crate, Small Wood — \$20.00
 Jar — 1 gallon/3.8 l — \$10.00
 Jar — 2 pints/0.9 l — \$2.00
 Jar — 4 pints/1.9 l — \$4.00
 Jar, Glass — 1 pint/475 ml — \$4.00
 Jug — 1/2 gallon/1.9 l — \$20.00
 Jug — 1 gallon/3.8 l — \$35.00
 Jug — 5 gallons/19 l — \$60.00
 Knapsack — \$25.00
 Metal Security Box, Large — 15 lbs/6.8 kg — 90 S.D.C. — \$80.00
 Metal Security Box, Small — 5 lbs/2.3 kg — 30 S.D.C. — \$40.00
 Metal Trunk, Large — 80 lbs/36 kg — 200 S.D.C. — \$500.00
 Metal Trunk, Small — 35 lbs/16 kg — 100 S.D.C. — \$250.00
 Pocket Purse, Small — \$5.00
 Sack, Large — \$15.00
 Sack, Small — \$6.00
 Saddlebag (horse) — \$100.00
 Safe, Large — 300 lbs/136 kg — 1000 S.D.C. — \$2000.00
 Safe, Small — 50 lbs/23 kg — 350 S.D.C. — \$900.00
 Shoulder Purse — Large — \$35.00
 Shoulder Purse — Small — \$20.00
 Tobacco Pouch — \$20.00
 Trunk, Large Wood — 50 lbs/23 kg — 70 S.D.C. — \$200.00
 Trunk, Small Wood — 25 lbs/11 kg — 30 S.D.C. — \$80.00
 Vial, Glass — 2 ounce/60 ml — \$4.00

Waterskin — 1/2 gallon/1.9 l — \$30.00
 Waterskin — 1 gallon/3.8 l — \$50.00
 Waterskin — 2 pints/0.9 l — \$20.00

Conventional Vehicles

Exceptional quality horses and customized motor vehicles generally cost 200% to 400% their base price.

Horses

Motorized vehicles are largely the province of the Bugs. With electronic fuel injection systems, the Bugs are able to take over virtually any modern land vehicle. And, since the Bugs also control nearly all production and distribution of fuel, keeping a car or plane going will be rather difficult for most adventurers. Thus, many freedom fighters and survivalists have resorted to that age-old method of transport, the horse.

Contrary to what many gamers may think, a horse is *not* a lawn mower with legs. A horse can eat grass, weeds and other vegetation, but it takes a much longer time to digest and therefore, the horse can't function at full capacity. A horse on a varied diet of oats, grass and hay will move 10% slower. A horse on a steady diet of grass and/or hay will run a full 25% slower because such food just isn't as nutritional or filling. It would be like you or I living just on bread and water - it would keep us alive, but with very little energy. On the other hand, a diet of oats, barley and other grains, though more expensive, will help keep the animal healthy and operating at top efficiency. Grooming and proper watering are also important for the animal's well-being.

Average Horse

Size: 56-60 inches (1.4 to 1.5 m) at the shoulder. **Weight:** 1,100-1,400 lbs. (499-635 kg). H.P.: 4D6+6 S.D.C.: 5D6+12. **Attacks per Melee:** 2. **Damage:** 2D6 kick, 3D6 rear kick, 1D4 bite. **Bonuses:** +2 on initiative, +2 to strike, +4 to dodge. **Natural Abilities:** Swim 50%, Jump 4-5 feet (1.2-1.5 m) high and 10 feet (3 m) long. Can carry up to 500 lbs (225 kg) and can pull 800-1,200 lbs (360-540 kg). **Speed:** 35 mph (56 kph) for extended periods, 45 mph (72 kph) sprints. **Average Life Span:** 12 years. **Cost:** \$1,000-\$4,000.

Automobiles

Compact: A.R.: 5 S.D.C.: **300 Speed:** 110 mph (177 kph) **Range:** 350 miles (563 km) **Cost:** \$15,000+
Mid-Size Sedan: A.R.: 6 S.D.C.: **350 Speed:** 110 mph (177 kph) **Range:** 300 miles (483 km) **Cost:** \$23,000+
Full-Size Sedan: A.R.: 7 S.D.C.: **450 Speed:** 120 mph (193 kph) **Range:** 250 miles (402 km) **Cost:** \$32,000+
Luxury Sedan: A.R.: 7 S.D.C.: **450 Speed:** 120 mph (193 kph) **Range:** 250 miles (402 km) **Cost:** \$48,000+
Sports Car: A.R.: 5 S.D.C.: **350 Speed:** 120-180 mph (193-290 kph) **Range:** 200 miles (322 km) **Cost:** \$32,000+
Minivan: A.R.: 6 S.D.C.: **350 Speed:** 120 mph (193 kph) **Range:** 350 miles (563 km) **Cost:** \$16,000+
Full-sized Van: A.R.: 7 S.D.C.: **400 Speed:** 120 mph (193 kph) **Range:** 200 miles (322 km) **Cost:** \$24,000+
Jeep (4-Wheel Drive): A.R.: 6 S.D.C.: **300 Speed:** 120 mph (193 kph) **Range:** 400 miles (644 kph) **Cost:** \$26,000+
Sport Utility Vehicle (4-Wheel Drive): A.R.: 6 S.D.C.: **250 Speed:** 120 mph (193 kph) **Range:** 200 miles (322 km) **Cost:** \$23,000+
Small Truck: A.R.: 6 S.D.C.: **300 Speed:** 120 mph (193 kph) **Range:** 300 miles (483 km) **Cost:** \$18,000+
16 ft. Truck: A.R.: 7 S.D.C.: **400 Speed:** 120 mph (193 kph) **Range:** 200 miles (322 km) **Cost:** \$29,000+
24-ft. Truck: A.R.: 8 S.D.C.: **500 Speed:** 120 mph (193 kph) **Range:** 190 miles (306 km) **Cost:** \$60,000+
Semi-Truck (Cab Only): A.R.: 10 S.D.C.: **600 Speed:** 120 mph (193 kph) **Range:** 400 miles (640 km) **Cost:** \$90,000+ **Cargo Trailer:** \$90,000

Motorcycles

Light Motorcycle: A.R.: 5 S.D.C.: **50 Speed:** 90 mph (145 kph)

Range: 120 miles (193 km) **Cost:** \$500+

Medium Motorcycle: A.R.: 5 S.D.C.: **100 Speed:** 110 mph (177 kph)

Range: 350 miles (563 km) **Cost:** \$1,800-3,500

Heavy Motorcycle: A.R.: 5 S.D.C.: **150 Speed:** 120 mph (193 kph)

Range: 350 miles (563 km) **Cost:** \$8,500-35,000

Aircraft

Glider: A.R.: 5 S.D.C.: **100 Speed:** 100 mph (160 kph) **Range:** Effectively unlimited, as kph **Range:** 359 miles (578 km) A.R.: 10. Deflects any small arms fire under a light machinegun. **S.D.C. by Location:** Main Body: 450 long as there is a wind current to ride. **Cost:** \$5,000+

Autogyro/Ultralight: A.R.: 5 S.D.C.: **150 Speed:** 100 mph (160 kph) **Range:** 200 miles (320 km) **Cost:** \$7,500

Hot-Air Balloon: A.R.: 5 S.D.C.: 100 (gondola), 50 (balloon canvas) **Speed:** As fast as the wind moves. **Range:** Up to 1,000 miles (1,600 km), depending on size of fuel tanks. **Cost:** \$10,000.

Helicopter: A.R.: 7 S.D.C.: **350 Speed:** 300 mph (483 km) **Range:** 680 miles (1,094 km) **Cost:** \$320,000+ **Note:** The only ones people will sell or trade away will be older, beat-up models that need serious repair. To get a new chopper, one will have to steal it from a Bug-held helipad.

Single Engine Plane: A.R.: 6 S.D.C.: **400 Speed:** 300 mph (43 kph) **Range:** 680 miles (1,094 km) **Cost:** \$70,000+

Double-Engine Plane: A.R.: 7 S.D.C.: **550 Speed:** 420 mph (676 kph) **Range:** 600 miles (966 km) **Cost:** \$180,000+

Small Jet: A.R.: 9 S.D.C.: **850 Speed:** 600 mph (966 kph) **Range:** 1,370 miles (2,205 km) **Cost:** Nobody in their right mind will part with one of these. Better to try stealing one from a Bug-held airfield.

Large Passenger Airliner: A.R.: 10 S.D.C.: 2,000 **Speed:** 500 mph (800 kph) **Range:** 4,000 miles (6,400 km) **Cost:** Remember what we said for small jets? That goes double for large ones. Besides, if you get your hands on one of these, you're only going to cause trouble with it, and we all know it.

Armored Fighting Vehicles

LAV-25 Personnel Carrier: **Weight:** 12.05 tons (10.9 kt) **Length:** 21 ft. (6.4 m) **Crew:** 3 +6 troops **Max. Speed:** 62 mph (99.2 kph) **Max. Range:** 410 miles (656.1 km) A.R.: 14. Stops anything under .50 caliber bullets. The underside is vulnerable to mines. **S.D.C. by Location:** Main Body: 600, Treads: 75 each **Typical Armament:** 30mm Chain Gun, 7.62 Light Machinegun, Multi-Round Grenade Launcher (Smoke). **Cost:** \$900,000, but that's assuming they could be found for sale or barter. **Notes:** Any enemy fire that penetrates the A.R. has a 66% chance of inflicting *fill* damage on everybody riding inside.

M-48A3 **Patton II Tank:** **Weight:** 52.4 tons (47.6 kt) **Length:** 28 ft. (8.6 m) **Crew:** 4 **Max. Speed:** 30 mph (48.2 kph) **Max. Range:** 287 miles (459.2 km) **Armor:** A.R.: 16. Stops pistol, rifle, light machineguns and fragments. Vulnerable to mines, antitank rockets and heavy machineguns. **S.D.C. by Location:** Main Body: 1,000. Main Gun: 200 Treads: 200 each **Typical Armament:** 90mm gun (Damage: 1D4X100. Ammo: 50 rounds. Blast Radius: 20 ft. (5 m). Range: 4,000 ft./1,220 m), .50 Caliber Machinegun, .30 Caliber Machinegun. **Attacks Per Melee:** The main gun can fire four times per melee with one action needed to reload after each shot. **Cost:** Don't bother. Just go steal one ... if you can. **Notes:** The main U.S. battle tank of the Vietnam war. Obsolete by modern battlefield standards, but highly organized survivalist units (particularly in Appalachia) have stockpiled many of these.

M1A1 **Main Battle Tank:** **Weight:** 67.7 tons (62.5 kt) **Length:** 32 ft. (9.78 m) **Crew:** 4 **Max. Speed:** 30 mph (48.2 kph) on rough terrain, 42 mph (67.7 kph) on pavement. **Max. Range:** 289 miles

(462.4 km) **Armor:** A.R.: 18. Stops pistol, rifle, light machineguns and fragments. Vulnerable to mines, antitank rockets and heavy machineguns. **S.D.C. by Location:** Main Body: 1,500, Main Gun: 300, Treads: 300 each **Typical Armament:** 120mm gun (Damage: 2D4X100. Ammo: 50 rounds. Blast Radius: 20 ft. (5 m). Range: 4,000 ft./1,220 m), .50 Caliber Machinegun, .30 Caliber Machinegun **Attacks Per Melee:** The main gun can fire four times per melee with one action needed to reload after each shot. **Cost:** Yeah, right! Would *you* sell one of these babies? Didn't think so. **Notes:** This tank was state of the art armor for what used to be the U.S. Marine Corps and U.S. Army.

Helicopters

UH-1H Huey: **Length:** 57 ft (17 m), **Basic Weight:** 2.45 tons (2.22 kt), **Payload:** 3,116 lbs./1.56 tons (1,414 kg/1.41 kt), **Cruising Speed:** 127 mph (203 kph) **Range:** 314 miles (406 km) A.R.: 9 **S.D.C. by Location:** Main Body: 400, Tail: 200, Rotor: 150. **Optional Armaments:** Can accommodate up to two 2.75" Rocket Pods or two quad TOW launchers, a 40mm Mark-10 automatic Grenade Launcher, and 2 XM-214 Miniguns or 2 M-60 light machineguns. **Cost:** Beau coup dollars, baby. Beau coup.

AH-1G Huey Cobra: **Length:** 53 ft (16 m) **Basic Weight:** 4.2 tons (3.81 kt), **Payload:** 2,500 lbs./1.25 tons (1,135 kg/1.1 kt), **Cruising Speed:** 138 mph (225 kph), **Range:** 359 miles (574 km), A.R.: 10. Deflects any small arms fire under a light machinegun. **S.D.C. by Location:** Main Body: 450, Tail: 300, Rotor: 250, Passenger Armor: A.R.: 15, S.D.C.: 350. Even if a Cobra is shot down, the passenger compartment is likely to remain intact. **Bonuses:** +2 to strike. **Armaments:** Up to four 2.75" Rocket Pods or quad TOW launchers, two XM-214 Miniguns and one 40mm Mark-19 automatic grenade launcher. **Cost:** You couldn't possibly afford it.

A Final Word

The original concept behind **Systems Failure™** was a tongue in cheek, zany game full of satire and humor inspired by a silly conversation with Steve Sheiring, Maryann, Rick Burke and I. While there is the touch of satire and humorous line or element here and there, the game turned into something very different. Something better.

I think **Systems Failure™** captures the elements of horror, suspense, science fiction, post-apocalyptic sentiment, and social satire wrapped in patriotism and high energy. It is a masterful blend of cliché, broad stereotypes and high concept interwoven with some nice original touches that do indeed make it new and exciting. It doesn't take itself too seriously, but at the same time it is a serious game.

Personally, I think it's incredibly fun to play and offers a lot of surprising depth and challenges. I am proud to have been the catalyst for it, having provided the initial concepts, some guidance and the finishing touches, but it was Bill Coffin who brought it all to life.

I knew we had a great game when after just reading the prologue, ending with Jimmy Gillis' diary, I couldn't wait to roll up a character and go squash me some Bugs! I hope you had the same reaction and enjoy hours of adventure.

— Kevin Siembieda, 1999

Y2K Bug — Don't get bit

RIFTS

There is so much to tell about **Rifts**® that we don't know where to begin.

Earth has been torn apart and reshaped. It is as alien as some distant planet, yet strangely familiar. Humankind has risen from the ashes of Armageddon to reclaim their planet, only this time there are other creatures who claim it as well.

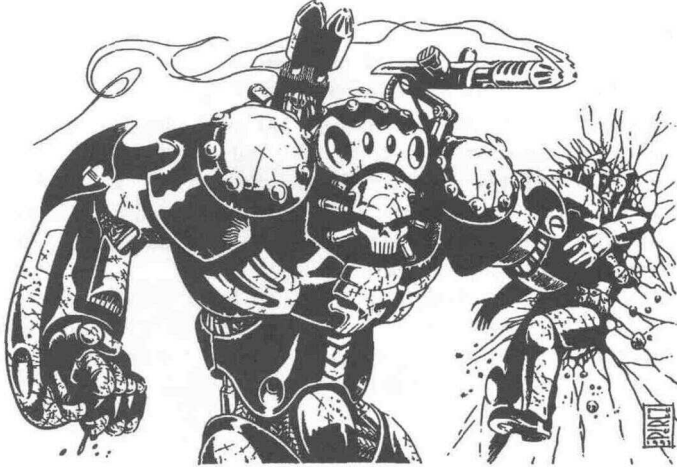

Rifts® is science fiction

It is high-tech science fiction with Mega-Damage rules, cybernetics, bionics, robotics, energy weapons, rail guns, power armor, giant robot vehicles, and fantastic cities. Cities where character classes like the *City Rat*, *Cyber-Doc*, *Operators*, *Body Fixers*, and other rogues call home. Cities controlled by the empire known as the Coalition States; a nazi-like government who controls the minds and hearts of its people and where books are forbidden. Places where men of magic, psychics, and scholars are hunted by the *Coalition Dog Packs* and *Psi-Stalkers*.

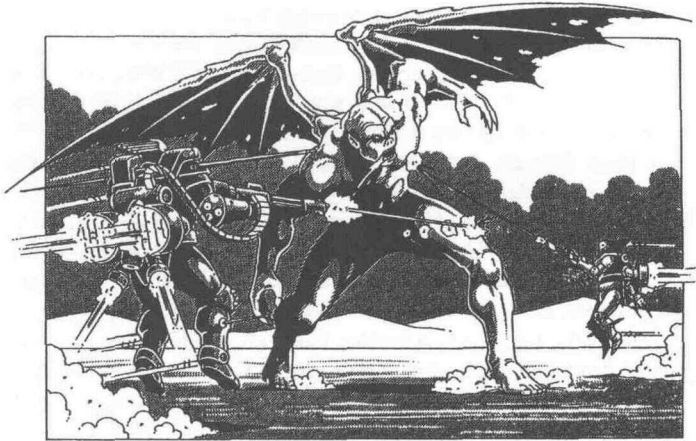

Rifts® is fantasy

The "science of magic" is as developed and powerful as robotics. Ley lines and their mystic energies are tapped to open doorways to other worlds and used to create technological marvels like TK-Guns (fire telekinetic bolts instead of bullets) and Wing Boards (surfboard like platforms that sail along ley lines). A world where creatures of legend walk among men. A world where character classes like the *Line Walker*, *Techno-Wizard*, *Shifter*, and *Mystic* are just beginning to master the power that ancient man called magic.

Copyright 1998 Palladium Books Inc.
Palladium Books®, Rifts®, Megaverse®, The Mechanoids® are registered trademarks owned by Palladium Books Inc. Other titles and names are also trademarks of Palladium Books Inc. Robotech® is a registered trademark of Harmony Gold USA, Inc.

Rifts® is horror

Where ley lines meet, they are called junctions or "nexus" points. These are the places where portals or "Rifts" tear open the fabric of space and time. Sometimes the Rifts can be controlled, but all too often they tear open like an erupting volcano of mystic and psychic energy. From the eruption, hordes of creatures emerge. Some are monstrous flesh and blood creatures, others are alien intelligences, but the worst are supernatural beings that even future man calls *demons*.

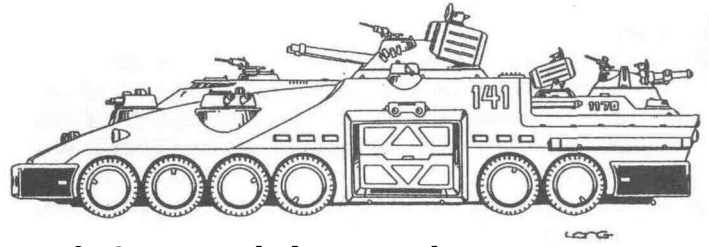

Rifts® is post-holocaust adventure

The world is a vast wilderness, a new frontier with many wonders waiting to be explored, and just as many horrors barring the path. Player characters are the brave, idealistic, adventurous explorers of this new world. The men and women who dare to carve their place in a world gone mad. Occupational Character Classes include the *Cyber-Knight*, *Bursters*, *Juicers*, *Borgs*, *Crazies*, *MindMelters*, *Coalition Elite*, and many, many others.

Rifts® is great artwork

The cover by *Keith Parkinson* is only a hint at what awaits you inside. Incredible new robots, bionics, weapons, vehicles, characters and more are breathtakingly illustrated by *Kevin Long* and others. Plus a 12 page center spread of paintings by Long and Parkinson that brings the world of **Rifts**® to life. Written by *Kevin Siembieda*. \$24.95 plus \$3.00 postage and handling. 256 pages — Complete role-playing game.



Rifts®, your source to the Megaverse®

The original game took three years to design, write and illustrate. It has been a smash hit since the day of its release.

The sourcebooks that have followed continue the tradition of great art, dynamic characters, strong story, and high-concept. But we go beyond the boundaries of Earth. Dimension Books carry the reader to alien galaxies and strange, new worlds. Better yet, **Rifts**® is compatible with Palladium's entire Megaverse® of games, from *Heroes Unlimited*™ and *Robotech*® to *Palladium Fantasy*® and *Nightbane*®. Available at stores everywhere.

Visit Palladium's Web Site to see our complete catalog, the latest news, talk to fans in our chat rooms, access special sourcebooks and data, and join in all the fun and excitement! Moderated by V.P. Maryann Siembieda.
www.palladiumbooks.com

Palladium Books Inc.
Dept. D

12455 Universal Drive
Taylor, MI 48180

Your doorway to the Megaverse®

Other Palladium Games

Heroes Unlimited™ RPG

- Over 100 super abilities.
- Mutants & Aliens.
- Vigilantes & Super-Soldiers.
- Mega-Heroes & Superhumans.
- Robot & Cyborg creation rules.
- An much more.
- Written by Kevin Siembieda.

Rifts® RPG

- Earth is transformed.
- Magic and science collide.
- Portals to countless worlds.
- Characters of incredible power.
- An infinite Megaverse® of adventure.
- Limited only by your imagination™.
- Written by Kevin Siembieda.

Ninjas & Superspies™ RPG

- 41 different martial arts.
- Dozens of mystic powers.
- Superspies and secret organizations.
- Gimmicks, cyborg agents and more.
- Written by Erick Wujcik.

Palladium Fantasy RPG®

- Hundreds of magic spells, plus circles and wards.
- Heroic warriors, knights and paladins.
- Human and nonhuman player characters.
- Subhuman monsters, demons and sorcery.
- Epic adventure in a unique world of fantasy.
- Written by Kevin Siembieda.

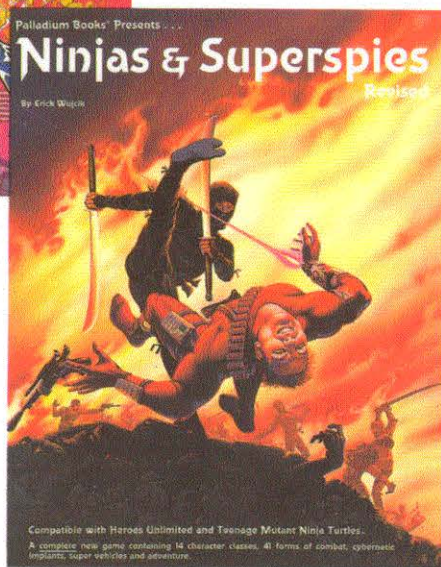
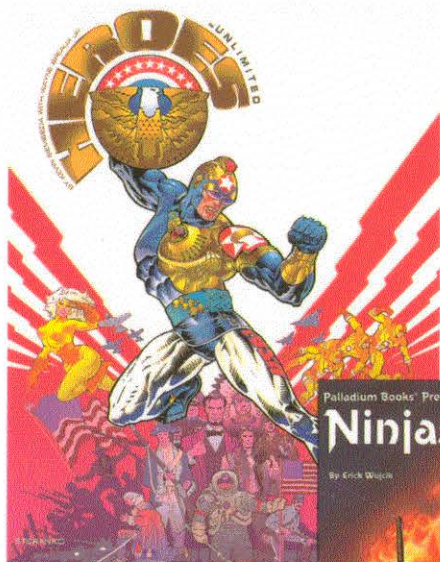

Systems Failure™ RPG

A Role-Playing Game of survival and heroics

Systems Failure™ is non-stop, blood and guts action! A story of loss, rebirth, and courage. Of self-sacrifice, patriotism and heroics.

Characters are off-color, off-kilter and sometimes just plain crazy, but they are all heroes willing to take a stand.

American civilization (and the world) has collapsed and is dominated by an inhuman foe from another world. It's time she was free again. A truly different and tantalizing spin on the Post Apocalyptic story setting, done with Palladium's no-holds-barred, anything goes approach to things.

- A complete role-playing game with everything you need to play (other than people and dice) in one book.
- 11 O.C.C.s including the Exterminator, Freebooter, Sawbones, Grease Monkey, NORAD Psychic, NORAD Splicer, and Wacko.
- Creation rules and colorful background material to make each character unique.
- The monstrous enemy are bug-like alien invaders with the power to infiltrate and seize control of every electronic device on the planet.
- Plenty of maps, world information and adventure ideas.
- Written by Bill Coffin with Kevin Siembieda.
- 144 pages.

\$12.95

Cat. No. 650

I.S.B.N. 1-54757-038-2

ISBN 1-57457-038-2



9 781574 570380