

Palladium Books® Presents:

# South America™

Rifts® World Book Six

By C.J. Carella



---

# Warning!

## Violence and the Supernatural

**This book may be inappropriate for young readers.**

**The fictional World of Rifts** is violent, deadly and filled with supernatural monsters. Other-dimensional beings, often referred to as "demons," torment, stalk and prey on humans. Other alien life forms, monsters, gods and demigods, as well as magic, insanity, and war are all elements in this book.

Some parents may find the violence and supernatural elements of the game inappropriate for young readers/players. We suggest parental discretion.

Please note that none of us at Palladium Books condone nor encourage the occult, the practice of magic, the use of drugs, or violence.

---

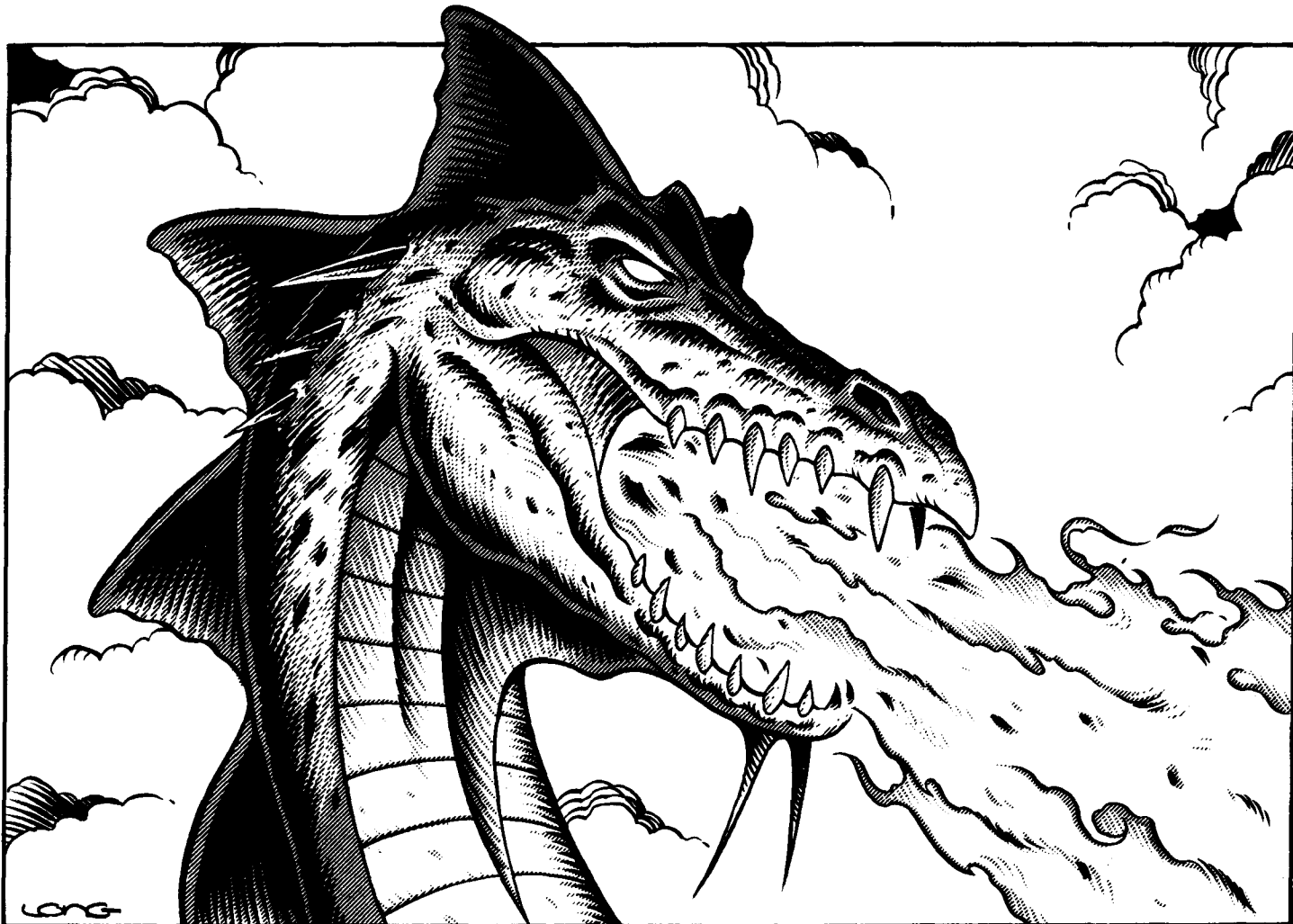

**A supplement for the Rifts RPG.  
Compatible with the entire Palladium Books Mega verse!**

**Special Thanks to the Electronic Super-Highway Road Warriors:** Cole Cash, Jeremy Frost, Stephen Grooms, Matthew Jinkerson, Shawn Krabill, Brian Lamar, Tanya Malone-Hartmann-Falgren, Xavier March, Eric Nielsen, Roger Nielsen, Edward Palmer and Joshua Rosenberg. They were the first to follow Cudbury into the unknown reaches of the Amazon river. Congratulations to them all!

*Carlos J. Martijena-Carella*

**Other titles in the **Rifts**® series include:**

**Rifts**® Sourcebook One  
**Rifts**® Sourcebook Two: **Mechanoids**®  
**Rifts**® Sourcebook Three: **Mindwerks**™  
**Rifts**® Conversion Book One  
Rifts\* Conversion Book Two: **Pantheons** of the Megaverse\*  
**Rifts**® World Book One: Vampire Kingdoms  
**Rifts**® World Book Two: Atlantis  
**Rifts**® World Book Three: England  
**Rifts**® World Book Four Africa  
**Rifts**® World Book Five: Triax™ and the NGR  
**Rifts**® World Book Seven: **Rifts**® Undersea  
**Rifts**®: Mercenaries™  
Rifts\* Dimension Book One: Wormwood™  
**Rifts**® Dimension Book Two: Phase World™  
Rifts\* Dimension Book Three: Phase World Sourcebook™

**Other Palladium RPG titles include:**

The Compendium of **Weapons, Armor,** and Castles™  
The Compendium of Contemporary Weapons™  
The **Palladium**® RPG  
Revised Heroes Unlimited™  
Villains Unlimited™  
Teenage Mutant **Ninja** Turtles\* and Other Strangeness  
After the **Bomb**®  
**Nightspawn**™  
**Ninjas** and **Superspies**™  
**Robotech**® RPG  
**Macross II**™ RPG  
Beyond the Supernatural™

**Third Printing — October, 1998**

Copyright © 1994 Palladium Books Inc.

Copyright © 1994 by Kevin Siembieda

All rights reserved under the Universal Copyright Convention. No part of this book may be reproduced in part or whole, in any form or by any means, without permission from the publisher, except for brief quotes for use in reviews. All incidents, situations, institutions, governments and people are fictional and any similarity, without satiric intent, of characters or persons living or dead, is strictly coincidental.

Rifts, Palladium Books, The Mechanoids, and Megaverse are registered trademarks owned and licensed by Kevin Siembieda and Palladium Books Inc. The Anti-monster, **Splugorth**, Triax, Mindwerks, **Naruni** Enterprises, Glitter Boy, **Psi-Stalker**, **Simvan**, Skelebots, the Coalition States, Erin Tam and other names and titles are trademarks owned by Kevin Siembieda and Palladium Books Inc.

Rifts® World Book Six: South America is published by Palladium Books Inc., 12455 Universal **Drive**, Taylor, MI 48180. Printed in the USA.

Palladium Books™ Presents:

# South America™

## Rifts™ World Book Six

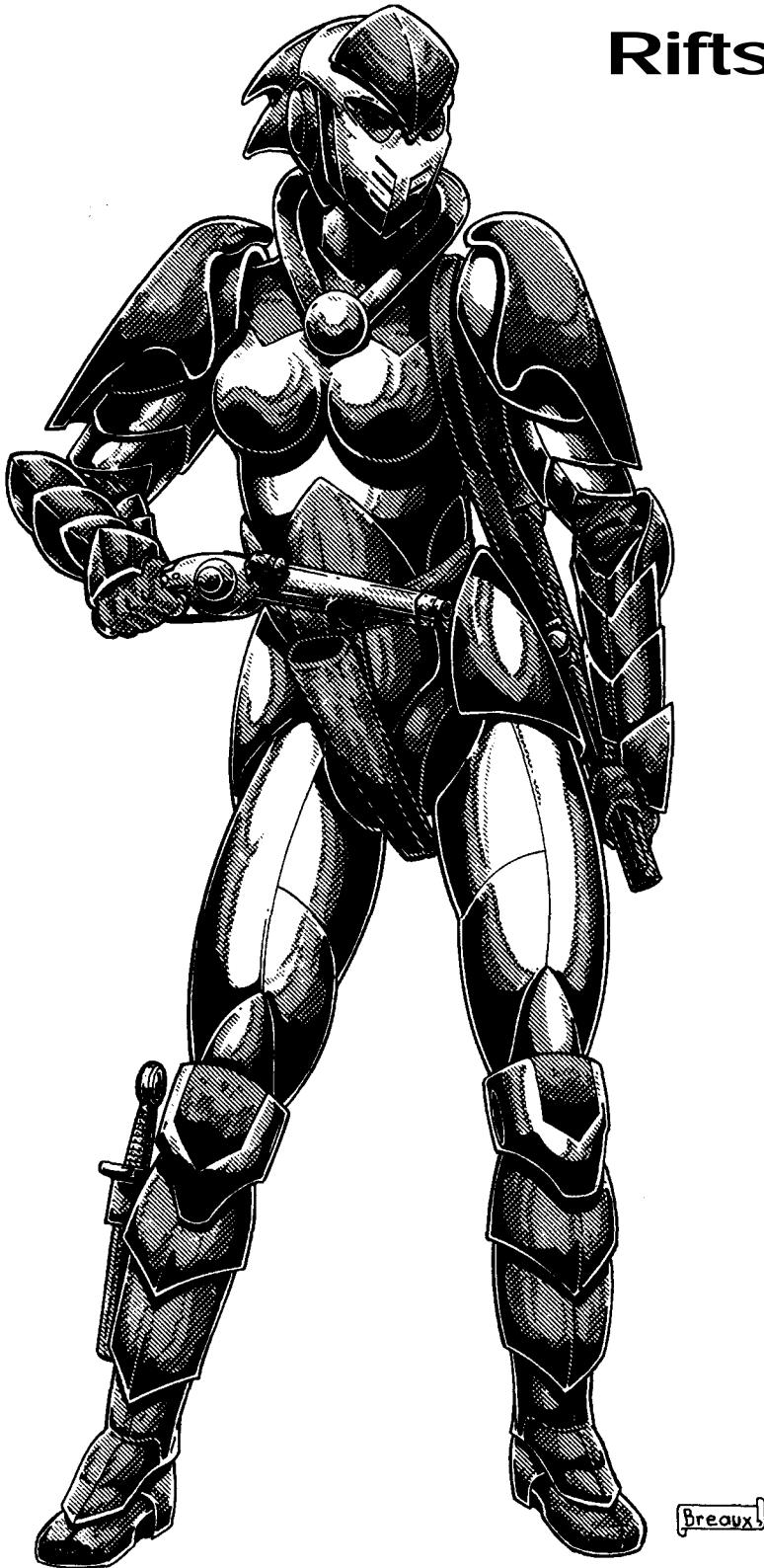

Written By: **Carlos J. Martijena-Carella**

Additional Text & Concepts: **Kevin Siembieda**

Senior Editor: **Kevin Siembieda**

Editors: **Alex Marciniszyn**

**James A. Osten**

**Thomas Bartold**

**Julius Rosenstein**

**Kevin Kirsten**

Cover Painting: **Brom**

Interior Artists:

**Kevin Long**

**Wayne Breaux**

**Vince Martin**

**Roger Petersen**

**Kevin Siembieda**

**Earl Geier**

**Brom**

Art Direction & Keylining: **Kevin Siembieda**

Typography: **Maryann Siembieda**

**Special Thanks** to C.J. Carella for another outstanding addition to the Rifts World. To Brom for a powerful cover painting and giving me an opportunity to ink his pencils. And to Maryann, Wayne, Rog, Vince, Kev, Jim, Thorn, Alex and the usual gang of Palladium wizards for another exciting Rifts world book. I'd also like to welcome Mike O'Connor and Kevin Kirsten to the Palladium staff.

## Table of Contents

Introduction . . . . .	7	The Pirate Kingdoms . . . . .	43
An Overview of South America . . . . .	8	<b>Kryang's Land</b> . . . . .	43
The Travelogue of Professor <b>Augusto Cudbury</b> of <b>Lazlo</b> . . . . .	8	King <b>Kryang</b> . . . . .	44
The First Transcript - November, 102 P.A. . . . .	8	A Typical Kryang Pirate . . . . .	45
Monsters from Atlantis . . . . .	8	<b>Slavers' Port</b> . . . . .	45
The Second Transcript - <b>March</b> , 103 P.A. . . . .	9	Other Pirates . . . . .	46
First Contact . . . . .	9	New <b>O.C.C.s</b> . . . . .	46
The Anti-Monsters . . . . .	10	Sailor O.C.C. . . . .	46
El <b>Dorado</b> - Myth or Reality? . . . . .	10	Pirate O.C.C. . . . .	47
The Pirate Kingdoms . . . . .	11	Other O.C.C.s . . . . .	48
The <b>Bahia</b> Kingdom and the Land of the Lizard Men . . . . .	11	The Land of a Thousand Islands . . . . .	49
The Third Transcript - May, 103 P.A. . . . .	12	The Kingdom of Bahia . . . . .	49
The Fourth Transcript - July, 103 P.A. . . . .	13	Rift Activity . . . . .	50
More of El Dorado . . . . .	13	Foreign Relations . . . . .	50
The Fifth Transcript - <b>August</b> , 103 P.A. . . . .	13	The Bahia Militia . . . . .	51
The Amazons and El Dorado! . . . . .	13	Voodoo Priest O.C.C. . . . .	51
The Sixth Transcript - September, 103 P.A. . . . .	14	<b>Loas</b> - Spirit Entities . . . . .	53
Rifts South America . . . . .	15	Maga Island . . . . .	54
The Amazon River . . . . .	15	Foreign Relations . . . . .	56
Weather . . . . .	15	Jungle Elf R.C.C. . . . .	57
Flora and Fauna . . . . .	15	<b>Biomancy</b> Trees & Items . . . . .	58
Languages . . . . .	15	Trees of Wisdom . . . . .	58
The Republic of Colombia . . . . .	16	Memory Trees . . . . .	59
The Vampire Wars . . . . .	16	The <b>Biomancer</b> O.C.C. . . . .	61
Rift Activity . . . . .	18	Biomancy . . . . .	64
Foreign Relations . . . . .	18	The Power of Life . . . . .	64
La <b>Fortaleza</b> - Colombia . . . . .	19	Biomancer Spell Descriptions . . . . .	64
La <b>Fortaleza's</b> Police and Military Forces . . . . .	20	Level One . . . . .	64
The Security Division . . . . .	21	Commune with Nature . . . . .	64
Colombian 1st Army Corps . . . . .	21	Shape <b>Plants</b> . . . . .	64
Other Places of Note . . . . .	21	Weather Sense . . . . .	64
<b>Camargo</b> . . . . .	21	Level Two . . . . .	64
Ciudad Bolivar . . . . .	22	Animate Plant: Minor . . . . .	64
<b>Bonito</b> - Frontier <b>City/Port</b> . . . . .	22	Animal Weaponry: Simple . . . . .	65
Weapons & Armor of the Republic of Colombia . . . . .	22	Insect Leap . . . . .	65
<b>RC-10</b> Laser Pistol . . . . .	22	Plant Virtual Sight . . . . .	65
<b>RC-15</b> Laser Rifle . . . . .	23	Weave Plants . . . . .	65
Dragon-1 Plasma Projector . . . . .	23	Level Three . . . . .	65
RP-C20 Rocket Pistol . . . . .	23	Accelerate Plant Growth . . . . .	65
RR-C40 Rocket Rifle . . . . .	24	<b>Chitin</b> . . . . .	65
RAR-C15 Rocket <b>Auto-cannon</b> Rifle . . . . .	24	Shrink Plant . . . . .	66
RA-C15 Rocket <b>Auto-cannon</b> . . . . .	24	Level Four . . . . .	66
Colombian Robots & Power Armor . . . . .	25	Animal Weaponry: Major . . . . .	66
D-20 Light Combat <b>Exo-Skeleton</b> . . . . .	25	Forest Camouflage . . . . .	66
D-30 " <b>Conquistador</b> " Power Armor . . . . .	27	Strengthen Plant . . . . .	66
G-9A " <b>Jaguar</b> " Light Robot Vehicle . . . . .	29	Level Five . . . . .	67
G-18B " <b>Aguirre</b> " Heavy Combat Robot . . . . .	31	Animal Ghost . . . . .	67
<b>Lancero</b> Light <b>Tank/APC</b> . . . . .	31	Metamorphosis: Plant . . . . .	67
<b>Zancudo</b> Transport & Attack Helicopter . . . . .	33	Level Six . . . . .	67
The Anti-Monster O.C.C. . . . .	34	Bio-Blast . . . . .	67
The Vampire Kingdom of <b>Haktla</b> (The Colombian Andes) . . . . .	37	Tree <b>Teleport</b> . . . . .	67
The Pyramid City . . . . .	38	Level Seven . . . . .	67
The Plaza of Punishment . . . . .	38	Tree Warrior . . . . .	67
<b>Enumu</b> , Lord of Drought . . . . .	39	Undo <b>Undead</b> . . . . .	68
<b>Hak-Talon</b> , Master Vampire . . . . .	40	Level Eight . . . . .	68
Giant Vampire Bats - A D-Bee Monster . . . . .	41	Suspended Animation . . . . .	68
		Touch of Life . . . . .	68

Level Nine	68	Hunter Cat R.C.C.	113
Heal the Earth	68	Oracle Cat R.C.C.	114
Level Ten	68	The <b>Sekhmet</b> R.C.C.	116
Woodland Entity	68	<b>Werejaguar</b> & <b>Werepanther</b> R.C.C.	117
Available Common Spell Magic	68	The Divine Felines - A Triumvirate of Gods	118
Bio-Weapons	69	Bast - Egyptian Cat Goddess	119
Lesser <b>Bio-Weapons</b> & Armor	69	<b>Yaguar-Ogui</b> the Jaguar - South American Feline God	120
Enchanted Spears, Swords & Clubs (80 P.P.E.)	69	<b>Simba</b> - African Lion God	121
Light Wood Armor (150 P.P.E.)	69	<b>Cibola</b> , the Gilded City	123
Light <b>Chitin</b> Armor (200 P.P.E.)	69	Foreign Relations	125
Greater <b>Bio-Weapons</b> & Armor	70	Cibola City Highlights	125
Bio-Energy Bow (200 P.P.E.)	70	<b>Cibolan</b> Armed Forces	126
Bone Blade (500 P.P.E.)	70	Key Forces & Characters	127
Insect Pincers (500 P.P.E.)	70	<b>Inix</b> - Alien Intelligence	127
Wood Armor: Superior (650 P.P.E.)	70	Soul Worms	128
Chitin Armor: Superior (900 P.P.E.)	70	<b>Malkhom</b> - Cibola's Head of <b>Security</b>	129
The Kingdom of <b>Lagarto</b>	71	<b>Iridna</b> - <b>Inix's</b> War Chief	130
Foreign Relations	74	Rendell - The Slave Master	131
Armed Forces	74	Kastor - Leader of the Gatherers	132
New <b>Dragcona</b>	75	The Gatherers R.C.C. - Minions of Inix	134
First City	75	<b>Pogtalian</b> Dragon Slayers R.C.C.	135
<b>Melastirth</b> - Dragon Overlord of Lagarto	75	The <b>Pincer</b> Warriors R.C.C. - Supernatural Minions	136
<b>Stleet</b> - High King of Lagarto	77	<b>Grimbor</b> Ape-Men - Optional Player R.C.C.	138
Lizard Men R.C.C.	79	Cibolan Weapons & Equipment	139
Weapons and Armor of Lagarto	79	<b>NE-4P</b> Plasma Cartridge Pistol	139
The " <b>Carnosaurus</b> " <b>Kittani</b> Series	79	<b>NE-10</b> Plasma Cartridge Rifle	139
<b>Kittani</b> Raptor Power <b>Armor/Robot</b>	79	<b>NE-200</b> Plasma Cartridge <b>Machinegun</b>	139
Kittani <b>Allosaurus</b> " <b>Firedrake</b> " Power Armor	82	Dragon Death Power Armor	141
Kittani <b>Tyrannosaurus</b> Robot Vehicle	83	Cibolan Flying Platform	141
El Dorado - The Cities of Gold	86	Cibola's Drugs & Potions	143
<b>Manoa</b>	86	Magical Potions and Pills	143
Clan <b>Skellian</b>	88	Dream	143
Foreign Relations	90	The <b>Energizer</b>	143
Armed Forces	90	The Transformer	143
Weapons of Manoa	91	Enhancer	144
Enchanted Armor	91	Lightning Nectar	144
<b>Manoan</b> " <b>Flamer</b> " Pistol	91	The Rain Forest	145
<b>Manoan</b> SK Stun Gun	91	Tribal Shaman O.C.C.	145
<b>Manoan</b> "Fireball" Rifle	92	Totem Warrior O.C.C.	146
<b>Manoan</b> Stun Pistol	92	Monsters of the Amazon	148
<b>Hoplite</b> Power Armor	92	The <b>Ellal</b> - South American <b>Undead</b>	148
Lictor Assault Robot	95	<b>Trelque-huecuve</b> - Monster Squid	149
Amazon R.C.C.	97	Huecu - Demonic <b>Manta</b> Ray	150
<b>Atlantean</b> Monster Hunter O.C.C.	99	The <b>Aunyain</b> - Tusked Magicians	152
True <b>Atlanteans</b>	100	Ships of South America	152
Tattoos of Monster-Shaping	101	<b>Splugorth</b> Slaver Raider	152
<b>Shapeshifting</b> Powers	101	<b>Splugorth</b> Slaver <b>Mothership</b>	154
<b>Ewaipanomas</b> R.C.C. - Headless Men of the Amazon	102	Corsair <b>Hydrobike</b>	156
<b>Shaydor Spherians</b> R.C.C.	103	Piranha Submersible Attack Boat	157
<b>Omagua</b> - City of Jaguars	104	"Black Galleon" Gunboat	158
The Divine Felines	106	The Black Ship - Scenario Outline	159
Foreign Relations	106	Nightmare Island	160
City Highlights	107	<b>Kharkon</b> the <b>Undaunted</b> , A Transformed Shifter	160
Mutant Cat R.C.C.	107	<b>Dalgon</b> the Undying - A <b>Syvan</b> Pirate	162
<b>Felinoid</b> R.C.C. - Jaguar Mutants	107	Archill the Necromancer	163
Flying Tiger R.C.C.	109	The Black Ships - Demonic Vessels	165
Flame Panther R.C.C.	111	Experience Tables	168

## Quick Find Table

### O.C.C.S and RC.Cs

Amazon R.C.C. . . . .	97
Anti-Monster O.C.C. . . . .	34
Atlantean Monster Hunter O.C.C. . . . .	99
<b>Biomancer</b> O.C.C. . . . .	61
Cibola Gatherer R.C.C. (optional) . . . . .	134
Cibola <b>Pincer</b> Warrior R.C.C. (optional) . . . . .	136
<b>Ewaipanomas</b> R.C.C. (optional) . . . . .	102
<b>Felinoid</b> Optional R.C.C.S (start) . . . . .	107
<b>Felinoid: Flame Panther</b> R.C.C. . . . .	111
Felinoid: <b>Flying</b> Tiger R.C.C. . . . .	109
Felinoid: Hunter Cat R.C.C. . . . .	113
Felinoid: Oracle Cat R.C.C. . . . .	114
Felinoid: <b>Sekhmet</b> R.C.C. . . . .	116
Felinoid: <b>Werejaguar/Panther</b> R.C.C. . . . .	117
<b>Grimbor</b> Ape-Men R.C.C. . . . .	138
Jungle Elf R.C.C. . . . .	57
Lizard Men R.C.C. (optional) . . . . .	79
Other O.C.C.S . . . . .	48
Pirate O.C.C. . . . .	47
<b>Pogtalian</b> Dragon Slayer R.C.C. . . . .	135
Sailor O.C.C. . . . .	46
<b>Shaydor Spherian</b> R.C.C. . . . .	103
Totem Warrior O.C.C. . . . .	146
Tribal Shaman O.C.C. . . . .	145
Voodoo Priest O.C.C. . . . .	51

### Civilizations in South America

<b>Bahia</b> . . . . .	49
<b>Loas</b> - Spirit Entities . . . . .	53
Voodoo Priest O.C.C. . . . .	51

Cibola . . . . .	123
Advisor <b>Iridna</b> . . . . .	130
Advisor <b>Kastor</b> . . . . .	132
Advisor <b>Malkhom</b> . . . . .	129
Advisor <b>Rendell</b> . . . . .	131
City Highlights . . . . .	125
Drugs & Potions . . . . .	143
Gatherers (optional R.C.C.) . . . . .	134
Grimbor (optional R.C.C.) . . . . .	138
<b>Inix</b> , Ruler of Cibola . . . . .	127
Pincer Warriors (optional R.C.C.) . . . . .	136
Pogtalian Dragon Slayer R.C.C. . . . .	135
Soul Worms . . . . .	128
Weapons & Equipment . . . . .	139

<b>Columbia, Republic of</b> . . . . .	16
Anti-Monster O.C.C. . . . .	34
<b>Bonito</b> . . . . .	22
<b>Camargo</b> . . . . .	21
Ciudad Bolivar . . . . .	22
La <b>Fotaleza</b> . . . . .	19
Weapons and Armor . . . . .	22

<b>El Dorado</b> . . . . .	86
Cibola . . . . .	104
<b>Manoa</b> . . . . .	86
<b>Omagua</b> . . . . .	123
The Legend . . . . .	86

<b>Lagarto</b> . . . . .	71
First City . . . . .	75
<b>Lizard</b> Men R.C.C. . . . .	79
<b>Melastirth</b> - Dragon Overlord of Lagarto . . . . .	75
New <b>Dragcona</b> . . . . .	75
<b>Stleet</b> - High King of Lagarto . . . . .	77
Weapons and Armor of Lagarto . . . . .	79

<b>Maga</b> . . . . .	54
Bio-Weapons . . . . .	69
Biomancer O.C.C. . . . .	61
<b>Biomancy</b> . . . . .	64
Green World - History . . . . .	55
Jungle Elf R.C.C. . . . .	57
Trees, Memory . . . . .	59
Trees of Wisdom . . . . .	58

Manoa . . . . .	86
Amazon R.C.C. . . . .	97
Atlantean Monster Hunter O.C.C. . . . .	99
Clan <b>Skellian</b> . . . . .	88
Shaydor <b>Spherians</b> R.C.C. . . . .	103
The Ewaipanomas R.C.C. - Headless Men of the Amazon	102
Weapons & Armor . . . . .	91

<b>Omagua, City of Jaguars</b> . . . . .	104
City Highlights . . . . .	107
Divine Felines . . . . .	118
<b>Felinoids</b> R.C.C. . . . .	107
Flame Panther R.C.C. . . . .	111
Flying Tiger R.C.C. . . . .	109
Hunter Cat R.C.C. . . . .	113
Oracle Cat R.C.C. . . . .	114
Sekhmet R.C.C. . . . .	116
<b>Werejaguar &amp; Werepanther</b> R.C.C. . . . .	117

<b>Pirate Kingdoms</b> . . . . .	43
<b>Kryang's</b> Land . . . . .	43
Other O.C.C.s . . . . .	48
Other Pirates . . . . .	46
Pirate O.C.C. . . . .	47
Sailor O.C.C. . . . .	46
<b>Slavers' Port</b> . . . . .	45

<b>Other Highlights</b>	
Monsters of the Amazon . . . . .	148
Rifts South America . . . . .	15
Ships of South America . . . . .	152
South America: An Overview . . . . .	8
The Rain Forest . . . . .	145



## Introduction

Some of the first words of advice beginning writers get is to "write what you know." Not exactly what somebody who is interested primarily in science fiction and fantasy wants to hear — in fact, it's crappy advice for any writer. You write what feels good to write. You don't have to rely on your life experiences if you've got imagination. If you're good enough to make your imaginings convincing, you'll be successful, sometimes more successful than people who have really had colorful and dramatic lives but who lack the **storytelling** ability to make those experiences feel real to the reader.

Sometimes, though, you can draw on what you know — to some degree. I spent my childhood in South America; Peru and Venezuela specifically. After studying the history and legends of the continent, I'd always hoped to do some writing dealing with that part of the world. South America is a fascinating continent, a place where the huge, mysterious Amazonian jungle coexisted with the advanced civilization of the **Incas**. A part of the world that has more than its share of myths and adventuring potential. From legendary lost cities in the jungle to countless legends of gods, heroes and monsters to real-life exotic locales like the immensely varied Amazonian rain forest, South America has always offered a great setting for adventure movies and books.

The South America you will find described in these pages is not the continent I've known, however. It's the continent I've

seen in my imagination. Besides drawing on well known South American legends like El Dorado, the Amazon woman warriors and native mythology, I've also tried to do for those legends what Kevin Siembieda did for Camelot and Atlantis — take the stories and give them a unique spin that fits right into the Rifts Megaverse. Thus, you'll find not one city of El Dorado, but several, all of which view the others with suspicion. You'll find a couple of new magical sub-systems and much in the way of new equipment, adventure ideas and interesting characters that I and the rest of the Palladium staff could cram into one volume.

In the early planning stages with Kevin, he encouraged me to expand on the continent as much as I could and let me know that if I could not fit it all in one book, a second South American world book could follow. And it will: This **sourcebook** deals mostly with the northern portion of the continent and the Amazon basin. It will be followed up by another world book that details the Empire of the Sun, where the ancient Inca culture has been reborn, and the Silver River Republics, a high-tech sanctuary where some advanced pre-Rifts technology still survives.

I think the Rifts system has achieved an amazing blend of all the most common genres of RPGs, mixing fantasy, science fiction, super-heroics and horror in a unique way. I am glad to be contributing to it.

— *C.J. Carella*



Distance is no longer a sure means of protection — if it ever was.

## The First Transcript November, 102 P.A.

Greetings to all my friends in the Council of Learning, especially to Plato. I hope you are all well, as I haven't had news from you in over two weeks. Our last radio contact with North America took place while The *Quester* was still North of the Bermuda Triangle. The Ley Line activity in the region is interfering with our communications, among other things. Our progress has been slow, as we try to skirt all active zones. Edmund Globetrotter, the *Shifter-for-hire*, has been most useful to us. If it wasn't for his astounding magical prowess, even this converted frigate would have long been swallowed by a Rift or torn asunder by one of the storms.

### Monsters from Atlantis

... and that has been but the beginning of our tribulations. Just three days ago, a giant floating monster attacked the ship. Despite its monstrous appearance, the creature was obviously intelligent, and it tried its best to damage the ship. Thankfully, our missile batteries were enough to drive it off, hurt but still alive. The monster continued to trail us, this time underwater, but turned back after we fired one torpedo at it. I hope this will be the last we see of it. Enclosed you will find the video and sonar records of the brief battle. I apologize for the lack of clarity, but perhaps your computers can enhance the image of the creature. The expedition's military commander, the mysterious Claymore, told us the creature was a Murex Metzla, a being affiliated with the rulers of Atlantis. I shudder to think what other horrors the inhuman leaders of that continent could unleash on Humankind. Claymore knows more than he's telling us, of that I'm sure, but I will continue trying to gain his trust. He wants to see South America as much as I do and his talents as a warrior and military commander are unquestionable.

We have passed several small islands in the course of our journey. On all four occasions, we sent power armor fliers to explore them. One island was a barren rock, completely uninhabited. Two had some pitifully primitive human *settlements*, so fearful of strangers that our attempts to communicate with them failed in the time we could spare before moving on.

The last island turned out to be a living thing! Without warning, one hundred meter (328 feet) long tentacles whipped out of the seemingly inert rocky ground, snaring one of our power armor troopers. There was nothing we could do for the unfortunate man; the tentacle snapped him in half, power armor and all, in a matter of seconds. Claymore coldly told us that from the sonar readings of the "island," the creature was a hundred times more massive than our ship, and we simply did not have enough weaponry to destroy it. We sailed away, and from now on we will use unmanned drones to investigate these islands.

One dead already and we are not even near our goal. I pray this is not a harbinger of things to come.



## An Overview of South America

### The Travelogue of Professor Augusto Cudbury of Lazlo

**Introductory comments from the archivist at Lazlo:** The following are partial transcripts of the six messages sent by Professor Cudbury's South American expedition. At great personal expense, Cudbury and several patrons financed the outfitting of a Triton Patrol Boat converted into a research vessel. The ship, christened *The Quester*, set off towards South America on April 10, 102 P.A. We have ample records for *The Quester's* trek up the Great Lakes river, past the Coalition State of Free Quebec. Free Quebec did not interfere with the ship, although we have reports that Chi-Town's government was most displeased with Quebec's forbearance. Then the ship started its perilous trip southward.

The following transcripts are copied from the memory banks of six nuclear-powered drones that Cudbury sent back to Lazlo as he progressed in his voyage. Cudbury sent a total of 32 message drones, four per message to make sure at least one would reach Lazlo. Of these, only fifteen reached us. Two whole sets of four drones never made it to North America. Given the dangers the small robot vehicles had to endure, it is not surprising that there were some casualties. Some of us at the Council believe that Coalition spies learned of these drones and purposely tried to shoot down or capture them as they flew through their territories. Such is the blind fear of knowledge that *Prosek* and his minions espouse, to the detriment of all. But even from the surviving documents, the Council knows that South America will not remain an obscure land of legends for much longer. There are Powers in those lands that will soon make their presence felt.

## The Second Transcript March, 103 P.A.

We have arrived. I am no Erin Tarn, so I will let the enclosed video records speak for me, but I am overwhelmed by the beauty of this place. The Amazon is the mightiest river I've ever seen, wide and deep enough to allow us to continue our trip into the heart of the continent aboard our ship. This is good — I had feared we would be forced to continue the trip in the small barges we had brought, or even on foot, both risky alternatives. For the past few months, we have circumnavigated the area commonly known as the "Thousand Islands." I have seen the old maps that show this was once a solid continental mass and it is shocking to compare those images with today's reality.

Something we all will have to get used to is the oppressive heat — it's not quite as bad as some parts of North America in the summer, but close enough. The constant pestering by mosquitos and other vermin is another thing one must get used to. Disease is always a danger in these parts and we've instructed everyone to use insect repellents and take immunogenic pills on a regular basis.

### First Contact

Our first contact with intelligent life came at sea, where we were met by a gunboat! It wasn't a very large or powerful ship (it displaced less than 100 tons/90,000 kg, I was told), and its weaponry was not highly advanced, but it bespoke a degree of civilization we weren't expecting.

We were ordered to identify ourselves. The patrolmen spoke a form of Spanish that is different from that spoken in Southern North America and Mexico. Isolation has bred different dialects, I suppose. We were able to communicate with them, however, and we learned that the boat hails from the largest human nation on the North Coast, the Republic of Colombia. Once we identified ourselves, we were welcome to dock outside the port of Ciudad Bolivar. The harbor was too small to accommodate our ship; at least that was what the authorities claimed, but I think they are wary of strangers. The pilot that guided us through a mine field protecting the harbor spoke of pirate raids, vampires and other monsters to the West.

Despite their wariness, the leading members of our expedition were invited to a reception given by Ciudad Bolivar's governor, General **Armando** Collazo. He was friendly and talkative. From him and his fellow officers (and, even more importantly, their wives), I learned a great deal about their country.

The reception was followed by a feast where we had the chance to sample some Colombian cuisine. Corn, rice and black beans are among the most important staples. Unlike Mexican food, there wasn't much in the way of hot spices like **chili** peppers, for which my bowels were grateful. While we ate, we were able to hear a lot about this nation's past and present.

**Colombia** is a developing nation that has managed to unearth enough **pre-rifts** technology to make it comparable to **Lazlo** or **Whykin**. The nation is in a state of constant warfare. Ciudad Bolivar itself was attacked less than two months ago by a band of humans and D-Bees on speedboats. The raiders fought their way into the city market and managed to carry off some valuables, although they probably didn't get away with enough to make up for their losses.

For as long as anyone can remember, there has been a continuing conflict between Colombia and the vampire-led armies of the West. The Colombians fervently believe that these vampires have built their own kingdom, where human slaves toil for their undead masters. Although I saw no **vampiric** activity firsthand, I have become convinced that the vampire threat both here and in Mexico is far graver than we imagined. I fear that Erin Tarn met her doom in Mexico and that her worst fears about the area were, if anything, underrated. (**Editors' Note:** The **Cudbury Expedition** left Lazlo shortly before they heard from the heroic Erin Tarn, who is alive and well and still travelling around the world.)

From the sidelong glances our hosts gave the two non-human expedition leaders at the dinner table and some other off-hand remarks, I deduce that Colombia shares much of the same hatred and prejudice toward non-humans as the Coalition States. Threatened by organized vampire raids from the West, occasional **Atlantean** incursions from the North, and D-Bee pirates from the East, I can understand, if not justify their fears. Unlike the Coalition, however, the Colombians welcome and accept magic-practitioners and, in fact, have made significant developments in **techno-wizardry**. I also noticed that one D-Bee race was exempted from prejudice. A Dwarf sat at the table with us and from what I could tell it would seem that the largest non-human group in Colombia is made up of Dwarves who have adopted Spanish names and culture. These short and squat **humanoids** made somewhat comical figures, dressed in wide-brimmed straw hats or elaborate military uniforms, but they carried themselves with dignity and a seriousness that discouraged laughter.

I learned there is some limited trade between Colombia and the kingdoms to the South corresponding to the pre-Rifts Empire of Argentina (they are collectively called the Silver River Republics, **SRR** for short). Ships circumnavigate the continent on the Atlantic side and trade diverse technological items, **pharmaceuticals**, and oil, all of which Colombia produces, for the advanced weaponry that is to be found in the Republics. General Collazo proudly told us that the Colombian army recently purchased 24 Glitter Boy suits from the Silver River Republics (**SRR**).

The Colombians avoid the Amazon river, which they consider a brigand-infested wasteland. To their South is a largely unknown land referred to as the Empire of the Sun. It is said that the old **Incan** gods have returned to reclaim their land and are responsible for the emergence of the Empire. Colombia avoids contact with that nation, although there have been a couple of skirmishes along the wide strip of unclaimed land and jungle that separates them. Rumors abound about giant flying ships that are sometimes sighted on the Southern border and that beings from outer space have dealings with these **Incas**! I have read some pre-rifts books that claim that the **Inca** culture (and **Aztec** and **Mayan**, for that matter) was influenced by extraterrestrial visitors. If these rumors are true, how did they get through the barriers that prevent Coalition spacecraft from leaving the Earth's atmosphere? I wish to emphasize that these are rumors, lest I start spreading fear of space invaders — although, given the way our world has suffered, what could these invaders do that is worse than what others have done?

The Pacific Ocean is avoided due to the presence of a nomadic sea race that preys on any ship that strays into their **terri-**

torial waters. There seems to be a number of large sea monsters along the coast as well.

### The Anti-Monsters

Two of the officers present were full-conversion mystic cyborgs called los "Anti-Mounstros" — the Anti-Monsters. It seems that these men are modified through a unique blend of bi-onics and techno-wizardry. My hosts would not divulge how the process was discovered and I don't think that the process would be easily duplicated even in Lazlo or Tolkeen, so I suspect there must be a transdimensional source involved. The Anti-Monsters are promising young psychics that volunteer to have their bodies permanently altered through spells and cybernetic operations. If one believes everything General Collazo says, these men and women are unstoppable juggernauts able to slay dragons single-handed.

Even allowing for exaggeration, I can attest that the anti-monsters were impressive, lumbering masses of armor with incongruously small heads and expressionless face masks. I have been told most of them prefer to hide their features behind featureless masks or macabre helmets with fanciful and frightening designs; it appears that the transformation process horribly scars their faces. The anti-monsters' hatred for all non-humans was evident, however, and towards the end of the dinner we had an ugly incident between Ikamo, my ogre assistant, and one of the anti-monsters. Fortunately, no blows were exchanged, but the Colombian warrior taunted my friend and accused us of being spies from El Dorado! This was the first mention of the fabled city of Gold. The situation was defused before it got violent.

I managed to gain a private audience with Gen. Collazo's wife, as she felt she owed our expedition an apology (there might have been some military calculation involved, as it is obvious that our ship has enough firepower to seriously damage the city). Although we have no intention of antagonizing or hurting our hosts, I took the opportunity to learn more about El Dorado.

### El Dorado — Myth or Reality?

You may recall my scholarly papers on the myths of El Dorado and my interest in finding whether, as with Atlantis and Camelot, the coming of the Rifts had brought about some sort of rebirth of this fabled city. Amalia Collazo is a ley line walker and scholar, and as influential a ruler of this city as her husband. (As a side note, I noticed a conspicuous lack of women in the Colombian military, but counted many among the city's mystic and anti-monster cyborgs. An interesting balance between the traditional Latin American machismo and modern pragmatism). Mrs. Collazo was happy to share her knowledge of the city. Indeed, there is an El Dorado further South somewhere in the solid land mass past the Thousand Islands. Colombia has had no direct contact with the city, so most of the information she could give me was second-hand at best.

El Dorado is said to be a very powerful city-state. Some rumors claim it is a city of magic, others make it a technological heaven, and a few more hold it as a mixture of magic and technology unlike anything else outside Atlantis. Mrs. Collazo told a number of often contradictory stories. In the interest of fairness (and in case this is my last message — the dangers beyond Colombia are not exaggerations, of that I'm sure), I've listed all the rumors below:

- El Dorado is peopled by mutant felines and werejaguars.
- El Dorado is a city of women. If so, that might explain the ancient tales about female warriors in the jungle — the Amazon river was given its name because of those stories.
- The city-state is an outpost of Atlantis. Although there are no direct physical routes between Atlantis and the Amazon, that would pose no problem for a transdimensional civilization. I pray this rumor is wrong.
- The city does not exist in this dimension, but frequent Rifts connect Earth to its plane of existence.
- The city, like Atlantis, disappeared from the Earth centuries ago, and came back when the conditions were right for its return.

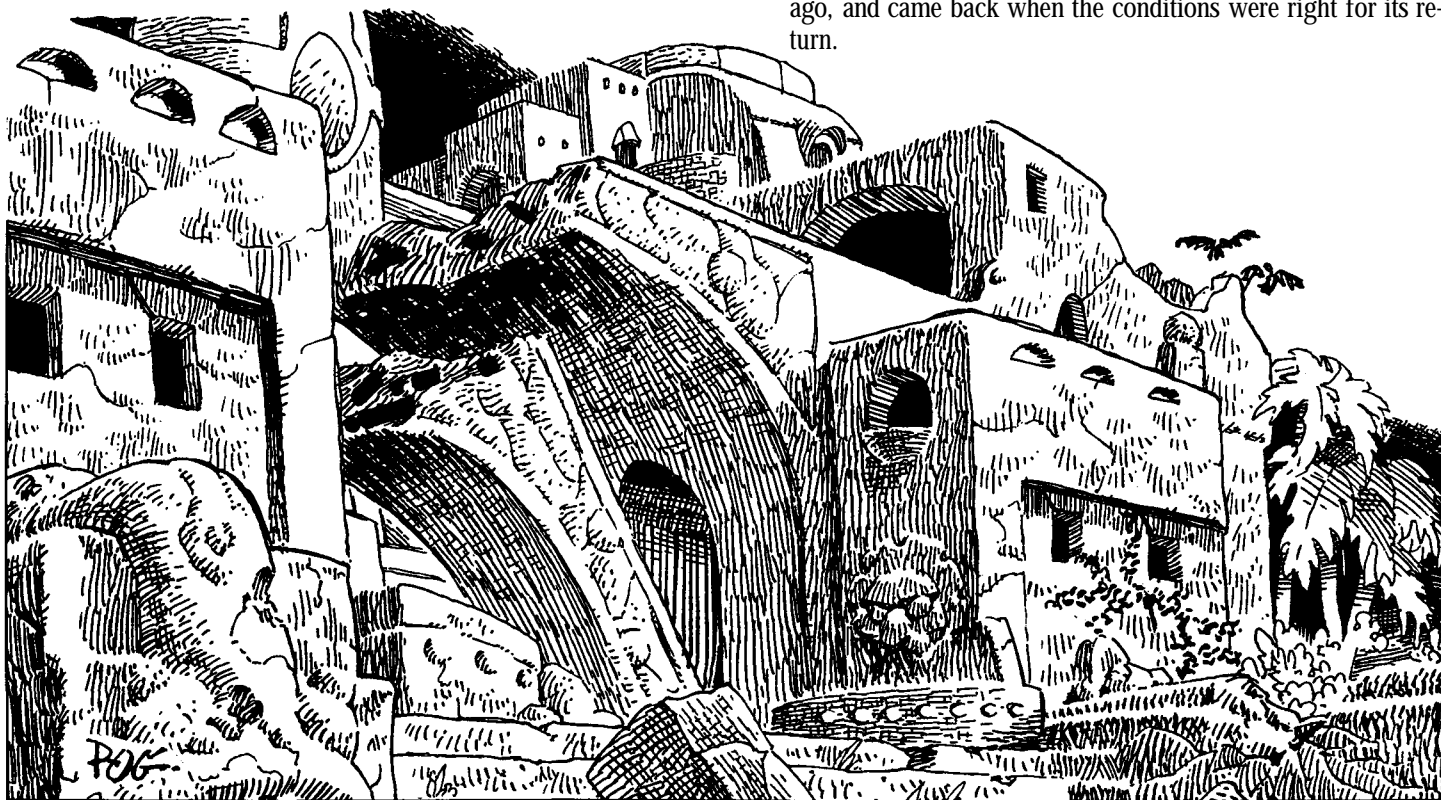

- There is no city of El Dorado, but instead a confederation of city-states.
- There is war in the Southern jungles; El Dorado and another powerful civilization are fighting for control of the Amazon.
- An army of supernatural monsters rules El Dorado.

Hopefully, in the months to come I will be able to determine which rumors are true and which are old wives' tales.

Over the next seven days, we remained anchored at Ciudad Bolivar. Higher-ranking members of the Colombian government have met with us aboard the *Quester*, where in the interest of safety, we decided to remain. The Colombian officials remained cordial, but I could sense an atmosphere of suspicion. They had many questions about North America. Somehow they have heard of the Coalition States and they assumed our ship came from there. I have told them about **Lazlo** and its tolerant policies which they found naive at best. "Humanity is at war for its very survival," a member of the Colombian Defense Ministry told me. "We cannot afford the luxury of allowing potential enemies into our midst." He sounded almost exactly like a spokesman from the CS. This and other conversations depressed me. True, Humankind is beset by foes, but only by making alliances with the other civilized races will we survive.

Despite our obvious differences in opinion, our hosts became convinced that we presented no danger to their nation and consented to sell us supplies and give us more information about the lands to the East and South. They were unhappy about our plans to navigate the Amazon, but decided not to press the issue. They continue to warn us about river pirates and inhuman creatures of magic. Even El Dorado inspires fear in these besieged peoples.

## The Pirate Kingdoms

Many of the small islands in the archipelago are peopled by raiders of the worst sort — heirs of the ancient tradition of the **Brethren of the Coast**. We have heard tales of large pirate fleets that sometimes organize and conduct large-scale raids, as well as of mysterious, **demon-crewed** Black Ships. Some of these pirates raid as far away as Africa, North America and England, despite the dangers of the Bermuda Triangle and the ships and monsters of Atlantis. We have also heard many tales of slave raids from Atlantis. I cannot confirm or deny any of these rumors, but I wanted to mention them to warn (or entertain) any future travelers.

We stopped at a couple of minor islands. Some were in an appalling state of poverty, with people living in simple huts and surviving in very primitive conditions. The only signs of advanced technology were the occasional energy weapon and modern vehicle. The inhabitants of those islands did not attack us and we were able to engage in some minor trade. We managed to acquire several weapons of alien design, designated as "**Kittani**" manufactured. Claymore told us the Kittani are a **Splurgorth** servitor race. We will study these weapons and send you their schematics in future messages.

Piracy aside, I believe it would be to our advantage to set up trade lines between these nations and our own. Lazlo and New Lazlo could greatly benefit from this. I shudder to think what would happen if the Coalition States formed an alliance with Colombia and it made use of that nation's **techno-wizardry** and the Anti-Monster cyborgs. An unlikely turn of events, given the dislike of the Coalition for magic, but not impossible.

## The Bahia Kingdom and the Land of the Lizard Men

The *Quester* proceeded East, as we tried to explore as many of the islands as we could before beginning the journey South. We have charted a number of saltwater and freshwater currents, as well as mixtures of the two. The dominance of fresh water, even in areas that should have been at least brackish, has surprised some of our scientists. Our magicians believe it's a result of Rift activity, the application of magic, or divine intervention by extra-dimensional powers. We found no evidence to support mystical or scientific explanations.

Sea-life was varied, including some Earth species that were thought to be extinct, like the freshwater manatee and river dolphin.

We are staying on the main tributaries and dare not send exploration teams too far away, so I fear we are missing a great deal. Still, I feel we are gaining a much greater insight to this mysterious continent than we had before our expedition.

There are a number of independent communities scattered among the islands we visited. Many of these communities seem to be made up entirely of people of Indian or African ancestries. Most have returned to the ways of their ancestors. Our arrival often frightened these peoples, who abandoned **their** houses and went into hiding in the jungle. Twice, we were attacked by magic and **techno-wizardry**. Rather than give these people cause to hate us, we tried to leave without resorting to violence.

Over a period of two weeks, the inhabitants of the islands eventually came to trust us a little and we managed to talk to several village headmen and shamans. The common tongue along these areas is a mixture of Spanish, Portuguese and an Indian dialect called Creole (this language has no relation to the "Creole" tongue spoken in the Caribbean in **pre-Rifts** times). Enclosed you will find linguistic notes and a translator program with a 6,000 word dictionary. Future travelers would be well-advised to learn this language. Spanish seems to be limited to the Northern and Southernmost portions of the continent and becomes less frequent the further South we travel.

Most of the Indian and Afro-American communities we've met are organized along tribal lines, with a handful of trading towns and cities. We only encountered one such city, New **Bahia**. It is run by a priesthood who worship ancient African gods. New Bahia the city is the capital of the Kingdom of Bahia, which is based on the largest island of the Archipelago. The kingdom was small, but relatively well-developed. The city depends on magic and techno-wizardry almost completely. Some of their equipment and devices are purchased from another island called Maga, which specializes in using magic to replace technology.

**Maga Island** is populated by humans and a race of **humanoids** called "**los Duendes de la Jungla**" — Jungle Elves. These green-haired creatures channel their magic to transform animals, plants and even their own bodies with incredible effects. Regrettably, the *Quester* was not allowed to dock at Maga Island, but even at New Bahia, I saw first-hand a previously unknown brand of wizardry called **Biomancy**, the magic of the Jungle Elves. It is indeed an amazing craft. The **biomancers** can create articles of clothing and food out of simple trees and plants without harming them! This is the ultimate relationship between man and nature,

which I don't think is matched even by the druids of England. And I'm told that Maga Island is "the" most powerful center of biomancy on the continent and is the source of wondrous suits of armor woven from mere wood and insect chitin.

New **Bahia** worships the so-called Voodoo deities with a number of very dynamic ceremonies and dances. We were invited to one such event, where we saw believers become possessed by their "gods" and perform great acrobatic leaps and speak in strange tongues. The mystically inclined members of our expedition found the magic in those ceremonies to be real and very effective. Much of the power of Voodoo comes from interaction with entities called the "loa"—spirits not unlike the poltergeists, haunting and possessing entities well documented in **Lazlo**. Thankfully, these entities are more benevolent, at least to those who know how to control them.

Perhaps the most interesting discovery we made at New Bahia was the existence of a huge population of lizard men. Most of these villages and cities are built of wood, directly over the river, anchored with poles sunk into the ground beneath the water. Even New Bahia had a large community of these creatures who lived in their own neighborhood and conducted a lively trade there. These people spoke what we've identified as Dragonese or **Elven**, which Edmund Globetrotter calls "the common tongue of the **Megaverse**." We managed to interview several Lizard Men at New Bahia and learned they settled on Earth over two centuries ago, shortly after the Coming of the Rifts.

We are told that elsewhere along the Amazon, there are several lizard-man city-states collectively known as the "Kingdom of **Lagarto**," the Creole/Spanish word for Lizard. Although there is no actual king or overall ruling body in the Kingdom of Lagarto, it is rumored that a confederation of cities ruled by a dragon is trying to build an empire by forcing the various lizard-man communities to swear allegiance to it and to embark in a war of conquest. The lizard men of New Bahia knew little about Lagarto and begged me to tell them if any such information became available during my travels south. I promised I would do so.

I hope these rumors are wrong. It is encouraging to see a large population of D-Bees settled and living peacefully with their human neighbors. After we left The Kingdom of Bahia, we purchased a few supplies from two lizard-man villages. Although the size of our ship worried the villagers, we were still received peacefully and eventually they became comfortable enough to talk to us. They knew about the rumors of the Lagarto Kingdom but could not confirm them, either. These simple people keep to themselves even among their own kind and prefer to be left alone. "That makes them smarter than most people I know," was Claymore's comment when I shared my insights with him. A strange belief for a man who has by his own account travelled through many lands, many worlds, even.

**The rain forest** and jungles themselves are awesome. The profusion of colors, sounds and smells can be overwhelming at times, and yet one can feel at peace here. The rain forest proper is much calmer, with enormous trees and little underbrush. Even so, along the river many of the old dangers, such as mosquito carried diseases, biting insects, piranha fish and snakes still linger. Twice I have seen the waters boil when a school of piranha found a victim. I am told that a new species of "**CaribFish**" (another name of Piranha) is so powerful that a swarm of them can

tear apart a man in power armor! Fortunately, there are several magical and technological countermeasures for such monsters.

We continue travelling South, staying in the main tributary. We have hired half a dozen local guides at New Bahia (nobody in Colombia would accompany us); hopefully they will make our travel safer.

## The Third Transcript May, 103P.A.

We have learned that the reports about the Kingdom of Lagarto were all too accurate. A large area on both sides of the Amazon seethes with war over control of the lizard people. We have come across no less than five lizard-man villages, all burned to the ground and the inhabitants slaughtered. Populated villages evacuated in terror when they saw us approaching, fearing we were conquerors or raiders. We have heard explosions and energy discharges in the distance as we slowly navigate these waters. Most of the fighting seems to be concentrated on the "East Bank." Eventually, I'm sure the conflict will extend to the North and West. One more threat to the security of Colombia — and another reason for that nation to fear and hate non-humans.

We did not escape involvement in this conflict. On the fifteenth day after my last transcript, the ship was attacked by a number of lizard men in canoes. They were armed with energy rifles, fully the match of modern weaponry. Among our attackers were several magicians and shamans who caused confusion in the ship with weather and **illusionary** spells. Much against our desires, we returned fire. The lightly equipped warriors were no match for our **firepower**. Then a dragon came, sweeping down from above and landing on our deck! We lost six men in less than a minute, until Claymore, wielding the sword that gave him his nickname, faced the creature in single combat — and defeated it!!

We saw the man survive a claw swipe that cut clean through his body armor, so we now know that Claymore is more than human. Is he a mutation, a member of some **transdimensional** race, or something more? All I know is that he won't speak of the incident and that the rest of the crew give him a wider berth than ever before. He does not seem to mind the isolation and he remains an effective leader. I've never seen a crew leap to obey commands the way his did.

As per his suggestion, we continue to use our loudspeakers, announcing our intention to traverse the land peacefully, in both Creole and Dragonese — and we have mounted the dragon's head on a pike, a grisly trophy of our determination to defend ourselves. I protested this act of brutality and desecration, but Claymore insisted. "The other Dragons will understand the message," he said bluntly. "Now they know we are not to be trifled with. I only hope they decide we aren't worth the effort to destroy." He seems convinced that a dragon controlled kingdom was responsible for the attack and dominate this territory. He may be correct, because over the last month we have not been attacked by either lizard men or dragons.

We have seen a number of exotic creatures, including a giant alligator, over forty feet (12.2 m) long. It followed our ship for a while but finally disappeared. We have made frequent foraging trips into the rain forest. Our botanists and zoologists are de-

lighted. The legendary variety of Amazonian flora and fauna is no exaggeration. In the dozen short trips inland we have made, we have catalogued no less than three hundred varieties of animal and plant life not found in any book or database. Our native guides have identified herbs, fruits and animals with powerful medicinal and pharmaceutical chemicals, as well as some with great magical potential. I wonder what an English Druid would make of all this.

Of the handful of peaceful communities we have seen (even in times of war, life goes on for many people), I asked about the fabled Millennium Trees, which are said to grow in Europe, Africa and Asia, but which for some reason have avoided the American continent. None of the natives seemed to know about the trees I described. Several thought we were making a joke and dismissed the idea entirely. A human **biomancer** told us: "They wouldn't grow here. A tree that big would make the One jealous." He was referring to a mythological First Tree which supposedly was the source of all plant and animal life in the world. The Tree is said to grow at the center of the world (the center of the rain forest, **maybe?**), and can only be found after penetrating a veritable maze of physical and mystical defenses. The Tree is said to be a source of great magic and wealth. Could this be a Millennium Tree, or a different species altogether? I hope we will be able to answer this question as our journey progresses.

## The Fourth Transcript July, 103 P.A.

**Note:** This is in actuality the fifth part of **Cudbury's** messages, no transcripts of the fourth one survived the trip to North America. From what little could be pieced together, it seems that the **Lagarto** Kingdom and its agents continued to harry the **Quester** for weeks on end — *The Council of Learning*. The following is the next transcript received.

I fear we haven't made any progress since the battle at the **Carib** village. The damage has been too extensive and we have lost over half of our missile launchers. My earlier damage report was too optimistic. We simply don't have the parts to effect the repairs we need. Even **Claymore** is dejected. The physical injuries he incurred during the battle with the wave of dragons and lizard men have healed, but he looks like a man who has met his match. After interrogating a prisoner, he found out who is behind the depredations of the Lizard People. Although he won't give us details, he has mentioned the **Pantheon of Dragonwright**. I know the name only too well, having seen the cult's spread in the Federation of Magic and even in our own **Lazlo**. I pray the Council will make public the pictures of atrocities committed in the name of **Dragonkind**. I know most dragons — among them my respected colleague **Plato** — would be appalled to see their name taken in vain in such an obscene manner. I have heard that the cult is not usually evil, but the twisted version being spread on Earth seems to be deplorably evil.

**Edmund Globetrotter** died without regaining consciousness. He joined the others with a simple burial offshore. We have lost almost one-fifth of the entire expedition. We dare not go back; we have managed to leave the area controlled by the so-called Kingdom of **Lagarto**, and the dragons and their minions seem to be afraid of following us this far South. Our only hope is to make the entire journey South and seek refuge among the Silver

River Republics. There we hope to effect repairs and make our return via the Atlantic Ocean. Our journey is now one of survival.

## More of El Dorado

We have made inquiries at the village where we have been staying about **El Dorado**. The local tribe has heard of it and swear they know for a fact that there is more than one mighty city called **El Dorado** in the jungle. All of the **El Dorados** are on the West Bank and each is independent from the others. The local shaman says all of them are places of enormous magic and at least one of them trades regularly with tribes on the mainland. The shaman said there were four cities of **El Dorado**: a city of women, a city of wizards, a city of jaguars, and a city of monsters. This might explain the contradictory reports we heard during our earlier travels. Not one, then, but four or even more cities hidden deep in the jungle comprise **El Dorado**. We are in their area of influence now, which explains why the pursuit of the **Dragon Kings** has slackened off; even they wish to avoid conflict with **El Dorado** — at least not until they have consolidated their power base.

## The Fifth Transcript August, 103 P.A.

We were wrong once again about the persistency of the **Dragon Kings**. **Claymore** is sure these dragons are insane or totally consumed by malevolence. Our miscalculations may have cost us the **Quester**.

The leaders of the Kingdom of **Lagarto** chose subtlety for their most recent attack. Under the cover of darkness, a dragon flew on board, assumed human shape, and made its way into our hold undetected. He tripped one of our magical alarms, but before we could deal with him he had **teleported** away. The bomb he planted next to our nuclear power plant went off moments later. There was no meltdown, thank Heaven, but the core casing has cracked and we have had to shut the reactor down. The batteries don't have enough power to carry us very far. We are trying to cannibalize the power plants of four robot vehicles and jury-rig them, but even this is a temporary measure; those power plants don't have the capacity to provide continual energy, and we will be forced to proceed at a snail's pace from now on. We certainly cannot return to North America until we have somehow replaced the reactor.

## The Amazons and El Dorado!

A few days after the disaster, we made an astounding discovery. Four canoes coming from the western shore intercepted the **Quester**. They were crewed by female warriors — we have found the mythical **Amazons**!

The women were tall and athletic, with long black hair and tanned skin. They were dressed in archaic armor reminiscent of Ancient Greece. Does this mean that the Amazons that gave this river its name are actually the same Amazons mentioned in Greek mythology? I wish I was in a more relaxed environment; I fear I am in no shape to pursue the implications of this discovery at this time.

The Amazons greeted us in the **Dragonese** tongue. They wanted to know our origin, our destination, and any news about the dragon rulers of **Lagarto**, but they answered precious few

questions in return. When asked where they came from, one warrior replied “**Manoa.**” Now, I happen to know that Manoa was one of the mythical cities of El Dorado! “So you're from El Dorado!” I blurted out. They looked puzzled and almost angry at the mention of that name. Perhaps the El Doradeans do not appreciate being called by the name Spanish invaders gave their lands. In any case, our requests to send an expedition inland to visit their city were denied. “We are at war,” the Amazon leader explained to us. “The forest isn't safe.” They named their enemies as the cities known as **Omagua** (another of El Dorado's names) and **Cibola** — another city of myth, but from North American legends! I dare not even venture to speculate what this all means.

They left Helena, one of their warriors, on board to act as our pilot and guide. They seemed to trust us enough to leave only one Amazon aboard — or maybe they didn't fear our expedition. Over the last six days, we have proceeded at an excruciatingly slow pace. Even a canoe, let alone a sailing ship, could overtake us. This Amazon has warmed up to us, however, and has told us more about the lands we will not be able to observe.

According to our guide, Manoa is an **Atlantean** outpost. These matter-of-fact words terrified us. Are these women another **Splugorth** creation, like the Blind Warrior Women that harry us in North America? We did our best to disguise our disquiet and tried to get as much information as possible. Her description of **Atlanteans** is nothing like what we've heard about the monstrous Splugorth and the current alien inhabitants of that continent. In fact, her descriptions reminded me of the legendary super-men of Greek legend. I have heard rumors about so-called, “True Atlanteans,” and begin to suspect that maybe the same name was applied to two different races and cultures. I leave the speculation to my more learned colleagues. Helena said that Manoa was a peaceful, prosperous city engaged in a war of survival against her two evil neighbors.



Omagua is a city of beast-men, ruled by strange gods. I wonder. I know that Argentina was known to have engaged in advanced bio-engineering research before the Coming of the Rifts. Some of that research is said to have been duplicated at Lone Star where the Dog Boys and other mutant animals are created.

Maybe this “legendary” city is a haven for these oft hated creatures. Cibola, on the other hand, reminded me of descriptions of Atlantis. A city ruled by totally inhuman monsters engaged in acts of slavery and cannibalism. The **Cibolans** also seem to love destroying large tracts of rain forest to exploit its riches. From that, I'd almost believe that the Cibolans are the **Splugorth's** puppets and the so-called “Atlanteans” from Manoa are something else altogether.

Enclosed you will find the complete transcripts of the interview, as well as a dictionary and basic translation program of the “Atlantean” tongue, which does bear some resemblance to Ancient Greek (of which tongue I only know a smattering; perhaps the resemblances will not bear close scrutiny).

## The Sixth Transcript September, 103 P.A.

Note: Once again, a transcript is missing between this and the previous one. The loss is very unfortunate, because it seems that a great deal of information about the cities of Manoa and Omagua were included there and may be lost to us — *The Council of Learning*.

When I left North America, I thought I was leaving behind a continent torn with strife and violence. I had high hopes that, unlike my homeland and bloody Europe, South America would prove to be somehow different. Vain hope, that. As I record these words, I see the mighty **Quester** sink. The ship is lost and with it any hopes of returning home. No attack from the **Lagarto** Kingdom destroyed our vessel. Instead, we were caught in the evil that is called **Cibola**.

First we were contacted by a hideous little creature that called itself a **Gatherer**. It demanded we pay a toll to continue our travels south. The toll was to be paid in flesh! The filthy monster wanted slaves. We all but kicked the monster off our ship and prepared to do battle.

It didn't take long in coming. The attackers were golden-plated monsters, piloting open flying platforms and armed with powerful beam weapons. There were no less than a hundred of these monsters and they raked the **Quester** from bow to stern. Among the casualties was Helena, our Amazon guide. We spent all our missiles in defending ourselves and lost over one-third of the crew, but managed to fight them off. All to no avail; the ship has three large holes below the waterline and it is sinking. Fortunately, we were able to beach ourselves and have evacuated everyone and everything we could remove. Then we scuttled the ship, to deprive our enemies of any booty. I felt my heart break as our trusty vessel sank under the swift currents of the river.

We are sending our next-to-last group of message drones with this report. We will proceed through the jungle. Going North is impossible because we would have to fight through the dragon controlled areas and face innumerable dangers. So southward bound we continue. We will dispatch our last set of drones when we find some sort of haven. Pray for us.

Note: This was the last message received from **Cudbury's** expedition. We fear we have lost one more adventurous and courageous soul to the pursuit of knowledge. — *The Council of Learning*.

---

# Rifts South America

---

South America covers an area of roughly six million square miles (15.5 million square kilometers). Before the Coming of the Rifts, the continent had a triangular shape, but the continent has split into two large sections. The eruption of the ley lines, explosion of Rifts, and the return of the continent of Atlantis created a tidal wave unlike anything seen on Earth. The whole northern coastline was obliterated. Countries like Venezuela and Colombia, where most of the population was concentrated, were crushed. More than nine-tenths of the inhabitants were killed by the tidal wave alone. Millions more perished in the earthquakes, storms and tornadoes that devastated the whole continent as a result of thousands of Rifts opening at the same time around the world.

The continent is a divided land, cut in two by the mightiest river to ever run through the Earth. The Northern half of the continent is dominated by jungles covered in tropical and semi-tropical forests, with patches of less dense savannah. Most of its northern shores have been fragmented into hundreds of islands of varying size. The weather, flora and fauna is for the most part very similar to what it had been before the Rifts, although there are hundreds of exotic species and **D-bee** life forms.

The southern half remains a mostly unexplored wilderness.

## The Amazon River

Even before the Coming of the Rifts, the Amazon river was the largest (and second longest) river in the world, 4,000 miles (6400 km) long, and up to 150 miles (240 km) wide at its mouth; over 1,000 miles (1600 km) of the river were navigable by the largest ocean-going ships. The river tended to run towards the East and West, with dozens of tributaries streaming South into the Continent.

After the Great Cataclysm, the Amazon was transformed into a river the likes of which the Earth has never seen, over 15,000 miles (24,000 km) long (not counting tributaries), and with an average width of 3 miles (4.8 km) — at several places, one cannot see the opposite shore, which is well beyond the horizon! This makes the Amazon the largest freshwater body on the planet. In fact, much of the surrounding coastline has been transformed into fresh water, with a wider strip of brackish water separating it from the salty ocean.

The Amazon has two main branches. The **East-West** stream, which follows the contours of the original Amazon river, is the area with the most islands and is the widest (but shorter) of the branches. It is known as the Lesser Amazon (ironic, since that used to be the main portion of the river). Its tributaries reach all the way to the Pacific Ocean.

Running south, splitting one-third of the continent from the rest, is the 9,000 mile (14,400 km) long Greater Amazon. By rights, it should be a salty body of water, but it is not. The few scientists who have examined the problem have been stymied. Mages and mystics believe that a permanent Rift somewhere along the river is the source of the fresh water. Some actually

propose that this hypothetical rift opens directly to the Elemental Plane of Water, the mythological native dimension of Water Elementals! Whatever the case may be, there are an uncommonly large number of water elementals living along the length of the Greater Amazon.

## Weather

The average weather of the region is hot, averaging 86 degrees Fahrenheit (30 degrees Celsius). In some areas, the temperature can fall to about 64 degrees Fahrenheit (18 degrees Celsius), while in the mountains it can fall all the way to below freezing. Rain is very heavy, averaging around 40 inches (1020 millimeters) every year. The heat and the humidity can be debilitating to people, especially if encumbered by a lot of equipment. Even environmental armor cannot completely shield people from the worst of the heat: There is a 5% chance (roll every week) that air filters or cooling systems will overload or become clogged; characters will then be at -2 to strike, parry and dodge and will tire twice as fast as normal. The armor will heat up and become as hot as a steam bath.

## Flora and Fauna

There are more species in the South American rain forest than in any other region of the world. Even a small area (say, one square mile/2.59 square kilometers) of rain forest has thousands of animal species and hundreds of plants. Most of them had still not been classified by scientists before the Coming of the Rifts (not counting the thousands of species that will be forever unknown, driven to extinction by indiscriminate logging and deforestation before ever being discovered). As a result, it is hard to tell which plants or animals in South America are native to Earth and which are **transdimensional** newcomers. Many species had latent psychic and magic powers which have been awakened by the emergence of ley line energy.

Some common species in the region include dozens of varieties of monkeys, giant rodents, wild pigs, and several feline predators, the most famous being the spotted jaguar. There are thousands of bats, the most famous of which is the vampire bat, which drinks the blood of sleeping cattle and humans, and often transmits diseases with its bite, including rabies. A giant variety of vampire bat appeared after the Coming of the Rifts (see the Vampire Kingdom of **Haktla**).

## Languages

The main languages found in South America include Spanish, **English/American** and Creole (a mixture of Spanish, Portuguese, and Indian dialects). A few groups still speak Portuguese in what was formerly Brazil. **Dragonese/Elven** is the fastest-growing language of the continent. It is spoken at the Kingdom of **Lagarto**, the cities of El Dorado, and all communities in contact with either Jungle Elves or Lizard People. Creole is the next most common tongue. **Demongogian**, the foul tongue of the demon and devil races, is spoken in Cibola and the Vampire Kingdom of **Haktla**.



# The Republic of Colombia

**Population Breakdown:** Slightly over 2 million total; mainly humans.

Most Colombians are of mixed racial heritage, combining white, Indian and African ancestry: 1.7 million

Dwarves (the source of much **Techno-Wizardry** knowledge): 150,000

Lizard Men, mostly on the Eastern frontier; accepted but tend to keep to themselves. The greatest concentration in Colombia is found in the cities of **Camargo** and **Bonito**, plus about a dozen small lizard-man villages: 60,000

Normal Elves: 99% live in the **Elven Quarter** of **Camarg**: 3,000

Jungle Elves: Live in scattered villages: 2,500

Changelings: Live in hiding; they have an informal support network — 1,000 (estimated)

**Were-Jaguars:** Small nomadic bands of 10-60 members each: 800

Dragons: (most in hiding) 16

Other D-Bees and non-humans: 5,000 (estimated)

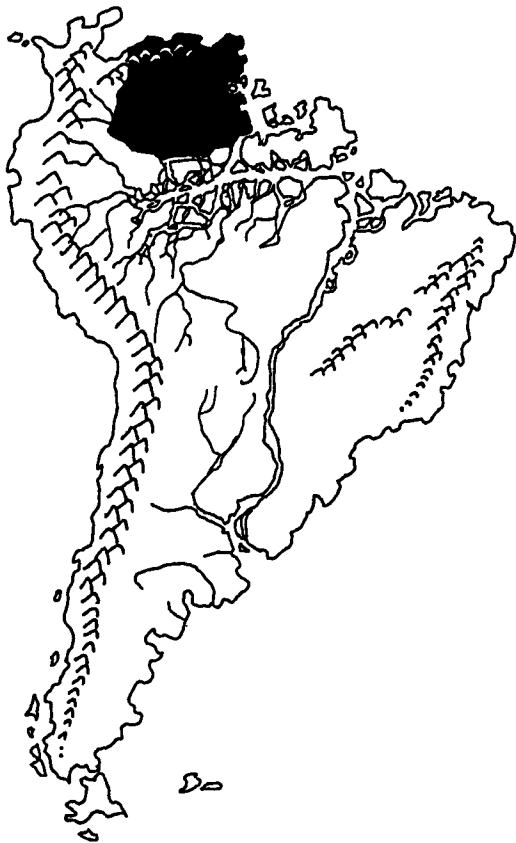

## History of Colombia

The *Estados Unidos de la Republica de Colombia* is a human dominated nation that was built by the survivors from the **pre-Rifts** countries of Venezuela, Colombia and the **Guyanas**. Miraculously, a few regions were not devastated by the Great Cataclysm and the survivors managed to rebuild some level of technology. But even so, the Republic would not have survived

if it hadn't been for the help of a number of **humanoid D-Bees** who were brought to Earth by the same Rifts that transformed and destroyed much of the continent. Currently, Colombia's situation is not very different from that of the **New German Republic (NGR)** — both nations are beset by supernatural foes.

## The Early Settlements

As Atlantis rose again in the Atlantic Ocean, enormous waves bombarded the coasts of upper South America. Most of the population, which lived along the coastline, was wiped out by the disaster. Only a handful of towns, cities and other installations in the interior escaped annihilation. Among those installations were four military bases in the jungle area, used to fight off drug dealers and to protect national borders. In the ensuing chaos, the military commanders from those bases joined forces and took the reins of power. Resistance to the military was minimal. The people were terrified and welcomed the idea that somebody, anybody, was willing and able to take charge.

For several years, the survivors tried to rebuild and survive, ignoring other communities and turning their energies inward. A handful of people developed magical and psionic powers. At first the community reacted with fear to these “**brujos**” (witches), but with time, practitioners of magic were eventually accepted as long as they acted for the benefit of the community. A large group of D-Bees also appeared in the area. Most of them were dwarves from an advanced alien civilization that specialized in **techno-wizardry**. Their contribution to the progress of the fledgling country soon overcame any suspicions on the part of the indigenous people. Soon, the “**Enanos**” (the Spanish word for dwarf) became an accepted part of the Colombian culture. A couple of decades after the Coming of the Rifts, the Republic of Colombia was born. Twenty years later, first contact with other civilizations to the east took place, most notably the kingdoms of Bahia and Maga.

Through this period, the survivors were extremely tolerant and unprejudiced. Their military defenses were enough to protect the first cities and villages. Monsters that threatened people were destroyed or chased away, but any D-Bee that did not act in a violent manner was allowed to live in the cities. Many became full citizens. This open-door policy lasted for almost a century. Then, the Vampire Wars shattered this policy, along with complacency.

## The Vampire Wars

It started with strange disappearances and bizarre murders. Lone patrols would leave for the neighboring jungles and never be heard of again. It became dangerous for a person to take strolls alone at night. Every morning, the body of some unfortunate would be found on the streets, drained of blood. Aberrations of nature soon followed. Dogs and rats started attacking people without provocation and the annual rainfall started to decrease (this was not linked to the attacks until much later). Eventually, some victims were lucky and resourceful enough to survive. They described their attackers as **fanged humanoids** who sought their blood. Some of the D-Bees shuddered and told their human neighbors about experiences they had with vampires and the danger they posed. The government organized special squads to search the cities for any signs of **vampiric** activity.

At the cost of many lives, the cities and townships of Colombia purged themselves of the vampire marauders who had taken

up shop in their settlements. Some Colombians thought the nightmare was over, but this was but the first skirmish of a war that continues to this day. The early infiltration and assaults had only been a test of the human's will. About a month after the human's *countermeasures* were instated, the vampire intelligence that ruled the undead in this region ordered a major assault against the entire country. That massive raid would become known in Colombian history as "the Night of Blood." Three thousand vampires, over six thousand monstrous D-Bees (including brodkil, sowki, ghouls and dybbuk), thousands of giant vampire bats (see below) and hundreds of human slaves attacked virtually every city, town and village in Colombia at the same time: 11 p.m. on a Sunday, when most people were in their beds. Families that lived away from large communities were slaughtered quietly and efficiently. Entire villages and half a dozen towns were massacred to the last person.

At the end of the Night of Blood, over 30,000 innocent people had been killed. The majority were women, children and the defenseless! Some 5,000 more were carried off by the raiders as blood slaves. Although these numbers may sound terrible, the inhuman creatures had miscalculated. The Colombians were not completely unprepared to resist the vampires and the planned extermination and enslavement of all humans in the area was not successful. The undead attackers lost over half of its vampire forces and auxiliaries — most in failed attempts to destroy the cities. Even more importantly, the citizens of Colombia sought revenge! The war was on.

The conflict became fiercer when it was discovered that the vampires' master had allied itself with a demonic being that was trying to transform South America into a desert!

The war has continued on and off for almost one hundred years. The Colombians have won several victories (twelve years ago, they destroyed all the major vampire cities and almost drove the vampire intelligence out of Earth's dimension), but time after time the predators managed to replenish their numbers and counterattack. The human warriors have learned to hate not only vampires, but their inhuman servants, including most non-human D-Bees. This ended up helping the vampires, as many innocent alien creatures were pushed to the west, away from Colombia, where they had to forge an alliance with the vampire cities or perish.

## Government

Colombia is a Republic. Note that a republic does not have to be a democracy. All the word "republic" means is that the country is not a monarchy with a hereditary king. The country has a president who is elected every six years by the **Military Council**, an assembly made up entirely of Colombian high-ranking military officers (a rank of colonel and up). The general public elects city mayors and other local officials, but true power rests with the military. Most of the people of Colombia don't have a problem with this. They are locked in a war for survival and they trust the military to protect them. Human rights are usually respected, but don't apply to anybody classified as non-human, including most D-Bees with the exception of the dwarves.

The justice system is in the hands of military courts. Trials are quick and justice is swift and merciless. There are very few prisons in Colombia. Serious crimes like murder, rape, arson, and treason carry the death penalty, which is executed within

one hour of the verdict. Lesser criminals such as thieves, smugglers, con-men, people convicted of involuntary manslaughter, etc., are sentenced to a varying period (from one month for the smallest offenses to up to ten years for the highest non-capital crimes) of forced labor at military bases usually located in the most dangerous areas of the country — many say this is as good as a death penalty.

The Current Government is led by **General Mauricio de la Plaza**, a 49-year old veteran who rose through the ranks. General Plaza is a brilliant strategist and tactician who has written several books on anti-vampire and anti-monster warfare. Books that are now used as training manuals in the Colombian military schools. Plaza is mostly concerned with the safety of the nation. A strong believer in human supremacy, he distrusts all D-Bees, with the exception of the Dwarves, and will use any pretext to exile or exterminate other non-human communities in the country. Other than this, he is an honorable but ruthless man, able to plot and machinate with the best of them when it is necessary.

## Society

In some ways, the people of Colombia have reverted to the customs of the 19th century. The military and wealthy land-owners are very influential and the rest of the population are very respectful towards them. The idea of personal honor is very strong and people are prepared to die to defend it. Upper class society is very polite, because a duel to the death can be sparked off by the slightest hint of disrespect. The rest of the people tend to be very religious and patriotic. The external threat of the vampires has unified them like never before in South American history.

Military rank is the principal determinant of status in Colombia, followed by land ownership and money. In the **oldtimes**, officers were drawn from the upper classes, whether or not they were competent. The war against the vampires has changed that and anybody with enough talent and skill can become a powerful military leader. Over the last two centuries, many people who were born to simple peasant families have risen to the top of the military. That is why the army has so many volunteers.

Officers are given excellent pay and benefits. At the rank of major, they become part of the "landed" class and are given a land grant. Very often, this land is located near the border, on a relatively uninhabited and hostile area. Such a tactic stimulates the extermination of vampires and the expansion of the nation's border. It is a popular policy.

After the military come the **Six Families**. In alphabetical order, they are the **Armendariz**, **Crespo**, **Rios**, **Sanchez**, **Torrijos** and **Villarreal** families. These six families are clans that each have hundreds of members and thousands of people in their service or under their patronage. Family members usually have a normal name and surname and then add their clan name. For example a man called Emilio **Rodriguez** who belonged to the Crespo clan would call himself Emilio **Rodriguez-Crespo** and people would give him a great deal of respect.

The Six Families own huge plantations where they are the law; much like the medieval barons of old. Many of the junior clan members join the army but the rest concentrate on the family business. The families' immense wealth makes them very influential, but they know that the military retains most of the power. Not long ago, there used to be Eight Families. The other

two tried to avoid paying taxes and did not contribute to the war effort. An armored brigade marched into each family's main compound, dragged the principal leaders into the street and shot them on the spot. Since then, the rest know better than to interfere or try to dodge important military issues.

Feuds are common between the families, some of which are very fierce and violent. The Crespo and Torrijo families have been deadly rivals for fifty years; ever since Luis **Diaz-Crespo** shot **Manuel Gonzales-Torrijo** in the back (of course, the Crespos say the Torrijo member was shot in the back because he was running away after ambushing Luis **Crespo!**). As a result of this rivalry, hundreds of people have died in shootouts, duels, and everything short of a war (which the military won't allow).

The third group of influential citizens are other landowners and the landless wealthy who include merchants, industrialists, and professionals such as doctors, lawyers, mechanics/operators, entertainers, etc. They have little political power but have a lot of money and are in some ways the backbone of the country. Beneath these groups is the middle class. Mostly city workers, regular soldiers, and artisans. Below them is the peasant and worker class. The lower classes are subject to military conscription (despite this, over 80% of the Colombian military is made up of volunteers), and have very few guaranteed civil rights. Surprisingly, the government/military rarely abuses its power. The exceptions occur when people agitate for political change, or are suspected of collaborating with inhuman D-Bees or worse, vampires.

The position of D-Bees in Colombia varies from race to race. D-Bees that are human enough to fit in, like elves and dwarves, are generally accepted, but only the dwarves have full citizenship rights. All others are considered to be foreigners, even if they have been born in the country. Foreigners can be deported very easily by the authorities. Beings like ogres and goblins have even more problems fitting in and will be the first to be questioned or suspected if a crime is committed in their vicinity. Clearly non-human creatures like wolven, centaurs, **rahu-men**, and giants are not allowed to stay in most Colombian cities. At best, they are expelled; often they are killed on sight. Supernatural beings like gargoyles, **brodkil**, demons and other entities are destroyed immediately. Dragons are judged on a case-by-case basis; if enough humans can vouch for the character of a dragon, he will not be bothered, as long as he obeys the laws.

The only accepted non-humans are the Lizard People, who have shared lands with the Colombians for over a century and have shown they are not a threat (this may change now that the Kingdom of Lagarto is beginning to become a threat). Although accepted, they do not share the rights of the human populace and are treated like second-rate peasants and **low-lives**.

Except for the Dwarves, D-Bees, including Lizard People, have little legal or social standing. Business contracts are invalid unless the D-Bee has a human partner. This has bred a whole class of "professional partners," humans who get paid a salary or a cut in a business simply to sign contracts for D-Bee entrepreneurs! A D-Bee convicted of any crime is sentenced to death or exiled. Killing a human, even in self-defense, is punished by death or (if they prove conclusively that the killing was in self-defense) exile. A large number of exiles have settled in border towns very similar to the ones that appeared in the NGR. These shanty-towns, mostly located along Colombia's East Coast, often become a haven for rogues, outlaws and pirates.

## Rift Activity

Colombia has many powerful ley lines and nexus points within its borders. Lacking pyramid technology (fully described in **Rifts Atlantis**), they cannot control the flux of P.P.E. energy along those areas, and Rifts often occur. The Armed Forces always have units on stand-by to deal with any arrivals from the Rifts. Beings from known "monster races" like the **mindolar**, **sowki**, gargoyle and dybbuk are destroyed on the spot. Other D-Bees are questioned and usually escorted out of the nation's borders. Human or very human-like beings (True **Atlanteans** or natives of Wormwood, for instance) are frequently accepted and may be allowed to stay, provided their intentions are peaceful. Trouble will lead to their immediate expulsion, imprisonment or execution.

Occasionally (perhaps once every two or three years) something crawls out of a Rift that is too powerful for a mechanized company to deal with. On those occasions, a general alert is sounded and larger army units search for the creature with technology, magic and psionics, until they capture or destroy it. On 91 **P.A.**, a 12 foot (3.7 m) humanoid that could **fire** lightning bolts from his hands fought an entire mechanized brigade to a standstill before being driven back into the Rift where it came from — it was still alive after withstanding an hour of bombardment and gunfire! The Colombian government believes this was a god-being of some kind and fear it may one day return to exact vengeance.

## Foreign Relations

**Atlantis:** **Splogorth** raiders have been harassing the people of the Republic for years and will continue to do so. Lord **Splyncryth** is not interested in conquering new territories, so the harassment will not go beyond organizing slave raids and posting spies. The Colombian armed forces can recognize most **Atlantean** species and have orders to kill them on sight.

**The Kingdom of Bahia:** The two nations have friendly relations, and have exchanged ambassadors for the last few **decades**. Although they disagree in matters of D-Bee policy, Colombia and Bahia are both controlled by humans and know they may need each other to survive.

**Maga Island:** The Republic views the jungle elves with suspicion. The **biomancers** that control Maga don't like the damage to the environment caused by Colombia's industry, but there is no serious enmity between the two and some trade is conducted regularly between the two countries. Some of the more aggressive and militant Colombian officials have whispered plans of one day conquering this island, but their views are in the minority.

**The Kingdom of Lagarto:** So far there hasn't been any direct contact between the two nations. The Colombian government is hearing disturbing stories about the dragon-controlled kingdom and are worried about the possibility of fighting a war on two fronts. Eventually, (within a few years or maybe months!) the two nations will come into conflict. Their desire for expansion and opposing viewpoints will make war inevitable.

**The Empire of the Sun:** The Colombians are separated from these new **Incas** by mountains and jungle, so contact is minimal. Sometimes, roving Colombian patrols and **Inca** war-bands run into each other with violent results. Neither side is interested in

trade or alliances with the other, at least not yet. Colombian spies have discovered that the **Incas** may have dealings with aliens from outer space! Exactly what those dealings are and how they will affect the rest of the continent remains unknown.

**The Silver River Republics (SRR):** These independent kingdoms to the South represent the most technologically advanced terrestrial civilization on the continent. There is active sea trade between the SRR and Colombia. Several embassies from the diverse kingdoms of that land can be found at La Fortaleza. Colombia owes much of their technological advances to trade with this nation.

**The Coalition States:** After Cudbury's reports were made public, North America and Europe learned about the human kingdom of Colombia. A Coalition Embassy, complete with honor guard, has flown to Colombia on a Death Head's Transport. Talks regarding trade and a possible military agreement are currently underway. The Coalition envoys have not been able to repress their distaste for the use of magic and the tolerance of D-Bees found in Colombia, but they still have found that this country shares so many beliefs with the CS that it cannot be ignored. If nothing else, limited trade will begin after the talks are over. A military alliance between the CS and Colombia will achieve little in the short run — the two nations are too far away from each other to offer quick military or economic assistance. In the future, however, Colombia would make an excellent staging point for an invasion of Atlantis or the Vampire Kingdoms in Mexico!

## La Fortaleza — Colombia

**Population:** 150,000 (120,000 humans, 25,000 dwarves, 2,000 lizard men, 3,000 assorted humanoid D-Bees). All speak Spanish, 50% (100% among the dwarves) are literate, 40% also speak Creole, 30% speak Dragonese/Elven, and 60% of the Dwarves also speak the Dwarf language (many have forgotten it over the centuries).

An additional 80,000 people live in neighboring farming villages. A military base (5,000 soldiers) is on a hill overlooking the city from the west.

La Fortaleza (the Fortress, pronounced **For-tah-leh-zah**) is the capital city of Colombia. The city was built 120 years ago, at the height of the Vampire Wars, because the former capital was considered to be indefensible. La Fortaleza is built on a high plateau protected by a network of concrete bunkers and gun emplacements. La Fortaleza has been besieged seven times over the last century (the last one occurred in 99 P.A.), but it has never been taken.

Besides holding the government offices, the city is also the major industrial center for the nation, producing most of the construction and agricultural machinery, medicines, and, of course, weapons and armor of Colombia. There are several smiths, magic shops, vehicle repair garages, and general stores. Many entertainers ply their trade in the city, distracting the people from their worries and fears. There are four theaters where stage plays and old **pre-rifts** films are shown. The Six Families all have large mansions on the hills at the top of the city, although most of the family leaders live away from the city in their plantations.

Colombia uses the same "credits" that exist in North America (the credit was a form of international currency before the Rifts), but barter and precious metals are the most common means of exchange. Gold, silver and bronze coins are also used to this end. Colombian coins include the bronze centavo (1 credit), silver reales and coronas ("royals" and "crowns," worth 5 and 10 credits respectively), and gold guineas and pounds, worth 50 and 100 credits respectively. Player characters trying to sell those coins for their metal content will **find** that their actual worth is about 30% their currency worth — the coins are debased, a typical government ploy (then again, paper money has even less "real" worth in the 20th century).

Despite the constant dangers threatening the city, its population and rulers have tried to make it an attractive place to live. The city has several parks and plazas where festivals are celebrated approximately once a month. During these festivals or "carnivals," most businesses (except those who deal in food and entertainment) close their doors, the people dress in gaudy costumes, and they party through the streets until well past dawn. Dancing and drunken revelries are common, as are brawls, but deadly violence is rare, and quickly stamped out by the authorities. During the carnivals, both the Security Division and the Fire Department go to full alert, because sometimes the parties devolve into mini-riots and also because vampires may attempt to infiltrate the city during the celebrations.

La Fortaleza is also the only place where the dreaded **anti-monster warriors** are manufactured. The anti-monsters are the only "altered humans" created by the country, but a large contingent of juicer and crazy mercenaries from the Silver River Republics are on retainer to the Colombian government. Normal 'borgs are very rare in the country, usually mercenaries or adventurers from far-off lands or worlds.

Crime in La Fortaleza is not as widespread as in the Coalition States, but it exists, especially in the low-income areas where gambling, prostitution and racketeering are all too common. A version of the **Black Market** exists in Colombia and engages in the acquisition and sale of stolen military equipment, smuggled goods and weapons from Atlantis, dangerous and outlawed magical items, and illegal drugs, among other things.

There are no body chop-shops, but people who want to modify their bodies can try to find **Doctor Prometheus**, a **Splugorth-trained bio-wizard!** Doctor Prometheus uses bio-wizard microbes, micro-parasites and large parasites (see **Rifts Atlantis**) to endow his clients with superhuman powers. His own body has been enhanced in diverse and unknown ways. Many enhanced gang members owe their powers to the good doctor, and don't mind that many of them die or go insane as a side effect of his "treatments." Doctor Prometheus is also a **Splugorth spy** and his "clinic" (which is constantly being relocated; it never stays in the same place for longer than a few days) houses the occasional Splugorth minion. The doctor is protected by a magic-tattooed **maxi-man** (7th level) called Navaja (the Blade), whose tattoos allow him to create daggers and knives with magical powers, as well as a host of other things.

Despite the Security Division's best efforts, there is also a vampire presence in La Fortaleza. It is limited to one master vampire and 6 to 36 secondary vampires (the number fluctuates as members are killed and more are "recruited"). All are involved in acts of sabotage and terrorism against the military.



These vampires limit their activities, because their main goal is to bring news to their masters in the west. To that purpose, they often try to use their powers to control minor government officials and use them as spies. At any given time, they control 1D6 people with access to secret government information and have a 33% chance of discovering any specific plan (this could be a factor in an adventure if the player characters are doing secret work for the Colombian government).

## La Fortaleza's Police and Military Forces

The city has a para-military police force known as the **Security Division**, as well as Regular Army units stationed in and around the area. Between the two forces, the city has almost 10,000 soldiers, plus another 2,000 to 6,000 volunteers and private guards that can be assembled into a militia in case of an emergency. The regular army often conducts maneuvers around the city and is on constant alert.

## The Security Division

The Security Division (SD) consists of regular police officers and an elite core of highly trained troopers, mages and psychics, able to deal both with regular crime and the vampire threat. They are fairly efficient, but many officers are not above taking bribes from the Black Market to look the other way when illegal transactions are conducted. However, the SD will not deal with or compromise themselves where vampires or supernatural beings are involved. The fool who dares to associate with such monsters is considered a traitor and is executed or has a deadly accident. 90% of the SD's members are fanatical in their hatred of vampires, demons and other supernatural forces. About 75% have similarly strong feelings toward monstrous looking D-Bees.

### Statistical Data: A Typical Security Division Officer

**Average level of experience:** Second to sixth level.

**Standard Body Armor:** Patrolmen wear grey Plastic-Man armor (35 M.D.C.). Field troops and special operatives wear Bushman armor or the equivalent (M.D.C. 60).

**Standard Weapons:** RC-10 laser pistol, RC-10 laser rifle, 9 mm automatic pistol (15 shot clip, 2D6 S.D.C. damage) with at least one clip of silver bullets, a ceramic water pistol, a police baton and a wood crucifix. Additional vampire fighting equipment may be assigned to Special Forces or under special circumstances and can include **techno-wizard** devices and water cannons.

### Unit Breakdown:

**Police:** 3000 police patrol the city streets in groups of 4 to 12. They are usually on foot, on motorcycles or in light APCs. Each unit is commanded by a sergeant.

**Mechanized Division (500 troops):** 160 wear D-20 Light Combat Exo-Skeletons, 90 are clad in D-30 Power Armor, 30 use G-9A robot vehicles and 20 have G-18B heavy robot vehicles plus 30 Lancero Light Tanks/Riot Vehicles.

**Anti-Monster Division (120):** Anti-Monsters are typically levels 2 to 7 and frequently work with Special Forces.

**Special Forces (200):** Psychics, mages and priests with military/defense training. Their ranks include 21 mind melters (levels 1-6 — Commander Conrad is 9th level), 32 Military Specialists/Major Psionics (levels 2-6), 46 Military Specialists/Minor Psionics (levels 3-8), 11 bursters (levels 1-6), 18 ley line walkers (levels 2-8), 20 mystics (levels 2-6), 23 techno-wizards (levels 2-6), 14 shifters (levels 2-4), 21 voodoo priests (levels 2-6), and 14 tribal shamans (levels 2-8).

## Colombian 1st Army Corps

The nation's standing army has almost half of all its effectives stationed at La **Fortaleza**. At least once every two years, the First Army sends out large armed expeditions into vampire territory — the government has learned that the best defense is a good offense. These campaigns are bloody affairs, with losses of 5-10% every time. And that is when the campaign is successful! People remember the three expeditions (the last one a mere twenty years ago) that marched into vampire territory... and never returned.

### Statistical Data: Typical Soldiers

**Average level of experience:** Second to seventh level

**Standard Body Armor:** Bushman armor or equivalent (M.D.C. 60), painted in green camouflage patterns.

**Standard Weapons:** RC-C40 Rocket Rifle, ceramic water rifle, six grenades, machine-pistol with silver bullets (3D6 S.D.C.), wood crucifix, and a mallet and 6 to 24 stakes.

### Unit Breakdown:

**Infantry:** 12 Infantry Battalions of 640 troops each (four companies of 160 men make up an infantry battalion) 7,680 men.

**Foreign Legion:** 2000 mercenaries, adventurers, fighters and D-Bee warriors which are kept separated from regular troops. They are used primarily as assault troops (some say as cannon fodder). They include 140 juicers, 150 crazies (mainly meres from the Silver River Republics), 130 wilderness scouts and 100 **headhunters**, 500 lizard men warriors, and assorted non-humans. The Foreign Legion soldiers are always trying to prove themselves to their comrades, and are surprisingly brave fighters.

**Mechanized Division:** 2000 troops divided into 800 D-20 Light Combat Exo-Skeletons, 400 D-30 Power Armor, 80 G-9A robot vehicles, and 40 **G-18B** heavy robot vehicles, 50 Lancero Light Tanks/Riot Vehicles, and 24 Glitter Boys.

**Air Support:** 200 troops; 20 **Zancudo** helicopters and 10 ancient **F-15** fighters with light M.D.C. plating (M.D.C. 70).

**Anti-Monster Battalion:** 360 troops divided into 60 squads of 6 anti-monsters each. The squads are assigned to larger units as reconnaissance teams, seek and destroy squads and as special operatives. Or they can be combined as a single shock force — over three hundred charging Anti-Monsters is enough to destroy most foes. Most are 4th to 7th level.

**Magical Battalion:** 286 troops. Current personnel include 43 ley line walkers, 23 mystics, 46 voodoo priests, 36 medicine men, 21 warlocks, 41 tribal shamans, 32 **techno-wizards**, 21 **biomancers**, 14 shifters, and 9 temporal wizards. These magicians are all 4th to 7th level.

**Psychic Battalion:** 315 troops. Current personnel include 28 mind melters, 14 bursters, 21 mind bleeders, 32 **psi-stalkers**, 64 major psionics (headhunters and special forces O.C.C.s), 82 minor psionics (same O.C.C.s), 43 mutant animals and 31 assorted D-Bees with psychic powers. These soldiers are all 3rd to 7th level.

---

## Other Places of Note

Listed below are other major cities in Colombia.

---

## Camargo

**Population Breakdown:** 100,000 (Humans 55,000, dwarves 25,000, lizard men 15,000, elves 3,000, plus 2,000 other D-Bees)

Camargo is the second largest city in the Republic of Colombia. It is also notable for having one of the largest concentrations of non-humans. Located near the eastern coast, it is a major trade and industrial center. Most of the weapons and equipment that are not produced in La Fortaleza are made here. Furthermore, almost all the products imported from other nations (mostly imports from the **Bahia** Kingdom, Maga Island and the Silver River Republics) pass through this city on their way to the capital and distribution throughout the nation.

The city is best known for its center of magical studies, simply known as The University (La Universidad). The University has some very powerful wizards among its faculty (no less than a dozen 10th level or higher mages). **Techno-Wizardry**, standard magic, elemental magic, voodoo rituals and even some **biomancy** are all taught at The University. Most of the teaching has a military inclination because magic is one of the chief weapons used in the defense of the Republic.

Besides being the site of the University, **Camargo** is not very different from La **Fortaleza**, only smaller and not as well-protected. Its police force is about the same size as La **Fortaleza**'s, and there is an army base near the city with some 5,000 troops.

## Ciudad Bolivar

**Population Breakdown:** 90,000 approximate total population: 70,000 humans, 15,000 dwarves, 3,000 lizard men, and 2,000 others. This doesn't include the transient/visitor population (mostly foreign sailors and merchants) of about 2D6x1000 people at any given time.

Ciudad Bolivar is on the easternmost part of Colombia and is one of the largest trading ports in the country. Most of the trade from the Silver River Republics arrives here first. The city is also the headquarters of the Colombian Navy. These factors have made Ciudad Bolivar a prosperous town where just about anything that's for sale can be found. There is even a small — and indirect — trade of **Atlantean** items, purchased from merchants who in turn purchase from the Pirate Kingdoms, clients of the **Splugorth's Atlantis**.

The city has a crime problem in the dock areas and in the poorer districts. Many savage crime gangs fight each other and

the authorities on a weekly basis. They deal in drugs, forbidden and dangerous magic (**bio-wizardry**) and other illegal goods. The most notorious gang-bangers, **The Caribs**, have the custom of piercing their noses with sharpened bones (often human) and are rumored to practice ritual cannibalism. They are said to be led by some sort of monstrous D-Bee or even a **vampire!**

## Bonito Frontier City/Port

**Population Breakdown:** 41,000 approximate total population: 25,000 humans, 7,500 lizard men, 2,500 dwarves, and 6,000 D-Bees.

Located on the South coast of Colombia, Bonito has a large population of non-humans, including the largest colony of ogres known in South America (800 individuals). It is also the home of even stranger creatures, including **adarok**, **zembahk**, **erta**, **Shaydor Spherians** and the occasional Intel, renegade Kittani, giants and aliens (see **Rifts Atlantis** for many of these creatures).

The city is very independent and the central government doesn't have a large military presence here (only two infantry battalions totalling 700 to 800 soldiers), making Bonito the equivalent of a free port. The city has a large militia of about 4,000 troops, nearly half of them D-Bees, which protect it from outsiders. In general, the populace is tolerant of non-humans, so many D-Bees in the country unwilling to take their chances in the other nations of South America, have ended up settling in Bonito.

Bonito is also the only port that deals directly with the Pirate Kingdoms, selling and buying products of dubious origins.

---

# Weapons & Armor of Colombia

---

Besides the weapons listed in this section, Colombia's dealings with the Silver River Republics enables them to acquire many energy weapons and powered armor suits identical to or similar to the ones found in North America. For example: There is an Argentinean series of laser weapons sold in Colombia that closely resemble **Wilk's** products. Rail guns and grenades identical to North American models (Northern Gun, Iron Heart and others) are also available. In addition, there is an ample supply of archaic S.D.C. firearms; mostly pistols, rifles and machineguns, as well as bow weapons, blow guns, swords, machetes, knives, and hatchets.

Over the last few years, some indirect trade via pirates has begun between the residents of the **Splugorth's Atlantis** and the Republic of Colombia. Some merchants and adventurers trade with the Pirate Kingdoms (described elsewhere). The pirates gladly exchange slaves and other goods for Atlantis made weapons and armor; mostly Kittani exports. As a result, elite units, mercenaries and private individuals may have access to Kittani plasma swords, energy weapons, rail guns, Kittani Explorer armor and **Manling** power armor, as well as a few vehicles, lesser

rune weapons, bio-wizardry, and robots. As usual, however, the Kittani reserve their best equipment for their own use, so they are not usually for sale (if they are, they are extremely expensive). See **Rifts Atlantis** for information about Atlantean technology.

## RC-10 Laser Pistol

This is a low-powered laser gun that represents the best that can be produced with local technology. It is popular with street gangs and is the standard issue weapon of local police forces. Most serious soldiers disdain its use due to its low penetration power/damage.

**Weight:** 2 lbs (0.9 kg)  
**Mega-Damage:** 1D6M.D.  
**Rate of Fire:** Standard  
**Effective Range:** 1000 feet (305 m)  
**Payload:** 20 shots  
**Market Cost:** 9,000 credits

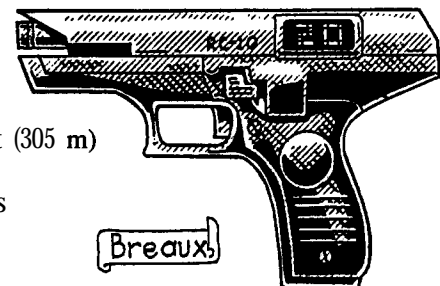

## RC-15 Laser Rifle

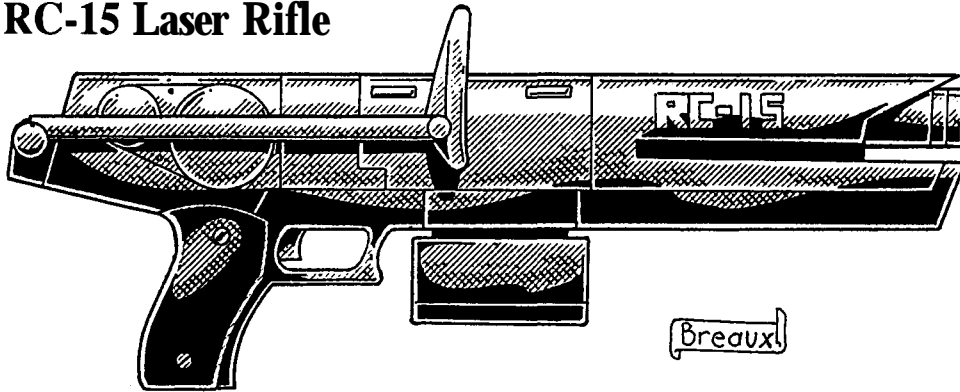

This rifle is the standard issue weapon of the Colombian army. It is heavier than average, lacks many of the capabilities of North American or European weapons and has very short range for a rifle, but can take a beating, holds up well in the hot and humid jungle and has excellent stopping power. Many think of it as an energy shotgun.

**Weight:** 21 lbs (9.5 kg)  
**Mega-Damage:** 3D6+6 M.D.  
**Rate of Fire:** Standard  
**Effective Range:** 1000 feet (305 m)  
**Pay load:** 20 shots  
**Market Cost:** 14,500 credits.

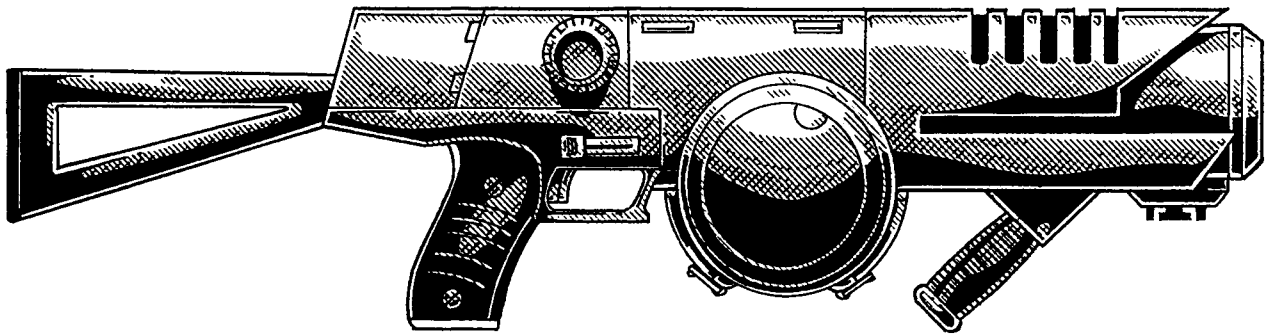

## Dragon-1 Plasma Projector

A heavy plasma cannon similar to the Coalition's C-27 (see Rifts, page 203), minus the targeting scope and with a lighter charge. Usually distributed to Anti-Monsters or heavy weapon squads.

**Weight:** 21 lbs (9.5 kg)  
**Mega-Damage:** 5D6M.D.  
**Rate of Fire:** Standard  
**Effective Range:** 1200 feet (366 m)  
**Payload:** 12 shots  
**Market Cost:** 20,000 credits

## RP-C20 Rocket Pistol

An invention based on an Argentine Empire's pre-Rifts prototype. The weapon fires self-propelled ammunition. The gun has a gas propellant tank that ejects the rockets at bullet speed, then once it is airborne, air vents on the nose of the bullet ignite the jet fuel inside it, turning it into a fast rocket with an explosive tip. Rocket bullets have very good range and penetration. "C" series weapons are only manufactured at Camargo, where an Argentinean-sponsored weapons factory survived the Coming of the Rifts.

**Weight:** 4 lbs (1.8 kg)

**Mega-Damage:** 3D6 M.D. standard explosive round. Wooden warheads (for anti-vampire purposes) inflict 1 M.D. point to normal targets, but do 4D6 damage to vampires.

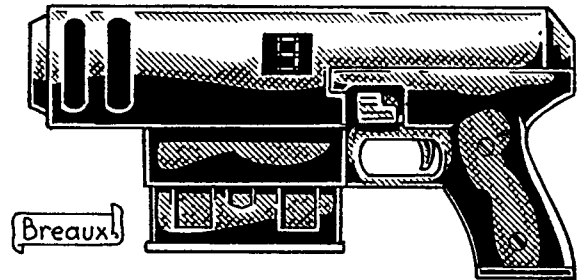

**Rate of Fire:** Standard  
**Effective Rocket Range:** 1200 feet (366 m)  
**Payload:** 9 shots  
**Market Cost:** 14,000 credits for the pistol; 80 credits per standard explosive round or 50 credits per wooden warhead round.



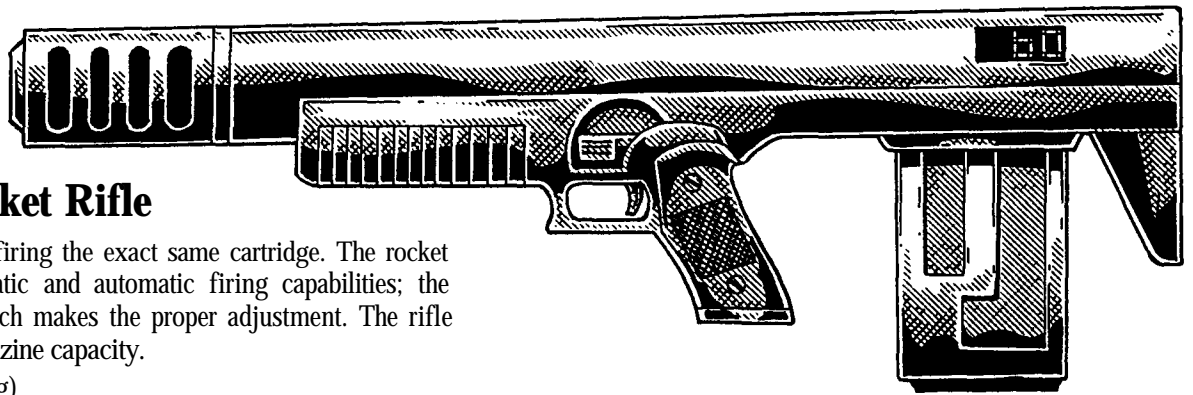

## RR-C40 Rocket Rifle

The rifle version, firing the exact same cartridge. The rocket rifle has semi-automatic and automatic firing capabilities; the flip of a selector switch makes the proper adjustment. The rifle also has a larger magazine capacity.

**Weight:** 21 lbs (9.5 kg)

**Mega-Damage:** A single round inflicts 3D6. A burst is 10 shots and does 1D4X10 M.D. Wooden warheads (for anti-vampire purposes) inflict 1 M.D. point to normal targets (1D4 M.D. on a burst), but does 4D6 damage to vampires or 1D6X10 on a burst.

**Rate of Fire:** Standard

**Effective Range:** 1200 feet (366 m)

**Payload:** 60 or 100 shot ammo clip

**Market Cost:** 35,000 credits for the rifle; 80 credits per standard round or 50 credits per wooden warhead round.

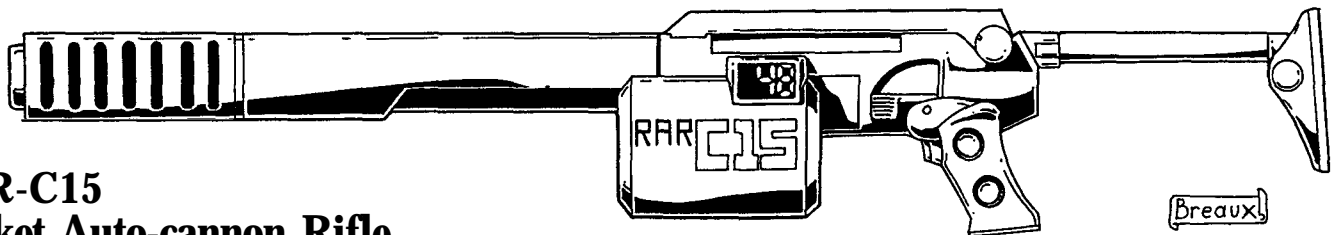

## RAR-C15 Rocket Auto-cannon Rifle

A slightly smaller and lighter, rifle version of the heavy tripod weapon. Its use is limited to robots, cyborgs, power armor troops and characters with a P.S. of 24 or greater. Characters with a lower P.S. cannot use the RAR-C15 because it is too heavy (-10 to strike and can barely be lifted and aimed) — unless it is mounted on a vehicle or tripod and manned by two operators with a combined P.S. of 24 or greater. When fighting vampires, the gun is loaded with solid wood warheads.

**Weight:** 50 lbs (22.68 kg)

**Mega-Damage:** A single round inflicts 3D6+5. An eight round short burst does 1D4X10 M.D.; a long burst is 20 rounds and inflicts 2D4X10 M.D. Wooden warheads (for anti-vampire purposes) inflict 1 M.D. point to normal targets (1D4 M.D. on a burst), but does 4D6 damage to vampires or 1D6X10 on a short burst and 2D6X10 on a long burst.

**Rate of Fire:** Standard

**Effective Range:** 2000 feet (610 m)

**Payload:** 200 round belt (allowing for ten long bursts or 25 short bursts). A 48 round magazine can be substituted if so desired (that's six short bursts, or two long bursts and one short).

**Market Cost:** 65,000 credits

## RA-C15 Rocket Auto-cannon

A larger, crew-served, heavy weapon used either in vehicles or as the tripod-mounted support gun of a squad. A rifle model (RAR-C15) is often carried by the anti-monster and other cyborgs and exo-skeleton troopers. The RA-C15 (and RAR-C15) uses a larger rocket than the standard rifle model and can use either a long magazine or a belt fed ammo drum. A typical crew is a two or three man team with a combined strength of 30. This weapon has superior firepower and range.

**Weight:** 70 lbs (31.7 kg)

**Mega-Damage:** A round does 4D6 M.D. An eight round short burst inflicts 1D6X10 M.D. A long burst is 20 rounds and inflicts 2D6X10 M.D.; wooden warheads (for anti-vampire purposes) inflict 2 M.D. points to normal targets (2D6 M.D. on a long burst), but do 6D6 damage to vampires or 2D6X10 on a short burst or 3D6X10 on a long burst.

**Rate of Fire:** Standard

**Effective Range:** 2600 feet (792 m)

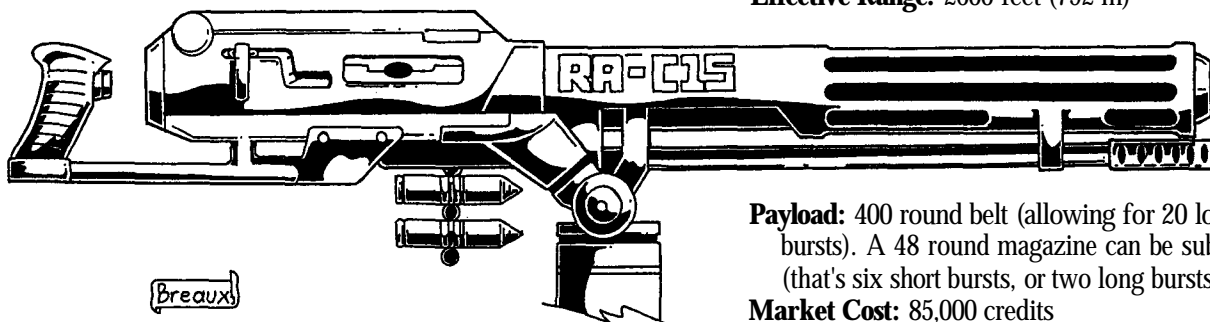

**Payload:** 400 round belt (allowing for 20 long bursts or 50 short bursts). A 48 round magazine can be substituted if so desired (that's six short bursts, or two long bursts and one short).

**Market Cost:** 85,000 credits

# Colombian Robots & Power Armor

Colombia is able to manufacture simple types of power armor and robots. These power armor suits have most of the basic features described in the **Rifts RPG**, pages 211-212. Nuclear power systems, however, are NOT available and all Colombian-made power armor and robots run on **rechargeable batteries**. Colombian armies travel with trucks carrying gasoline-powered generators to recharge the armored troops and bots. Adventurers rarely buy robots and power armor of Colombian manufacture because of this disturbing shortcoming (most foreigners and mercenaries prefer the more expensive models available from the Silver River Republics). However, the Colombians have learned to work within the limitations of their mechanical creations and are a formidable force.

## D-20 Light Combat Exo-Skeleton

This is a light suit of battery-driven armor. It offers only twice the protection of normal body armor but also provides enhanced strength and has all the basic features common to power armor suits.

**Model Type:** D-20 Exo-Skeleton

**Class:** Armored Infantry Assault Suit (Light)

**Crew:** One

**M.D.C. by Location:**

Arms (2) — 50 each

Rocket Gun (1) — 50

Backpack Magazine Dispenser — 100

\* Head — 60

\*\* Main Body — 150

Legs (2) — 60 each

\* Destroying the head has a 1-70% chance of knocking the pilot unconscious. If conscious, the pilot has two problems: one, he has no power armor combat bonuses to strike, parry and dodge, and two, the human head is now vulnerable to attack. The head can only be hit when a character makes a called shot and even then the attacker is -3 to strike.

\*\* Depleting the M.D.C. of the main body will shut the armor down completely, making it useless.

**Speed:**

**Running:** 50 mph (80 km) maximum. Note that the act of running does tire out its operator, but at 20% of the usual fatigue rate thanks to the **exo-skeleton**.

**Leaping:** 10 feet (3 m) high and lengthwise; double from a running start.

**Flying:** Not possible.

**Range:** The battery has a 12 hour charge, which gives the suit a maximum range of 600 miles (960 km) if running in a straight line for the entire 12 hour period. Typically, effective range will be 100 to 200 miles (160-320 km).

**Statistical Data:**

**Height:** 7 feet (2.1 m)

**Width:** 3 feet (0.9 m)

**Length:** 3 feet (0.9 m)

**Weight:** 180 lbs (81.5 kg)

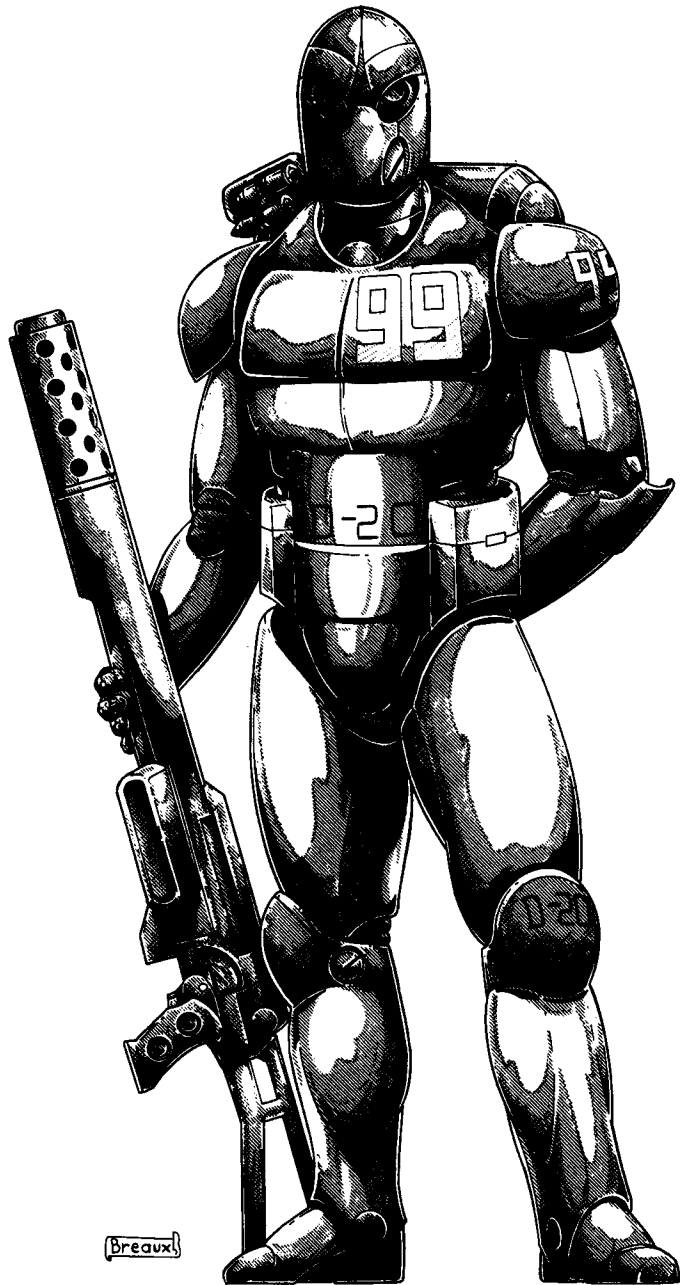

**Physical Strength:** Equal to a P.S. 24

**Cargo:** None

**Power System:** Battery with 12-hour life. Can be recharged by any power plant. When the last of the energy is used up, the augmented strength and weight dispersment is gone and the character can barely move — one attack per melee, no combat bonuses, and a speed of 2! It even takes two minutes to unsuit without power.

**Recharge:** Four hours are needed to fully recharge. Most generators designed for recharging power armor suits can recharge **five** suits simultaneously.

**Market Cost:** 150,000 credits

## Weapon Systems

**1. RAR-C15 Rocket Auto-cannon Rifle:** Rifle version of the heavy tripod weapon used by cyborgs and power armor troops. When fighting vampires, the gun is loaded with solid wood warheads.

**Primary Purpose:** Anti-personnel

**Secondary Purpose:** Defense.

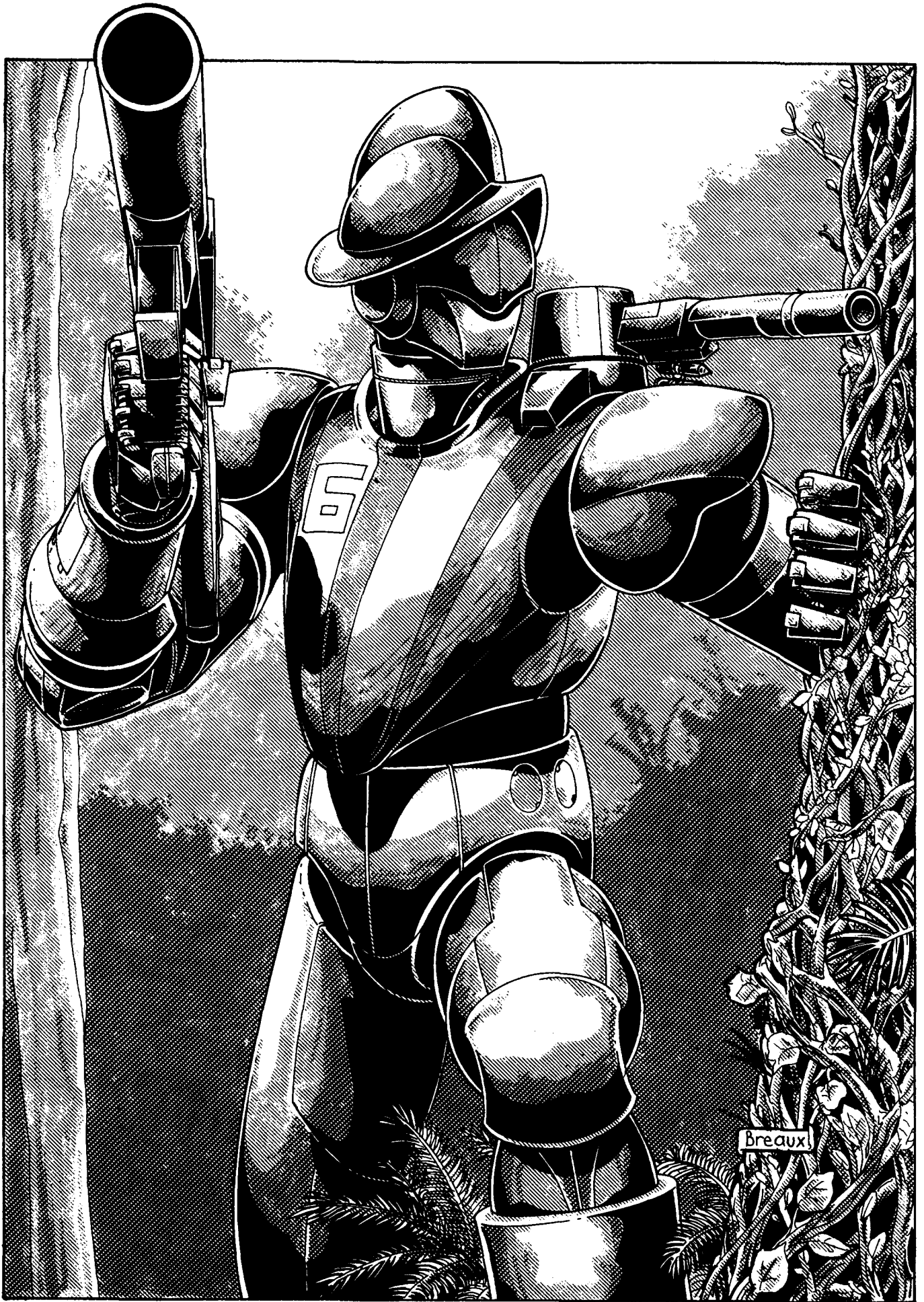

Weight: 50 lbs (22.68 kg)

Mega-Damage: A single round inflicts 3D6+5. An eight round short burst does 1D4X10 M.D.; a long burst is 20 rounds and inflicts 2D4X10 M.D. Wooden warheads (for anti-vampire purposes) inflict 1 M.D. point to normal targets (1D4 M.D. on a burst), but does 4D6 damage to vampires or 1D6X10 on a short burst and 2D6X10 on a long burst.

Rate of Fire: Standard

Effective Range: 2000 feet (610 m)

Payload: 200 round belt fed drum (allowing for ten long bursts or 25 short bursts). A 48 round magazine can be substituted if so desired (that's six short bursts, or two long bursts and one short).

**2. Hand to Hand Combat:** Rather than use a weapon, the pilot can engage in mega-damage hand to hand combat. See Power Armor Combat Training in the **Rifts RPG** for specifics.

## D-30 "Conquistador" Power Armor

This is a heavy infantry power armor designed to resemble the ancient Conquistador armor worn by Spanish warriors in their conquest of South America. This burnished, grey metal armor is large and intimidating. In terms of protection, it rivals the Northern Gun Samsom armor from North America. It is very heavily armed, with a repeating bazooka, a shoulder-mounted machinegun, and a missile launcher.

**Model Type:** D-30 Armor Suit

**Class:** Armored Infantry Assault Suit

**Crew:** One

**M.D.C. by Location:**

Arms (2) — 80 each

Legs (2) — 100 each

Mini-Missile Launchers (2; forearms) — 35 each

Hand-held Auto-loading Bazooka — 80

Shoulder Rocket Gun — 40

Backpack Ammo Dispenser — 120

\* Head — 95

\*\*Main Body — 230

\* Destroying the head has a 1-70% chance of knocking the pilot unconscious. If still conscious, the pilot has two problems: one, no power armor combat bonuses to strike, parry and dodge, and two, the human head is now vulnerable to attack. The head can only be struck when a character makes a called shot and even then the attacker is -3 to strike.

\*\* Depleting the M.D.C. of the main body will shut the armor down completely, making it useless.

**Speed:**

Running: 60 mph (96 km) maximum. Note that the act of running does tire out its operator, but at 10% of the usual fatigue rate thanks to the robot **exo-skeleton**.

Leaping: 12 feet (3.65 m) high and lengthwise; double from a running start.

Flying: Not possible.

Range: Batteries have a 10-hour charge. Maximum range while running full tilt for 10 hours would be roughly 600 miles (960 km), but practical range is 100 to 200 miles (160-320 km).

**Statistical Data:**

Height: 10 feet (3.0 m)

Width: 6 feet (1.8 m)

Length: 5 feet (1.5 m)

Weight: 900 lbs (408 kg)

Physical Strength: Equal to a P.S. 30

Cargo: None.

Power System: Battery with 10-hour charge. Can be recharged from any power plant.

Market Cost: 240,000 credits

## Weapon Systems

**1. Auto-loading Bazooka:** This is a big, magazine-loaded, bazooka-like recoilless rifle. In the fight against vampires, the Colombian armorers have developed a special fragmentary warhead with a hardwood casing. On impact, the explosion flings large wood splinters in every direction.

Primary Purpose: Anti-Vehicle and/or Anti-Personnel

Secondary Purpose: Defense

Mega-Damage: Fires either fragmentary, armor-piercing or wood-fragment unguided rockets. Anti-armor rockets do 1D6X10+20 M.D. to a 3 foot (0.9 m) radius, fragmentary rockets inflict 6D6 M.D. to a 20 foot (6.1 m) radius, and wood-fragment warheads inflict 1 M.D. point to a 20 foot (6.1 m) radius — vampires caught in the blast take 1D6X10 M.D.

Rate of Fire: Can fire twice per melee round; a new rocket is cycled into the gun in approximately 6 seconds or so.

Effective Range: 1200 feet (366 m)

Payload: 12 shot drum magazine. Reloading the drum will take 1D4 minutes.

**2. Arm-Mounted Mini-Missile Launchers:** The forearms have two mini-missiles for long-range attacks.

Primary Purpose: Anti-Personnel and/or Anti-Aircraft

Secondary Purpose: Defense

Mega-Damage: Varies with missile type.

Rate of Fire: One or two missiles.

Effective Range: About one mile (1.6 km).

Payload: Four total; two missiles per each arm.

**3. Shoulder-Mounted Rocket Gun:** The Conquistador's primary weapon is a rocket machinegun, slaved to a sighting system inside the suit's helmet. The weapon is fed by an ammo dispenser backpack.

Primary Purpose: Anti-Personnel

Secondary Purpose: Defense

Mega-Damage: A round does 4D6 M.D. A 10-round burst inflicts 1D4X10+6 M.D. A long burst is 40 rounds and inflicts 2D4X10+10 M.D. Wooden warheads for anti-vampire purposes inflict 2 M.D. points to normal targets (2D6 M.D. on a burst, 3D6 M.D. on a long burst), but do 5D6 damage to vampires and 2D4X10 on a short burst and 3D6X10 on a long burst.

Rate of Fire: Standard.

Effective Range: 2000 feet (610 m)

Payload: 2,000 rounds in the backpack dispenser.

**4. Hand to Hand Combat:** Rather than use a weapon, the pilot can engage in mega-damage hand to hand combat. See Power Armor Combat Training in the Robot Combat section in the **Rifts RPG** rule book.



# G-9A "Jaguar" Light Robot Vehicle

The G-9A is a giant, humanoid bot with a sculpted feline face and retractable vibro-claws in its fingers. The "Jaguar" is a very fast and mobile robot built with pre-rifts technology; some suits were actually built before the Great Cataclysm — excavated from ancient ruins (new power supplies have been installed). They are very expensive, because the nuclear power plants they require have to be imported from the Silver River Republic or other high-tech manufacturers, but they are worth it.

**Note:** Over the last few years, a mysterious private purchaser has bought over a hundred of these robots. Unknown to the authorities, this buyer was from the city of Omagua. The mutant felines who inhabit that city love the robot's design and it has become a part of that city's defense forces.

**Model Type:** G-9A

**Class:** Ground Infantry Assault Robot

**Crew:** One pilot and can accommodate three passengers.

**M.D.C. by Location:**

Shoulder Missile Launchers (2) — 100 each

\*\*\* Eye Laser Cannons (2) — 25 each

20 mm Auto-cannon in Left Arm — 120

**Head** — 100

Hands (2) — 60 each

Arms (2) — 150 each

Legs (2) — 220 each

\*\* Main Body — 320

Reinforced Pilot's Compartment — 100

\*\* Depleting the M.D.C. of the main body will shut the armor down completely, making it useless.

\*\*\* The eye laser cannons are small and difficult targets to hit, requiring a called shot at -2 to strike.

**Speed:**

**Running:** 90 mph (144 km) maximum

**Leaping:** The bot can leap up to 20 feet (6.1 m) high or across.

Add 10 feet (3.0 m) with a running start.

**Statistical Data:**

**Height:** 21 feet (6.4 m)

**Width:** 11 feet (3.4 m)

**Length:** 7 feet, 2 inches (2.2 m)

**Weight:** 18 tons (16,200 kg) fully loaded.

**Physical Strength:** Equal to a P.S. 40

**Cargo:** Minimal storage space; about four feet (1.2 m) for extra clothing, weapons, and personal items.

**Power System:** Nuclear; average energy life is 20 years.

**Market Cost:** 25 million credits.

## Weapon Systems

**1. 20 mm Auto-cannon:** This is a multi-barreled, Vulcan-style auto-cannon that fires explosive shells at a very high rate. Ammo is stored in the arm and main body. The gun is mounted in the left forearm, but its barrel is far enough back to allow the Jaguar to engage in hand to hand combat without interference from the weapon.

**Primary Purpose:** Anti-Vehicle

**Secondary Purpose:** Defense

**Mega-Damage:** A burst is 40 rounds and does 2D4X10 M.D.; can only fire bursts. The gun can also fire special wooden rounds

for anti-vampire purposes: damage becomes 2D6 M.D. per burst, but they inflict 2D6X10 H.P. to vampires.

**Rate of Fire:** Equal to the number of hand to hand attacks of the pilot (usually 4-6)

**Effective Range:** 4000 feet (1220 m)

**Payload:** 4,000 rounds in the arm. A built-in magazine in the body has an additional 12,000 rounds that will automatically reload the arm magazine when it is empty (takes one melee round/15 seconds). Reloading these ammo dispensers requires special equipment and takes about an hour.

**2. Laser Eye Beams (2):** The robot's "eyes" are actually two powerful lasers. These beams always fire as a single unit.

**Primary Purpose:** Anti-Robot and Anti-Aircraft.

**Secondary Purpose:** Defense

**Mega-Damage:** 6D6 M.D. per dual blast. If one eye is disabled, damage is reduced to 3D6 M.D.

**Rate of Fire:** Equal to number of combined hand to hand attacks (usually 4-6)

**Effective Range:** 4000 feet (1220 m)

**Payload:** Effectively unlimited.

**3. Mini-Missile Launchers (2):** The shoulders of the Jaguar have two mini-missile launchers.

**Primary Purpose:** Anti-Personnel and Anti-Aircraft.

**Secondary Purpose:** Defense

**Mega-Damage:** Varies with missile type.

**Rate of Fire:** One at a time or volleys of two, four, eight, sixteen or thirty-two missiles!

**Effective Range:** About one mile (1.6 km).

**Payload:** 32 total mini-missiles; 16 in each launcher.

**4. Hand to Hand Combat:** Rather than use a weapon, the pilot can engage in mega-damage hand to hand combat. The special design provides the Jaguar with the following bonuses and damage capabilities:

**Bonuses:** One additional melee attack/action at levels one, three, seven and 12. +1 on initiative, +1 to strike, +2 to parry, dodge, pull punch and roll with impact.

**Damage:**

Restrained Punch: 1D4 M.D.

Full Strength Punch: 2D6 M.D.

Claw Strike: 4D6 M.D.

Power Punch: 4D6 M.D. (counts as two melee attacks)

Power Claw Strike: 6D6 M.D. (counts as two melee attacks)

Kick: 2D4 M.D.

Leap Kick: 3D6 M.D. (counts as two attacks)

Stomp or Body Flip: 1D4 M.D.



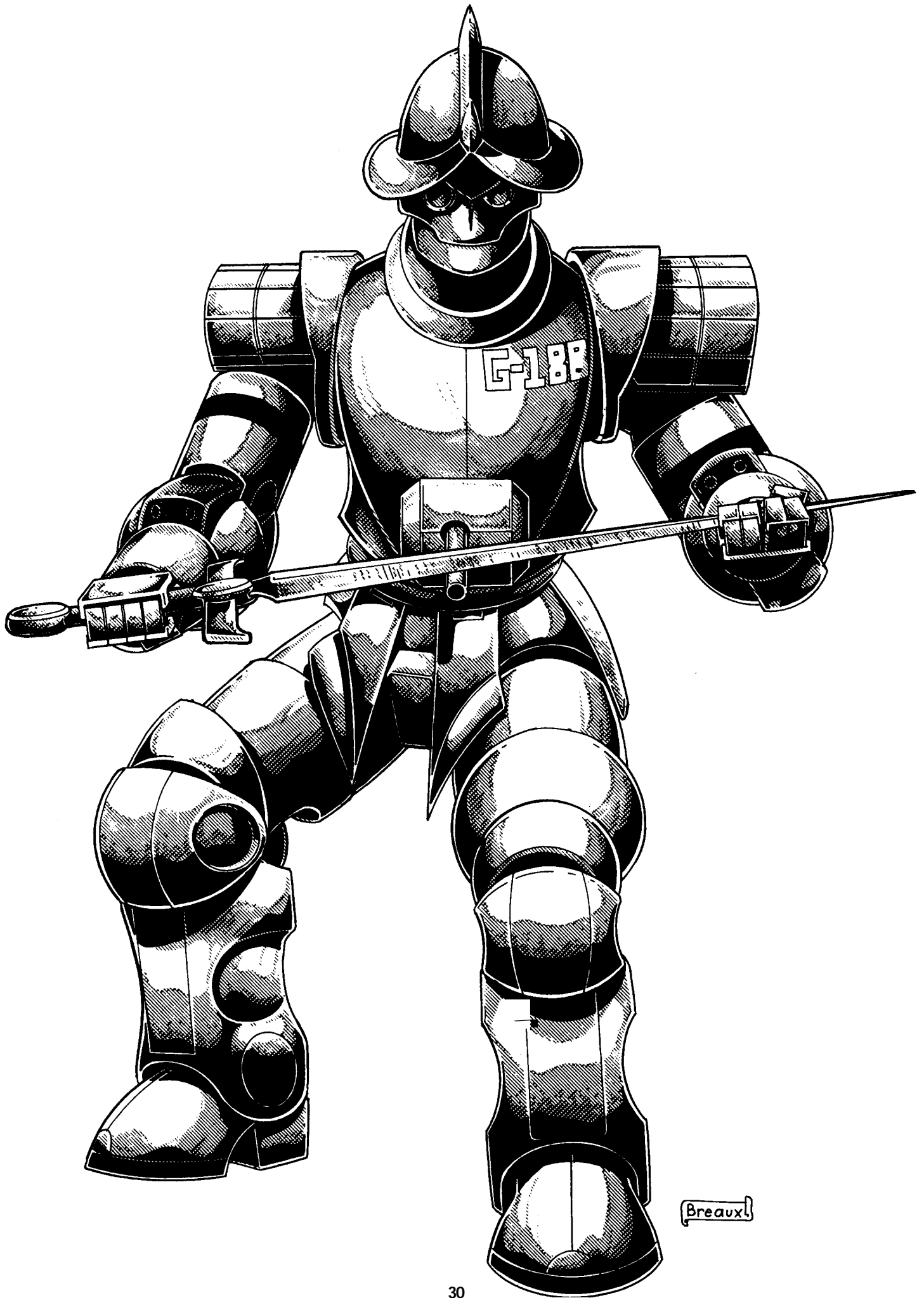

Breaux

# G-18B “Aguirre” Heavy Combat Robot

This robot vehicle is named after an infamous Spanish explorer and soldier known for his atrocities and fierceness. The Aguirre is built along the same lines as the Conquistador power armor, only twice the size. This heavy robot is best known for the giant vibro-sword it wields in hand-to-hand combat. Special anti-vampire units have special silver-plated blades that inflict massive damage to the undead.

**Model Type:** G-18B

**Class:** Ground Infantry Assault Robot

**Crew:** One pilot and can accommodate four passengers.

**M.D.C. by Location:**

Giant Vibro-Sword — 200

Belly Rocket Auto-cannon — 150

Shoulder Missile Launchers (2) — 140 each

Forearm Lasers (2) — 90 each

**Head** — 100

Hands (2) — 50 each

Arms (2) — 160 each

Legs (2) — 240 each

\*\* **Main Body** — 380

Reinforced Pilot's Compartment — 100

\*\*Depleting the M.D.C. of the main body will shut the robot down completely, making it useless.

**Speed:**

Running: 60 mph (96 km)

Leaping: The powerful robot legs can leap up to 15 feet (4.6 m) high or across. Add 10 feet (3.0 m) with a running start.

**Statistical Data:**

Height: 27 feet (8.2 m)

Width: 15 feet (4.6 m)

Length: 10 feet (3.0 m)

Weight: 21 tons (19,407 kg) fully loaded

Physical Strength: Equal to a P.S. 44

Cargo: Minimal storage space; about four feet (1.2 m) for extra clothing, weapons, and personal items.

Power System: Nuclear; average energy life is 15 years.

Market Cost: 30 million credits.

## Weapon Systems

**1. Rocket Auto-cannon:** A Vulcan-style rocket gun is mounted on the belly. It is used mostly against small ground targets like infantrymen and light vehicles. It can also use special anti-vampire ammunition.

Primary Purpose: Anti-Personnel

Secondary Purpose: Defense.

Mega-Damage: A burst is 10 rounds and does 1D6X10 M.D. The belly gun can only fire bursts. Anti-vampire rounds fire wooden rocket shells that inflicts 2D4X10 hit points (H.P.) to vampires.

Rate of Fire: Equal to the pilot's combined number of hand to hand attacks (usually 4-6).

Effective Range: 4000 feet (1220 m)

Payload: 4,000 rounds; that's 400 bursts!

**2. Medium Range Missile Launchers (2):** Two missile launchers are built into the robot's shoulders. They are used for long range bombardment or against flying targets.

Primary Purpose: Anti-Aircraft

Secondary Purpose: Anti-Armor

Mega-Damage: Varies with missile type.

Rate of Fire: One at a time or in volleys of two, three or four.

Effective Range: 40 to 80 miles (64 to 128 km).

Payload: Twelve total; six per each launcher.

**3. Laser Cannons (2):** Two high-powered lasers are built into each forearm.

Primary Purpose: Anti-Personnel

Secondary Purpose: Defense

Mega-Damage: 3D6 M.D. per single blast or 6D6 M.D. for a dual blast (counts as one attack).

Rate of Fire: Equal to the number of hand to hand attacks (usually 4-6).

Effective Range: 4000 feet (1220 m)

Payload: Effectively unlimited.

**4. Giant Vibro-Sword:** A huge two-handed sword (20 foot/6.1 m) is kept attached to the robot's back by a magnetic clamp. When activated, the blade is surrounded by an energy field. This design has been copied from a captured Atlantean weapon. Sometimes the robots are equipped with a non-energy, silver-plated giant sword for anti-vampire purposes.

Mega-Damage: When activated, the sword inflicts 1D6X10 M.D. Without the energy field, the sword is a blunt weapon that inflicts 3D4 M.D. The silver plated sword does 2D4 M.D. to normal targets, but 2D6X10 hit points (H.P.) to vampires!

**5. Hand to Hand Combat:** Rather than use a weapon, the pilot can engage in mega-damage hand to hand combat.

Bonuses: One additional melee **attack/action** at levels one, four, eight and 12. +1 to strike, +3 to strike with sword, +3 to parry, +5 to parry with sword (+1 to parry energy blasts), +2 to dodge, +2 to pull punch, +3 to roll with impact.

Damage:

Restrained Punch: 1D6 M.D.

Full Strength Punch: 3D6 M.D.

Power Punch: 1D6X10 M.D.

Kick: 2D6 M.D.

Leap Kick: 4D6 M.D.

Stomp or Body Flip: 1D6 M.D.

## Lancero Light Tank/APC

The Lancero is a combination **tank/armored** personnel carrier. It is tiny compared to the Coalition and NGR troop carriers, but it does the job of transporting a ten man infantry squad and can act as a fighting vehicle as well. There are several Lancero models, with different weapon systems. The Type A is the most common combat vehicle, the Type B is used in artillery/support roles, and the Type V is a dedicated anti-vampire combat vehicle that can't carry troops — instead, it has a huge water tank and pressure water cannon!

All **Lanceroes** use a gasoline engine (nuclear power plants are very rare and expensive in Colombia), which gives them limited range. Other than that, its mega-damage armor and weapon systems make it comparable to similar North American vehicles. Its balloon tires allow it to traverse broken terrain and float, allowing the vehicle to double as an amphibious vehicle ideal for warfare along rivers and marshes.



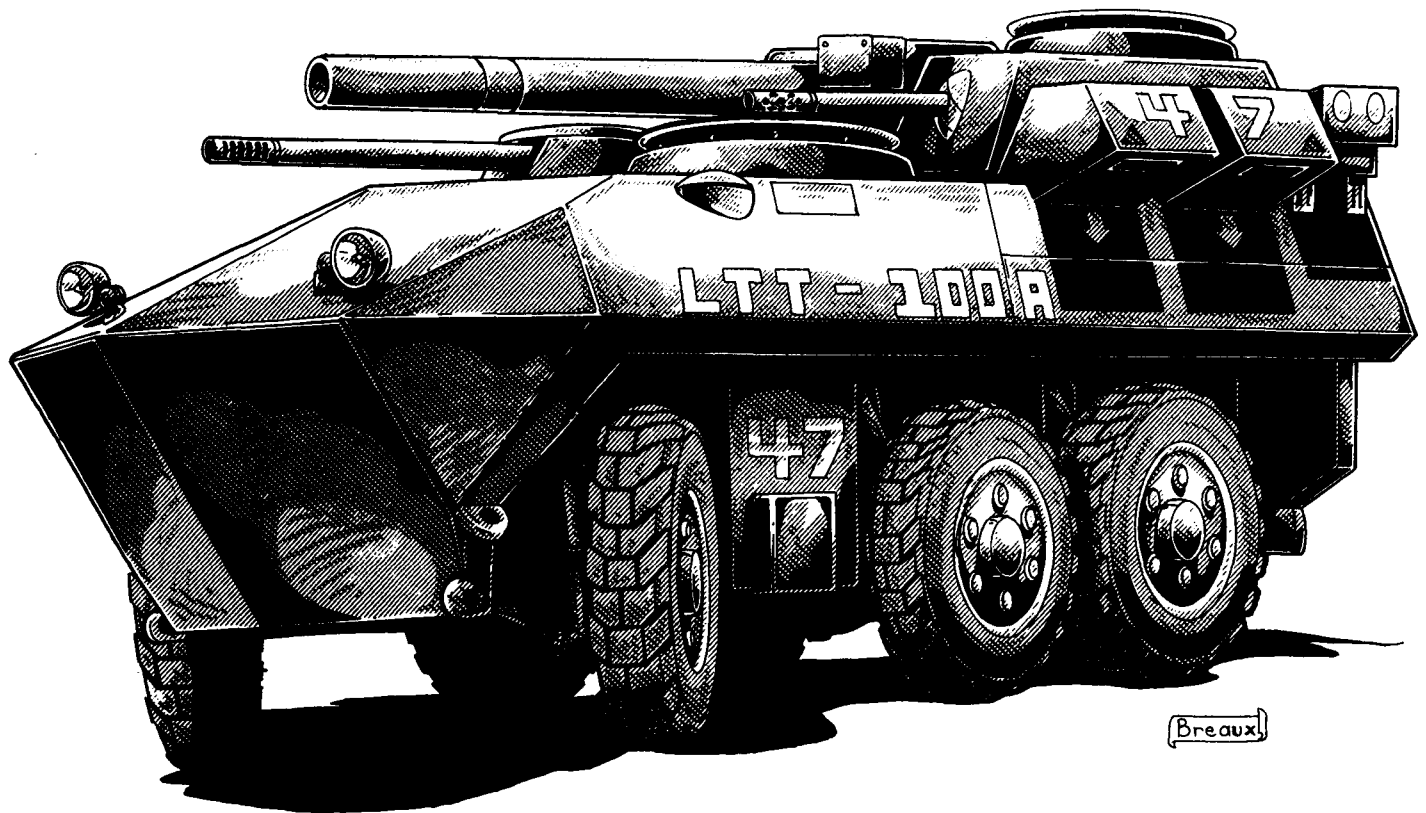

**Model Type:** LTT-100A, LTT-100B and LTT-100V

**Class:** Infantry Assault and Transport Vehicle

**Crew:** Four: pilot, co-pilot, communications engineer and gunner.

**Troop Transport Capabilities:** Up to ten troopers in body armor or light **exo-skeletons**, or six troopers in Conquistador, heavy power armor, or four men in body armor and four in power armor. The troops enter and disembark using a falling door ramp on the back of the vehicle. Type B tanks have a reduced troop bay that can hold up to five men in body armor or three soldiers in power armor. The Type V vehicle has room for only three human-sized passengers.

**M.D.C. by Location:**

Main Turret and Cannon — 200

Side Mini-Missile Launchers (2) — 40 each

Front-mounted Rocket Machinegun — 100

Back Ramp Door — 200

Balloon Tires (6) — 40 each

\*\* Main Body — 300

Reinforced Pilot's Compartment — 100

\*\*Depleting the M.D.C. of the main body will shut the tank down completely, making it useless.

**Speed:**

Driving on the ground: 80 mph (128 km)

Water: 15 mph (24 km)

Range: 600 miles (965 km); it has an extra large gas tank and high efficiency engine.

**Statistical Data:**

Height: 12 feet (3.7 m)

Width: 12 feet (3.7 m)

Length: 21 feet (6.4 m)

Weight: 14 tons (12,698 kg) fully loaded

Cargo: The troop bay can hold up to five tons (4500 kg) of material if used as a transport. Besides that, there is some storage

space; about four feet (1.2 m) for extra clothing, weapons and personal items; 4 rifles, one rocket launcher, and 12 mini-missiles. Type V tanks can hold only about 1 ton (900 kg) of additional material. The rest of the converted troop bay is taken up by the water tank.

Color: Typically camouflage, green, or dark grey.

Power System: Gasoline turbine engine.

Market Cost: 2.1 million credits.

**Weapon Systems**

**1. Main Gun:** There are two types of main guns that can be used. Type A and B tanks are equipped with a 120 mm high-velocity tank gun using several varieties of ammunition. Type V tanks have a powerful water cannon. This weapon is mounted on the turret and can be used by the gunner.

Primary Purpose: Anti-Armor (Types A & B); Anti-Vampire (Type V)

Secondary Purpose: Anti-Personnel (Types A & B); Riot Control (Type V)

Mega-Damage: 120mm Cannon: Varies with ammo type. Either High-Explosive (2D4X10 M.D. to a 20 feet/6.1 m radius) or Armor Piercing Solid Round (2D6X10 M.D.; no blast radius).

Water Cannon: Inflicts only 2D6 S.D.C. damage, but has an 88% chance of knocking human-sized people and robots off their feet (**only** 48% on targets weighing 800 lbs to a ton/360 to 900 kg; no chance against targets weighing more than a ton/900 kg). Against vampires, the water blast does 2D6X10 hit point damage.

Rate of Fire: 1 per melee (Types A & B); six times per melee (Type V).

Effective Range: 6000 feet/1830 m (Types A & B); 500 feet/152 m (Type V)

Payload: 50 120 mm rounds or 600 water blasts.

**2. Coaxial Machinegun:** A light rocket machinegun is mounted next to the main gun on the turret, where it can be operated by the gunner.

Primary Purpose: Anti-Personnel

Secondary Purpose: Defense

Mega-Damage: A short burst is 20 shots and does 4D6 M.D., a long burst is 40 rounds and inflicts 1D4X10 M.D. Wooden warheads (for anti-vampire purposes) inflict one M.D. point for a short burst or 1D4 for a long burst to normal targets, but does 5D6 damage to vampires on a short burst or 1D6X10 on a long burst. The machinegun can only fire bursts.

Rate of Fire: Equal to the number of hand to hand attacks (usually 4-6)

Effective Range: 2000 feet (610 m)

Payload: 8000 rounds (that's 2000 long bursts, or 4000 short).

**3. Rocket Machinegun:** This is a heavy machinegun that fires rocket-assisted rounds. The weapon is mounted on the front of the vehicle and can be fired by the pilot or co-pilot.

Primary Purpose: Anti-Personnel

Secondary Purpose: Defense

Mega-Damage: A 10 round burst inflicts 8D6 M.D. A long burst is 40 rounds and inflicts 2D4X10 M.D. Wooden warheads (for anti-vampire purposes) inflict 2 M.D. points to normal targets (2D6 M.D. on a long burst), but do 5D6 H.P. to vampires (2D4X10 on a long burst). Can only fire bursts.

Rate of Fire: Equal to the number of hand to hand attacks (usually 4-6)

Effective Range: 2000 feet (610 m)

Payload: 8000 rounds; that's 200 long bursts or 800 short bursts!

**4. Side Mini-Missile Launchers (2):** Mounted on each side of the vehicles are two multi-missile launchers. They can be operated by the gunner, pilot or co-pilot.

Primary Purpose: Anti-Personnel and/or Anti-Armor.

Secondary Purpose: Defense

Mega-Damage: Varies with missile type.

Rate of Fire: One at a time or volleys of two, five or ten missiles.

Effective Range: About one mile (1.6 km).

Payload: Twenty total; ten per launcher.

## Zancudo Transport & Attack Helicopter

This is a medium-sized flying vehicle designed to carry a power armor squad of six soldiers in and out of combat zones, especially in battles against vampires and pirates — The coastline is regularly patrolled by squadrons of 4-8 Zancudo helicopters. The helicopter also provides air support for ground troops and possesses impressive firepower, including a large auto-cannon and four missile launchers. Like most Colombian vehicles, the Zancudo has a fuel engine, not a nuclear one. The Zancudo Transport chopper also comes in a cargo and ambulance version — both have the same basic stats, but eliminate the missiles.

**Model Type:** CH-1000



**Class:** Combat assault and transport helicopter.

**Crew:** Two; pilot and co-pilot/gunner.

**Troop Capacity:** Six men in light power armor or 10 infantry soldiers in body armor.

**M.D.C. by Location:**

\*\*\* Four-Blade Top Rotor — 60

\*\*\*\* Rear Rotor — 50

Mini-Missile Launchers (4) — 100 each

Auto-cannon in Belly Turret — 100

\* Main Body — 250

Reinforced Pilots' Compartment — 150

\*\*\* Destroying the large top rotor will cause the ship to crash in 1D4 melee rounds.

\*\*\*\* Destroying the rear rotor will cause a loss of control; piloting skill rolls are at -40% and the pilot has to land immediately.

\* Depleting the M.D.C. of the main vehicle destroys the helicopter and it crashes.

**Speed:**

Flying: 200 mph (320 km); full VTOL capabilities.

Range: 450 miles (720 km) with fuel engines.

**Statistical Data:**

Height: 16 feet (4.9 m)

Width: 15 feet (4.6 m), 55 feet (16.8 m) for top rotor.

Length: 70 feet (21.3 m)

Weight: 12 tons (10,800 kg) fully loaded

Cargo: Up to 5 tons (4500 kg) of cargo can replace troops. Compartment behind pilots seats provides about 3 feet (0.9 m) of storage space for personal effects.

Power System: Gasoline engine.

Market Cost: 400,000 credits

**Weapon Systems**

- 1. 20 mm Rocket Auto-cannon:** A heavy gun that fires bursts of rocket-propelled ammunition with explosive warheads. The auto-cannon can chew through an armored vehicle or a nautical ship in less than a minute.

Primary Purpose: Anti-Vehicle.

Secondary Purpose: Anti-personnel

Mega-Damage: A burst is 20 rounds and inflicts 1D6X10 M.D. Can only fire bursts.

Rate of Fire: Equal to the number of hand to hand attacks of the gunner (usually 3-6)

Effective Range: 4000 feet (1220 m)

Payload: 4000 round drum; that's 200 bursts!

- 2. Mini-Missile Launchers (4):** Mounted on side "wings" are two pairs of missile launchers designed to saturate an area with anti-personnel missiles or to destroy armored vehicles and buildings with high-explosive missiles.

Primary Purpose: Anti-vehicle and anti-personnel.

Secondary Purpose: Defense

Mega-Damage: Varies with missile type.

Rate of Fire: One at a time or volleys of two, four, eight, twelve, sixteen, twenty or twenty four missiles.

Effective Range: About one mile (1.6 km).

Payload: 48; 12 per launcher.

# The Anti-Monster O.C.C.

The Anti-Monster is a mystic cyborg — a creation of advanced **trans-dimensional techno-wizardry**. At present, the only place on Earth where Anti-Monsters are created is the Republic of Colombia. Although several Anti-Monsters have been captured and experimented upon in an attempt to discover the manner in which they are created, not even Atlantis can duplicate the process (so **Techno-Wizard** characters shouldn't even think about trying to build one). **Spugorth** bio-wizards suspect that a god or a supernatural intelligence is the developer of the secret magic.

The Anti-Monster might be related to the alien Holy Terrors (see **Rifts Dimensions Book One: Wormwood**), since the end result is similar: a superhuman armored warrior. Of course, Holy Terrors are all but unknown on Earth, so very few people have made the connection. Another possibility is that the process was learned from the extradimensional genius known as *Doctor Articulos* (see **Rifts Sourcebook One**) or at least from someone in the Doctor's home dimension.

To become an Anti-Monster, the character must be a minor psionic, a latent psychic, mystic and/or other magic practitioner. The candidate then undergoes extensive surgical procedures in which most of his bone structure and internal organs are removed and replaced by **techno-wizard** created bionic parts. The surgery is accompanied by a prolonged magic ritual, during which almost all the I.S.P. and P.P.E. of the character is consumed (retains only 1D4 of each) as the link between man and magical machine is established. When the ceremony is over, the metal components of the cyborg become "alive" and can heal on their own (see O.C.C. abilities).

The Anti-Monster is a supernatural creature, able to inflict massive damage to vampires, demons, and other creatures of magic. Furthermore, the character's new body is enchanted with several spells which can be used up to four times per 24 hour period.

Vampires and supernatural monsters consider the Anti-Monsters to be their deadliest enemies and will do anything in their power to destroy them. At the same time, most humans and **D-bees** tend to fear and mistrust the mystic cyborgs because they seem so cold, merciless and inhuman. These characters are tragic heroes committed to defending a world that does not completely accept them. Surprisingly, they remain loyal defenders of humans and most innocent beings and are dedicated to destroying supernatural evil wherever it is encountered. An evil Anti-Monster working on the side of supernatural monsters is an extreme rarity.

## The Price of Power

**1. Inhuman Appearance:** The character's appearance is irrevocably changed into a towering metallic brute, 7 feet (2.1 m) tall, weighing 400 lbs (180 kg) and horror factor 2D4+6.

**2. Debilitating Complications & Death:** Furthermore, at the end of 1D4 years, there is a 5% chance that the **Anti-Monster's** body will reject the magical grafts; this rejection requires an immediate save vs **Coma/Death** at -15%. Even if the save is made, the Anti-Monster will be crippled; -7 to strike, parry and dodge, reduce all attacks and speed by half for 1D6 **months!** Afterward, the mystic cyborg seems to recover and is only -2 on all combat

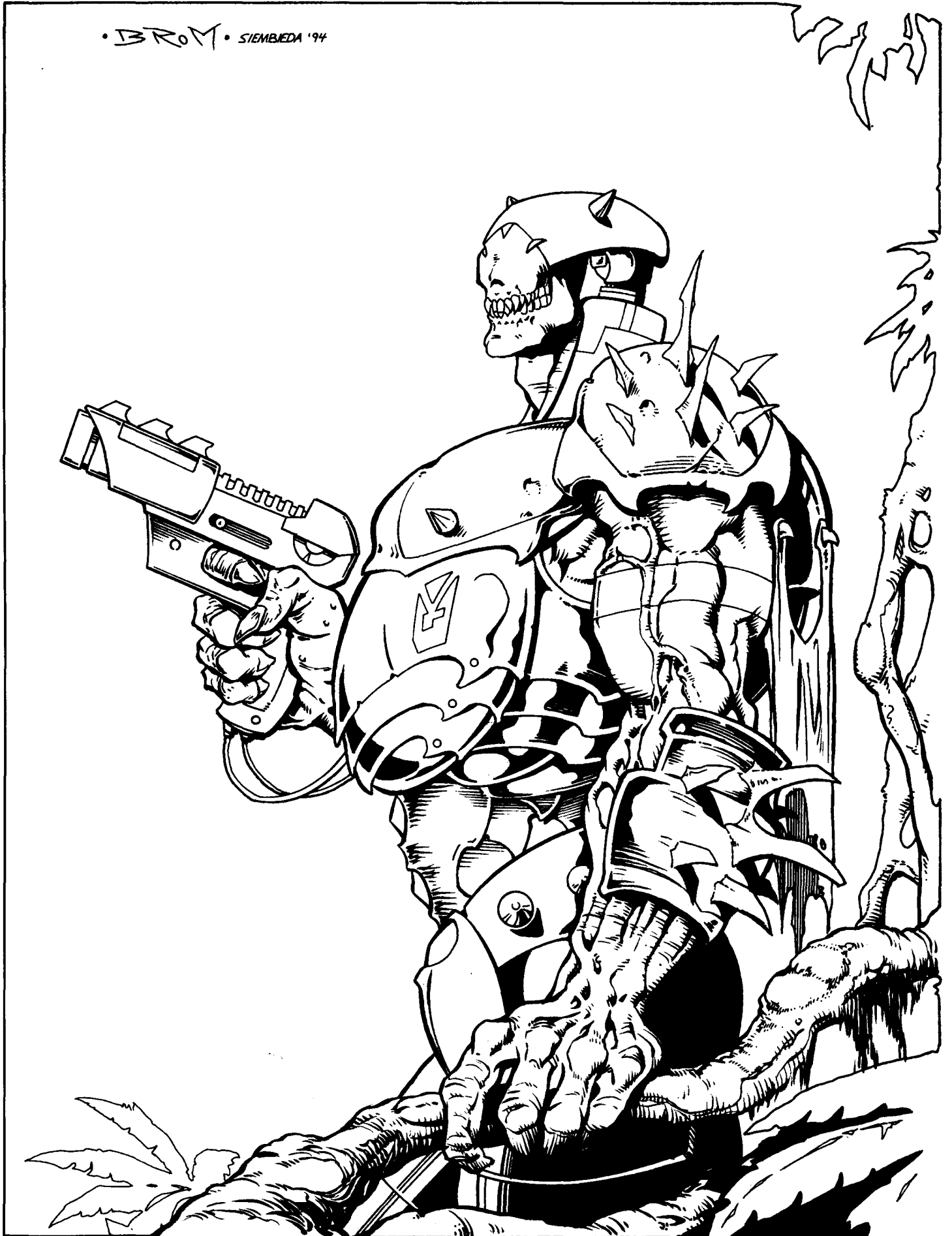

bonuses, while speed and the number of attacks per melee are reduced only by 25%. However, this may be a temporary situation with the chance of rejection **reoccurring** 1D6 years later and again 2D4 years after the second crisis. After the third crisis, the Anti-Monster is safe from rejection and returns to full strength and ability for the rest of his days. In any case, very few Anti-Monsters survive more than 15 years of active duty.

**3. A loss of humanity:** All Anti-Monsters lose their human appearance and a bit of their humanity in the creation process. They tend to forget about the human condition like needing rest, sleep, food, water, etc. About 50% become impatient and intolerant or frustrated by human frailties and weaknesses. Most (90%) seem cold, brutal and merciless, especially when combating monsters. This is compounded by the character's intense obsessions and monstrous appearance.

**4. Insanities:** 80% of all Anti-Monsters develop an Obsession. Roll or pick one.

01-20 Obsessed with destroying vampires, ghouls, necromancers and all forms of undead.

21-40 Obsessed with destroying all evil supernatural beings. Dislikes and distrusts any supernatural being, even those of a good alignment (and isn't too thrilled with creatures of magic and men of magic who summon or control the supernatural).

41-60 Obsessed with protecting humans and innocent **D-bees** against evil and manipulative gods and **their** minions, including priests, acolytes, shamans, warlocks and witches.

61-80 Roll on the random table on page 20 of the **Rifts RPG**.

81-00 Pick one of the above and roll for one additional random obsession.

## The Anti-Monster O.C.C.

**Alignment:** Any, but usually scrupulous, selfish or aberrant.

**Attribute Requirements:** None, other than a willingness to become an inhuman creature, and initially possesses either magical abilities and/or minor psionics.

### O.C.C. Abilities and Bonuses:

**1. M.D.C. Transformation.** The character becomes a magical **flesh-and-metal** creature with 1D6X10+400 M.D.C. The character regenerates damage at the rate of 4D6 M.D.C. per minute (or 1D6 per melee).

**2. P.P.E. and I.S.P.:** The character's inner energies are permanently spent during the mystic transformation process. P.P.E. and I.S.P. drop to 1D4 points each. Furthermore, this P.P.E. and I.S.P. cannot be tapped in any way by the Anti-Monster, magic practitioners, or Mind Bleeders.

**3. Supernatural Attributes:** The Anti-Monster has the following supernatural attributes: M.A. 19+1D6, P.S. 28+2D6, P.P. 19+1D6, P.E. 18+2D6, P.B. 2D4 and Spd 3D4X10. All other attributes are determined normally for the character's race of origin.

Mega-damage inflicted by hand to hand combat varies with the supernatural P.S. of the character (see **Rifts Conversion Book One**, page 22). Against vampires, the character inflicts 1D4 hit points (H.P.) with a restrained punch, 2D6 H.P. with a full strength punch, and 4D6 H.P. with a power punch (counts as two attacks), plus the addition of the P.S. attribute damage bonus.

**4. Supernatural Powers:** The Anti-Monster is unaffected by normal (non-M.D.C.) heat, cold and weapons, and no longer needs to eat or breathe (can survive indefinitely in outer space, underwater, buried alive, etc.). Mega-damage heat, fire, plasma and cold inflict half damage. Lasers, particle beams, ion blasts, electricity, mega-damage explosions, psionics and magic do full damage. The character is also impervious to poisons, drugs and magic potions.

**5. Magical Powers:** During the creation process, the Anti-Monster gains the following "built-in" spells: Blinding flash, globe of daylight, chameleon, armor of Ithan, magic net and shadow meld. He can cast each spell up to three times per 24 hour period, equal to a 5th level wizard. The character does not gain any further spells, nor do the existing spells increase in level. The character can use rune weapons, scrolls and techno-wizard or enchanted items, but not magic potions or ointments.

**6. Sense Psychic and Magic Energy.** This power works like the **Psi-Stalker's** ability, but isn't as developed. The Anti-Monster can detect the presence of psychic energy, specifically psionics (I.S.P.) and magic (P.P.E.) directly oriented towards magic spells, circles, wards, **techno-wizardry** and magic devices. The ability is constant and automatic, just like the **psi-stalker**. Range: 50 feet (15.2 m).

**7. Sense supernatural beings.** Identical in function to the previous ability, except the Anti-Monster is much more sensitive to the very distinctive psychic "scent" of the supernatural. Base Skill: 60%+2% per level of experience. The ability to identify the specific type of paranormal creature has a base skill of 58%+2% per level of experience, and it includes demons, vampires and dragons.

**8. Other Psionic Powers.** None; all potential psychic abilities are burned out during the transformation. However, the character is considered a major psionic for save purposes (12 or higher).

**9. Bonuses.** +2 to initiative (+4 against ghouls, vampires and all forms of undead), +1 to strike, parry and dodge (in addition to hand to hand and attribute bonuses), +4 to pull punch, +2 to roll with impact, +3 to save vs magic, +3 vs save vs psionics, and +5 to save vs horror factor. All are in addition to the attribute bonuses. They are immune to the vampire's mind control bite (but can be killed by the vampire's killing bite) and cannot be turned into a vampire. Impervious to poisons, drugs and magic potions; see number four and ten.

**10. Vulnerabilities and Penalties.** The Anti-Monster takes double damage from rune weapons, Wormwood crystal magic, and Millennium Tree wands, staves and weapons (good or evil). The size and weight of the cyborg makes prowl difficult: -20% to all prowl rolls.

### O.C.C. Skills:

Radio: Basic (+10%)

Wilderness Survival (+10%)

Piloting (any one, except robots and power armor, at +10%)

Language (two of choice at +20%)

Demon and Monster Lore (+15%)

W.P. Energy Rifle

W.P.: three of choice

Hand to Hand: Expert

Hand to Hand: Expert can be changed to Martial Arts or Assassin (if an evil alignment) for the cost of one "other" skill.

**O.C.C. Related Skills:** Select 6 other skills. Plus select two additional skills at level three, two at level six, one at level nine, and one at level twelve. All new skills start at level one proficiency.

Communications: Any

Domestic: Any

Electrical: Basic only

Espionage: Any (+5%)

Mechanical: Automotive only

Medical: Only First Aid and Paramedic (Paramedic counts as two skills).

Military: None

Physical: Any except acrobatics

Pilot: Any except robot and power armor (+10%).

Pilot Related: Any (+10%)

Rogue: Any

Science: Basic Math only

Technical: Any (+5%)

W.P. Any

Wilderness: Any

**Secondary Skills:** The character also gets to select six secondary skills from the previous list. These are additional areas of knowledge that do not get the advantage of the bonus listed in parenthesis. All secondary skills start at the base skill level. Also, skills are limited (any, only, none) as previously indicated in the list.

**Standard Equipment:** Suit of medium or heavy M.D.C. armor (can also wear any suit of cyborg armor, including Heavy Infantry Armor: 420 M.D.C.), two energy weapons of choice, and three other hand to hand or archaic weapons of choice. Anti-Monsters don't need to eat and are not affected by weather, so they carry minimal survival equipment.

**Money:** Starts out with 1D6×1000 in credit.

**Cybernetics:** Mystical bionic lungs, retractable claws or retractable forearm **vibro-blades** and up to 1D4+1 cybernetic implants (player's choice) incorporated during the **operation/transformation**, but cannot gain any others after the transformation (only the creation ceremony allows the character to accept the implants). Each implant increases the chance for rejection by 3% (see the price of power, above).

---

# The Vampire Kingdom of Haktla (The Colombian Andes)

---

**Population Breakdown:** A total of 684,004

Master Vampires: 4

Secondary Vampires: 4,000 (plus 2,000 in suspended animation)

Wild Vampires: 2,000 (plus 1,000 in suspended animation)

Assorted minor demons (alu, lasae, mares and shedim): 5,000

Humans: 300,000

Other humanoid races: 250,000

Brodkil Warriors: 20,000

Note: This doesn't include a slave population of 100,000.

Most vampire intelligences on Rifts Earth targeted Mexico and Central America. South America was considered undesirable due to its wet climate, frequent rain, and many rivers. The lone exception to this line of thought was held by **Haktla**, an ancient and powerful intelligence with many connections with demon races. Haktla decided that if the region's weather was unsuitable for vampires, then he would simply have to change the weather patterns! Unable to do so on his own, the vampire intelligence contacted a demon lord called **Enumu, King of Drought**. This demon had been worshipped as a minor deity in a couple dimensions, where he ran a supernatural "protection racket" (If human victims were not sacrificed in enough number to satiate his unnatural needs, Enumu would cause droughts and famine).

As fate would have it, Enumu had recently been defeated and expelled from his own realm and had nowhere to go. Consequently, the King of Drought found **Haktla's** offer especially appealing. Although suspicious of vampires, the diabolical creature could recognize a good deal when he was offered one and the two demonic beings forged a lasting alliance.

Enumu worked his magic to alter weather patterns by reducing the normal amount of rainfall and making rain occur only during the daytime and under his absolute control. Haktla created a master vampire in the Andes Mountain range and the vampire community soon grew and conquered most of the human and D-bee communities in the Colombian Andes. The human population that was not turned into vampires or killed in combat were enslaved by their undead conquerors.

Eventually, the vampire intelligence ordered his minions to expand east, into the Republic of Columbia. The result has been a war that has lasted for centuries; neither side has been able to seize and hold the upper hand.

At this point, the vampire kingdom of Haktla has one of the largest undead populations in the world (second only to the Kingdom of Ixzotz, in Mexico). In terms of population, the Haktla intelligence controls a larger area of land and a greater number of people than any other vampire kingdom on Earth. Unlike his Mexican cousins, Haktla does not care for subtlety and does not try to conceal his kingdom's existence from the people of the surrounding territories. Virtually every inhabitant of South America (and parts of Central America) knows of or has heard about the **Vampire Kingdom of Haktla**.

Three factors have prevented Haktla from creating hundreds of thousands of vampire warriors and sending them against Colombia. The first is that the vampire intelligence wanted to see how the threat of the Horsemen of the Apocalypse (see **Rifts Africa**) was dealt with: Haktla had known of the prophecy for centuries and was not ready to start expanding until that danger had passed. Secondly, he is not sure what "Powers" exist to the south — so far, all vampire probes in that direction have run into pow-

erful magical opposition. Haktla has heard rumors about both the Kingdom of Lagarto and the cities of El Dorado and believes too obvious a threat might persuade these potential enemies to join forces against his Kingdom. Finally, Haktla realizes he is not powerful enough to resist an all-out attack from Atlantis and knows that the Spugorth will react violently to a vampire controlled continent. Likewise, he wonders how forces in the north (including fellow vampire intelligences in Mexico) would react to his conquest of all of South America. For now, he and Enumu are content with small gains against Colombia and the relatively stable stalemate that currently exists.

Haktla made contact with a race of supernatural monsters shaped like giant vampire bats several decades ago (see the description for Giant Vampire Bats in this section). These creatures are some sort of bizarre magical mutation and can be controlled by master vampires and vampire intelligences. Haktla has attracted a huge flock of these creatures (over 10,000) and sometimes sends them on brutal attacks against outlying Colombian communities and other targets.

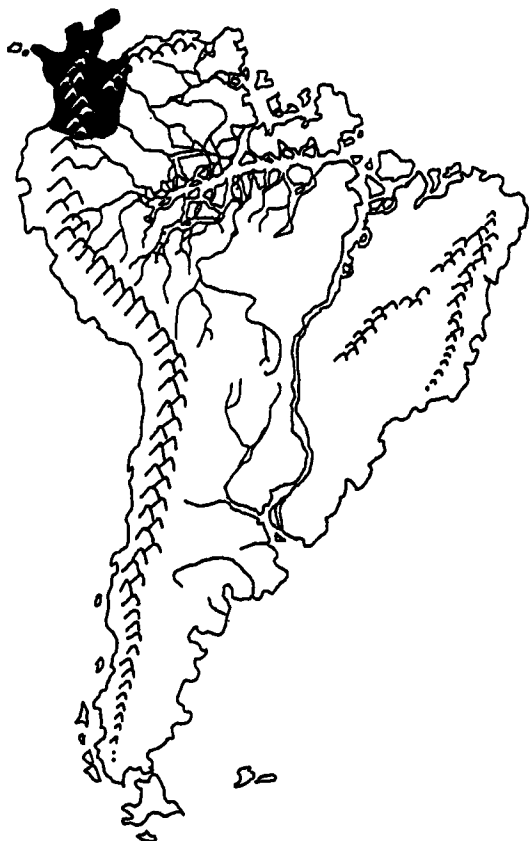

## The Pyramid City

**Population Breakdown:** A total of 67,000

1 master vampire (Hak-Talon)

Secondary vampires: 1200

Assorted demons: 1000

Brodkil Warriors: 5000

Humans and D-Bees: 60,000 (70% humans, the rest are diverse humanoid D-Bees).

Pyramid City is located in a hidden valley in the Northern Andes mountain range. It is the second city to bear this name: the first one was located and destroyed by the Colombian army almost a century ago. The dry mountain climate is ideal for vam-

pires and the treacherous passes and narrow roads leading to the city can be easily defended. Powerful spells hide the whole valley from all conventional forms of detection and most magical and psionic senses. There is also an army of 500 secondary vampires, 5,000 Brodkil, and a few dozen other monsters and demons stationed on the mountain passes leading to the city. So far, these defenses have ensured that no enemy force has made it to the kingdom's capital. The city is built around a Mayan-style pyramid that Haktla had established shortly after his arrival on Earth.

Pyramid City is very primitive. There is no electricity, central lighting or much in the way of human comforts. The only power source is the pyramid built at a ley line nexus which is used by Haktla and Enumu to travel and to draw P.P.E. to power their spells and rituals. The Brodkil have a nuclear power plant used to recharge their weapons and equipment, but do not share the power with the human slave population who live under medieval conditions. The only signs of high technology are the weaponry that the Brodkil and some of the vampires use. Most of it is captured from Colombian armed forces or adventurers and includes about fifty robots and armored vehicles.

The human population of Pyramid City (and the rest of the Kingdom) has lived in slavery for over a hundred years. They have been taught to believe that Haktla and Enumu are gods and that they have a sacred duty to pay "Blood Taxes" to feed their vampire overlords. Wisely, Haktla and his master vampires do not frequently mistreat the local population. Only those who try to escape or oppose their rule suffer their wrath. Despite poor living conditions, only a small percentage (less than 10%) of the human population seriously considers rebelling against their masters. The majority faithfully serve the gods (Haktla and Enumu) and their minions (vampires and demons) and consider themselves blessed.

## The Plaza of Punishment

A constant reminder of the folly of rebellion is the **Plaza of Punishment**. Every month, one to twenty (sometimes more) men and/or women are brought here for ritual execution. The victims are typically foreign interlopers, people captured during raids against Colombia, or citizens found guilty of treason (on the rare occasions when no suitable victim can be found, Hak-Talon charges some random unfortunate or visiting adventurer with treason or conspiracy and has him brought to the Plaza). The victims are chained to the rows of posts set in the Plaza and every night for several days are drained of blood through torture (or by vampires). The agony is prolonged as long as possible with the victims often lingering for an entire week or two. In this way, the inhabitants of Pyramid City are given a graphic demonstration of the consequences of fighting back. In some cases, the unfortunate individual is turned into a wild or secondary vampire — becoming a loyal servant of the Kingdom.

Any person foolish enough to help any of these prisoners to escape "justice" is hunted down and slain. Ideally, they are captured and made to suffer the same fate. Foreigners who speak or act against vampires or conspire with their enemies suffer the same punishment. Travelers who stray into vampire territory may be captured, enslaved and made to serve the vampires or one of their demon minions.



## Enumu, Lord of Drought

Enumu is a demonic semi-elemental being with the power to control the weather. In several worlds throughout the Megaverse, the creature has been worshipped as a god of rain and fertility. Unlike most so-called gods, however, Enumu usually plays on the fears and weaknesses of mortals, threatening them with drought and scarcity if they do not keep him well supplied with human sacrifices. The foolish monster hasn't learned that intimidation tactics never work for long and, time after time, the oppressed people rise up to oppose him. Other gods, ancient dragons, powerful sorcerers and even mortal champions of light have battled Enumu and expelled him from all his former domains. It was shortly after one such defeat that **Haktla** contacted Enumu and offered to form an alliance.

The demon has no regrets regarding this unholy union. Over the last century, he has been worshipped as a god, second only to Haktla in power and influence. Every month, a hundred or more humans and D-Bees are sacrificed in his name either in ritual sacrifice or war, keeping him well fed with the P.P.E. of the victims. In return, Enumu uses his powers to control rainfall over the area, keeping it at a minimum and restricting it to the daylight hours when vampires are well secluded. Every time a Colombian invasion force has reached **Haktla's** mountain strongholds, Enumu's weather powers have been used against the human warriors, causing storms, flash floods, and mud slides to bog down the enemy during the day and preventing weather magic from causing rain at night, when the vampires strike.

However, Enumu's efforts to bring drought to the Republic of Colombia have been checked by the intervention of several

powerful priests and their deities; mostly the followers of the Voodoo pantheon. The demon will not directly confront gods or their servants and has made it clear to his ally that he will not actively participate in the Colombian conflict until the vampires have the area under their control.

**Alignment:** Miscreant

**Species:** Demon Lord

**Horror Factor:** 16

**Attributes:** I.Q. 17, M.A. 18, M.E. 20, P.S. 27, P.P. 19, P.E. 25, P.B. 6, Spd. 43.

M.D.C.: 1800

P.P.E.: 4000

**Natural Abilities:** Nightvision 4000 feet (1220 m), see the invisible, turn invisible at will, bio-regeneration 1D4X10 M.D.C. per minute (every 4 melee rounds), impervious to all forms of weather magic such as wind rush and call lightning, immune to electricity (takes no damage from mega-damage or magical electricity), and all other energy attacks inflict one-quarter damage! **Teleport** 65%, dimensional **teleport** 72% (only to previously known dimensions; includes Hades and Dyval).

**Special: Weather Control:** Enumu can control the weather over a 1000 mile (1600 km) radius. Within this area, the demon can control rain, winds and other climatic factors. The weather in the surrounding areas is also severely affected — Enumu's intervention has changed weather patterns around the world.

**Special: Negate Weather Magic:** The demon can also prevent normal weather magic from working within a smaller area of 100 miles (160 km) radius. Only a super-powerful magician, warlock (15th level or higher), or a priest of a weather deity can override his weather control. Gods of weather and fertility can nullify Enumu's power with ease.

**Vulnerabilities and Penalties:** Most forms of magic, including rune weapons, circle magic, wards, staves and wands, have full effect and inflict full damage. Kinetic force, including missiles, explosives, rail guns, and mega-damage punches and kicks, inflict full damage.

**Disposition:** Enumu has a cruel and intimidating air about him. Anybody who speaks with him feels vaguely threatened by the demon's tone, rumbling voice and demeanor. The Lord of Drought considers all mortals and lesser creatures to be no more than cattle to be toyed with or slaughtered at his whim. The demon fears dragons, powerful supernatural monsters, fellow demon lords and gods, but never shows this fear openly. Even when confronted by a more powerful being, Enumu will maintain a threatening poise — although he will be ready to flee if push comes to shove.

**Experience Level:** Equal to a 15th level warlock.

**Magic Knowledge:** Knows all air, water and fire elemental spells.

**Psionic Powers:** None

**Combat Skills:** Supernatural

**Attacks per Melee:** Seven hand to hand or three by magic.

**Bonuses:** +2 on initiative, +6 to strike, +6 to parry and +7 to dodge, +12 to damage, +4 to roll with **impact/punch**, +4 to pull punch, +10 to save vs poison, +6 to save vs magic, +5 to save vs psionics, and +10 to save vs horror factor.



**Damage:**

Restrained punch, kick or claw — 5D6+12 S.D.C.  
 Full Strength Punch — 3D6 M.D.  
 Claw Swipe — 5D6 M.D.  
 Power Punch — 6D6 M.D.  
 Power Claw Swipe — 1D6X10 M.D.  
 Kick Attack — 4D6 M.D.

**Weapons:** None. Relies entirely on his natural powers.

**Skills of Note:** Math (advanced and basic), astronomy, demon and monster lore, wilderness survival, anthropology, land navigation and wilderness survival, all at 98%. Literate and fluent in Demongogian, Spanish, American, Euro, Dragonese/Elf and Creole, all at 98%.

**Description:** A humanoid with an over-developed, muscular upper torso and arms and relatively short legs and narrow waist, giving him an almost cartoonish appearance. However, his leathery skin with scaly patches, oversized mouth filled with several rows of needle-like teeth and huge, glowing eyes are anything but amusing. His hands have six fingers, each tipped by menacing black claws. His voice has a rumbling quality like rolling thunder.

## Hak-Talon, Master Vampire

Hak-Talon was born Edgardo Amendariz, a simple villager in a secluded mountain community in the Andes mountain range. The young man was a shepherd, relatively content with his life — until the dreams started. Dreams of unimaginable power, of being superior to the rest of his fellow villagers. Edgardo had often been the victim of the town bullies; in his dreams he avenged every slight by tearing his enemies' throats apart and drinking their blood. The youngster always awoke from these dreams with a feeling of terror, and time and time again he rejected the implicit offer the dream made. But the contacting vampire intelligence knew what it was doing.

Edgardo soon started to resent his place in the world. In his dreams, he was the most powerful being on Earth, while in reality, he was a humble member of the community, often picked on, without a say in any matter of importance. Every slight he suffered, real or imagined, made him angrier and angrier. Edgardo started trying to boss around the other villagers, who naturally laughed him off: why should anybody listen to this child? Frustration and anger made the dreams less horrifying and the offer of supreme power grew more tempting.

The final straw came when a girl he had a crush on was betrothed to an older, more influential member of the community. Later that night, Edgardo wept bitter tears and fell asleep dreaming of revenge. He found himself facing an utterly inhuman being of unimaginable power. An offer was made and Edgardo knew that this time it was no dream. After only a second of hesitation, Edgardo nodded his acceptance. That night, Edgardo Amendariz died and Hak-Talon was born.

The following night, the villagers, who had barely noticed the absence of the young shepherd, started suffering a rash of disappearances. The first to go was the girl Edgardo had coveted and her fiancé. Then one by one, all the town bullies began to vanish. Every morning, huts were discovered empty, with small splatters of blood on the floor and signs of struggle, suggesting the occupants had not left willingly. Terrified, the villagers es-



tablished watches — only to have the watchers disappear. After one-fifth of the village was gone, the rest decided to flee, but it was too late. Before the night was over, the helpless community was visited by **Hak-Talon** and his army of vampires composed of many of the missing villagers, transformed into the undead. A massacre followed; none of the villagers escaped.

Hak-Talon served his new master well, preying on all human and D-Bee communities in the area, slaughtering or infecting innocent victims to expand the **vampires'** dominion. It only took a few years to acquire the numbers needed to enable the vampire intelligence to Rift to Earth and take physical residence in the Andean mountains. Hak-Talon has remained the first and foremost master vampire of the kingdom, but recently, some of **Edgardo's** old personality has begun to surface. Sadly, nothing humane or good. Actually, the same resentment and ambition that caused him to become a vampire in the first place are nagging at Hak-Talon. He has risen as high as he can in the service of **Haktla** and he wants more. He believes that there is some arcane formula or ritual that could transform him into a vampire intelligence — maybe that's how the intelligences reproduce! His secret research on the matter is very subtle and quiet, using human and D-Bee agents in Columbia and the island kingdoms. Player Characters in South America might even be sent on a quest for a mystical scroll or artifact, not knowing that their mysterious employer is an agent for a power hungry master vampire.

**Alignment:** Diabolic

**Species:** Master Vampire

**Horror Factor:** 14

**Attributes:** I.Q. 25, M.A. 28, M.E. 22, P.S. 33, P.P. 27, P.E. 19, P.B. 23, Spd. 30.

**Hit Points (vampire):** 160

**P.P.E.:** 40

**Natural Abilities:** All vampire powers (see **Rifts Vampire Kingdoms**). Control other vampires, metamorphosis into wolf, vampire bat or mist, summon vermin, invulnerable to normal weapons, regenerates 2D6 hit points per melee, nightvision 1600 feet (488 m), smell blood up to one mile away (1.6 km), does not breathe, and recognizes other vampires by sight.

**Disposition:** Little is left of the shepherd boy corrupted by **Haktla**. What remains are his worst qualities; selfishness, petty egotism and hunger for power. Like all master vampires, **Hak-Talon** is an inhuman monster who only pretends to behave like a normal person in order to deceive foolish mortals. In the vampire kingdom, **Hak-Talon** behaves like a god, tolerating no disrespect from his mortal slaves and often engaging in little head games to keep the humans in fear and uncertainty.

**Experience Level:** 11th level master vampire.

**Magic Knowledge:** None

**Psionic Powers:** Control other vampires, death trance, alter aura, empathy, mind block, hypnotic suggestion, presence sense, sense evil, deaden pain, induce sleep and super-hypnotic suggestion. **I.S.P.:** 180

**Combat Skills:** Supernatural

**Attacks per Melee:** Six hand to hand or two psionic plus two hand to hand attacks.

**Bonuses:** +3 to initiative, +6 to strike, +6 to parry and dodge, +18 to S.D.C. damage, +2 to save vs magic, +4 to save vs

psionics, +9 to save vs horror factor. Immune to all forms of mind control and psionic and magic sleeps and paralysis.

**Weapon Proficiencies:** W.P. sword, W.P. blunt, W.P. energy rifle, W.P. heavy.

**Weapons:** Often uses captured Colombian weaponry, including rocket rifles and heavy weapons.

**Armor:** None, but carries a captured **Splugorth** talisman that provides an **Armor of Ithan** protection field three times a day (100 M.D.C.)

**Skills of Note:** Wilderness survival, track animals, hunting, and demon lore, all at 98%. Speaks Spanish, Quechua and **Demongogian**, all at 98%.

**Description:** A short man with Indian features. His skin is unnaturally pale, but his aura of power and charisma makes him attractive in a terrible, scary way. Dresses in colorful ponchos and headgear.

## Giant Vampire Bats A D-Bee Monster

The common vampire bat is a well-known danger of the jungle. Sleeping people and cattle are often targeted by these small predators, who make small scratches or bites and lick the blood of their victims. These attacks are not life-threatening, but can transmit disease and infection.

The giant vampire bat is a different matter. These beasts resemble normal bats, but they are nearly man-sized, with stubby, short wings, and heavy bodies that would seem to make them unlikely flying creatures. Their power of flight is a matter of magic, not physics, which gives them disarming speed and agility in the air. Their teeth are all long and sharp, and their bites tear and rip off chunks of the victim's flesh. They are nocturnal predators that are blinded and vulnerable in the daylight. During the day, they hide in caves, ruins and other dark places. Like all bats, the creatures are nearly blind, but have developed a radar sense that allows them to spot obstacles (and incidentally, invisible targets). They also have an incredible sense of smell. Unlike true vampire bats, however, these creatures favor attacking and killing live prey, either carrying it to their lairs, or taking a bite and then flying away.

The origin of these creatures is unknown, but superstition suggests they are related to the vampire races. Perhaps they are a race of D-Bees who were given vampire-like powers developed by a powerful intelligence using **bio-wizardry**. Or maybe they are denizens of some supernatural realm and have no direct connection to vampires at all. It is just as likely that these creatures are normal vampire bats that have been magically altered by the surge of P.P.E. released by the Rifts or by some man of magic. Regardless of their origin, these giant bats can be controlled (but not summoned) by master vampires and vampire intelligences as easily as normal vampires control ordinary vermin. Fortunately, the giant bats are found only in the mountains and rain forests of **South America** and are unknown to the other vampire kingdoms on Rifts Earth.

In the wild, the giant predators hunt alone or in small groups (1D4+1 individuals) and are typically encountered in both the forests and mountains. A cave may harbor a whole flock, ranging from 2D6 to 1D6X10 individuals, depending on the size of the cave.



The giant bats controlled by Haktla and **Hak-Talon** travel in groups of 6 to 9 (1D4+5) and are frequently dispatched to enemy territories to attack any **humanoids** they may encounter. Special missions are often led by a secondary vampire travelling in bat form. The giant animals may also be used to create a distraction while vampires strike from another area or may be sent ahead in battle to frighten the enemy and penetrate enemy lines. The creatures are highly intelligent for animals and completely obedient to vampires.

**Alignment:** Considered to be an evil predator.

**Attributes:** IQ 2+1D4 (high animal intelligence), M.E. 18+1D4, M.D. 9+1D6, P.S. 20+1D6, P.P. 16+1D6, P.E. 16+1D6, P.B. 6+1D4, Spd 20+3D6 flying, 3D6 on the ground or climbing. M.D.C.: 2D6X10

**Horror Factor:** 14

**P.P.E.:** 6

**Natural Abilities:** Regenerates 1D6 M.D. per melee round, impervious to poison, disease and S.D.C. weapons; takes half damage from non-magical M.D.C. weapons/attacks.

Radar sense: 1200 feet (366 m). Allows them to know/sense the location of people, objects, movement and the general shape of the environment around them. They can also smell the scent of blood up to two miles (3.2 km) away, recognize a specific scent 80%, track by smell 85%, track, dodge and strike by sound (keen hearing) 65%, and can climb trees, the sides of buildings or cave walls at 75%. They are poor swimmers (30%) and avoid large bodies of water.

**Vulnerabilities and Penalties:** Silver weapons, but not wood or water, inflict M.D.C. damage. Normal mega-damage weapons inflict half damage, but magic has full effect and inflicts full damage.

Sunlight is painful to the creatures and inflicts the following penalties, 2 on initiative, 2 to strike, parry and dodge, and reduce the number of melee attacks by half. Fire or light sources from torches, powerful flashlights, etc. can spook the creatures. This works as a Horror Factor value: a torch or a normal flashlight have a Horror Factor of 10; a spotlight being shined in its face or globe of daylight has an H.F. of 15.

**Combat:** Four physical attacks per melee.

**Bonuses:** +1 on initiative, +3 to strike, +4 to parry and dodge (+6 to dodge when flying), +3 to save vs magic and psionics. All these are in addition to attribute bonuses.

**Damage:** Bite inflicts 3D6 M.D., claw strike does 2D4 M.D., flying swoop attacks inflict 1D4X10 M.D. but count as two melee attacks. There is also a 20% chance that the bites of the creature will inflict disease; typically fever.

**Average Life Span:** 20 to 30 years.

**Habitat:** Forest, jungle and mountains of South America (could eventually migrate to Central America). Sleeps in caverns, ruins and other dark places.

**Average Size:** 5 feet (1.5 m) tall, with a wingspan of 6 feet (1.8 m).

**Average Weight:** 200 lbs (90.6 kg).

# The Pirate Kingdoms

**Population:** About 200,000  
40% humans 80,000  
20% lizard men 20,000  
40% assorted D-Bees 80,000

Scattered on both sides of the Amazon river and along the coastline are over a hundred medium-sized islands (and many hundreds more of small to tiny ones). Of these medium islands (typically about 90 to 200 square miles/233 to 518 sq. km), about two dozen are inhabited by violent raiders and marauders, all members of the so-called Pirate Kingdoms. Many D-Bees forced to flee Columbia end up in these areas. Hatred, poverty and lack of industry lead many into becoming pirates, thieves and cutthroats. Some live under primitive conditions, travelling in canoes or small powered boats to nearby settlements where they steal what they can. The more powerful clans and kingdoms have large fleets and control powerful seaports and lengths of river or coastline. From these strongholds they attack ships and conduct raids on the mainland.

The principal sea routes infested by pirates lay outside the Amazon River and in the Southern portion of the Atlantic ocean. These waters are traveled by ships conducting trade between the Silver River Republics and Colombia, Maga and Bahia and offer rich pickings. Freebooter ships prowl the sea lanes seeking merchant vessels to plunder, or engage in lightning quick raids on seaports and coastal communities. Some pirate bands venture further away, raiding ships and islands deep in the Atlantic Ocean and even plunder the coast of Africa and the Mediterranean Sea. The Pirate Kingdoms do not venture into the Pacific Ocean because it is the domain of pirates operating out of the Bahia islands (for more information about the Bahia pirates, see **Rifts Undersea**).

The slave trade is an important source of wealth for these pirates. The main slave buyers are the **Splugorth** who supplement their own raiding parties by purchasing captives from independent pirates. Several islands have small Splugorth bases that conduct and coordinate trade with the pirate kingdoms. The largest such center is an entire island colonized by minions from Atlantis, an island appropriately named **Slavers' Port**.

Described below are two major forces in the Pirate Kingdoms. A third, made up of two islands, is fully developed in the **Black Ships** scenario outline elsewhere.

## Kryang's Land

**Land Area:** 200 square miles (518 square km).  
**Population Breakdown:** Total population 22,000 (plus 1200 slaves).

Humans 20%  
Lizard Men 20%  
Ram-Rat Monsters (see Wormwood Dimension Book) 20%  
Giants 10%  
Other D-Bees 30%

This does not count a small Splugorth trading post (small because **Kryang's** pirates do most of **their** trading at Slavers' Port, which isn't too far away). The Splugorth post has 40 **Kittani** warriors, 10 Overlords, two Conservators and one High Lord on regular duty. Sunaj assassins and other minions occasionally visit the port or assist in unusual problems.

Kryang's Land was founded by a demonic D-Be'e known as **Kryang** the **Rathos**. The creature was Rifted to Earth with a band of Ram-Rats, a race of pseudo-demons, both of whom are active in many dimensions, including **Wormwood**. The monster and his band quickly subdued the local pirates and took over their operation. In the ten years since **Kryang's** arrival, he has become a legendary pirate renowned for his **ruthlessness** and skill. His band now has over two dozen large ships and hundreds of small sailboats and other vessels. They conduct raids against every coastline on the continent, from Colombia, Maga and Bahia to the Silver River Republics and even occasional in the Gulf of Mexico and along the coast of Africa!

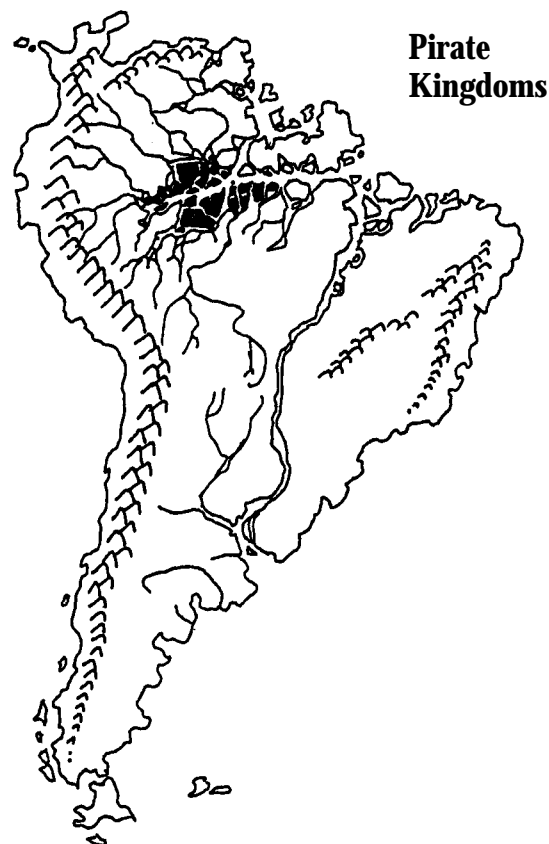

Kryang's pirates control one medium-sized island with a natural harbor and protected by harsh cliffs and a treacherous, rocky coastline. Kryang has placed several Kittani laser batteries in strategic places around the harbor and has mined the whole area with the exception of a narrow corridor that is changed regularly and which only a handful of his pirate navigators know how to cross. Twice, the Colombian Navy has attacked the harbor and both times have withdrawn with heavy losses. The second assault included a massive missile strike that destroyed half of the buildings in the port and seriously injured Kryang himself. As a result of these battles, Kryang has sworn revenge against the Republic of Colombia and always saves his worst atrocities for the citizens of that country.

The port consists of several dozen buildings gathered around a courtyard. A number of small houses surround the town center with twisting streets that have no names or markings. Strangers can easily get lost in this disorganized layout. **Kryang's** "palace" is a heavily fortified bunker carved into a hill overlooking the town and facing away from the sea. The town proper has four large inns and a dozen smaller ones, always filled with sailors, traders, mercenaries and pirates. The island even has an "arena": a 200 foot (61 m) wide, fifteen feet (4.6 m) deep, round pit, located a short distance from the town. The arena is the site of frequent contests, usually where prisoners or volunteers engage in fights to the death, while spectators watch from bleachers set around the pit. Drinking, brawling, wrestling, feasts, pranks, torture, singing, dancing and gambling are other common forms of amusement.

Inland, the place consists of patches of jungle cut away by plantations where slaves work the crops that feed the inhabitants. **Kryang** and three or four of his cronies own the plantations and control the price of food on the island.

## King Kryang

Kryang is a **Rathos**, a demonic race of giant warriors fully described in **Rifts Dimension Book One: Wormwood**. This particular "rambler" (as his race is commonly known) was the leader of a band of monstrous mercenaries in the service of anybody who would meet his price. His last employer was some sort of god or alien intelligence who used Kryang's army as cannon fodder in a war against gargoyle shock troopers. During a particularly violent clash, a wizard from one side or the other opened dimensional Rifts right on the battlefield, transporting thousands of warriors from both sides to other worlds. Kryang and most of his band appeared on a South American island on Rifts Earth. The local human and D-Bee pirates were no match for him and his hardened warriors. He soon became the overlord of the region.

The pirate king's renown is such that he has visited Atlantis as a guest at the city of **Splynn** (see **Rifts Atlantis**). He even accepted a challenge and fought at the Splynn Arena where he defeated a **Splugorth** Conservator in a memorable fight. King Kryang considers himself an ally of Atlantis. Lord **Splynncryth** finds the Rathos an amusing minor servant and humors Kryang whenever he is visiting, but only as long as the "king" doesn't do anything too annoying or embarrassing. Kryang is currently content with his role as a pirate king. He entertains himself by leading large scale raids against seafaring merchants and other nations, or by organizing his own version of gladiatorial games, forcing captives to fight to the death in his arena for his amusement.

**Alignment:** Diabolic

**Species:** Rathos the Rumbler

**Horror Factor:** 15

**Attributes:** I.Q. 14, M.A. 12, M.E. 10, P.S. 44, P.P. 20, **P.E.** 26, P.B. 3, Spd. 50.

**M.D.C.:** 400

**P.P.E.:** 200

**Natural Abilities:** Nightvision 400 feet (122 m), see the invisible, impervious to normal fire (magic fire and plasma energy inflict half damage), bio-regeneration 6D6 M.D.C. once per

melee round, and regenerates severed limbs within one week.

**Disposition:** Kryang is the typical warlord: arrogant, boastful and loud. When he is not involved in warfare, he finds entertainment in savage feasts (in which human victims are sometimes butchered and eaten on the spot!), torture and degradation. Besides himself, he only cares about his minions, but not very much. Despite his vices and sadism, Kryang is an experienced warrior and a master tactician. He had little experience in naval warfare when he first arrived on Earth, but in a few years has learned everything his teachers could show him and is now a capable sailor.



**Experience Level:** 10th level warlord

**Magic Knowledge:** His natural powers include: climb, thunder clap, breathe without air, fool's gold, magic net, repel animals and spoil water/food. Plus he knows the following elemental

magic spells: identify minerals, identify plants, rock to mud, crumble stone, rot wood, wither plants, wall of clay, and earth rumble.

**Psionic Powers:** None

**Combat Skills:** Supernatural

**Attacks per Melee:** Six hand to hand or two magic attacks per round.

**Bonuses:** +2 to initiative, +5 to strike, +5 to parry and dodge, +29 to S.D.C. damage, +3 to roll/pull punch, +7 to save vs magic, +10 to save vs earth warlock magic, +8 to save vs poison, and +5 to save vs horror factor.

**Weapon Proficiencies:** W.P. blunt, W.P. chain, W.P. energy rifle, and W.P. heavy.

**Weapons:** Favors Kittani weapons, including the K-4 laser pulse rifle, KEP-special energy pump pistol and K-E4 plasma ejector. Also has a huge assortment of neural maces, vibro swords and mega-damage melee weapons. His prized possession is a Crystal Fire Rod (see **Rifts Atlantis**) which he won at the Splynn Arena.

**Armor:** Enchanted plate armor with 120 M.D.C.

**Skills of Note:** Land navigation 86%, prowl 80%, climb 90%, swim 98%, tracking 80%, plus Demongogian and Gobblely at 98%; also knows Dragonese, elemental, and Spanish at 65%.

**Description:** A grey-skinned, over-muscled, 8 foot (2.4 m) giant, covered with yellow discolorations and spiny protuberances. His hands are three-fingered, with long talons.

## A Typical Kryang Pirate

**Typical Alignments:** Anarchist, miscreant and diabolic.

**Species:** Humans 20%, lizard men 20%, ram-rat monsters (see Wormwood Dimension Book) 20%, giants 10% (including ogres, trolls, jotan and gigantes), and a variety of D-Bees 30%.

**Horror Factor:** Varies with race.

**Attributes:** Varies with race.

M.D.C. & P.P.E.: Varies with race.

**Natural Abilities:** Varies with each particular race.

**Disposition:** Most are mean, cocky, boastful and rowdy. Approximately 33% are cannibals and/or sadistic.

**Typical Level of Experience & O.C.C.s:** 1D4+4th level pirate, sailor, thief, assassin, headhunter, warrior/soldier/mercenary, or vagabond.

**Magic Knowledge:** Varies; only 10% have a background/O.C.C. in the mystic arts. Most are warrior and adventurer types.

**Psionic Powers:** Varies with the character's race and R.C.C.

**Combat, Abilities, Bonuses and Skills:** Vary with race and occupation.

**Weapons:** The types of weapons used by Kryang's Pirates can vary dramatically from brigand to brigand. Many favor Kittani weapons, especially plasma blades and lances. Others prefer Colombian items or weapons from the north (CS, Northern Gun, Wilk's, etc.), while still others prefer magic weapons and techno-wizard items.

# Slavers' Port

## A Splugorth Outpost in South America

**Land Area:** 90 square miles (230 square km).

**Population Breakdown:** Total population 15,000 (plus thousands of bots and tens of thousands of slaves).

Splugorth Overlords: 20%

Kittani: 15%

Powerlords: 5%

High Lords: 1%

Splugorth Slavers: 5%

Blind Warrior Women: 15%

Gargoyles: 15%

Other: 24%

This doesn't count a transient population of 3D6X1000 people (mostly pirates and traders) and a slave population of 4D6X10,000.

Slavers' Port is a heavily defended island north of the mouth of the Amazon. It is the major trading point between Atlantis and South America, although this is changing with the rise of New Dragcona (see the **Kingdom of Lagarto**, elsewhere in this book). Pirate ships dock here by the hundreds! They bring with them their cargo of slaves, exotic animals, and booty. The port also sells Kittani weapons, armor and vehicles, as well as cybernetic augmentation and some bio-wizardry modifications. Hundreds of millions of credits change hands every day in this harbor, making Slavers' Port one of the wealthiest cities on the continent. The Republic of Colombia and rival pirate fleets have considered sacking the town, but the garrison of thousands of Overlords and Kittani warriors, supported by the finest Splugorth weaponry and over 5,000 security drones, prevent most from conducting such a dangerous undertaking. Those who have tried were defeated, captured and sold into slavery.

The Port has a fleet of 12 **Slave Raider ships**; at any one time 2D4 will be out of the harbor conducting raids on the continent or carrying their cargo to larger Mother Ships, which in turn take the cargo (usually slaves) to Atlantis. Independent pirates arrive in great numbers and the harbor can accommodate as many as 30 large ships and 50 to 60 smaller boats. The port is dominated by the **Slavers' Block**, a huge stage where hundreds of slaves are examined, purchased and sent to the pens that take up a third of the whole town. The slave pens offer many different types of accommodations. These range from relatively spacious rooms for valuable slaves (i.e., those with skills or powers that will fetch a high price) to overcrowded, filthy hellholes for the least valuable or those designated as food/livestock for their monster owners! Many different types of technological and magical measures are used to imprison and watch-over the slaves to prevent escapes or revolts.

The rest of the town consists of inns, taverns, stores, shops, and homes. The architecture of the buildings is reminiscent of Roman and Greek styles. The streets are straight and numbered, making it easy for newcomers to find their way around. A **Splugorth-style** pyramid overlooks the port from the top of a hill. It is used to siphon power from a nexus point as a means of power, defense and transportation. In an emergency, inhuman troops from Splynn can travel via dimensional Rift, reinforcing the garrison in a matter of minutes. The pyramid can also unleash a ley line storm right outside the harbor with disastrous results for any ships caught in its wake.



## Other Pirates

Some pirate kingdoms of note include the **Brethren of the Coast**, a human-dominated pirate band that often raids Colombia; the **River Rats**, who operate off the Amazon river and use small boats and hydro-bikes; and **The Wreckers**, a group of raiders led by a circle of air and water warlocks who create storms that drag ships into treacherous reefs where they are smashed — the Wreckers then kill the survivors and loot the sinking ships.

There are also many part-time pirates. These are merchant ships that will attack a smaller vessel if the two encounter each other out in the open sea, away from witnesses. These part-timers are **very** careful to **conceal** their crimes and **will usually** kill everyone they rob, or sell them to the **Splugorth**.

Game Masters are free to develop other pirate communities (there are scores of them) as their needs and desires dictate. Remember, a pirate clan, port or kingdom can be rich or poor, use magic or technology (high or low) or both. Most have low to moderate levels of education, wealth, resources and technology. The smallest and worst equipped gangs will be little more than illiterate thugs, bullies and vagabonds who rely on traps, ambushes and pure muscle to rob others. They will have few expensive weapons or magic items and are not likely to number more than a two dozen.

## New O.C.C.S Sailor O.C.C.

South America, is broken into hundreds of islands and fragmented by scores of rivers and streams, thus its people rely heavily on water travel. Thus, a whole class of sailors and seafarers has developed. The disparity of technology levels in different areas means that in some places sailors will be using simple square-rigged sailboats, while others may crew nuclear-powered submersible ships able to outperform any vessel of the 20th century! Depending on the background of the **character**, he or she may be familiar with different or even all kinds of technological seafaring techniques.

The sailors of Rifts Earth have to be a combination traveler, warrior and explorer. In many respects, the sailor O.C.C. is the most dangerous, because they willingly pit themselves against the many dangers of the sea (and subsequently, air). A ship is vulnerable to assault from sea serpents, harpies, magic and pirates, as well as the elements themselves. Storms, rough waters, high winds, fog, rocks, ice, heat, cold, lost direction, hunger, loneliness, and despair are all enemies of seafaring men and women. However, the mystery, intrigue, foods, sights and adventures in far-away lands make it an exciting occupation that lures the wayward and wandering spirit. Most people who choose the sailor's life are seeking adventure, face poverty and starvation at home, or are fleeing an enemy (or the law).

The goal of many sailors is to either save up enough money to retire in comfort or to become the captain of their own ship.

Others never look that far ahead and live for the moment. Pay varies from place to place. Usually, it is determined by the skills and experience of the sailor and the length of the trip. Most captains withhold some or all the payment until the trip is completed; this helps to prevent desertion. While aboard a ship, the captain and his officers are "The" law, and the sailor is expected to obey completely or suffer the consequences.

**Alignment:** Any

**Attribute Requirements:** P.S. 7 or higher. A good P.P. and P.E. is ideal, but not a requirement.

**O.C.C. Abilities and Bonuses:** Add +10 to S.D.C. and 1D4 to P.E. attribute.

**O.C.C. Skills:**

Radio: Basic (+10%)

Two Languages (+10%)

Boat: **Sail Type** (+15%)

Boat: Motor and Hydrofoils (+10% each)

Boat: Ships (+20%)

Fishing (+10%)

Climbing (+10%)

Ship Mechanics (treat like Aircraft Mechanics; +5%)

Swimming (+20%)

Boat Building (+5%)

Carpentry (+5%)

One W.P. of choice

Hand to Hand: Basic

Hand to Hand: Basic can be changed to hand to hand Expert at the cost of one "other" skill or Martial Arts (or assassin if an evil alignment) for the cost of two "other" skills.

**O.C.C. Related Skills:** Select 8 other skills; at least one has to be pilot related and one physical.

Communications: Any (+5%)

Domestic: Any (+5%)

Electrical: Basic Electronics only

Espionage: Any

Mechanical: Any

Medical: First Aid and Holistic Medicine only

Military: None

Physical: Any (+5% where applicable)

Pilot: Any (5%)

Pilot Related: Any (+10%)

Rogue: Any (+8%)

Science: Math: basic, anthropology and astronomy only (+10%).

Technical: Any (+10% to lores and languages)

W.P.: Any

Wilderness: Any (+5%)

**Secondary Skills:** The character also gets to select four secondary skills from the previous list at level one, plus another two at levels four, six and eight. These are additional areas of knowledge that do not get the advantage of the bonuses listed in parentheses. All secondary skills start at the base skill level. Also, skills are limited as previously indicated in the list.

**Standard Equipment:** Light M.D.C. body armor with built-in floaters (add 10% to the armor cost and reduce prowling by 5%, but allows the character to swim while wearing armor), two weapons of choice (usually nothing larger than an energy rifle and an archaic weapon like a knife), fishing line and hooks, compass, flashlight, backpack, knapsack, and mess kit.

**Money:** 1D6×100 credits and 2D6×1000 in black market saleable items.

**Cybernetics:** Starts with none. May or may not be opposed to cybernetics and bionics.

## Pirate O.C.C.

Piracy as a profession is as old as sea travel itself. From the Sea People of Egyptian times to the buccaneers of the Caribbean, seafaring rogues and cutthroats have made their fortune by plundering merchant vessels, kidnapping, extortion and raids. Sometimes, the pirates are sailors who lack any legitimate employment, so they turn to crime to support themselves. Often, however, they are professional criminals.

On Rifts Earth, piracy involves searching for and attacking other ships and raiding coastal towns and merchant caravans. Some pirate bands travel deep inland to hit valuable targets, sending armed groups as far as 100 miles (160 km) into the mainland in search of booty. Traditionally, pay is based on the booty found. Large pirate operations pay a small percentage of plunder (0.5 to 1% of the total value). The captain and his first mate get the largest portion, usually 30-40% to the captain and 10 to 20% to his first mate. Smaller groups divide the plunder evenly into shares, with the captain getting four to ten shares and the first mate, petty officers and other valuable crew members receiving two to five shares. Food, room and board is provided on the ship at no cost for the crew.

Some pirates become privateers. Privateers are licensed by a nation or kingdom to attack and plunder a rival nation. The license allows these corsairs to return to the licensing nation for repairs and protection; in return, the kingdom receives a percentage of all plunder acquired, usually 10-40% of the total. A few coast kingdoms in North and South America have been granting privateer licenses to seafaring mercenary groups.

A few pirate bands do not kill, rape or plunder indiscriminately, but limit their attacks to rich or tyrannical targets like modern Robin Hoods of the seas. The vast majority are brigands with little respect for life or dignity. About 50% of the profits made by pirates comes from the slave trade. The **Splugorth** flesh merchants pay top price for healthy captives, so even a raid on a poor village will be profitable. Pirate slavers know that their victims will be ruthlessly exploited and often slaughtered as foodstock by the inhuman Minions of Splugorth, so only the most evil people will engage in slave running.

**Note:** Many other O.C.C.s will be included among a pirate crew. At least 20% will be members of the sailor O.C.C., and many pirates are juicers, headhunters, city rats, operators, smugglers and others.

**Alignment:** Usually selfish or evil; pirates of good alignments are almost unheard of and typically limited to privateers and Robin Hood types.

**Attribute Requirements:** P.S. 7, P.P. 8

**O.C.C. Abilities and Bonuses:** Add 2D6+6 to S.D.C. and 1D4 to P.E. attribute.

**O.C.C. Skills:**

Radio: Basic (+10%)

Two Languages (+10%)

Boat: Two types (+15%)



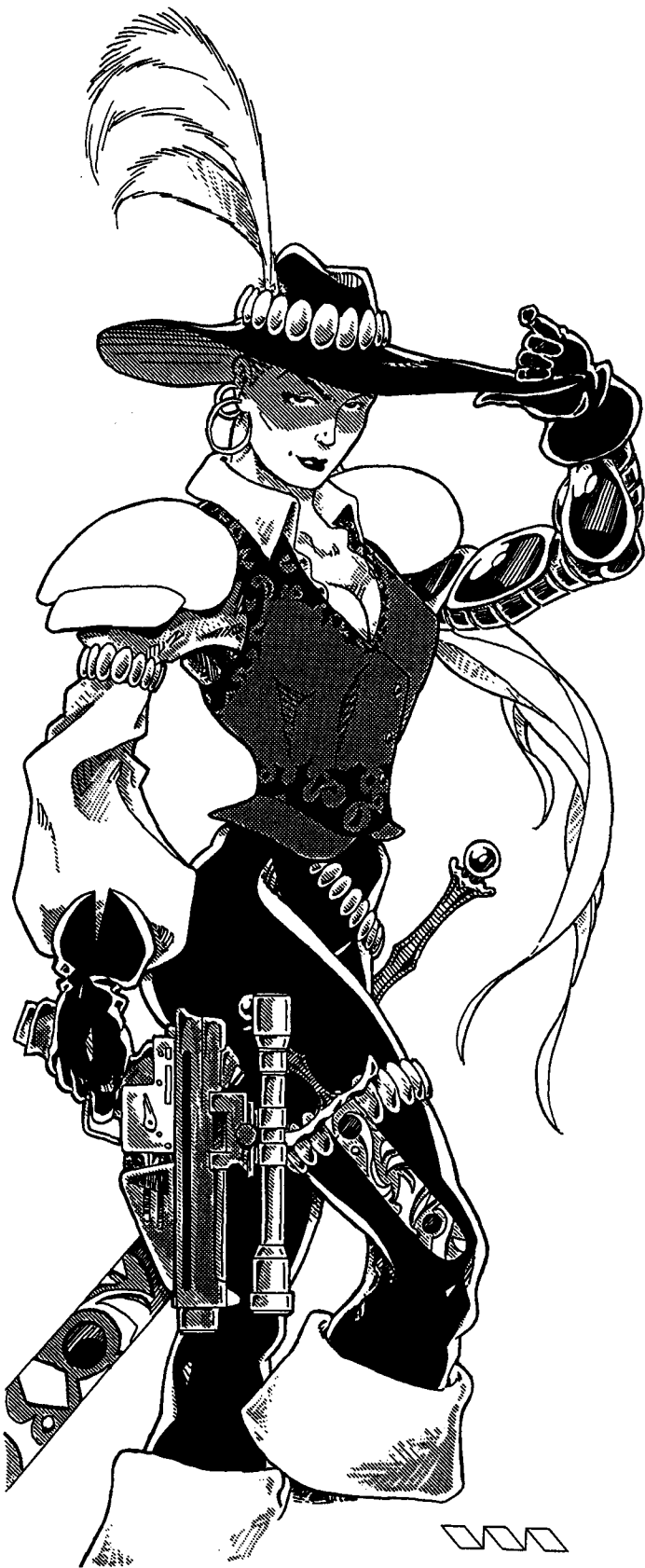

**O.C.C. Related Skills:** Select 7 other skills; at least one has to be pilot or pilot related and one physical.

Communications: Any (+5%)

Domestic: Any

Electrical: Basic Electronics only

Espionage: Any (+15%)

Mechanical: Any

Medical: First Aid and Holistic Medicine only

Military: None

Physical: Any (+5% where applicable)

Pilot: Any (+10%)

Pilot Related: Any (+10%)

Rogue: Any (+12%)

Science: Math: basic, anthropology and astronomy only (+5%).

Technical: Any (+10% to lore and languages)

W.P.: Any

Wilderness: Any (+5%)

**Secondary Skills:** The character also gets to select three secondary skills from the previous list at level one, plus another two at levels three, five, nine and thirteen. These are additional areas of knowledge that do not get the advantage of the bonuses listed in parentheses. All secondary skills start at the base skill level. Also, skills are limited as previously indicated in the list.

**Standard Equipment:** Two energy weapons of choice and two archaic weapons, a suit of M.D.C. body armor, first aid kit, handcuffs, mess kit, sleeping bag, 100 feet (30.5 m) of rope and a grappling hook.

**Money:** 1D4×1000 in credits and 3D4×1000 in saleable black market items.

**Cybernetics:** The pirate may have 1D4 cybernetic implants. In relatively primitive areas (like most of South America), cybernetic items are relatively rare, but contact with the **Splurgorth** makes them more available to pirates. Wealthy pirates (not first level characters) can even afford bio-wizardry treatments (see **Rifts Atlantis** for more information).

## Other O.C.C.S

Also see the **Amazon**, **Anti-Monster**, **Biomancer**, **Jungle Elf**, **Ewaipanomas**, **Felinoids**, **Jungle Shaman**, **Totem Warrior**, **Voodoo Priest** and others — each described in their corresponding region of habitat or influence.

Virtually any of the O.C.C.s and R.C.C.s found in the **Rifts RPG**, **Rifts Sourcebook One**, **Vampire Kingdoms**, **Rifts Mercenaries**, **Rift Africa** and **Rifts Atlantis** can be used in the South American setting, as well as the herbalist and temporal raider found in **Rifts England** and a handful of R.C.C.S from **Wormwood**. In the case of most O.C.C.s, the character is likely to be a native resident of the region. In others, he or she can be a visitor from another part of the world or an alien dimension. Note, however, that while adventurers from the north and east may find their way to South America, the Coalition States, **Lazlo**, **Tolkeen**, the Pecos Empire, **Naruni Enterprises**, the **Xiticix** and other North American powers have virtually no interest or presence in this part of the world. Even forces in Mexico and the Yucatan seldom venture beyond Colombia or into The Land of a Thousand Islands. The people of Europe, Africa and Asia have their own problems, so only shipwrecked travelers far from

Fishing (+5%)

Climbing (+15%)

Ship Mechanics (treat like Aircraft Mechanics; +5%)

Swimming (+20%)

W.P. sword

W.P. energy rifle

W.P. two of choice

Hand to Hand: Expert

Hand to Hand: Expert can be changed to hand to hand Martial Arts (or assassin if an evil alignment) for the cost of one "other" skill.

their homelands may be present in South America. As for Atlantis, the Minions of **Splugorth** (as well as their slave races and renegade minions) have a growing presence as Lord **Splynncryth** quietly and masterfully weaves his web of corruption and infiltration in this part of the world.

---

# The Land of a Thousand Islands

---

To the east and south of Colombia lies the shattered continent that is now known as the **Land of a Thousand Islands**. Even before the Coming of the Rifts, the Amazon was the largest river in the world. Since the Great Cataclysm, it has become the largest freshwater river in Earth's history! A river that can be navigated by ocean-going vessels along its two main arteries (called Amazon East and Amazon West, respectively) and most of its larger tributaries. The river is crisscrossed with ley lines, mostly up north, but mystic energy continues along its entire length. There are over 40 good-sized islands (20 mile/32 km diameter or greater) and hundreds of smaller ones.

Many of these islands are occupied by pirates. Others have independent villages of humans or D-Bees. The two largest kingdoms among the islands are **Bahia and Maga**, two places where magic, not technology, is the driving force.

## The Kingdom of Bahia

**Author's Note:** The descriptions and O.C.C.s described in this section make mention of the mystical religion of **Voodoo**. Although the word voodoo commonly refers to evil magic, the raising of zombies, and similar mischief, Voodoo is an actual religion worshipped in many places in America. The depiction of Voodoo in this book is pure fantasy and has no relationship to existing religions or reality.

**Size:** Main Island: 21,000 square miles (54,400 square km). Two other islands, New Haiti (named in memory of the other major center of Voodoo, destroyed by the Great Cataclysm) and Porto Principe, add an additional 9,000 square miles (23,300 square km) of territory.

**Population Breakdown:** 900,000 total

Humans: 540,000 (60% of the total population; mostly of Afro-American and Indian descent)

Lizard Men: 90,000 (10% of the total population)

Jungle Elves: 18,000 (2% of the total population)

Dwarves: 9,000 (1% of the total population)

Other D-Bees and supernatural creatures, including four kukulcan dragons, a few hundred faerie, and others, none numbering over 2,000 individuals, represent the remaining 27% of the population.

## History

Even before the Coming of the Rifts, there had been people and cultures who were aware of the supernatural world. One such group existed in Brazil and the Caribbean, among the descendants of African slaves brought to the New World centuries ago. These men and women managed to keep alive some of their traditions and mystic knowledge in the magical religion known popularly as Voodoo. For almost five hundred years, the **Houngans and Mambos** (Voodoo priests and priestesses) had kept alive the world of spirits and enchantment in America. When the Time of the Rifts came, it did not catch them unawares. According to the legends, every priest and priestess in the world started having terrifying nightmares and visions of the disaster to come.



Their **loas** (spirits and gods) advised them to bring the people to a safe haven where they would be protected from the brunt of the cataclysm. However, in the 21st Century, most people had forgotten the old ways, and the houngans and **mambos** were only able to convince a few hundred believers to follow them.

Abandoning everything they couldn't carry, the pilgrims left their cities and towns and ventured into the wilderness, crossing the Brazilian border (with the help of Voodoo priests from French Guyana) and taking refuge in a largely uninhabited area. When the Rifts came, the **houngans** and **mambos'** weak magic powers surged with incredible new strength. Prepared and fortified, the priests were able to defend their people while all around them millions of **nonbelievers** died horribly. Storms and earthquakes battered and tore apart the Earth. The sea rose and swallowed much of the coast. The Amazon river's ripples spread like a living monster. Its many tributaries like massive tentacles splintering the land into hundreds of islands. The largest island was the settlement occupied by the Voodoo pilgrims which was spared the full brunt of the incredible holocaust. It was named after the Brazilian city that had once been a center of Voodoo worship before its destruction by the eruption of the ley lines — Bahia.

Given the large buildings and high standard of living in the area, it would appear that Bahia is a fairly technologically advanced community. However, there are very few factories or high-tech facilities in the city. What little they need in the way of modern equipment is purchased from the Republic of Colombia and the island of Maga. Instead, Bahia depends almost exclusively on magic. The priests' rituals ensure good crops and their magic allows people to build homes, defend themselves and enjoy many comforts usually expected in technological civilizations.

## Government

Bahia is ruled by a monarchy. A King and a Queen co-rule, each sharing equal power. Unlike traditional royalty, the two don't even have to be married to each other! Over Bahia's history, brothers and sisters, a parent and a child, complete strangers, or men and women who didn't particularly like each other have shared the throne. The only requirements are that both have to be respected priests of the Voodoo religion and are selected in a mystical ceremony in which *the spirits* name the two candidates from among the assembled ranks of priests.

The king and queen name a number of government officials, including a General in Chief, a Health Minister, and Tax Collector, among others. They take care of the administration of the kingdom, although they exert little control over the life of the common people. Most taxes are levied on foreign merchants and what little law enforcement there is deals with severe crimes or outside threats. The local Voodoo priests take care of most village affairs.

The villages and towns under Bahia's protection can have any form of government they wish, but if many people complain of injustices committed by that government, the **monarchs** can intervene.

## Society

The people in Bahia live under primitive conditions when compared to such places as the Coalition States, The NGR and even The Republic of Colombia. The major technological centers can be found in the capital city of New **Bahia**, which is the only place where electrical lighting and other comforts like modern plumbing, sewer systems, modern medicine and vehicle repair facilities can be found. Throughout the majority of the kingdom, visitors will **find** scattered villages dedicated to farm-

ing, the raising of livestock, or fishing. Of course, most villages will have a few dedicated craftsmen and artisans such as basket weavers, carpenters, clothes makers, fabric weavers, jewelers, sculptors, tattoo artists, and so on.

The most prestigious and respected people in the villages are Voodoo priests. They are the doctors, judges, advisors and even psychiatrists of the community. They may not be acknowledged as the direct leaders (although they often serve as exactly that), but their word carries a lot of weight with everybody, whether or not they follow the Voodoo beliefs. Other practitioners of magic are also well-regarded, with the exception of evil mages and all necromancers, who are viewed as dangerous monsters. Necromancy has been part of Voodoo in the past, but it was always rejected by the majority of Voodooists. In Bahia, all necromancers are considered potential criminals and not allowed on the island (See **Rifts Africa** for the complete description of the Necromancer, African Witch, Rain Maker and Mind Bleeder).

The people of Bahia tend to view things in a relaxed, unhurried manner. The work gets done, but people are rarely in a rush to do anything. The villagers tend to be happy, boisterous people, given to dance and music. Bahia is also open to beings of all species. D-Bees find themselves cheerfully accepted and treated as equal members of the community, provided they follow the voodoo laws and religion. Only those who break the law suffer any form of persecution. Many non-human beings have become Voodoo priests and have risen in status to the point that no one will be surprised if a D-Bee becomes the next King or Queen of the island kingdom in the near future.

## Rift Activity

Bahia is in a highly magical area; the western coast is particularly active, with a dozen major ley lines and six nexus points. As a result, dimensional Rifts open regularly over the area. The Voodoo priests have a small army of **loa**entities (described elsewhere in this section) posted at nexus points. They are charged with attacking hostile creatures which may emerge and to alert the authorities of incoming danger. Peaceful D-Bees are questioned and allowed to go free. The ley lines also serve as a means of mystic energy for building, healing and defense.

## Foreign Relations

**Atlantis:** Bahia is occasionally raided by **Splugorth** slavers, but the islands' magical defenses make those raids very costly. Beyond that, there is no direct contact between Atlantis and Bahia.

**The Republic of Colombia:** There is trade and open diplomatic relations between the two countries, as well as an informal mutual-assistance accord. Twice in the last twenty years, powerful pirate kings have made it necessary for Colombia and Bahia to join forces and send a combined fleet against pirate raiders. Most of the boats used by the Bahia Coast Guard are purchased from the Colombians.

**Maga Island:** The mysterious and rather reclusive inhabitants of Maga island have little use for outsiders, but they do engage in some limited trade with Bahia. The rulers of Maga consider the people of Bahia to be closer to nature than most and are friendlier towards them than to any other nation in the world.

**The Kingdom of Lagarto:** Human and D-bee refugees from the wars in the east and south come to Bahia in droves. With

them come ominous stories of the new dragon rulers of **Lagarto**. There have been a few skirmishes between **Bahia** patrol boats and lizard men roving bands. Eventually, the Lagarto armies may threaten the shores of Bahia itself. The Voodoo nation is **growing** increasingly concerned about this threat and continue gathering information and to reinforce their defenses.

**The Silver River Republics:** Ships from the SRR make stops in Bahia. Almost all the technology the island has is purchased from either the SRR or Colombia. Besides trade, however, there are no formal ties between them; the two places are too far away.

**The Coalition States:** The same diplomatic mission that has recently arrived to Colombia has made a survey of neighboring lands. In the opinion of the Coalition diplomats, Bahia is a depraved haven for D-bees and sorcerous criminals and its inhabitants practice forbidden demon-worshipping rituals. If the CS and Republic of Colombia become allies, the Coalition diplomats will do their best to convince the Colombian government to sever relations with Bahia.

## The Bahia Militia

The island has a defense force, but there is no standing army, except for an honor guard around the Bahia King and Queen, a mechanized infantry, and the coast guard. In an emergency however, the island kingdom can raise an army of 10,000 volunteers within 24 hours, and ten times that number within a week. On the other hand, Bahia can draw defenders from a large pool of mages, priests and the helpful spirits that they can summon.

Most of the equipment of the Bahia Militia is purchased from Colombia. The island can repair (but not manufacture) robot armor, but not sophisticated electronics or bionics.

### Militia Statistical Data:

**Average level of experience:** 2-5

**Standard Body Armor:** Equivalent to Plastic Man armor (35 M.D.C.).

**Honor Guard:** Biomancer Heavy Chitin Armor (M.D.C. 100).

**Standard Weapons:** C-20 Rocket Pistol, C-40 Rocket Rifle, machete, hand radio, bedroll, mess kit and compass. Honor Guard: as above, plus two bio-weapons.

**Unit Breakdown:** 10,000 soldiers broken down into squads of 10 or 12 and platoons of 24 to 40 soldiers.

**Mechanized Division:** 90 D-20 Light Combat **Exo-Skeletons**, 35 D-30 Power Armor, 20 **K-Universal** Light Power Armor, and 14 G-9A robot vehicles. All are well maintained and combat ready.

**Honor Guard:** Elite combat unit made up of 200 experienced warriors (levels 5-8) equipped with **biomancy** weapons and armor purchased from **Maga Island**.

**Magic Militia:** At any given moment, the Bahia Militia can field 100-140 Voodoo priests, 80-120 warlocks, 60-100 biomancers, 60-100 mystics, 40-80 ley line walkers, and 1D6X10 additional practitioners of magic, most ranging in levels 3-8. An additional 1D4X10 assorted apprentice men of magic (zero to 1st and 2nd levels of experience) serve as assistants or additional support.

**Army of Loa:** 10-20 Voodoo priests will assume control of over 1D6X100 loa spirits. These spirits can wreak havoc with most armies, possessing soldiers and having them attack their

comrades, or using their psionic powers with devastating effects to help divide and conquer the enemy.

**Bahia Coast Guard:** The Bahia Coast Guard consists of 24 "Black Galleon" patrol ships (described elsewhere), purchased from Colombia. Each ship has a team of mages and priests on board, complete with 1D6X10 loa entities as a supernatural strike force.

## Voodoo Priest O.C.C.

The word "voodoo" has often been used to name any "evil" cult that comes along. Voodoo, that is, the magical beliefs of people of African ancestry brought to America, is not an evil system of magic. Quite the contrary. The Voodoo magician-priests (called **houngans** if they are male, or **mambos** if female) are the protectors of their people. They use their magic abilities for the good of the community. There some evil Voodoo priests who misuse their power, but they are a rarity and are avoided or even hunted down and slain by the good.

The Voodoo Priest O.C.C. has several elements in common with the African Priest described in **Rifts Africa**. At the Game Master's discretion, Voodoo priests can know some of the rituals and ceremonies described in **Rifts Africa** on pages 86-91 (if using this option, reduce the other magical abilities as described below). The Medicine Man and Rain Maker O.C.C.s of **Rifts Africa** (as well as the evil African Witch and Necromancer) can also be found among Voodoo practitioners and are treated in the same manner as described in that book.

**Alignment:** Any, but tends to be good or selfish

**Attribute Requirements:** I.Q., M.A. and M.E. of 13 or higher.

### O.C.C. Abilities and Bonuses:

1. **Commune with spirits.** Same as the spell. Only in the case of the priest, he needs only to meditate for a few minutes to talk to entities of all kinds (but especially **loas**). The ability to see and speak to these ghost-like beings does not mean that they will obey the character or be of any help (but see the control spirit and exorcism powers, below).

2. **Control spirits.** The **loas** are a special form of entity (see **Rifts Conversion Book One** for more information about other types of entities). A Voodoo priest can conduct a ceremony (lasting 10 minutes) to summon and control a ghostly or divine loa. The loa can resist by making a save vs magic. A Voodoo priest can control one loa, plus an additional one at levels three, seven, ten and fourteen. Note that most **loas** of a good alignment will want help at least for a while.

There is a 1-55% chance that a Voodoo priest will have one ghostly loa who believes itself to be one of the priest's ancestors. This spirit will stay at the priest's side 50% of the time and always appears during times of trouble and danger that involves the priest or his people. This ghostly loa will offer the priest warnings, observations, advice, and protection. Roll to see if such a spirit helps and protects the Voodoo priest at second level (1-55% chance). A failed roll means no ancestral loa at that time, but roll again at levels four, six, eight, ten, twelve and fourteen, until one is acquired. Only one such ghostly loa ancestor is possible. Lucky priests will acquire one early on. The least lucky never get one. If this particular



spirit should ever be destroyed, there is only a 1-25% chance of acquiring a new ancestral ghost.

**3. Exorcism.** A successful exorcism will drive **out/banish** any entity or lesser demon from a possessed person, animal, dwelling or area. The exorcised creatures cannot return to the place or person for at least 6 months and are likely to never return (86% likelihood). A successful exorcism performed in an area such as a graveyard, tomb, etc., will destroy all animated skeletons, corpses and mummies which inhabit the area of exorcism. Ghouls and zombies will be banished for 10 months, while the greater supernatural creatures, including lesser devils and demons, vampires, ghosts, wraiths and specters, are banished for 6 months.

The Rite of Exorcism: An exorcism requires 1-6 hours of prayer and meditation to perform the rite, depending on the strength of the **possessing/inhabiting** force. The holy symbols of the priest's religion are necessary and it is wise to have assistants and bodyguards, should fighting be involved. Success ratio: 8% per level of experience. Can be attempted as many times as the priest wants.

**4. Turn Dead.** This rite is similar to exorcism, but it can be enacted in only two melee rounds and affects only animated skeletons and corpses, mummies and ghouls. This ability enables the priest to **turn/repel** the dead by commanding them to leave in the name of his deity(s). The dead will stop what

they were doing and go away. Vampires, ghosts, wraiths, **loas** and specters may be temporarily kept at bay (a few feet/a meter away), hesitating for one or two melee rounds, but will not be otherwise affected. Demons and devils are not affected at all. Success Ratio: 20% at first level, plus 5% per additional level of experience.

**5. Spell Magic.** At first level, the voodoo priest can select four spells from levels 1-4. At each additional level, the voodoo priest can select an additional two spells equal or lower than his current level of experience. These spells are learned in a manner similar to the mystic; additional spells cannot be purchased or learned. **Note:** If the GM allows the voodoo priest to have access to the rituals and ceremonies of the African Priest (see **Rifts Africa**), then the priest only knows three spells at first level, and one spell per additional level.

**P.P.E.:** The P.E. attribute times three, plus 2D6 P.P.E. per level of experience. Additional P.P.E. is drawn through ritual ceremonies, singing, chanting and animal sacrifices, as well as from ley lines.

**6. Bonuses.** +1 to save vs poison and drugs, +2 to save vs magic curses and disease, +4 to save vs possession, and +4 to save vs horror factor.

**O.C.C. Skills:**

Speaks native tongue 98%

Speaks two additional languages (usually Creole and Span-

Lore: Monsters & Demons (+15%)  
 Wilderness Survival (+15%)  
 Holistic Medicine (+10%)  
 Basic Math (+20%)  
 Dance (+10%)  
 Sing (+10%)  
 Preserve Foods (+15%)  
 Track Animals (+10%)  
 W.P. Blunt  
 W.P. of choice  
 Hand to Hand: Basic  
 Hand to hand: basic can be changed to hand to hand: expert at the cost of one "other" skill or martial arts for the cost of two "other" skills.

**O.C.C. Related Skills:** Select five "other" skills. Plus select two additional skills at level three, one at level five, one at level eight, and one at level twelve. All new skills start at level one proficiency.

Communications: Any  
 Domestic: Any (+10%)  
 Electrical: None  
 Espionage: None  
 Mechanical: None  
 Medical: Any (+10%)  
 Military: None  
 Physical: Any  
 Pilot: Any  
 Pilot Related: Any  
 Rogue: Any  
 Science: Any (+10%)  
 Technical: Any (+15%)  
 Wilderness: Any (+10%)  
 W.P. Any

**Secondary Skills:** The character also gets to select five secondary skills from the previous list. These are additional areas of knowledge that do not get the advantage of the bonus listed in parentheses. All secondary skills start at the base skill level. Also, skills are limited (any, only, none) as previously indicated in that list.

**Standard Equipment:** Set of everyday clothes, ceremonial robes and costume, assorted ceremonial tools (knives, candles, incense, stick of calk, etc.), four small sacks, backpack, first-aid kit with assorted herbs, teas, and other medicines. 30% will have an energy weapon and 1D4 spare E-clips, 30% will have a bio-weapon, 30% will have a Techno-Wizard weapon, and 10% will have one energy weapon and a TWor biomancy weapon.

**Money:** 2D6×1000 credits' and 2D4×1000 credits worth of saleable items, including herbs and teas.

**Cybernetics:** Starts with none and will avoid them because they interfere with magic and are not natural.

## Loas — Spirit Entities

Voodoo magic involves dealing with and controlling loas (spirits). There are two types of loas, greater and lesser. The lesser loas are a form of supernatural entity/energy being that is invisible to the human eye. Common entities include the poltergeist, syphon, tectonic and possessing entities.

Greater loas are the equivalent of gods and supernatural intelligences. Most have their own pantheon (to be fully described in a future Rifts Conversion Book). The Greater Loas rarely intervene directly in the affairs of mortals. The names and areas of magic used by some Voodoo gods are listed below:

**Legba:** God of magic and crossroads.

**Ertzuli:** Goddess of lust and love.

**Danbhalá:** Snake god of wisdom.

**Chango:** God of lightning and the storm.

**Oggun:** God of fire, metal and war.

### The Loas

**Ghostly Loa:** The typical loa (90%) is an entity similar to the traditional haunting/ghost and possessing entities. Like the haunting entity, the loas identify themselves with specific dead people and come to believe they are the ghostly spirit of that individual. This character can be either a dead human or D-bee.

Ghostly Loas are attracted to certain funeral rituals, particularly those of the Voodoo belief. These loas become imprinted with the person's memories and know most everything the dead person knew or felt. Their I.Q., skill recollections and personality become the same as those of the deceased person. Most ghostly loas will try to protect the dead person's family, friends, clan, community or nation. The more religious rituals and honor the spirit is given, the longer he will remain as the protector of the people and ideals the deceased had stood for. On the other hand, loas that imprinted on evil people will try to hurt the living to get the P.P.E. they need. Ghostly loas are able to possess humans and animals and use a variety of psionic powers.

**Divine Loas** are entities who associate with one of the Voodoo Gods. They feed off the P.P.E. used in religious ceremonies and rituals only. The "real" gods allow these loas to do so because they use them as agents and servants. So, for example, the god Oggun will be able to command thousands of minor Oggun-loas. Divine loas also have the power of possession, plus they have a specific set of psionic powers determined by the god they are representing.

**Alignment:** Any, but the majority are good or selfish alignments.

**Attributes:** Only the mental attributes are applicable to the loa in energy form. The divine loa has an I.Q. 18, M.A. 17, and M.E. 17. The ghostly loas have the I.Q., M.A. and M.E. "imprint" of the specific dead person it believes it is.

**S.D.C. & Hit Points (in S.D.C. environments):** 1D4X10 S.D.C. and 5D6 hit points in energy form.

**M.D.C. (in Mega-Damage environments):** 1D4X10+40; becomes a minor mega-damage energy creature when on Rifts Earth.

**Horror Factor:** 10 for ghostly loas or 12 for divine loas.  
 P.P.E.: 1D4+4 for ghostly loas or 1D6+6 for divine loas.

**Natural Abilities:** The natural state of the loa is an invisible en-

ergy being that is impervious to physical and energy attacks, including poisons, explosions and mega-damage weapons. Only magic and psionic attacks can damage a loa entity. While in its natural entity state it can hover and fly (speed 22 for ghostly, 33 for divine) and is completely intangible, able to pass without negative effect or damage through walls, people and physical obstacles.

The ghostly loa can make itself semi-visible as a transparent, ghostly image of the person it thinks it is (horror factor 10). The divine loa can make a similar appearance but has only a vaguely humanoid appearance and may have the wings of an angel.

**Imprinting:** The energy loas will imprint, and identify with a deceased human or D-bee and assume his or her identity/personality and I.Q., but retains its energy body. Only the strongest emotions and memories of the dead person are known by the loa (such as feelings toward family, friends, enemies, goals, love, hate, fear, etc.); the less important memories are dim recollections. **Note:** A divine loa believes it to be the life essence of a Voodoo god.

**Possession:** The loa can only assume physical shape by possessing humans, D-bees or animals (but not other supernatural beings or powerful creatures of magic). When possessing the living, the creature uses the physical attributes of the host body (plus bonuses described previously) but not the skills or memory of the possessed character. The entity retains the memories and skills of the deceased person with whom it has been imprinted. Possession by a loa can be resisted with a successful save vs psionics. A willing "mount" does not save.

When possessing a person, the loa gives the character a temporary bonus of +2D4 to P.S., +1D6 to P.P., +2D4 to P.E., and +100 S.D.C. This allows the possessed people to perform incredible feats of strength and endurance, including chewing and eating glass, walking over burning coals without pain and minimal damage, making enormous leaps, etc. All damage from such activities is first taken off the bonus S.D.C. When the possession is over, all the attribute and S.D.C. bonuses disappear. If the possessed person took more than 100 S.D.C. worth of damage, the rest of the damage applies normally to the person's own S.D.C. and hit points. The loa can use all its psionic abilities while possessing a physical host body.

**P.P.E. Vampire:** All entities, including the loas, feed on P.P.E. The ghostly loa needs 40 P.P.E. a week and the divine loa needs 60 P.P.E. a week. The ghostly loa feeds on P.P.E. released by ley lines, magic ceremonies and energies released at the moment of a person's or animal's death. The divine loa can only feed on P.P.E. released during magic and Voodoo ceremonies, ley line nexuses, or from P.P.E. given to it freely by a Voodoo priest or the god it is associated with.

**Psionic Abilities of Ghostly Loas:** The creature has two super-psionic powers that match the deceased character's personality and occupation. A warrior, for example, could have psi-sword and telekinetic force field, a magician might have mind bolt and empathic transmission, while a parent or teacher is more likely to have protective or nurturing abilities. Or, one super psionic power can be replaced with two sensitive or healing powers, for a total of one super psionic ability and two lesser psionic powers. All psionic powers are used as

if the loa was a 6th level mind melter. Available I.S.P. is equal to the loa's P.E. times six.

**Psionic Abilities of Divine Loas:** I.Q. 18, I.S.P. is equal to P.P.E. times 10, two sensitive or healing powers of choice and the following super psionic powers are available depending on which god the spirit is associated with:

**Legba:** Hydrokinesis and mind bond.

**Ertzuli:** Empathic transmission and hypnotic suggestion.

**Danbhalá:** Bio-manipulation and mind bond.

**Chango:** Pyrokinesis and psi sword.

**Oggun:** Telemechanics and psi sword.

**Combat:** Five psionic attacks per melee when in spirit/energy form, or five physical or psionic attacks when possessing a physical body (regardless of the deceased's past combat skills).

**Bonuses:** +2 to initiative, +2 to strike, +4 to parry and dodge, +2 to pull **punch/roll** with impact, +3 to save vs magic and psionics, +10 to save vs horror factor. All bonuses apply to both the physical and spirit form.

**Damage:** By psionics, physical attacks, or weapon.

**Magic:** None

**Languages and Skills:** Ghostly loas know the skills and languages of the imprinted person. Divine loas know French, Spanish, Creole and all African languages at 98%, plus **Demon/Monster Lore** and **Voodoo Lore** at 98%, wilderness survival 72%, track humans and animals 76% and prowl 88%, and W.P. spear, and W.P. blunt.

**Habitat:** Anywhere. The loas follow believers of Voodoo, which can be found mostly in South America and the African West Coast, but also in parts of North America.

**Enemies:** Other entities and supernatural creatures.

**Size:** About 5 feet (1.5 m) tall as an energy being.

**Weight:** Not applicable.

**Note:** Loas are NOT intended to be player characters. They are supernatural entities with limited abilities and understanding of human affairs best used as enemy monsters or potentially friendly Non-Player Characters. As friendly NPCs the loas will be most inclined to help Voodoo priests, believers in Voodoo (like the people of **Bahia**) and the friends, family and descendants of the deceased person from whom they are imprinted. Voodoo spirits may offer warnings, encouragement, insight and clues by visiting or possessing a priest or individual as a ghostly spirit. They may also help in a more direct way via possession or psionics — usually under the leadership of a Voodoo priest.

---

## Maga Island

---

**Size:** 8,000 square miles (20,700 square km). Associated islands add an additional 10,000 square miles of territory (25,900 square km).

**Population Breakdown:** Total 300,000

Human 30%

Jungle Elves 30%

Faeries (mostly Common, Green wood and Tree Sprites) 22%

Lizard Men 5%

Dwarves 2%

Elves (Palladium world), 1%

Other D-Bees and supernatural creatures 10% (including over a dozen hatchling dragons of diverse types, a community of 1D4 x 100 Adarok "mountain men," and others).

Maga Island is a center of learning and magic knowledge. Its founders are a mixture of human Amazon Indians of a dozen different tribes, and the mysterious newcomers known as the Jungle Elves, masters of **biomancy**.

At first sight, the island would appear to be a primitive, nearly uninhabited place. Anybody flying over the island would only see a thick, impenetrable canopy, broken by an occasional clearing and little else. Visitors will discover that all the trees on the island are M.D.C. structures and almost impossible to cut down through normal means.

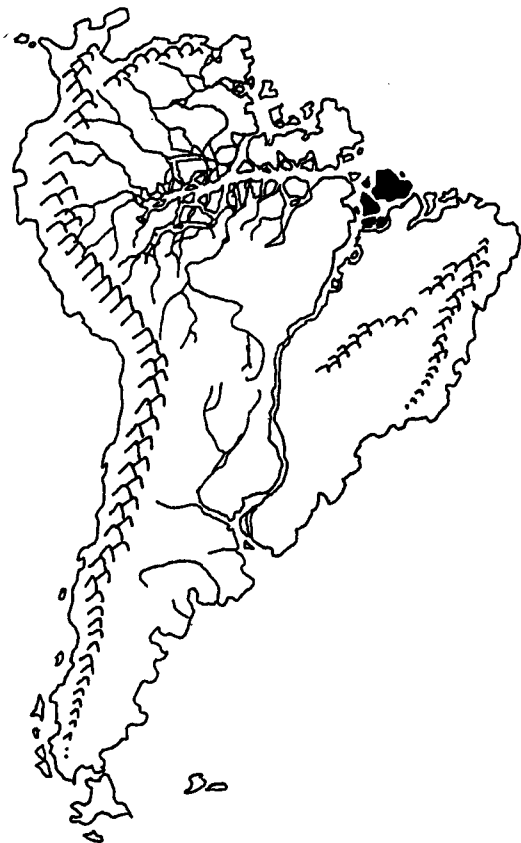

Beneath the thick forests is an amazing civilization that never cuts or damages trees, plants and harvest crops while living in harmony with nature. The large island is the home of an advanced civilization that is almost totally based on magic. The housing, feeding and security of Maga Island's inhabitants is provided by the **biomancers**, a special group of mages who have learned to gently manipulate nature to achieve their ends. Only in the otherworldly dimension of Wormwood and a few areas of England can one find such a close relationship between the people and their environment.

## History

The jungle elves keep no written records. Their history is transmitted orally and magically, and kept in their wondrous Memory Trees. They arrived on Earth carrying the seeds of these trees, seeds that contained all their previous history. According to the tales told by the Memory Trees, the jungle elves were denizens of a forest-covered planet identified simply as the "Green World." On this planet, the elves and diverse faerie races

coexisted peacefully. For tens of thousands of years the jungle elves lived in amazing balance with nature.

The **Megaverse**, however, is a harsh and unforgiving place. One day, dimensional Rifts ripped open the skies of the Green World and an invading army poured through the cracks in reality. The Memory Trees show images of tall **humanoids** in power armor, huge monsters, and dozens of alien beings. Most inhabitants of Rifts Earth will recognize the invaders to be the Minions of **Splugorth** trying to claim yet another world for themselves.

Although war and violence had been all but unknown among the people of the Green World, they rallied to defend themselves. The struggle went on for years. The jungle elves received help from Splugorth renegades and **transdimensional** heroes like the **Atlantean** Undead Slayers. From them they learned the arts of war. Biomancy, which had only been a purely beneficial form of magic, was transformed to become a powerful weapon. The Splugorth servitors were surprised by tiny Elves who suddenly transformed themselves into killing machines able to tear apart a **Kittani** warrior in full serpent power armor. Despite their most valiant efforts, the invaders gained the upper hand and Green World fell to the aliens.

The Splugorth lord who led the invasion was cruel and savage even by its species' standards. When the jungle elves used the forest itself as a weapon, the Splugorth retaliated with defoliants and plasma bombardments, laying waste to whole continents and obliterating the eons-old ecosystem. As the jungle elves prepared themselves for a fight to the death, they made a fateful decision — to send a colony of their people to another world so that their race might survive, in case the war was lost. Aided by transdimensional magic stolen from their enemies, ten thousand jungle elves and as many faeries, carrying seeds and saplings from thousands of plant species, were Rifted to different places in the Megaverse. The largest group arrived on Rifts Earth, not too long after the Coming of the Rifts.

To the jungle elves, the Amazonian rain forest was as similar to their lost home as they could hope for. The Elves scattered throughout the land, but the largest tribe stayed on a group of islands off the Greater Amazon. These islands would act as a refuge and haven. A rallying place in case of an emergency. The jungle elves and their faerie allies befriended the human and D-Bee inhabitants already living on the island and taught them the secrets of biomancy. They believed that such knowledge was a gift and that those who learned it would gain more understanding, love and respect for nature. From these alliances, the Kingdom of Maga Island was born.

This loose confederacy of islands has become a magical haven where no buildings are erected and no trees are cut down. Using biomancy and elemental magic, houses have been built without harming a single tree. A few earth and stone dwellings exist, created by magic, but they are hidden under the roots of trees so that to a casual observer the whole island seems to be covered by plant life. The human and **D-bee** inhabitants have adopted the customs and habits of the jungle elves. They live under seemingly primitive conditions, wearing vegetable fiber clothing and using few tools and technology. The only exceptions to this rule can be found along some strips of the coastline where more "normal" looking towns, mostly peopled by dwarves, have been established to conduct trade with the outside world. They also act as the first line of defense against pirates.



Even these towns are different, built *completely* out of stone through earth and stone magic. The militias in the stone towns are well equipped with modern energy weapons, **techno-wizard** items and modern equipment, much of which is acquired from Colombia or Atlantis via seafaring merchants and pirates.

## Government

The jungle elves follow the orders of the **Tree Council**. Most outsiders believe this is a name for some sort of parliament, but in fact the name is the literal truth. The Tree Council has no elves or any human or D-Bee members. It is made up of a circle of **ancient** Trees of Wisdom; intelligent, telepathic trees that the jungle elves brought with them from their **homeworld**. It is also said that the eldest, most powerful **biomancers** become Trees of Wisdom by undergoing a permanent transformation.

Maga island is a free, mostly unregulated community. It lives by one simple rule: do not harm any living thing within the island territory. This harm doesn't have to be blatant. Accidentally polluting the environment, damaging the water supply, destroying food supplies, **hunting/killing** for pleasure/sport (rather than for food), and vandalism of trees, forest or crops are all considered to be harmful to life in the community and are not tolerated. Those who break the rule may be forced to do community service, face exile, or even be executed. Invaders and dangerous criminals are killed outright. By their wantonly cruel and destructive actions, those individuals are seen as a pestilence that must be eliminated. Note: There isn't much of a legal system in the Maga Confederacy. Complex issues are judged by the Tree Council and its decisions are final. Thankfully, the Tree Council respects life and is usually fair in its decisions.

## Society

Most of the inhabitants of Maga live under a tribal organization. Since the biomancers provide most of the food, clothing and shelter for free, there is very little need for private property. Private property exists, but most people own very little. Instead, the local village or tribe owns most of the goods, and shares them equally among members. Weapons, technological items and other rare articles are usually owned by a community and distributed to those who need them. Disputes are settled by the tribe elders, or failing that, by the Tree Council.

There are a large number of faeries on Maga and the neighboring islands. They live as they are wont to do, freely and without a care. They play harmless pranks on the local humans, but in general treat them with uncommon consideration and courtesy. Jungle elves are always respected and viewed with awe by the usually careless faeries. The little creatures save most of their mischievousness for invaders and unwanted visitors. Wandering faeries in the forests are a powerful line of defense, as many **Splugorth** and pirate raiders have painfully learned.

There are several coastal communities in the islands where this is not the case, however. These towns are peopled by dwarves descended of the same **D-bees** that arrived in Colombia. The jungle elves allowed them to settle on the coasts to provide a safe area for trade and to act as a defensive line. The towns resemble communities found anywhere on Rifts Earth, except for the fact that they use no wood in their buildings, and that most of their houses are built using earth or stone magic. For this reason, most local inhabitants call the **dwarven** communities "Stone

Towns." They are usually located next to a natural harbor to allow ships to dock and are relatively small (the largest one has less than 5,000 inhabitants). Dwarves and humans make up most of the population in the Stone Towns. Even here, most are close to nature and, while they may not live 100% by the rules of the jungle elves, they live under "civilized" conditions. The towns sell **biomancer** products in return for technology and are fairly prosperous. They are very careful not to pollute the environment and they keep a well-armed militia to deal with raiders. Generally speaking, the people of the Stone Towns and the inner island communities of the jungle elves live in peaceful cooperation and mutual respect and friendship.

## Foreign Relations



**Atlantis:** The Minions of the Splugorth are not allowed on the islands under any circumstances. Raids by pirates and Splugorth slavers are not uncommon, but less than half of them manage to make off with any slaves or booty. Many are utterly destroyed. Splugorth bio-wizards are fascinated by **elven** biomancy and want to learn its secrets. Thus, elven biomancers fetch top prices at the Splugorth slave market by purchasers who use magic and torture in an attempt to pry the secrets of biomancy from their slaves. Thus far, the monsters of Atlantis have been unsuccessful in learning biomancy and do not realize how numerous the jungle elves and biomancers are on the island of Maga.

**The Republic of Colombia:** This nation's distrust of most D-Bees has prevented any formal relations with Maga. Many Colombian vessels trade with the coastal towns, however. Some radical Colombians feel that those towns could be convinced to join the Republic and might become the stepping stone towards the conquest of the Maga island chain.

**The Kingdom of Bahia:** This Voodoo controlled island nation has a good relationship with the people of Maga. Voodooists and biomancers often compare notes and work together for the benefit of both kingdoms. If one or the other is threatened, the people of the other island kingdom will come to their aid.

**The Kingdom of Lagarto:** The people of Maga suspect that the Splugorth are behind this rising empire and fear that it will soon attack them. These fears are well-founded. The dragons that rule Lagarto are considering mounting an invasion of the island to uncover its secrets.

**The Silver River Republics:** Other than occasional trade from seafaring merchants, there is no regular or formal contact between Maga and the SRR.

# Jungle Elf R.C.C.

Outsiders know little about jungle elves, **biomancy** or **Maga**. Most regard the elves as a strange race seemingly related to the elves and faerie folk from the Palladium World (although not known in that world). The jungle elves' own legends speak of a primeval world ruled by the Tree of Life, a mountain-sized tree that dwarfs the Millennium Trees and even the mythological Yggdrasil. The jungle elves call themselves "The sons and daughters of the Tree," or "The Champions of the Tree." Some scholars think they are the creation of an ultra-advanced alien civilization, possibly a rival to the people who created the Millennium Trees (see **Rifts England**). It is interesting to note that wherever the jungle elves thrive, the Millennium Trees do not grow, and vice versa. Nor do the jungle elves have any historical knowledge of the great mystic trees. The Jungle Elves have heard about the trees of England and have expressed great admiration for the Millennium Trees, to whom they refer to as their "cousins," but they refer to all plant life as their "brothers" or "cousins."

Jungle elves can form nomadic tribes or permanent communities. The permanent settlements make greater changes in their environment, building huge, living cities of interlocked trees and bush, and create new species of plants that serve the needs of the community. Even those Jungle Elves who do not practice biomancy have the power to modify living things to suit their needs. **Maga** island is the largest and most powerful of all the jungle elves' communities.

Many jungle elves like to explore and wander, especially in jungles and forests. There are nomadic tribes of jungle elves scattered throughout the Amazonian rain forest. One or two jungle elves or biomancer explorers, adventurers or even the occasional tiny nomadic tribes (3D6 members maximum) can be found anywhere in South America. Once in a while, an ambitious jungle elf is encountered as far north as the old Canadian Empire (usually by avoiding vampire infested Mexico via magic or sea travel) and as far east as Africa!

## **Alignment: Any**

**Attributes:** I.Q. 3D6+2, M.E. 3D6, M.A. 4D6, P.S. 2D6+3, P.P. 3D6+3, P.E. 3D6, P.B. 4D6, Spd 4D6.

**S.D.C.:** 20 plus O.C.C. and skill bonuses.

**M.D.C.:** Armor or magic only.

## **R.C.C. Abilities and Bonuses:**

1. Communicate with plants and animals. The jungle elf can contact nearby animals and plants in the same manner as the biomancer, but more effectively. This communication does not occur in the form of words, but in a manner similar to empathy. The jungle elf receives "flashes" of past events involving the animal or plant, but these are limited to the creature's own senses and awareness. For example, a tree will notice if a man-sized creature is climbing on it, or will feel heat if someone fires an energy weapon near its trunk or branches, but it will not be able to see the individuals involved, and neither will the elf who is communicating with it. The communication also allows the jungle elf to calm down enraged animals, but only if the character can project a sense of peacefulness towards the creature. **Chance of Success:** The communication link and "flashes" of insight are automatic, the attempt to calm an animal has a base chance of 40% plus

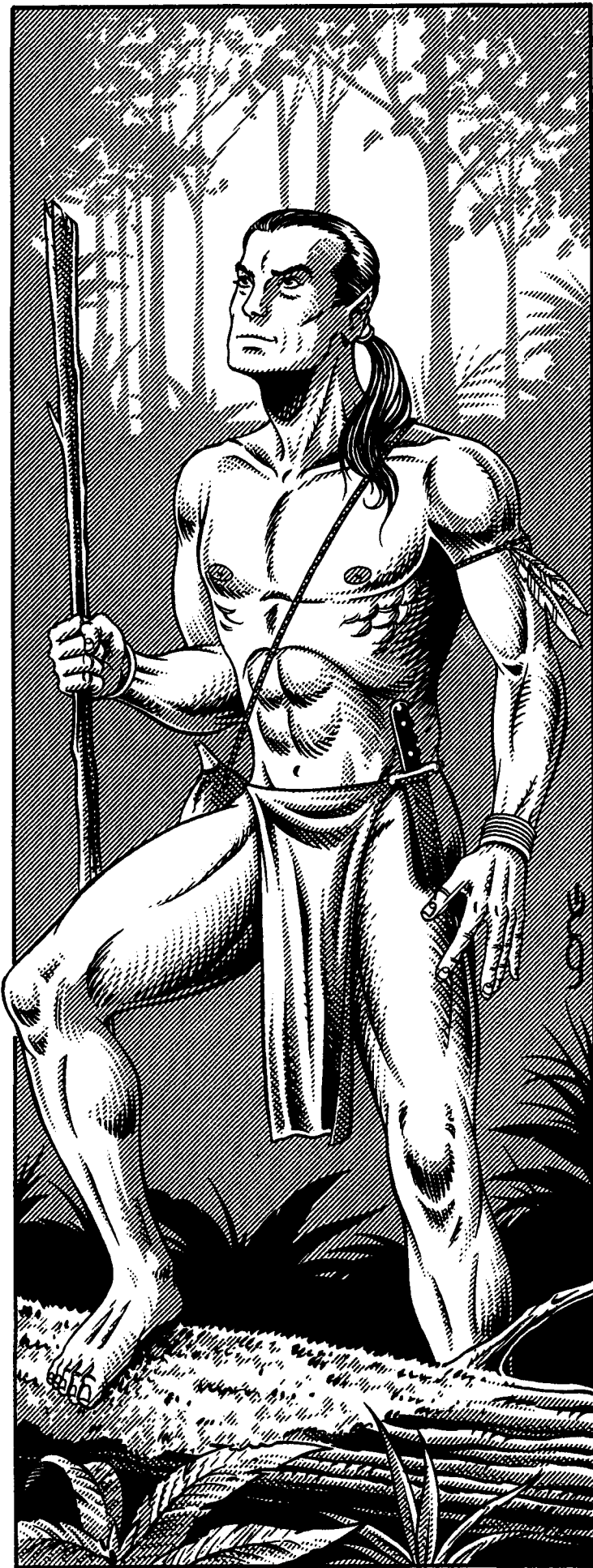

4% per level of experience (does not work against supernatural monsters). Range: 120 feet (36.6 m).

2. The Gift of Nature. All jungle elves can convert living organic matter into edible food! By concentrating and spending 8 P.P.E., the elf can convert part of a living plant into a fruit-like organ (the "Gift"). The fruit has enough nutritional value to keep a person fed for one day. The procedure only works on a tree, bush or large plant, and can only be done on one plant a set number of times. As a rule of thumb, a bush will only provide one "Gift," a man-sized plant 1D4+1 "Gifts", a medium-sized tree 2D6, and so on. The largest, normal trees provide 2D6X10 Gifts of Nature. Trying to exceed a plant's limit (the jungle elf will sense exactly how many times he can ask for a Gift) inflicts 2D6 S.D.C. damage to the plant and generates a psychic backlash that does 1D4X10 S.D.C. to the character (or M.D.C. if the character is a mega-damage creature). **Note:** This power cannot be used on some alien vegetation or Millennium Trees. An attempt will result in temporary injury to the Tree and a mega-damage explosion to anybody near the tree (see **Rifts England** for details of the energy releases of the Millennium Trees).

3. Biomancy Powers. Most jungle elves have some spell knowledge in the field of **biomancy**, even among those who do not follow a magical occupation. Starting at second level, jungle elves mystically know one biomancy spell from the level one category. Every level after the second, they learn one additional biomancy spell. Spells can be selected from any level lower than or equal to the character's current experience level minus one. This means a 5th level jungle elf could learn a 4th level or lower spell, and so on.

4. P.P.E.: The number from the P.E. attribute plus 1D4X10 points. Add another 1D6 P.P.E. points per level of experience.

5. Psionics. Considered to be major psionics. Can learn six powers from the Sensitive, Physical or Healer categories. I.S.P.: M.E. plus 1D4 x 10, plus 2D4 per level of experience.

6. Bonuses. Jungle Elves are at +1 to resist magic and psionic attacks and +2 to save vs horror factor.

7. Skills of Note: All Jungle Elves have wilderness survival starting at 55% at first level (improves normally and is cumulative with IQ or O.C.C. bonuses) and 75% are skilled at archery and targeting. They all speak **Dragonese/Elven** (+25%) and **Faerie** (+20%), in addition to O.C.C. acquired languages.

8. Available O.C.C.s on Rifts Earth: The following O.C.C.s are available to the jungle elf. Each indicates how common they are among the elves. **Note:** Reduce or eliminate most high-tech skills from the standard O.C.C. Most jungle elves reject the trappings of technology and refuse to learn or even use "dead things," as they call machines. Nor do they use cybernetics and bionics.

Typical O.C.C.s among Jungle Elves:

20% **Biomancer**

15% Wilderness Scout or equivalent (eliminate most high-tech skills and replace with skills from the category of domestic, wilderness, W.P. or physical skills).

15% \* Warlock (Earth, Air and Water; only 0.5% are Fire Warlocks who are often shunned by the community; see **Rifts Conversion Book One** for details on the Warlock O.C.C.).

10% Ley Line Walker

10% Herbalist or Druid (see **Rifts England**)

10% \* Mind Melter

5% Mystic

3% \* Shifter/Summoner

3% Totem Warrior (new O.C.C.)

3% Jungle Shaman (new O.C.C.) or African Priest (see **Rifts Africa**)

2% African Rain Maker or Medicine Man (see **Rifts Africa**)

2% Stone Master (see **Rifts Atlantis**)

2% Temporal Wizard (see **Rifts England**)

\* **Note:** Of the O.C.C.s listed above, only the Warlock, Mind Melter, and Shifter/Summoner do NOT possess any biomancy powers. Jungle elves who forsake the ways of the "Green World" and who rely on technology and machines, and/or live in tech cities, lose the powers of biomancy. The power can be regained only after returning to the ways of the jungle elves and living free of machines for 1D4 years (returns in full). Biomancy magic is described after the **biomancer** O.C.C.

**Standard Equipment:** This equipment list takes priority over the individual O.C.C. equipment list. Most Jungle Elves have little use for technology. Those who rely on technology lose their biomancy powers. G.M.s may make some exceptions, such as allowing the character to use an energy weapon or walkie-talkie.

Minimal clothing and supplies, unless travelling away from their beloved rain forest. Owns two archaic weapons (typically one is a bow and arrows) and will have two simple biomancer weapons or one major biomancer weapon, plus a suit of light or medium Chitin or Wood Armor, and an organically grown pouch and backpack.

They may use **techno-wizard** weapons and equipment, herbs and other magic items, but avoid the use of rune weapons, bio-wizardry (not to be confused with biomancy) and similarly imprisoning or destructive forms of magic, which they consider evil and detrimental to life.

**Cybernetics:** Even bio-systems will gravely impair the Jungle Elf's powers: lose all special abilities and reduce P.P.E. by half. No Jungle Elf willingly gets cybernetic or bionic implants and most avoid bio-wizard items as well. Even a single bionic augmentation or pair of cybernetic implants will reduce the range, duration and potency of biomancy magic by half. Bio-system prosthetics or replacement organs are not as detrimental but still reduce the magic by 5% per each bio-system.

## Biomancy Trees & Items

### Trees of Wisdom

These intelligent telepathic trees are the rulers of Maga. They claim to be the descendants of the One Tree, which is said to exist in the Green World imprisoned by the **Splugorth**. Most Trees of Wisdom are on Maga island where they make up the Tree Council. Several dozen other Trees of Wisdom are scattered throughout South America where they act as guides and advisors to jungle elves and **biomancers**.

Trees of Wisdom are exotic plants with segmented trunks, short branches and large, pointed leaves (3 to 12 feet/0.9 to 3.7

m long and 1 to 4 feet/0.3 to 1.2 m wide). Their size ranges from 10 to 50 feet (30 to 15.2 m) tall. These trees are M.D.C. structures and have powerful regeneration capabilities. They are usually a dark shade of green with purple hues. They tend to grow together in groups of 2-24 individuals and prefer to be within 100 feet (30.5 m) of a ley line or ley line nexus. Maga's Tree Council has 48 Trees of Wisdom standing in a perfect circle around a powerful nexus point.

Much like the Millennium Tree, the Trees of Wisdom draw on the P.P.E. of the ley lines to exist and do not need water or nutrients. Perhaps because both tree species compete for P.P.E., neither will ever grow within 1000 miles (1600 km) of the other! The absence of Millennium Trees in South America may be due to the proliferation of Trees of Wisdom on the continent. It is believed that a few grow in the Florida region and other areas of North America which would also explain why no Millennium Trees can be found there, either.

Even if on the verge of destruction or threatened, Trees of Wisdom have developed a way to survive. In an emergency, they can invest their life essence, memories, and personalities on an acorn which can be planted elsewhere and regrown — a sort of mystic resurrection. When its life essence is transformed into an acorn, the original tree loses its consciousness and powers, and withers away, losing 1D6X10 M.D.C. per hour until it finally crumbles to dust. The acorn has 100 M.D.C. and can fall down next to the tree to be picked up by a jungle elf, **biomancer**, Voodoo priest or other trusted ally, or it can "shoot" the seed in a random direction up to a mile (1.6 km) away, hoping it will reach a safe place to grow. The Tree may also transfer its life essence into an **acorn** to feign its death. The acorn can last for centuries without being "planted" and regrown, but the life essence inside is dormant and powerless in a dream-state until it is replanted.

Legends insist that the oldest, wisest and most powerful jungle elves can transform themselves into Trees of Wisdom at the moment of their death. If this is true, it must happen only to the most ancient and wisest — no jungle elf has ever confirmed or denied this myth and many don't believe it themselves (we leave it up to the G.M. whether any wizened elves can transform into a Tree of Wisdom).

**Alignment:** Usually scrupulous or principled; only occasionally selfish or evil (less than 3%).

**Attributes:** Most physical attributes are meaningless. **I.Q.** 2D6+18, **M.A.** 2D6+18, **M.E.** 2D4+20, **P.E.** 2D4+20.

**M.D.C.:** 3D6X100+300 main trunk. Branches have 2D4X10 M.D.C. each.

**Natural Abilities:** Sense environment around them without needing vision (unaffected by invisibility or darkness); range: 2000 feet (610 m) for most sensations involving humans and animals, but up to 20 miles (32 km) when involving forest fires, floods, storms, drought, plagues, earthquakes, ley line eruptions/ebbs and flows, Rifts opening, the Four Horsemen, and similar natural disasters. The tree can also bio-regenerate 4D6X10 M.D.C. every minute, communicate **telepathically** with any intelligent creature at no **I.S.P.** cost (range 2000 feet/610 m), cast spells, use psionic powers, is immune to normal fire, heat and cold (mega-damage fire, heat and cold inflicts half damage) and does not need to breathe air or eat (feeds on P.P.E.).

**Magic:** Trees of Wisdom know the following spells: Cloud of smoke, globe of daylight, chameleon, concealment, fear, turn dead, armor of **Ithan**, energy field, ley line transmission, magic net, domination, calling, energy disruption, horrific illusion, call lightning, words of truth, constrain being, globe of silence, purification, negate magic, oracle, wisps of confusion, banishment, summon and control animals, calm storms, summon rain, and close Rift. All spells are equal to a 10th level ley line walker. **P.P.E.:** 3D4X100, plus what they can draw from ley lines.

**Psionics:** Knows all sensitive powers and bio-manipulation, empathic transmission, hypnotic suggestion, group mind block, mind block auto-defense, mind bolt, mind wipe, telekinesis and telekinetic force field. All equal to a 10th level mind melter. **I.S.P.:** 2D6X100+100.

**Combat:** Three magic or psionic attacks per melee round. Has no physical actions other than spell casting. Creating an acorn can be accomplished in one melee round (15 seconds).

**Bonuses:** +2 to save vs magic and psionics, +10 to save vs horror factor, in addition to attribute bonuses.

**Skills of Note:** Trees of wisdom have the equivalent of a 98% skill in most lores and general knowledge. They know little of technology, but are experts in psychology, herbology, holistic medicine, law and politics. They also have an intrinsic understanding of the workings of magic, ley lines and psionics.

## Memory Trees

---

These spindly trees have pointed, spiral-like trunks and branches, with tiny leaves which are usually grey-green in color with silver hues. Like the Trees of Wisdom, they are intelligent, although not at the genius level. Their main function is to store the history of what goes on around them and to serve as the record keepers of Maga's civilization. They are a combination of computer library and school teacher that communicates **psionically** with their students. All jungle elves and many humans at Maga Island spend part of their childhood communing with the Memory Trees and learning more about their history and current events. Learning is not instantaneous, but it requires about half the time normally spent on reading and studies. This is made possible because the trees are able to recreate memories and transmit knowledge directly into the student's mind. However, time is still required to assimilate and understand the information.

The information exchange is two-sided. While the Memory Trees impart their lessons, they also "record" the memories of their students, provided the sharing is mutual and offered of the student's free will. Popular rumors claim that the Memory Trees will record the memories of any being they encounter, whether given willingly or not. Consequently, many criminals or those with something to hide tend to avoid communicating with the trees entirely. In reality, people who do not desire their memories to be "downloaded" can resist and the Memory Tree will desist. However, it will not share its knowledge with any individual who will not reciprocate in kind.

The communication process is simple. The student sits near the tree (anywhere within 30 feet/9.1 m will do) and concentrates. The tree will answer questions either through telepathic words or it will provide images and the equivalent of virtual reality, having the character experience the events it is relaying. If

a tree does not know an answer, it can communicate with all other Memory Trees within 200 feet (61 m) of it to see if any of its brothers can help. This process can take as little as a few minutes or several hours, depending on the complexity of the question.

Most of the information found in the Memory Trees has to do with the jungle elves and all matters that concern them, including Green World, Maga and **biomancy**. It's up to the Game Master to determine how much knowledge a particular tree may offer, especially in other areas of history and learning. Memory Trees will obey any commands given to them by a Tree of Wisdom, including refusing to divulge secrets or dangerous information. A cluster of Memory Trees might know great secrets of magic or technology (although it is unlikely), but they won't share them with just anybody, especially if the character asking is selfish or evil.

Like the Trees of Wisdom, Memory Trees can invest an acorn with their life essence, memories and consciousness. The first jungle elves that arrived from the Green World brought with them several seeds, each containing the history of their people.

The **Splogorth** have developed bio-wizard techniques to forcibly extract the information found in a Memory Tree, but it only works 20% of the time. Most trees will destroy their memories and consciousness rather than pass them on to this diabolical enemy.

**Alignment:** Always principled!

**Attributes:** Most physical attributes are meaningless. I.Q. 3D6, M.A. 3D6, M.E. 1D4+20, and P.E. 1D4+20.

**M.D.C.:** 1D4X100 main body, 1D4X10 per each average branch.

**Natural Abilities:** Sense environment around them without needing vision (unaffected by invisibility or darkness), with a range of 1000 feet (305 m), bio-regenerate 1D6X10 M.D.C. every minute. Communicates **telepathically** with any intelligent creature at no I.S.P. cost (range 1000 feet/305 m). Immune to normal fire, heat and cold (mega-damage heat and cold inflicts half damage). Can transmit memories and knowledge directly into other minds, and absorb them from others at the same time; sort of a mental exchange of information. A mind block can stop either transmission.

**Magic:** None

**Psionics:** All sensitive powers plus bio-manipulation and empathic transmission. I.S.P.: 1D4X100.

**Combat:** Two psionic attacks per melee round.

**Bonuses:** +1 to save vs magic and psionics, +6 to save vs horror factor.

**Skills of Note:** Most Memory Trees will have a 98% proficiency in several lores (including magic lore), several languages, anthropology, botany, astronomy, mathematics and wilderness skills. They have magic lore at 98%, but cannot teach or learn spell casting, circle making, ward making, biomancy or summoning magic.



# The Biomancer O.C.C.

Biomancers are the ultimate symbiotes of any ecology. They are able to take care of all their needs without using tools or machines, or having to harm any living being. **Biomancy** is one of the most powerful systems of magic ever devised, but is virtually unknown throughout most of the **Megaverse** because it depends on the character's close relationship to nature and an incredibly high regard for life. Biomancers usually feel responsible for the ecosystem they inhabit. Many of them will not go into cities or civilized areas unless absolutely necessary, because they are horrified by the crimes against nature committed in these areas; such as levelling forests, polluting the air, water and land, slaughtering livestock, building houses out of trees and so on. Technology is viewed with distrust and seen as an unholy alliance with "dead" things!

Biomancy is available to humans, all **elven** races, True **Atlanteans**, **simvan**, **psi-stalkers**, **zembahk**, dwarves, dragons and most **humanoid** D-bee races willing to accept the way of life that this magic vocation demands. However, demonic races, predators, and most supernatural beings can NEVER learn **biomancy**. This includes the **Splogorth** and most of their servitor races who rely on technology and destructive or enslaving magic, as well as gargoyles, brodkil, trolls, gromek, most alien intelligences, and "demons" from Wormwood. Gods, demigods and godlings can learn this art, but few have done so. Biomancy is unknown in most parts of the Megaverse. The only known dimensions where it has been found in abundance are the Green World from which the jungle elves migrated, and, now, Rifts Earth which has been influenced by the elves. Most **biomancers** are found in South America, although a few adventurous ones have made their way to North America, Africa and Europe.

Biomancy is the direct magical and philosophical opposite of necromancy, and practitioners of these two schools are deadly enemies. Biomancy should not be confused with Splogorth bio-wizardry which also affects living beings, but is intrusive, enslaving and often damaging. To most biomancers, Splogorth bio-wizardry is a mockery of life. They consider the Splogorth symbiotes and parasites to be unnatural mutations used for foul purposes. Biomancers also abhor the use and creation of rune weapons and will never use them, because they consider their creation process a violation of the **sacredness** of life.

**A Note About Wormwood From C.J. and Siembieda:** If a G.M. chooses to introduce biomancers to a campaign set in the dimension of Wormwood, he'll have to decide whether the **biomancer's** powers work on the living planet. Any power that affects plant and animal life is unlikely to work, since there are few of either on Wormwood. However, the **biomancers** should be able to communicate with the Living Planet like the Wormwood Priest of Light and **Wormspeaker**, just as he communicates with the trees! In fact, the biomancer will have the same *powers of Communion with Wormwood* as the **Wormspeaker** plus life fuel, locate food and resources, and repel symbiotes, but all are at half the usual range and duration.

## The Philosophy of Biomancy

There are three basic "schools" of biomancers. They are known as the Acceptors, the Patient Ones, and the Defenders. The O.C.C. abilities and skills are fundamentally the same for

each. It is their view of the world, their reaction and tolerance to it that defines the three different philosophies.

**The Acceptors**, like their name indicates, tolerate the crimes of most sentient beings against nature as **part** of the process of evolution. They only object to the most extreme acts of inhumanity, pollution, and deforestation; many human, **dwarven** and D-bee biomancers are Acceptors, but almost no jungle elves. The Acceptors can be found in or near cities and are not above travelling in vehicles, living in artificial houses or using technological items. However, they avoid cybernetics, bio-wizardry and rune weapons and exhibit an obvious respect for life and nature. Even these characters are vegetarians and will not hunt or kill any animal or plant except in self defense. Most even avoid eating or harming fish and insects.

**The Patient Ones** do not accept crimes against nature. They prefer to live away from such people and the stench of their cities in all-natural communities. They take no action against the misguided destroyers and polluters, except to try to repair the damage they have inflicted and to defend lands the biomancers and jungle elves have claimed as their domain. They use technology **and/or techno-wizardry** only as a temporary, last resort. They absolutely abhor bio-wizardry, rune weapons and other forms of magic that enslave or damage any life forms. Most biomancers on Maga Island are Patient Ones. Most even avoid eating or harming fish and insects.

The patient ones get along best with characters who have a high regard for all life. They find the use of bots, cybernetics, bionics and artificial augmentation distasteful and treat such characters coolly or with disdain.

**The Defenders** are the most militant and extreme of the biomancers. Not only do they reject the "ways of death" and destruction used by most civilized species, they take an active role in stopping damage to nature. They reject all technology as evil and unnatural and will only use it under the most extreme circumstances (sometimes not even then). Some of them have gone so far as to declare war on city folk, destroying polluting factories and those involved in deforesting the woodlands. Most will punish or slay anyone who dares to damage a tree or slay an animal or fellow being in their presence. The most brutal and extreme punishments are reserved for those who kill or destroy deliberately for pleasure or profit without regard for people, fauna or the land.

The defenders try to avoid associating with meat-eaters, supernatural beings, scientists, operators, robot pilots or other techie characters who insist on using "dead things" **and/or** defile nature. The defender biomancer finds city rats, **headhunters**, cyborgs, bots, crazies, juicers, and other characters who use cybernetic, bionic, robotic or artificial augmentation to be repugnant. Most even frown upon the acceptor biomancers and techno-wizards. Yet the most hated are the so-called demons (who hate, enslave, torment and destroy life), the Splogorth, their minions, **bio-wizards** and the creators of rune weapons/items/magic.

The defender biomancer gets along best with other defenders, patient ones, faerie folk, **druids**, psi-stalkers, simvan, psychics, **cyber-knights** and characters dedicated to defending life, and preserving and nurturing nature.

**A note from Siembieda:** The biomancers and jungle elves are concerned with (and promote) the wise use of the environment and conservation. Through biomancy they have learned to

live in complete harmony with nature, working with and molding it rather than fighting with it. They share the land and work with the plants and animals that inhabit the land. They see plants and animals as their "brothers" and worthy of the same respect, honor and right to live as any human being (maybe more so). They feel closest to their "brother" they because plants are comparatively benign and more accepting than most other living creatures, especially mammals.

The biomancer and jungle elf understand that living creatures must eat and use plants and other animals to survive. They recognize that the way of the predator, although distasteful to them, is an aspect of nature. Thus, while they may be disgusted by hunters or cattle men and their practice of slaying and eating animals and wearing their skins, they do not consider such people to be monsters or criminals if they only kill what they need and use all, or as much of the slain animal, as possible. However, those who kill only for the animal's pelt, horns, or for sport are seen as monsters and **despoilers** of nature.

The same holds true with the use of plants and trees. Again, while they may be personally repulsed by the chopping down of a "brother" tree and seeing it used to build a **shelter/house**, most biomancers are not inclined to punish the perpetrators if the character(s) takes pains to replant and keep the forest alive and healthy. However, those who strip forests bare for their wood, or to make room for crops, cattle, or polluting cities are seen as foul destroyers or indifferent monsters. Those who destroy out of carelessness or out of vindictiveness are viewed with equal disdain and are the ones to feel the wrath of the biomancer.

The biomancer and jungle elf's understanding of nature and their high regard for life make most of these characters forgiving, patient and tolerant of other life forms and their unpleasant ways of life. They try to educate others and encourage change by way of example. They gladly teach other beings who desire to live in greater harmony with nature the way of the jungle elf and even **biomancy** — such as they have done at Maga and other scattered communities throughout South America.

The biomancers try to never become destroyers themselves, although they are not afraid to deal out their own harsh justice and retribution against those who deserve it (this is especially true of the defenders). They have no regard for "dead things" such as the machines, weapons, bots, vehicles, factories and buildings used in technological societies. "Dead things" are frequently the target of their anger and retribution. Slavery of any kind is despised and biomancers will often try to rescue/free the enslaved and slay the enslavers — this judgement includes cruel shifters, bio-wizards and masters of rune magic.

## The Biomancer O.C.C.

**Alignment:** Any, but most are either principled, scrupulous, unprincipled or aberrant. Only a tiny number are anarchist, miscreant or diabolic and they are usually regarded as loathsome renegades to be hated and feared.

Generally, the acceptors tend to be scrupulous or unprincipled. The patient ones are most commonly principled or aberrant, and the defenders go the whole range, with many scrupulous, unprincipled and more than a few aberrant.

**Attribute Requirements:** I.Q. and M.A. of 11 or higher.

## O.C.C. Abilities and Bonuses:

1. **Sense Supernatural Evil.** The biomancer is aware of all things around him in the natural world. Thus, he or she will feel or sense any major disturbances in nature. Supernatural beings, especially evil ones, are destroyers and predators that interfere with the natural order of life. They radiate their alignment and foul intentions, which the biomancer senses like a sickening nausea coursing through his body.

The sensation is unmistakable, costs no I.S.P., and is automatic, meaning that the character does not have to concentrate or focus himself to sense supernatural evil. The sensation is very general, warning the biomancer to the presence of supernatural evil, but without providing specific data. For example, the biomancer will know that an evil supernatural being, or beings, is in the area, but will not know its identity, location, numbers, or level of power. However, he will know whether the being is near or far, a horrible or lesser evil, and whether or not it approaches, waits or is leaving the area. Range: 1000 feet (305 m) plus 100 feet (30.5 m) per level of experience.

2. **Communication with Plants and Animals.** The biomancer can contact nearby animals and plants. This communication does not occur in the form of words, but in a manner similar to empathy. The biomancer can get "flashes" of past or current events involving the animal or plant, but limited to the creature's own memory and senses. For example, a tree will notice if a man-sized creature is climbing on it, or will feel heat if someone fires an energy weapon near its trunk or branches, but it will not be able to see the individuals involved, and neither will the biomancer sharing its memories.

The communication power also enables the biomancer to calm down enraged animals, but only if the character can project a sense of peacefulness towards the creature and provided the animal has not been attacked. Chance of Success: The communication is automatic whenever the biomancer tries it. The attempt to calm the animal has a base chance of 35% plus 5% per level of experience. Half if the animal is alien to Earth and does not work at all against supernatural monsters, creatures of magic or intelligent beings, such as humans. Range: 60 feet (18.3 m) plus 10 feet (3.0 m) per level of experience.

3. **Healing Touch.** The biomancer can manipulate the tissues of living things, repairing damage from wounds, poison, etc. The touch restores 1D4 S.D.C./hitpoints or M.D.C. per level to any one creature or character (the biomancer can also use it on himself). At first, this ability can only be used three times per 24 hours, then four times a day at 5th level, five times a day at 8th level, and six times a day at 12th level.

4. **The Gift of Nature.** All biomancers can convert living organic matter into edible food! By concentrating and expending 8 P.P.E., the biomancer can convert any part of a living plant into a fruit-like organ (the "Gift") with enough nutritional value to keep a person fed for one day. The procedure only works on a tree, bush or larger plant, and can only be done on one plant a set number of times. As a rule of thumb, a bush will only provide one Gift, a man-sized plant 1D4+1 Gifts, a medium-sized tree 2D6, and so on, with the largest trees able to provide 2D6X10 Gifts. Trying to exceed a plant's limit (the biomancer will sense exactly how many

times he can ask for a Gift) inflicts 2D6 S.D.C. damage to the tree and generates a psychic backlash that does 1D4X10 S.D.C. to the **biomancer** (or M.D.C. to a mega-damage character)! Note: This power cannot be used on a Millennium Tree. An attempt will result in temporary injury to the Tree and a mega-damage explosion to anybody near the tree (see **Rifts England** for details of the energy releases of the Millennium Trees).

5. The Gift of Peace. The **Biomancers'** unique link to the ecosystem gives them an aura that protects them from most animals and even some monsters. Low-intelligence animals from mosquitos to elephants will never attack the biomancer, except in self defense. Most of the time, they will get out of his way or go around him. Even some alien monsters with animal intelligence, like the fury beetle, will not attack the biomancer unless cornered or attacked first. Intelligent creatures, supernatural monsters and demons are unaffected by the aura.

6. Create **Bio-Weapons**: The biomancer can create weapons, armor and equipment by magically altering living matter! The process is somewhat similar to **techno-wizardry** and **bio-wizardry**, but it affects living animals and plants without hurting them. See the description under **biomancy** magic for the details on bio-weaponry and equipment.

7. **P.P.E.**: Like all practitioners of magic, the biomancer is a living battery of mystic energy that he can draw on to create magic. **Permanent Base P.P.E.**: 1D4X10+10 plus P.E. attribute number. Add 3D6 P.P.E. per each additional level of experience. The biomancer can also draw P.P.E. from ley lines, nexus points, and other people the same as the ley line walker and other mages.

8. Bonuses: +1 to save vs magic at levels four, seven, ten, twelve, and fifteen, +2 to save vs horror factor, +15% to save vs **coma/death**, +4 to resist any bio-manipulation magic (including agony, blind, mute, life drain, sickness, curses, metamorphosis, and transmutation), +2 to save vs psionics.

9. **Initial spell knowledge**: The **biomancer's** spell knowledge, like his powers, come from his mystical link to the Tree of Life, the mystical symbol for all living things. At first level, the biomancer can select six spells from levels one and two, from either the **Biomancer Magic** spell list or from the **Available Common Spell Magic** list. These are part of the **biomancer's** permanent spell casting abilities. Once selected, they cannot be changed.

10. **Learning new spells**. The biomancer gains new spells, much like a mystic, through meditation whenever he or she has reached a new advancement plateau (level of experience). At second level, the biomancer can select a total of four spells chosen from levels one, two and three of either Biomancy Magic or Common Spells. At third level, the character can choose an additional four total spells selected from levels one, two, three and four. After **reaching** each additional level of experience, the biomancer can choose a total of two additional spells from any level lower or equal to his current experience level. Biomancers cannot be taught new spells, nor can they purchase them.

Biomancers can also use herbs, magic potions, teas, ointments, magic scrolls (if literate), wands, staves and other magic items. **Techno-wizard** devices can be used too, although most **biomancers** will avoid the ones made out of

"dead things" from technological societies, like guns and power armor.

#### **O.C.C. Skills:**

Speaks Native Tongue at 98%

Two additional languages (+10%)

Lore: Monsters and Demons (+15%)

Lore: Faerie (+20%)

Basic Math (+10%)

Holistic Medicine (+10%)

Wilderness Survival (+15%)

Land Navigation (+10%)

Track Animals (+10%)

W.P. Archery and Targeting

W.P. **One** of Choice

Hand to Hand: basic

Hand to Hand: basic can be changed to expert at the cost of one "other" skill, or to hand to hand: martial arts at the cost of two skills.

**O.C.C. Related Skills**: Select six "other" skills. Plus select two additional skills at level three, one at level six, one at level nine, and one at level twelve. All new skills start at level one proficiency.

Communications: Any

Domestic: Any (+5%)

Electrical: None

Espionage: Detect ambush, detect concealment, intelligence and tracking only.

Mechanical: None

Medical: Any (+10%)

Military: None

Physical: Any

Pilot: Horsemanship and riding exotic animal only (+14%)

Pilot Related: Any

Rogue: Any (+2%)

Science: Any (+10%)

Technical: Any, (+10% only on language, literacy, writing, art and lore)

W.P.: Any

Wilderness: Any (+10%)

**Secondary Skills**: The character also gets to select four secondary skills from those listed. These are additional areas of knowledge that do not get the advantage of the bonus listed in parentheses. All secondary skills start at the base skill level.

**Standard Equipment**: Set of travelling clothes and a set of ceremonial clothes. Many Biomancers wear only a loincloth and/or cloak while in the jungle. They also own an organically grown backpack, water skin and food for 1D6 days (plus up to 2D6 days' worth of Gifts of Nature). A staff and one weapon of choice (only 20% carry energy weapons) are also carried. Light M.D.C. armor is worn, usually either Light Wood or Light Chitin armor (see below), plus one simple organic weapon.

**Money**: Starts out with 1D4X1000in credits and 1D6X1000in valuables.

**Cybernetics**: Starts with none and will avoid them because they interfere with magic and are unnatural. Even bio-systems will be shunned unless absolutely necessary. The biomancer would rather wear a patch over an eye lost in combat than get a cybernetic replacement. A single bionic augmentation or pair of cybernetic implants will reduce the range, duration



and potency of **biomancy** magic by half. Bio-system prosthetics or replacement organs are not as detrimental but still reduce the magic by 5% per each.

---

# Biomancy

---

## The Power of Life

Biomancy is a form of magic that allows the user to transform simple animals and plants into anything the caster could need — without killing or hurting them! The magician's link to nature allows him to cast a number of spells. The magic works best in wilderness areas, since it often requires plant life, but many spells are **devastatingly** effective anywhere. Only **biomancers** and some jungle elves with appropriate O.C.C.s can learn biomancy spells.

---

## Biomancer Spell Descriptions

Accelerate Plant Growth (5, 10 or 20 P.P.E.) — 3rd level  
Animal Ghost (20) — 5th level  
Animal Weaponry: Simple (6) — 2nd level  
Animal Weaponry: Major (20) — 4th level  
Animate Plants: Minor (4) — 2nd level  
Bio-Blast (15) — 6th level  
Chitin (15) — 3rd level  
Commune with Nature (2) — 1st level  
Forest Camouflage (15) — 4th level  
Heal the Earth (200) — 9th level  
Insect Leap (5) — 2nd level  
Metamorphosis: Plant (30) — 5th level  
Plant Virtual Sight (6) — 2nd level  
Shape Plants (4) — 1st level  
Shrink Plant (10 or 200) — 3rd level  
Strengthen Plants (20 or 400) — 4th level  
Suspended Animation (80) — 8th level  
Touch of Life (60) — 8th level  
Tree **Teleport** (20) — 6th level  
Tree Warrior (30) — 7th level  
Undo Undead (25) — 7th level  
Weather Sense (1) — 1st level  
Weave Plants (15) — 2nd level  
Woodland Entity (80) — 10th level

---

---

## Level One

### Commune with Nature

**Range:** One mile (1.6 km) radius per level of experience.

**Duration:** Instant

**Saving Throw:** None

P.P.E.: 2

The **biomancer** meditates and gets a general feeling for the surrounding ecosystem. The spell will tell the character if the ecosystem is unbalanced or damaged and why — a general sense of the source of the disturbance, such as drought, extensive pollution, deforestation, fire, war, plague, etc.

### Shape Plants

**Range:** Touch

**Duration:** Permanent

**Saving Throw:** None

P.P.E.: 4

The spell caster can reshape a tree limb or small plant at will. He can alter its position and even twist the trunk and branches of a small tree or plant. Large trees and intricate designs, such as sculpting a normal tree into a **humanoid** or animal shape, will take multiple castings (each casting causes one minor effect). Affecting a large tree would take 8-12 castings. This power only works on living or freshly cut trees and plants.

### Weather Sense

**Range:** One mile (1.6 km) radius per level.

**Duration:** 24 hours

**Saving Throw:** None

P.P.E.: 1

The character's connection to nature gives him or her an idea of what the weather will be like for the next 24 hours. The spell delivers an extensive weather report; i.e. cloud cover, wind direction and speed, temperature highs and lows, humidity, the likelihood of precipitation or foul weather and approximately when it will arrive and how long it will last.

Note that the spell cannot forecast weather changes caused by magic or ley lines during that period — but if the weather doesn't come out as reported the character will know an outside force is responsible.

---

## Level Two

### Animate Plant: Minor

**Range:** 60 feet (18.3 m) per level of experience.

**Duration:** One melee round (15 seconds) per level of experience.

**Saving Throw:** None

P.P.E.: 4

The spell caster can cause one plant of average tree size or less to move. The plant will remain rooted to the spot but will move its limbs or stems around. Trees will make a lot of noise if they flail their limbs, rustling their leaves as if a strong wind was running through them. The character can also make a tree or branch bend to better reach a branch or to climb. The animated plants cannot attack or hinder people, but can distract or even

terrify foes (at the G.M.'s discretion, seeing a large tree suddenly move its branches or bend as if to bow might call for a save vs a Horror Factor of 9 to 11).



## Animal Weaponry: Simple

**Range:** Self

**Duration:** One minute per level of experience.

**Saving Throw:** None

**P.P.E.:** 6

The spell caster alters his own body by making his fingers magically elongate into bony animal-like claws, or his teeth into fangs. The claws inflict 3D6 S.D.C. in hand to hand combat and are +1 to strike and parry. Fangs inflict 2D6 S.D.C. per bite and can be used to chew through S.D.C. rope, wood or material.

## Insect Leap

**Range:** Self

**Duration:** Instant

**Saving Throw:** None

**P.P.E.:** 5

This spell enables the character to make an enormous grasshopper-like leap. This can be either a broad, lengthwise leap or high jump. Broad jumps (for distance) will carry the character 50 feet (15.2 m) plus 10 feet (3.0 m) per level of experience. High jumps (leaping up rather than for distance) are 10 feet (3.0 m) plus 6 feet (1.8 m) per level of experience.

## Plant Virtual Sight

**Range:** 100 feet (30.5 m) per level of experience.

**Duration:** 1 melee round (15 seconds)

**Saving Throw:** None

**P.P.E.:** 6

The spell caster can mystically "see" from the vantage point of any plant from a blade of grass low to the ground to the tallest treetop. For instance, a character needing to see past a jungle's heavy canopy could use this spell to magically move his eyesight to the top of a tree. The caster has to specify the angle and direction he will be looking at.

## Weave Plants

**Range:** Touch

**Duration:** Permanent

**Saving Throw:** None

**P.P.E.:** 15

The character can take portions of a plant (never a whole plant, but small pieces from bushes and trees like leaves, vines, and so on) and reshape them into a vegetable fiber that is lightweight, resilient and waterproof; reminiscent of plastic with a cotton-like texture. Color is manipulated by the selection of the base material. Fabric made of bark, branches and roots will be shades of brown, leaves provide shades of green, grains give yellow and orange, while flower petals and fruits offer an array of colors.

As the caster creates the fiber, he or she can reshape it into clothing, belts, bags, baskets, rope or any article that can be made out of fabrics or weaves. The sewing/tailor skill is necessary to make a functional set of clothing (any style). Characters without a sewing or tailoring skill can only make simple cloaks, robes, blankets, sheets of material, sacks, rope and similar simple articles. Each casting creates three square feet (0.3 square meters) of material per level of experience.

S.D.C. armor can be made by using bark or roots and layering and interlacing several layers of heavy cloth. The maximum protection such armor will provide is 45 S.D.C. with an A.R. of 13. This spell can also be used to mend M.D.C. wood armor, restoring up to 5 M.D.C. per level of experience with every casting. Biomancy wood armor is described later.

## Level Three

### Accelerate Plant Growth

**Range:** Touch

**Duration:** Permanent

**Saving Throw:** None

**P.P.E.:** 5 for a small plant, 10 for a tree, 20 for a large tree

The biomancer can speed up the normal growth of a plant. Full-grown plants will sprout a full year's worth in a melee round and a sapling will grow up into a full sized adult plant. Adult trees will grow another 4D6% of their current size. A seed needs two castings, one after planting to create a sapling and another spell to make the plant reach full size.

### Chitin

**Range:** Self

**Duration:** Ten minutes per level of experience.

**Saving Throw:** None

**P.P.E.:** 15

The character's skin is covered by a dark, vaguely organic substance that looks like melted wax with spiny protuberances at the joints and shoulders. This mystical chitin protects the caster with 40 M.D.C. plus 5 M.D.C. per level of experience. The chitin armor is considered to be the equivalent of light body armor (-5% prowl penalty). No other armor can be worn over it, but it can be concealed under a cape, cloak or robe. The chitin clad character can be easily mistaken for a monster or D-Bee. The spines in the chitin inflict an extra 1D6 S.D.C. in hand to hand

combat — M.D. if this spell is combined with the spell *animal weaponry: major*.

## Shrink Plant

**Range:** Touch

**Duration:** One minute per level of experience or permanent.

**Saving Throw:** Standard; supernatural plants get a +6 to save.

**P.P.E.:** 10 temporary or 200 for permanent shrinking.

This spell will shrink any plant by as much as 90%, reducing a 30 foot (9.1 m) tree to a mere 3 feet (0.9 m). The caster can determine the degree of shrinking in gradations of 10% up to 90%. Once shrunk, the spell cannot be used on that plant again to make it any smaller. Expending 200 P.P.E. points will cause a permanent reduction of the plant.

## Level Four



## Animal Weaponry: Major

**Range:** Self

**Duration:** One minute per level of experience.

**Saving Throw:** None

**P.P.E.:** 20

The spell caster alters his own body by making his fingers magically elongate into bony animal-like claws and/or his teeth into large fangs. The character can even make a pair of horns or antlers grow out of his head. The major spell makes these mega-damage weapons.

Claws inflict 2D6 M.D. in hand to hand combat and are +1 to strike and parry. Fangs inflict 1D6 M.D. per bite and can be used to chew through rope, wood, plastic, and even light chains and thin metal. Horns or antlers do 2D6 M.D. and are +1 to strike.



## Forest Camouflage

**Range:** Self

**Duration:** Two minutes (8 melees) per level of experience.

**Saving Throw:** None

**P.P.E.:** 15

The mage can blend into any plant-covered landscape, becoming totally invisible! Unlike the chameleon spell, the mage can move around without disturbing the spell. Not even the see invisible spell, or creatures with that ability, are able to see the camouflaged character as long as he stays among vegetation. Neither will any technological imagers or sensors detect the magically concealed spell caster. While the spell is in effect, the character has an effective prowl skill of 60% (or adds 10% to an existing prowl skill, whichever is greater).

The only way to attack the character is to shoot or strike wildly, but all such attacks are -5 to strike and the magically camouflaged character has the initiative. Area effect magic and explosives are more likely to hit the concealed target.

The character will only reveal his hiding place if he calls attention to himself by shouting, making noise, or attacking. Even then attackers are -2 to strike and he is vulnerable only during the melee(s) in which he performs the foolish action. He can also reveal himself by stepping out of vegetation, like moving onto rocks, a vehicle or a paved street. By retreating back into the woodlands and remaining silent, the character will once again become invisible and undetectable.

Remember, the spell only works in places where trees and plants are numerous: forests, jungles, city parks, even grasslands (but then the character must crawl or remain crouched).

## Strengthen Plant

**Range:** One tree or 10 foot (3.0 m) area per level of experience.

**Duration:** One minute per level of experience or permanent.

**Saving Throw:** None

**P.P.E.:** Temporary effects: 100; blades of grass, a shrub or bush 20 M.D.C., a small tree 30 points, an adult tree 40 points, or a giant redwood type tree 60 P.P.E. points. 400 P.P.E. will permanently transform a living plant of any size into a mega-damage structure.

This spell transforms normal trees and plants into M.D.C. structures! A blade of grass has one M.D.C. point (and is like stepping on a nail, pointed end up), small shrubs and bushes acquire 4D6 M.D.C., larger bushes and small trees have 1D6X10 M.D.C., good sized trees have 4D6X10 M.D.C. and trees towering 200 feet (61 m) or higher have 1D6X100+100M.D.C.!

Some biomancers use rituals and ley line energy to permanently transform whole forests into living mega-damage structures. This is especially effective in foiling logging operations, preventing normal chainsaws and bulldozers from harming the mega-damage plants. The transformed plants are also immune to disease, insects and to normal fires, but not mega-damage fire and forces.

Once a mega-damage plant or tree is cut down/killed, however, it reverts back to normal S.D.C. wood, so people trying to exploit the capabilities of the strengthened plants get nothing for their troubles. Approximately 70% of the trees on Maga Island have been permanently transformed into mega-damage structures.

## Level Five

---

### Animal Ghost

**Range:** 10 feet (3.0 m) per level of experience.

**Duration:** One minute per level of experience

**Saving Throw:** Standard

P.P.E.: 20

This spell can be used along a game trail, a drinking spot, or any place frequented by animals. The spell creates a seemingly real image of any one animal that has frequented the area regularly. The illusion appears real, especially from a distance and can be manipulated to do anything the animal would normally do. A deer would run away, a bear could stand threateningly and roar, a predator might growl and take an aggressive stance, and so on. Many biomancers use this spell to trick and frighten hunters, entice them on foolish chases, or to lure them into an ambush.

The spell is referred to as animal "ghost" because like a ghost or holographic projection, the animal has no substance. Arrows, spears and bullets fly right through the image without any reaction from the creature. Also like a ghost, the animal will suddenly disappear without a trace when the spell ends.

### Metamorphosis: Plant

**Range:** Touch

**Duration:** 5 minutes per level of experience.

**Saving Throw:** None

P.P.E.: 30

The biomancer can transform himself into a plant. The size can range from a shrub to a tree. While in this state, the magician cannot move, attack or use magic (except to end the spell), but remains in control of all his senses other than speech. Turning into a shrub or tree temporarily gives the character 60 additional S.D.C.; a large tree will grant the character an additional 200 S.D.C.

## Level Six

---

### Bio-Blast

**Range:** 100 feet (30.5 m) plus 10 feet (3.0 m) per experience level.

**Duration:** Instant

**Saving Throw:** None except dodge, but the victim must know the attack is coming and must roll an 18 or higher.

P.P.E.: 15

The spell caster fires a bolt of life energy at a target, disrupting living beings and destroying inanimate objects. The blast does 2D6 S.D.C./hit point damage and causes neural disruption to living creatures. Victims lose initiative and the number of melee round attacks and combat bonuses are reduced by half for one melee round. Against inanimate objects, such as weapons, bots, vehicles, machines, rock and buildings, the blast inflicts 1D6 M.D. per level of the spell caster. Mega-damage is doubled against vampires, other undead, and supernatural monsters.

The bio-blast can be fired from the fingertips or eyes of the spell caster and is +1 to strike.

## Tree Teleport

**Range:** 200 feet (61 m) per level of experience.

**Duration:** Instant

**Saving Throw:** None

P.P.E.: 20

The biomancer can temporarily transform himself and up to 150 lbs (68 kg) of equipment into bio-energy and "jump" to a nearby tree. The tree acts as a lightning rod for the bio-energy and enables the caster to disappear, move and reform himself. The effect is just like a teleport spell, enabling the character to pop in, out and around an area without leaving tracks or to surprise an enemy. The spell needs a tree to "ground" itself and to give the spell caster a fixed target location; he appears right next to the target tree.

If a foolish character attempts the spell when there are no trees in range, he cannot re-materialize! Instead, the character will temporarily turn into energy and drift randomly for 1D6 days, after which time he will finally reappear next to a tree 1D4X10 miles (1D4X16 km) from his jump point (or the next closest tree if none are within that range).

## Level Seven

---

### Tree Warrior

**Range:** Immediate area

**Duration:** 30 minutes per level of the biomancer.

**Saving Throw:** None

P.P.E.: 30

This spell enables the biomancer to animate a tree and imbue it with supernatural strength and endurance. The tree will pull itself up by the roots, follow the biomancer and fight his enemies. At the end of the spell, the tree will root itself in the nearest convenient spot (if possible, its original position) and return to normal. The tree can serve as a bodyguard, spy, or scout. Tree warriors are ideal for ambushes because they can remain immobile like an ordinary tree until an unsuspecting victim is within reach and then strike. Biomancers who carelessly cause the death of a tree with this spell, however, have a 10% chance of losing their biomancer powers until they can somehow redeem themselves! This 10% chance is cumulative.

#### Tree Warrior

- M.D.C. 200
- 8 to 15 feet (2.4 to 4.6 m) tall, P.S. 25, P.P. 17, I.Q. 7, Spd. 16, +3 to strike, +4 to parry and dodge, bio-regenerate 2D6 M.D.C. per melee round, and M.D. fire and plasma does half damage.
- Can shoot bio-energy bolts inflicting 3D6 M.D., doubled against vampires and the undead; range: 100 feet (30.5 m).
- Four physical attacks or bio-bolts per melee. Punch inflicts 2D6 M.D., power punch does 4D6 M.D. (counts as two attacks).
- The Tree Warrior will obey only the person who summoned it.

## Undo Undead

Range: 300 feet (91.4 m)

Duration: Instant

Saving Throw: Standard

P.P.E.: 25

The magician causes an undead creature to be surrounded by bio-energy that reacts to its necromantic energies like matter does to anti-matter! Vampires, zombies, skeletons and other undead or animated dead will be burned horribly if they fail their saving throw. The spell inflicts 1D6X10 M.D. or hit point damage, +2 points per level of the spell caster's experience. A successful save means the undead suffers only 1D6 points of damage and recognizes the dangerous life magic held by his opponent.

## Level Eight

### Suspended Animation

Range: Self

Duration: One day to ten years per level of the character.

Saving Throw: None

P.P.E.: 80

The biomancer can place himself in a total state of suspended animation, slowing all body functions to a crawl and simulating death. The biomancer ages two years for every ten that he sleeps. While in the suspended state, the biomancer cannot cast spells or think, only dream. His physical body is not protected in any way by this spell so he should find a safe, dry, warm place with some form of protection. The character can be roused only by a Tree of Wisdom, Memory Tree, or via telepathic communication, but only if he can be convinced to end his magic sleep.

### Touch of Life

Range: Touch

Duration: Permanent

Saving Throw: None

P.P.E.: 60

The biomancer can revive a recently dead person by infusing him with bio-energy. The corpse can be no more than a day old (less is better). The chance of success is 70% plus 1% per level of experience. If successful, the corpse will be restored to 10 hit points above zero. The person will be weak and sick until the rest of his hit points are restored. The touch of life does not restore missing limbs, heal burns or disease, or cure insanity.

## Level Nine

### Heal the Earth

Range: 100 feet (30.5 m) area per level of experience.

Duration: Permanent

Saving Throw: None

P.P.E.: 200

This spell will heal the area from any poisons, pollution, and other damaging substances. The area thus treated will become perfectly suited for the development of life, as determined by the

region's ecosystem. If cast on farmland, yields for the area affected will be increased by 10% per level of the spell caster's experience.

## Level Ten

### Woodland Entity

Range: Self

Duration: One melee (15 seconds) per level of experience.

Saving Throw: None

P.P.E.: 80

The spell caster transforms himself into a gigantic tree-like creature with superhuman strength and endurance. The woodland entity has a P.S. of 30 (supernatural), and 300 M.D.C.! It regenerates 3D6 M.D.C. every melee round, attacks with its spiked claws, and is +2 to strike and inflict 6D6 M.D.! Fire and energy attacks inflict half damage and its own attacks do full damage to vampires and were-creatures; double damage to alien intelligences.

### Available Common Spell Magic

The spells available to the biomancer are limited to those listed as follows. The P.P.E. cost and spell effects remain unchanged.

#### Level One

Death Trance  
Globe of Daylight  
See Aura  
Sense Evil  
Sense Magic

#### Level Two

Chameleon  
Climb  
Concealment  
Detect Concealment  
Turn Dead

#### Level Three

Armor of Ithan  
Breathe Without Air  
Energy Bolt  
Impervious to Fire  
Invisibility: Simple  
Negate Poison

#### Level Four

Carpet of Adhesion  
Cure Minor Disorders  
Energy Field  
Magic Net  
Repel Animals  
Shadow Meld  
Swim as Fish

#### Level Five

Energy Disruption  
Escape  
Heal Wounds  
Sleep

#### Level Six

Cure Illness  
Impervious to Energy  
Magic Pigeon  
Reduce Self

#### Level Seven

Dispel Magical Barrier  
Fly as the Eagle  
Invisibility: Superior  
Invulnerability  
Metamorphosis: Animal  
Purification

#### Level Eight

Commune with Spirits  
Eyes of the Wolf  
Exorcism  
Metamorphosis: Human  
Negate Magic

#### Level Nine

Metamorphosis: Insect  
Summon & Control Canine  
Water to Wine

**Level Ten**  
Metamorphosis: Superior  
Summon/Control Rodents

**Level Eleven**  
Remove Curse  
Summon & Control Animals

**Level Twelve**  
Metamorphosis: Mist

**Level Thirteen**  
Sanctum

**Level Fourteen**  
Restoration

---

# Bio-Weapons

---

Biomancers are adept at creating (growing, actually) a number of magical weapons and armor. The existence of bio-weapons in the Amazon Jungle has resulted in so-called primitive peoples being able to stand their ground against technologically advanced enemies. Maga Island and the Bahia Kingdom are the major sources of bio-weaponry, but several other communities (not only elven and human, but even lizard men) have learned the secrets of biomancy and have started producing these wondrous weapons. Bio-Weaponry is rarely made available to would-be spoilers of nature, however. This includes most city dwellers, "civilized" characters, pirates, and would-be conquerors like the Splugorth and their minions. Still, some of those products fall into the wrong hands. The Splugorth minions are beginning to study the secrets of biomancy.

The prices given below are for the markets of Maga Island or the Bahia Kingdom. In other parts of the world they are likely to be extremely rare (if they exist at all) and incredibly expensive. In South America, heroes might be given bio-weapons and/or armor as a reward for a great deed. As always, the availability of this equipment is ultimately left to the Game Master.

## Lesser Bio-Weapons & Armor

### Enchanted Spears, Swords & Clubs (80 P.P.E.)

These weapons are made of fire-hardened wood and then charged with magical energy, turning the wood into a mega-damage structure. Spears have 1D6X100 M.D.C., swords and clubs have 1D4X100 M.D.C. The weapon's M.D.C. comes into play only when an attacker is trying to destroy the weapons. Generally speaking, these items can parry mega-damage weapons or blasts without fear of breaking.

Most of the time, these weapons inflict S.D.C. damage, but when the owner wills it, the weapons are surrounded by a bio-energy aura that allows the weapons to inflict mega-damage! Each time the power is activated, the energy aura lasts five minutes (20 melee rounds). Activating an enchanted wooden weapon takes one melee action of concentration.

The weapon's energy aura can be activated up to six times; after that, its P.P.E. base must be replenished. This can be done either by placing the weapon at a ley line or nexus, or by having a mage infuse the weapon with 30 P.P.E. When the weapon is charged, it can be used by anybody and is activated by a simple mental command. However, the user of the weapon must know

about its power; if he does not actively wish for activation, nothing will happen.

**Club:** 1D6 S.D.C. or 2D6 M.D. with aura activated.

**Wooden Sword:** This is a club with its edges sharpened. 2D4 S.D.C. or 3D6 M.D. with aura activated.

**Spear:** A fire hardened spear (no metal or stone can be placed on its tip). 2D6 S.D.C. or 4D6 M.D. with aura activated; the energy spear does more damage than a sword or club.

### Light Wood Armor (150 P.P.E.)

The recipient of the armor must be present for the spell casting, as well as one large tree or several medium-sized ones (more for larger humanoids). While the Biomancer chants the ritual (this takes approximately ten minutes), the recipient (this can be the biomancer himself or another character) stands with his or her back to one of the trees. As the spell progresses, the tree(s) begins to reach out to the recipient, its limbs stretching out towards him. The trunks become fluid and surrounds the character's body. When the ritual is over, the person is totally encased in wood. For 1D4 minutes he is blind and oblivious to the world. Some find the experience disquieting and those with claustrophobia cannot endure the ritual. Most biomancers take the opportunity to engage in deep meditation and enjoy being one with the trees.

After the 1D4 minute period is over, the trees resume their natural appearance. Meanwhile the wood around the character continues to transform into form-fitting, polished, mega-damage wood armor. The specific design of the armor is up to the spell caster, although it usually has an organic-like shape to it. The suit is fully sealed, with a limited oxygen of 10 minutes worth of air when buttoned up tight. However, the armor is alive and can purify air. Thus, the character is +3 to save vs toxic gases and airborne poison and impurities. The living armor reacts to perceived dangers by sealing itself and extruding thorns as a means of auto-defense. These thorns, usually located on the side of the hand or forearm, knuckles, elbows, shoulders and knees inflict 1D4 M.D. in hand to hand combat.

Since the armor is completely form-fitting and incredibly flexible, it has no prowl penalty and provides the owner with 45 M.D.C. of protection. This M.D.C. regenerates at the rate of 2D6 M.D.C. points per 24 hours. A biomancer with the weave plant spell can repair the armor even more quickly. If destroyed, the armor "dies" and is lost. Wood Armor cannot be given to somebody else because it has been bonded to fit only the person for whom it was created. If the owner dies, the armor will wither away in 1D6 hours. When the owner doesn't want to wear the armor, the suit liquifies and rolls right off of him, turning into a thorny mound. To put the armor back on, its owner picks it up and it flows back on to him (takes about 10 seconds, less than one melee round).

### Light Chitin Armor (200 P.P.E.)

The creation process enchants a group of insects into weaving a chitin-like substance around the subject (who can be either the caster or somebody else). The actual ritual takes about 20 minutes, and must be in an open forested or swamp area. A swarm of insects will arrive and surround the subject of the spell, completely covering him under a solid, living mass of bugs. The insects are temporarily enchanted and able to secrete a gooey

substance over the character. The recipient of the armor must remain as still as possible while immersed in the crawling insects and goo. The GM might require characters who aren't biomancers or jungle elves to make a save vs a horror factor of 10. Failure means the character thrashes around or flees and the spell is ruined and the P.P.E. lost.

When the ritual is completed, the cloud of insects withdraw to reveal the character clad in a suit of insect plate armor, complete with a helmet and transparent eye goggles. Its perfect fit gives it excellent mobility (no prowl penalties). By flexing his muscles, the wearer can extend a set of long claws from the hands (1D6 M.D., +1 to strike). The suit has 70 M.D.C. and is alive and regenerates 4D6 M.D.C. per 24 hour period. This armor can be healed, like any living thing, through use of the heal wounds spell, restoration, or the biomancer's healing touch. If all its M.D.C. is destroyed, the armor is beyond repair and dies. Like all other bio-armor, each suit of Chitin Armor is custom made for its owner and cannot be worn by anyone else; if the owner dies, so does the armor.

The armor can be sealed and holds a 20 minute supply of air before needing to be refreshed. The chitin can "breathe" in more air, filtering most gases and substances. Even when temporarily unsealed, the character inside the armor gets a +6 bonus to save vs toxic gases, airborne poisons and disease.

## Greater Bio-Weapons & Armor

### Bio-Energy Bow (200 P.P.E.)

This bow is grown from a living tree and shaped magically. Unlike a normal bow, this weapon has no visible string, yet it is curved in the shape of a strung bow. The bow is armed by a mental command and the gesture of drawing back an imaginary string. The moment the imaginary string is released, an "arrow" of bio-energy is unleashed.

Arrow Damage: 4D6 M.D., doubled against vampires, undead and alien intelligences.

Range: 900 feet (274 m).

Payload: The bow can fire 40 arrows before needing a recharge by either placing it at a ley line or by having any wizard or psionic spend 25 P.P.E. or 40 I.S.P.

### Bone Blade (500 P.P.E.)

The blade of this weapon resembles a giant serrated tooth and is supernaturally sharp. Large swords inflict 4D6 M.D., short swords inflict 3D6 M.D. and knives do 2D6 M.D. The sword is permanently enchanted and can be used by anybody. The bone blade has 1D6X100 M.D.C. (this applies only if an attacker targets the sword itself), and regenerates damage at the rate of 4D6 M.D.C. per melee round.

### Insect Pincers (500 P.P.E.)

This complex living weapon is worn like a glove. Two pincers protrude from the hand harness. On mental command the pincers snap open and shut like scissors, but are sharp on both sides of the pincer blades. They can be used to stab, cut or slash an opponent. Stabbing or slashing does 4D6 M.D. and a scissor cut does 6D6 M.D. Each pincer has 1D6X100 M.D.C. (this applies only if an attacker targets the pincers) and regenerates dam-

age at the rate of 4D6 M.D.C. per melee round. Destroying one of the two pincer blades reduces the damage to 2D6 M.D. and cannot be used like scissors.

### Wood Armor: Superior (650 P.P.E.)

The creation process works exactly like the lighter suit of armor, but the suit created is much more powerful, with 80 M.D.C. The suit also regenerates 1D6 M.D.C. per hour; the process can be sped up by other spells the same as described previously.

Superior Wood Armor is not only alive, but it also moves and acts as an exo-skeleton, giving its wearer an equivalent of a supernatural P.S. of 18! A restrained punch does 3D6 S.D.C., full strength punch does 1D6+4 M.D. (counting the thorns) and power punch does 2D6+4 M.D. (counts as two attacks). The armor clad character is +1 to strike and parry and +2 to dodge. Biomancer spells that add armor or weapons to the caster will work on this armor as well.

### Chitin Armor: Superior (900 P.P.E.)

Fundamentally the same as the light chitin armor, but stronger, with 110 M.D.C. and regenerates damage at a rate of 2D6 M.D.C. per hour. Furthermore, it acts as a living exo-skeleton, granting the wearer a supernatural P.S. of 25 and increases his speed by 20%. Restrained punch inflicts 4D6+10 S.D.C., full strength punch does 2D6+6 M.D. (counting the claw damage bonuses), and a power punch inflicts 4D6+6 M.D. While in the suit, the character is at +2 to strike, parry and dodge. Biomancer spells that add armor or weapons to the caster will work on this armor as well.



# The Kingdom of Lagarto

**Size:** 1,000,000+ square miles (2,560,000+ square km). Lizard man communities cover more than a hundred small islands and a major section of the smaller half of the South American continent. In terms of land area, it is the largest single nation in South America.

**Population Breakdown:** 2.2 million total

Lizard Men: 1,800,000

Humans (free): 80,000

Cernun Mystics (see **Rifts England**): 4,000

Gigantes (serving the Cernun Mystics): 10,000

Dragons (all types): 800; the second largest, known concentration of dragons on Earth.

Eandroths: 14,000

Crocodilians (see **Rifts Africa**): 6,000

Tautons (see **Rifts Africa**): 8,000

Lizard Mages: 1,000

Lyvorrkians (see **Rifts Vampire Kingdoms**): 20,000

Gargoyles: 20,000

Overlords (see **Rifts Atlantis**): 4,000

T-Men (see **Rifts Atlantis**): 6,000

Kittani (see **Rifts Atlantis**): 10,000

Other: 40,000; mostly non-human D-Bees, goblins, and monster races — see **Rifts Conversion Book** for descriptions of many monster races.

**Note:** This does not include some 100,000 non-human visitors, mostly from the city of Dragcona in Atlantis.

**Slave Population:** 200,000 total

Lizard Men 100,000

Humans 80,000

Others 20,000

## History

Almost three hundred years ago, a lizard man mage from the Palladium world arrived in South America. Since lizard men prefer waterways, especially with fresh water, the Amazon and the Land of the Thousand Islands were ideal for his people. Thousands of lizard men abandoned their home world and migrated to Rifts Earth. Over the centuries, they have multiplied in such numbers that they form one of the largest non-human communities on the planet (of course, Atlantis, The Gargoyle Empire, The Brodkil Empire and the Phoenix Empire are larger, but all are across the Atlantic Ocean). Several hundred members of other reptilian species have also found their way to La Tierradel Lagarto — "the Lizard's Land." Lizard Mages, tautons, crocodilians, dragons, among others, all came to this land where they could be accepted by their "cousins."

Fifteen years ago, calling the lizard man communities a kingdom would have been a great exaggeration. There were a handful of large cities and thousands of small villages scattered across the smaller islands along the Southwestern Archipelago and alongside the West Bank of the Larger Amazon river, but no one ruler or government controlled them. One lizard man settlement would come to the aid of another, but there was no central government, sense of nationality, central laws or organization of any kind. The closest one came to organization was that in times

of crisis, it was customary for all settlements to send representatives to **First City**, to discuss matters that would affect all lizard men in the area. This emergency reunion was called "The Gathering."

Throughout the history of the lizard people of Earth, there have been only three Gatherings. The first one, 210 years ago, was to deal with a giant monster that had Rifted in at a ley line nexus and was threatening several cities. The second one was 70 years ago, when a long drought, caused by the demon lord Emunu, required dozens of warlocks and shamans to pool their resources to summon the rain before dozens of channels dried up. The last one took place 20 years ago, when an ancient dragon appeared at the First City. **Melastirth**, as the dragon called himself, was an envoy from the city of Dragcona in Atlantis and a High Priest of the Cult of Dragonwright (see **Rifts Atlantis**, page 32). The dragon had been handpicked for the job by Styphathal himself, the ruler of Dragcona and self-styled god of Dragonwright.

In front of the gathered leaders of the Lizard's Land, Melastirth delivered an ultimatum presented as a prediction and an offer. He prophesied that the Megaverse was coming to a momentous turning point. Only two groups would come out of these troubled times; "Those who conquer and those who are conquered."

"The cult of Dragonwright is the only True Way for the Scaled Peoples. You are among the chosen ones! The long-lost offspring of Dragonwright! Return to the fold!! Follow the path of Dragonwright and seize your rightful place of power!"

Melastirth neglected to mention that in North America, Dragonwright missionaries claim that humans are the chosen people. The Atlantean cult is one that will tell people what they want to hear. The dragon went on to warn that those who opposed the Ways of the Dragon could expect no protection from the mighty champions that would be arriving shortly from Atlantis and elsewhere — a thinly veiled threat.

Only one elderly lizard, a great-great-grandson of the original founder of the First City, dared to speak against Melastirth. "Beware, brothers," he said steadily, as if he was unaware of the danger his words would bring upon him. "This great serpent offers us the privilege of serving him and his kind. But this 'privilege' may prove to be a burden for us, our children, and our children's children. If his champions come, let us welcome them as an invader, with naked blade and magicks! His 'True Way' will lead us into slavery and submission. We left one world seeking freedom. Are we going to lose ourselves to this being and his shallow promises of salvation and power? I say, nay!"

Melastirth growled at this, but before he could respond, another lizard man struck the speaker down with a treacherous spell. The murderer was **Stleen Otter-Eater**, a powerful warlord from one of the smaller cities to the west and a long-time follower of the teachings of Dragonwright. Stleen stood over the smoldering corpse and shouted: "This is the fate of those who oppose the True Way! It is time the Scaled People took their place in the world and stopped hiding behind cowards!" He pointed at the body at his feet and continued. "Are there any other traitors here, so I may strike them down as well?"





Nobody spoke, because Stleen was renowned both as a warrior and a sorcerer. Besides, many agreed with him and the dragon. Too long had the Scaled Peoples suffered at the hands of the mammal and others. By unanimous vote, The Gathering decided to join the Cult of Dragonwright with Melastirth as their Overlord.

The dragon graciously appointed a lizard man as High King of Lagarto. The High King was a position held only during times of war, when all the lizard tribes would join forces under a single leader. On Earth, that office had been filled only twice before. The cunning Overlord turned the High King into a permanent position and rewarded Stleen's treachery by appointing him the High King of Lagarto.

Within a few months, hundreds of dragons arrived, followed by tens of thousands of other reptilians. The newcomers included many tautons and crocodilians who, for one reason or another, had forsaken their normal masters. There were also thousands of power-hungry Cernun Mystics (see **Rifts England**) and hundreds of evil Lizard Mages (see **Rifts Conversion Book One**) enticed by the opportunity of carving up their own fiefdoms and baronies where they could conduct magical research and maybe reestablish their past days of glory.

At first, most lizard man communities were unaffected by the changes in the First City. Most of the dragon activity concentrated on the east coast of the continent, which didn't have a large lizard man population, but was ideal as a port for ships and aircraft coming from Atlantis. This location would become a new city dedicated to Dragonwright. The labor to build the city came from human slaves and lizard man volunteers. It was a few years later, with the completion of the city, New **Dragcona**, with its towers and pyramids rising into the sky, that the lizard people started to feel the yoke of oppression. Tax men came to towns and villages, praising the name of Dragonwright and demanding between 5% and 10% of the village's food reserves. Even more damaging, one out of every ten young male lizards and one out

of every twenty female lizards, were to be pressed into the King's Army. Some villages resisted these tax men. Every rebellious settlement was destroyed and its people sent into slavery or killed outright.

The kingdom is continually growing, absorbing small settlements of lizard men, D-bees and humans. Some scouting and raiding parties have already reached the domains of Manoa, Omagua and Cibola (a.k.a. El Dorado). So far, the dragon rulers of the kingdom have been unwilling to make raids into Colombia, because they don't feel strong enough to tackle an organized army. At least not quite yet. For the same reason, they are not concentrating their efforts on the cities of El Dorado or any of the larger island kingdoms. In a few years, however, this will change and the sounds of war will shake the land.

Although the city of Dragcona is in Atlantis and under Splugorth rulership, the activities in New Dragcona and Lagarto are not a Splugorth project. Lord Splynncryth is largely uninterested in South America, concentrating most of his attention in Africa and Europe, particularly in the great wars being waged in the New German Republic. The trouble in South America is the handiwork of Styphathal. However, Lord Splynncryth welcomes Styphathal's initiative. After all, any kingdom controlled by Dragcona will be an ally to Atlantis, and if Splynncryth decides to intervene in South America, he will use Lagarto as a staging area. Furthermore, should things go awry, the Splugorth can disavow any knowledge of the situation and blame Melastirth as a renegade. Of course, Splynncryth has allowed Styphathal and Melastirth to use a limited number of Kydian Overlords and gargoyles as shock troops in their campaign.

Note: Most of the dragons who inhabit the area do not believe in the goals of the kingdom of Lagarto, but many enjoy visiting a place where they are venerated and respected. Most of the hundreds of dragons living in the kingdom spend their time attending to their private affairs and avoid the company of other dragons (dragons are natural loners). However, several dragons have become part of the government and the movement toward war (about 5 or 10% of the overall dragon population). Some are true believers of the Cult of Dragonwright, while others enjoy the privileges of being treated as living gods. A third faction uses their position in Lagarto to pursue their own ends, whatever they may be.

## Government

Since the Cult of Dragonwright took over Lagarto a strict and brutally efficient bureaucratic monarchy has seized control of the country. Power is firmly in the hands of the Dragonwright cultists. High King Stleen is little more than a figurehead. Most of the truly important decisions are made by Overlord Melastirth and his trusted advisors. By and large, the lizard man and human inhabitants in Lagarto have no say whatsoever in the government. Taxes, both in goods and services are imposed by the New Dragcona government. Disobedience is punishable by enslavement or death.

The local villages continue to be ruled by headmen, as they have been for centuries. The headmen deal with all local problems. They also have the new responsibility of collecting all taxes levied by the government. As a result, most village leaders are now either Dragonwright fanatics or opportunists taking advantage of the situation. Since they can appeal to the military to

repress rebels, they have enormous power. Despite this, many tyrannical headmen have been murdered or have suffered dubious "accidents" when they pushed the people too far.

The river cities were once governed by a council of elders, but now are under military governors, usually a tauton, gargoyle, lizard mage or other reptilian non-lizard man. Life in the cities is not as oppressive as some of the outlying villages, but open acts of rebellion are more likely to be noticed and punished. A network of spies and informants is spread throughout the nation, formed by either religious fanatics, warmongers or greedy riff-raff.

Military bases are scattered throughout the kingdom. The soldiers on these bases are, in effect, members of an occupation army, with little or nothing in common with the locals. They care only about collecting taxes, maintaining order and stirring up the people for war. While they sometimes defend villagers from wandering monsters and foreign raiders, most are a force of oppression, disliked and feared by less militant civilians (about 40% of the overall lizard man population). The majority of the lizard men have been swept up in the hype of conquest, power and Dragonwright, so they are willing to make sacrifices in the way of taxes, less freedom and volunteering for combat duty.

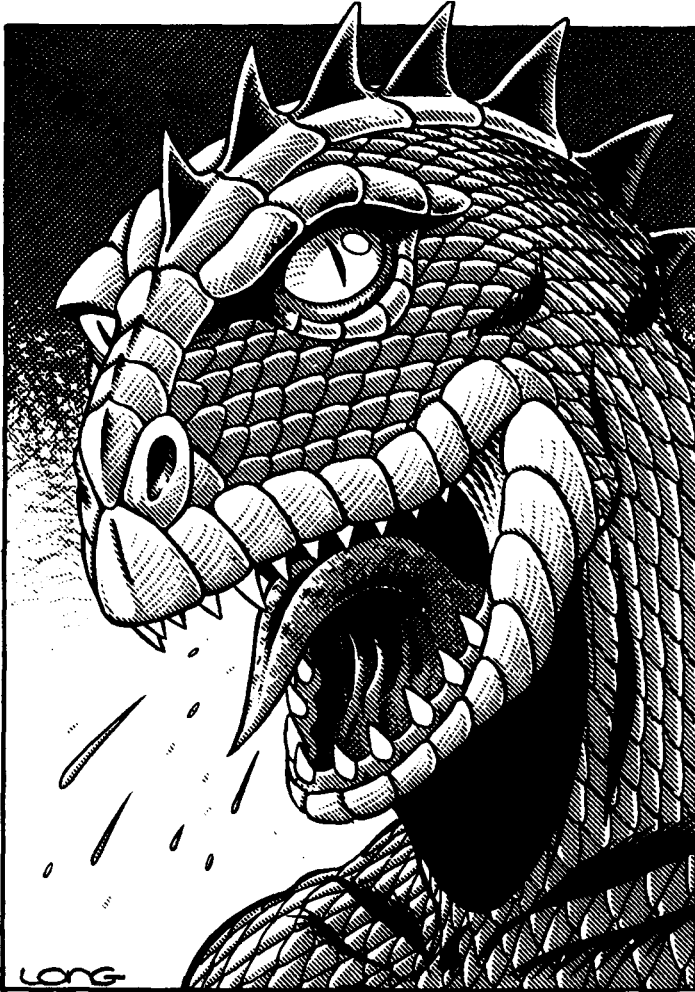

## Society

For centuries, the lizard man communities lived under primitive but harmonious conditions. They are territorial and active colonists, but prefer to live along the coastline and on islands of freshwater rivers, lakes, and swamplands, leaving much of the

jungle interior to habitation by other races. Most lizard men tribes prefer to be left alone, but are often provoked to acts of violence by hostile intruders. However, neighboring human and **D-bee** communities were rarely attacked without reason. There was even some trade conducted with **humanoids** in the hinterlands (dry land did not much interest the lizard men). They also befriended and formed loose alliances with some of the **were-jaguar** tribes in the jungle.

The largest lizard man population centers were the equivalent of small cities with little in the way of industry or services. In many ways, they were little more than a sprawl of tribes that covered miles of river bank and stream with their wooden pole-supported houses and rafts. Manufacturing was very limited. The city government was left in the hands of a king and a council of elders.

Before the coming of the dragons, there were dozens of kings and hundreds of chieftains. Each conducted local affairs as they saw fit. Lizard men only organized themselves as a larger nation during times of grave emergencies. In areas not yet under the direct control of the minions from New Dragcona, this still holds true. Small river villages continue to pursue their simple fishing and food gathering lives, unconcerned with the affairs of the world around them. Elsewhere, things have changed a great deal.

In the middle of each city now stands a steel and concrete City Hall controlled by dragons and their servants. Taxes are collected and put toward the war fund. The young are encouraged to hate humanoids and to want war. Many join the army and many more follow the ways of Dragonwright. The old ways of life are being discarded and war seems imminent.

The Cult of Dragonwright has gained many converts among the lizard **men**, especially in the army and among the young. The young conscripts enjoy a life of relative luxury and are taught that they are the defenders of Dragonwright — holy warriors that deserve the respect and subservience of all common lizard men. Many of them have become swaggering bullies that enjoy intimidating the population. They only fear the officers and members of the "master races," dragons and lizard mages. Soldiers are deliberately assigned to places away from their families and village. Isolated, they are more easily indoctrinated into the militant ways of Dragonwright and they are not "confused" by their families, friends and elders who cling to the old peaceful ways. This practice also encourages aggression and fanaticism, military unity, dedication to the cause and **commaraderie** among the troopers.

Despite these tactics, many lizard men (40%) have rebelled against the regime and the call to war. Whole squads of soldiers have deserted and carry out guerrilla attacks against military operations, especially dragons and the Minions of **Splugorth**. Those opposed to war are becoming as hardened and fanatical as the minions of the evil Dragonwright. Of the lizard men soldiers and supporters in the new regime, at least 25% are torn with doubt and old loyalties. When push comes to shove, many may desert their dragon lords to side with their families and the old way. At this point, a civil war is growing in intensity, but the rebels are hopelessly outnumbered and overpowered.

## Foreign Relations

**Atlantis:** Lagarto is an unofficial ally of Atlantis, although Melastirth insists the alliance is formal and binding. Based on the level of trading with Atlantis (specifically Dragcona) and the number of Kittani advisors, Minions of Splugorth, and latest weapons and armor present (purchased by the shipload, often with slaves), it is easy to understand how one might get that impression. Remember, this is all Styphathal's doing. Lord Splynnrcryth is secretly kept informed of developments, but he has not sanctioned any alliance with Lagarto and will disavow any knowledge to the goings-on there if it serves his purpose. This means that if things go badly in the Amazon, Lord Splynnrcryth will leave them high and dry to fend for themselves. So much for the *appearance of an* alliance with Atlantis.

If Styphathals and Melastirth's campaign goes well, the Splugorth will use Lagarto as a stepping stone to conquer all of South America. However, if Styphathal and/or Melastirth become too ambitious (and successful), Lord Splynnrcryth may become concerned. The Splugorth lord does not want any one nation to grow too strong. If the dragon kingdom becomes too powerful, it might threaten the interests of Atlantis. Should he see this happen, Lord Splynnrcryth may withdraw his support and even covertly start aiding the other nations of South America to defeat Lagarto. No matter how things go, it is the lizard men who'll suffer. They are only pawns in a game controlled by superbeings.

**The Republic of Colombia:** Lagarto views Colombia as its principal enemy to the north. Once it has dealt with any civil insurrection and the threat from the cities of El Dorado, it will turn its attention to Colombia. If (when) this happens, a three-way war will explode between Lagarto, Colombia and the Vampire Kingdom of Haktla, with additional sub-elements and smaller fronts against Bahia, Maga and the pirates.

**The Kingdom of Bahia:** This island has accepted thousands of lizard man refugees fleeing the tyrannical rulers of Lagarto. Pursuing Lagarto troops have fought more than a few skirmishes with the Bahia Coast Guard. Things are likely to get worse soon.

**Maga Island:** Raiders from Lagarto sometimes conduct slave raids on the island domains of the jungle elves. A campaign of conquest is likely, but only after Lagarto has dealt with its more powerful enemies, such as Colombia. The lizard men, like most nations, dramatically underestimate the numbers and powers of the jungle elves and their biomancy magic.

**Omagua:** The city of the jaguar-people once had good relations with many lizard man communities. When the Cult of Dragonwright arrived, Omagua started aiding rebellious lizard men, leading to many violent clashes between the two kingdoms. The gods that rule Omagua have little love for the Cult of Dragonwright, but don't want to start a new war as long as they are threatened by Cibola.

**Manoa:** The city of magic is too far southwest to have any contact with Lagarto.

**Cibola:** The Cibolans continually raid Lagarto and small battles between Cibolan slavers erupt frequently. The people of Lagarto hate Cibola and send small search and destroy squads against them regularly, but for the moment, Cibola is not a target for conquest.

**The Silver River Republics:** The human-controlled kingdoms in the south have little contact with Lagarto. So far, ships headed for Colombia and other islands sail right past New Dragcona without incident. Their ships have suffered more attacks from pirates than from Lagarto. These distant southerners tend to believe the stories of an impending war and the evil of New Dragcona are grossly exaggerated.

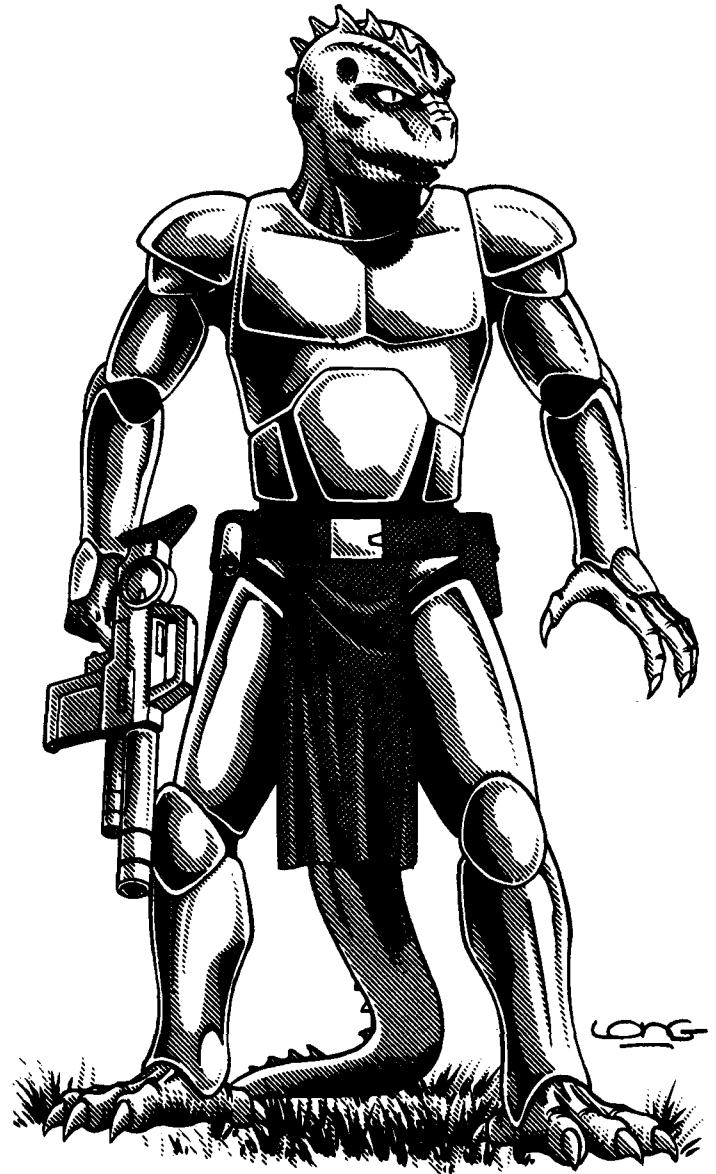

## Armed Forces

Lagarto has one of the largest armies on the continent, over 100,000 troops on full-time duty, plus a militia numbering 200,000! Only the threat of civil war and the huge frontier the army has to cover have prevented it from overtaking other nations. The Lagarto line troops are equipped with Kittani equipment (see the Weapons Section), including several advanced suits of power armor (some new, experimental designs). Besides lizard men, the army has many members of other reptilian races, including tautons, crocodilians, cernun mystics, gargoyles and dragons. For the most part, the army operates in platoons of 20 to 40 troops. Four platoons make up a company and four companies form a regiment. Most jungle forts have one or two regiments stationed at them. Cities can have an entire brigade (four regiments or battalions) or even a full division (four brigades or

sixteen regiments). Described below are some typical platoons used by the **Lagarto** Nation.

#### Typical Tax-Collecting Platoon

- 1 Tauton, lizard mage of **cernun** mystic
- 24 Lizard men in combat armor
- 8 Lizard men or **Kittani** advisors in Serpent or Raptor Power Armor
- 4 Lizard men or Kittani advisors in Equestrian or **Allosaurus** Power Armor
- 4 Hover trucks to carry produce or slaves

#### Search and Destroy Platoon

- 4 Tautons, **Crocodilians** or Gargoyles
- 6 Lizard men in combat armor
- 6 Lizard men in **K-Universal** power armor
- 4 Serpent Power Armor suits
- 4 Raptor Power Armor suits
- 2 **Tyrannosaurus** robots

#### Amphibious Platoon

- 8 M.D.C. canoes (80 M.D.C.)
- 24 Lizard men in amphibious combat armor
- 8 Crocodilians
- 4 Serpent Armor suits

#### Extermination Platoon

- 1 Adult dragon or 4 dragon hatchlings
- 8 Gargoyles
- 4 Tautons
- 1 Cernun Mystic
- 4 **Gigantes**
- 8 Serpent Power Armor
- 8 Raptor Power Armor
- 4 **Allosaurus** Power Armor
- 4 **Tyrannosaurus** Robots

## New Dragcona

**Population:** Approximately 65,000+ inhabitants and growing.

- 25,000 Lizard men
- 6,000 Tautons (see **Rifts Africa**)
- 6,000 **Lyvorrkians**
- 5,000 Crocodilians (see **Rifts Africa**)
- 2,500 Cernun mystics (see **Rifts England**)
- 6,000 Gigantes (see **Rifts Conversion Book One**)
- 2,000 Gargoyles
- 2,000 **Kydian** Overlords (see **Rifts Atlantis**)
- 3,000 T-men (see **Rifts Atlantis**)
- 500 Lizard mages (see **Rifts Conversion Book One**)
- 7,000 Humans
- 1D4X100Dragons

This does not include visitors (2D4X1000 at any given time; most are from Atlantis and the New Phoenix Empire) or slaves (20,000; 70% humans and 30% lizard men/political prisoners).

New Dragcona is the newest and largest city in Lagarto. It is located on the east coast of the continent and is intended as a major trading port. **Splugorth** ships going to Atlantis and the African city of **Gorth** (see **Rifts Africa**) stop there to fill their holds

with slaves, rare minerals, and other valuable items. Like its namesake in Atlantis, the city has a sinister and unkempt look to it, reflecting the dark side of the Cult of **Dragonwright**. Decadence and vice abounds and dragons and other super-powerful **D-bees** do as they please with the human population (both free and slave). Even many of the non-military lizard men suffer abuse at the hands of dragons and the Minions of **Splugorth**.

New Dragcona is the least like any of the lizard men villages or cities. By comparison, it is a cosmopolitan port with large buildings, magic, technology and services that appeals primarily to beings other than lizard men. Most lizard men dislike the city and avoid it if they can.

## First City

**Population:** 50,000 total. 40,000 lizard men and the rest belong to diverse reptilian races. In addition, there is an occupation force of 5,000 Minions of **Splugorth**; 47% are gargoyles, 50% Kittani and, 3% young dragons (average level of experience is 1D4+1, with only a handful of adult dragons).

For the most part, this city is built on the top of the river itself. Buildings are mounted on wooden poles set into the riverbed, as is lizard man tradition. Once the major city of Lagarto, it now suffers under the occupation of dragons and **Atlantean** minions and the inhabitants live in constant fear. The floating city has become an armed camp and represents everything that is wrong with the Dragonwright war effort.

A secret resistance movement is quickly forming among the original inhabitants who want to return to their old, comparatively peaceful way of life. This well organized force is dedicated and growing, with several small, neighboring lizard men villages contributing manpower, information and support. If civil war erupts, First City is likely to become the rebels' stronghold.

## Melastirth

### Dragon Overlord of Lagarto

Many dragons believe that their great power and near immortality makes them the absolute superior over most species in the Megaverse. These same dragons tend to believe that they don't receive the respect they are due. Melastirth is even more radical. Bolstered by obscure passages in the writings of the (evil) Dragonwright religion, he feels that all **non-dragonic** races must be enslaved and led by the true masters of the Megaverse, dragons. Those who resist this rule should be beaten into submission or exterminated. Melastirth is the "Hitler" of **dragonkind**, complete with a master race, a master plan, and a campaign of selected genocide. He knows he won't live to see his dream of a dragon dominated Megaverse fulfilled (he figures that the great campaign will take over 50,000 years, as foretold in the scriptures of Dragonwright, which is a very long time even for a dragon), but he wants to see the process started during his lifetime.

Melastirth joined **Styphthal** in Dragcona soon after the return of Atlantis. Rifts Earth with its multidimensional connections and mystic energy, seems to be the ideal place to launch his crusade. When it came to **Melastirth's** attention that a lizard man civilization was thriving in South America he saw it as a sign. The Dragonwright religion is often used to trick **non-drag-**



ons into contributing to their own enslavement or destruction. At many places in the Megaverse, reptilian species have venerated dragons, so Melastirth thought these creatures would make ideal pawns. He prepared a plan that would eventually guarantee him control over the entire South American continent. When he presented it to Styphathal, the dragon-god was very interested and Melastirth was given full funding and support. Thousands of reptilian humanoids were recruited from a dozen different worlds, including other types of lizard men, dragons, tautons, crocodilians, cernun, gargoyles and lizard mages.

Then Melastirth made his move. The lizard men, loosely organized and possessing nowhere near the craftiness or deviousness of the evil dragon, were easily intimidated and their spirits conquered — at first. Resistance has been quietly growing and Melastirth's ideal of a united "Scaled Ones" nation is already beginning to come apart. The dragon is growing more and more frustrated, ordering more frequent atrocities to squash any resistance. This is accelerating his plans of war and conquest.

Note: Over the last two centuries, Melastirth has become one of Styphathal's most trusted and feared lieutenants. Although Melastirth suspects his leader does not share his visions of the future, he still respects, obeys and admires him. Meanwhile, Styphathal has embraced and encouraged Melastirth's madness. He knows about his lieutenant's delusions and, although he thinks them ridiculous, sees them as a means to acquire more power. Should Melastirth fail, he has lost nothing. Should Melastirth go too far, he will slay him and claim all of his conquests for himself. If nothing else, Styphathal recognizes that the exploits of Melastirth should provide years of entertainment. Styphathal's only mistake is underestimating Melastirth's blind ambition, fanatical resolve and growing levels of experience and power.

**Alignment:** Diabolic; considers only dragons, gods, major demons and other greater beings to be his equals, and will deal

with them honorably. He feels free to lie, cheat or steal from all other people.

Species: Great Horned Dragon

Age: 1500 years old

**Horror Factor:** 14

**Attributes:** I.Q. 28, M.A. 27, M.E. 20, P.S. 49, P.P. 17, P.E. 24, P.B. 23, Spd. 70 running, 130 flying.

M.D.C.: 7500

P.P.E.: 1000

**Natural Abilities:** Nightvision 100 feet (30.5 m; can see in total darkness), see the invisible, turn invisible at will, regenerates 1D4X10 M.D.C. per minute, takes half damage from all fire attacks (including M.D. fire and plasma), teleport self 92%, dimensional teleport 52%, and metamorphosis at will (lasts for an indefinite period).

**Disposition:** A master manipulator, public speaker, and politician. He would be even more effective if he wasn't impaired by his prejudices against all "lesser races" and dreams of cosmic glory. Melastirth tends to underestimate humans and other humanoids, and this has stolen a few victories from his grasp. He tries to justify these setbacks as proof of the treachery and cowardice of non-reptilians and one more reason why they should be destroyed. Melastirth is truly insane, but so far he has managed to make his delusions work to his advantage.

**Experience Level:** 20th level dragon and equivalent to a 10th level spell caster and a 14th level psychic.

**Magic Knowledge:** Knows all spell magic levels 1-15. P.P.E.: 1000

**Psionic Powers:** Knows all sensitive, physical and healing powers plus bio-manipulation and psi sword. I.S.P.: 120

**Combat Skills:** Natural

**Attacks per Melee:** Eight physical or psionic attacks per melee, or four fire breaths and four physical or psionic, or three by magic.

**Bonuses:** +4 on initiative, +4 to strike, +5 to parry and dodge, +34 to S.D.C. damage, +4 to roll with impact/punch, +4 to pull punch, +9 to save vs poison, +9 to save vs magic, +7 to save vs psionics, +7 to save vs horror factor.

**Weapon Proficiencies:** W.P. Sword, W.P. Energy Pistol.

**Weapons:** Owns several Kittani and Splugorth weapons, as well as an Impaler rune sword (see Rifts Atlantis).

**Armor:** Never wears any.

**Skills of Note:** Basic and advanced math 98%, literate in Dragonese/Elven, Spanish, Creole, American, Euro, Kydian, and Kittani, at 98%, demon and monster lore 98%, faerie lore 90%, monster lore 98%, detect ambush 98%, detect concealment 98%, wilderness survival 98%.

**Description:** In dragon form, Melastirth is a powerful horned dragon, 30 feet (9.1 m) tall and 70 feet (21.3 m) long, with bright golden/orange scales and a magnificent spiny ridge. He often uses his shapeshifting powers to take on the form of a gigantic lizard man, 10 feet (3.0 m) tall.

## Stleet

### High King of Lagarto

---

Stleet is the High King of Lagarto, Defender of the Scaled Ones and Paladin of Dragonwright. The lizard man started out as a warrior defending a tiny fishing village on the West Bank of the Greater Amazon. He was captured by pirates and taken to one of the northern islands. There, he was purchased by another pirate leader. Stleet's fighting skills and savagery endeared him to his master. The two eventually became friends, Stleet was freed and hired to be his former master's personal bodyguard. Stleet repaid the man's trust one night by slitting his throat and stealing a sailboat full of high-tech weapons, armor and other valuables. He then sailed to a large lizard man village where he told a story of harrowing ordeals at the hands of slavers and his daring escape. The lies and his wealth made him a hero and an influential person in lizard man society.

The self-serving Stleet was never a religious person, but when he was offered a great deal of power, magic weapons and other prizes he became a quick convert to the Cult of Dragonwright. He has quickly become Melastirth's most trusted agent among the lizard men. The murder of the elder lizard chief during Melastirth's speech was carefully planned and choreographed in advance. Even the words Stleet spoke were lines he had memorized previously! Thus is history sometimes made.

Besides his appointment as High King, Stleet was also rewarded with a trip to Atlantis and free treatment in the Bio-Wizard's transforming tanks. The Splugorth alchemists were careful not to deform Stleet — in fact, he came out of the vats looking even better and more heroic than before. In addition to augmented strength, he also received the power of breathing flame (he often suggests that the truly worthy followers of Dragon-

wright get this reward). After the treatment, Stleet made a show of killing four lizard men in hand to hand combat, using only his bare hands and his supernatural strength. These frequent displays of brutality have frightened many lizard men as well as intensified the rebels' hatred of the new regime. Stleet is now considered to be a demon, or even worse, someone who sold his soul to a dark power.

Over the last several years, there have been no less than 30 attempts on Stleet's life. Most have been at the hands of "trusted" servants and business associates who have turned on him. Other attacks have been at the hands of those seeking revenge. The most recent was a sophisticated bombing attempt that so seriously injured him that he barely survived even with Atlantean medicine and magic. This attack could not be traced to any lizard man or associate and has started rumors that Stleet's masters may be trying to eliminate him. The truth is that the attack was orchestrated by agents of Cibola in an attempt to create chaos and dissension among the lizard people.

**Alignment:** Miscreant

**Species:** A lizard man bio-borg.

**Horror Factor:** 14, but only when in an attack frenzy.

**Attributes:** I.Q. 14, M.A. 17, M.E. 12, P.S. 30, P.P. 21, P.E. 21, P.B. 22, Spd. 44. Supernatural strength and endurance (inflicts 3D6 M.D. with a punch or kick, 6D6 M.D. from a power punch).

**M.D.C.:** 200

**P.P.E.:** 3

**Natural Abilities:** Breathe underwater, polarized vision, swim 90%. Has been endowed with dragon's breath implants (4D6 M.D., range 30 feet/9.1 m, can breathe flames one time per melee, and counts as an additional attack per melee round).

**Disposition:** One of the worst scoundrels ever spawned. Stleet will sell out, absolutely anybody, if he thinks he can get something worthwhile out of it. He is a compulsive liar, but is very careful about getting caught. Stleet feels no loyalty towards either Melastirth or the cult of Dragonwright. He's even got a story prepared should the lizard people rise up in arms and overthrow the dragon's rule. In that case, he will claim he was first deceived and then brainwashed by the cruel monsters and will point to the few scars he got from the bio-wizardry modifications and mysterious explosion as proof of torture and betrayal. If this yarn doesn't work he will flee the area to save his unworthy skin, probably throwing in with pirates or even Cibolans.

**Experience Level:** 8th level warrior

**Magic Knowledge:** None

**Psionic Powers:** None

**Combat Skills:** Hand to Hand: Expert and power armor basic.

**Attacks per Melee:** Four (plus fire breath once per melee).

**Bonuses:** +1 on initiative, +5 to strike (+6 underwater), +6 to parry and dodge (+7 to parry and +8 to dodge underwater), +15 to S.D.C. damage, +2 to roll with impact/punch, +2 to pull punch, +6 to save vs poison, +3 to save vs magic.

**Weapon Proficiencies:** W.P. sword, W.P. blunt, W.P. energy pistol, and W.P. energy rifle.

**Weapons:** Favors vibro-swords, spears and other archaic weapons. Has a lesser rune bastard sword that inflicts 6D6 M.D. and has an evil alignment, I.Q. 13, and all the standard rune sword powers. He also has a **KEP-Special** energy pump pistol

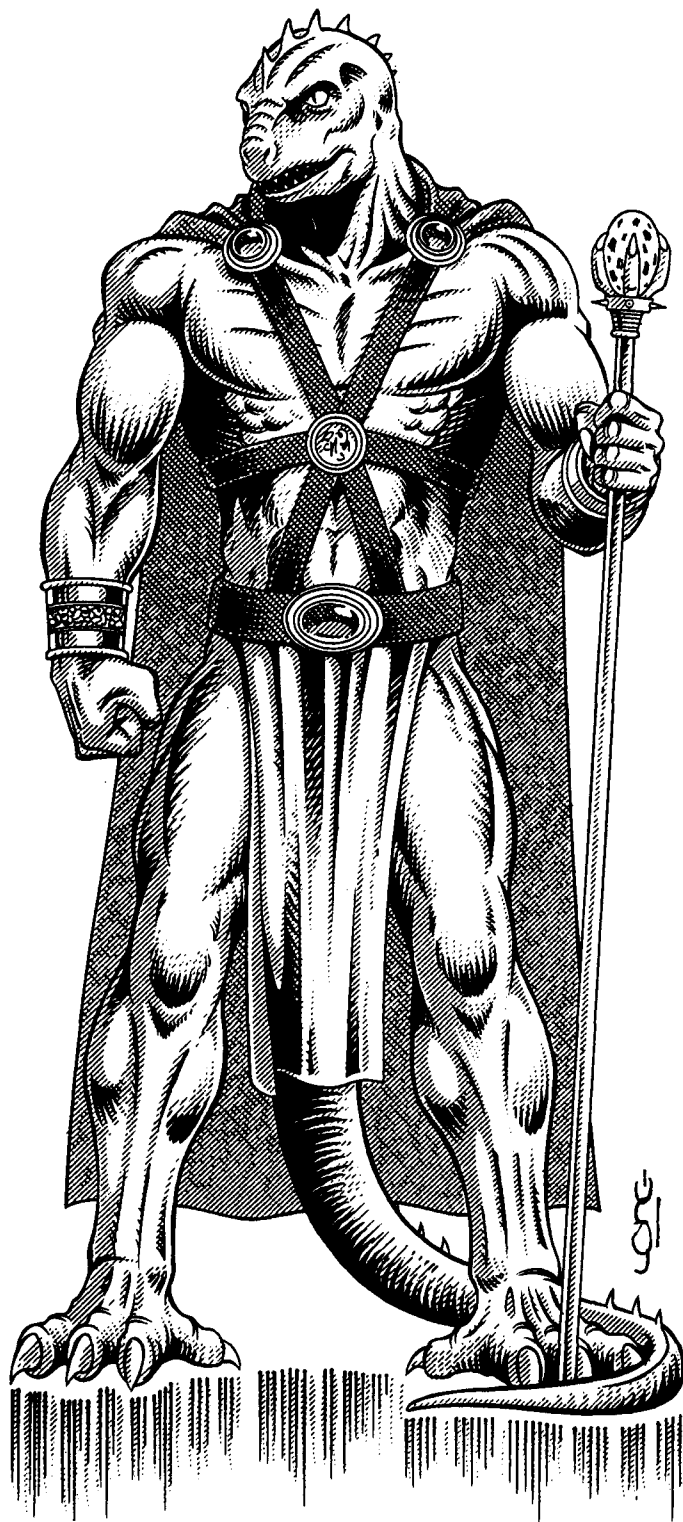

as his personal sidearm (Kittani manufacture: inflicts 5D6 M.D.) and he pilots a Raptor power armor.

**Armor:** Suit of gilded and highly polished Kittani explorer armor (85 M.D.C.).

**Skills of Note:** Fishing 98%, dance 75%, play musical instrument 80%, speak Dragonese/Elven and Creole 98%, basic math 90%, climb 90%, pilot sail and motor boat 98%, boat building 80%, track animals 65%, preserve food 70%, land navigation 73%, and wilderness survival 80%.

**Description:** An over-muscled, tall lizard man (six feet/1.8 m tall, a giant among his species). As a side effect of his bio-wizard transformation, his eyes are yellow and he has some scars.

## Lizard Men R.C.C. Optional Player Characters

In the last decade and a half, the lizard men inhabitants of Lagarto have become divided into two groups. The first one is the traditional lizard man who is the reclusive, primitive hunter described in **Rifts Conversion Book One**.

The second group comprises the followers of New Dragcona and evil Dragonwright. They are far more aggressive, militant and serve as the newly-trained soldiers for the "Nation of Scaled Peoples." This generation of lizard men are also a lot more sophisticated technologically and socially. Many of them have joined the army at a very young age, and have been indoctrinated and trained with techniques similar to those used by the Coalition States and Atlantis.

Some of these trained lizard men have deserted and now work with the resistance or have escaped to other nations, where they sell their services as mercenaries or pirates. Player characters could come from either group or be one of the traditional lizard men. In the latter case, they will have little knowledge or skills pertaining to technology.

**Alignment:** Any

**Attributes:** I.Q. 3D6, M.E. 2D6, M.A. 3D6, P.S. 3D6, P.P. 3D6, P.E. 3D6, P.B. 3D6, Spd 3D6 running and climbing, twice as fast swimming.

**Hit Points:** Standard

S.D.C.: 1D6X10

**Horror Factor:** 13 when in an attack frenzy.

P.P.E.: 2D6

**Natural Abilities:** Breathe underwater (indefinitely), natural polarized vision, and swim 90%.

**Magic:** By O.C.C. only.

**Psionics:** Standard

O.C.C.: Any, except Borg or Coalition military O.C.C.s. Soldiers of the Lagarto army are equal to Headhunters, Wilderness Scouts or Special Forces Soldiers.

**O.C.C. Bonuses:** +1 on initiative, +1 to strike and parry underwater, +2 to dodge underwater. Soldiers of Lagarto are also +1 to strike and parry in any combat situation and get an additional 3D6 S.D.C. points.

**Average Life Span:** 50 years

**Habitat:** Rivers, streams, swamps and lakes.

**Size:** Four and a half to five and a half feet (1.4 to 1.7 m)

**Weight:** 80 to 150 lbs (36 to 67.5 kg)

**Appearance:** Reptilian humanoids with fine, scaly green skin and bright green or blue eyes. A spiny crest runs along the tail. The mouth is filled with small but sharp teeth.



## Weapons and Armor of Lagarto

**Most standard issue weapons** in Lagarto are of Kittani manufacture, but some Colombian and other items may be available, especially to officers and special operatives. The typical soldier is equipped with Kittani Explorer armor (M.D.C. 85), a sword, and a K-4 laser pulse rifle or K-6 ion pulse rifle. Elite units wear K-Universal light power armor (M.D.C. 220) and may have a handgun or plasma sword in addition to the rifle and conventional sword.

Rebel lizard men tend to rely on ancient weapons and **technowizard** equipment. Long-range energy weapons are in short supply — the formal army has vastly more powerful weapons.

### The “Carnosaurus” Kittani Series

This is a new line of experimental Kittani power armor purchased by the rulers of New Dragcona to outfit its armies. The designers of these robotic suits were inspired by the dinosaur predators found in regions of Rifts Earth and by the archaeological records of Earth's prehistory. The Kittani were fascinated by the sleekness and lethal grace of the predators from the Jurassic and Cretaceous Eras. The results of their research were two power armor suits and one giant robot. **These vehicles** are well suited for jungle warfare and can function in swamps or rivers without trouble. Furthermore, their reptilian motifs make them very attractive to the **Dragonwright** cultists who consider dinosaurs to be primitive relatives to dragons (although this is far from being a proven scientific fact).

The power armor and robots follow the general shape and form of the ancient dinosaurs, but have the typically baroque spines, decorations and modern weaponry that are the Kittani trademark. They are heavily armed and armored and their speed and power match any war machine on Earth. Several dozen Carnosaurus suits are being deployed along the borders of Lagarto and have already proven their effectiveness in clashes against **Cibolan** and **Omaguan** patrols. Only a few lizard men deserters have managed to steal a few of these new machines.

### Kittani Raptor Power Armor/Robot

The Raptor is a medium-sized power armor based on the **velociraptor** predators of the Jurassic Era. The suit is bipedal, balanced by a long tail, with undersized arms. Like their namesakes the raptors are excellent runners and **leapers** and adept at delivering powerful slashing kicks. Their jaws use hydraulic presses to deliver a nasty bite. Additionally it has the usual range of built-in weaponry, including twin missile launchers and an assortment of lasers. The pilot is inside the main body/torso, with his legs curled up. The raptor's legs are wholly mechanical, making it one of the fastest robot runners on the market. **Thrust**-assisted leaps give it even greater mobility and allow it to leap great distances in a single bound. The speed and maneuverability of the raptor bot is awesome.



**Model Type:** Kittani RPA

**Class:** Heavy Infantry Environmental Exo-Skeleton

**Crew:** One

**Current Status:** Fully field tested and ready for mass production.

**M.D.C. by Location:**

Concealed Shoulders Missile Launchers (2) — 100 each

Arms/Laser Mounts (2) — 80 each

Clawed Hands (2) — 35 each

Hip Thrusters — 75 each

Legs (2) — 160 each

Clawed Feet (2) — 90 each

\* Tail — 120

\*\* Head — 130

\*\*\* Main Body — 350

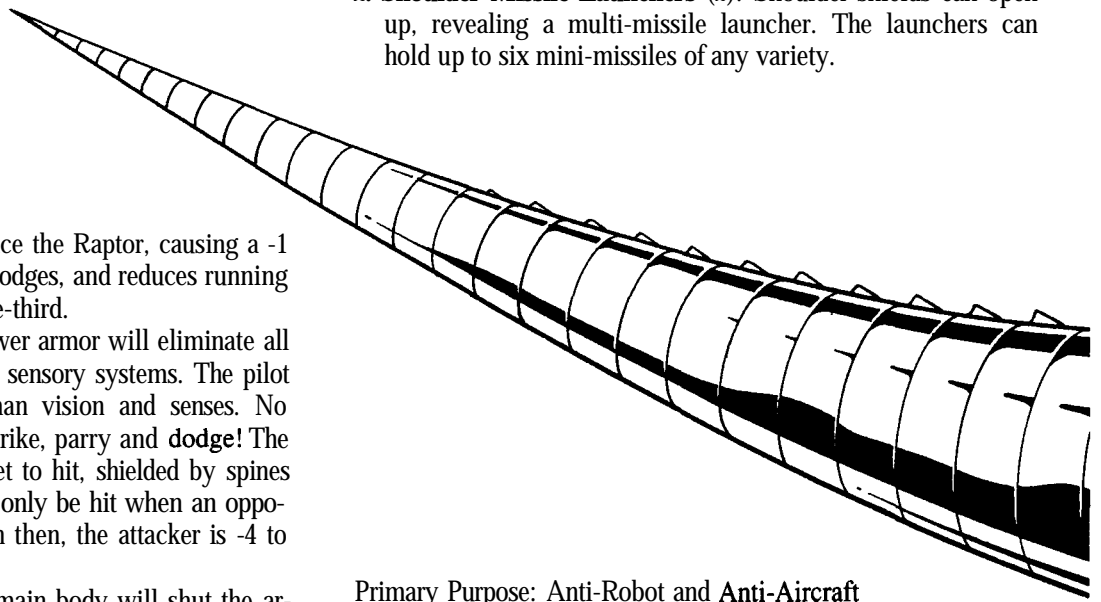

\* Destroying the tail will unbalance the Raptor, causing a -1 penalty to all strikes, parries and dodges, and reduces running speed and leaping distances by one-third.

\*\* Destroying the head of the power armor will eliminate all forms of optical enhancement and sensory systems. The pilot must now rely on his own human vision and senses. No power armor combat bonuses to strike, parry and **dodge!** The head is a small and difficult target to hit, shielded by spines and shoulder plating. Thus, it can only be hit when an opponent makes a called shot and even then, the attacker is -4 to strike.

\*\*\* Depleting the M.D.C. of the main body will shut the armor down completely, making it useless.

**Speed:**

Running: 150 mph (240 km) maximum. Cruising speed is a more cautious 60 mph (96 km). The act of running does not tire the operator in the least.

Leaping: A standing still leap is 40 feet (12.2 m) up or lengthwise. A running leap can reach about 60 feet (18.3 m) in height or 120 feet (36.6 m) in length, while a jet **thruster** assisted leap can reach 200 feet (61.0 m) in length and 100 feet (30.5 m) in height!

Swimming: 20 mph (32 km) or 40 mph (64 km) when assisted by the **thrusters**.

Flying: Not possible. The rear thrusters add to the raptor's leaping and swimming speed, not flight.

**Statistical Data:**

Height: Stands 10 feet (3.0 m) tall (Note: The original **velociraptor** dinosaur stood about 6 feet/1.8 m tall but its cousin, the larger **Deinonychus**, stood 10 feet/3m tall).

Width: 6 feet (1.8 m)

Length: 24 feet (7.3 m) long from head to tail tip.

Weight: One ton (907 kg)

Physical Strength: Equal to a P.S. 35

Cargo: None

Power System: Nuclear power with a 20 year life.

Market Cost: 30 million credits; sold only to **Splugorth** allies like New Dragcona, never on the open market.

**Weapon Systems**

**1. Laser Mounts (2):** Each arm has a mounted pulse laser that can fire coordinated blasts or shoot at different targets. Laser frequency can be adjusted by the pilot to defeat laser-resistant armor suits like the Glitter Boy.

Primary Purpose: Assault

Secondary Purpose: Defense

Mega-Damage: 6D6 M.D. for a single laser pulse, or 1D6X10 for a combined laser burst (counts as two attacks).

Rate of Fire: Equal to number of combined hand to hand attacks (average 6 to 8).

Effective Range: 4000 feet (1220 m)

Payload: Effectively unlimited.

**2. Shoulder Missile Launchers (2):** Shoulder shields can open up, revealing a multi-missile launcher. The launchers can hold up to six mini-missiles of any variety.

Primary Purpose: Anti-Robot and Anti-Aircraft

Secondary Purpose: Defense

Mega-Damage: Varies with mini-missile. Standard load is plasma missiles (1D6X10 M.D.).

Rate of Fire: One at a time or volleys of two, four, six, eight or twelve missiles.

Effective Range: About one mile (1.6 km).

Payload: 12 total; six per launcher.

**3. Head Laser Beams:** The eyes in the bot's head are actually medium-range lasers used for close combat. A favorite tactic consists of grappling or biting an opponent, then firing the eye lasers at point-blank range.

Primary Purpose: Anti-Personnel

Secondary Purpose: Defense

Mega-Damage: 2D6 M.D. per single blast or 4D6 M.D. per dual blast (counts as one attack).

Rate of Fire: Equal to number of combined hand to hand attacks (average 6 to 8).

Effective Range: 2000 feet (610 m)

Payload: Effectively unlimited.

**4. Hand to Hand Combat:** Rather than use a weapon, the pilot can engage in mega-damage hand to hand combat. The hands on the small arms have claws and each foot has a large retractable, scythe-like, claw designed for kicking, slashing and cutting.

Damage:

Restrained Punch: 1D4M.D.

Full Strength Punch: 2D6 M.D.

Power Punch: 4D6 M.D. (counts as two melee attacks)

Kick: 4D6 M.D.

Slashing Claw Kick: 5D6 M.D.

Leap Kick: 1D4×10M.D. (counts as two melee attacks).

Slashing Claw Leap Kick: 1D6×10M.D. (counts as two attacks)

Tail Strike: 4D6 M.D.

Bite: 4D6 M.D.

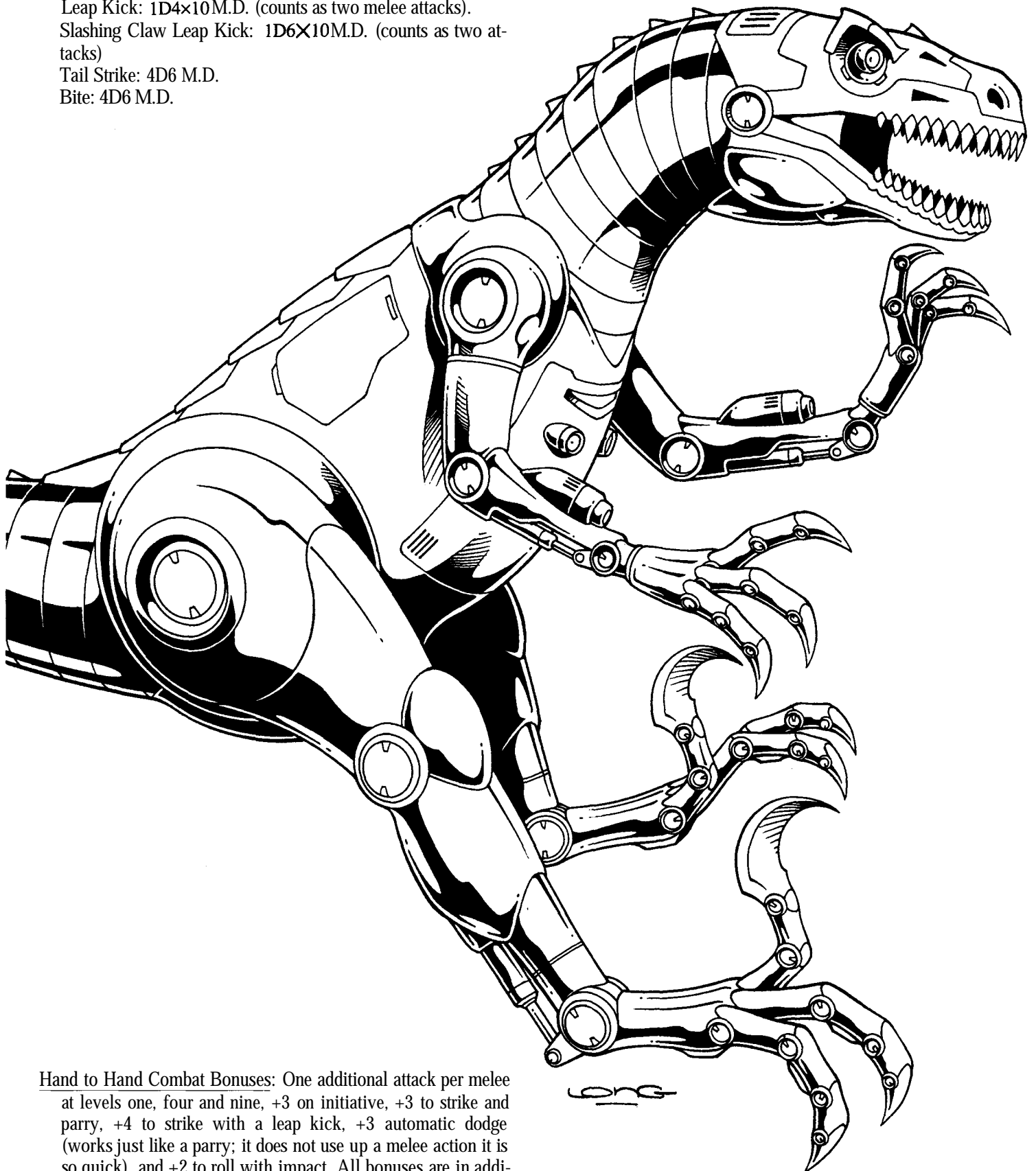

Hand to Hand Combat Bonuses: One additional attack per melee at levels one, four and nine, +3 on initiative, +3 to strike and parry, +4 to strike with a leap kick, +3 automatic dodge (works just like a parry; it does not use up a melee action it is so quick), and +2 to roll with impact. All bonuses are in addition to hand to hand skill and attribute bonuses.

## Kittani Allosaurus "Firedrake" Power Armor

The Allosaurus is a larger bipedal suit that is arguably a one-man robot vehicle rather than power armor. It is more heavily armored and unlike the raptor suits, is not designed for kicking or leaping, but for running and delivering a nasty bite. Their bulk conceals many nasty surprises, including a medium-range missile launcher, a tri-barrel rail gun and many weapon systems. The designers added a plasma projector mounted in the mouth. This super-flamethrower has earned the armored bot the nickname "Firedrake" and is a favorite of dragons.

Despite its greater size, the bot is still very fast, maneuverable and well suited to a jungle environment. The Allosaurus is designed to work side by side with raptor and serpent armor in a support role.

**Model Type:** Kittani APA

**Class:** Strategic Mobile Assault Suit

**Crew:** One

**Current Status:** Experimental Prototype

**M.D.C. by Location:**

Mini-Missile Launchers (2, side-back) — 120each

Tri-Barrel Super Rail Arms (2) — 150 each

Arms (2) — 100 each

Clawed Hands (2) — 50 each

Chest Medium-Range Missile Launcher — 160

Legs (2) — 200 each

Clawed Feet (2) — 110each

\* Tail — 200

\*\* Head — 120

\*\*\* Main Body — 475

\* Destroying the tail will unbalance the allosaurus bot, causing a -1 penalty to all strikes, parries and dodges, and reducing running speed and leaping distances by one-third.

\*\* Destroying the head will eliminate all forms of optical enhancement and sensory systems. The pilot must now rely on his own vision and senses. No power armor combat bonuses to strike, parry and dodge! The head is a comparatively small, moving target. Thus, it can only be struck when an opponent makes a called shot and even then, the attacker is -2 to strike.

\*\*\* Depleting the M.D.C. of the main body will shut the armor down completely, rendering it useless.

**Speed:**

**Running:** 100 mph (160 km) maximum. Note that the act of running does not tire the robot's operator.

**Leaping:** The robot legs can leap up to 15 feet (4.6 m) high or lengthwise unassisted by thrusters. A jet thruster assisted leap can project the unit up to 50 feet (15.2 m) high and 100 feet (30.5 m) lengthwise.

**Swimming:** 15 mph (24 km) or 30 mph (48 km) when assisted by the thrusters.

**Flying:** Not possible.

**Statistical Data:**

**Height:** 17 feet (5.2 m) tall (about half the size of the original dinosaur which was 35 to 40 feet/107 to 12.2 m).

**Width:** 10 feet (3.0 m) with weapon turrets.

**Length:** 30 feet (9.1 m) long from head to tail tip.

**Weight:** 3 tons (2700 kg)

**Physical Strength:** Equal to a P.S. 48

**Cargo:** Small area for pilot's personal items and a weapon bin with room for one rifle, one pistol, canteen and food rations.

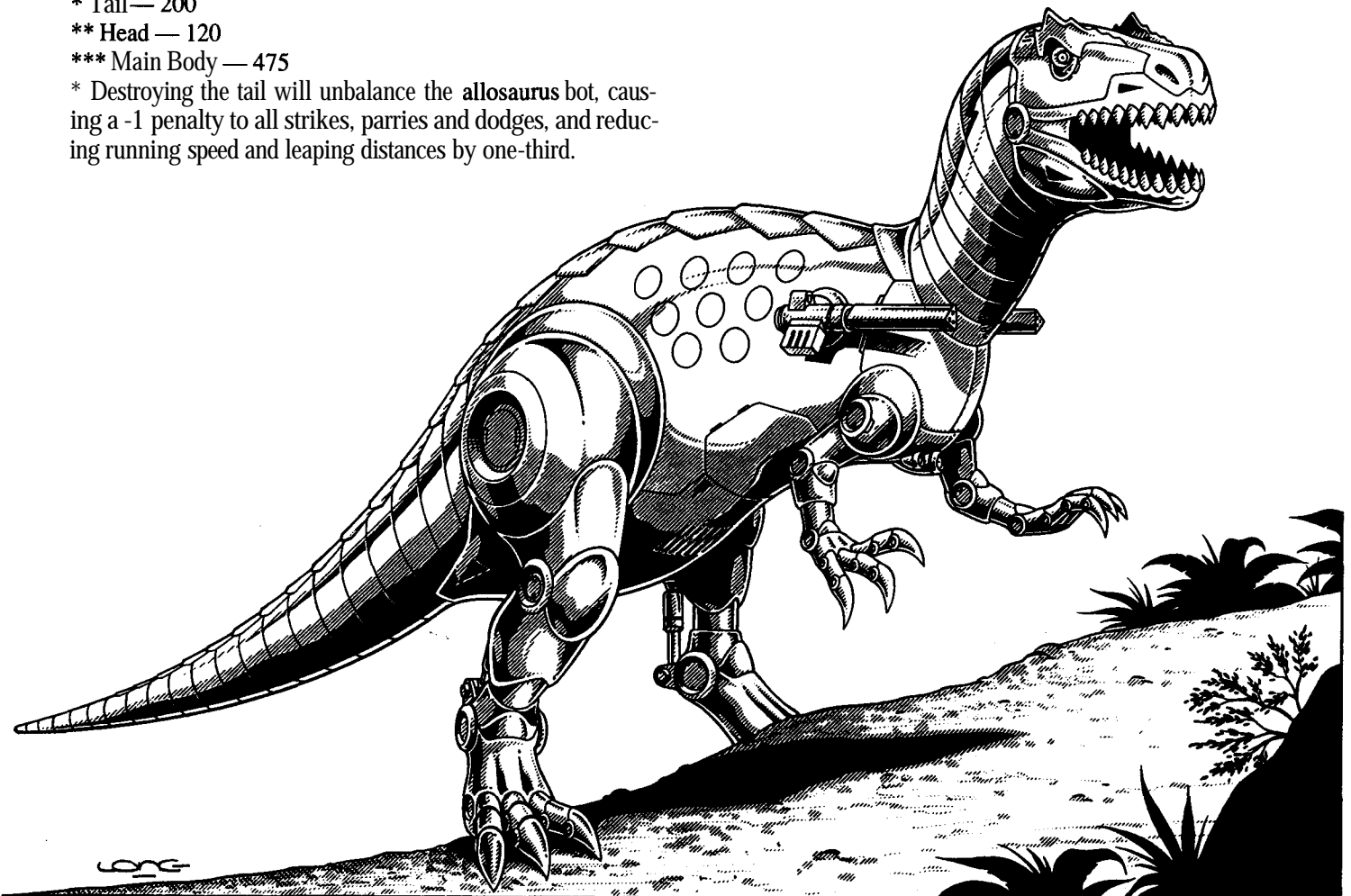

Power System: Nuclear; average energy life is 20 years.  
Market Cost: 50 million credits. Sold only to allies like the New Dragona government, never on the open market.

## Weapon Systems

**1. Medium-Range Missile Launcher:** Chest plates protect the housing that contains four medium-range missiles. The plates flip up and slide out of the way so the missiles can be launched.

Primary Purpose: Anti-Armor

Secondary Purpose: Defense

Mega-Damage: Varies with missile type. Commonly uses plasma missiles (2D6X10 M.D.)

Rate of Fire: One at a time or volleys of two or four missiles.

Effective Range: About 40 miles (64 km).

Payload: Four missiles total, two in each chest housing.

**2. Tri-Barrel Super Rail Gun Arms (2):** This is the same gun used by the **Kittani** Equestrian Power Armor (see **Rifts Atlantis**), with the same mount style. The **Allosaurus** has two of these big guns mounted above and behind its two small arms. They can be fired one at a time at different targets or at the same target simultaneously. The weapons are hooked directly to the armor's nuclear power supply and can be pointed 180 degrees up and down and 90 degrees side to side.

Primary Purpose: Assault

Secondary Purpose: Defense

Mega-Damage: A burst is 40 rounds and inflicts 1D6X10 M.D.; can only fire bursts. Targets located straight ahead can be fired upon by both rail guns, inflicting 2D4X10 M.D. per double burst (counts as one melee attack).

Rate of Fire: Can fire up to six bursts per melee round (each counts as one melee attack).

Effective Range: 6000 feet (1830 m)

Payload: 4000 round drum, that's 100 bursts. If a second drum is added, it feeds immediately after the first drum is exhausted. Reloading a drum will take about five minutes, even for those trained in its use, and a strength of 26 or higher is required.

Special Weapon Features: The rail gun has its own laser targeting and radar tracking system built into the weapon itself.

Range: 6000 feet (1830 m).

Bonuses: +2 to strike.

**3. Concealed Mini-Missile Launchers (2):** A mini-missile launcher is concealed on each side and back area of the **allosaurus**. The launch tubes appear as small circular plates or hatches on the body.

Primary Purpose: Anti-Robot, Anti-Aircraft.

Secondary Purpose: Defense.

Mega-Damage: Varies with mini-missile type. Standard load is plasma missiles (1D6 x 10 M.D.).

Rate of Fire: One at a time or volleys of two, four, six, eight or twelve missiles.

Effective Range: About one mile (1.6 km).

Payload: 24; 12 mini-missiles per each launcher.

**4. Mouth-mounted Plasma Projector:** This short-range weapon delivers a short-range but very intense jet of plasma fire. The plasma discharge is devastating in close combat and is often used to burn down villages and woodlands.

Primary Purpose: Assault

Secondary Purpose: Anti-Personnel

Mega-Damage: 2D4X10 M.D.!

Rate of Fire: Once per melee round only (counts as one melee attack).

Effective Range: 300 feet (91.4 m)

Payload: Effectively unlimited.

**5. Hand to Hand Combat:** Rather than use a weapon; the pilot can engage in mega-damage hand to hand combat.

Damage:

Restrained Punch: 1D6 M.D.

Full Strength Punch: 5D6 M.D.

Power Punch: 1D6X10 M.D. (counts as two attacks)

Kick: 5D6 M.D.

Leap Kick: 1D6X10 M.D. (counts as two attacks)

Tail Strike: 5D6 M.D.

Bite: 1D4X10 M.D.

Head Butt: 2D6 M.D.

Stomp: 2D6 M.D.; effective only against opponents 8 feet (2.4 m) tall or smaller.

Hand to Hand Combat Bonuses: One additional attack per melee at levels one, five and ten, +2 on initiative, +2 to strike and parry, +1 to dodge, +1 to roll with impact. All bonuses are in addition to hand to hand skill and attribute bonuses.

## Kittani Tyrannosaurus Robot Vehicle

This is the largest of the **Carnosaurus** series. It is the heaviest and most powerful robot combat vehicle used by the Kingdom of **Lagarto**. The mere sight of one of these robots crashing through the rain forest is enough to cause panic among the lizard men; many of whom consider it to be the avatar of an ancient god. Although the Tyrannosaurus is relatively slow compared to its smaller "cousins," its **firepower** is unmatched.

**Model Type:** Strategic Assault Robot Vehicle

**Class:** Kittani TRV

**Crew:** Two: pilot and a **co-pilot/gunner**. Can accommodate two human-sized passengers.

**Current Status:** Experimental Prototype

**M.D.C. by Location:**

Shoulder Medium-Range Missile Launchers (2) — 300 each

Belly Rail Gun Turret — 120

Concealed Mini-Missile Launchers (2) — 100 each

Side Twin-Barrel Pulse Cannons (2) — 150 each

Arms (2, small) — 130 each

Clawed Two-Finger Hands (2) — 50 each

Legs (2) — 300 each

\* Tail — 320

\*\* Head and Sensors — 240

Reinforced Pilot's Compartment — 120

\*\*\* Main Body — 600

\* Destroying the tail will unbalance the robot, causing a -1 penalty to all strikes, parries and dodges, and reduces running speed and leaping distances by one-third.

\*\* Destroying the head of the robot will eliminate all forms of optical enhancement and sensory systems. The pilot must rely on his own vision and senses. In addition, all combat bonuses are lost. The head is a comparatively small, moving target and can only be hit when an opponent makes a called shot and even then, the attacker is -1 to strike.



68

\*\*\* Depleting the M.D.C. of the main body will shut the bot down completely, making it useless.

**Speed:**

Running: 80 mph (128.7 km) maximum.

Flying: Not possible.

**Statistical Data:**

Height: 28 feet, 9 inches (8.8 m; about a third smaller than the original dinosaur whose average height was 46 feet/14 m).

Width: 16 feet, 4 inches (5.0 m) from shoulder to shoulder.

Length: 40 feet (12.2 m) from head to tail tip.

Weight: 30 tons (27210 kg)

Physical Strength: Equal to a P.S. 60

Cargo: Minimal storage space; about four feet (1.2 m) for extra

clothing, weapons, and personal items. Plus, a weapons locker with room for two energy rifles, two energy pistols, two canteens and enough rations for two weeks.

Power System: Nuclear; average energy life is 20 years.

Market Cost: 100 million credits. Sold only to Splugorth allies, never on the open market.

**Weapon Systems**

**1. Shoulder Medium-Range Missile Launchers (2):** This is an oversized version of the Raptors and Allosaurus' hidden missile launchers. The sixteen medium range missiles give the Tyrannosaurus the capability to conduct long-range bombardment.

Primary Purpose: Anti-Armor

Secondary Purpose: Anti-Aircraft

Mega-Damage: Varies with missile type. Usually outfitted with plasma missiles (2D6X10 M.D.)

Rate of Fire: One at a time or volleys of two, four, eight, or sixteen missiles.

Effective Range: About 40 miles (64 km).

Payload: Sixteen, eight missiles per launcher.

**2. Concealed Mini-Missile Launchers (2):** A mini-missile launcher is concealed on each side and back area of the tyrannosaurus robot. The launch tubes appear as small circular plates or hatches along the sides of the body toward the back.

Primary Purpose: Anti-Robot, Anti-Aircraft.

Secondary Purpose: Defense.

Mega-Damage: Varies with mini-missile type. Standard load is plasma missiles (1D6X10 M.D.).

Rate of Fire: One at a time or volleys of two, four, six, eight or twelve missiles.

Effective Range: About one mile (1.6 km).

Payload: 48; 24 per each mini-missile launcher.

**3. Twin-Barrel Pulse Cannons (2):** Mounted on the shoulders and behind the tiny arms are a pair of high-powered laser pulse cannons. These double-barreled weapons have amazing range and firepower. Each can rotate 360 degrees in all directions.

Primary Purpose: Assault

Secondary Purpose: Defense

Mega-Damage: 5D6 M.D. per single pulse from one barrel or 1D6X10 M.D. per dual blasts from one cannon. Both cannons can simultaneously fire at the same target to inflict 1D6X10 M.D. or a maximum of 2D6X10 M.D. (all four barrels fired at once). A double barrel or quadruple barrel simultaneous blast counts as one melee action.

Rate of Fire: Equal to the number of hand to hand attacks of the pilot or gunner (usually 3-6). Maximum six blasts per melee.

Effective Range: 6000 feet (1830 m)

Payload: Effectively unlimited.

**4. Belly Rail Gun:** A belly-mounted turret holds a tri-barrel rail gun that is used for close combat and to counter enemy ground troops.

Primary Purpose: Anti-Personnel

Secondary Purpose: Defense

Mega-Damage: A burst is 40 rounds and inflicts 1D6X10 M.D.; can only fire bursts.

Rate of Fire: Can fire up to six bursts per melee round (each counts as one melee attack).

Effective Range: 4000 feet (1220 m)

Payload: 4000 round drum, that's 100 bursts. If a second drum is added it feeds immediately after the first drum is exhausted. Re-loading a drum will take about five minutes, even for those trained in its use, and a strength of 26 or higher is required.

**5. Head Laser Cannon (2):** Each eye is a powerful laser cannon. The pilot usually controls this weapon.

Primary Purpose: Assault.

Secondary Purpose: Defense.

Mega-Damage: 1D4X10 M.D. per single blast, or 2D4X10 M.D. for a dual laser blast (counts as two attacks).

Rate of Fire: Equal to the number of hand to hand attacks of the pilot or gunner (usually 3 to 6).

Effective Range: 4000 feet (1220 m)

Payload: Effectively unlimited.

**6. Hand to Hand Combat:** Rather than use a weapon, the pilot can engage in mega-damage hand to hand warfare. The arms are tiny and ineffectual for hand to hand combat, but can be used for punching, ripping and tearing at point-blank range; arms' reach is about six feet (1.8 m). Instead, the pilot uses the legs to kick, the tail to hit and the giant maw to bite.

Damage:

Restrained Punch: 1D6 M.D.

Full Strength Punch/Tear/Rip: 5D6 M.D. (limited to extremely close range only)

Power Punch: None

Kick: 1D6X10

Leap Kick: None

Tail Strike: 1D4X10 M.D.; 25 foot (7.6 m) reach

Head Butt: 3D6 M.D.

Bite: 1D6X10+10 M.D.

Body Ram (short running start): 1D6X10 M.D. and has a 75% chance of knocking a truck-sized opponent over or down; 95% for man-size to 15 feet (4.6 m) tall opponents, motorcycles, and small cars. Victim loses initiative, one melee attack and is knocked back 2D6 yards/meters (X10 for human-sized targets who also lose two melee attacks/actions). Counts as two melee attacks.

Stomp: 4D6 M.D. (only against opponents 10 feet/3.0 m tall or shorter).

Hand to Hand Combat Bonuses: One additional attack per melee at levels one and seven, +2 to strike and parry, and +1 to dodge. All bonuses are in addition to hand to hand skill and attribute bonuses.

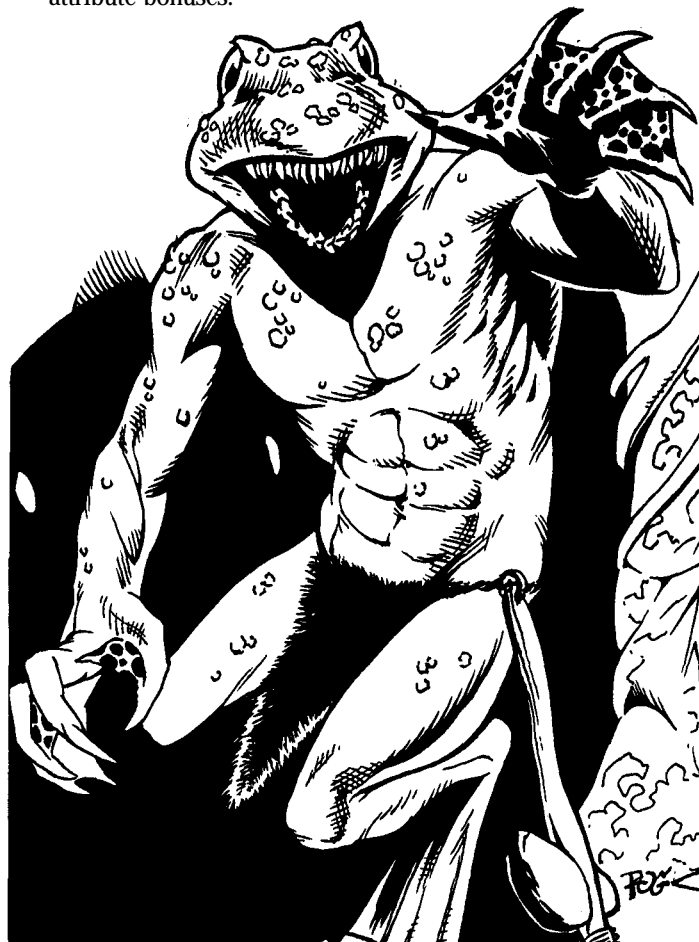

# El Dorado

## The Cities of Gold

When Spanish conquerors first reached South America, they came in search of gold and quick riches. They heard tales of mythical cities of gold. Places where the rulers swam in a lake as servants threw precious metals into the waters. Of men who covered their bodies in gold powder and lived in gilded cities paved with precious stones. These cities were said to exist somewhere in the depths of the jungle. Dozens of Spanish, German and English expeditions set out into the Amazonian rain forest looking for the mythical El Dorado. Every tribesmen they met claimed that the Gilded City, El Dorado, was further away. Disease, wild animals and ferocious natives forced each expedition to turn back. Some never returned. Those that did came back empty-handed. Eventually, scholars decided that the so-called City of Gold was but a myth, concocted by the natives to lure the greedy Europeans out of their lands.

The truth was something that no European (or even most natives) would suspect. There had once been three cities hidden in the Amazon jungle. The oldest and wealthiest had been founded by True **Atlantean** refugees long before the arrival of Europeans, but the entire city had been transported to a **transdimensional** limbo where it remained hidden for centuries. The second had been the home of the werejaguar race, led by the widely worshipped South American Jaguar god. That city had always existed in an alternate dimension, communicating with Earth through dimensional Rifts. The third city was one of the largest transdimensional markets on the planet, ruled by a supernatural intelligence. With the Coming of the Rifts, the three cities have returned to Earth, this time permanently! The Cities of El Dorado exist in different areas of the mainland Amazon rain forest where they are growing increasingly violent toward each other.

The legendary cities are currently known as **Manoa**, **Omagua** and **Cibola**. Each is a major power and their domains have the largest population concentration in the Amazon basin. Furthermore, each has a level of mystic knowledge or technology that rivals that of any other nation on the planet. Their influence may someday reach the rest of the American continent and the consequences of the three cities' rivalry may be felt around the world.

**Note:** The three cities described below may not be the only places that inspired the legends of El Dorado. **Pre-rifts** Earth was a place that occasionally brushed with extra-dimensional realms from many strange places. Who knows what other strange worlds and peoples were encountered by explorers and Amazonian Indians in the past? Game Masters are welcome to explore these and other possibilities. South America is a huge continent, sparsely populated, and has more than enough room for other exotic places and lost empires.

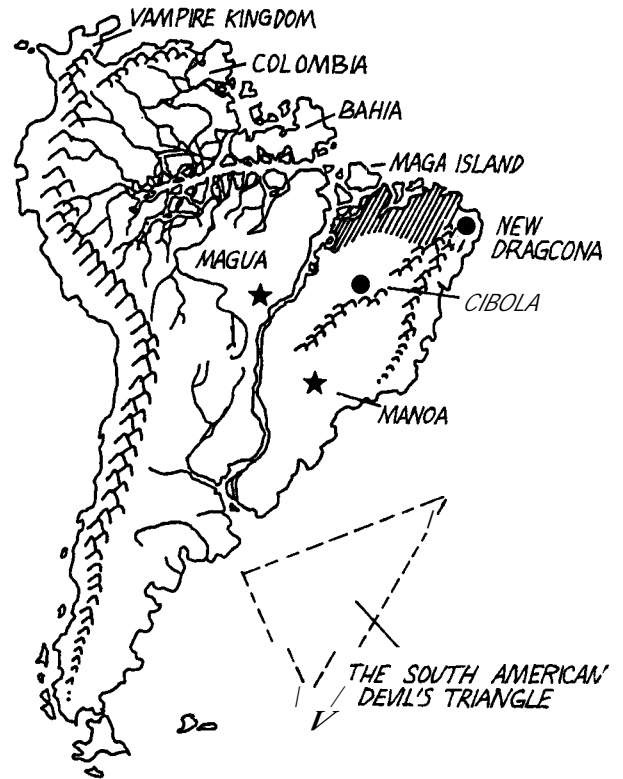

## Manoa

**Population Breakdown:** 2 million total

True Atlanteans: 50,000

Humans: 500,000

Amazons: 400,000

Ewaipanoma Headless People: 400,000

Shaydor **Spherians** (free colony): 300,000

Lizard Men (refugees from **Lagarto**): 140,000

Other D-Bees and supernatural creatures: 200,000 including 1D4X100 dragons (a third are **Chiang-Ku**), some godlings and demigods and a few good or selfish supernatural monsters.

There are no slaves in Manoa, but it has 5D6X1,000 visitors at any given time.

## History

This city was the original El Dorado and the landmark that inspired most of the legends about the gilded city. Shortly before the first Europeans arrived in the New World, the city was removed and transported to another dimension. The city was originally founded by a handful of Atlanteans from Clan Skellian. The Atlanteans were fleeing the destruction of their continent, but had decided to remain on their home planet. The Amazon's rich network of ley lines allowed the Atlanteans to endure the depletion of magic energy for centuries longer than anywhere else in the world. So they prospered while their brothers and sister abandoned the planet and went into voluntary exile in other dimensions (for more information about the other Atlantean Clans, see **Rifts Atlantis**).

A few Atlanteans stayed near the coast where they influenced the Indian cultures of those lands. Most Atlanteans traveled deep into the inland jungle, away from other human civilizations.

They founded their new home in an isolated valley in the heart of the rain forest. The only other dwellers of the valley were a small **indian** tribe on the verge of extinction. Years before, a plague had wiped out most of the male population. The women learned to fulfill all the roles of the tribe, including fishing, hunting and combat. Enemy tribes tried to capture these "defenseless" women only to find that the female warriors were as fierce as any man and more courageous than most. Several tribes decided to join forces to teach these "upstarts" not to usurp the **males'** traditional roles. The fledgling tribe was grimly preparing for a fight to the death when the Atlanteans arrived and disrupted the war.

The women's courage struck a chord with the newcomers, so they joined the women's fight. The Atlanteans used their advanced bio-wizardry and a spiritual ceremony involving the spirit protectors of the tribe to endow all the females with superhuman powers. The few surviving males were left unchanged. The grateful tribe and **Atlantean** refugees would live in harmony and join forces to create a new home. Together they built the city of **Manoa**. There were less than a hundred Atlanteans, but they used their powers over stone to build a **fabulous** city of gold and marble, while the women of the indigenous tribe became its superhuman protectors. The other tribes soon learned to stay away from the magical city and its ferocious female warriors.

The people of Manoa would never forget their Atlantean heritage, but would call themselves **Manoans** and build a prosperous new life. Stories about Manoa, The City of Gold, were told among the surrounding tribes and spread throughout the continent. The tales would later become legendary and persist long after the fabled city would disappear from the face of the planet.

Years later, the Manoans rescued a band of **transdimensional** refugees who were in danger of being exterminated by humans who thought they were demons. The **Ewaipanomas** were an alien race that had lived in the deepest reaches of the Amazon rain forest for centuries. They had successfully avoided contact with humans for decades, but were eventually discovered and savagely attacked. A handful of survivors stumbled across Manoa where the tolerant Atlanteans and warrior women, both outcasts themselves, welcomed them with open arms. The alliance between the warrior women, Atlanteans and Ewaipanomas kept the city safe from outsiders but only added to tales of magic, demons and treasure.

For thousands of years, Manoa grew and flourished. As time went by, however, the magical energies of the Earth continued to ebb. Buildings requiring powerful spells to stay erect began to crumble. It became more difficult to pierce the barriers separating Earth from other dimensions and the powers of both Atlanteans and the warrior women increasingly diminished. Even more threatening were the visions many **Manoan/Atlantean** prophets had of the future and two periods of destruction. They saw steel-bearing invaders who would destroy all the civilizations of the land and plunder every city, village or hut they could find. Worst, the seers caught a glimpse of a time when the Earth would be torn asunder and reshaped by incredible mystic forces. Few would survive either holocaust (the latter was the Great Cataclysm caused by the eruption of the ley lines to occur in the far flung future).

Armed only with a mere fragment of their technology and magic, the Manoans decided that staying on Earth would be too

costly. They had already fought too many hardships to give it all up. Like their fellow Atlanteans thousands of years before, the rulers of Manoa gathered the people together and, with all the mystic energy they could muster, opened one final Rift that took the entire city into a dimensional limbo where they could dwell in peace. The Manoans could not forsake their homeland entirely so they erected some mystical portals that would allow occasional trips back to Earth.

A decade later, the Spaniards came, but the city was gone, its former territory reclaimed by the rain forest and now only a memory in the minds of the natives. A few groups of Amazons who stayed behind fought the invaders, trying to block their expeditions down the mighty river that cut through the jungle. These battles became legendary. The Spanish were reminded of the Amazons of Greek mythology and the river was renamed **The Amazon** in their honor. As the Europeans expanded, the last remnants of the Amazon warriors escaped to Manoa via the dimensional portals. Later scholars could find no evidence of the female warriors and concluded that the "Amazons" were nothing but myth. The Spanish and other Europeans also heard stories of a city of gold and searched for it in vain. After centuries of failing to find the legendary city, **Manoa/El Dorado** became a historical footnote, a thing of fairy tales.

Manoa stayed in its **dimensional** pocket for over 500 years. The population of the Amazon warriors and human Manoans grew steadily. The city's overall population was increased by transdimensional emigrants, including a large number of Shaydor **Spherians** who were rescued from their **Splugorth** slave masters. The number of Atlanteans remained low, never rising above a few thousand. Many went away, leading the nomadic life style common to their kind.

## The Return of Manoa

The cataclysm that spawned the return of magic to the world was felt by the Manoans through their dimensional links to Earth. The **Atlanteans'** pyramids flared with the onrush of P.P.E. energy, and all sensitives and wizards felt the psychic eruption that ran through the world, shaking the fabric of the Megaverse. The return of the city to Earth was involuntary — the small dimensional gates linking the Manoans to Earth became full-fledged Rifts and the whole city was on the verge of being torn asunder by the dimensional maelstrom. Rather than fight the mystic energies, the rulers of Manoa hastily assembled a ritual that enabled them to safely return the city to its original resting place. Manoa reappeared shortly after the Great Cataclysm, appearing during the middle of a ley line storm and filling the valley it had once occupied.

At first, the local natives were terrified by the city's sudden appearance. Over the next few years, however, the **Manoans/Atlanteans** became known as healers and teachers. Some were scared by the Amazons and Ewaipanomas, but eventually came to accept them. Although most Indians are nomads and do not enjoy cities, a few were attracted by the beauty of Manoa and the gentle hospitality of its people. Many have since become citizens. Thousands of D-Bees stranded in the Amazon found refuge in the city. The Manoans (True Atlanteans included) are glad to be home.





## Clan Skellian

Most of the Atlanteans that built Manoa came from clan Skellian. The Skellian were well-respected in the old days when Atlantis was the jewel of the Megaverse and were known for their work as stone masters, artists, magicians and philosophers. Among other things, they were said to have close ties with several ancient Chiang-Ku dragons and were considered to be the foremost masters of Tattoo Magic. Clan leader, Temarkhos the Tenth, headed the opposition to the experiment that led to the ancient disaster that removed Atlantis from the planet (for more details, see **Rifts Atlantis**). His words were not heeded however, and the disaster he had predicted was even worse than he had imagined. Through magic, Temarkhos lived for over four thousand years, and saw the full consequences of the failed experiment. He sent most of his clan to other dimensions, but he and one hundred select Atlanteans stayed and made their way to South America. After Manoa was founded, the Atlantean population grew slowly over the centuries, so that by the time the city left the Earth, there were about 2,000 Atlanteans within its walls.

When Manoa returned to the Amazon Jungle, the new Lord Skellian sent agents through the dimensions to find the other clan members and convince them to return to Earth. Many heeded the call and by 100 P.A. most clan members had resettled in Manoa. As a result, Manoa has the largest Atlantean community on the planet and one of the largest in the Megaverse. So far, the city has made no impact on the rest of the world and has remained a secret — the Atlanteans/Manoans are too busy engaged in conflicts with their immediate neighbors to deal with crises elsewhere. Eventually, Manoa will turn its full attention to helping the people of Earth survive their tribulations.

Clan Skellian is fully dedicated to the restoration of Earth and its defense against supernatural intelligences, gods and demons who may try to exploit or conquer the world. The Manoans hope to one day reclaim Atlantis from the Splugorth and perhaps restore the continent to its former glory. Since the Skellians were not directly responsible for the cataclysm that destroyed Atlantis, the clan is not as guilt-ridden as most True Atlanteans, and are more willing to take the reins of power if it should become necessary. Over the millennia, Clan Skellian has continued to work with the Chiang-Ku dragons and have developed a whole new category of magic tattoo: Monster-shaping Tattoos and a new type of Tattooed Man, the Atlantean Monster Hunter.

Most other True Atlanteans are not aware of the rise of Manoa. Many have noticed the gradual disappearance of clan members from other places in the Megaverse, but only two other clans have been trusted with the destination of their migration. As a result, most Atlanteans are suspicious of the Skellians, placing them in the same category as the Aerihsan clan (see **Rifts Atlantis**). Also, there are rumors that the members of Clan Skellian consort with inhuman monsters or that they transform themselves into monsters. These rumors only add to the distrust felt for this clan.

## City Highlights

The city is located right in the middle of the jungle. Travelers will suddenly come to a huge clearing where a mighty city stands. Manoa fills up the entire valley and then some. The tree line has been cleared (the trees were transplanted, not chopped down) and pushed back about 500 yards/meters from the hills.

At first sight, only the top of the main pyramid and the tallest buildings and towers can be seen behind the imposing white and gold walls. A small tributary of the Amazon river runs through the kingdom, providing most of the fresh water.

Most buildings use Greek-Roman style architecture, with rows of columns supporting triangular roofs, open courtyards in the middle of most houses, and numerous mosaics and wall paintings. Statues of historical and mythological figures are common in public places, such as city parks, pavilions and gathering spots. It is said that some of these statues can be animated through stone and rune magic and will fight for the city in an emergency.

**The City Walls:** Manoa is surrounded by a continuous wall made of a white stone similar to marble with golden hues. Runes and circles of power are inscribed on the walls, protecting them against magical and physical attacks. To this day, no known force has been able to breach the walls; conventional attacks simply bounce off without leaving so much as a scratch on the wall's polished finish. Magical attacks have fared no better.

In an emergency, the full energy of the city's pyramids can be used to activate a magical force field that covers the entire city and can be maintained for a full week (at the end of the week, the ley line energies of the area will be exhausted for a full week). This force field can withstand 500,000 M.D. before collapsing. While engaged, the field does not interfere with counterattacks coming from within the city. No army in South America has the **firepower** to take the city by storm; only the **Splugorth** (and possibly the Coalition or the **NGR**) would be able to amass a large enough army to do the job and Manoa is far enough away from those places to be safe from them.

**The Four Gates:** These four portals are the main entrances to the city. Each gate stands one hundred feet (30.5 m) tall and fifty feet (15.2 m) wide. The entrances are blocked by swinging double doors of a nearly indestructible golden alloy (the doors have 10,000 M.D.C. each). Only one gate is usually opened at any one time. A platoon of 20 robots and 40 Amazon warriors are stationed at the open gate and visitors must identify themselves and explain their business in Manoa to them. Pistols and other small hand weapons are allowed within the city limits; anything heavier must be checked in at the gate until the visitors' leave.

**The City Streets:** The streets are paved with marble blocks covered with golden inlays and encrusted with gems. The texture of the marble streets is smooth but not slippery, enchanted to act both as a thing of beauty and a very functional road and sidewalk.

The gems are enchanted through stone magic to produce a variety of magical effects — mostly in defense of the city. People trying to carve them out will activate a magical alarm and cause a backlash of mystic energy that inflicts **1D4X10M.D.** to a 10 foot (3.0 m) area centered on the thief! Trying to neutralize the enchantment through Negate Magic or similar spells will also activate an alarm located in the surrounding area. Visitors quickly learn that trying to steal from Manoa is not only foolish but suicidal.

The width of the streets range from 20 yards/meters for the main avenues to five yards/meters for the side streets, usable only by pedestrians. Next to the main avenues are golden strips that serve as moving sidewalks. Each is about two yards wide and move at a steady **8 mph** (12 km). The strips are the city's

public transportation system used by most pedestrians. The main streets are used by **techno-wizard** and conventional vehicles, as well as many **animal-drawn** carts and wagons used by the more primitive village people who live around the city.

**The Market Square:** Near the center of the city is a market area attended by sellers of produce, artisans, and all kinds of merchants. **Manoa's** market is nowhere near as impressive as the ones in **Splynn** or **Cibola**, but buyers can find a good assortment of fine clothing, equipment, food, drink, magical items, and exotic articles.

**The Pyramids:** The city has five pyramids. Each is placed on top of the nexus points located within the city's borders. Four of them are relatively small, averaging 200 feet (61.0 m) in height. The fifth one, located in the center of the city, is 800 feet (244 m) tall and towers above all other structures in Manoa. All the pyramids are very well guarded by over a hundred **Atlantean** warriors and magicians and two hundred Amazon and **D-bee** soldiers. Access is restricted and can be granted only by the Lord Protector or the Council of Wisdom. The pyramids are used for transportation of troops, government officials and mages around the sprawling city and are also connected to several dozen dimensions, most of which are dominated or populated by **Atlanteans**.

## Law & Government

Manoa is ruled by a Lord Protector, an inherited position that has been held by only four people (**Atlanteans** live for centuries, after all).

Lord **Temarkhos**, is the Fourth and current Protector.

The Lord Protector receives advice from the **Council of Wisdom**, made up of the wisest and most experienced Atlanteans, Amazons, humans and D-Bees. All council members are men and women 50-300 years old, depending on their race, and are experienced in the fields of politics, management, science, or magic **and/or** war. This simple government has worked admirably well for over a thousand years.

Administrative duties are handled by the **Civil Service**, a group of bureaucrats that deal with such details as tax-collecting, public services and other boring but important parts of the government. A large number of Civil Servants are Shaydor **Spherians** who perform their duties with fairness and efficiency. Despite this, the Civil Service is disliked by many people. After all, they are tax collectors.

Justice is managed by the **Security Bureau**, which acts as both police and judicial system. Most of the higher positions in the Bureau are occupied by Atlanteans. Although this system has the potential to be abused, so far it has worked well. Complaints against the Security Bureau's judgments are usually brought to the Council of Wisdom. The Lord Protector can also grant pardons under special circumstances.

Punishments for crimes rarely include imprisonment. Community service and restitution (to undo or repair the damage done) is the most common penalty, followed by fines. Terrible crimes call for exile and for such acts as murder in the first degree, treason and arson, the penalty is death. Manoa has the lowest crime rate on the continent.

## Society

Manoa is an unusual **Atlantean** city in many ways. The large percentage of D-bees in the city and the high positions they can reach in government and all walks of life, goes against the unspoken beliefs of racial superiority held by many True Atlantean clans. Most True Atlanteans view themselves as the defenders of all mortal races in the Megaverse. That means that the other races are like children who need guidance and protection and one does not share power with children. The **Skellian** Clan has never ascribed to this belief and tries to accept other life forms as true equals. Other Atlantean clans believe they are wrong to share so much power and knowledge, especially with aliens like the Ewaipanoma and Shaydor. These issues are never debated publicly where **non-Atlanteans** might overhear (they don't want to offend), but those are the sentiments held by many outside of Manoa.

Even within Clan Skellian there are factions less tolerant than others. The problem arises with contradictory lessons taught to young Atlanteans even at Manoa. On the one hand, they grow up with several other races who are generally regarded as equals. Many become life-long friends, lovers, and leaders. On the other hand, many **Manoan** Atlanteans are still taught that they have a duty to protect these and all races, because the Atlantean people are an older, wiser and more powerful species. In the course of normal life and among the Council of Wisdom, the words and ideas of **non-Atlanteans** are sometimes ignored or subtly ridiculed. This causes a slight undercurrent of tension that occasionally flares into nasty situations. For the most part, however, **Manoans** of all races get along very well, with little of the distrust or outright hatred that scars so many communities on Rifts Earth.

## Foreign Relations

So far, Manoa has only dealt with their immediate neighbors, but they have sent scouts and explorers throughout the world. They have acquired fairly detailed knowledge of every major kingdom and nation throughout the **Americas**, Europe and Africa, including the Coalition States, The NGR and the **Splugorth** of Atlantis.

Manoa finds the people of **Columbia**, **Bahia** and **Maga** share similar views of the world and are likely candidates for trade and alliances. However, no formal relations have been instigated with any of them.

**The Kingdom of Lagarto:** The Manoans view the rise of **Lagarto** as a potential threat. Already, **search-and-destroy** patrols from Lagarto have wandered into areas controlled by Manoa, resulting in violent skirmishes. At this point, the **Lagartoans** are considered to be allies of the Splugorth and therefore, enemies of Manoa and all True Atlanteans. Several Undead Slayers and other Manoan champions have gone into lizard man territory to conduct reconnaissance, support the rebel movement and to help fleeing refugees. Although Manoa is a good distance south of Lagarto, the Manoans are not going to sit back and let the Splugorth or their minions get a stranglehold on South America. Sooner or later, they will become actively involved in the war against Lagarto — probably sooner.

**Omagua:** The first contact with Jaguar City came when a Manoan patrol was tricked by **Cibolans** into fighting the felines.

That incident led to many years of fighting and distrust. The **Manoans** have learned that "gods" rule Omagua and are concerned that these powerful entities will try to seize control of South America. This suspicion has interfered with efforts to establish peace with Omagua. For the last decade, there has been an uneasy truce between the two, broken by sporadic fighting.

**Cibola:** Manoa and **Cibola** are locked in war. The Manoans know that a supernatural intelligence controls the city. They abhor the slave trade and raids conducted by the Cibolans. Manoan patrols of Amazons, Monster Hunters and other warriors ruthlessly destroy any **Cibolan** raiders they encounter and rescue slaves and prisoners from their clutches whenever they can.

**The Splugorth of Atlantis:** Splugorth minions that venture into Manoan controlled areas are attacked on sight. Lord **Te-markhos** has gathered a lot of information about Atlantis and hopes to free his ancestral homeland one day in the future. For now, he is concerned with preserving Manoa and freeing South America (starting with Lagarto) from the **Splugorth's** corrupting influence.



## Armed Forces

All able-bodied Manoan citizens must serve in the military for a minimum of two years. As a result, 70% of all Manoan adults have the following military skills:

Hand to Hand: Basic

One modern W.P. (usually Energy Rifle, but may vary with the race and aptitude of the character).

One archaic W.P.

## Typical Manoan Patrols

The Manoans rarely use large armies, preferring small, maneuverable units, ideal for jungle warfare.

### Border Patrol

- 4 Amazon Warriors
- 4 human Wilderness Scouts
- 4 Shaydor Spherian Warriors
- 4 Atlantean warriors in Hoplite Power Armor

### Search and Destroy Patrol

- 2-4 Amazon Warriors
- 2-4 Shaydor Spherians
- 1 Atlantean Undead Slayer or Monster Hunter
- 2-4 Atlantean warriors in Hoplite Power Armor
- 2 Atlantean warriors in Lictor Power Armor

# Weapons of Manoa

Manoa relies heavily on magic and **techno-wizardry**. All the TW weapons described in the **Rifts RPG**, **Rifts Vampire Kingdoms** and other titles, can be found at Manoa. Additionally, the Atlanteans have developed techno-wizardry items that are beyond the abilities of any civilization known on Earth, with the exception of the **Splugorth**. Among other things, the Manoans have developed a number of TW weapons and vehicles that can be used by normal humans! These weapons need to be recharged at pyramids or by a **techno-wizard**, but they can be issued by soldiers whether they have mystic or psionic powers or not.

Among other things, the Manoans have developed a **TW-energy cell** that can be recharged with pyramid **energy!** Spent cells magically recharge after being placed in a stone pyramid for a half hour or by being invested with 40 P.P.E. points. The Five Pyramids of Manoa have huge chambers for recharging energy clips. In Manoa, these cells cost roughly the same as a normal E-clip, but they will not power normal energy weapons or techno-wizard devices other than the ones designed for their use.

The Manoan "factories" that make these wondrous machines are located in large **pyramids** that use enormous amounts of P.P.E. to produce the desired results. Expert craftsmen and practitioners of magic add the final touches and details. It would take enormous resources and decades (even centuries) of research to match these accomplishments. **Note:** This process uses the skills of both stone masters (see **Rifts Atlantis**) and techno-wizards using a very advanced form of magic. Normal techno-wizards (and yes, that means player characters and other True Atlanteans) will be *unable* to replicate the process.

## Enchanted Armor

The armorers and alchemists of Manoa manufacture several suits of enchanted chain mail, plate, and segmented plate armor both for sale and for use by the Armed Forces.

The disadvantage of these suits is that it requires the services of a techno-wizard or an alchemist to repair any damage. This is no problem in Manoa, but it can be difficult to find repairmen in other parts of the world. **Magic armor repairs** in Manoa typically cost 300 to 400 credits per every M.D.C. point of armor restored, up to the maximum of the suit.

One of the advantages is that the material is uncharacteristically light and comfortable for a full suit of heavy armor; most weigh around 25 pounds (11 kg).

**Chain Mail:** 75 M.D.C., -5% prowl penalty. 35,000 credits.

**Segmented Plate:** 85 M.D.C., -10% prowl penalty. 45,000 credits.

**Plate Armor:** 100 M.D.C., -15% prowl penalty. 60,000 credits.



## Manoan "Flamer" Pistol

This stylized gun looks almost like a 16th-century **wheellock** pistol (the Manoan craftsmen who make them prefer a baroque design). It fires the equivalent of mini-fireballs (as per the **wallock** spell), but has greater range. This gun is the standard sidearm of the Manoan Armed Forces, and is popular among local adventurers, wilderness scouts, guardsmen, and Amazons.

Weight: 2 lbs (0.9 kg)

Mega-Damage: 3D6 M.D. per blast.

Rate of Fire: Equal to the number of hand to hand attacks per melee; this is not an automatic weapon.

Effective Range: 600 feet (183 m)

Payload: 12 shots per TW-Cell

Cost: 10,000 credits in Manoa; rarely found elsewhere.

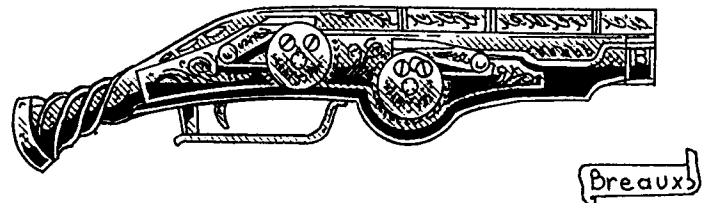

## Manoan SK Stun Gun

This TW pistol has two settings: **stun** and **kill**. The **Stun** setting actually casts a long-range version of the **agony** spell (see **Rifts RPG**, page 177)! The **"kill"** setting fires a magic lightning bolt. The bolt originates from the gun's barrel. The shooter must aim to strike but the bolt is +3 to strike.

The weapon is standard issue among the Manoan Internal Security Forces. It is very useful in subduing mortal criminals without killing them and ideal for engaging a variety of dangerous supernatural enemies.

Weight: 3 lbs (1.4 kg)

Mega-Damage: **Stun:** A blast is equal to the effects of the **Agony** spell. **Save vs magic:** 14 or better is needed to save.

**Lightning Bolt:** 5D6 M.D.

Rate of Fire: Equal to the number of hand to hand attacks per melee.

Effective Range: 600 feet (183 m) on the **kill** setting and 100 feet (30.5 m) on the **stun** setting.

Payload: 8 shots of either setting per E-Cell.

Cost: 15,000 credits

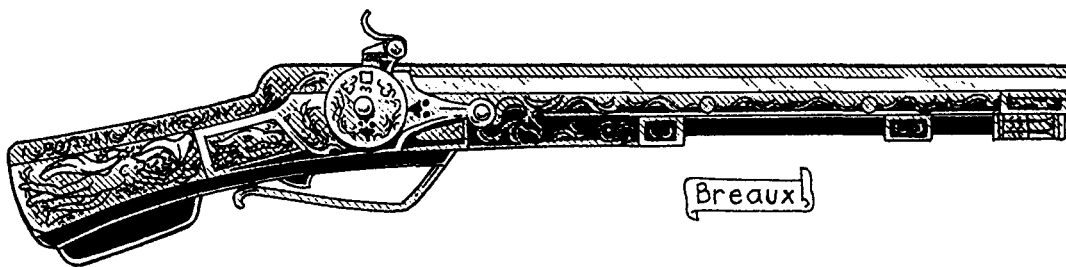

## Manoan "Fireball" Rifle

This weapon also has an archaic look and is very ornate, usually with a gold sheen to it. It fires a slightly more powerful fireball than the pistol and has greater range and energy capacity. Most Amazon warriors are issued this rifle.

Weight: 6 lbs (2.7 kg).

Mega-Damage: 4D6+6 per blast.

Rate of Fire: Equal to the number of hand to hand attacks per melee.

Effective Range: 1600 feet (488 m)

Payload: 24 shots with a TW-Cell

Cost: 20,000 credits.

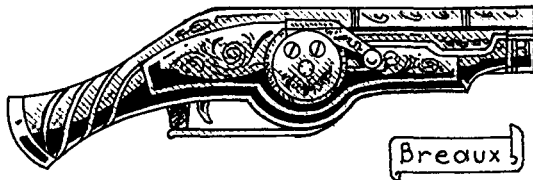

## Manoan Stun Pistol

A non-lethal version of the SK stun gun that only has the stun setting is available to the public. It is very popular for self-defense among storekeepers, bouncers, and other people who prefer not to use lethal force. However, using a stun pistol without provocation is a serious offense in **Manoa**, punishable with a large fine, confiscation of the gun and (in the case of visitors) outright expulsion from the city! The pistol looks similar, but not identical to the SK gun and is a bit smaller.

Weight: 2.5 lbs (1.2 kg).

Mega-Damage: A blast is equal to the effects of the Agony spell (save vs magic of 13 or higher applies).

Rate of Fire: Equal to the number of hand to hand attacks per melee.

Effective Range: 50 feet (15.2 m)

Payload: 8 shots per E-Cell.

Cost: 8,000

## Hoplite Power Armor

By C.J. Carella & Kevin Siembieda

This power armor suit looks like a giant, metal, Greek warrior clad in Spartan Hoplite armor complete with a metallic cuirass, leg plates and crested helmet. An oblong shield and an energy spear are standard issue with the armor.

This highly advanced **techno-wizard** device uses a variation of the Golem spell and other secret combinations of spells to animate and command the metal shell. The pilot steps inside the armor as he would any high-tech power armor! The golemish suit automatically responds by closing snugly around the human-

oid, encasing him or her inside its metal skin. The fit is tight but comfortable. The outer skin of the magic power armor provides the character with magically augmented strength, speed, and senses, in addition to mega-damage protection.

The armor's magical "accessories" make it the equal of most normal suits of armor, with the equivalent of the sensor and communication systems available to most standard high-tech power armor. Unlike nuclear powered suits, the Hoplite armor needs to be recharged at a stone pyramid or ley line after 96 hours of continual use (roughly every four or five days). 24 hours' worth of energy is recharged within one hour's time, so four hours will put the armor back to maximum power. It takes three times as long to recharge at a ley line or nexus. In both cases, there are no special ritual, procedures or technician required; simply place the armor inside a stone pyramid or on a ley line and it will automatically recharge. Furthermore, all damage incurred by the armor is magically repaired at a rate of 75 points per hour at a pyramid or 37 points per hour at a ley line. However, the suit is beyond repair if the main body M.D.C. has been completely depleted.

The Hoplite and its larger cousin, the Lictor robot, are the largest war machines employed by Manoa.

**Model Type:** M-100 Hoplite

**Class:** Techno-Wizard Armored Assault Suit

**Crew:** One, usually a human or True Atlantean, occasionally an Amazon.

**M.D.C. by Location:**

Shield — 100

Arms (2) — 120 each

Hands (2) — 50 each

Legs (2) — 140 each

Spear — 120

\* Head — 80

\*\* Main Body — 300

Armor of Ithan Force Field — 100

\* Destroying the head of the power armor will eliminate all forms of optical enhancement and sensory systems. The pilot is forced to rely on his own human vision and senses. Furthermore, all power armor combat bonuses to strike, parry and dodge are lost! The head can only be hit when a character makes a called shot and even then, the attacker is -3 to strike.  
\*\*Destroying the main body renders the suit useless and the shield and spear lose their energy.

**Speed:**

**Running:** 60 mph (96 km) maximum. Note that the act of running does tire out its operator, but at 20% the usual fatigue rate.

**Leaps:** 20 feet (6 m) lengthwise and 12 feet (3.6 m) high.

**Swimming:** 5 mph (8 km)

**Flying:** Not available in standard models.

**Statistical Data:**

Height: 9 feet (2.7 m) from feet to the crest of the helmet.

Width: 4 feet (1.2 m)

Length: 3 feet (0.9 m)

Weight: 600 lbs (270 kg).

Physical Strength: Equal to a supernatural P.S. 26!

Standard Tech Power Armor Features: All, including radar, radio communications, air purification, etc.

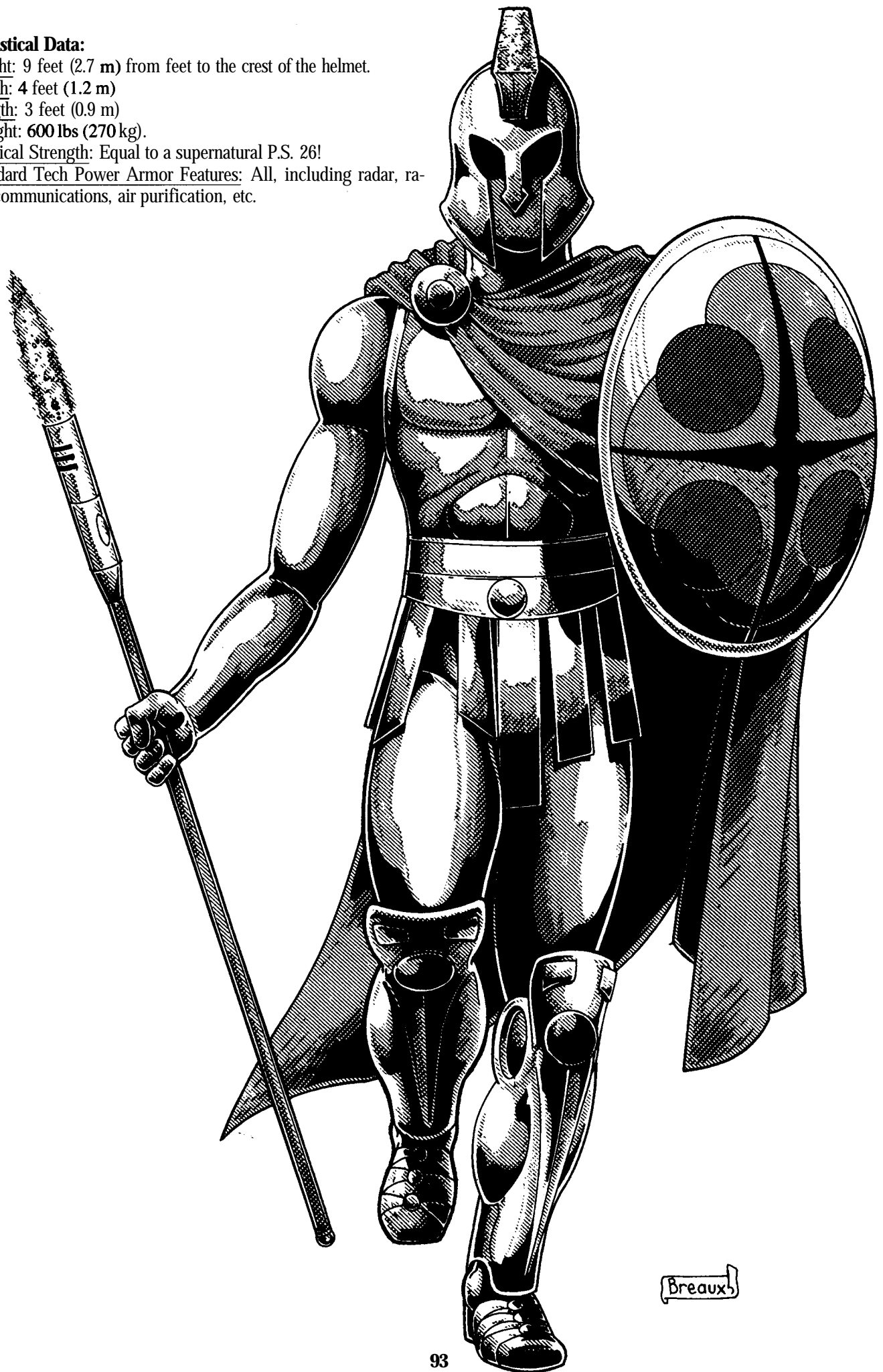

Standard Magic Features Include: Language translator (tongues spell), additional environmental systems (breathe without air and impervious to normal fire) and force field (armor of **Ithan**).

Cargo: None; although belts and pouches can be worn and carried.

Power System: Magical; 96 hours of continued use. Afterwards, it must be recharged at a pyramid (takes four hours) or at a ley line (takes eight hours).

Market Cost: 60 million credits.

## Weapon Systems

The following weapons and features are standard to most Hoplite power armor. Many suits, especially among officers, Amazons and heroes, have been further modified with additional **techno-wizard** enhancements or weapon options (Game Master's choice, but use your discretion. M.D.C. cannot be further increased by any means). Also note the P.S. and other features listed under the speed and statistical data above.

**1. Energy Spear:** This is an enchanted, mega-damage spear capable of firing energy bolts. The spear can also be used in hand to hand combat, in which case it is surrounded by an energy force field, inflicts mega-damage and can be thrown a greater distance than a normal spear.

Primary Purpose: Anti-Armor

Secondary Purpose: Anti-Personnel

Mega-Damage: Long-range energy blast: 5D6 M.D.

Hand to Hand: Energized spear strike: 6D6 M.D.; non-energized spear strike: 3D6 M.D.

Rate of Fire: Each energy blast counts as a melee **action/attack**; point and shoot.

Effective Range: Energy Bolt: 1000 feet (305 m). Thrown: 300 feet (91.5 m).

Payload: Effectively unlimited while the power armor is activated.

Bonuses: +1 to strike and parry in hand to hand combat, +2 to strike when thrown.

**2. Shield:** The Hoplite's shield is enchanted to emit a powerful shock wave attack that inflicts damage and has a chance of knocking an opponent off his feet (modified wind rush). The shield also works perfectly as a defensive or bashing weapon.

Primary Purpose: Anti-Personnel

Secondary Purpose: Defense

Mega-Damage: The shock wave does 2D6 M.D. and has a 75% chance of knocking a man-sized or smaller target off his feet. Reduced to 60% for a target 9 feet (2.7 m) tall and 35% for a target 10 or 11 feet (3.0 to 3.3 m) tall. Larger opponents cannot be toppled. If knocked down, the opponent loses one melee **action/attack** and initiative. A shield bash does 2D6+6 M.D.

Rate of Fire: Each shock wave blast counts as a melee **action/attack**; point and shoot.

Effective Range: Shock wave blast: 300 feet (91.5 m)

Payload: Effectively unlimited; recharged when the power armor is recharged.

Bonuses: +2 to parry, +1 to strike with shield or shock wave.

**3. Light Amplification System:** Laser-like beams are emitted from the eyes. At the lowest setting they function as searchlights with a 300 foot (91.5 m) range. At the two higher settings they are lasers.

Primary Purpose: Anti-Personnel

Secondary Purpose: Defense

Mega-Damage: Three settings: Light beam (no damage), 6D6 S.D.C. or 3D6 M.D. lasers.

Rate of Fire: Each laser blast counts as a melee **action/attack**; look and shoot.

Effective Range: Laser blast: 1000 feet (305 m); light beam: 300 feet (91.5 m).

Payload: Effectively unlimited; recharged when the power armor is recharged.

Bonus: +1 to strike.

Magic Spells: The armor can also cast a globe of daylight and blinding flash spell three times each per 24 hour period. Each is equal to a sixth level spell.

**4. Hand to Hand Combat:** Rather than use a weapon, the pilot can engage in hand to hand combat. Inflicts 5D6 S.D.C. on a restrained punch, 3D6 M.D. on a full strength punch or kick and 6D6 M.D. on a power punch or leap kick (both count as two melee actions). Power Armor Combat Bonuses: One additional attack per melee round at levels one, five, and ten; +1 on initiative, +1 to strike and parry, +2 to dodge, +2 to pull punch, +2 to roll with impact.

**5. Energy Weapons:** The character may also use one or two conventional energy weapons, rail guns and equipment suitable for a 9 foot tall **humanoid**. Smaller man-sized items may be carried in sacks or backpacks for use when the pilot is outside his power armor.

**6. Some Commonly Available Optional Abilities:** As many as two additional items can be selected and added to the power armor of officers, heroes and members of elite combat squads. **And/or** these items and powers can be used as an alternative to replace any of those listed in numbers 1-3, above.

• **Shoulder or Forearm Spikes:** Each shoulder or forearm has six enchanted spikes that can fly out and stab an enemy and then return magically to the armor. The spikes can be destroyed, however, in which case they must be replaced by a **techno-wizard**. The spikes are often used to destroy incoming missiles, but such a tactic destroys the spikes (each spike has six M.D.C.).

Primary Purpose: Anti-Personnel

Secondary Purpose: Anti-Missile

Mega-Damage: 3D6 M.D. per spike.

Rate of Fire: One at a time or in volleys of two, four, eight and twelve. After hitting a target, the spikes magically return to the armor in one melee (15 seconds), unless they are destroyed.

Effective Range: 1000 feet (305 m)

Payload: Twelve

• **TW Magic Net:** A lightweight, man-sized net with small weights at the end of it, similar to the ones used by gladiators. Normally it is a mega-damage structure with 50 M.D.C. and can be used to ensnare and hold an opponent or animal, entangle weapons, or parry (+1 to strike, +2 to parry or entangle, inflicts 1D6 S.D.C. damage as weapon). Six times per 24 hour period it can be magically activated to work like the *magic net spell*, making it larger and more formidable. Equal to a sixth level spell.

• **TW Fire Gauntlets:** A pair of gauntlet style gloves with high-tech looking nobs and wires (each has 80 M.D.C.). They are magically empowered to function like mini-flamethrowers, shooting a stream of flame from each.

Primary Purpose: Anti-Personnel

Secondary Purpose: Defense

Mega-Damage: Three settings: 1D4X10 S.D.C., 3D6 M.D. or 5D6 M.D. per single blast, double the damage if both gauntlets are fired simultaneously at the same target.

Rate of Fire: Each blast counts as a melee **action/attack**. A simultaneous blast from each counts as one melee attack.

Effective Range: 300 feet (91.5 m)

Payload: Effectively unlimited; the gauntlets recharge when the power armor is recharged.

- **TW Ankh Mace:** A demon slaying weapon in the shape of the Egyptian Ankh — the symbol of life. The weapon is used as a club or mace and is a mega-damage item (has 100 M.D.C.). It can also fire a shock wave blast.

Primary Purpose: Anti-Undead and Zombies

Secondary Purpose: Defense

Mega-Damage: 1D6 M.D. to mortal opponents, but does 3D6 M.D. to vampires and all other types of undead, as well as animated dead, skeletons, mummies and zombies.

Rate of Fire: Each shock wave blast counts as a melee **action/attack**; point and shoot.

Effective Range: Shock wave blast: 300 feet (91.5 m)

Payload: Effectively unlimited; recharged when the power armor is recharged.

Bonuses: +1 to strike and parry.

Magic Spells: Can cast the turn dead spell three times per 24 hour period and banishment once. Both are equal to a sixth level spell.

- **TW Flaming Sword** or other hand-held TW weapon or magic item can be part of the character's armaments. Note that **Manoans** do not create rune weapons, although such items may be acquired from time to time.
- **Magic Senses:** Can cast a total of 8 spells per day from the following available sensory augmenting magic: See aura, see the invisible, detect concealment, sense magic, sense evil, and eyes of the wolf. Each is equal to a sixth level spell.
- **Magic Communication:** Can cast a total of 8 spells per day selected from the following available communication augmenting magic: Ley line transmission, magic pigeon, commune with spirits, calling, words of truth, and the eyes of **Thoth**. Each is equal to a sixth level spell.
- **Magic Flight:** Fly as the Eagle can be engaged for a total of two hours of flight per 24 hour period. These two hours can be split into any number of shorter flight periods, but cannot exceed a total of two hours.
- **Magic Underwater Capabilities:** Swim as the Fish (superior) and breathe without air can be engaged four times per 24 hour period. Equal to a sixth level spell. A one melee lapse is needed before the spell can be reengaged.
- **Magic Jungle Cloaking System:** Chameleon spell can be engaged at will; includes shield. Duration is equal to a sixth level spell. A one melee lapse is needed before the spell can be reengaged.
- **Super Energy Damper System:** Impervious to energy spell can be engaged at will. Energy attacks of all kinds do NO damage, including fire, lasers and electricity, but physical blows, including explosives, rail guns, mega-damage punches, etc. do full damage. Duration is equal to a sixth level spell. A one melee (15 second) lapse is needed before the spell can be reengaged. **Note:** This defense system counts as two selections!

## Lictor Assault Robot

By **C.J. Carella & Kevin Siembieda**

The Lictor is sculpted like a giant Greek-style statue of a man in breast plate and stylized helmet, wielding an axe and a giant rifle. This 30 foot (9.1 m) robot is a creation of advanced **techno-wizardry** magic. It has several built-in spells, including an energy field and the ability to fly! The rifle is a giant version of the TK rifle described in the **Rifts RPG**. The axe is an enchanted weapon able to shoot lightning bolts or deliver devastating electrified attacks. Additionally, the Lictor has a few mundane mechanical weapon systems, such as a missile launcher and a light laser. The robot is powered through magic and needs to be recharged at a pyramid after 72 hours of continual use.

Lictors are not commonly used by **Manoan** patrols, but held back for defense of the city. The exceptions are the **Manoan search-and-destroy** squads and special operations, in which lightly armed scouts locate a target and the **Lictor(s)** rushes in to finish the job. Four Lictors always stand guard at each of the city's main gates.

**Model Type:** L-100 Lictor

**Class:** Techno-Wizard Strategic Assault Robot

**Crew:** Two: one pilot and a **co-pilot/gunner**, usually a human or True **Atlantean**, occasionally an Amazon.

**M.D.C. by Location:**

Shoulder Plates (2) — 150 each

Axe — 200

Giant **TK-Rifle** — 250

Missile Launchers (2; shoulders) — 100 each

Arms (2) — 200 each

\* Hands (2) — 90 each

**Legs** (2) — 250 each

\* Head — 250

\*\* Main Body — 400

Magical Force Field — 150

\* A single asterisk indicates a small or difficult target to hit. They can only be struck when an attacker makes a called shot and even then the character is -3 to strike.

\*\* Depleting the M.D.C. of the main body will shut the robot down completely, making it useless.

**Speed:**

Running: 45 mph (72 km) maximum.

Leaping: 30 feet (9.1 m) lengthwise or 20 feet (6.1 m) high.

Flying: Fly at up to 50 mph (64 km). The spells sustaining flight only allow two hours of flight, after which the robot cannot fly again for 24 hours or until recharged at a pyramid (20 minutes for flight). These two hours can be split into any number of shorter flight periods, but cannot exceed a total of two hours.

Swimming: 10 mph (16 km)

**Statistical Data:**

Height: 30 feet (9.1 m)

Width: 15 feet (4.6 m)

Length: 9 feet (2.7 m)

Weight: 30 tons (27,000 kg) fully loaded.

Physical Strength: Equal to a supernatural P.S. 32.

Standard Tech Robot Features: All, including radar, targeting, radio communications, air purification, etc.

Standard Magic Features Include: Language translator (tongues spell), additional environmental systems (breathe without air and



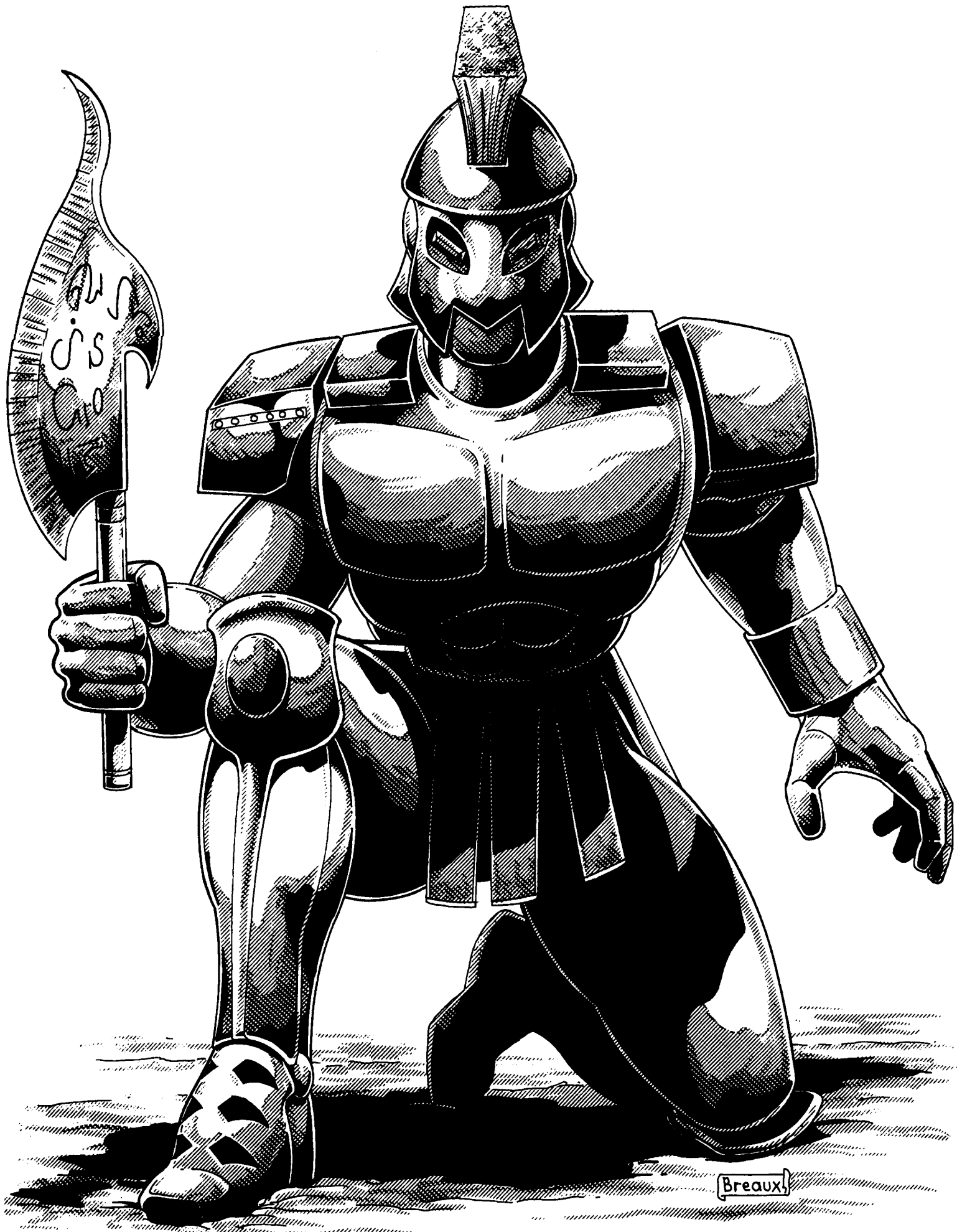

impervious to normal fire) and force field (armor of **Ithan**).

Cargo: Small area for the pilots' personal items.

Power System: Magical. Allows for 72 hours of continual use; afterwards, it must be recharged at a pyramid (one hour per day) or ley line (takes two hours per day's worth of energy); same basic conditions as the Hoplite power armor.

Market Cost: 80 million credits.

## Weapon Systems

**1. TK-Rifle:** This techno-wizard weapon resembles a giant rail gun, but fires hard bolts of invisible force, just like the techno-wizard **TK-machinegun**, only much more powerful.

Primary Purpose: Assault

Secondary Purpose: Defense

Mega-Damage: 1D6X10 M.D. per blast.

Rate of Fire: Equal to the combined hand to hand attacks (usually 4-8). Each blast counts as one melee action/attack.

Effective Range: 4000 feet (1220 m)

Payload: Effectively unlimited; recharges when the robot recharges.

**2. Energy Axe:** This enchanted weapon is useful both in close combat and for short-range attacks. The magic in the axe enables the wielder to either charge up the axe handle for hand to hand attacks, or to fire a powerful lightning bolt. If the axe is thrown it will magically return to its owner in three seconds.

Primary Purpose: Assault

Mega-Damage: 1D6X10 M.D. per electrically-charged hand to hand strike, or 1D4X10 M.D. for a lightning blast or when thrown.

Rate of Fire: Equal to the number of combined hand to hand attacks.

Effective Range: Hand to hand combat, thrown: 300 feet (91 m), or electrical blast: 600 feet (183 m).

Payload: Effectively unlimited; recharges with the robot at ley lines or stone pyramids.

Bonuses: +1 to strike and +2 to parry.

**3. Eye Plasma Bolts:** The ruby gem eyes of the Lictor are enchanted to unleash powerful plasma bolts/fire balls.

Primary Purpose: Assault

Secondary Purpose: Defense

Mega-Damage: 5D6 M.D. for a single blast from one eye or 1D6X10 M.D. from twin blasts simultaneously fired from both eyes at the same target (counts as one melee attack).

Rate of Fire: Equal to number of hand to hand attacks per melee.

Effective Range: 2000 feet (610m)

Payload: Effectively unlimited.

Bonuses: +2 to strike.

Magic Spells: The robot can also cast a fuel flame and circle of flame spell three times each per 24 hour period. Each is equal to a sixth level spell.

**4. Mini-Missile Launchers** (2): A pair of conventional mini-missile launchers are mounted on the shoulders.

Primary Purpose: Anti-Armor & Anti-Aircraft/Dragon

Secondary Purpose: Anti-Personnel

Mega-Damage: Varies with missile type, but typically armor piercing (1D4X10 M.D.) or plasma (1D6X10 M.D.).

Rate of Fire: Volleys of two, four or six.

Effective Range: About one mile (1.6km)

Payload: 48 total; 24 in each launcher.

**5. Concealed Laser Fingers** (2): The first finger on each hand conceals a light laser; point and shoot.

Primary Purpose: Anti-Personnel

Secondary Purpose: Defense

Mega-Damage: 2D6 M.D. per single blast or 4D6 M.D. per dual blast from both fingers simultaneously.

Rate of Fire: Equal to the pilot's combined hand to hand.

Effective Range: 2000 feet (610 km)

Payload: Effectively unlimited.

**6. Hand to Hand Combat:** Rather than use a weapon, the pilot can engage in hand to hand combat. Inflicts 5D6 S.D.C. on a restrained punch, 4D6 M.D. on a full strength punch or kick, and 1D4X10+8 M.D. on a power punch or leap kick. Robot Combat Bonuses: One additional attack per melee round at levels one, six, and eleven; +1 on initiative, +1 to strike, parry and dodge, +3 to dodge when in flight, +1 to pull punch, +1 to roll with impact.

**7. Energy Weapons:** The character may also use one or two conventional energy weapons, rail guns and equipment suitable for 30 foot giants. Smaller, man-sized items can be stored inside for use when the pilot is outside the robot.

**8. Some Commonly Available Optional Abilities:** Generally, the same items and powers (and limitations) that are available for power armor are available to the Lictor robot; except the magic net and all weapons must be giant-sized.

## Amazon R.C.G.

By C.J. Carella & Kevin Siembieda

The descendants of the fierce female warriors the **Atlanteans** rescued from certain death remain the loyal defenders of Manoa. *The Amazons* were transformed into their superhuman form through the powers of **Atlantean** alchemy, bio-wizardry and the intervention of some South American female goddesses who sympathized with the tribe's plight.

Over the centuries, the "Amazons" have lost most of their Indian cultural heritage, and adopted the language and customs of their Atlantean patrons while retaining their martial spirit. The Amazons have been taught to be aggressive warriors. Many dislike and/or distrust men, because males often underestimate and belittle their combat abilities on the basis of gender. This often works in the women's favor and the expert warriors have been taught to use every advantage available to them to win! Amazons are extremely self-reliant, honest, brave, outspoken, and competitive. On the battlefield, Amazons are courageous, bold, unmerciless and daring paladins equal to the best **cyber-knights**. Their views tend to be very black and white. They frown upon individuals who show indecision, self indulgence, lack of honor and other weaknesses of character and they usually air their disdain loudly. They abhor lies, cowardice, cruelty and betrayal above all else. Amazons are impressed by physical strength, intelligence and bravery.

Although liaisons between Amazons and normal humans have occurred constantly throughout their history, most of those relationships do not remain amicable or last long — their superhuman nature (often frightening to mere mortals) and high standard of ethics and morality usually come at odds with other less disciplined and moral people. As for romance, Amazons can mate with normal humans, True Atlanteans, or ogre males, but

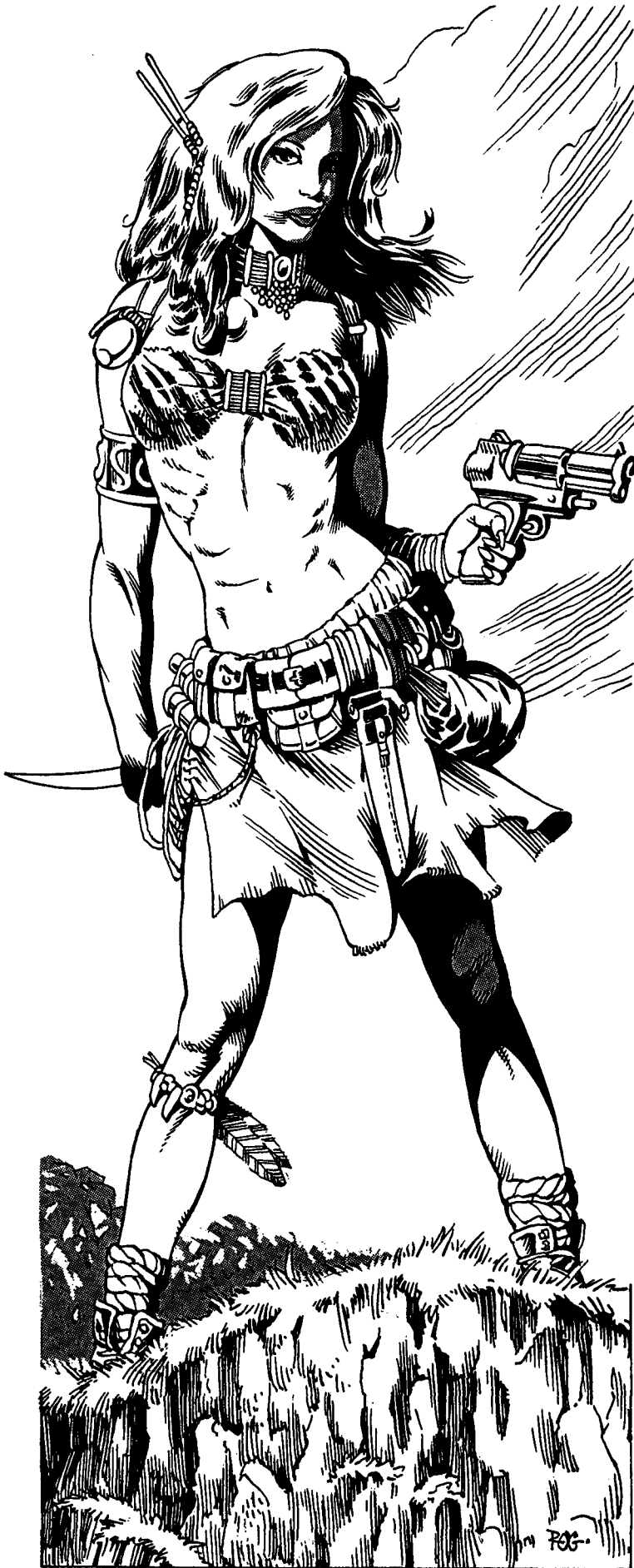

their offspring is almost always a superhuman female (85% likelihood; males are very rare). Some of the more hardened warriors will simply use their lover to conceive a female child and then abandon him. More often however, the Amazon enters into an honest and loving relationship. Sadly, such a romance may not last unless the husband can accept the trials and tribulations that come with a wife (and female child) dedicated to a life of soldiering. Amazons are known to be fiercely honest and loyal, thus they are not forgiving of any betrayal, indiscretions or abuses on the part of their mate. "As rare as a happily married Amazon" is a common expression in Manoa.

The gender of an Amazon's offspring determines their power. If the child is a male (15% chance), he has all the racial abilities of the father. Female babies (85%) will have the powers of the Amazon. Girls are educated in Amazon-run schools where they learn the arts of warfare, magic, and psionics, while males are usually left under the care of the father.

While Manoa remained in the dimensional limbo, the Amazons defended the city against occasional D-bee or monster attacks. Now they have to face a greater number of threats than ever before; a challenge they happily accept. Most Amazons are members of the Manoan defense forces and older war leaders now sit at the Council of Elders. After their return to Earth, some Amazons have rebelled against the old ways of war and some have left the city with their husbands and children to live comparatively peaceful and normal lives. However, the Amazon is warrior born and the call to adventure and combat is always nagging at them. Several small, independent human-Amazon communities have been established throughout South America. Some follow the typical Amazon traditions (some are even more aggressive and militant than those at Manoa) and others do not. A sizable number can also be found adventuring anywhere on Rifts Earth and in other dimensions. Some are knight-errants and others are explorers out to see the world (or Megaverse).

**Alignment:** Any, but usually good, unprincipled or aberrant. Evil Amazons often hate all males and seek to punish, enslave or destroy them. Evil ones also tend to use their formidable powers for their own selfish desires (usually power, wealth and worship) to conquer and rule, enslave, or terrorize all weaker beings.

**Attributes:** I.Q. 3D6, M.E. 3D6+4, M.A. 3D4, P.S. 3D6+10, P.P. 3D6+8, P.E. 4D6+4, P.B. 3D6+6, Spd 6D6. Supernatural strength and endurance.

**Average Attributes:** I.Q. 11, M.E. 16, M.A. 11, P.S. 22, P.P. 20, P.E. 20, P.B. 17, Spd 25. Inflicts 4D6 S.D.C. on a restrained punch, 2D6 M.D. on a full strength punch or kick and 4D6 M.D. on a power punch.

**Hit Points & S.D.C.:** Standard hit points, same as humans, plus 4D6X10 S.D.C. in non-mega-damage environments. M.D.C.: 3D6X10 plus 2D4 per level of experience; becomes an M.D.C. being on Rifts Earth and in other mega-damage environments. Can also wear body armor or power armor.

**R.C.C. Abilities and Bonuses:**

1. **Supernatural Attributes:** In the P.P.E. rich environment of Rifts Earth, the Amazon warrior becomes a mega-damage creature with supernatural strength and endurance. This means the warrior can pick-up and carry 50 times the weight of a normal human and inflict M.D. with their bare hands. Use the table in **Rifts Conversion Book One**, page 22, to determine hand to hand damage.

2. **Natural Powers:** In addition to their high attributes, Amazon warriors have the following natural abilities: Nightvision 60 feet (18.3 m), superior hawk-like vision, resistant to heat and cold (M.D. heat and cold inflicts half damage, immune to normal heat and cold) and bio-regenerate 1D4X10M.D. (or hit points) every hour.

3. **Magic Powers:** Amazons can have either magic OR advanced psionic powers (pick one). If the magic option is used, the Amazon gains all the *magic powers* of a Mystic, numbers 1, 2, and 4 (see **Rifts RPG**, page 86). The Amazon gets none of the Mystic's special O.C.C. abilities, but she can select a total of four lesser psionic powers from healing, sensitive or physical and is still considered a major psionic. **P.P.E.:** 2D4X10+P.E. and add 2D6 P.P.E. per level of experience. **I.S.P.** is limited to M.E. plus 3D6.

4. **Psionic Powers:** Amazons can have either magic OR advanced psionic powers (pick one). If psionic powers are selected the Amazon is considered a master psionic. She selects a total of eight powers from any of the lesser categories (mix and match) and has the super psionic powers of psi-sword and psi-shield. An additional two lesser powers can be selected each additional level of experience. One additional super psionic ability can be selected at levels 3, 5, 7, 9, 11 and 13. **Bonuses:** +1 to save vs psionic attacks and +2 vs magic illusions, +1 to save vs horror factor. **I.S.P.:** M.E.+1D6X10, plus 2D6 per level of experience. **P.P.E.:** 1D4X10.

5. **Enhanced Longevity:** Amazons age at a slower rate than normal humans. While they are not as long-lived as elves or Atlanteans, the Amazon does not age until she reaches 200 years of age. Until that point she looks to be in her early 20's! They can live for 1D4X100+160 years.

6. **Bonuses:** +1 attack per melee round, +2 on initiative, +1 to parry and dodge, +1 to save vs magic, +4 to save vs horror factor, +3 to save vs disease, +10% to save vs coma/death. This doesn't count any possible attribute or skill bonuses.

#### **R.C.C. Skills:**

Lore: Monsters & Demons (+15%)

Language: Atlantean (98%)

Language: Spanish (98%)

Language: Two of choice (+10%)

Wilderness Survival (+10%)

Land Navigation (+10%)

Track Humans (+15%)

Track Animals (+15%)

W.P. Sword

W.P. Archery and Targeting

W.P. Energy Rifle

W.P. Two of Choice (80% will use archaic weapons).

Hand to Hand: Expert

Hand to Hand: Expert can be changed to Hand to Hand: Martial Arts (or assassin if evil) at the cost of one "other" skill.

**R.C.C. Related Skills:** Select six "other" skills from any of the available categories, plus one additional skill at levels three, six, nine and twelve. **Note:** The Amazons tend to rely on their superhuman abilities and are usually unfamiliar with most high-tech skills.

Communications: Radio: basic only.

Domestic: Any (+10%)

Electrical: None

Espionage: Any (+10%)

Mechanical: None

Medical: Only Holistic Medicine (+10%)

Military: None

Physical: Any (+10% where applicable)

Pilot: Any, except high-tech power armor, robots, tanks and spaceships. Amazons may learn to pilot the magic Hoplite power armor or the Lictor robot (but most prefer to engage in one on one combat without hiding behind a robot or battle suit).

Pilot Related: None.

Rogue: None.

Science: Botany, Chemistry, Basic Math and Advanced Math only (+10%)

Technical: Any (+10%), except Computer Operation and Computer Programming.

W.P.: Any.

Wilderness: Any (+10%)

**Secondary Skills:** The character gets to select four secondary skills from those listed. These are additional areas of knowledge that do not get the advantage of the bonus listed in the parentheses. All secondary skills start at the base skill level.

**Size:** Average is 6 feet (1.8 m) tall, but can reach up to 7 feet (2.1 m).

**Weight:** Average 140 to 160 lbs (63 to 72 kg); all muscle.

**Standard Equipment:** A short tunic or leather halter top, skirt, a cloak or cape, metal arm bands and 1D6 other articles of clothing (usually sparse clothing is worn in the hot and incredibly humid jungle). A backpack, sleeping bag, blanket, 50 feet (15.2 m) of rope, skinning knife, fishing line and hooks (bone or metal) and 1D6 weeks of dried food rations.

**Weapons and Armor:** Amazons in the service of Manoa are issued a **TW** Flame Rifle or a **TK-Machinegun**, a **TW** Flaming Sword and a light suit of enchanted chain mail armor (70 M.D.C. and lightweight, but 45% prefer to fight unencumbered by armor). They may also have two or three additional weapons of choice, usually reflecting their W.P. skills. Independents will have two energy weapons of choice and three other weapons (including archaic types) plus 1D6 spare **E-Clips** or **TW-Clips**, and a suit of light body armor (60% prefer to fight unencumbered by armor). Favorite types of weapons include magic items of all kinds, bow and arrows of all kinds, **Kittani** plasma swords and axes, and **vibro-blades**.

**Money:** Usually none. May have the equivalent of 1D6X1000 credits in trade items. Additional moneys may be provided for special missions.

## Atlantean Monster Hunter O.C.C.

By C.J. Carella

The leaders of Clan Skellian, the developers of the Monster-Shaping Tattoos, have created a special force of tattooed warriors, similar to the Atlantean Undead Slayers (see **Rifts Atlantis**). These agents are trained in the arts of subterfuge and espionage with magic tattoos ideal for the job. Some of the most adept Monster Hunters have infiltrated the inhuman cities of Cibola, New **Dragona**, and **Splynn**, risking their lives in daring espionage and rescue missions. Others travel the land, acting as pala-

dins of justice, and often under the pretense that they are an inhuman "sidekick" or slave of a more human looking master (True Atlantean, Amazon or warrior/spy) to justify their inhuman form. See the Monster-Shaping Tattoos in this section for more details.

## True Atlanteans

### Character information common to most Atlanteans

Alignment: Any; but the majority are principled, scrupulous, or unprincipled.

**Attributes:** The number of six-sided dice rolled is designated. I.Q. 3D6+4, M.E. 4D6+6, M.A. 3D6+4, P.S. 4D6+4, P.P. 3D6, P.E. 3D6+6, P.B. 3D6+6, Spd. 4D6+6

**Hit Points:** P.E.+1D6 per level of experience.

S.D.C.: 50 plus those gained from O.C.C.s, magic tattoos, and physical skills. Only Undead **Slayers/Tattooed Men** are mega-damage creatures.

**Natural Armor Rating:** None

**Horror Factor:** 14 if an Undead Slayer or 12 for the average Atlantean. Even humans tend to be awestruck when they realize they stand with or against a True Atlantean.

**Weight:** 170 lbs plus (76.5+ kg).

**Height:** Start at 6 feet plus 1D4 inches (about 1.8 m). Add one inch for every hundred years of age.

Age: Most appear to be 19 to 35 years old, but can be anywhere from 19 to 250 years old. An Atlantean that looks to be 40 or 50 years of age is physically 251 to 500 years old. The average life span is 500 years, but time warps caused by dimensional travel can enable the character to span a thousand years, sometimes more.

Sex: Male or female.

**Appearance:** Entirely human; handsome, dark hair (brown to black) and tall - six to seven feet.

**Disposition:** Typically a headstrong and bold lone wolf, but kind, merciful, noble, honest and brave.

**Combat Skills:** Typically Hand to Hand: Expert or Martial Arts.

**Magic:** Depends on O.C.C.

**P.P.E. Base:** 10, plus the average Atlantean has an additional 12 P.P.E. from the "Marks of Heritage" and six P.P.E. for each additional magic tattoo. Furthermore, the Atlantean has the P.P.E. from any magic O.C.C.s; the exact amount varies with each magic O.C.C.

### Atlantean Characteristics as they apply to Monster Hunters

**1. Magic tattoos denote heritage.** Each True Atlantean has a tattoo of a heart impaled by a wooden stake (no blood) on the right wrist for protection from their eternal enemy, the vampire, and a flaming sword tattoo on the left wrist to create a magic M.D.C. weapon. The tattoo is placed on an Atlantean child at age five or six. The clan crest of the Skellian (two interlaced Chiang-Ku dragons) is always part of the sword's hilt. The marks are just two of the 17 to 50 tattoos that cover their bodies.

**2. Increased P.P.E. from magic tattoos:** Base P.P.E. is 2D4X10 for all monster hunters, males and females. Add 10 P.P.E. points for each level of experience and six P.P.E. points for each tattoo. The character can also draw energy from ley lines and nexus points.

**3. Increased P.P.E. Recovery:** The monster hunter's P.P.E. replenishes itself at the rate of 20 points for every hour of rest or sleep, four times faster than normal humans!

**4. M.D.C. transformation.** Monster hunters have a base M.D.C. of 2D4X10 plus each additional tattoo beyond six instills the male monster hunters with 11 M.D.C. points and females with 13 M.D.C. points.

**5. Cannot be physically transformed by any means,** including, but not limited to, metamorphosis potions and spells, the transformation ritual, vampire transformation, **petrification**, turn to mist, growth or **reduction/shrinking** spells, potions or any other form of magic or supernatural transformation spell, curse, wish, or enchantment.

**6. Continue to grow as adults.** After reaching adulthood at about age 25, True Atlanteans grow about an inch (25 mm) every century or so, which gives them an average adult height of six feet, six inches to about seven feet (2.0 to 2.1 meters).

**7. Sense vampires.** Can sense the presence of vampires and vampire intelligences within a 1000 foot (305 m) radius, but cannot pinpoint exact source/person responsible for the sensation. Recognizes vampires by visual **identification/appearance:** 10% per level of experience.

**8. Operate dimensional pyramids.** All Atlanteans are seasoned dimensional travelers who know how to operate the pyramids created by the stone masters for the purpose of communication and dimensional **teleportation**. Base skill is 40%+5% per level of experience.

**9. Sense ley lines.** Same as the Line Walker.

**10. Sense Rifts.** Same as the Line Walker.

**11. Ley line Phasing.** Same as the Line Walker.

**12. Other Bonuses:** +1 on initiative, +2 to save vs magic of all kinds (in addition to P.E. bonuses), +8 to save vs horror factor. Attribute bonuses from physical training and magic: +1 to M.E., +2 to P.S., +2 to P.E., and +4 to Spd. Monster Hunters are considered to be supernatural beings.

**Magic Tattoos (see Rifts Atlantis):** The typical Monster Hunter will start with 15 tattoos in addition to the Marks of Heritage (see above).

Make the following selections:

One simple weapon

Two magic weapons

Two Animals

Two Monsters

Four Monster-Shaping

Three Powers

Select one more tattoo from any category.

Then, with each level of experience, the character's clan elder or clan alchemist will add two more simple tattoos (animal or simple weapon) or one major tattoo (powers, monster, monster-shaping or magic weapons). The most tattoos any **Tattooed-Man** can get at any time is two. There must be at least six months between the acquisition of another pair of **tattoos**.

**Attribute Requirements:** I.Q. 10 or higher and M.E. 20 or higher. A high P.S. and P.P. are helpful but not required.

**Note:** Many young Atlanteans from Clan Skellian have volunteered for the Monster Hunter O.C.C. to be better prepared for adventuring around the world. For many, this is **their** first time in the field of combat. Characters should start at first level of experience.

**Racial Restrictions:** True Atlanteans, humans, ogres and chiang-ku.

**O.O.C. Skills:**

Radio: Basic (+10%)

Languages and Literacy: **Dragonese/Elf**, American and Greek at 98%

Languages: Speaks/understands two additional languages of choice (+15%)

Intelligence (+15%)

Tracking (+10%)

Wilderness Survival (+15%)

Lore: Demons & Monsters (+25%)

Lore: Magic (+15%)

Disguise (+15%)

Concealment (+15%)

W.P. Sword

W.P. Energy Pistol

W.P. Energy Rifle

One W.P. of choice

Hand to Hand: Martial Arts

**O.C.C. Related Skills:** Select four "other" skills, plus three additional skills at levels four, eight, and twelve. All new skills start at level one proficiency.

Communications: Any (+5%)

Domestic: Any (+5%)

Electrical: Any

Espionage: Any (+10%)

Mechanical: Any

Medical: Any (+10%)

Military: Any (+10%)

Physical: Any

Pilot: Any, except robot and power armor skills (+10%).

Pilot Related: Any (+10%)

Rogue: Any (+4%)

Science: Any (+5%)

Technical: Any (+10%), except Computer Operation and Computer Programming.

W.P.: Any

Wilderness: Any (+5%)

**Secondary Skills:** The character gets to select six secondary skills from those listed. These are additional areas of knowledge that do not get the advantage of the bonus listed in the parentheses. All secondary skills start at the base skill level.

**Standard Equipment:** Typically has a TW energy rifle and energy pistol, plus any weapon and equipment that suits his mission. When masquerading as a monster, the Monster Hunter will wear any armor and equipment the creature would normally use.

## Tattoos of Monster-Shaping

### A new variety of Tattoo Magic

Monster-Shaping tattoos are a special category of tattoo that seemingly transforms the user into a member of any monster race! These tattoos do not grant "true" shapeshifting abilities, but an ectoplasm-like substance that surrounds the character's true body, disguising his appearance.

True Atlanteans cannot be transformed by any means, magical or technological, but the magical Monster-Shaping tattoos do NOT physically transform the character. Instead it creates a magical false body around him. One might consider the monster shapes created by the tattoos to be a mystic monster costume, **exo-skeleton** or power armor with elements of illusion thrown in. The monster shape adds to the tattooed man's M.D.C. and physical P.S., P.P. and P.E., but does NOT grant the user any of the special powers of the monster race he or she is disguised as (although they simulate such power through other means). The **Atlantean** Monster Hunter (see new O.C.C.) uses these tattoos to infiltrate alien organizations or to get close to their quarry without being noticed. If the M.D.C. of the creature disguise is depleted, the "costume" is ruined and the **T-Man** within is revealed.

Only members of Clan **Skellian** and a few **Chiang-Ku** dragons know the secrets of monster-shaping tattoos (the Chiang-Ku helped the Skellian alchemists develop the shapeshifting magic). Player characters must be affiliated with either Clan Skellian or the dragons who hold its secrets to have access to those tattoos. Note: The **Splogorth** are beginning to suspect that a new category of tattoo has come into existence. Once they find proof of it, they will spare no effort to capture and study any tattooed men with shapeshifting powers.

### Shapeshifting Powers

To activate a shapeshifting tattoo, the T-Man merely touches the tattoo and focuses his concentration on it (counts as one melee **action/attack**). The tattoo glows with a blinding aura that completely covers the character. When the aura dissipates, the T-Man has a new, monstrous shape — actually, he or she is surrounded by a magical shell that has the desired shape.

#### P.P.E. needed to activate the shapeshifting tattoo:

- Beings with less than 1000 S.D.C. and/or hit points: 30 P.P.E.
- M.D.C. races with less than 60 M.D.C.; 60 P.P.E.
- M.D.C. races with 61 to 200 M.D.C.; 90 P.P.E.
- M.D.C. races with 201 to 1000 M.D.C.; 120 P.P.E.
- M.D.C. races with 1001 to 3000 M.D.C.; 200 P.P.E. (the limit).

**Duration:** 30 minutes per each level of the Tattooed Man's experience. If the S.D.C. or M.D.C. of the shell is destroyed, the power will be cancelled and the **T-Man's** true shape will be revealed. If the T-Man is slain while in the fake form, his remains will return back to his natural shape. The false shape will continue to exist even if the creator is rendered unconscious, possessed, or mind controlled.

**Physical Attributes:** The monster form has the maximum P.S., P.P., and P.E. attributes of a member from that race or the tattooed man's own, whichever is higher.

**Attacks Per Melee and Combat:** The character also gains any natural hand to hand attacks his new shape has, such as tail strikes or bite and claw attacks. The shape, however, does NOT grant the tattoo user any of the natural abilities of the race, including special senses, flight, regeneration, natural shapeshifting abilities, breath or energy attacks, etc.

**Natural Body Armor:** The false shape provides the character with M.D.C. or S.D.C. protection and can be treated as a suit of body armor. When its structural capacity is depleted, the shell/shape is destroyed, its armor protection gone, and the

character's true identity is revealed. The maximum mega-damage value of the false shape cannot exceed 800 M.D.C. or twice the character's natural M.D.C. total, whichever is more. In other words, a tattoo user could take the shape of an adult dragon, but he would only have a maximum of 800 M.D.C., instead of the 2,000+ M.D.C. possessed by most adult dragons.

**Limitations:** The magic shape changing tattoos only give the character the general shape, size and features of a particular race and cannot be used to assume the features of a specific individual. Thus, the True Atlantean may look like a typical troll or sphinx, but not the leader of a particular tribe or any other specific character.

When a **shapeshifting** tattoo is activated, the wielder takes the shape of a member of the race depicted in the tattoo. The racial disguise desired must be larger than the Tattooed Man (T-Man). Since most Atlanteans are over six feet (1.8 m) tall, only larger than human races can be imitated with tattoo magic. Ogres, trolls, wolven, **brodkil**, gurgoyles, giant races and large monsters like dragons, sphinxes and others are ideal for this type of disguise.

Even when transformed, the magic tattoos remain visible on the character's false hide, skin or scales. They can be covered under clothing or armor, but doing so will restrict access to them. Since most non-human races cannot use tattoo magic, people may assume these tattoos are decorative — or may wonder whether or not the creature is an impostor! While in altered form, the character can use his other tattoos as usual. Power tattoos or other forms of magic can be used to simulate the abilities of the T-Man's false shape.

## The Ewaipanomas R.C.C.

### Headless Men of the Amazon — Optional Player Character

Several European explorers of the Amazon Jungle came back with tales of a mysterious tribe of aborigines who had no heads! They claimed that these beings (usually considered to be demons) had the normal body of a brown skinned human, but their eyes were set **on/in** their shoulders and they had two mouths, one in the middle of each breast. This tribe was known as the Ewaipanoma (pronounced eh-wai-pah-no-mah). The tales were dismissed as wild fantasies, hallucinations caused by the heat or superstition.

The tales were true. A large number of these "headless" beings live in South America; the only place in the world where they could be found. This race was not native to Earth, but had been transported to our world during the great dimensional disaster caused by the ancient Atlanteans thousands of years ago. Over 2,000 Ewaipanomas were wrenched from their homes and deposited in an unknown jungle on a strange planet.

Their homeworld was closely linked to Earth **elementals** but it had little in the way of plant and animal life. The incredible variety of life on Earth drove many Ewaipanomas to the brink of insanity and death. To make their lives worse, at that time, magic was on the wane on Earth (as a result of the same Atlantean experiment), and although the Ewaipanomas possessed elemental powers equal to earth warlocks, their powers were



greatly reduced. Their only assets were their strength and physical toughness, which enabled them to survive the dangers of the jungle wilderness and frightening tribespeople (many of whom attacked the aliens, believing they were demons).

Despite these odds, the Ewaipanomas persevered and survived. A few peaceful native tribes gave them acceptance and taught them how to live in the jungle. With time and experiences, they became adept to the ways of the rain forest. Over the centuries, new human tribes appeared and hunted the Ewaipanomas with greater determination. The arrival of the Skellian Atlanteans saved the aliens from extinction. Eventually, most Ewaipanomas in South America came to live with the Atlanteans. Their powers over earth and stone were helpful in building **Manoa** and many of them continue as builders, architects and stone masters (a magic learned from the **Manoans**) to this day.

The Ewaipanomas race of people are very calm, rarely rushing to do things without thinking them through first. Most of the time, they are very rational, diplomatic and peace loving. The Ewaipanomas of Manoa are very well educated and love to ap-

ply logic and reason to any problem. When they lose their temper, however, they are a terrible sight to behold. This only happens when they are provoked by brutality or threatened with slavery.

**Alignment:** Any

**Attributes:** I.Q. 3D6, M.E. 3D6+4, M.A. 3D6, P.S. 2D6+20, P.P. 3D6, P.E. 4D6+4, P.B. 2D6, Spd 3D6. Supernatural strength and endurance.

**S.D.C./Hit Points:** Standard hit points in non-M.D.C. worlds, plus 1D6X10+10 S.D.C. (plus those gained by O.C.C. and skills).

M.D.C.: 2D6X10 M.D.C. plus add 1D6 M.D.C. per level when in a mega-damage environment such as Rifts Earth.

**Natural Abilities:** Supernatural strength, regenerates 2D6 M.D.C. per hour, and can communicate with elementals (98%).

**Bonuses:** +2 to save vs magic and psionics, +2 to save vs horror factor, add 1D4X10 to starting P.P.E. This is in addition to O.C.C. and attribute bonuses.

**O.C.C.s:** 70% of all Ewaipanomas are Earth Warlocks, 20% are Stone Masters and 10% are others. Average level of experience is 1D4, but some adventurers and elders can reach much higher levels (their casual, laid-back nature causes them to advance in experience at half the normal rate).

Size: 6 to 7 feet tall (1.8 to 2.1 m).

**Weight:** 300 lbs (135 kg)

**Standard Equipment:** Varies with O.C.C.

**Cybernetics:** Never get any!

## Shaydor Spherians

The shaydor are a race of **nonhumanoid D-bees** that have been enslaved by the **Splugorth** for millennia. These gentle, long-limbed, crystalline creatures are usually encountered a small groups of travelers, or as the servants of alien monsters. **Manoa** has a very large population of shaydor, however. Not very long after Manoa's return to Earth, about two hundred years ago, a wandering tribe of **spherians** settled in Manoa. The city's reputation for fairness and friendliness attracted many more members of that race, so that over the last hundred years there has been a population explosion of shaydor in Manoa. The spherians now are one of the most numerous and influential races in the city. Note: The shaydor race is fully described in Rifts Atlantis.

**Alignment:** Any

**Horror Factor:** 12

**Attributes:** I.Q. 3D6+2, M.E. 4D6+2, M.A. 3D6+2, P.S. 2D6, P.P. 2D6, P.E. 3D6+2, P.B. 3D6, Spd 3D6.

M.D.C.: 2D4X10+20

**Natural Abilities:** Prehensile feet, tail and tentacles, double-jointed, ambidextrous, good color vision, keen hearing, swim 50%, climb 70%, prowl 60%.

**Bonuses:** +4 on initiative, +3 to strike and parry, +5 to strike with tail, +4 to dodge, +2 to roll with punch, fall and impact, +6 to save vs horror factor, +1 to save vs psionics, poison and disease, +10% to save vs **coma/death**. Bonuses are in addition to attribute bonuses.

**Magic:** None; rely on psionics, although they may collect and use magic items.

**Psionics:** Considered a master psionic/mind melter. They are divided into four types of psionic **orientation/O.C.C.'s**: healer,

sensitive, explorer and warrior; each with a different variety of powers.

**Healer:** I.S.P.: M.E. number plus 4D6X10 (+10 per each level of experience). Has mind block, telepathy, see aura, bio-regeneration (self), healing touch, psychic diagnosis, and bio-manipulation. Plus select five additional psionic powers from the category of healing, three from sensitive and three from super **psi-powers**. Select one additional healing or super **psi-power** every three levels of experience, starting at level three.

**Sensitive:** I.S.P.: M.E. level plus 3D6X10 (+10 per each level of experience). Has mind block auto-defense, telepathy, empathy, see aura, presence sense, sense magic and ectoplasm. Plus select six additional powers from the category of sensitive, two from healer, two from physical and three mind type powers from super psionics (no kinesis of any kind). Select one additional sensitive or super-psi power every three levels of experience, starting at level three.

**Explorer:** I.S.P.: M.E. number plus 3D6X10 (+10 per each level of experience). Has mind block, telepathy, see aura, astral projection, object read, telemechanics, impervious to cold, impervious to fire, and resist fatigue. Plus select four powers from the category of physical, two from sensitive, and three from super psionics (any). Select one additional power from any psionic category every two levels of experience, starting at level two.

**Warrior:** I.S.P.: M.E. number plus 4D4X10 (+10 per each level of experience). Has mind block auto-defense, telepathy, see aura, sixth sense, death trance, alter aura, impervious to fire, summon inner strength, and resist fatigue. Plus select four additional powers from the physical category, two types of kinesis (super), and three other super psionic powers. Select one additional power from any psionic category, except healing, every three levels of experience, starting with level three.

**R.C.C. Skills:**

Art (+5%)	
Computer Operation (+10%)	Writing (+10%)
Land Navigation (+15%)	Basic Math (+20%)
Wilderness Survival (+10%)	Advanced Math (+20%)
Languages: Native <b>Shaydorian</b> and <b>Dragonese/Elf</b> 98%	
Languages: Select two additional (+20%)	
W.P. Knife	w.P. One of choice

**R.C.C. Related Skills:** Select seven "other" skills, plus one additional skill at levels three, six, nine and twelve. All new skills start at level one proficiency.

Communications: Any (+10%)	Wilderness: Any (+5%)
Domestic: None	Electrical: Any
Espionage: Escape and intelligence only (+5%)	
Mechanical: Any	Rogue: Any
Medical: Any (+5%)	Science: Any
Military: None	Technical: Any (+5%)
Pilot Related: Any	<b>W.P.:</b> Any
Pilot: Any, except robot and power armor.	
Physical: None; see natural abilities	

**Secondary Skills:** The character also gets to select six secondary skills from the previous list. These are additional areas of knowledge that do not get the advantage of the bonus listed in the parentheses.

**Size:** 7 to 10 feet (2.1 to 3.0 m) tall      **Weight:** 100 lbs (45 kg)

**Standard Equipment:** Shaydor from Manoa usually carry one or two **TW** weapons.



# Omagua — City of Jaguars

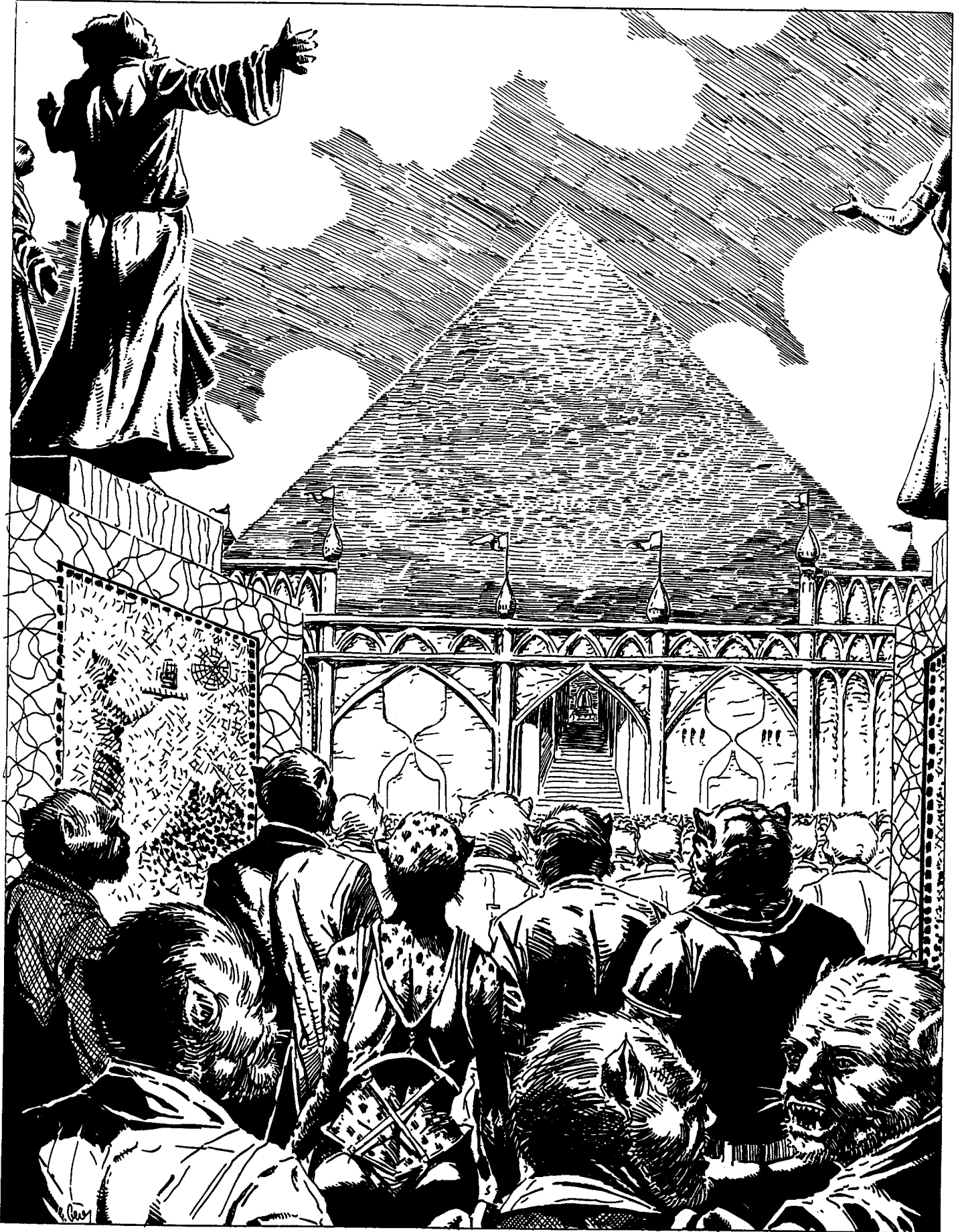

**Population Breakdown:** About 1.5 million

Felinoids: 400,000

Assorted Mutant Felines: 400,000

**Werejaguars:** 50,000

Flying Tigers: 100,000

Hunters: 100,000

Oracle Cats: 80,000

Flame Panthers: 80,000

**Sekhmet** Lion People: 60,000

**Werepanthers:** 50,000

**Ramen** (see Rifts Africa): 20,000

Lizard Men: 10,000

**Raksashas:** 2,000

Sphinxes: 2,000

Humans: 10,000

Jungle Elves: 10,000

Other: 100,000+ assorted D-Bees, the occasional dragon, and a few gods, demigods and other supernatural beings.

There are also an additional **4D6X1000** visitors at any one time. There are no slaves in **Omagua**.

The origins of **Omagua** **harken** back to the time before the Rifts, when the nation of Argentina had become a world power and an important center of technology. In a secret laboratory hidden in the sparsely populated Argentinean plains, a number of genetic experiments were conducted decades before the Rifts. The goal of **Project Achilles** (the code name of all experiments conducted at the institute) was to produce a breed of super-soldiers. The laboratory spliced human and animal material, trying to come up with a viable warrior race. Dozens of different animal species were tried, but the laboratory had the most success with the genes of the great hunting cats — tigers, leopards and the South American jaguar. Eventually, no less than a hundred different varieties of mutant felines had been developed. These ranged from the standard "cat-men" to the superhuman "hunter." The natural psychic abilities of some felines were also discovered and enhanced. The mutant races were given exaggerated predatory instincts and blood lust, taking the predatory instincts of cats to an almost demonic level. The project directors were convinced that in a few years they would have an unbeatable army of anthropomorphic warriors.

None of the scientists gave much thought to the feelings of the subjects **themselves**. The mutant cats were subjected to innumerable brutal experiments and treatments. "Useless" strains of non-warriors were killed in grotesque procedures designed to test the limits of endurance. The scientists tried to instill a slave mentality into the mutants by inspiring fear. It didn't work. The gene-engineered warriors saw their creators as an enemy to be overcome. Many researchers and guards were killed by their prisoners, but all escape attempts were stopped and the genetic batches of proven rebels was poured down the drain.

One of the "rejects" was a small, runty, mutant black panther called **ZB-23** (the mutants were not given names, just a letter and number to designate the genetic batch they had come from). "Zee," as he was called, was weak, slow, and lacked any of the predators' characteristic ferocity. By rights, ZB-23 would have died horribly in one of the endurance experiments. However, he tested very high on all ESP tests, so he was kept alive until the geneticists could isolate the source of his powers.

Zee was used as a "trusty" by the institute guards and was allowed to move freely about the labs and security areas. On at least two occasions he calmed down a berserker mutant before it could kill other inmates. Despite his privileges and high regard by humans, he was well-liked by the other mutant cats. He was always there with a kind word and good advice. The amazing psionic abilities of "Zee" prompted the Achilles Project to start breeding more cats of his kind. Thus were created the so-called "Oracle Cat."

What the researchers did not know was that Zee and his fellow oracle cats were super-intelligent as well as psionic. They also had a deep love of freedom and were determined to free themselves and their kindred from captivity. The week before the Great Cataclysm, Zee and his brothers and sisters had clairvoyant dreams of the disaster to come. With the dreams came a visitation. All psychics saw three feline faces counseling them and showing them a place in the jungle where they would find a home.

The oracle cats made their plans, keeping them from their fellow mutants until the hour before the escape. After contacting all the feline mutants through telepathy, the psionic cats led a massive breakout. The guards and security robots were overwhelmed, but there were severe losses on both sides. The survivors then fled to the jungles. Hours after the breakout, the Great Cataclysm began and the Argentine Army had other things to worry about than the escapees.

The pilgrimage into the jungle took months to complete. It was an epic odyssey that has been passed down in **Omagua's** history and legend. The mutant refugees travelled through the land while earthquakes, ley line storms, and monstrous **transdimensional** monsters ravaged the world. Many perished during the exodus, but the felinoids pressed forward, inspired by their spiritual leaders. Halfway to their destination, they encountered a group of strange beings, **werejaguars**, who had arrived through the dimensional Rifts or who had secretly dwelled in the South American jungle for centuries. At first, the mutant and supernatural feline races were suspicious of each other, but they quickly became allies, traveling and fighting their way to freedom together. When they reached the preordained location in the vision, all the surviving cats joined hands and performed a powerful ritual that opened a huge Rift. Through the Rift came the city of **Omagua**, the mythical jaguar city once again returned to Earth.

Over the years, **Omagua** grew in size. The mutant cats, living in relative peace and prosperity, bred and multiplied quickly. Their technical knowledge, acquired secretly while in captivity, allowed them to raise the technology of the city to a level close to that of the Coalition States. The ones known as the Divine Felines brought more cat D-bees from other worlds from weretigers to sphinxes. **Omagua** prospered. The native peoples of the area avoided the city at first, but eventually came to accept the mutants and even started some trade, although usually at special meeting places; only a few humans were allowed to proceed through the secret passes leading to the city. It wasn't until more than two centuries had passed that the first crisis took place.

Raiders from **Cibola** started sacking the smaller villages around the outskirts of the city. Then they braved the protective dimensional barriers to attack **Omagua itself**. When a small army of feline warriors went after the raiders, they ran into an Amazon

and **Atlantean** force from **Manoa** — just as the alien intelligence of Cibola had planned. Before communication could be established, snipers hiding in the forest opened fire, and a battle erupted between all three sides. Cat warriors were attacked and killed, mistaken as the perpetrators of the attack. **Atlanteans** and Amazons retaliated against the *monsters* with deadly force. When the fight was over, a state of undeclared war existed between all three of the great cities (ironically each mistaken for mythical El Dorado).

Most of the time, there are only occasional skirmishes between the three enemies. Omagua has developed a standing army, both to deal with old enemies and to protect against the rapidly increasing **Splugorth** raids that come from the Kingdom of **Lagarto**, a new and potentially deadly enemy.

## The Divine Felines

Omagua was the creation of three gods: the South American deity **Yaguar-Ogui**, the Egyptian goddess **Bast** and the African lion-god, **Simba**. These deities are the patrons of many feline races across the Megaverse. They have wanted to create a haven for felineoids (as they call them) for eons; Omagua is the realization of that dream. The Coming of the Rifts, and the plight of the Argentinean mutant cats gave the trio the inspiration to create a homeland for felineoids on Earth. Since the creation of Omagua, the Divine Felines have formed a mini-pantheon of their own, with its own area of interest separate from their original divine groups.

**Story Note:** The long-term plans of the Divine Felines are a mystery. Maybe they plan to expand their influence over Rifts Earth. On the other hand, they seem content with the territory they hold and may only care about the rest of the planet when something or somebody directly threatens the well-being of their people. Depending on the Game Master's plans, the three gods (or any one or two of them) could be ambitious would-be conquerors, devious plotters, or champions of good. However, the welfare of Omagua and its inhabitants will remain first and foremost in each of their minds.

## Government

Omagua has a theocratic government, ruled by religious leaders — in this case, the gods themselves! The Divine Felines live within the city walls at least some portion of the time. They are the ultimate rulers of the city and the adjacent lands. Most of the time, the gods leave the day-to-day management of Omagua to the **Claw Leaders**. The Claw Leader is a political and religious position that combines the roles of military commander, city administrator and high priest. There are five Claw Leaders appointed by the Divine Felines. They make most major decisions and can only be overruled by the **gods**.

There is also a representative body, called the **Assembly of the Prides** (commonly known as "The" Prides, as in lion's pride — a communal group of felines). The Prides has one hundred representatives who are elected by universal vote; the hundred candidates with the most votes are elected to the Council every four years. The Prides can propose laws, levy taxes and act as a Supreme Court during important legal disputes, but most of the political power rests with the Claw Leaders.

## Society

The average Omagua citizen is happy and content. The city is a clean and prosperous place and violent crime is rare. The exception to the rule is the area known as the **Kitty Litter**, but even that area is much quieter than Chi-Town's burbs or other slums found around the world. Although the gods are the absolute rulers of the city, most people do not mind their reign, because it is rarely used for oppressive purposes. Many people are fanatically loyal to the Divine Felines and will take offense at any disparaging comments directed at them. Although it is not a crime to speak against the godly rulers of Omagua, people who blaspheme against them may face challenges or even angry mobs.

The majority of the population is **made** up of mutant cats of different species and origin, but there is no bias against any feline being, from sphinxes to **werejaguars**. Other **humanoids** are not treated as well, but there is no overt prejudice or violent racism in Omagua. Non-feline visitors may find themselves snubbed, and merchants may charge them slightly higher prices (5-10% more for the same goods or services). Occasional insults or snide comments may be made by the more militant or embittered felines, but serious altercations are rare. When crimes or disputes occur, the word of a feline is usually taken above members of any other race, especially humans or **kittani**, although the citizenship, reputation, wealth and influence of the parties involved is also taken into account. If a non-feline proves himself to be a decent, friendly person, he will eventually be accepted. There are a number of humans and other non-felines who are trusted and valuable members of Omagua society.

## Foreign Relations

Due to its divine rulers, Omagua has ties with several other dimensions. Sometimes, one of the three gods is involved in a war on another world. Seven times during the last two hundred years, armies from Omagua have used the dimensional portals in the Great Palace's pyramid to travel to far-off worlds where they fight and die in strange lands.

**Manoa:** The two cities try to leave each other alone. When two patrols encounter each other, they tend to exchange insults, a few shots or sword blows, and retreat back to their borders. There is talk of a reconciliation between Manoa and Omagua, but sabotage from Cibola keeps stalling negotiations.

**Cibola:** This slave city is **Omagua's** chief enemy. The standing orders for all **Omaguan** patrols is to capture or destroy any **Cibolan** creature found in the jungle. The Divine Felines are not confident enough to launch a direct attack against the city, because they don't know what *powers* control it — if an evil god or a super-powerful alien intelligence is behind Cibola, an all-out war could destroy everything the gods have worked so hard to achieve.

**The Kingdom of Lagarto:** The rise of the Cult of **Dragonwright** has deeply troubled the Divine Felines. They have enough connections to suspect that this particular version of the cult is a **Splugorth** ploy to expand its influence, and, in any case, the cat gods have little use for dragons. Any armed group of lizard men who enter the Omagua territories is ordered to turn back. If they refuse, they are destroyed. One dragon was killed in a recent skirmish, escalating the likelihood of war.

**Atlantis:** Now that the Kingdom of **Lagarto** has allowed a **Splogorth** outpost on the west bank of the Amazon, slave raids have become more frequent. Lord **Splynncryth** is curious about the rumors of a god-controlled city and wishes to learn more, so he is **sending** spies into Omagua. They include a team of corrupt **Ramen** cat-men, **werejaguars**, and a human slave altered through bio-wizardry to resemble a felinoid. The spies are now hiding in the Kitty Litter, reporting back to the agents in Lagarto and spreading mischief.

## City Highlights

Except for a few trusted merchants who sell their goods to the felinoids and the occasional traveler who accidentally stumbles across it, strangers are seldom brought into the city itself. Omagua stands on top of a hill that was magically created in the middle of the jungle. It is located a half a mile (0.8 km) away from the Amazon River. The city should be clearly visible from above, but nobody has ever been able to locate it from the air. Planes that attempt the trip find themselves thrown miles off course, their instruments go crazy — or they never return. River traffic also passes by the city completely unaware of its existence. This and other strange phenomena suggests that Omagua is not completely on Earth, but in a zone of **transdimensional** instability. Enemies who come too close to the city will find themselves lost in other dimensions, or ravaged by ley line storms, Rift activity and other strange events. According to some **Cibolan** savants, Omagua can only be found in another dimension and is connected to the Earth through a gigantic, eternal Rift. Others compare Omagua to the Yucatan peninsula (see **Rifts Vampire Kingdoms**), a place that is connected to two or more dimensions and not truly a physical part of **any**. Of course, this also serves as a great (natural) defense, making attacks from beings other than dimensional raiders virtually impossible.

**The city** is built of yellow stone brought from another dimension. There are several architectural styles scattered across its neighborhoods. Some are reminiscent of African or Islamic styles, with round cupolas and soft lines, while others more closely resemble the massive stone buildings of the **Incas**, and mixed among them are obelisks and pyramids of Egyptian make.

**The Great Palace:** At the center of the city, on top of the mystic hill, lies the Great Palace, the dwelling of the Divine Felines. This is an imposing structure built around a huge (1000 foot/305 m tall) pyramid, which happens to be on top of a ley line nexus. The whole palace is plated in gold and has jeweled mosaics depicting the Divine Felines and scenes of the founding of the city. A number of statues, triumphal arches and other decorations surround the main building, which looks over a huge courtyard that can fit 100,000 spectators. The Claw Leaders and sometimes the gods themselves address their people in this courtyard from a large gold and jewel encrusted balcony. Magic spells transmit the images from the balcony onto holograph-like projections that appear in many open areas of the city. This allows those who cannot fit in the courtyard to see and hear the speeches as if they were present at the Palace courtyard. Recently, a television system has been installed to broadcast news and public addresses to the whole city and outlying villages, but most people still prefer to gather in the open to see the magical projections, or, if lucky enough, the real thing.

**The Business District:** Felinoids and mutant cats dominate the business and market districts. Delicious and exotic foods, drinks, and a variety of services and common goods can be found in the market. There is a fair share of transdimensional trade going on, but exotic and powerful magical items are almost as rare in Omagua as they are in most North American cities. Technological items made in Colombia or the Silver River Republics can be found at slightly higher prices (10-20% more than normal black market prices). They are usually brought into the city and sold by human and **D-bee** smugglers who have managed to win some trust among the felinoids.

**The Kitty Litter (Slums):** This pejorative term is used for the poorest section of the city, which accounts for one-fifth of the total area. Crime is more commonplace in the Kitty Litter. The police rarely visit and the area is largely distrusted (and avoided) by most of the felinoid inhabitants. **Non-felinoids** who helped found the city or who have found themselves stranded in Omagua end up in the Litter. Most stay because they prefer the squalid living conditions of the slums than the danger and uncertainty of the world outside. The houses in this section tend to be made of cheap brick with wooden supports and are often fire-traps. Many of its inhabitants work on the other side of the law, selling and smuggling drugs, arms and contraband. The authorities suspect that the area is a nest of **Cibolan**, and perhaps **Splogorth**, spies and drug dealers, but for some reason they haven't done anything about it. Even so, there is less crime in the Kitty Litter than in the average cities of Colombia or the Coalition States.

## Mutant Cat R.C.C.

### Optional Player Character

Besides the specific races described below, a large number of other mutant cat species live in Omagua. The Game Master can use the mutant animal creation rules from **Heroes Unlimited** or **Teenage Mutant Ninja Turtles and Other Strangeness** to devise other mutant strains. There is also a section on mutant felines found in **Rifts Vampire Kingdoms**, page 61, and werejaguars on page 172.

## Felinoid R.C.C.

### Jaguar Mutants — An Optional Player Character

Unlike the researchers at the Coalition, the scientists of the Argentine Empire concentrated mostly on one specific strain of cat genes, the South American jaguar. The Achilles Project rounded up thousands of those scarce creatures, nearly destroying the original animal species. The best combination of jaguar and human DNA produced the felinoid race, a viable (that is, one that could reproduce) mutant strain with enhanced, but not supernatural, strength, speed and endurance. The felinoids also developed some minor psionic abilities.

After the odyssey to Omagua, the felinoids became the most numerous species in the city. They have proven to be the backbone of the community, providing artisans, workers and merchants, as well as warriors, leaders and magicians. Unlike their super-powerful mutant cousins, the **felinoids'** personalities are almost completely human, with a few cat-like instincts such as a

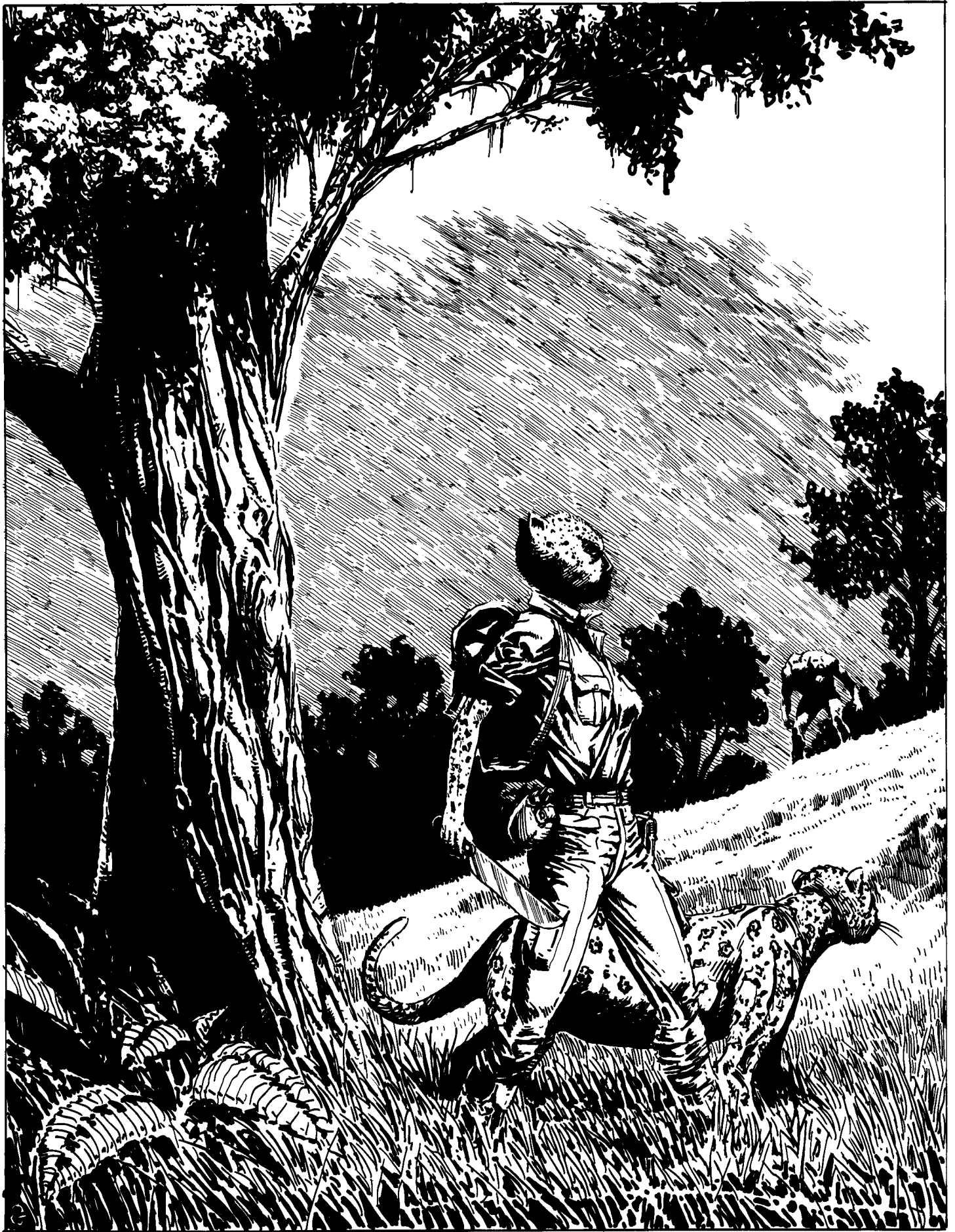

love for taking naps during the day, pouncing on moving objects, a love for hunting and purring when they are happy.

### Felinoids — Mutant Jaguars

**Alignment:** Any

**Horror Factor:** 9 (10 for the larger mutant cats)

**Attributes:** I.Q. 3D6, M.E. 3D6+4, M.A. 3D6, P.S. 4D6+4, P.P. 4D6, P.E. 4D6, P.B. 3D6, Spd 5D6.

**Hit Points:** Standard: P.E. attribute number plus 1D6 per level of experience.

S.D.C.: 1D6X10 S.D.C. plus O.C.C. and skill bonuses.

M.D.C.: Armor or magic only.

**R.C.C. Abilities and Bonuses:** Nightvision 200 feet (61 m), excellent hearing and smell, enhanced strength and reflexes, retractable claws that inflict an extra 1D6 S.D.C. damage in hand to hand combat and fangs that inflict 1D6 S.D.C.; +10% to climbing, and acrobatics skills, +3 feet (0/9 m) on all leaps, and +1 on initiative.

**Psionic Knowledge:** All felinoids are major psionics (see **Rifts RPG**, page 12). They can select a total of eight powers from one category or a total of six powers from any of the three categories: sensitive, physical and/or healer.

I.S.P.: M.E.+1D4X10 plus 1D6+1 per level of experience.

**Magic Knowledge:** None, unless a magic O.C.C. is taken (see below).

**O.C.C.s Among Felinoid Jaguars:** Any except **Coalition/High tech soldiers**, power armor pilots, glitter boy pilots or juicers. Shifters, necromancers, witches and **techno-wizards** are a great rarity among the jaguar mutants. Players can select any Occupational Character Class with the above exceptions, but the most common types are as follows. **Note:** Over 70% of all city dwelling felinoids belong to "civilian," non-combat oriented O.C.C.s like merchant, artist, farmer, laborer, healer, scholar and teacher. The following list are O.C.C.s typical of *adventuring* felinoids.

21% Wilderness scouts

20% **Headhunters/Mercenary/Special Forces**

8% Priests (The Divine Felines Pantheon)

6% Mind melters

5% Mystics

5% Ley line walkers

5% Warlocks (any element)

5% Biomancers

5% Totem warriors (Jaguar only)

5% Sailor or Pirate

5% City rats

10% Other

Average Size: 5 to 7 feet (1.5 to 2.1 m) tall.

**Average Weight:** 140 to 220 lbs (63 to 99 kg).

**Appearance:** Most felinoids of Omagua are bipedal **humanoids** with varying degrees of human features and abilities. 75% of all felinoids are mutant jaguars covered with leopard-like spots over yellow or light brown fur; **other** colorations are possible, but rare. Jaguar felinoids tend to be five to six feet tall (1.5 to 1.8 m), while many of the other mutant species created by Project Achilles tend to be larger; typically six and a half to seven and a half feet (1.95 to 2.25 m), and the tiger is the largest.

The larger cats include the **African lion**: 7%; second largest next to the tiger; add 2D6 to P.S. and speed but reduce

I.Q. by 1D4. **African leopard**: 5%; add 1D6 to P.P. and speed but reduce M.E. by 1D6. **North American mountain lion/puma/cougar**: 5%; add 1D6 to P.P. and P.E. but reduce M.A. by 1D4. The **tiger**: 3%; the largest of the cats (7 to 8 feet/2.1 to 2.4 m); add 2D6 to P.S. and P.E. but reduce speed by 1D6.

Small, mutant South American cats include the **ocelots, serval, and caracal (lynx family)**: 3%; rarely exceed 5 feet (1.5 m); same stats as the jaguar but reduce M.E., P.S., and speed by 1D6 — 2% other.

Note: This description applies only to the *felinoid mutant* population and does not include **Ra-men, werejaguars** and other **D-bee** felines who inhabit Omagua and other parts of South America.

**Standard Equipment:** Varies with the O.C.C. selected. The city of Omagua has limited high technology obtained through **transdimensional** trade, so the Game Master has to rule as to what is available.

Adventurers and scouts will have the types of equipment needed for jungle travel and exploration, such as a backpack, sleeping bag, canteen, machete, and a **sidearm**. It's interesting to note that most of the mutant cats seem to have an instinctive attraction to blade weapons, particularly **Kittani** plasma swords and **vibro-blades**. Magic blades are rare and coveted. Remember, these creatures are **humanoid**.

**Money:** Varies with O.C.C.

**Cybernetics:** Starts with none. There are no cybernetic facilities in Omagua, not even in the Kitty Litter slums. Most Felinoids will disdain cybernetic, bionic, chemical and bio-wizard enhancements. This applies even to O.C.C.s that might normally allow cybernetics.

Note: The "Jaguar People" are *werejaguars*. They inhabit the jungles of the Yucatan, Central America and South America. Jaguar felinoids are occasionally mistaken for jaguar **werebeasts** (see **Rifts Vampire Kingdoms** for more details about werejaguars and other beings).

## Flying Tiger R.C.C.

### Optional Player Character

This unique mutant strain was accidentally discovered by Argentinean gene-engineers who were trying to isolate psychokinetic genes. Some of the mutant cats were able to levitate themselves and even fly at low speeds and altitudes. Encouraged, the scientists added some genetic material from bats to the mixture, and developed a mutant race of cats who could propel themselves telekinetically while using their bio-grown wings to maneuver!

The flying tigers developed a number of amazing powers; not only could they fly, they could protect themselves with a telekinetic force field and project bolts of force, much like the super-powerful hunter R.C.C. With the Coming of the Rifts, these powers have increased a hundredfold. The flying tigers are able to achieve incredible speeds in the air, and can engage in airborne acrobatics and maneuvers superior to most humans in a jet pack or flying power armor.

These mutants serve as the Air Force of Omagua. All flying tigers are trained in combat and are expected to be on call as **mi-**

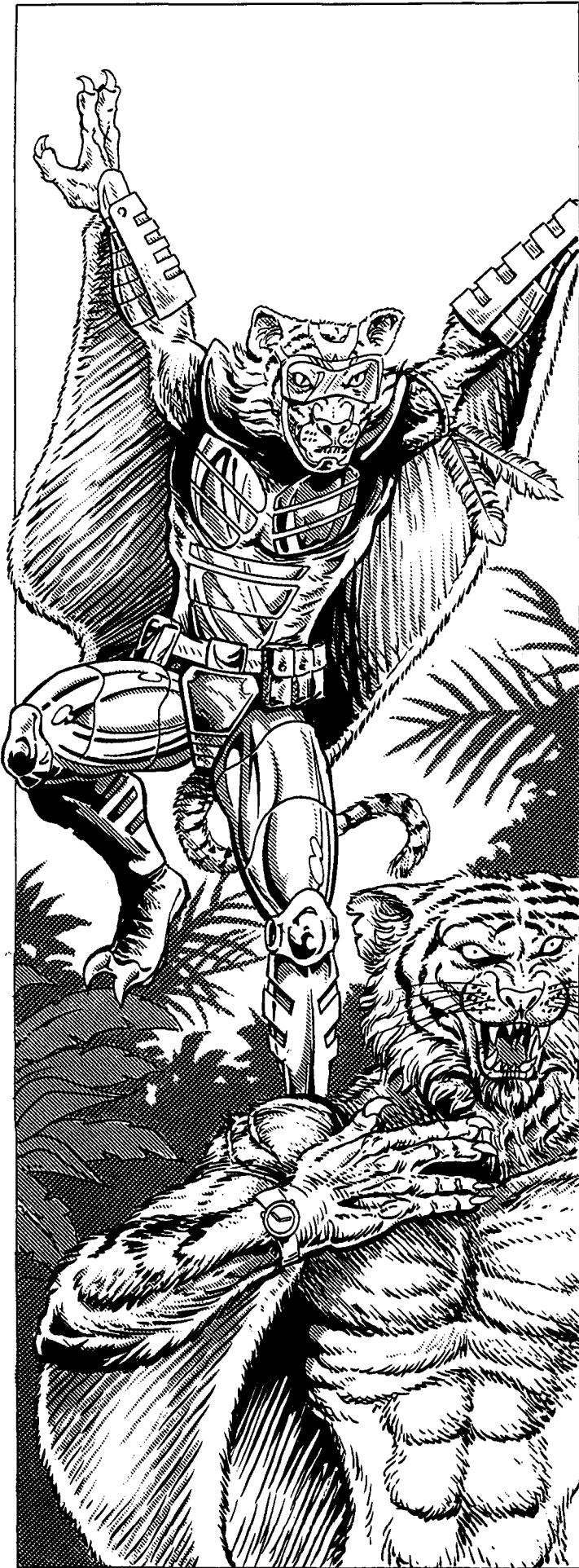

KEVIN SIEMBIEDA 94

litia men. Many serve in the army full time and the rest are in the Omaguan equivalent of the National Guard and can be called into service in an emergency.

**Alignment:** Any.

**Horror Factor:** 10

**Attributes:** I.Q. 3D6, M.E. 3D6+6, M.A. 3D6, P.S. 4D6+4, P.P. 3D6+6, P.E. 3D6+4, P.B. 3D6, Spd 5D6 on the ground; also see flying powers and bonuses, below. The flying tigers are not as physically powerful as other mutant tigers and cats, but make up for it with their psionic powers.

**Hit Points:** P.E.x2 plus 1D6 per level.

**S.D.C.:** 1D6X100 S.D.C.

**M.D.C.:** Psionic Force Field: 90 plus 10 M.D.C. per level.

**R.C.C. Abilities and Bonuses:**

1. **Supersonic Right:** The flying tigers can achieve the speed of sound, **Mach One** (approximately 670 mph, about 11 miles per minute or one mile every 5 seconds - 1070km per hour, 18 km per minute, 1 km every 3.5 seconds). See bonuses. The use of this power is an automatic **psi-ability** that costs no I.S.P.

2. **Nightvision and Superior Vision:** Can see in the dark 1000 feet (305 m) and has hawk-like vision; see bonuses for initiative.

3. **Psionic Force Field:** By spending 10 I.S.P., the Flying Tiger can generate a force field that protects with 90 M.D.C. plus 10 M.D.C. per level of experience! Furthermore, while this force field is on, the flying tiger's hand to hand attacks inflict M.D.C. damage use normal, S.D.C. damage and P.S. bonuses, but now they inflict M.D.C. The field lasts four minutes per level of experience.

4. **Psionic Force Blasts:** By spending 5 I.S.P., the flying tiger can fire psychokinetic energy bolts that inflict 3D6 M.D. at level one, plus 1D6 M.D. per additional level of experience. Range: 800 feet (244 m). By concentrating, the character can elect to fire S.D.C. damage bolts but the I.S.P. cost is unchanged.

5. **Other Psionic Powers:** Considered to be a master psionic, but major powers are limited to those described in this section. The character can select a total of eight powers from the healing, sensitive or physical categories. I.S.P.: M.E. attribute number plus 2D4X10. The character gets another 10 I.S.P. for each additional level of experience.

6. **Bonuses:** +2 on initiative (in the air and on the ground), one extra attack per melee in addition to hand to hand bonuses, +1 to save versus psionics, +1 to save versus magic. When in flight, the character gets an additional +1 on initiative, +2 to strike and parry, and +5 to dodge; these bonuses don't apply when on the ground.

**R.C.C. Skills:** The flying tigers of Omagua all undergo military training and learn the following skills:

Basic Math (+20%)

Lore: Demons and Monsters (+10%)

Language: Spanish (+30%)

Language: Ancient Egyptian (+30%)

One Language of choice (+15%)

Land Navigation (+20%)

Tracking: Humans and Monsters (+15%)

Tracking: Animals (+10%)

Wilderness Survival (+10%)

Acrobatics (+10%)

Prowl (+15%)  
W.P. Energy Rifle  
W.P. two of choice

**Hand to Hand:** Expert

Hand to Hand: Expert can be changed to martial arts (or assassin if evil) at the cost of one "other" skill.

**R.C.C. Related Skills:** Select four "other" skills, plus select one additional skill at levels three, seven, eleven and fifteen. All new skills start at level one proficiency.

Communications: Any (+10%)

Domestic: Any (+5%)

Electrical: Any

Espionage: Any (+5%)

Mechanical: None

Medical: First aid and holistic medicine only (+5%)

Military: None

Physical: Any

Pilot: Any (+10%); except power armor and robots.

Pilot Related: Any (+5%)

Rogue: Any

Science: Astronomy only (+5%)

Technical: Any (+5%)

W.P.: Any

Wilderness: Any (+5%)

**Secondary Skills:** The character also gets to select four secondary skills, excluding those marked "None," plus select an additional two skills at levels two, four, eight, and twelve. These are additional areas of knowledge that do not get the advantage of the bonus listed in parentheses, All secondary skills start at base skill level.

**Size:** Six to eight feet (1.8 to 2.4 m) tall.

**Weight:** 180 to 220 lbs (81 to 99 kg).

**Appearance:** 60% are mutant tigers with flaps of skin below their forearms similar to those of a flying squirrel. The other 40% are mutant jaguars with the same flying squirrel membrane.

**Standard Equipment:** Custom-fitted cat warrior body armor (M.D.C. 60) that allows for their underarm membrane and maximum movement. They also get an energy weapon of choice, four extra E-clips, one archaic weapon of choice (usually a sword), first-aid kit, backpack, basic survival equipment, mess kit, and clothing.

**Money:** 1D6×1000 credits and 2D4×1000 credits in barter items.

**Cybernetics:** Never get any.

## Flame Panther R.C.C.

### Optional Player Character

The flame panthers are the result of a peculiar mutant strain that developed pyrokinetic abilities. The mutation could not be reproduced by the Achilles Project and the flame panthers became a unique race, one that became ultra-powerful in the P.P.E. charged environment of Rifts Earth.

Before the Coming of the Rifts, the red-haired felinoids had pyrokinetic powers roughly equivalent to the Burster (although unable to create mega-damage flames). Now, however, they are super-pyrokinetic beings, able to surround themselves with an aura of flame and shoot blasts of plasma energy. They can even

propel themselves over short distances by triggering controlled flame explosions behind them! These "rocket jumps" give the illusion of flight.

Due to their powers, most flame panthers are dedicated warriors, much like their cousins, the hunter cats and flying tigers. They are trained from early childhood to fulfill the role of warrior and defender — most are fanatically dedicated to the protection of Omagua and intelligent felines in general. Their incredible flame powers make them feared by most jungle dwellers and even many felinoids. A squad of (6 to 10) flame

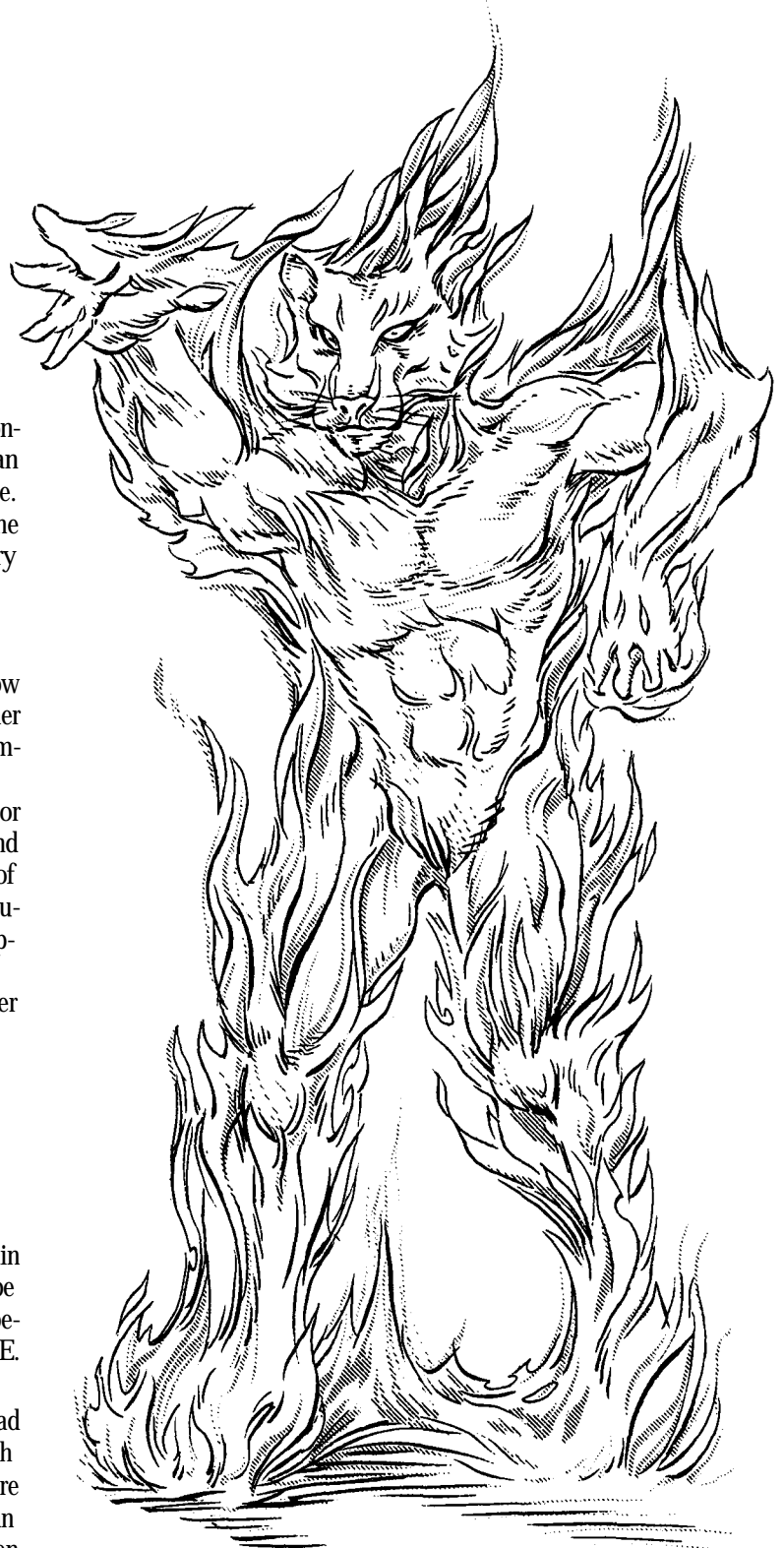

KEVIN SIEMBIEDA '94



panthers can destroy an ordinary village in a matter of minutes. On the other hand, flame panthers also have the power to extinguish fires at will, making them the ultimate firemen — in every sense of the word.

**Alignment: Any**

**Horror Factor:** 14 when surrounded by flame aura; ordinarily 9.

**Attributes:** I.Q. 3D6, M.E. 4D6, M.A. 3D4, P.S. 3D6+3, P.P. 3D6+4, P.E. 3D6+4, P.B. 3D6, Spd 3D6.

**Hit Points:** P.E.x2 plus 1D6 per level of experience.  
S.D.C.: 1D4X100+100S.D.C.

M.D.C.: Flame Aura: 70 M.D.C. plus 10 M.D.C. per level of experience.

**R.C.C. Abilities and Bonuses:**

1. Impervious to fire and heat: Works just like the burster power, rendering the flame panther invulnerable to fire and heat. Mega-damage plasma, napalm and magic fires do one-tenth damage. Electricity does half damage. Automatic; no I.S.P. cost.

2. Extinguish Fires: The power to instantly put out flames without the need of chemicals or water. The fire just disappears. Range: 100 feet (30.5 m) plus 10 feet (3.0 m) per level of experience. Area affected: 10 foot (3.0 m) radius per level of experience. I.S.P. Cost: 4

3. Flame Aura: The panther can surround itself with an aura of **psychokinetic** flame. While surrounded by that aura, the character is protected from all forms of physical and energy attacks. The aura offers protection of 70 M.D.C. plus 10 M.D.C. per level of experience. While the aura is on, the character's touch (or punches and kick) will inflict 4D6 M.D. of flame damage. I.S.P. Cost: 10. Lasts one minute (4 melees) per level of experience.

4. Flame Bolt: A blast of superheated plasma that does massive damage, plus it will ignite **flammables** and start fires. Mega-damage: 4D6 M.D. plus add 1D6 M.D. at levels three, five, seven, nine, eleven, thirteen and fifteen. Range: 1000 feet (305 m). The cat is also +1 to strike with the flame bolt. I.S.P. Cost: 10per bolt.

5. Rocket Jump: By firing a controlled flame discharge behind him, a flame panther can launch himself over great distances, up to 200 feet (61.0 m) plus 50 feet (15.2 m) per level of experience. The character cannot steer while in flight, so once he takes off, he travels in a fixed arc towards the targeted area, just like a bullet. Just before landing, another flame discharge acts as a brake to slow his descent and impact. Sudden stops are impossible and rocketing into an opponent, opening or at a specific, small target is difficult (3 to strike); typically lands within 1-10 feet (0.3 to 3.0 m) of the desired landing **area/target**. Anybody in either the **takeoff** or landing area will take 2D4 M.D. from the flame discharges. I.S.P. Cost: 2 per discharge.

6. Sense Fire: Identical to the burster power (see **Rifts RPG**, page 103).

7. Other Psionic Powers: The character can select three powers from each: sensitive, healing and physical categories.

I.S.P.: M.E. attribute plus 3D4X10 I.S.P., plus an extra 10 I.S.P. per level of experience. Considered to be a master psionic, but the majority of the character's powers are pyrokinetic as described.

**R.C.C. Skills:**

Basic Math (+10%)

Lore: Demons and Monsters (+10%)

Language: Spanish (+30%)

Language: Ancient Egyptian (+30%)

One Language of choice (+10%)

Land Navigation (+10%)

Tracking: Humans and Monsters (+15%)

First Aid (+15%)

Wilderness Survival (+10%)

Prowl (+10%)

W.P. Energy Rifle

W.P. two of choice

Hand to Hand: Expert

Hand to Hand: Expert can be changed to martial arts at the cost of one "other" skill.

**R.C.C. Related Skills:** Select four "other" skills, plus select one additional skill at levels three, seven, eleven and fifteen. All new skills start at level one proficiency.

Communications: Any (+10%)

Domestic: Any

Electrical: Any

Espionage: Any (+5%)

Mechanical: None

Medical: Holistic medicine only (+5%)

Military: Any

Physical: Any

Pilot: Any (+10%)

Pilot Related: Any

Rogue: Any (+5%)

Science: None

Technical: Any (+5%)

W.P.: Any.

Wilderness: Any (+5%)

**Secondary Skills:** The character also gets to select four secondary skills, excluding those marked "None," plus select an additional two skills at levels two, four, eight, and twelve. There are additional areas of knowledge that do not get the advantage of the bonus listed in parentheses. All secondary skills start at base skill level.

**Size:** 6 to 7 feet tall (1.8 to 2.1 m)

**Weight:** 300 lbs (135 kg).

**Appearance:** A felinoid with reddish-brown fur and either spots or stripes.

**Standard Equipment:** An energy rifle (equivalent to a **Wilk's** laser rifle) or a Colombian rocket rifle, a blade weapon of choice, light M.D.C. body armor (1D4X10+10 M.D.C.), survival kit.

**Money:** Starts with 1D4X1000credits in salable articles.

**Cybernetics:** Never gets any.



## Hunter Cat R.C.C.

### Optional Player Character

The Hunter was the ultimate success of the Achilles Project, the toughest, fastest, most savage killing machine the bio-engineers could manufacture. Hunter Cats were the final result of splicing and mixing the genes of Bengal tigers, South American jaguars, gorillas and humans. Experimental techniques increased the healing factor of the creature by two orders of magnitude, and the tensile strength of its muscle tissue by a factor of five. The physical abilities of the hunter cats far surpassed even the wildest hopes of the researchers. Further tests revealed that some of their incredible abilities were not physical, but psionic in nature.

This discovery scared many of the scientists at Project Achilles. The project director even advised that all hunter cats be destroyed. The Argentinean government denied the request, because the potential of this warrior race outweighed any dangers. Further research showed that a number of psionic "superpowers" were available to them, making the cat a match for a human in power armor, even when fighting bare-handed! Yet despite their incredible power, the hunters were not perfect. The cats possessed an intense hunting and killing instinct that was difficult to control. The warrior cats lived for the thrill of the hunt — and savored each kill. They felt alive only when stalking or killing an enemy. Their blood lust too often overpowered their sense of reason, turning them into mindless, merciless monsters. The Achilles Project had made their killing machines a little too well.

With the Coming of the Rifts, the psionic powers of the hunter cats became even more powerful, giving them supernatural power and making them even more aggressive. At Omagua, these predators have been both an asset and a problem. Most of them serve Omagua faithfully as the city's protectors, but once in a while one of them goes berserk and causes some mayhem, rampaging wildly and attacking people (usually non-felines) without provocation. Fortunately, Oracle Cats can help calm and control the hunters, but not always. Some become murderers, serial killers, bandit lords, and all sorts of villains. Other renegades may become unreasoning, feral monsters who live in the wild like an animal, but hunt and kill for the sheer pleasure. These feral monsters usually select a particular territory (50 mile/80 km area) as its domain and slaughters all trespassers. Worst is the hunter cat of an evil alignment who turns completely rogue, but retains its calm and intellect. These beasts often become the assassin, warlord or partner with witches, necromancers, vampires, demons and even evil gods and godlings.

**Alignment:** Any, but lean towards selfish or evil alignments; very few hunter cats overcome their killer instincts enough to be considered to be of a good alignment.

**Horror Factor:** 12

**Attributes:** I.Q. 3D6, M.E. 3D6, M.A. 2D6, P.S. 5D6+12, P.P. 3D6+8, P.E. 4D6+6, P.B. 4D6, Spd 2D6X10. Supernatural strength and endurance. Note: The I.Q. drops 50% if the character becomes feral.

**Hit Points:** P.E.x5, plus 2D6 per level of experience.

S.D.C. 4D6X100 S.D.C. plus any skill bonuses. This huge amount of S.D.C. means that the hunter can survive minor mega-damage better than any of his brothers. Remember, one M.D. point is equivalent to 100 S.D.C.

M.D.C.: Psionic force field provides 150 M.D.C. plus 10 M.D.C. per level — described in the R.C.C. Abilities and Bonuses that follow.

#### R.C.C. Abilities and Bonuses:

- Supernatural strength:** The hunter cat's strength is partially psionic in nature. As a result, in P.P.E. rich environments it is considered supernatural, able to inflict M.D.C. damage with punches and kicks. See **Rifts Conversion Book One**, page 22, for a damage listing from supernatural strength.

- Bio-regeneration:** Very similar to the Crazy's power (see **Rifts RPG**, page 56), but even more powerful. The hunter must do nothing but meditate for the power to work. Every minute of meditation will restore 1D4X10 S.D.C., 4D6

hit points and will close wounds and knit bones in a matter of 1D4 minutes. The bio-regeneration automatically kicks in whenever the hunter cat is knocked unconscious **and/or** at zero hit points or below. The character is also +30% to save vs coma and death, in addition to P.E. bonuses.

3. **Psionic Force Field:** By spending 10 I.S.P., the hunter cat can create a force field around him that offers 150 M.D.C. of protection plus 10 M.D.C. per level of experience. This field only protects the character and cannot be extended to protect others. Duration: 10 minutes per level of experience.

4. **Psionic Force Blasts:** By spending 5 I.S.P., the Hunter Cat can fire psychokinetic energy bolts that inflict 3D4 M.D. at level one, plus 1D4 M.D. per additional level of experience. Range: 500 feet (152 m).

5. **Killing Frenzy:** Hunter cats sometimes lose control and become berserkers who cannot distinguish between friend and foe. In any situation where the Game Master thinks the cat can lose his temper, the character must make a save to control himself (add M.E. bonuses). Depending on the stress level of recent situations, the character can be set-off by a verbal provocation, argument or brawl. More likely, the character will become a berserker upon seeing or failing to prevent some tragedy, such as witnessing a loved ones death or some other traumatic occurrence. During the killing frenzy, the character first attacks those responsible/who angered/outraged him, followed by anyone who tries to attack or hinder him, and finally any living thing within his reach; pretty much in that order.

During such an emotional episode, nobody is safe. While enraged, the hunter cat is +10 to P.S. and +1 to strike, parry and dodge and the force field automatically activates, provided he has enough I.S.P. to power it. The character will calm down 1D6 melee rounds after a battle (often just standing in the middle of the carnage panting, roaring, and attacking any who get too close or dare to challenge him), or when 2D4 minutes have passed, whichever comes first. Only oracle cats, **simvan** and psychic sensitives (with empathy) can calm the berserker down more rapidly or help to curb the emotions before they erupt through soothing words and psionics. **Note:** The empathic transmission power has a chance of snapping the hunter from a berserker rage but he is +5 to save. The simvan monster rider, with their natural ability to soothe and control animals, can stop or prevent the deadly outburst similar to an oracle cat, but the berserker is +3 to save.

6. **Other Psionic Powers:** The cat is considered to be a master psionic. In addition to the powers listed here, he can select 1D4+1 powers from the physical psionic category and 1D4 from the super category. I.S.P.: M.E. attribute plus 2D6X10. The character gets another 10 I.S.P. for each additional level of experience.

7. **Retractable Claws (fingers and toes):** Adds 1D6 M.D. to raking claw attacks and +10% to climb.

8. **Bonuses:** +2 on initiative (triple during frenzy), one extra attack per melee round, +2 to strike, parry and dodge, +4 to pull punch (gone during frenzy), +4 to save vs horror factor (triple during frenzy), +2 to save versus psionics, +2 to save versus magic. All in addition to attribute and skill bonuses.

### **R.C.C. Skills:**

Basic Math (+10%)

Lore: Demons and Monsters (+10%)

Language: Spanish (+30%)

Language: Ancient Egyptian (+30%)

One Language of choice (+10%)

Land Navigation (+10%)

Tracking: Humans and Monsters (+20%)

Tracking: Animals (+20%)

Wilderness Survival (+15%)

Prowl (+15%)

W.P. Energy Rifle

W.P. two of choice

Hand to Hand: Martial Arts or Assassin (if evil).

**R.C.C. Related Skills:** Select four "other" skills, plus select one additional skill at levels three, seven, eleven and fifteen. All new skills start at level one proficiency.

Communications: Any (+5%)

Domestic: Any (+5%)

Electrical: Any

Espionage: Any (+5%)

Mechanical: None

Medical: First aid and holistic medicine only (+5%)

Military: None

Physical: Any

Pilot: Any (+5%)

Pilot Related: Any

Rogue: Any (+6%)

Science: None

Technical: Any (+5%)

W.P.: Any

Wilderness: Any (+10%)

**Secondary Skills:** The character also gets to select four secondary skills, excluding those marked "None," plus select an additional two skills at levels two, four, eight, and twelve. These are additional areas of knowledge that do not get the advantage of the bonus listed in parentheses. All secondary skills start at base skill level.

**Size:** 6 to 8 feet tall (1.8 to 2.4 m).

**Weight:** 300 to 600 lbs (140 to 270 kg); all muscle.

**Appearance:** A heavily muscled, spotted or striped felineid with overdeveloped arms, shoulders and upper torso.

**Standard Equipment:** An energy rifle (equivalent to a **Wilk's** laser rifle) or a Colombian rocket rifle, blade weapon of choice, heavy cat warrior armor (M.D.C. 90), and survival kit.

**Money:** Starts with 1D4X1000 credits in salable articles.

**Cybernetics:** Never gets any.

## **Oracle Cat R.C.C. Optional Player Character**

The descendants of Zee and the rest of the ZB-23 genetic batch are commonly known as oracle cats. Their appearance is almost cartoonish, with oversized heads, small furry bodies and round innocent eyes that make humans think of cuddly, stuffed animal toys. Their inoffensive appearance belies their incredible psionic power. The oracle cats have several super-powers, including the ability to get glimpses of future events, read minds

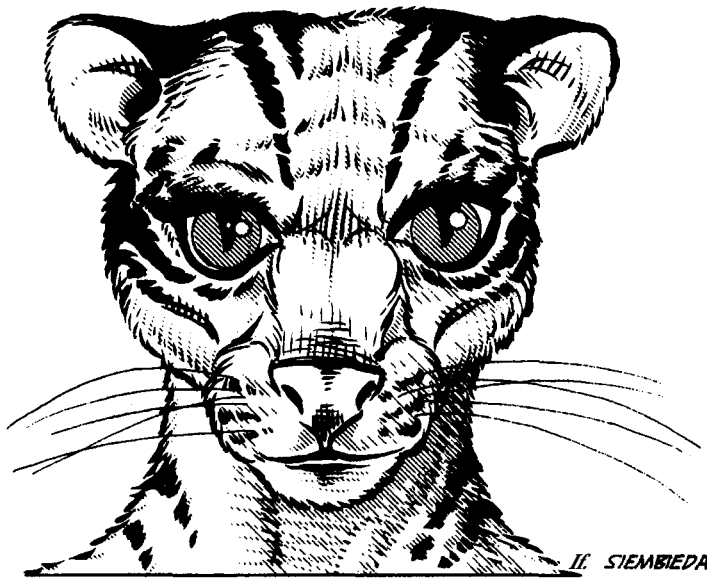

and calm down berserk animals and monsters, including the hunter cats.

Non-player characters can be war leaders, military advisors, paramedics, doctors, judges, spies, and security officers. A few of these toy-like creatures grow to become vicious criminals, but the vast majority are pillars of the community, and the most respected felinoid race inside the city.

A few oracle cats have also become priests of the Divine Felines, increasing their powers and influence even more. The Divine Oracles, as they are called, have both psionic and clerical powers (but gain levels much more slowly, due to the dedication they must put into the disciplines of both mind and religion; takes twice as long as the oracle cat R.C.C.). They are considered great saints and chosen leaders. The Divine Oracles only participate in the most important missions and are often sent through the Megaverse carrying out the orders of their godly patrons.

**Alignment:** Any, but lean towards good or selfish.

**Horror Factor:** None

**Attributes:** I.Q. 3D6+8, M.E. 4D6+6, M.A. 3D6+6, P.S. 2D6, P.P. 4D6, P.E. 3D6, P.B. 4D6, Spd 4D6.

**Hit Points:** P.E. plus 1D6 per level of experience.

**S.D.C.:** 1D4X10 S.D.C. plus those gained through skills.

**M.D.C.:** Psionic force field: 10 M.D.C. per level of experience.

**P.P.E.:** 2D6

**R.C.C. Abilities and Bonuses:**

1. **Inborn Powers:** All oracle cats have the following psionic powers at level one: Clairvoyance, empathy, presence sense, see the invisible, mind block, sense magic, telepathy and empathic transmission. I.S.P.: M.E. attribute plus 4D6X10. Add 10 I.S.P. per additional level of experience. Considered a master psionic.

2. **Psionic Force Field:** Oracle cats can create a force field of psionic energy, just like the hunter cats, but much weaker: 10 M.D.C. per level of experience. Activating the force field costs 10 I.S.P., and it lasts one minute per level of experience.

3. **Aura of Peace:** The cats can project a powerful tele-empathic wave that neutralizes all emotions of anger, hatred and fear. This wave affects animals, monsters and intelligent creatures, removing those emotions from characters who have lost control due to anger, berserker rage, horror factor/fear or a

hysterical state. The saving throw is standard, except for berserkers and people who are completely overwhelmed by insanity, rage or fear; they save at +2! Note that characters engaged in combat may continue to do so, but they will no longer fight clouded by a frenzy, hate or fear and will show some measure of self-control and mercy.

4. **Additional Psionic Powers:** At every level starting with the second, the character can select two powers from the sensitive, physical or healing categories, or one from the super category. After reaching fifth level, the character can pick any two powers from any lesser category plus a super psionic power.

**R.C.C. Skills:** The list below is for typical oracle cats. Divine Oracles use the skills for the Priest O.C.C. (see **Rifts Conversion Book Two**).

Basic and Advanced Math (+20%)

Lore: Demons and Monsters (+20%)

Language: Spanish (+30%)

Language: Ancient Egyptian (+30%)

One Language of choice (+15%)

Literacy (+10%)

Paramedic (+20%)

W.P. Energy Rifle

W.P. two of choice

Hand to Hand: Martial Arts or Assassin (if evil).

**R.C.C. Related Skills:** Select six "other" skills, plus select one additional skill at levels three, five, seven, eleven and fifteen.

All new skills start at level one proficiency.

Communications: Any (+5%)

Domestic: Any (+5%)

Electrical: Any

Espionage: Any (+5%)

Mechanical: None

Medical: Any (+15%)

Military: None

Physical: Any, except boxing and wrestling

Pilot: Any (+10%)

Pilot Related: Any

Rogue: Any (+2%)

Science: Astronomy only.

Technical: Any (+10%)

W.P.: Any

Wilderness: Any (+10%)

**Secondary Skills:** The character also gets to select four secondary skills, excluding those marked "None," plus select an additional two skills at levels two, four, eight, and twelve. There are additional areas of knowledge that do not get the advantage of the bonus listed in parentheses. All secondary skills start at base skill level.

**Size:** 4 to 5 feet (1.2 to 1.5 m) tall.

**Weight:** 50 to 100 lbs (22.5 to 45 kg).

**Standard Equipment:** Custom-made light M.D.C. body armor (30 M.D.C.), one light energy weapon, one TW weapon of choice, assorted survival equipment. Wears little in the way of clothing, unless adventuring.

**Money:** 2D6X1000 in salable items.

**Cybernetics:** None; avoids them like the plague.



## The Sekhmet

### Optional Player Character

The Sekhmet are named after an Egyptian feline goddess, a sister of Bast, who is said to have created (or discovered) their race. The Children of Sekhmet, as they are also known, are lion-headed **humanoids** somewhat similar to the **Ramen** (see **Rifts Africa**), although not quite as gigantic. The Sekhmet have been the servants of many feline gods, including **Simba** (see below). The African lion-god was venerated in several dimensions dominated by these beings.

The **sekhmet** are a race of warriors and hunters. They prefer to travel in war bands of 12 to 100 members, divided into smaller groups of 4 to 6 individuals called prides. The war bands lead a semi-nomadic lifestyle, preferring to live off the land as hunters or working as mercenaries (and in some places, marauders and bandits). Sekhmet children are taught to fight and track prey from the moment they are old enough to walk. The prides have initiation rites for adolescence known as the Coming of Age, adulthood, the Time of the Warrior, and, for a select few, the rank of Pride Leader, the Time of Choosing. These initiation rites are dangerous and would seem vicious to outsiders, but the Sekhmet believe they are necessary to remove the weak or unlucky from the rest of the band. **The Coming of Age** ceremony also creates a link with the supernatural that enables the character to instinctively learn magic, just like a mystic or a priest.

The Children of Sekhmet have fought against (and occasionally with) many evil deities and supernatural monsters in divine wars that flare up across the **Megaverse**. Past enemies have included a host of demons, devils, gargoyles, vampires, the **Splurgorth**, True **Atlanteans**, **Ramen**, **Tautons** and countless other races.

The god Simba has let it be known that Omagua can be used as a safe haven for all sekhmet. Currently, over 50,000 of these creatures have settled in the city permanently, and thousands more come and go every day. Most are in the service of the Pantheons of Light, or in search of heroic adventure. In Omagua, the local sekhmet have learned to respect both the **werebeasts** and the mutant felinoids who live alongside them. Mixed war-bands or smaller prides will frequently contain the members of several different feline races, mortal and superhuman. Note to G.M.s: Such a group could be composed entirely of player characters sent on missions to other lands or worlds by their leaders at Omagua or from Simba, or they could be heroes in search of adventure and glory. Such a group could make an interesting campaign focus.

**Alignment:** Any, but most lean toward good and selfish.

**Horror Factor:** 12

**Attributes:** I.Q. 3D6, M.E. 3D6, M.A. 3D6, P.S. 4D6+10, P.P. 3D6+4, P.E. 4D6+4, P.B. 3D6, Spd 4D6; supernatural strength and endurance.

M.D.C.: 3D6X10 M.D.C., plus 2D6 per level of experience.

**R.C.C. Abilities and Bonuses:** Nightvision 200 feet (61 m), keen vision, regeneration 1D6X10M.D.C. every hour. +1 on initiative, +2 to strike, +1 to parry and dodge, +1 to pull punch, +1 to roll with impact, +1 to save vs magic and psionics, and +5 to save vs horror factor.

**Magic Knowledge:** Pick four spells from levels 1-3 at level one, and one additional spell every level after that. The spells are learned through mystical enlightenment. New spells, besides those acquired at first level, cannot exceed the character's current level of experience.

P.P.E.: P.E. attribute plus 2D6X10, plus 2D6 per level of experience.

**Psionic Knowledge:** Considered a minor psionic. Select four psionic powers from either the healing or physical categories.

I.S.P.: M.E. attribute number plus 1D4X10, and an additional 1D6 per level of experience.

#### R.C.C. Skills:

Basic Math (+15%)

Ancient Egyptian (+20%)

Dragonese/Elf (+15%)

One language of choice (+15%)

Track Animals (+20%)

Track Humans/Monsters (+15%)

Wilderness Survival (+20%)

Detect Ambush (+10%)

Swim (+10%)

Two W.P.s of choice

Hand to Hand: Expert

Hand to Hand: Expert, can be changed to Martial Arts at the cost of one "other" skill.

**R.C.C. Related Skills:** Select five "other" skills, plus select one additional skill at levels three, five, seven, eleven and fifteen. All new skills start at level one proficiency.

Communications: Any

Domestic: Any (+10%)

Electrical: Any

Espionage: Any (+10%)

Mechanical: Any

Medical: First aid and holistic medicine only.

Military: None  
Physical: Any  
Pilot: Any (+5%)  
Pilot Related: Any  
Rogue: Any  
Science: None  
Technical: Any (+10%)  
W.P.: Any  
Wilderness: Any (+10%)

**Secondary Skills:** The character also gets to select five secondary skills, excluding those marked "None," plus select an additional two skills at levels three, eight, and twelve. These are additional areas of knowledge that do not get the advantage of the bonus listed in parentheses. All secondary skills start at base skill level.

**Size:** 6 to 7 feet (1.8 to 2.1 m)

**Weight:** 300 to 450 lbs (135 to 203 kg).

**Appearance:** Lion-headed humanoids. The rest of the body is human looking, except for a lion's tail.

**Standard Equipment:** Suit of enchanted plate armor (100 M.D.C.), one techno-wizard or energy weapon, survival gear, and food. Most *sekhmet* only wear a loincloth and a cloak at the most.

**Money:** 1D6×1000 in salable items.

**Cybernetics:** Starts with none. May consider getting minor implants, but any major cybernetics risk interfering with the *Sekhmet*'s magic abilities.

## Werejaguars & Werepanthers

### Optional Player Characters

These creatures are fully described in the **Rifts Conversion Book One and Rifts Vampire Kingdoms**. The werejaguars worship the deity known as *Yaguar-Ogui*. The god occasionally calls upon them during times of need.

When Omagua was founded, thousands of these creatures and their werepanther cousins migrated to the city. Most werebeasts in the city are part of the armed forces, which gives them an excuse to go into the jungle and hunt down animals and supernatural monsters. Most of them get along very well with the other feline races, although some degree of rivalry exists between the werejaguars and the impressive hunter cats. Members from both groups often try to outperform the other and in a couple of instances, the rivalry has turned ugly.

### The Werejaguar — Also known as The Jaguar People

**Alignment:** Feline werebeasts are typically anarchist or any evil (occasionally unprincipled) alignments. By comparison, canine werebeasts tend to be evil and only occasionally anarchist.

**Size:** 6 to 7 feet tall in human and humanoid monster form, 5 to 6 feet long in animal form. **Weight:** 200 to 300 lbs (90 to 136 kg).

**Hit Points (Special):** 6D6+10. Like the vampire, the werebeast is invulnerable to most weapons, including mega-damage energy weapons, explosives, bullets, fire, wood, steel, poisons and toxins. However, also like vampires, werebeasts are vulnerable to ordinary silver. Weapons that have at least a 50%

silver content inflict double damage to the supernatural things. Thus a silver-plated dagger, which normally inflicts 1D6 S.D.C. damage, inflicts 2D6 points of damage directly to the monster's hit points. Although werebeasts possess bio-regenerative powers, they are nothing like the vampire's, so being bludgeoned or stabbed by silver can kill the creature without requiring decapitation and staking.

**The Eight Attributes of the Werejaguar:** The number of six-sided dice are indicated as follows: I.Q.: 2D6+2, M.E.: 3D6, M.A.: 4D6, P.S.: 4D6 (never less than 16), P.P.: 4D6 (never less than 16), P.E.: 4D6, P.B.: 4D6, Spd. 6D6

**Experience Level:** Average 1D4, same as *psi-stalker*.

**Natural Abilities:** The abilities listed are specifically for the werejaguar, other werebeasts may differ. Speak while in animal shape, prowl 80%, swim 60%, climb 90%/80%, acrobatics 80%, track by smell 60%, nightvision 300 ft (91.5 m), and bio-regeneration: restores hit points at a rate of 2D6 H.P. an hour.

**Limited invulnerability:** See hit point description. *The creature is vulnerable* to magic, psionic attack and weapons made of *silver* (double damage). *Wolfbay* and garlic will hold all werebeasts at bay like a vampire, but the cross, sunlight and running water have no adverse effect. Powerful mega-damage attacks and explosions that inflict great amounts of damage may knock the creature down or stun it. Same *Knock Down/Impact* table as for vampires.

**Shape-changing power:** The three (3) shapes are human, jaguar, and its natural shape of a jaguar humanoid (half man/half jaguar). Superstitions tell us that a werebeast is human by day and beast by night, but this is not true. The werejaguar can shape-change at will, day or night. The metamorphosis takes about 15 seconds (one melee round) and there is no limit to the number of times the creature can perform a metamorphosis or how long he can maintain that particular shape. The creatures are quite intelligent, thus they generally assume the less frightening form of human during the bright sunlight hours when humans are on the prowl and into monster humanoid form or animal shape during the night. Also since they are nocturnal hunters, they tend to sleep during daylight hours and are most active during the night.

**Horror Factor:** 12 in their natural half man/half beast monster shape. The horror factor does not apply to human form.

**Magic:** All werejaguars can cast the following spells, provided they have enough personal P.P.E. to do so: Tongues, chameleon, astral projection, repel animals, heal wounds, metamorphosis: animal, and metamorphosis: human.

P.P.E.: 2D4X10+10

**Psionic Abilities:** Sixth sense, see the invisible, and mind block. **I.S.P.:** 5D6

**Attacks Per Melee:** Five (5) in natural monster or animal form; two (2) in human shape.

**Damage:**

Claws do 1D6 S.D.C. plus P.S. bonus to damage, bite does 2D6 damage.

Human shape punch — 2D6 S.D.C./H.P.+P.S. bonus.

Restrained claw — 4D6 S.D.C./H.P. + P.S. bonus.

Power claw — 1D6 M.D.C., counts as one attack.

Power punch claw — 3D6 M.D.C., counts as two attacks.



Normal Bite — 2D6 S.D.C.

Power Bite — 1D4 M.D

**Note:** All S.D.C. damage from claws or bite inflict full damage to the hit points of vampires and other **werebeasts**.

**Bonuses:** In addition to probable attribute bonuses, the **werejaguar** is +1 on initiative, +2 to strike, +2 to parry and dodge, +6 to save vs horror factor, +2 to save vs psionics, and +2 to save vs magic.

**Skills:** **Werejaguars** can speak Spanish 98%, land navigation 90%, and can learn a total of seven additional secondary skills at first level and two additional skills at levels three, six, nine, eleven and fourteen. Use the same experience table as the **psi-stalker**. Hit points and skill proficiencies increase with each level; no special skill bonuses unless indicated. Available skill categories include domestic, espionage, science: basic math only, technical: language, lore, and photography only, W.P. any (lean toward ancient), wilderness (any,

+20%), pilot: automobile, motorcycle, hover vehicle, boat, and horsemanship.

**Note:** **Werejaguars** are found throughout Central and South America. They are most numerous in and around Omagua and the Yucatan Peninsula. Most other gatherings are small tribes and villages ranging from a few dozen to about 100 members.

Although myth warns that **werejaguars** are the enemy of man, they usually avoid conflicts with humans, except to defend themselves or their territory. They prey mainly on animals and, on Rifts Earth, other supernatural creatures. In fact, the **werejaguars** are an instinctive enemy of vampires. They enjoy deadly games of sport and delight in the challenging combat offered by vampires, humans, **D-bees** and other intelligent life forms. Like most cats, the fun of recreational hunting is in the stalking, chase, and capture of the prey. Unless a character is a vampire or demon, there is a good chance of being let free after the "cat and mouse" game is over.

## The Divine Felines

### A Triumvirate of Gods

Feline deities have been worshipped by many cultures, both on Earth and in other worlds across the Megaverse. In South America, figurines, amulets and paintings depicting a feline **humanoid** are found among dozens of cultures. These were often representations of the god **Yaguar-Ogui** (sometimes jaguar people worshiped jungle deities or forces of nature). **Yaguar-Ogui** was once worshipped by the inhabitants of the Andes mountain chain, but was eventually replaced by the more powerful **Inca** deities and confined mostly to the less numerous primitive tribes and the **werejaguar** race (which in ancient times referred to itself as the Children of **Yaguar-Ogui**).

The god has become a friend to other cat-gods, including the Egyptian goddess **Bast** and the African Lion Spirit, **Simba**. For

centuries, **Yaguar-Ogui** dreamt of a united coalition of feline gods and all the cat peoples of the Megaverse, but most rebuffed him. **Anhur**, the lion-headed god from the Pantheon of **Taut**, laughed in **Yaguar-Ogui's** face. Even **Bast** and **Simba** did not initially share **Yaguar-Ogui's** belief. It wasn't until thousands of years had passed and **Yaguar-Ogui** had been all but forgotten in South America that an opportunity to make his dream a reality came to pass. He had a prophetic dream in which he saw a city populated by thousands of feline **humanoids**, united in worship of him and two others. Inspired by his vision, the Indian **Jaguar** god contacted his fellow deities. **Bast**, a former member of the Egyptian Pantheon of **Light**, had a quarrel with **Ra** and decided to strike out on her own, so she gladly joined **Yaguar-Ogui** in his scheme. **Simba** agreed because he had hopes of reestablishing his cult in Africa, and believed that **Omagua** would serve as a good stepping stone towards that goal.

The Divine Felines then contacted the psychic mutant cats at the Achilles Project and led them to found a city in the jungle. Their joint powers protected the pilgrims from the calamities of the Great Cataclysm. Later, the gods and their servants joined the mutants in raising the towers of Omagua. With over a million worshippers, the three deities have established a powerful power base in South America.

## Bast Egyptian Cat Goddess

Bast is an ancient Egyptian goddess of light, long associated with the Pantheon of Ra (see Rifts Africa for a full description of Ra and his fellow gods). She was a symbol of happiness and levity. In ancient Egypt, festivals in her name were more like wild parties than religious ceremonies. Although she has long been an enemy of the forces of evil, Bast was always impulsive and spoiled; reflecting her feline nature. On a whim, the goddess had demanded that Ra turn over to her the feline warrior race known as the **Ramen**. She claimed they belonged to her, as goddess of all cat races. Ra quite rightly refused and Bast stormed out of his extra-dimensional palace, withdrawing her support from the Gods of Light.

Even though she is impulsive and selfish, Bast is not evil, and she never considered joining Ra's enemies, the Pantheon of Taut. Instead, when she was contacted by **Yaguar-Ogui**, she wholeheartedly joined in the scheme, pledging her personal army of thousands of Ramen warriors (the few that had chosen to worship her). Her preference for Egyptian culture is evident in the city's architecture, and Egyptian is one of the main tongues of Omagua.

The goddess is endlessly curious. She quickly gets bored inside the city and frequently disappears to go on adventures or exploring. Of the three gods, she is the most likely to be out on some quest or mission. Sometimes she will even accompany a military patrol on combat missions. Her fellow gods frown on this behavior, because she is comparatively vulnerable outside the city (her M.D.C. becomes one-fifth of what it is within Omagua) and if she were killed or captured, the city would suffer a terrible blow to its morale. However, she is quite incorrigible and does as she pleases at least half the time.

**Alignment:** Unprincipled

**Species:** Goddess

**Horror Factor:** 15

**Attributes:** I.Q. 21, M.A. 23, M.E. 18, P.S. 23, P.P. 26, P.E. 20, P.B. 22, Spd. 66; supernatural strength and endurance.

**M.D.C.:** 9,000 in most places; 45,000 inside the Great Palace at Omagua.

**P.P.E.:** 4,000

**Natural Abilities:** Nightvision 1000 feet (305 m), see the invisible, turn invisible at will, **teleport** 89%, dimensional **teleport** 80%, metamorphosis into any cat shape at will, resistant to cold and heat (takes half damage), bio-regenerate **4D6X10** M.D.C. every minute (4 melee rounds).

**Disposition:** She exhibits all the characteristics of a cat, from royal dignity to carefree laziness, from exquisite grace to childish playfulness (with a streak of cruelty). The goddess is generous and friendly towards those she considers her friends. If anyone offends her, she will cut him to ribbons, either figuratively (her sarcasm can be devastating) or literally!





**Experience Level:** 15th level ley line walker, 10th level stone master and mind melter.

**Magic Knowledge:** All spell magic levels 1-15 at 15th level proficiency. All stone magic at 12th level.

**Psionic Powers:** All healing, sensitive and physical powers at 10th level proficiency. I.S.P.: 1,000

**Combat Skills:** Hand to Hand: Expert

**Attacks per Melee:** Five hand to hand attacks per melee or two by magic.

**Bonuses (all):** +2 on initiative, +8 to strike, +11 to parry and dodge, +2 to roll with **impact/punch**, +2 to pull punch, +5 to save vs poison, +5 to save vs magic, +7 to save vs psionics, +10 to save vs horror factor.

**Weapon Proficiencies:** W.P. sword, W.P. blunt, W.P. energy rifle.

**Skills of Note:** All wilderness and domestic skills at 98%, wilderness survival 98%, and is fluent and literate in **Dragonese/Elf**, Ancient Egyptian, Creole, Spanish, American, Euro, **Demongogian** and Portuguese, all at 98%.

**Armor:** Enchanted scale armor: M.D.C. 1,000

**Description:** Usually, a beautiful cat-headed woman in golden vestments. Bast can assume the shape of any feline animal, from the tiniest kitty-cat to a gigantic **sabertooth**; her stats remain unchanged in all forms. Her three favorite shapes: a cat-headed woman with an otherwise fully **humanoid** body; a furry humanoid cat, similar to the intermediate form of a **werejaguar**; and a giant cat. In both the **werejaguar** and giant cat form, the **goddess'** bite inflicts 5D6 M.D.

---

### Special Magic Weapon:

**The Cat's Gauntlet:** A greatest rune weapon, shaped like a silver clawed glove. Bast has been known to give a few of her most loyal followers a lesser version of this gauntlet (reduce damage and spell levels by half).

The powers of the gauntlet:

- I.Q. 10 and has a telepathic link with Bast.
- Indestructible; silver in color.
- Unprincipled alignment: If any creature of evil alignment touches it, they are burnt, suffering 4D6 points of damage.
- Spell Magic: It can cast the following spells as often as three times each per 24 hour period: blinding flash, globe of daylight, cloud of smoke, wall of flame, circle of flame, fire bolt, fire ball, ignite fire, fuel flame and impervious to fire. All are equal to a 12th level warlock.
- Mega-damage: **1D6X10** M.D. when used to claw; double damage to alien intelligences.
- Hooked Spikes: The gauntlet's **three hooked** knuckle spikes can fly out of their housing, remaining connected to the gauntlet by a long chain link. Each knuckle spike does 3D6 M.D., and the victim is snagged and can be pulled towards the wielder (to see if the victim resists, each side rolls a D20 plus their P.S. bonus; the higher total wins the contest). Range: The chain links extend up to 100 feet (30.5 m).

## Yaguar-Ogui the Jaguar South American Feline God

The Jaguar God is an ancient South American deity of hunters and warriors. The strength and speed of the jaguar were said to be his gifts. He was worshipped by the **pre-Inca** civilizations of the continent, as well as the more primitive inland tribes. He is reputed to be the creator of the werejaguar race by mystically uniting a human and a feline. The god was also the enemy of vampires and other undead, including the monstrous **Ellal**.

The rise of the **Inca** gods stole a great deal of power from Yaguar-Ogui. These new, more sophisticated deities and god-ling-kings took over most of the coastal civilizations of the continent and **Yaguar-Ogui's** worship was pushed to the largely uninhabited jungles of the interior. The Jaguar God has never forgiven the Inca deities for this and even refused to help them when they thwarted an invasion that could have threatened the entire planet (more information about the Inca gods, the alien invasion, and the return of the invaders will be available in a **Rifts South America sourcebook/follow-up**). Embittered by the loss of prestige, Yaguar-Ogui turned his back on humankind and devoted himself to his faithful servants, the Jaguar People. He even built a small city in a pocket dimension which he populated with **werejaguars**; occasional sightings of the city through dimensional gates gave rise to more legends of El Dorado. Once a god of great moral strength, his anger has changed him into a less compassionate, more selfish individual.

Now that he has founded a city where felinoids of a dozen races all worship him, Yaguar-Ogui is once again thinking of his human worshippers. There are still many Indian tribes that call upon his name, and many are now suffering at the hands of **Cibola**, **Splugorth**, demons, and the rapidly expanding Kingdom of **Lagarto**. Yaguar-Ogui is making plans to intervene on behalf of his worshippers. **Note:** He regards **Manoa** as potential trouble because he distrusts **Atlanteans**. The god was worshipped when Atlantis sank beneath the waves and the ensuing cataclysm ravaged his domain and seriously reduced his powers, a result of the general weakening of magic on Earth. Yaguar-Ogui blames all Atlanteans for the disaster and will have as little to do with them as possible. This distrust is one of the things that have prevented an agreement between Manoa and Omagua.

**Other Aliases:** Chacha-Puma, El Jaguar

**Alignment:** Unprincipled with anarchistic leanings. Formerly scrupulous.

**Species:** God-level Werejaguar

**Horror Factor:** 17

**Attributes:** I.Q. 21, M.A. 20, M.E. 19, P.S. 32, P.P. 27, P.E. 23, P.B. 20, Spd. 66.

M.D.C.: Special Limited Invulnerability; see below.

**Hit Points:** 3,000 in most places; 15,000 inside the Great Palace in Omagua. Also see special vulnerabilities.

**Natural Abilities:** Nightvision 200 feet (61 m), shift into any of three different shapes (human, a natural half-man, half-beast state, and jaguar) at will, and superhuman vision and hearing, fully equivalent to advanced cybernetic systems. **Teleport** 88%, dimensional **teleport** 65%.

**Invulnerability:** Yaguar-Ogui is a **super-werebeast**. Like all **werebeasts**, he is invulnerable to virtually all weapons, including mega-damage energy weapons, explosives, bullets,



fire, wood, and **poison/drugs**. However, Yaguar-Ogui is vulnerable to ordinary silver, magic and hand to hand attacks from other supernatural creatures (inflict full damage). Even so, he regenerates damage at the rate of **1D4X10 M.D.C.** per melee round.

**Disposition:** Yaguar-Ogui was both the primal nature **god/totem** of primitive nomads and the wise guide and protector of urban, sophisticated civilizations. When involved in a hunt or fight, the god reverts to his animalistic state, attacking savagely and giving no quarter. Often, he will strike from ambush, just like a predator in the wild and he uses those tactics even in more sophisticated battlefields and diplomacy. Yaguar-Ogui loves to surprise his opponents. On the other hand, the Jaguar God is the essence of patience and understanding when conducting city business.

**Experience Level:** 15th level warrior and mystic.

**Magic Knowledge:** Knows all spell magic levels 1-10 plus banishment, mystic portal, wards, **anti** magic cloud, remove curse, summon and control animals, amulet, calm storms, summon entity, time hole, protection circle: superior, summon storm, summon lesser being, sanctum, talisman, close rift, restoration, and dimensional portal.

**P.P.E.:** 2000

**Psionic Powers:** Has all the mystic's abilities plus all sensitive and physical powers, all at 15th level.

**I.S.P.:** 800

**Combat Skills:** Hand to Hand: Martial Arts.

**Attacks per Melee:** Six hand to hand or psionic attacks, or three by magic.

**Bonuses:** +3 on initiative, +8 to strike, +11 to parry and dodge, +3 to roll with **impact/punch**, +3 to pull punch, +10 to save vs poison, +10 to save vs magic, +7 to save vs psionics, +10 to save vs horror factor.

**Weapon Proficiencies:** W.P. Sword

**Weapons:** Rarely uses them, preferring to rely on his natural hand to hand abilities or his magic.

**Armor:** Magical robes: M.D.C. 500

**Skills of Note:** Fluent and literate in Spanish, Creole, American, Gobblely, **Demongogian**, Greek, Ancient Egyptian, Euro and Dragonese/Elf 98%,

**Description:** A stately giant **werejaguar** (12 feet/3.7 m tall), dressed in robes with a leopard pattern and a golden crown. The god rarely assumes his human shape, preferring the half-beast form or the full jaguar shape.

## Simba African Lion God

Simba is an ancient lion god, widely worshipped in many parts of the Megaverse. A warrior god, he was part of a pantheon of animalistic deities, most of whose members have died or disappeared. Some African religions acknowledged him, but he remained a minor totem or spirit guide on Earth. When Yaguar-Ogui made his second offer to Simba (the first entreaty had been ignored), the god was in dire straits, having lost the worship of many worlds to more aggressive gods and alien intelligences. Simba decided he had nothing to lose and helped bring Omagua back to Earth.

From the start, the lion-god has been the least involved in the city's business. Simba has his own plans and Omagua is only a

stepping stone towards bigger and better things. Simba has often used warriors recruited in the city to fight wars in other worlds. Neither Bast nor **Yaguar-Ogui** approve of this, but they don't want to antagonize him. Especially since a war with the other cities of El Dorado seems more likely — his power and knowledge will come in handy. In fact, Simba is eyeing both **Manoa** and **Cibola** with interest. If "his" cat warriors could conquer the two cities, Omagua would become a very powerful center of magic, **transdimensional** travel, and technology. Simba's ambition may lead him to initiate a full-scale invasion of the other cities. Nobody knows this, but a few people (and **Yaguar-Ogui** himself) are starting to suspect his intentions.

**Alignment:** Anarchist

**Species:** God

**Horror Factor:** 16

**Attributes:** I.Q. 18, M.A. 19, M.E. 17, P.S. 52, P.P. 22, P.E. 30, P.B. 17, Spd. 88.

M.D.C.: 8500, or 42,500 in the Great Palace in Omagua.

P.P.E.: 2,000

**Natural Abilities:** Nightvision 200 feet (61 m), see the invisible, resistant to heat/fire (does half damage), **teleport** 90%, dimensional **teleport** 82%, bio-regeneration 1D4X 100 M.D.C. per minute/4 melees, change shape into a giant lion.

**Disposition:** Simba thrives on intimidation. When he speaks, he usually accentuates his words with growls and roars, sometimes loudly enough to shatter glass. As a warrior, he sees everything as a possible challenge or contest, and he always plays to win. The god respects fighting prowess and will tend to appreciate warriors a great deal more than magicians, scholars or psychics.

**Experience Level:** 16th level warrior and magician.

**Magic Knowledge:** Knows all spells levels 1-7 plus luck curse, metamorphosis: human, minor curse, negate magic, oracle, curse: phobia, mute, speed of the snail, water to wine, banishment, metamorphosis: superior, mystic portal, anti-magic cloud, remove curse, amulet, metamorphosis: mist, time hole, close rift and impenetrable wall of force.

**Psionic Powers:** None

**Combat Skills:** Hand to Hand: Martial Arts.

**Attacks per Melee:** Eight hand to hand attacks, or two by magic.

**Bonuses:** +4 on initiative, +10 to strike, +12 to parry and dodge, +6 to roll with **impact/punch**, +6 to pull punch, +10 to save vs poison, +8 to save vs magic, +8 to save vs psionics, +10 to save vs horror factor.

**Weapon Proficiencies:** Knows all W.P.s.

**Armor:** Relies on his natural toughness.

**Description:** A lion-headed man, covered with light golden fur. He can alter his size from 6 to 24 feet (1.8 to 7.3 m).

**Special Magic Weapons:**

**Simba's War Club:** A greatest rune weapon. Its head is shaped like a clenched, clawed hand. As one of its power, this hand can open and grab, tear or crush opponents.

The powers of the club:

- I.Q. 13 and has a telepathic link with Simba.
- Indestructible; blue in color.
- Anarchist alignment: if any creature of good or evil alignment touches it, they are burnt, suffering 4D6 points of damage.



- Spell Magic: It can cast the following spells as often as three times each per 24 hour period: Invulnerability, **levitation**, summon rain, and calm storms. Equal to an 8th level sorcerer.
- Mega-damage: 2D4X10 M.D.
- Unclenched Hand: With a mental command, **Simba** can cause the **club's** clenched fist to open. This hand can grab a target (-2 to strike, parry and dodge while grappling), and tear or crush it (5D6 M.D.).

---

# Cibola, the Gilded City

---

## Another contributor to the legends of El Dorado

**Cibola Population Breakdown:** Approximately 1.4 million

Gatherers: 100,000

Pincer Warriors: 200,000

Pogtalian Dragon Slayers (see Rifts Vampire Kingdoms): 200,000

Grimbor: 150,000

Dimensional Ghouls: 20,000

Brodkil Warriors: 80,000 (see **Rifts Sourcebook One or Triax**)

Lizard Men: 50,000

Orcs: 30,000

Gargoyles: 20,000

Gurgoyles: 20,000

Humans: 50,000

Giants: 20,000

Other (including some temporal raiders, thousands of greater demons and devils, **elementals**, and aliens from other dimensions): 100,000—200,000

Does not count transient and visitor population of 2D4X10,000 people; mostly **transdimensional** traders and their bodyguards, travelers, bounty hunters and spies.

**Cibola Slave Population:** 300,000 total

Humans: 200,000

Lizard Men: 50,000

Other races: 50,000

Most slaves are captured South American natives of all races. They are kept as forced labor in Cibola or sold to other parts of the Megaverse. Cibola buys few slaves from other dimensions — why buy, when they can capture all they need?

## History

**The Seven Cities of Cibola** are a North American myth. Several Spanish expeditions in Texas and New Mexico searched in vain for these fabulous cities. Their goal was both closer and further away than they could know. There was only one city of Cibola, but it was nowhere on Earth. Its appearances at locations all around the world is the result of dimensional portals used by explorers and foragers from other dimensions. These portals sometimes allowed people on Earth to glimpse the **city** in another dimension — a sort of transdimensional "mirage" effect; the city was never actually on Earth. These *glimpses* spawned many legends. Appearances in **pre-Rifts** South America added fuel to the myths about El Dorado.

Cibola is the domain of **Inix**, a supernatural intelligence of the race known as the **Soul Worms**. Inix has devoted thousands of years to his prosperous little city, which has become known throughout the Megaverse as a source of rare drugs and potions. Alchemy is the major industry of Cibola. The **Cibolan** Gatherers travel the Megaverse to find and retrieve all sorts of plants, animals and minerals used as magical components for their advanced alchemy. In some ways, Inix is a combination scavenger, peddler of magic items, pharmacist, and drug lord. Beyond that, however, he is also a thoroughly evil entity that requires death and suffering to exist. He is always plotting to gain more power and sees Cibola as a means to become a major player in the Megaverse. However, he is a patient schemer and is prepared to wait millennia before making his move, if that is what's necessary.

Until a couple of centuries ago, the city was located at a transdimensional Nexus, a sort of pocket dimension connected to thousands of dimensions. Cibola was protected by an army of different races, from wolfen war-bands recruited in the Palladium World and trained in high-tech warfare, to gargoyles, dimensional ghouls, and demons. The city was a stopping point for many transdimensional travelers, because its gateways allowed for easy access to many worlds. Cibola is one of the few non-**Splugorth** cities that had access to bio-wizard microbes and parasites, so many visitors also came looking for exotic drugs and bio-wizard treatments. The medical facilities in Cibola were also among the most advanced in the Megaverse and even routinely performed resurrections of the recently dead — for a hefty price. The transdimensional weapons dealer, **Naruni Enterprises** (see **Rifts Mercenaries**) also had a branch office in Cibola.

A few decades after the Coming of the Rifts to Earth, Inix and his minions discovered that their pocket dimension was becoming unstable. A magical analysis revealed that the whole nexus would collapse into itself in a matter of decades, destroying everything inside. They traced the root of the disturbance to a previously unknown planet which its inhabitants called Earth, which had only recently become a dimensional nexus of cosmic proportions.

Since major cataclysms are bad for business, Inix decided to deal with the problem as quickly as possible by relocating. Ironically, Rifts Earth seemed the ideal location. Its vast mystic energies and many dimensional Rifts would make relocation relatively simple and enable Cibola to maintain most of its otherworldly clients. Furthermore, at that point in time, other than a

**Splugorth** colony and a few vampire kingdoms, there were no gods, world governments or other major threats on the planet to oppose **Inix** settlement — it was virgin territory. The Amazon jungle was chosen because of its isolation from obvious population centers (after all, most of Cibola's trade would be with other worlds, not Earth). The whole city and several miles of its outer environs were forcibly transported to Earth. This move caused a massive earthquake that killed thousands of people in South America, and which was felt as far north as Texas.

Inix made one miscalculation, however. He inadvertently placed his city uncomfortably close (less than a thousand miles/1600 km away) to Omagua and almost as close to **Manoa**, both of which had escaped his magical survey of the area. The ruler of Cibola did not like the idea of having neighbors, but moving again would require prohibitively high amounts of energy and the ensuing natural disaster would definitely alert the Splugorth to Cibola's presence, something they hoped to avoid. Inix decided to make the most of the uncomfortable situation and stay.

The alien intelligence has no patience for other cultures and prefers to deal with others from a position of strength, so he sent his Gatherers, Pincer Warriors, and other minions on raiding missions against both cities, hoping to intimidate *them* into leaving or even destroy them. These forays did some damage, but only succeeded in creating a state of war between the three cities. It soon became evident that the only way to get rid of his neighbors would be to start a full scale war he might or might not win. Certainly such a commotion would evoke the interest of his old rivals, the Splugorth. Perhaps too late to do him much good, Inix turned his efforts to political intrigue, which managed to create enmity between Omagua and Manoa, preventing their alliance against Cibola.

For the most part, Cibola has few dealings with the people of South America, which may prove to be a strategic mistake. Until recently, **Cibolans** had little competition in this part of the world. However, **Naruni Enterprises** (a long-time associate and rival) has started to trade with the Silver River Republics to the south (as well as making inroads to the north, around the Coalition States) and may soon start dealing with the Kingdoms of **Lagarto** and Colombia. Meanwhile, the Splugorth of Atlantis (famous **interdimensional** traders) are becoming a force to reckon with, especially at New Dragcona. Both forces are likely to establish a competing **interdimensional** trade port in the foreseeable future; a disturbing prospect.

Most of Cibola's trade is conducted with beings from other dimensions, although it has established some informal trade with pirates and jungle brigands. Inix is himself a diabolic rogue who would much rather dispatch raiding parties into other lands/worlds and steal valuables rather than buy or manufacture them. Since the other nations of South America are seen as primitive barbarians or champions of good, the evil alien intelligence has no compunction about plundering them.

## Government

Cibola is the personal domain of Inix, an alien intelligence-like being known as a soul worm. He is the absolute ruler of his realm. There is no system of checks and balances to regulate his power, because to quote Inix, "he is power." The soul worm does as he pleases. Anybody who rebels, questions his law or

tries to manipulate him suffers his terrible wrath. To maintain his rule, he commands an army of fanatically loyal warriors, informers, spies and assassins — many of whom are demons and monstrous **D-bees**.

A number of personal advisors are next in the line of political power. All wield a lot of influence, but can lose it all at the whim of Inix. A great deal of intrigue occurs between these servants who frequently try to undermine each other while staying on their master's good side. The current group of favorites are **Malkhom**, a temporal raider, **Rendell**, a dragon, **Iridna**, a female godling, and **Kastor**, the leader of the Gatherers. These four beings control different areas of the city's operation and see each other as rivals for Inix' favor (and power). Their rivalry amuses Inix, who allows it to continue as long as it doesn't damage his interests.

There are also a number of minor ministers and bureaucrats, most of whom are members of the Gatherer race.

## Society

Unlike most of the nations previously described, Cibola has little in the way of nationalistic ideals or principles. People come to Cibola to make their fortune, usually by exploiting the innocent, foolish and greedy. As a result, the city's atmosphere is one of corruption, betrayal and fear. Greed dominates most transactions and crime runs rampant. Everybody is out to make a buck and often they make it at the expense of an unfortunate. This greed engenders intense rivalry, betrayal, treachery and intrigues on every level of business and government. The Cibolans are ready to sell anybody down the river if they can make a profit from it. To maintain order over these people, Inix and his servants use fear, keeping people comparatively honest (especially when dealing directly with him), or at least giving them cause to worry about getting caught and punished. Only **Inix'** warriors are truly loyal to the him, but even they show little concern or loyalty to the city's inhabitants — unless Inix orders otherwise.

Cibola is a slave society. Most hard or menial labor is performed by human and **D-bee** slaves. As a result, most free citizens tend to be lazy aristocrats, conniving business people, corrupt merchants, thieves and vagabonds who consider work to be something *that free men* shouldn't bother doing. Slaves have no rights and can be beaten, tortured or killed (sometimes used as food!) at their owner's whim. Acts of brutality are commonplace, and as a result, most "free" inhabitants of the city are of anarchist or evil alignments. Beings of any good alignment could never stomach the injustice, corruption and crimes committed in Cibola. Visitors, of course, can be of any alignment and there is a huge transient population from across the Megaverse.

Since most humans inside the city are slaves or servants, the alien monsters that rule Cibola have little regard for that race. Human visitors can expect to be insulted, harassed, robbed and even captured and enslaved by the locals. Picking a fight with an inhuman inhabitant will get a human into terrible trouble, leading to imprisonment, confiscation of all possessions followed by expulsion from the city (visitors only wish they can be that lucky), beatings, enslavement and even execution. The authorities will usually side with a citizen, especially powerful merchants, aristocrats and dignitaries from other dimensions. The

only exceptions to this rule applies to visitors (of any race) who are the guests of **Inix** or one of his "favorite" advisors, **character(s)** who exhibit great power (and his accuser is a known troublemaker) or a visitor who shows that he/she has a large amount of money and has come to the city to make purchases. Since trade provides most of **Cibola's** revenues, the city takes steps to protect "important" (i.e. wealthy) buyers. A few bribes in the right places will also help to get on the **authorities'** good side and out of virtually any trouble that does not involve Inix or his advisors. Depending on the situation, Cibolan guards and law keepers will expect "gratuities" ranging from 1,000 to millions of credits, or equivalent trade items or services.

## Foreign Relations

**Cibola** sees all nations on Earth as either rivals or prey. **Inix'** plans for the future include a slow but steady expansion of the city-empire. He sees the Amazon Jungle as a possible source for raw materials for his drug labs. Already Gatherer teams venture into the rain forest looking for samples of the local flora and fauna, not to mention victims for capture and sale on the inter-dimensional slave market.

**Manoa:** Inix sees Manoa as his city's most dangerous rival. He considers True **Atlanteans** to be a bunch of do-gooders and meddlers who will, sooner or later, try to shut down his operation (and he's right). Even worse, he is afraid that the **Manoans** may attract the **Splugorth's** scrutiny and does not want to deal with those ultra-powerful rivals at this time. Cibolan spies and saboteurs do their best to cause trouble in Manoa and to distract **Splugorth** agents.

**Omagua:** The Jaguar City is another dangerous enemy. Gods are always bad news as far as Inix is concerned — too tough to kill easily and either smart enough to avoid being fooled by Inix, or foolish enough to try to go against him. Inix is considering putting a contract out on the Divine Felines. There are a few outfits in the **Megaverse** that specialize in dealing with mega-powerful entities. The only problem is that their services are prohibitively expensive, so Inix is waiting until Omagua becomes a problem he cannot afford to ignore. So far the feline gods have not caused him much trouble. He hopes things stay that way.

**The Kingdom of Lagarto:** Inix has two words to say about the kingdom, "Splugorth puppets." The Splugorth are ancient rivals bordering on enemies. He decided to take the initiative in subverting their operations by sending (or encouraging) guerilla fighters and saboteurs into lizard man territory to engage in acts of violence to create confusion, terror and revolt. Bandits and mercenaries hired by and sent from Cibola plunder supply lines and steal **Kittani** and other valuable weapons and equipment from the **Lagartian** forces to resell them at the Cibolan **transdimensional** market.

**Colombia:** Inix (or, actually, his servant **Malkhom**) has several spies in place at Colombia to keep an eye on things transpiring in that volatile country. Two major events could make Cibola intervene in affairs Colombian. The first would be a rise in vampire activity. As far as Inix is concerned, vampires are as bad or worse than the Splugorth. If the **Haktla** vampires seem to be winning the war, Inix will send the humans covert aid — just enough to bring about a stalemate. The second possibility is an alliance between the Republic of Colombia and the Coalition

States. Inix does not want any foreign nations involved in South America's affairs, so he will assign **Malkhom's** and his agents to sabotage any such arrangements.

**The Silver River Republics (SRR):** Cibolan smugglers have recently started trafficking drugs in some of those nations. The SRR kingdoms are wealthy enough to offer a promising market. Most people in the SRR are ignorant about Cibola. That is just the way Inix likes it. Furthermore, their constant in-fighting and lack of awareness renders them an unlikely danger to Inix and his schemes. **GM Note:** This South American kingdom will be presented in a second world book about this continent.

**Maga Island:** Inix *wants* the secrets of **biomancy**. So far, his attempts to buy, cajole or steal information have all failed. These efforts have succeeded in making the rulers of Maga aware of Cibola and its desire to acquire biomancy. The jungle elves recognize the **Cibolans** as conniving **transdimensional** merchants, villains, and destroyers. They have taken additional measures to protect both Maga Island and the secrets of biomancy — it must never fall into the hands of such cutthroats. They also realize that they have acquired a new, dangerous enemy.

**The Kingdom of Bahia:** There is nothing about **Bahia** to interest the forces at Cibola. It is too far, too small, and too primitive for **Inix'** taste. All Bahia may represent is a potential pawn in their sabotage of Lagarto and serve as slave stock. At this point there have been no confrontations between the two kingdoms.

**The Empire of the Sun:** Inix has heard many intriguing (and alarming) rumors coming from the new **Inca** empire to the West. Among them are stories that the Inca gods once again walk the Earth, an alien fleet has arrived in the land, and that an army of transdimensional mercenaries controls the Andes mountains (as well as most roads in and out of what used to be Peru and Bolivia). Cibola has sent many spies to investigate, but none have returned. Malkhom is planning to hire an expendable group of mercenaries (player characters?) to make further investigations. **GM Note:** This part of the continent will be presented in *Rifts South America Two*.

## Cibola City Highlights

---

**Cibola's** arrival on Earth carved a huge swath of destruction across the jungle. Even now, well over a century after the event, the jungle has yet to grow back around the city. Instead, about a mile (1.6 km) all around the place consists of sparsely wooded savannah. Much of it is covered with fenced in enclosures where Cibolan slaves cultivate exotic alien plants used to make the powerful drugs peddled by Cibolan merchants. Half a dozen paved roads lead in and out of the city. Looming towers and buildings of strange designs jut into the skyline. Solid gold and platinum statues stand at most street corners. The figures represent dragons, **D-bee** warriors, magicians, and alien monsters, including Soul Worms like the ruler of Cibola (see below). Some statues are over 60 feet (18.3 m) tall, towering threateningly over passerby(s). The common rumor on the street is that these statues have been enchanted to act as surveillance devices, so most locals never speak openly against the city rulers while in their vicinity.

A few of the buildings produce strange shimmering effects, changing colors and even shapes as people stare at them! Those

buildings use *phase technology* in their construction, an alien science that enables physical objects to shift "dimensional frequencies," causing a number of powerful effects. Phase Technology and its alien creators are fully described in **Rifts Dimension Book Two: Phase World**.

Visitors who travel overland to Cibola will be stopped and questioned by one of the many roving patrols of **Gatherers or Pincer Warriors**. Visitors, particularly Earth-bom non-dimensional travelers, must pay these patrols a hefty entrance fee, which will vary from encounter to encounter. The fee is more like a bribe than a legitimate toll or tax. Valuable objects like gems, weapons, **E-cells**, high-tech equipment and magical items are welcomed as payment. Most (98%) will NOT accept universal credits — Earth money has little value to the dimension-spanning **Cibolans**.

**The Plaza of a Hundred Gates:** The plaza is a giant marketplace, located at the heart of the city, that surrounds the great Tower of the Hundred Gates, **transdimensional** visitor's station/nexus. The market occupies two square miles (5.2 square km) of permanent and semi-permanent shops, rental agencies, entertainment establishments (ranging from movie theaters to magic acts to houses of prostitution and drug dens), inns and restaurants, and other places of trade and services. Although not quite as large or varied as the **Splynn Dimensional Market** (see **Rifts Atlantis**), this place offers a lot of exotic merchandise, and sells articles not commonly found in the **Splugorth** markets, including a number of rare drugs and potions (**Inix**' specialty).

**The Tower of the Hundred Gates:** A 600 foot (183 m) tall, spiral tower rises from the center of the main marketplace. The giant structure taps into a ley line nexus below the surface of the city and acts like a stone pyramid to channel mystical energy for the creation of transdimensional "gates" to other worlds. The Hundred Gates name is an exaggeration; there are only 43 permanent dimensional portals. Each is linked to a different dimension, although some dimensions have more than one gate connected to them. Among the many dimensions connected to Cibola are the city of **Worldgate** on Wormwood (which has an additional two gates on other parts of the planet), the **Palladium world** (three gates: one in the Western Empire, another in a hidden temple in the Yin-Sloth Jungles and the last one located at some ruins in the Northern Wilderness), a **parallel-universe Earth** devastated by alien robot invaders whose **mecha** resemble giant crabs or insects (two gates), the space and dimensional port called **Center** on Phase World (see **Dimension Book Two** — an additional three gates are connected to other planets in the same universe), the home planet of the **Pogtalian** Dragon Slayers (see **Rifts Vampire Kingdoms**), two trading centers with **Naruni Enterprises**, and a dimension ruled by ancient Greek-Roman gods (see **Rifts Conversion Book Two: Pantheons of the Megaverse**).

Travel through those gates is restricted. Mystical alarms alert the Tower Guard to *unscheduled* arrivals/invasions/use. The tower has a permanent garrison of 5,000 warriors equally divided into search and destroy, defensive, heavy weapons and anti-magic battalions. Visitors have to talk to a Gatherer customs official, announcing their **intentions/business**, plane of origin, and estimated length of stay. The custom officials speak **Dragonese/Elf** and 10-15 other languages, plus they wear a magical headband that allows for magical translations in case the

newcomer speaks an unknown alien tongue. There is also an entry fee of 1,000 credits or the equivalent in trade. Regular visitors can purchase a monthly passport that is magically encrypted to prevent forgeries. The passport costs 15,000 credits and allows "regulars" to come and go without delays or any additional fees.

Visitors are allowed to keep hand weapons and even power armor, but large vehicles, giant robots and oversized military weapons must be left in the tower's vaults. No more than 12 beings are allowed through a gate at the same time. Larger groups should get prior permission from the Gatherers, **Inix** or one of the palace advisors, otherwise they will have to wait 24 hours before the next group of 12 are allowed into the city. Any group that even resembles an army will be denied entry. The Gatherer custom agents and palace advisors have the authority to deny dimensional access without an explanation. Likewise, they can detain, imprison, interrogate and/or deport visitors without warning or explanation.

**Important Note:** The spiral tower's magical energies envelop the entire city and make it very difficult to open Rifts or to perform dimensional **teleport** within city limits. Such attempts have a -70% penalty! This makes many dimensional travelers, shifters, temporal raiders, dragons and even greater beings like demon lords and gods reluctant to visit the city for fear of becoming trapped there. Even ordinary **teleportation** magic, machines and abilities are disrupted! All attempts at teleportation of any kind are -25%, making it a dangerous action. Furthermore, all temporal displacement magic is impaired; half duration, effect, range and chance for success.

Characters attempting to Rift into Cibola are +10% but will *always* appear at one of the "gates" inside the Tower. The only safe way to **dimensionally** Rift out of the city is to use one of the portals at the Tower of a Hundred Gates or to travel several miles away from the city. The space and time displacement aura around the city also helps merchants and slave masters to contain prisoners and slaves who have dimension-spanning powers.

**The Arena of Cibola:** This is a Roman-style circular arena that seats 100,000 spectators. **Inix** sponsors a number of gladiatorial fights and games for the entertainment of the masses. Slaves of all races are brought to fight and die in the arena. The most popular events include battles between giant monsters or supernatural creatures. The arena administrators are always on the lookout for exotic "acts." They pay a premium for any powerful supernatural creature, including dragons, godlings and super-powered **humanoids**. Visitors from other dimensions sometimes come to Cibola just to watch the bloody battles. They are willing to pay dearly for "big" attractions. The best seats in the arena sell for as much as 10,000 credits (front rows), to a minimum of 100 credits for the worst locations. Citizens of Cibola can watch the event from their homes or at public establishments on "pay to view" television; typical cost is 50 credits.

## Cibolan Armed Forces

The Cibolan "militia" comprises almost 60% of the entire population. Most of it remains within the city walls, ready to deal with any would-be invaders. **Search-and-destroy** or raiding patrols are sent out regularly to "defuse" potential problems before they get started. Listed below are some typical combat units.

### **Cibolan Scout Patrol**

- 6 Grimbor Warriors on foot.
- 2 Pincer Warriors or Poptalian Dragon Slayers on foot.
- 1 Gatherer leader on a flying platform.

### **Cibolan Search and Destroy Squad**

- 4 Grimbor Warriors on foot (scouts and skirmishers).
- 4 Pincer Warriors on foot.
- 4 Poptalian Dragon Slayers on foot.
- 2 Gatherers on flying platforms.

### **Cibolan Mechanized Squad**

- 6 Pincer Warriors on flying platforms.
- 4 Poptalian Dragon Slayers on flying platforms.
- 4 Poptalian Dragon Slayers in Dragon Death Power Armor.
- 2 Gatherers on flying platforms.

### **Cibolan Heavy Weapons Squad**

- 4 Pincer Warriors on foot.
- 2 Pincer Warriors with force fields and rocket launchers.
- 4 Poptalian Dragon Slayers in Dragon Death Power Armor.
- 4 Poptalian Dragon Slayers with force fields and Plasma Cartridge Machine Guns.
- 2 Gatherers on flying platforms.

### **Cibolan Supernatural Squad**

- 4 Pincer Warriors on foot.
- 4 Gallu Bull demons
- 4 Alu Demons
- 1 Greater demon or 2 Gatherers on flying platforms.

### **Cibolan Giant Squad**

- 4 Poptalian Dragon Slayers
- 4 Gigantes
- 4 Assorted giants
- 2 Gatherers on a flying platform.

### **Cibolan Aerial Squad**

- 4 Gatherers on flying platforms.
- 8 Poptalian Dragon Slayers on flying platforms.

## **Key Forces & Characters**

### **Inix — Alien Intelligence**

**Real Name:** Inixclajk

**Alignment:** Miscreant

**Species:** Soul Worm

**Horror Factor:** 15

**Attributes:** I.Q. 29, M.E. 23, M.A. 25, P.S. 38, P.P. 24, P.E. 28, P.B. 2, Spd 30.

**M.D.C.:** 14,000

**P.P.E.:** 2,000

**Natural Abilities:** Same as all soul worms (see below).

**Disposition:** Inix, despite his inhuman appearance, has several very human-like traits — including greediness, deviousness and cunning. A human dimensional traveler once described him as "a monster with the soul of a used car salesman." Inix craves wealth and power, but is not daring enough to go on a conquering spree like the more successful **Spugorth**, vampires and other alien intelligences. Inix is megalomaniac enough to refuse to serve a greater power, but doesn't feel he can become ruler of the **Megaverse** by his lonesome. For the

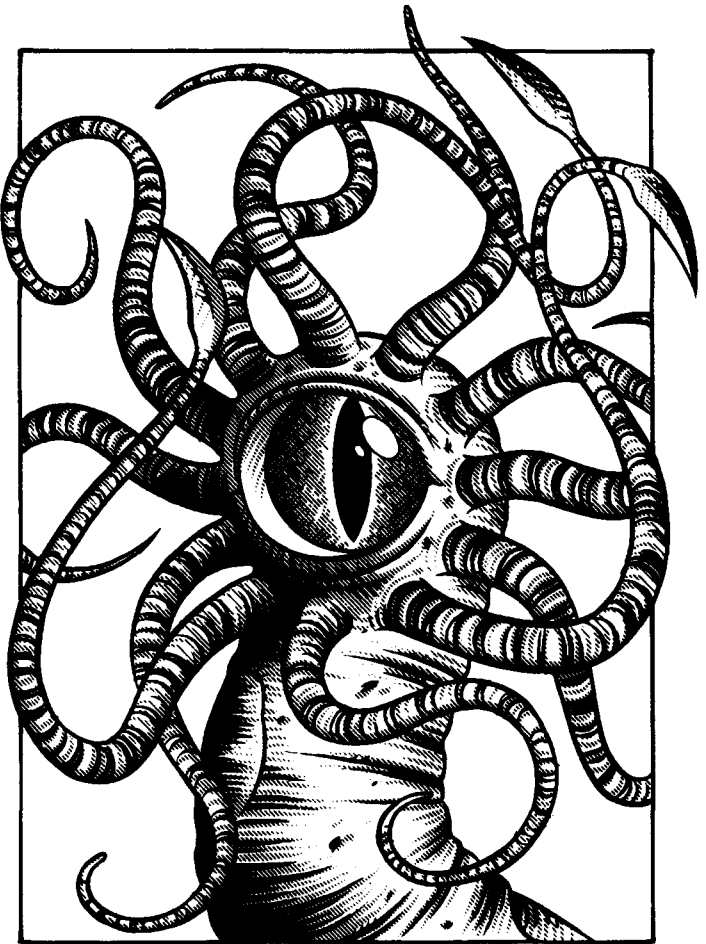

time being, he is content with ruling the fabulous city of **Cibola** and making it the foremost trading post in the **Megaverse** (which won't happen anytime soon, but he is in no hurry).

Inix enjoys terrorizing "lesser creatures" like normal humans, orcs, and other mortal races. When dealing with his "equals" (which include godlings, gods, extraordinary humans, ancient dragons and other intelligences), Inix uses flattery and diplomacy to manipulate them. When he tries to, he can (almost literally) ooze charm and become almost likeable (as much as a giant maggot can, that is); he often uses his magic to take a human or humanoid shape to better impress powerful beings.

**Experience Level:** 10th level Soul Worm R.C.C.

**Magic Knowledge:** Knows all spell magic levels 1-5, plus call lightning, compulsion, time slip, life drain, locate, minor curse, negate magic, control/enslave entity and metamorphosis (superior). P.P.E.: 2,000

**Psionic Powers:** All sensitive powers plus empathic transmission, hypnotic suggestion, and mind wipe. Equal to an 8th level mind melter. L.S.P.: 1,200.

**Combat Skills:** Supernatural

**Attacks per Melee:** Six hand to hand or psionic attacks, or two by magic.

Restrained Tentacle Strike — 1D6X10 +23 S.D.C.

Full Strength Tentacle Strike — 1D4X10 M.D.

Power Tentacle Strike — 2D4X10 M.D. (counts as two attacks)



**Bonuses:** +1 on initiative, +7 to strike, +6 to parry and dodge, +23 to S.D.C. damage, -1 to roll with **impact/punch**, +2 to pull punch, +7 to save vs poison, +8 to save vs magic, +5 to save vs psionics, +10 to save vs horror factor, immune to mind control and possession.

**Weapon Proficiencies:** None; relies on his powers.

**Weapons:** None; relies on his powers.

**Armor:** Never wears any.

**Skills of Note:** Magically knows all languages, literate in American, Spanish, Euro, Creole, Atlantean, Dragonese/Elf, Demongogian, Galactic Trade Tongue I, Kydian and Goblely, all at 98%. Plus intelligence 98%, swimming 98%, detect ambush 98%, detect **concealment** 98%, **demon/monster** lore 98%, D-Bee lore 98%, **Splugorth** lore 98%, Faerie lore 98%, anthropology 98% and archaeology 98%.

**Description:** Like all soul worms, **Inix** resembles a giant fleshy worm with an eye at one end. The eye is surrounded by 12 long tentacles, which he sometimes uses in very human-like gestures, like shrugging, beckoning people, or waving them away. He is also fond of using the metamorphosis spell to turn itself into a middle-aged human with a long grey beard and sharp features. Another favorite shape is that of a 12 foot (3.7 m) tall humanoid with the build and appearance of a god.

## Soul Worms

These monstrous creatures may be related to the **Zembakh Mystic Worms** (see **Rifts Atlantis**). Like the peace-loving **Zembakh**, the soul worms are fleshy larva-like beings with a huge eye on one end (the head). The differences, however, are many. Soul Worms are much larger, have 12 long tentacles surrounding the eye, and they are evil, destructive psychic vampires able to strip living things of their identities and life force.

Thousands of years ago, the soul worms were the servants of a powerful alien intelligence (perhaps related to or even one of the Old Ones from the Palladium World). They served as the **creature's** secret police, traveling to the hundreds of worlds under the monster's sway. There they would unearth plots against their master; real or imagined. One day, their master disappeared and never returned. No enemy could be found or cause attributed to the bizarre disappearance. Bereft of their leader, the soul worms and other minions were vulnerable to many enemies throughout the Megaverse; including mythological pantheons, the **Splugorth** and other alien intelligences. These rivals invaded and took over their territories. Nine-tenths of all soul worms perished, some were killed by the invaders, others died at the hands of former slaves seeking revenge. The rest scattered across the dimensions.

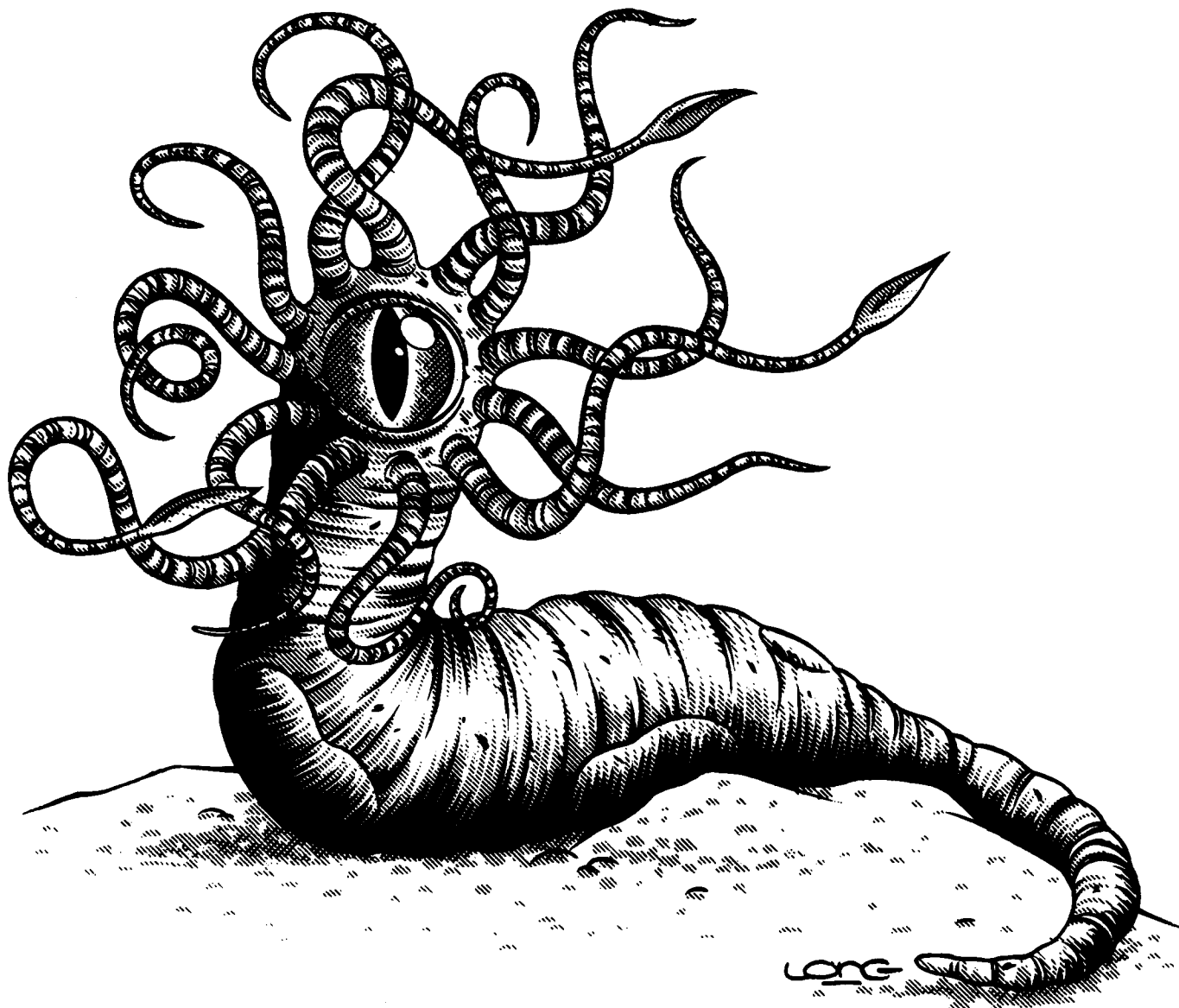

Today, only a few thousand soul worms survive. Some, like **Inix**, have become the lords of dimensional kingdoms. Others can be found in the service of powerful demon lords and evil gods, still others lead dimensional raiders, or wander the Megaverse. They are often associated with powerful dimensional travelers like temporal raiders, sowki, **mindolars**, **demi-gods** and **godlings**.

**Note:** Soul worms are not available as player characters.

**Alignment:** 33% are anarchist, 64% are evil, and a tiny 3% are unprincipled or good.

**Horror Factor:** 15

**Attributes:** I.Q. 2D6+18, M.E. 1D6+20, M.A. 1D6+20, P.S. 4D6+26, P.P. 4D6+4, P.P. 1D6+20, P.E. 2D6+18, P.B. 1D6, Spd 2D4X10.

**S.D.C./Hit Points (in S.D.C. environments):** 2D6X1000 S.D.C. and 1D4X1000 hit points.

**M.D.C.:** The worms become mega-damage creatures in magic rich environments such as Rifts Earth. 4D6X1000 M.D.C.; the central eye has 1/100 of the body's M.D.C., and each tentacle has 60 M.D.C.

**Natural Abilities:** Nightvision 500 feet (152 m), see the invisible, turn invisible at will, invulnerable to **fire** (even M.D.C. flame and plasma does no damage), bio-regenerate 2D6X10 M.D.C. per melee round, **teleport** self up to 100 miles (160 km) away, dimensional teleport to any dimension the character is familiar with (72%).

**Soul Draining:** This is a special, deadly power unique to the horrible soul worm. The monster can try to sap a victim's life force and memories. The use of this ability requires the soul worm to focus so intently that it becomes temporarily oblivious to everything around it and cannot defend itself or perform any melee actions/attacks for 2D4 minutes. Consequently, soul drain is rarely performed during combat and often reserved for important prisoners. The character under this attack needs to make a save vs psionics or he will lose 3D6 P.P.E. and I.S.P. This can be continued every melee round after initiating the draining attack; a new save can be attempted each melee round, but the character is 2 to save.

When all P.P.E. and I.S.P. are depleted, the soul worm can drain him of his Mental Endurance (M.E.) attribute at a rate of 1D4 M.E. points per melee round; the victim can try to save vs psionic attack (but is -2 to save). When the M.E. is reduced to zero, the victim is dead, and his soul and memories have been absorbed by the monster. The worm retains those memories for 3D4 hours, after which only those that most interest the creature remain. This makes soul worms the ultimate interrogators (although only if the interrogation target doesn't have to survive the process).

Most evil soul worms are addicted to the draining and must perform it once a week; every week that goes by without a victim, the Worm loses 1D4X10 M.D.C. (non-regenerable until it feeds **again!**), is at -2 to strike, parry and dodge, and save vs psionic attacks.

**Note:** Magic restoration or resurrection will bring the character back to life! However, he or she will suffer a complete loss of memory, experience points, O.C.C., skills, and all but the most rudimentary, everyday knowledge (like how to open a door, use of a fork and knife to eat, and similar). In addition, all mental attributes are permanently reduced by half and the character is insane: phobia about worms and maggots,

plus roll once on the Random Insanity Table Resulting from Trauma (see **Rifts RPG**, page 19). The character is also tormented by brief, but incomplete, flashes of memory and emotions from the past but they never last. The best the character can hope to accomplish is the vagabond O.C.C. and even then the selection of O.C.C. "other" skills and secondary skills are reduced by half. One thing the character will remember is the monster who did this to him. This may lead to an obsession (50%) to destroy the monster or to extract some sort of revenge.

**Average Level of Experience:** 2D6+3

**Bonuses:** Six attacks per melee, +1 to initiative, +2 to strike, +1 to parry and dodge, +1 to save vs magic and psionics, +6 to save vs horror factor, immune to mind control and possession. All these are in addition to attribute bonuses.

**R.C.C. Skills:** Magically knows all languages, literate in 10 languages, intelligence (+20%), swimming (+20%), detect ambush (+15%), detect concealment (+15%), **demon/monster** lore (+25%), any other six skills at +10%. Most Soul Worms are not interested in mundane skills best left to underlings and minions.

**Magic:** Soul Worms automatically know all spell magic levels 1-4, plus two more spells of any level per level of experience. At all levels, the spell strength, damage and range are as per a 6th level spell caster. P.P.E.: 1D4X1000

**Psionics:** All sensitive powers plus four super powers of choice. All powers work at 8th level, regardless of the worm's experience. I.S.P.: 1D6X100

**Size:** 5 to 7 feet (1.5 to 2.1 m) tall and 25 to 30 feet (7.6 to 9.1 m) long.

**Weight:** Four to seven tons (3600 to 6300 kg).

**Standard Equipment:** Rarely uses any. Some will use rune weapons and magic wands or staves. Their tentacles can manipulate objects almost as well as hands, but most Worms will not deign to use tools of any kind.

**Money:** 4D6X100 million in cash and 2D6 billion in hoarded valuables (much of which is likely to be hidden throughout the Megaverse).

**Cybernetics:** Never get any.

---

## Malkhom

### Cibola's Head of Security

---

Malkhom is **Inix**' most trusted agent and the head of the Intelligence Network and Security of **Cibola**. The character is a temporal raider of an evil alignment, yet often honorable. He is frequently away from the city, traveling to other worlds to conduct missions of espionage or assassination. His spies are everywhere, watching both the city and its neighbors. Of the four advisors, Malkhom is the most secure. He has proven to be too useful to be easily replaced and his loyalty and expertise is of great value to **Inix**. It is widely believed that Malkhom has dirt on the three other advisors (including evidence, real or manufactured, of plots against **Inix**) as well as most lesser officials and power merchants. Thus, nobody dares to interfere with him openly, preferring to use pawns that cannot be easily traced back to them. Malkhom never shows any emotion, regardless of the circumstances. His cold, analytical mind worries Rendell, who is

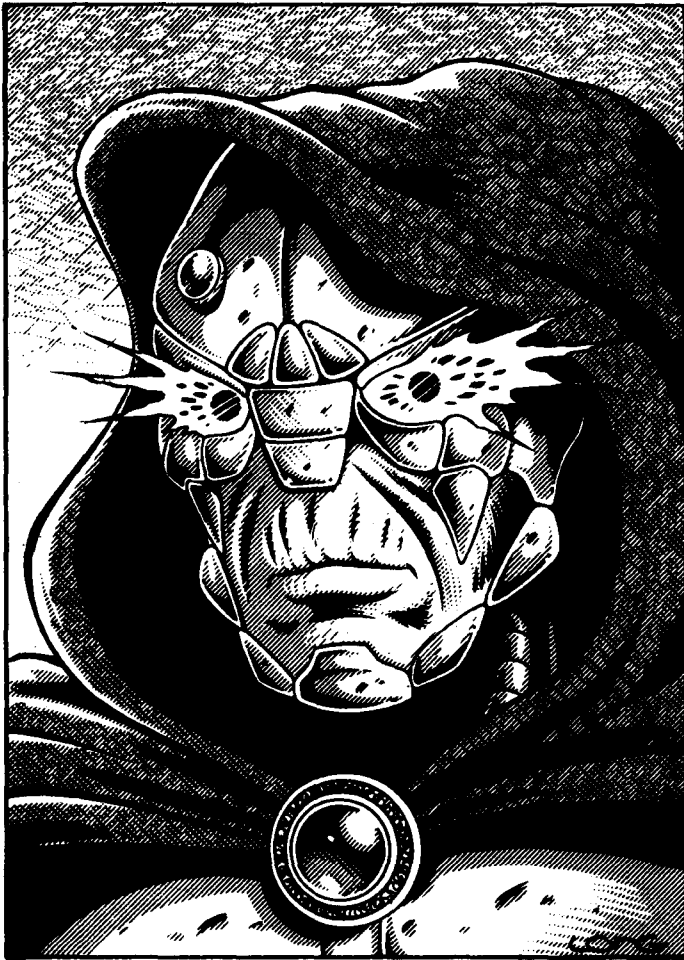

an impulsive beast, and Iridna, who recognizes a superior mind when she sees one.

**Alignment:** Aberrant

**Species:** Temporal Raider (see **Rifts England**)

**Horror Factor:** 13

**Attributes:** I.Q. 19, M.A. 12, M.E. 21, P.S. 20, P.P. 19, P.E. 17, P.B. 9, Spd. 20.

**M.D.C.:** 310

**P.P.E.:** 390

**Natural Abilities:** Sense dimensional anomalies, ley line phasing, feeds on the life force of living creatures, impervious to poisons, toxins, drugs, gases, heat and fire, doesn't breathe air, and is resistant to all forms of energy (does half damage), bio-regenerates 4D6 every melee round (the regeneration counts as one melee attack), and can fire energy blasts from his hands, eyes or mouth.

**Disposition:** Unnaturally calm and collected, even in the face of extreme danger or stress. His shining eyes always stare at people in a measuring, unnerving way. His demeanor seems to imply that he knows when a character is lying — in fact, it often seems he knows everything about the character and he's only testing to see if the person will be truthful or not.

His cold-blooded attitude applies to any situation, from interrogation to combat. **Malkhom** is calculating and merciless, doing whatever is necessary to get the job done, but always conscious of the short and long term consequences of his actions. Despite what one might believe to the contrary, he is willing to use acts of kindness, generosity, and compassion, or appeal to a person's greed, desires, and fears as quickly as

he might use intimidation, deception, torture and murder; whatever will get the best results.

**Experience Level:** 14th level temporal raider.

**Magic Knowledge:** Knows all temporal magic spells and all spells levels 1-2, plus summoning magic, protection circles: simple and superior, eyes of **Toth**, shadow meld, time slip, negate magic, mystic portal, close rift, and dimensional portal.

**Psionic Powers:** Knows alter aura, death trance, levitation, mind block, empathy and telepathy. I.S.P.: 49

**Attacks per Melee:** Six hand to hand or psionic attacks per melee, or twelve light energy blasts or six heavy energy blasts, or two magic attacks.

**Bonuses:** +6 to initiative, +7 to strike, +8 to strike with energy blasts, +9 to parry and dodge, +5 to roll with impact/punch, +5 to pull punch, +4 to save vs magic, +6 to save vs psionics, +10 to save vs horror factor.

**Weapon Proficiencies:** W.P. sword, W.P. energy pistol, W.P. energy rifle, W.P. knife.

**Weapons:** His personal **sidearm** is an NE-4P Plasma Cartridge pistol (1D4×10 M.D.).

**Armor:** Rarely uses any.

**Skills of Note:** Land navigation 98%, wilderness survival (98%), pilot hovercraft (98%), pilot jet aircraft (98%), horsemanship (98%), **Dragonese/Elf** 98%, **Demongogian** 98%, Spanish 98%, Creole 98%, American 98%.

**Description:** A grey, hairless humanoid with a face that resembles a metallic mask, with more plate-like growths on his arms, neck and chest. He wears solid black capes or hooded cloaks.

---

## Iridna

### Inix's War Chief

---

Iridna is a rarity in Cibola: a human-looking woman that is in a position of power in a city of monsters. However, when one gets to know her better, it is clear that she fits right in. Not all monsters look hideous.

The origins of the godling remain a mystery. Contradictory rumors make her a daughter of **Hel**, the Nordic death goddess, a renegade member of the Persian Pantheon, or a **demi-demon** from a hellish dimension. Nobody dares ask her too many questions. Iridna has been known to flail minor servants and messengers — and that was when she was in a good mood. Iridna's fierceness brought her to the attention of **Inix** several decades ago. It is said he watched admiringly as she **bare-handedly** tore apart a **Pincer Warrior** that looked at her the wrong way. In a couple of years, Iridna replaced the former War Chief of Cibola (the replacement ceremony was conducted at the gladiatorial arena, with drawn swords. Iridna won the duel and the position; her predecessor lost his head). The godling has ruled the multi-racial armies of Cibola with an iron fist, and has been able to deal with all threats to the city.

The only thing that worries **Inix** is that Iridna is perhaps a little too hawkish. She wants to lead **Cibola's** armies into a war of conquest, which is far from **Inix's** plans. As far as **Inix** is concerned, would-be conquerors never last long and he is happy ruling his rich and powerful little city. This difference in opinions



has led to some rumors that Iridna is considering replacing Inix as the ruler of Cibola — giving him the same treatment she gave the former War Chief.

**Alignment:** Diabolic

**Species:** Godling

**Horror Factor:** 10; 12 if the people facing her know of her reputation as a ruthless and sadistic killer.

**Attributes:** I.Q. 17, M.A. 22, M.E. 20, P.S. 43, P.P. 24, P.E. 28, P.B. 23, Spd. 34.

**M.D.C.:** 641

**P.P.E.:** 30

**Natural Abilities:** See the invisible, resistant to poisons, drugs and toxins (half as effective), nightvision 200 feet (61 m), fire and cold resistant (half damage), regenerates 1D6X5 M.D.C. every minute, and can fire an energy blast that does 6D6 M.D. (300 feet/91 m range).

**Disposition:** Iridna is insanely violent and sadistic, but she can hide her personality very well. She can be charming and charismatic, and never lets her dazzling smile falter, even while filleting some poor individual. The suffering of others gladdens her dark soul; her slaves seldom last more than a month or two before they offend her somehow and end up spiked on her sword — if they are lucky.

**Experience Level:** 12th level godling

**Magic Knowledge:** None

**Psionic Powers:** None

**Combat Skills:** Hand to Hand: Assassin and boxing.

**Attacks per Melee:** Seven hand to hand attacks per melee.

**Bonuses:** +4 to initiative, +10 to strike, +9 to parry and dodge, +3 to roll with impact/punch, +3 to pull punch, +9 to save vs magic, +3 to save vs psionics, and +9 to save vs horror factor.

**Weapon Proficiencies:** W.P. sword, W.P. knife, W.P. blunt, W.P. archery and targeting, W.P. energy pistol, W.P. energy rifle.

**Weapons:** Owns a Sword of Atlantis, a very powerful greatest rune weapon, and an assortment of energy weapons, vibroblades, and instruments of torture.

**Armor:** Black plate armor with a demonic motif, 120 M.D.C.

**Skills of Note:** Literate in *Dragonese/Elf*, *Demongogian* and *Creole* at 98%, speaks *Spanish* and *American* 98%, basic math 98%, demon and monster lore 98%, land navigation 97%, detect concealment 88%, detect ambush 93%, wilderness survival 93%, dance 93%, horsemanship 98%, pilot flying platform 98%, tracking 88%, and prowl 88%.

**Description:** A pale black-haired woman with intense deep-blue eyes. She favors black lipstick and nail polish, accentuating her paleness, and always dresses in black, wearing short tunics and thigh-high boots to formal occasions, or black demonic armor in combat. She always has her rune sword at her side.

## Rendell The Slave Master

Of all of *Inix*' important servants, Rendell is the most servile and sycophantic of them all, always agreeing and flattering the soul worm. He makes a disgusting and pathetic picture, a mighty fire dragon kowtowing to the slimy soul worm. Since Rendell is more than willing to kill anybody who offends him, nobody comments on his slavish behavior — at least not to his face.

According to people in the know, Rendell was a proud and powerful dragon who had the misfortune of falling prey to a more powerful great horned dragon. Rendell's rival defeated and captured him and kept him imprisoned in a pocket dimension for several centuries. Rendell's imprisonment involved a constant cycle of torture and degradation that eventually eroded his sanity and dignity. Inix discovered the captive dragon, broken by the centuries of indignity. The prisoner was ready to seize any opportunity for freedom and agreed to serve Inix if he would free him from his prison.

Inix personally led a small army to the dimensional prison, slew the horned dragon, and rescued Rendell. Since that day, the fire dragon has been *Inix*' loyal servant. In his insane state, he regards Inix as an angel from heaven, come to deliver him. The dragon has proven to be a very efficient administrator and is in charge of the slave and drug operations. This position often forces him to collaborate with Kastor, who is in charge of supplying new slaves and raw materials. Rendell is a frequent drug user and imbibes narcotic and hallucinogenic potions that are powerful enough to work on dragons (and which would instantly kill anybody other than an adult dragon or god). Rendell's only failing is that he is fiercely jealous of anybody who steals *Inix*' attention away from him. He despises *Iridna*, whom Inix seems to admire. The fact that the goddess holds Rendell in absolute contempt does not help, either. Rendell is also jealous of *Malkhom*, but recognizes him to be a vital servant of Inix. *Malkhom* has also shown the dragon some measure of compassion (if not respect) which has won him some loyalty from the beast.

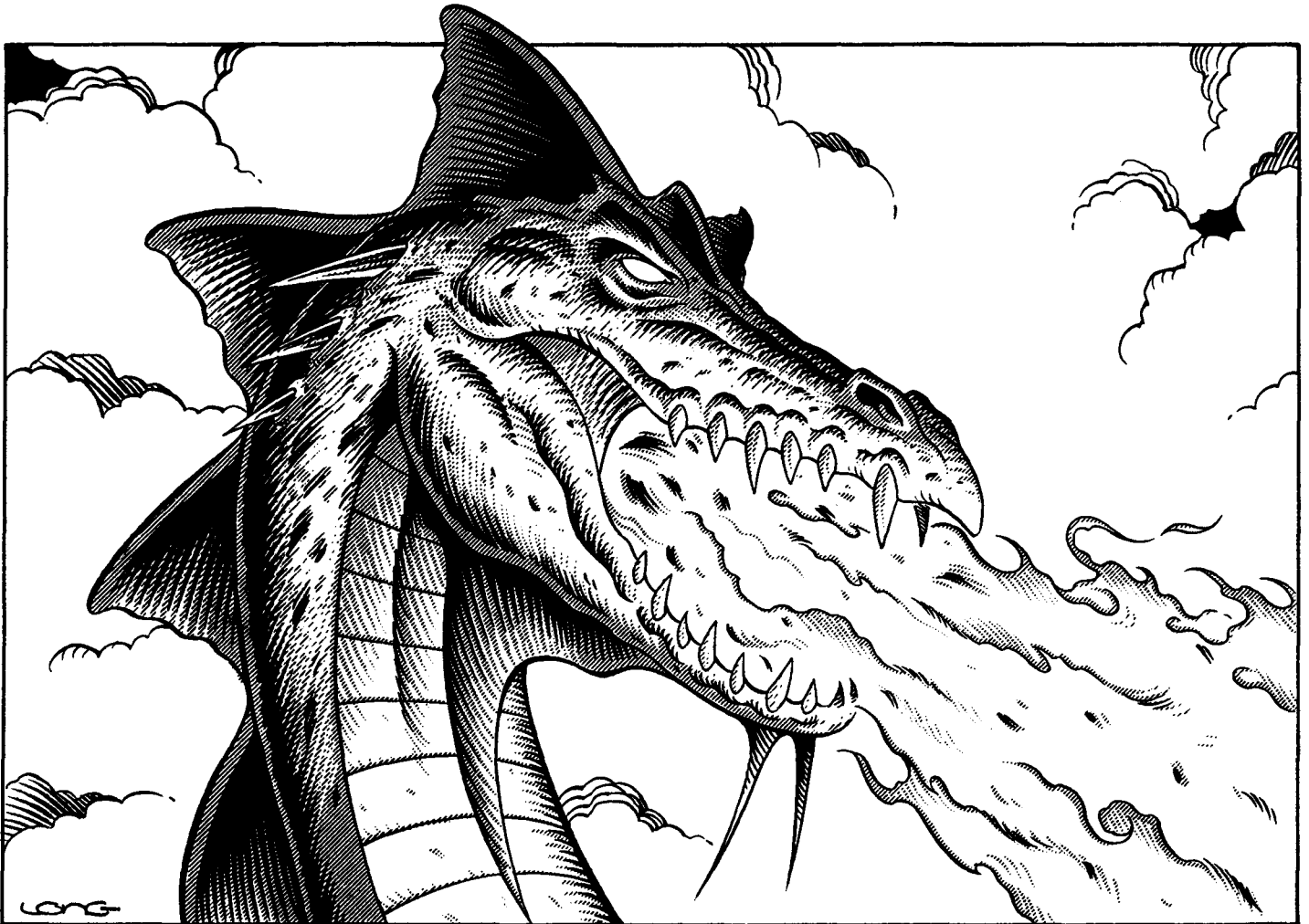

**Alignment:** Aberrant

**Species:** Fire Dragon (adult)

**Horror Factor:** 16

**Attributes:** I.Q. 21, M.A. 19, M.E. 14, P.S. 30, P.P. 19, P.E. 23, P.B. 18, Spd. 100 running or 180 flying.

M.D.C.: 2,000

**P.P.E.:** 300

**Natural Abilities:** Nightvision 100 feet (30.5 m; can see in total darkness), see the invisible, turn invisible at will, bio-regeneration 1D4×10 M.D. per minute, impervious to fire (does no damage), **teleport** self 88%, dimensional **teleport** 32% and metamorphosis at will (duration: 40 hours). Fire breath does 6D6 M.D. (200 feet/61 m range).

**Disposition:** Over the years, Rendell has regained some of his old personality, but only when dealing with his peers and underlings. Whenever he is faced with what he considers to be a superior, he immediately becomes servile and fearful; this includes **Inix** and **Malkhom**.

**Experience Level:** Equal to a 10th level ley line walker.

**Magic Knowledge:** All spell magic from levels 1-7, plus animate and control dead, turn dead, exorcism, resurrection, and remove curse.

**Psionic Powers:** Knows all sensitive and physical powers. **I.S.P.:** 100

**Attacks per Melee:** Eight hand to hand attacks per melee, or four fire breath and four physical, or two by magic.

**Bonuses:** +1 on initiative, +6 to strike, +5 to parry and dodge, +3 to roll with **impact/punch**, +3 to pull punch, +7 to save vs

magic, +3 to save vs psionics, +3 to save vs horror factor.

**Weapons:** Relies on his physical abilities.

**Armor:** None

**Description:** His natural form is that of a scarlet-red dragon with large wings and powerful limbs. His body is crisscrossed with scars that not even a dragon's powerful regenerative abilities can heal. When not in dragon form he prefers the shape of a giant Gatherer, since he most often deals with members of that race.

## Kastor

### Leader of the Gatherers

Kastor is the oldest Gatherer in the service of Cibola and is the clan leader who originally agreed to serve Inix, two thousand years ago. For over five hundred years, Kastor served Inix well, coordinating the activities of his Gatherers with the other raiders in **Inix**' service. Kastor also acted as the intelligence chief, using his minions to spy as well as to rob other places. Kastor was as happy as any Gatherer could hope to be — he could pick and choose from the loot of a hundred worlds.

Then Malkhom came along. The Gatherers were not as effective in the arts of espionage as other races. Their nasty habit of stealing anything that wasn't nailed down usually alerted people to their presence and they were unwelcome on most worlds. Malkhom was able to create a much more effective spy network, and Inix took the position of Chief of Intelligence away from Kastor and gave it to him.

The Gatherer remains in charge of the slaver and specimen raids that bring in much of the city's income, but Kastor resents the loss of power and prestige. He has been carefully planning his revenge on both **Malkhom** and **Inix** for over a century; he wants to hurt (not destroy) them without revealing himself or damaging his current position. To do this, he is prepared to give covert help to some of Cibola's enemies. Kastor will only help groups that can be an annoyance, but not a real threat. If he miscalculates, he might bring about his own downfall as well as that of the city.

**Alignment:** Miscreant

**Species:** Gatherer

**Horror Factor:** 13

**Attributes:** I.Q. 23, M.E. 18, M.A. 11, P.S. 23, P.P. 17, P.E. 22, P.B. 3, Spd 15

**M.D.C.:** 600

**P.P.E.:** 264

**Natural Abilities:** Nightvision 200 feet (61 m), see the invisible, turn invisible at will, bio-regenerates 1D6 M.D.C. per hour.

**Dimensional Teleport Powers:** 98% for well-known dimensions, 92% for dimensions he has visited at least once, 60% for "blind" teleports to a dimension gatherers are aware of but have never visited. Teleporting takes a melee round of concentration (no melee attacks, and defends at -2).

**Disposition:** Kastor is a greedy, conniving monster. He is a coward when it comes to fighting, preferring to attack from ambush or flee from his enemies only to return at a time of his own choosing. His favorite ploy is to teleport to another

dimension when things get nasty and come back and take his adversary by surprise. The Chief Gatherer is no fool and will not hesitate to fight if the odds are in his favor, or when he has no choice. A cornered or overconfident Kastor is a dangerous foe.

**Experience Level:** 14th level Gatherer

**Magic Knowledge:** Knows all spell magic levels 1-5, plus fire ball, impervious to energy, mask of deceit, reduce self, time slip, words of truth, agony, dispel magic barrier, invulnerability, life drain, hallucination, locate, metamorphosis: human, wisps of confusion, metamorphosis: insect, anti-magic cloud, time hole and close Rift.

**Psionic Powers:** Knows all sensitive powers, plus alter aura, ectoplasm, bio-manipulation, empathic transmission, group mind block, hypnotic suggestion, mind bolt, mind bond, mind wipe, P.P.E. shield, psi-shield, telekinesis (normal and super), telekinetic force field and telemechanics. I.S.P.: 112

**Attacks per Melee:** Five hand to hand attacks, or three by psionics or two by magic.

**Bonuses:** +3 to strike, +4 to parry and dodge, +1 to roll with impact/punch, +1 to pull punch, +4 to save vs poison, +4 to save vs magic, +3 to save vs psionics, +4 to save vs horror factor.

**Weapon Proficiencies:** W.P. Energy Pistol, W.P. Energy Rifle, W.P. Sword.

**Weapons:** A variety of energy weapons. Kastor is a qualified combat robot pilot.

**Armor:** Natural carapace. Sometimes wears personal force field belt (M.D.C. 130).

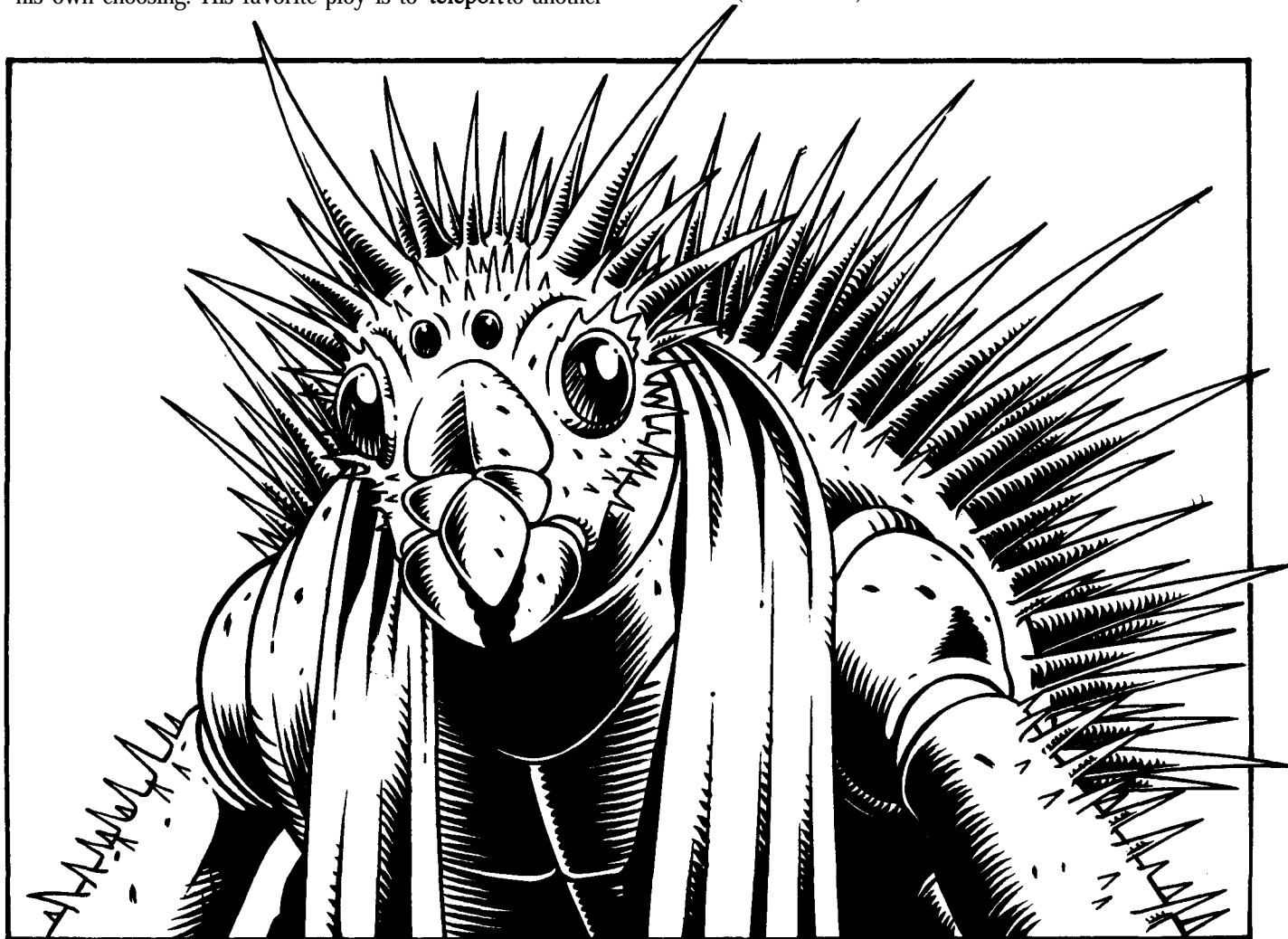

**Skills of Note:** Speaks **Dragonese/Elf, Demongogian, Creole, American, Ancient Greek, Galactic Trade Tongue I and II and Gobblely**, all at 98%; basic math, track animals and humans, land navigation, wilderness survival and demon and D-Bee lore, all at 98%.

**Description:** A round, squat creature with insect features and four arms. As Gatherers age, their **exo-skeleton** starts growing spines. **Kastor's** back is covered with them, making him look like a porcupine.

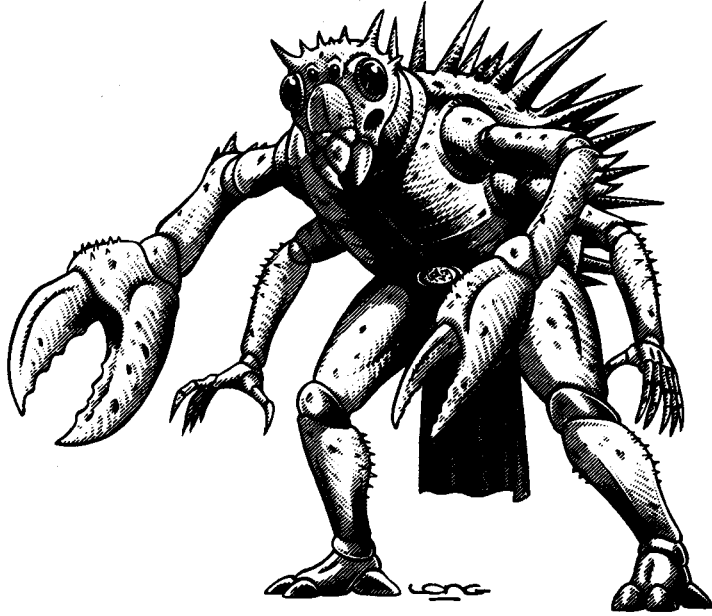

## The Gatherers Minions of Inix

The Gatherers are a race of squat, long-armed creatures that vaguely resemble a cross between a **humanoid**, a horny toad, and a lobster. They have two sets of arms; a smaller, humanoid pair with six-fingered hands, and a larger, clawed set. They are dimensional nomads that travel from world to world in packs, staying only long enough to collect any interesting items they might come upon. A good deal of the time, the items belong to someone else, but private property means little to most gatherers. Their natural dimension-traveling powers and their psionic tracking senses make them very adept at finding anything they decide to look for. The bands start with little in the way of technology and weapons, but as they travel from world to world, the more successful bands can become very well-equipped and powerful. Inix found a band of gatherers over 2,000 years ago and has gotten them to become very useful servants. Over the centuries he has recruited thousands of them.

The gatherers act as **Inix's** agents, thieves and occasionally spies, travelling to other worlds to find items or people the soul worm wants found. They also are **Cibola's** security officers and scouts. Gatherer-led patrols are sent into the Amazonian rain forest and the northern islands on scavenger missions searching for magical herbs, rare animals, plants, and sentient slaves. The gatherers' slave raids and thievery make them unwelcome throughout South America.

Note: The gatherer R.C.C. is not recommended for player characters. Most are brutal, treacherous and insanely selfish thieves with a total disregard for laws and property. Only soul worms, gatherer chiefs, and powerful beings can lead or control

them (even they will often attack or abandon their so-called master or friend the moment the creatures detect a sign of weakness). If the Game Master allows a gatherer player character, he will be the exception, not the rule. The character is instinctively selfish and a thief, with a tendency to hoard valuables and a great reluctance to share or help others. For this reason, unprincipled is the absolute best alignment possible; most are anarchist, miscreant or diabolic (rarely even aberrant). These characters will be viewed as either a member of a rival clan or as a self-serving rogue. Most other races throughout the Megaverse will treat the character as an untrustworthy thief or minion to a greater, more dangerous power.

**Alignment:** Any. Most gatherers in the service of Inix (which comprise over 90% of all gatherers on Rifts Earth) are anarchist or miscreant.

**Horror Factor:** 13

**Attributes:** I.Q. 4D6, M.E. 3D6+4, M.A. 3D6, P.S. 2D6+20, P.P. 3D6+2, P.E. 2D6+10, P.B. 2D6, Spd 4D6. Supernatural strength and endurance.

**M.D.C.:** 1D4X100+200 (carapace); mega-damage beings on Rifts Earth and magic rich environments.

**S.D.C./Hit Points (in S.D.C. environments):** 1D4X100+100 S.D.C., 1D6X10 Hit Points

**Natural Abilities:** Nightvision 200 feet (61 m), see the invisible, turn invisible at will, bio-regenerates 1D4 M.D.C. per hour.

**Dimensional Teleport Powers:** 88% for well-known dimensions, 64% for dimensions they have visited at least once, 32% for "blind" teleports to a dimension they are aware of but have never visited. Add +2% per level of experience to all those percentages (maximum 98%). **Teleporting** takes a melee round of concentration (no melee attacks, and defends at -2).

**Average Level of Experience:** 2D4+1

**Magical Knowledge:** Pick four spells from levels one to four at level one, and learn one additional spell per level of experience, of any level equal to or lesser than their current level of experience. Spells can also be learned or purchased (see Rifts, p. 164). P.P.E.: 3D6X10+P.E. attribute, plus 2D6 per level.

**Psionic Knowledge:** At level one, choose four psionic abilities from any psionic category (including super), with the exception of mind wipe, psi sword and possess other (available after third level), and select two more psychic powers for every new level of experience. I.S.P.: M.E. attribute plus 2D4X10+30; add 3D6 I.S.P. per additional level.

**R.C.C. Skills:**

Speaks **Dragonese/Elf** at 98%, and knows an additional five languages of choice (+20%)

Basic Math (+15%)

Track Animals (+20%)

Track Humans (+20%)

Land Navigation (+20%)

Wilderness Survival (+20%)

Demon Lore (+25%)

D-Bee Lore (+20%)

W.P.s of choice (select three)

Also select 8 "other" skills from any category, with a 10% bonus; remember, many are accomplished thieves with rogue skills.

**Combat:** Supernatural abilities. Five hand to hand attacks, or three by psionics or two by magic. Determine hand to hand

damage based on the creature's P.S. (see **Rifts Conversion Book One**, page 22); their clawed hands inflict an additional 1D6 M.D.

**Bonuses:** +2 to strike, +3 to parry and dodge, +1 to roll with punch, +2 to save vs magic, +3 to save vs psionics.

**Size:** 4 to 6 feet (1.2 to 1.8 m) tall

**Weight:** 200 to 500 lbs (90 to 225 kg)

**Natural Life Span:** 3,000 years

**Standard Equipment:** Two energy or **techno-wizard** weapons of choice, and melee weapon (often a vibro-sword or a magical weapon). A flying platform and other equipment is provided as needed.

**Money:** 4D6×1000 in credits and 1D4×10,000 in trade items.

**Cybernetics:** Usually avoided for fear of interfering with their magical abilities.

---

## Pogtalian Dragon Slayers

---

These powerful D-bees, alongside the pincer warriors, form the backbone of the Cibolan defense forces. Inix has hired thousands of dragon slayers as mercenaries to supplement his army. The two races are fierce rivals, both vying for the favor of their master. Duels between members of the two species are commonplace; many are fought in the arena for the entertainment.

**Pogtalians** are creatures of magic. Their native world is a lush wilderness of tropical and subtropical forests broken only by many swamps, marshes and the occasional desert and sea (no grasslands). The dominant life forms are dragons and dragon-like predators. The dragon slayers have evolved to survive in this hostile environment by becoming giants and developing a resistance to magic, as well as other features that enable them to combat their natural nemesis, the dragon.

The **pogtalians** live in small tribes of 20 to 100 members, with the majority living as nomads. Inix has visited this dimension very often and has established trading relations with one of the rare cities on this world. He sells them energy weapons, drugs and libations in return for captured dragons and monsters, dragon-skin armor, and raw materials.

Dragon slayers seldom terrorize unarmed humans or other tiny people. The giants are proud warriors and there is nothing to be proud of by slaughtering unarmed or inferior opponents. As warriors, they do not look for treasure or lord over other people. Instead, they seek adventure, challenges and combat. They love to fight dragons, powerful practitioners of magic, greater demons, giant monsters, giant robots, or against overwhelming odds.

The Pogtalians in Cibola are well trained in high-tech combat and are supplied with the best in weapons and equipment. Unlike the pincer warriors, they love using advanced weapons. The Cibolan technologists have even developed a set of powerful power armor designed to enhance the **Pogtalian's** incredible powers!

Note: Pogtalian player characters are possible — some Dragon Slayers have deserted from Cibola when ordered to commit dishonorable deeds, or they just reject the evil ways of the city. Others are escaped slaves or from tribes who do not associate with Cibola. Many simply seek adventure and new challenges. Most people in South America consider the **pogtalian**

dragon slayers to be dangerous **D-bee** monsters. The denizens of both Manoa and Omagua will attack a dragon slayer on sight, unless he is accompanied by other **humanoids** and is very careful about making aggressive or threatening gestures (which comes naturally to the species). Also, Pogtalians have been known to eat the flesh of humanoids (never of their own species), which adds to their bad reputation.

**Alignment:** Any, but leans towards anarchist. Most of those in the service of Cibola are anarchist or miscreant.

**Horror Factor:** 12

**Attributes:** I.Q. 3D6+1, M.E. 4D6, M.A. 3D6, P.S. 5D6+10, P.P. 4D6+2, P.E. 4D6+6, P.B. 1D6+1, Spd 4D6. Attributes are considered to be supernatural.

**S.D.C./Hit Points (in S.D.C. environments):** 1D4 x 100 S.D.C., Hit Points: P.E. x 5 plus 1D6 per level.

**M.D.C.:** 1D4×100; the giants are mega-damage beings on Rifts Earth and similar magic rich environments.

**R.C.C. Abilities and Bonuses:** Impervious to magic fire (including dragon fire), impervious to normal fire and cold, and special bio-regeneration can be used to instantly restore 1D6×10 M.D.C. three times per day (24 hours). The mouth is lined with large teeth; if a tooth is lost, a new one will grow to replace it in a matter of two weeks. The muscles and bone structure of the jaw enables the giants to unhinge the jaw (similar to many snakes) so that they can take massive bites and swallow large chunks of food. This also prevents the jaw from being broken. The mouth can be opened enough to inflict about a four foot by four foot (1.2 x 1.2 m) bite (6D6 M.D.). The giants have been known to snap off an entire hand from power armor or bots in a single bite.

**Energy Aura (special):** Pogtalians generate an invisible energy field that helps to protect them in combat. The creation of the field automatically engages, like an adrenaline rush, the instant the giant is frightened, angry, excited, or exerts himself. The invisible aura of energy adds 100 M.D.C. (subtract damage from this energy aura first) and covers anything the giant is wearing or holding. Depleted M.D.C. from the aura is restored within 24 hours.

The additional effect of the mega-damage aura is that the energy field turns ordinary, hand-held, S.D.C. weapons/items into *M.D.C. extensions of the Pogtal!* A strike from an S.D.C. giant sword, club, dagger or uprooted tree inflicts the normal punch damage of the Pogtal. Magical weapons inflict either the normal punch damage or the magical weapon's damage, whichever is greater.

**Bonuses:** +3 to save vs magic, +3 to save vs psionic attacks, +5 to save vs horror factor; supersensitive hearing is equal to the cybernetic amplified hearing and adds the bonuses of +1 to parry, +2 to dodge, and +3 to initiative (cumulative to his hand to hand and attribute bonuses). Great strength and agility provides one additional attack or action per melee.

**R.C.C. Skills:** Hunting, wilderness survival (+25%), land navigation (+20%), track animals (+20%, includes dragons and dinosaurs), skin and prepare animal hides (+20% large animals, +10% small), hand to hand: martial arts, swimming (+10%), W.P. Targeting, and W.P. Blunt and two W.P.s of choice (archaic if native to Pogtalia, any if trained in Cibola).

**R.C.C. Related Skills:** The Pogtalian can select six "other" skills at first level and two other skills at levels three, six, nine, twelve and fifteen.



Communications: Radio: basic and scrambler only  
 Domestic: Any (+10%)  
 Espionage: Tracking, sniper, intelligence only (+10%)  
 Mechanical: None  
 Medical (first aid or holistic medicine only)  
 Military: None  
 Physical: Any except acrobatics (+10% when applicable)  
 Pilot: Any if trained in **Cibola**, otherwise horsemanship and boats only.  
 Pilot Related: Any if trained in Cibola, none otherwise.  
 Rogue: Any if trained in Cibola, none otherwise.  
 Science: Math and astronomy only  
 Technical: Languages, literacy and lore only  
 W.P.: Any  
 Wilderness: Any (+10%)

**Size:** 3D6+10 feet (multiply by 0.3 for meters)

**Weight:** 1D6X1000lbs (1D6X450 kg)

**Average Life Span:** 300 years

**Standard Equipment:** Cibolan-trained Pogatians are equipped with a heavy energy rifle, dragon-skin armor (250 to 300 M.D.C.), and two or three archaic weapons such as swords, axes, clubs, etc.

**Money:** 2D6X1000 credits.

**Cybernetics:** Starts with none, but is not opposed to cybernetic augmentation.

---

## The Pincer Warriors Supernatural Minions

---

These supernatural monsters are the defenders of Cibola. Their origins are lost in the history of the Megaverse. Maybe they are the product of advanced bio-wizardry or the result of natural evolution in a hostile world. The pincer warriors served the same supernatural entity that once commanded the soul worms. After the downfall of their master, the pincer warriors became the soul worms' bodyguards and servants. **Inix** has recruited a larger number of pincer warriors than any other known being, soul worm or other. Having an army of thousands of these powerful creatures has helped safeguard **Inix**' independence.

The pincer warriors resemble metallic insectoids, not unlike the Xiticix warriors, but covered by long, slashing blades. Their instincts are much more brutal and bloodthirsty. Pincer warriors revel in combat and slaughter. They are utterly fearless and admire strength and power above anything else. As they get older and more powerful, these creatures grow larger (every level of experience after the first, add one inch (25 mm) to their height and 20 lbs/9 kg to their weight). The more kills they have to their name, the more powerful they become — some students of the supernatural believe these creatures are **para-demonic** creatures who feed off the life force of their kills, gaining more strength as they murder others. They tend to rely on their natural weapons, but are not above using energy rifles, heavy weapons, or flying platforms to travel faster.

**Note:** The pincer warrior R.C.C. is not recommended for player characters. Most Warriors are brutal, almost mindless creatures of instinct who consider all other sapient races as their legitimate prey. Only soul worms, gods and other supernatural

beings are powerful enough to intimidate and control them. If the Game Master allows a pincer warrior player character, he should be an aberration with higher than average I.Q. and an anarchist alignment (unprincipled or good alignments cannot be selected until the character shows incredible self-control). This abnormal creature will be persecuted by other pincer warriors, soul worms and gatherers as a misguided mutant **and/or** traitor. Most other races throughout the Megaverse will treat the character as a dangerous monster.

**Alignment:** Anarchist or evil.

**Horror Factor:** 13

**Attributes:** I.Q. 2D6+2, M.E. 3D6, M.A. 3D6, P.S. 4D6+20, P.P. 3D6+8, P.E. 3D6+12, P.B. 1D6+2, Spd 1D6X10. Supernatural strength and endurance.

**S.D.C./Hit Points:** 5D6X10 S.D.C. and 1D4X100 hit points (in non-M.D.C. worlds)

M.D.C.: A mega-damage creature on Rifts Earth and similar magic rich environments: 4D6X10+60 M.D.C., plus 1D4X10 M.D.C. per level of experience!

**Natural Abilities:** Nightvision 1000 feet (305 m), bio-regeneration 1D4X10 M.D.C. every five minutes and grows back lost limbs in 1D4 days, takes half damage from all energy attacks, including magic energy. The warriors are carnivores, but can go without food for months at a time without ill effect (they tend to gorge themselves when they can feed). This means they are often seen devouring those slain on the field of combat (but only after the battle is done).

**Combat:** Hand to Hand: Assassin.

**Number of Attacks:** Four at first level; additional attacks are gained as per the Hand to Hand: Assassin table.

**Damage:** Use the supernatural strength table (**Rifts Conversion Book One**, page 22), but add +6 M.D. to punches and kicks, due to its blade-like appendages, plus forearm slash does punch damage plus 4D6 M.D., and tackle/ram (using shoulder-mounted blades) inflicts 1D4X10 M.D.

**R.C.C. Skills:** The Pincer Warriors have very few skills. All speak **Dragonese/Elven** and **Demongogian** at 98%, plus two languages of choice (+10%), wilderness survival (+15%), climb (+10%), prowl (+15%), track human or animal (+15%), detect concealment (+10%), detect ambush (+10%) and two W.P.s of choice. Select one additional skill from the physical or wilderness category at levels four, eight and 12. Most cannot swim but are not frightened by water.

**Magic and Psionics:** None

**Size:** 9+ feet (2.7+ m) tall

**Weight:** 600 to 900 lbs (270 to 407 kg).

**Standard Equipment:** Most pincer warriors (60%) never carry weapons. 30% have one energy weapon of choice (usually a heavy plasma rifle or machinegun); an elite 10% (War Leaders, minimum I.Q. 13) have two energy weapons and a minor magical weapon or item.

**Money:** Starts with no money.

**Cybernetics:** Cannot get cybernetics; their regenerative abilities cause implants to be expelled within 1D4 minutes after the operation.





## Grimbor Ape-Men

### Optional Player R.C.C.

The Grimbor are native to the Palladium World, where they once dominated the Yin-Sloth Jungles and the Floenry Isles of that planet. However, unable to cope against attacks by more intelligent races and more powerful natural predators, their numbers have dwindled over the centuries. For more information about the Grimbor in their natural habitat, see the Palladium Role-Playing books **Adventures on the High Seas and Monsters & Animals** or **Rifts Conversion Book One**. In both shape and temperament, the grimbor are very similar to the Earth gorilla, except they are more intelligent, use tools and have been trained to use high-tech weapons, body armor, and basic equipment. They can be savage fighters, but their natural temperament is mild mannered and compassionate.

The alien intelligence Inix saw in this endangered species a potentially useful servant race and took steps to recruit large numbers of them. Using his shape-shifting spells, Inix assumed the form of a huge and powerful grimbor, and claimed to be a god and protector of these jungle people. Awed by the appearance of this "god," tribe after tribe of ape-men have sworn fealty to him. In less than a century, thousands of grimbor were transported via dimensional gates to the city of Cibola and outlying areas. Many of the tens of thousands of grimbor in Cibola roam the surrounding South American jungle in semi-nomadic tribes of hunter-gatherers. Every grimbor male who reaches adulthood owes several years of military service to Cibola. The ape-men are trained in the use of advanced weapons and made into scouts and guerrilla fighters.

The Cibolan grimbor are often used as cannon-fodder by Inix. Many tribes have been decimated, with most of their males away performing military service and others returning with crippling wounds and missing limbs that make them more of a burden than a help to the community. Despite this, most of these simple beings still worship Inix (in his grimbor guise) and do anything

the monster demands of them. The pincer warriors tend to pick on them, but the grimbor are respected by the pogtalian dragon slayers and friendships between the two races are commonplace. Sometimes mixed tribes of pogtalian and grimbor can be found in the Amazon wilderness and even traversing the Megaverse.

**Alignment:** Any, but usually good or selfish.

**Horror Factor:** 10

**Attributes:** I.Q. 1D6+3, M.E. 2D6, M.A. 3D6+2, P.S. 5D6, P.P. 2D6, P.E. 5D6, P.B. 2D6, Spd 1D6+1.

**S.D.C./Hit Points:** 1D6×100S.D.C., standard hit points.

**M.D.C.:** By body armor.

**R.C.C. Abilities and Bonuses:** Nightvision 40 feet (12.2 m), good color vision, track by smell 60% (males only), and swim 20%. They are terrible climbers. +6 to S.D.C. damage (in addition to P.S. bonuses), +1 to parry, two extra attacks per melee.

**R.C.C. Skills:** Grimbor in Cibola (males only) undergo military training and learn the following skills:

Language: Gobblely dialect 90%

Language: Dragonese/Elven (+15%)

Basic Radio (+10%)

Tracking humans and animals (+20%)

First Aid (+5%)

Weapon Systems (+5%)

W.P. Blunt

W.P. Energy Rifle

W.P. Energy pistol

Hand to Hand: Expert (cannot learn Martial Arts or Assassin)

**R.C.C. Related Skills:** Can learn an additional two skills at levels 3, 6, 9, 12 and 15. Automatically knows identify plants and fruits 60%, land navigation 80%, wilderness survival 80%, track animal 50% (males only) and carpentry 60%.

Communication: None (basic radio only)

Domestic: Any

Espionage: Wilderness survival only

Mechanical: None

Medical: Holistic medicine only (+5%)

Military: None

Physical: Any except acrobatics, gymnastics, and prowl

Pilot: Ground vehicles only

Pilot Related: None.

Rogue: Any except computer hacking

Science: Basic math only

Technical: Art, language and lore only

W.P.: Any

Wilderness: Any (+10%)

**Size:** 6 feet (1.8 m) tall when bent over walking on knuckles, 10 to 12 feet (3.0 to 3.6 m) tall completely erect.

**Weight:** 600 to 800 pounds (270 to 360 kg).

**Standard Equipment:** Cibolan scouts and warriors wear specially designed body armor with a built-in force field (120 M.D.C., plus 35 M.D.C. from the force field, unusable by normal humanoids), and carry an NE-10 plasma cartridge rifle and an ammo bandolier with 8 spare magazines, a high-tech version of their "yumbuto club" (an energized club that does 3D6 M.D. on a hit), a web belt for tools and equipment, and a first-aid kit.

**Money:** 1D6×100credits.

**Cybernetics:** Avoids getting them; in Cibola no Grimbor is forced to receive cybernetic, bionic or bio-wizard implants.

# Cibolan Weapons & Equipment

As a transdimensional trading center, Cibola has access to the weapons from a hundred different worlds. The only technology that is relatively scarce belongs to the **Splogorth (Kittani)** weapons are difficult to find and cost 20-30% higher than normal). Cibolan weaponsmiths have produced decent copies of many weapons produced on Rifts Earth, including Coalition and Northern Gun products. Most guns, however, are produced by **Naruni Enterprises**, a multidimensional weapons manufacturer (for more information about Naruni Enterprises and their weapons line, see **Rifts Mercenaries and Phase World**).

## NE-4P Plasma Cartridge Pistol

A pistol version of the rifle. It fires the same cartridges and inflicts the same damage but at a reduced range. It is very heavy and cumbersome for a pistol, but fans of firepower love it and the large grimbor and other Cibolan minions generally have superhuman strength so they have no problems with its use (humans are 2 to strike).

Weight: 6 lbs (2.7 kg)

Mega-Damage: 1D4X10 M.D.

Rate of Fire: Standard

Maximum Effective Range: 500 feet (152 m)

Payload: 10 shot magazine.

Black Market Cost: 25,000 to 30,000 credits. Each round costs 40 credits, so a full magazine costs 400 credits.

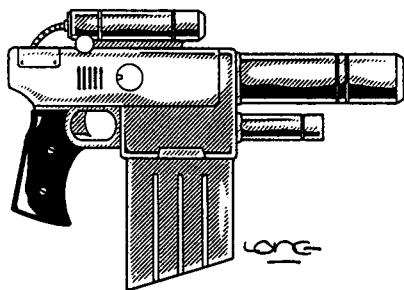

## NE-10 Plasma Cartridge Rifle

This weapon is an energy rifle that does not require an E-Clip. Instead, it uses thick cartridges that have a small impact primer. When the primer is hit by the mechanical weapon, the cartridge is converted into energy, causing a plasma discharge. The weapon inflicts a lot of damage, but has a limited range and the drawback is that the ammunition must be purchased from Naruni Enterprises. The gun's bore is almost two inches (51 mm) wide, so having it pointed your way is very intimidating.

The Cibolan soldiers are equipped with this weapon almost exclusively, both because they are very effective and because their ammunition can't be found anywhere else in South America, so deserters will quickly run out.

## NE-200 Plasma Cartridge Machinegun

This is a belt-fed, heavy version of the NE-10 rifle typically used as a tripod or vehicle-mounted weapon, but can also be used as an oversized rifle by power armor/cyborg troops, grimbors, gatherers, pincer warriors, and giants (that model typically uses a 40 shot magazine rather than belt-fed). The user of this

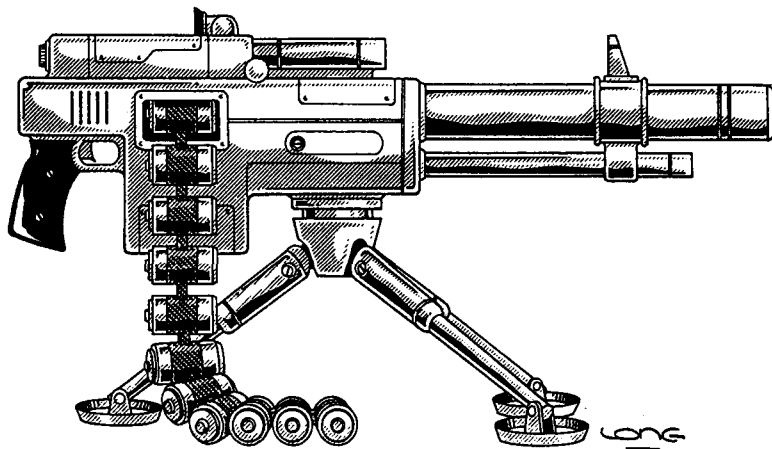

weapon must have a P.S. of 24 or greater, or have supernatural strength.

Weight: 70 lbs (31.7 kg). The belt weighs an additional 15 pounds (8.8 kg).

Mega-Damage: 1D4X10 per single shot, or 2D6X10 M.D. for a burst of 10 shots.

Rate of Fire: Standard

Maximum Effective Range: 2000 feet (610 m).

Payload: 200 shot belt or a 40 shot magazine.

Black Market Cost: 95,000 credits. Each round costs 40 credits, so a full magazine costs 1600 credits and a belt 8000.

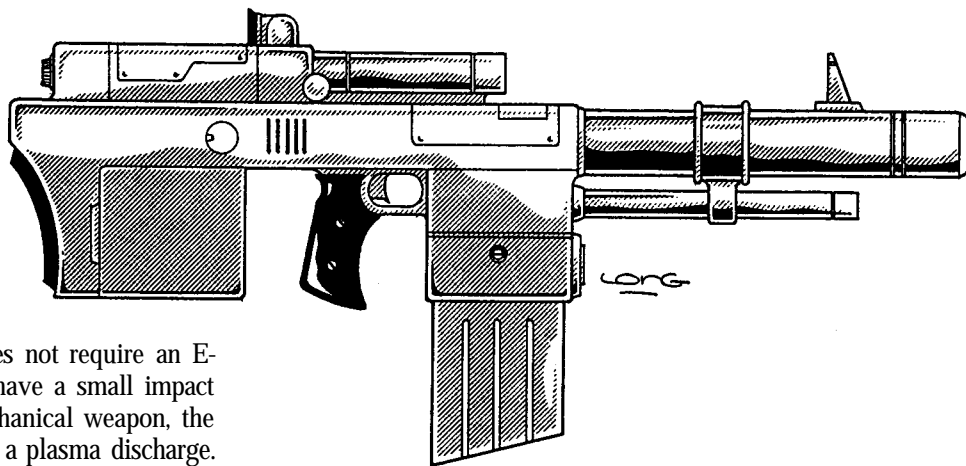

Weight: 20 lbs (9 kg)

Mega-Damage: 1D4X10 per single shot.

Rate of Fire: Standard

Maximum Effective Range: 1200 feet (366 m).

Payload: 20 shot magazine.

Black Market Cost: 40,000 credits. Each round costs 40 credits, so a full magazine costs 800 credits.



## Dragon Death Power Armor

This is a suit of power armor specifically designed with the **Pogtalian** dragon slayers in mind, although other giants who stand 18 to 24 feet (5.5 to 7.3 m) tall can also use it. The suit itself is 30 feet (9.1 m) tall, so most people will assume this is a robot vehicle rather than power armor. It has a draconic design, with a dragon-head crested helmet and clawed gauntlets. The power armor is designed for wearers with supernatural strength, which makes it more effective in hand to hand combat than most normal robot vehicles. Its special design also allows it to use the **Pogtalian's** natural force field. The only thing a dragon slayer can't use while in armor is his devastating bite.

This suit is a major element of the defense forces of Cibola. They are also sold freely in the city and in other **transdimensional** markets. A few have even made it to the **Splynn** Market, but only after being sold and resold in other dimensions; never bought directly from Cibola.

**Model Type:** DD-1000

**Class:** Strategic Armor Military Assault Suit

**Crew:** One

**M.D.C. by Location:**

Shoulder Missile Launchers (2) — 80 each

Arms (2) — 80 each

Legs (2) — 100 each

Plasma Cannon — 120

Jet Pack (on the back) — 120

\* Reinforced Helmet/Head — 110

\*\* Main Body — 350

\*\*\* Pogtalian Force Field — 100

\* Destroying the helmet of the power armor means the wearer's head is exposed to further attacks. Most giants are mega-damage creatures who can withstand at least 1/6 of their total M.D.C. damage to their head before being killed.

\*\* Depleting the M.D.C. of the main body will shut the armor down completely, rendering it useless.

\*\*\* A Pogtalian dragon slayer can extend his natural invisible force field around the power armor suit. This is not a power armor accessory; a wearer of another race will not be able to create this force field.

**Speed:**

**Running:** 100 mph (160 km) maximum. Note that the act of running does tire out its operator, but at 20% of the usual fatigue rate.

**Leaping:** The giant can leap 20 feet (6.0 m) high or 30 feet (9.0 m) lengthwise without assistance from the jet pack.

**Flying:** The rocket propulsion system enables the Dragon Death armor to hover stationary up to 200 feet (61 m) high or fly. Maximum flying speed is 300 mph (480 km) but cruising speed is considered to be 150 mph (240 km). Maximum altitude is limited to about 4000 feet (1220 m).

**Range:** The nuclear power system gives the armor decades of life, but the jet rockets get hot and need to cool after a maximum ten hours of flight when traveling at speeds above cruising, and after twenty-four hours of cruising speed, but can go indefinitely with rest stops.

**Statistical Data:**

**Height:** 30 feet (9.1 m) from the bottom of its feet to the dragon crest on its head.

**Width:** 16 feet (4.9 m) from shoulder to shoulder

**Length:** 9 feet (2.7 m)

**Weight:** 20 tons (18,000 kg) fully loaded.

**Cargo:** None.

**Power System:** Nuclear; average energy life is 25 years.

**Market Cost:** Six to twelve million credits; sold in **transdimensional** markets everywhere. It is highly coveted among many giant races.

### Weapon Systems

**1. Mini-Missile Launchers (2):** The heavily armored shoulder plates house 6 mini-missiles each.

**Primary Purpose:** Anti-Aircraft, Anti-Armor.

**Secondary Purpose:** Defense.

**Mega-Damage:** Varies with missile type. Usually carries plasma or armor-piercing missiles.

**Rate of Fire:** One at a time or volleys of two, four or six.

**Effective Range:** About one mile (1.6 km).

**Payload:** 12 total, six per launcher.

**2. Plasma Cannon:** A giant-sized plasma projector, connected to the suit's power supply. It can also carry a separate, giant E-clip.

**Primary Purpose:** Anti-Armor.

**Secondary Purpose:** Anti-Personnel.

**Mega-Damage:** 1D6×10 per blast, or 3D4×10 for a long burst (counts as two melee attacks).

**Rate of Fire:** Equal to the number of hand to hand attacks.

**Effective Range:** 4000 feet (1220 m)

**Payload:** Effectively unlimited. A giant E-clip has 20 shots, a normal E-clip has enough energy for 4 shots.

**3. Hand to Hand Combat:** Rather than use a weapon, the pilot can engage in mega-damage hand to hand combat. **Pogtalian**s and other giants with supernatural strength **already** inflict mega-damage from punches and kicks. Consequently, the damages listed below are in addition to damage inflicted by the giant's supernatural strength. **Bonuses:** One additional attack at levels one, six, and eleven. +1 on initiative, +2 to strike, +2 to parry, +1 dodge, +3 to dodge flying, +1 to roll with impact.

Full Strength Punch — 1D6 M.D.

Power Punch — 2D6 M.D., but counts as two melee attacks.

Claw Strike — 2D6 M.D. in addition to punch damage.

Kick — 2D6 M.D.

Leap Kick — 3D6 M.D.

Jet Assisted Body Slam/Ram — 1D6 M.D.

## Cibolan Flying Platform

Inix wanted to give his troops airborne capabilities, but did not want to spend a fortune on flying power armor suits. Jet packs were one option, but can be cumbersome and limiting, especially in a jungle environment. His weapon designers came up with a simple flying platform with handrails, a powerful plasma cannon, a missile launcher, and a force field for protection. The gatherers have fallen in love with the contraption. Flying platforms with one to three of these minions on board are a common sight over the city. Entire attack squads can be mounted on the platforms, which gives them added speed, mobility, **firepower**, and the ability to land and **takeoff** in small clearings. Enemies of Cibola have learned to dread the sight of a flying platform squadron skimming over the canopy.

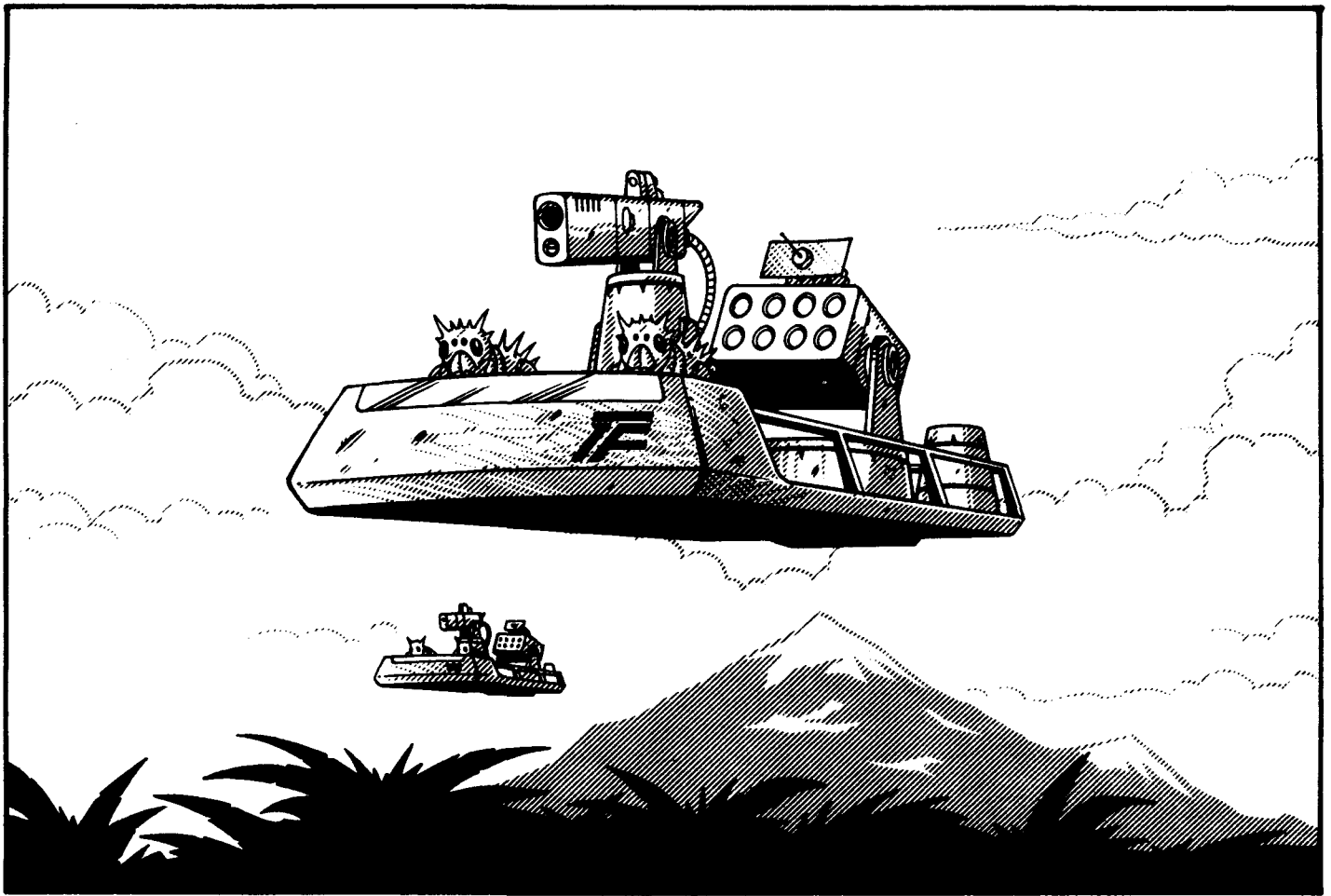

**Model Type:** FP-10

**Class:** Light Weapon Platform/Air Vehicle

**Crew:** One. Can accommodate one or two people in comfort, or up to four passengers under cramped conditions; reduce the pilot's skill by 15%, and all attacks from the platform are at -3.

**M.D.C. by Location:**

- \* Hand Railing — 40
- Missile Launcher — 30
- Plasma Cannon — 80
- \*\* Main Body — 85
- \*\*\* Force Field — 250

\* Destroying the hand railing will increase the risk that the pilot or passengers will be pitched out of the platform. The pilot still has a steering post, but without the railing the passengers have a 60% chance of falling if the platform speed is more than 50 mph (80 km). The hand railing is a very small target, requiring a called shot and is -4 to strike.

\*\* Destroying the M.D.C. of the main body totally destroys the platform.

\*\*\* Depleting the M.D.C. of the force fields depletes it for one hour; all other components become vulnerable to attack.

**Speed:**

Driving on the ground: Not possible, but can hover as low as three feet (0.9 m) above the ground.

Flying: 200 mph (320 km).

Maximum Altitude: 500 feet (152 m)

**Statistical Data:**

Height: One foot (0.3 m) thick; with hand railings it stands 6 feet tall (1.8 m).

Width: 9 feet (2.7 m)

Length: 10 feet (3.0 m)

Weight: 600 lbs (270 kg).

Cargo: Personal items can be fastened to the hand railing.

Power System: Nuclear; average energy life of 10 years.

Market Cost: 400,000 credits without weapon systems, 600,000 with.

**Weapon Systems**

**1. Plasma Cannon:** A medium-range plasma cannon used for strafing ground targets. The plasma discharge sometimes triggers forest fires, although the humidity of the rain forest usually prevents such incidents.

Primary Purpose: Assault

Secondary Purpose: Defense

• Mega-Damage: 6D6 M.D. per blast

Rate of Fire: Equal to the number of hand to hand attacks of the pilot.

Effective Range: 2000 feet (610 m)

Payload: Effectively unlimited

**2. Missile Launcher:** A mini-missile launcher is used for long-range attacks. A common Cibolan tactic is to have a ground observer identify the targets and then have a flying squad let loose with a volley of missiles to soften them up. The pilot can then follow up with strafing runs from the plasma cannon and/or additional missile salvos.

Primary Purpose: Assault

Mega-Damage: Varies with missile type. Usually plasma (1D6X10 M.D.).

Rate of Fire: One at a time or in volleys of two, four or eight.

Effective Range: About one mile (1.6 km)

Payload: 8 mini-missiles.

## Cibola's Drugs & Potions

**Inix** is one of the most successful drug dealers in the Megaverse. From magical potions to designer chemicals, Cibola has something for everybody. The overlord of the city has hundreds of alchemists, herbalists and scientists working full time to develop new drugs or refine old ones. Every drug of Earth, including cocaine, heroin, crack, barbiturates, amphetamines, hallucinogens, marijuana and some of the drugs described in the Rifts **Triax** world book, can be found in the city. Specialized drug dens welcome customers — as long as they can pay for the merchandise. Desperate addicts (especially humans and **D-bees**) willing to do anything for the next fix are a common sight in the seedier parts of the city.

Not all the chemicals sold in Cibola are addictive or harmful. Many have powerful medicinal or magical effects. Some powerful concoctions can turn normal humans into ultra-powerful beings far beyond the abilities of juicers or crazies — but Inix has become fascinated with both juicer and M.O.M. technology and is experimenting with both to add to the city's offerings and vices.

**Note:** In the game, as in real life, all addictive substances bring about nasty consequences for their users. Allowing one's character to become addicted to any drug will negatively affect his or her performance, stability and chances for survival.

## Magical Potions and Pills

### Dream

This potion comes in a golden bottle and is the most popular recreational drug on the market. Basically, dream brings to life the character's most wonderful fantasy for several hours, creating the most life-like dream he or she will ever experience. Addicts quickly lose touch with reality, going to any lengths to get another dose and return to their fantasy life.

**Duration:** 1D6 hours

**Bonuses:** Taking a dose of dream will sink the character into a deep sleep. The user will feel drowsy 1D6 minutes after imbibing the potion (reduce all attacks and bonuses by half), and will fall asleep 2D6 minutes later. The user will then be transported to a fantasy created by his own imagination; guaranteed to reflect his/her most coveted desires and fantasies. The drug-induced hallucination is utterly realistic and the character will be able to interact with elements of the dream as if they were real, except that everything will happen to fulfill his wishes. When another dose is taken, the character returns to where the previous dream left off — if that is what he wants. Otherwise, he can experience a completely new fantasy by concentrating on a new desire.

**Penalties:** The biggest problem with using dream is that, after a few doses, nothing in the real world feels quite as good. The addiction is quick and insidious; nobody is sure whether it is psychological, physical or both. Using dream more than once

a week requires a save of 16 or higher (add M.E. bonuses), or the user will find himself dissatisfied with reality and become lost to his fantasies. Real food will taste bland and unappetizing, life will seem ponderous and dismal, real thrills are blase. Nothing is good enough to satisfy him. The character will feel compelled to buy another dose of dream where everything is perfect, exciting and goes his way. The addict will soon be taking the drug daily (is 2 to save) and becomes completely withdrawn from the real world.

**Side-Effects:** Addicts who use the drug more than twice a week become lethargic and apathetic. They suffer 2 on initiative and 20% on all skill performance.

Long-time addicts (use dream regularly for six months or more) will find that if they don't take it daily, they will suffer horrible nightmares every time they sleep. In the nightmares, their fantasies are twisted and bring horror and agony. The experiences of those nightmares are as painfully realistic as the euphoric hallucinations. At this stage, the addict has to secure a daily dose of the drug or become insane. Some dream addicts even suffer fatal heart attacks during the nightmares. Many begin to lose touch with reality to the point that they take the drug two or three times a day, sleep whenever they aren't high, forget to eat or clean themselves and their habitats, quit their jobs (or get fired for terrible performance and many absences), get sick and die — usually from **malnutrition**, dehydration, or disease. Daily users have no initiative, skills are 40% and melee round actions and bonuses are half.

**Level of Addictiveness:** High

**Cost Per Dose:** 50 to 200 credits; the price seems to go up whenever the addict acts desperate for a new dose.

### The Energizer

This potion is very popular among mages. It has the effect of temporarily increasing and replenishing the user's P.P.E. base. However, the drug's "crash" period makes mages nearly useless until the side effects wear off and there is a danger that the drug will permanently reduce the character's P.P.E. base! A dose of the energizer drug (usually purchased in pill form) will replenish the character's P.P.E. pool, and raise it by an additional 2D6X10 P.P.E.! This extra P.P.E. must be used within one hour. At the end of that time, the drug's effects wear off, the P.P.E. is gone, and the side effects take place.

**Side-Effects:** The character not only loses the extra P.P.E., but he temporarily loses an additional 1D6X10 P.P.E. If it reduces the character's P.P.E. to zero, the character becomes extremely fatigued; reduce all attacks, bonuses and skills by half until the character rests for at least two hours. Additionally, there is a 3% chance (raised by an additional 2% every time the pill is used) that the character will lose 1D6 P.P.E. permanently and normal P.P.E. recovery now takes twice as long.

**Level of Addictiveness:** Medium

**Cost Per Dose:** 1,000 credits

### The Transformer

This alchemical potion transforms the drinker into a ferocious monster, complete with thick armored skin, supernatural strength, long claws and fangs. The creature varies from user to user and seems to reflect the dark side of the character's personality and/or his perception of power and a frightening **appear-**



ance. The user also becomes **supernaturally** fast and regenerates damage at an increased rate. While the effect is on, the character is an unsurpassed fighting machine. Problems occur after its effects have worn off.

**Duration:** 2D4+10 minutes.

**Bonuses:** When the drug is taken, the person becomes a monster and gains a foot (0.3 m) in height and about 300 lbs (135 kg) of weight in way of muscle and natural body armor. The transformed being has a mega-damage hide with 3D6X10 M.D.C., gets +10 P.S. points, supernatural strength, endurance and speed (multiply the character's normal speed by three) and is +2 to strike, parry and dodge. His claws do normal damage for supernatural P.S. plus an additional 2D6 M.D., and his bite does 4D6 M.D.

Furthermore, he regenerates damage at the rate of 1D6 M.D.C. per melee round. While the user is in the transformed state, he cannot use weapons or complex strategy and all skills are at -40%.

**Penalties:** When the drug's effect lapses, every muscle in the character's body aches and he feels absolutely exhausted. If forced to fight or engage in intense physical activity the character has only one attack per melee, no initiative, no bonuses, and will collapse within 1D6 melees (no matter what) and sleep for 1D4 hours.

**Side-Effects:** Using transformer more than three times a week will cause side-effects. The user will become more short-tempered than before, easily annoyed by every little thing that goes wrong. His reasoning ability will also be reduced: all skills are decreased by -5%. After two months of frequent use, there is a 2% chance (increased by 2% for every additional dose) that the transformation will become permanent! Permanently transformed characters will have their I.Q., M.E. and M.A. reduced by half, and all skills except wilderness survival, tracking and a few basic languages will be gone! The user will become a hot-tempered, simple-minded monster. It's up to the G.M. as to whether or not the character can maintain some level of control and be kept as a player character.

**Level of Addictiveness:** Medium

**Cost Per Dose:** 2,000 credits.

## Enhancer

This drug only works for psionic characters, temporarily jump-starting their power and energizing them.

**Duration:** Two hours or until the extra I.S.P. is spent, whichever comes first.

**Bonuses:** A single dose increases the character's I.S.P. by 2D4X10 points. Only one dose will work per 24-hour period.

**Side-Effects & Penalties:** The user must save vs poison (14 or higher). A failed roll means he gets "the shakes"; -3 to strike and parry, -20% to any piloting, computer or other skills that require hand-eye coordination and precise physical dexterity. The shakes last for 1D4 hours.

Those addicted to the drug will use it several times a week. They suffer from a lack of confidence when they are not "high and enhanced" which means they are 2 to save vs psionic attacks, mind control and magic illusions, 10% on all skill performance and are easily intimidated except when high on the drug.

**Level of Addictiveness:** High; becomes addicted if used more than once a week. Even weekly use can lead to addiction, but usually takes a bit longer.

**Cost per Dose:** 500 credits

## Lightning Nectar

This liquid drug can be ingested straight, mixed in a drink, or injected.

**Bonuses:** It temporarily grants the user 2D6X10 I.S.P. and one super psionic power! Only one dose will work per 24-hour period.

There are five different lightning nectars. Each is a different color for the power it grants (this is an artificial additive used to distinguish one drug from the next; sometimes mistakes are made, especially if bought from the black market or on the street).

Red lightning: Pyrokinesis

Blue lightning: Electrokinesis

White lightning: Hydrokinesis

Purple lightning: Bio-manipulation

Yellow lightning: Mind Bolt

No other powers are granted by this drug. If a minor or major psychic ingests the drug, he gains the extra I.S.P. and the psionic power. If a master psionic uses the drug, but already has the power, it can be used at half the normal I.S.P. cost and he still gets the additional, temporary 2D6X10 I.S.P. for the duration of the drug.

**Note:** The ingredients of this drug are a closely guarded secret, but are rumored to include brain tissue from psychic animals (and, some say, intelligent beings!).

**Duration:** The effect lasts for 1D4+2 hours.

**Side-Effects & Penalties:** After the effects wear off, the user has to make a save vs poison (14 or greater). If the save is successful, the character feels woozy, mildly depressed and is -2 to strike, parry and dodge, and -10% to all skills for 1D6 hours. On a failed save, the character is affected as above but for 1D6 days, and a second save (12 or greater) has to be made, or the character recovers I.S.P. at half the normal rate, suffers from a throbbing headache and loses 1D4 actions/attacks per melee round for 2D6 days!

**Level of Addictiveness:** Medium on the high side. The character will become addicted if the drug is taken more than twice a week. Frequent use causes the character's M.E. to be permanently reduced by one point per every *month* the drug is used more than four times.

**Cost per Dose:** 2,000 credits.

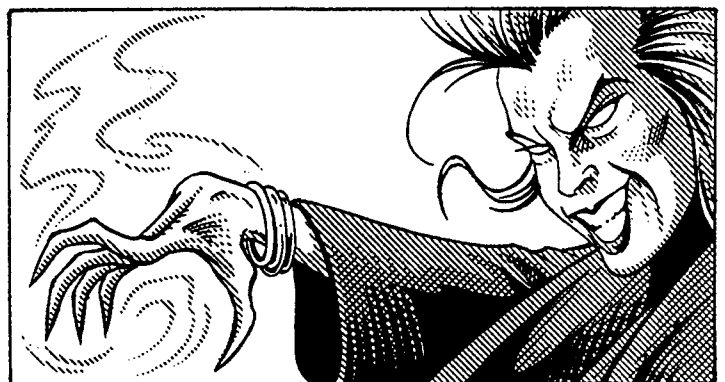

# The Rain Forest

With the exceptions of **Lagarto** and the three cities of El Dorado (Magua, **Manoa** and Cibola) there is no central government, king or people that dominates the vast jungle wilderness that covers much of Brazil, Bolivia and northern Peru. The rest of this huge land is mostly dense forest broken occasionally by large swamps and the rare savannah (grassland). It is sparsely populated by small nomadic and semi-nomadic tribes of humans, lizard men, jaguar people, werebeasts, and D-bees.

True nomads live by hunting and gathering. They travel in small tribes of 20-50 members and seldom stay in one area for more than a few weeks. Semi-nomadic tribes also hunt and gather, but most noticeably practice **slash-and-burn** agriculture, clearing tracts of jungle with **fire** and using the ashes as fertilizer. Since this practice quickly strips the nutrients from the land, the tribe has to move from place to place to give their former land time to recuperate. Semi-nomadic tribes are comparatively larger and have between 100 to 1200 individuals. They may settle in a particular area for one to four years before moving on.

Most of these people are the descendants of the once-vanishing Indian tribes of the Amazon who survived the Great Cataclysm and returned to the old ways of tribal, jungle life. There is a lot of diversity among these different human tribes and even more when one includes D-bees. Four main languages are spoken by the humans: **Awarak**, **Cariban**, **Ge** and **Tupian**. Creole is

used as a universal trade language between tribes and used to communicate with strangers; 80% of all natives speak Creole in addition to their native language and 40% also speak Spanish.

The cultures of these tribes vary widely, even among tribes that speak the same language and share the same ancestry. Some tribes are aggressive and violent towards outsiders, while others are shy or cautiously friendly. All of them utilize low technology, with almost no modern tools or weapons. Instead they use simple machetes, knives, spears and the bow and arrow. Some of the blade weapons are ancient **pre-Rifts** relics handed down from generation to generation. Only a handful of hunters use energy weapons and/or **vibro-blades** acquired in combat or stolen from pirates, bandits, adventurers or invaders.

Most tribes rely heavily on magic. A full 15% of the adult population are a wizards or priests of some sort. The most common types of magic practitioners include the tribal shaman (25%), other types of shaman (15%; see **Rifts Africa** for other shaman classes); **biomancers** (15%), totem warriors (15%), warlocks (10%), and mystics (10%). The remaining 10% consists of other diverse areas of magic such as the ley line walker, shifter, stone master, and temporal wizard, as well as evil magic practitioners like witches, necromancers and **ahunyain**. It is interesting to note that the **techno-wizard** and **druid O.C.C.s** are a true rarity in South America.

## Tribal Shaman O.C.C.

South American shamans act as a combination of priest and magician. Unlike typical priests, however, they worship a number of spiritual and elemental forces. The shamans of the rain forest are animistic: they believe that every living thing (and

many unliving ones) have spirits with which they can communicate. By performing the appropriate rituals, tribal shamans can communicate with plant and animal spirits, control and banish entities, and cast magic spells.

The shamans undergo ordeals in which they acquire their knowledge. These ordeals often involve fasting, meditation, the use of hallucinogenic plants, and physical torture. When a character has reached a new plateau of development (experience level), he must undergo an ordeal lasting at least 24 hours (the G.M. usually gets to pick the type of ordeal necessary; be fair and reasonable). During the ordeal, the character may be visited by spirits or visions, who provide him with information or insight (role-playing these visitations can be fun).

In post-Rifts South America, tribal shamans have become more influential and powerful than they ever were in the past. Most tribes are now either led by a shaman, or have a shaman as their second in command or a trusted advisor. Note: A biomancer, mystic or warlocks function as a tribal "shaman" but don't have any of the shaman O.C.C. abilities or bonuses.

**Alignment:** Any; but usually good or selfish.

**Attribute Requirements:** **I.Q. 9** and **M.A. 10**

### O.C.C. Abilities and Bonuses:

1. **Communicate with animal and plant spirits:** The tribal shaman can "speak" with animals and plants by reaching out to their spirits. The conversations are limited to things the animal or plant can understand, and will deal with very basic images and concepts (hunger, fear, rage, smells, flavors, etc.).

2. **Exorcism:** A successful exorcism will drive **out/banish** any entity or demon from a possessed person, animal, dwelling or area. The exorcised creatures cannot return to the place (or person) for at least 6 months and are likely to never return (86% likelihood of never returning). A successful exorcism performed in an area such as a graveyard, tomb, etc. will destroy all animated skeletons, corpses and mummies which inhabit the area of exorcism. Ghouls and zombies will be banished for 10 months, while the greater supernatural creatures, including lesser devils and demons, vampires, ghosts, wraiths and specters, are banished for six months.

The Rite of Exorcism requires 1-6 hours of prayer and meditation to perform, depending on the strength of the possessing/inhabiting force. The holy symbols of the priest's religion are necessary and it is wise to have assistants and bodyguards present in case fighting breaks out. Success ratio: 8% per level of experience. Can be attempted as many times as the priest wants.

3. **Turn Dead:** This rite is similar to exorcism, but it can be enacted in only two melee rounds (30 seconds) and affects only animated skeletons and corpses, mummies and ghouls. This ability enables the priest to turn/repel the dead by commanding them to leave in the name of his deity(s). The undead will stop what they were doing and go away. Vampires,



ghosts, wraiths, loas and specters may be temporarily kept at bay (a few feet away), hesitating for one or two melee rounds, but will not be otherwise affected. Demons and devils are not affected at all. Success Ratio: 20% at first level, plus 5% per additional level of experience.

4. **Spell Magic:** At first level select a total of six spells from levels 1-2 (see **Rifts RPG**, page 167). At second level select a total of three spells from levels 1-3. Upon reaching the third level of experience, the shaman can select three more spells from levels 1-4. Each additional level after the fourth, the shaman is limited to the selection of one spell from any of the levels, up to his corresponding experience level.

5. **P.P.E.:** The tribal shaman has 2D4X10 plus P.E. attribute number in P.P.E. Add 2D6 P.P.E. per additional level of experience.

6. **O.C.C. bonuses:** +1 to save vs poisons, drugs and disease, +2 to save vs horror factor.

#### **O.C.C. Skills:**

Speaks native tongue and Creole (98%)

Two additional languages (+15%)

Play Musical Instrument (+20%)

Monster/Demon lore (+15%)

Dance (+15%)

Track Animal (+10%)

Wilderness Survival (+15%)

Pilot: Boat and Sail (+15%)

W.P. Spear (limited targeting)

Hand to Hand: Basic

Hand to Hand: Basic can be changed to Hand to Hand: Expert at the cost of one "other" skill, or Martial Arts for the cost of two "other" skills.

**O.C.C. Related Skills:** Select six other skills. Plus select two additional skills at level three, one at level six, one at level nine, and one at level twelve. All new skills start at level one proficiency.

Communications: None

Domestic: Any (+10%)

Electrical: None

Espionage: Detect ambush and detect concealment only.

Mechanical: None

Medical: Holistic medicine only (+15%)

Military: None

Physical: Any

Pilot: Horsemanship or exotic animal and boats only.

Pilot Related: None

Rogue: Any except computer hacking

Science: Basic math only (+10%)

Technical: Art, language and lore only (+10%)

W.P.: Any

Wilderness: Any (+10%)

**Secondary Skills:** The character also gets to select two secondary skills from the list, at levels two, five, eight, and twelve. These are additional areas of knowledge that do not get the advantage of the bonus listed in parentheses. All secondary skills start at the base skill level.

**Standard Equipment:** One lesser biomancer, techno-wizard or energy weapon of choice, a small bag with minor possessions, another small bag or two to carry herbs and other items, a hunting/fishing spear, a knife or machete, sparse clothing (sometimes only a loincloth), and biomancer or light M.D.C. armor (worn only when adventuring or anticipating combat).

**Money:** 2D6X100 credits in trade items.

**Cybernetics:** None; never wants any and most avoid bio-wizard augmentation too.

## **Totem Warrior O.C.C.**

Totem warriors are specially gifted people who have acquired the mystical powers of their totem animal. Many South American cultures have mystical ceremonies where warriors find their spiritual guide, usually represented by an animal. The totem warrior goes beyond finding a spirit guide, he can actually gain superhuman powers granted by their totem animals!

These mystic warriors are often guided by and/or work with a tribal shaman. Most tribes have one tribal shaman and 1D6 totem warriors. Totem warriors are granted special privileges and status. They typically serve as the champions, defenders and avengers of their tribe. A few warriors have abandoned or lost their tribe and wander the land as lone adventurers.

**Alignment:** Any

**Attribute Requirements:** M.E. and M.A. 9 or higher. A high P.S., P.P. and P.E. are common but not required.

#### **O.C.C. Abilities and Bonuses:**

1. **Totem Gifts:** The character can call upon his totem spirit to infuse his body with supernatural powers. Summoning the power requires one melee round (15 seconds) of dancing. The dance imitates the behavior of the totem animal and invites it to enter his body.

When the power is invoked, the character becomes a mega-damage creature, with P.E.x5 M.D.C. plus 10 M.D.C. per level of experience. The character's strength becomes supernatural, enabling him to inflict mega-damage with hand to hand attacks. Other powers vary depending on the totem animal. All these powers and bonuses only exist when the totem warrior summons his totem animal. These powers last for five minutes per the warrior's level and can be invoked up to six times per 24 hour period. Each character has only one totem animal selected from one of the following.

- **Anaconda:** The huge constrictor snake of the Amazon provides +2D4 to P.S. attribute, 1D6X10 to M.D.C., +20% to climbing and swimming skills and can bear-hug enemies, inflicting 5D6 M.D. per each squeeze (each squeeze counts as one melee attack).
- **Crocodile:** +1D6 P.S., +2D6X10 M.D.C., +1 to save vs horror factor, hold breath for 2D4 minutes and can swim at 98%.



The mouth and teeth become inhumanly large and sharp, able to inflict 3D6 M.D. bite.

- **Falcon:** The warrior can fly as per the Fly as the Eagle spell, has superior vision 1000 feet (305 m), and grows claws that do an extra 1D4 M.D. in hand to hand combat. The character

is also +1 on initiative, +1 to strike, +2 to dodge and +1 to save vs horror factor.

- **Frog:** The character can leap 20 feet (6 m) high or lengthwise, can swim at 85%, swimming speed is double the warrior's running speed, can hold his breath for 4D4 minutes, and is +1 to dodge on land, +3 to dodge in or under water.
- **Jaguar:** +1D6 P.S., +1D6 P.P., 1D4X10 M.D.C., +1D6X10 Spd, nightvision 60 feet (18.3 m), and claws inflict an additional 1D6 M.D. The warrior is also +1 on initiative, +1 to strike, +2 to parry and dodge, +1 vs horror factor and +15% to climb and prowl skills.
- **Monkey:** +2D4 P.P., +2 to parry and dodge, +2 to roll with punch, fall and impact, has the climb skill at 88% and the acrobatics skill at 70%.
- **Tapir (South American Boar):** +2D6 P.S., +1D6 P.E., +5D6 to Spd, +2D4X10 M.D.C. and the identify plant skill at 80%.

2. **Bonuses:** Totem Warriors are +2 to resist possession and mind control, +2 to save vs magic and disease, and +3 to save vs horror factor.

#### O.C.C. Skills:

Speaks native language and Creole at 98%

Speaks one additional language (+15%)

Monster/Demon Lore (+10%)

Track Humans and Monsters (+15%)

Track Animals (+20%)

Wilderness Survival (+25%)

Dancing (+10%)

W.P. Archery and Targeting

W.P. Spear

W.P. One of choice

Hand to Hand: Expert

Hand to Hand: Expert can be changed to Martial Arts at the cost of one "other" skill.

#### O.C.C. Related Skills:

Select eight other skills. Plus select one additional skill at levels 3, 6, 9, and 12. All new skills start at level one.

Communication: Radio: Basic only

Domestic: Any (+5%)

Electrical: None

Espionage: Detect ambush and detect concealment only

Medical: Holistic medicine only

Mechanical: None

Military: None

Physical: Any (+5% where applicable)

Pilot: Boating, horsemanship and horsemanship: exotic animals only (+15%)

Pilot Related: None

Rogue: None

Science: Basic math only (+5%)

Technical: Any, except computer and photography.

W.P.: Any

Wilderness: Any (+10%)

**Secondary Skills:** The character also gets to select four skills from the previous list. These are additional areas of knowledge that do not get the bonus listed in parentheses.

**Standard Equipment:** Two lesser biomancer, techno-wizard or energy weapons of choice, a spear or bow and arrow, one or two knives, and machete, a small bag for minor possessions, a large sack, fishing line and hook, sparse clothing (sometimes only a loincloth), and biomancer or light M.D.C. armor.

**Money:** 1D6X100credits in trade items.

**Cybernetics:** Avoids them as being unnatural.

# Monsters of the Amazon

## The Ellal — South American Undead

Most South American tribes have elaborate rituals to bury or otherwise dispose of their dead. A reason for this is the existence of diabolic entities that can possess a dead body and turn it into a powerful, cannibalistic monster. In addition to the occasional dybbuk, South America is swarming with **ellal**. The **ellal** are entities who have existed on Earth for centuries. For some unknown reason they are attracted to and found in dangerous concentrations along the South American ley line system. Some (but by no means all) of the atrocities committed by ancient Spanish conquerors were the result of **ellal** spirits who took over the bodies of dead Spaniards (usually men who had died of disease or wounds but who hadn't been declared dead or discovered by their companions and went on to commit horrendous crimes to gain nourishment).

These creatures are barely intelligent in their invisible energy form, but when they possess a dead body, a new creature is spawned; one with great cunning and intelligence, and all the memories (but none of the personality) of the deceased. All **ellal** are diabolic, deriving enormous pleasure from acts of murder, torture and degradation. The longer they inhabit the corpse, the more powerful they become. South America has over a dozen **Ellal** who are 400-600 years old. These beings are the equivalent of a demon lord or minor deity in sheer power; some have set themselves up as god-kings and are worshipped by humans and D-bees.

To survive, the **ellal** must commit at least one murder a month. The victim must be alive and can be an intelligent creature of any age or race. Note: As long as a steady supply of victims is maintained, the **ellal's** host body will not decay and retains the age/appearance of the body at the time of death. Each murder provides a month's food; multiple murders have cumulative effects, so most **ellal** will try to kill as many people as possible to ensure their immortality.

**Ellal** who cannot find victims start to deteriorate; reduce P.B. by one point for every month of deprivation and reduce P.E. and P.S. by one point each for every two months without proper nourishment. P.S. and P.E. will be recovered at the rate of one point per month when feeding resumes, but P.B. is permanently gone — the body, once it starts deteriorating, cannot be restored to its former appearance. When P.B. is reduced to 3, the creature can never pass for human again, looking like an emaciated, mummified or rotting corpse with a dry stench (raise Horror Factor to 15). If P.E. is reduced to 0, the **ellal's** host body suffers all the decay it has been spared at once — centuries old corpses will turn into dust while those only a few years or decades old turn to dry bones.

Unlike other Undead, the **Ellal** can operate in daylight without harm. Normal weapons can hurt them, but only do one-third their normal damage. Silver weapons inflict mega-damage. Holy



weapons, Millennium Tree staves and wands, and **anti-Undead** bio-weapons all inflict triple damage. Destroying an **ellal** is still very difficult, because the creature regenerates damage even faster than a vampire. Reducing it to -21 points or greater will put it into a regenerative coma, but does not kill it! The only way to truly destroy the undead **ellal** is to reduce it to -200 M.D.C., or to perform an exorcism (spell, shaman or priestly ritual) after the creature has been brought into a coma (starting the exorcism ritual will prevent any further regeneration). A successful exorcism (if the **ellal** fails its save) will destroy the body and the parasitic entity both.

The banishment spell (see *Rifts*, page 183) will separate the **ellal** entity from the body, which causes the body to decompose immediately, but the entity is free to possess a new body (the powers of the new body start from scratch — the **ellal** becomes the equivalent of a first level monster).

Another way to deal with the **ellal** is to capture them and place them someplace from which they cannot escape, leaving them to starve to death. This can include a prison cell, pit, dimensional pocket, or even by encasing the thing in a block of mega-damage concrete or steel; while in a physical body the entity is trapped inside and is limited by that body. However, an imprisoned or inactive **ellal** can go into a stasis trance. As it remains in this dreamless sleep, its body does not deteriorate and can exist unharmed for centuries (3D6)! but when it awakens, it must feed within 12 hours or perish. This is usually bad news for whomever released the creature, although some necromancers have been known to release an imprisoned **ellal** and feed it human slaves in order to strike a bargain or partnership with the undead abomination.

**Alignment:** Diabolic only!

**Horror Factor:** 8 in energy form, 12 in human form but only when the creature is revealed as one of the undead.

**Attributes:** Energy Form: I.Q. 2D6+3, Spd (floating) 2D6X10, all others not applicable.

Animated Corpse Form: I.Q. 3D6+2, M.E. 3D6+3, M.A. 3D6, P.S. 4D6+6, P.P. 3D6+4, P.E. 4D6+6, P.B. 3D6, Spd 1D4X10. Supernatural strength and endurance. Add +1D4 to P.S., and +1 to P.E. and P.P. for every century of undead life.

**S.D.C./Hit Points:** Applicable only in S.D.C. environments. P.E.x10 plus 1D4X10 for every century as an undead.

**M.D.C.:** In a magic rich environment such as *Rifts* Earth, the **ellal** is a mega-damage monster. P.E.x10 M.D.C. plus 1D6X10 for every century of undead life!

**Natural Abilities:** Possess dead bodies, regeneration 1D4X10 M.D.C. per melee round, supernatural strength and endurance, sees through illusions, resistant to non-magical damage (takes one-third damage from all normal weapons, including mega-damage attacks). In energy form only: immune to normal weapons, invisible and incorporeal.

**R.C.C. Skills:** The **ellal** acquires the skills the possessed body had in life. These skills start at level one proficiency and increase one level for every fifty years the **ellal** continues to live in that body. If the corpse had any magic or psionic powers, they are also known and possessed by the entity, but, again, they start at first level strength. The entity in its energy form is instinctively attracted to mages and psychics; the average **ellal** has the powers of a practitioner of magic, mind melter or major psionic.

**Average Level of Experience:** 2D4, which also means the average age is 100 to 400 years old.

**Size:** Varies with the race of the body it has selected to inhabit.

**Standard Equipment:** Ancient **ellal** accumulate vast fortunes and often have a hoard of magical items and lost treasures, including gems, jewelry, rune weapons, scrolls and relics. Recently created **ellal** have only whatever they can scavenge or steal.

## Trelque-huecuve — Monster Squid

This creature was mentioned in native myths that were apparently based on a real monster. The **trelque-huecuve** (pronounced **trel-keh** ooh-eh-coo-veh) is a tentacled creature that resembles a giant squid. It can live both in fresh and salt water and is most commonly found near the mouth of the Amazon and large tributaries. Its favorite tactic is to lie at the bottom of a river and extend its tentacles, waiting for motion in the water. When a living creature swims by or even disturbs the water by splashing, drinking, filling a canteen, etc., the creature's finely tuned senses detect the motion and sends a grabbing tentacle after it. If the victim vigorously resists, more tentacles reach out to entangle it and drag it beneath the water, where the monster's beaked mouth can finish the job.

The monster squids sometimes grow large enough to sink medium-sized ships. Thankfully, such gargantuan specimens are very rare. Nobody actively hunts these monsters although they are edible and their oils can be used to make lamp oil, lubrication oils, and others. Running into them accidentally can have deadly consequences. **Note:** Although they resemble squids, the **trelque-huecuve** are not real squids; they have ten tentacles instead of eight and their body structure is different.

**Alignment:** Considered to be an evil predator.

**Attributes:** Low animal I.Q. 1D4, M.E. 1D6+2, M.A. 1D4, P.S. 40+1D6, P.P. 16+1D4, P.E. 20+1D4, P.B. 1D6, Spd 20+2D6 swimming.

**M.D.C. by Location:**

Mouth/Beak (1) — 80

Tentacles (10) — 100 each (300 for the giants)

Main Body — 400 (900 for the giants)

**Horror Factor:** 12 (16 for giants)

**P.P.E.:** 9

**Natural Abilities:** Sense movement underwater 88%, sense temperature changes of water, sense currents and direction of flow, exceptional hearing, and are surprisingly fast swimmers.

**Combat:** Up to five attacks per melee at any one target; ten attacks per melee total!

**Bonuses:** +1 on initiative, +4 to strike, +5 to parry, +4 to dodge with the tentacles, +1 to dodge with its entire body.

**Damage:** Tentacle grab: No damage but drags any victim with a P.S. 40 or less below water, towards its **mouth/beak**. Tentacle strike: 4D6 M.D. Power strike: 1D4X10 M.D. (counts as two attacks). Beak bite: 1D6X10 M.D. Giant specimens do +5 M.D.C. and can sink or drag small vessels below the waves.

**Average Life Span:** Unknown. Believed to live for centuries.

**Languages:** None

**Habitat:** Larger rivers, seas and oceans around the world, but seem most numerous at the northern and southern mouths of

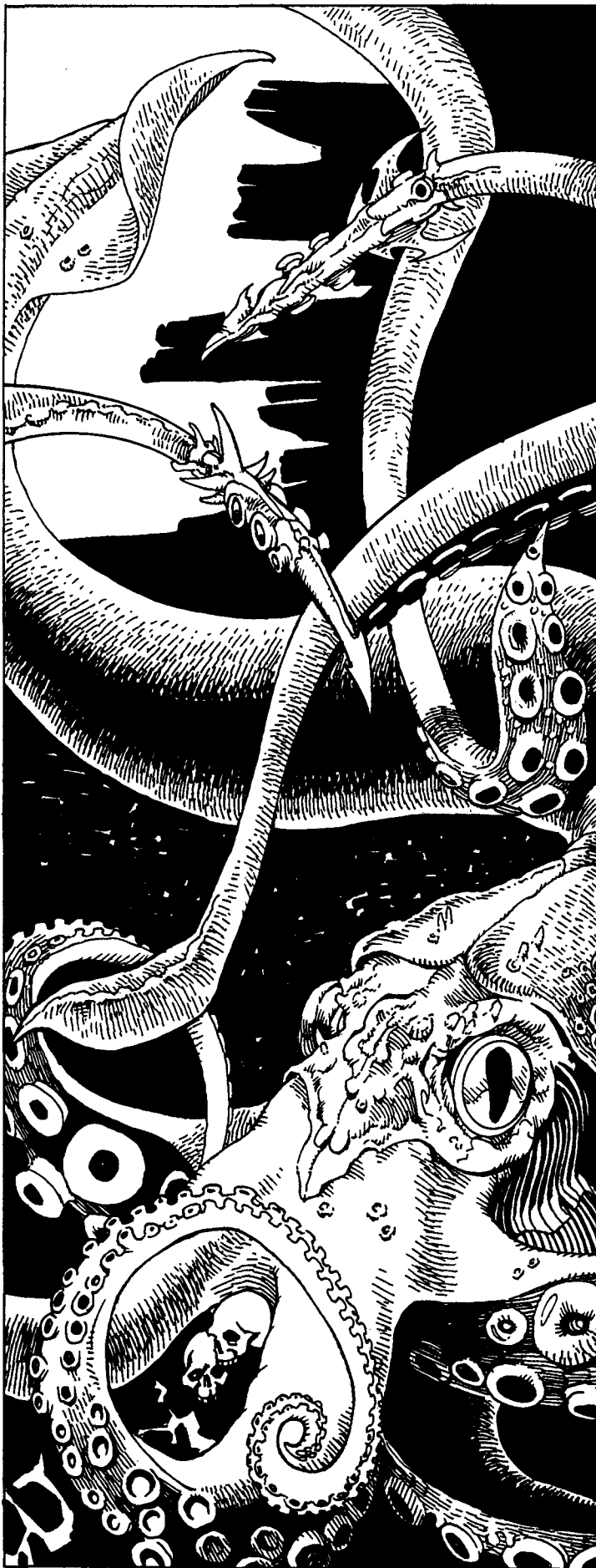

the Amazon, the Demon Sea (Bermuda Triangle), and South Atlantic along the coasts of Brazil, Argentina, and west Africa.

**Enemies:** Giant predators and humanoids.

**Size:** Between 30 and 300 feet long (9.1 to 91 m).

**Weight:** 600 lbs to 5 tons (270 to 4500 kg).

**Note:** Solitary predators.

## Huecu — Demonic Manta Ray

The huecu (pronounced *hoo-h-weh-koo-h*) is a creature of mythology that has returned to the world. The supernatural fish is carnivorous and seems to prefer to eat and kill intelligent beings, which has led to some theories that the creature is a P.P.E. vampire of some sort. This giant freshwater manta ray is a constant threat to river travelers and even people travelling on land near a river or stream. The huecu not only swims underwater, but can float on air currents above the water and fly for short distances!

Its meat is edible so some native tribes hunt this creature, turning predator into prey. Properly treated by smoking or drying strips of the meat, it can last for a very long time without spoiling, making it an ideal fare for nomads. The teeth of the huecu can be made into knives or spearheads that are able to parry M.D. weapons. For the most part, the huecu is attacked out of self-defense rather than profit.

**Alignment:** Considered to be an evil predator.

**Attributes:** Animal I.Q. 1D6, M.E. 10+1D6, M.A. 1D6, P.S. 30+2D6, P.P. 14+1D6, P.E. 16+1D6, P.B. 1D4, Spd 2D4X10 underwater, 5D6 flying, but it can only fly for 1D6 minutes at a time and has trouble maneuvering through dense forest.

**M.D.C. by Location:**

Stinger/tail — 60

Main Body — 225

**Horror Factor:** 11

**P.P.E.:** 10

**Natural Abilities:** Nightvision 200 feet (61 m), limited flight powers, poisonous stinger.

**Combat:** Four attacks per melee.

**Bonuses:** +1 on initiative, +4 to strike from the air, +5 to strike underwater, +5 automatic dodge underwater, +3 automatic dodge (flying); cannot parry.

**Damage:** Bite does 4D6 M.D., stinger does 3D6 M.D. plus poison inflicting 4D6 M.D., flying slam does 5D6 M.D.

**Average Life Span:** 60 years

**Languages:** None

**Habitat:** Rivers

**Enemies:** Humanoids, the *trelque-huecuve* and other monsters and giant predators.

**Size:** 60 feet (18.3 m) long from tip to tail, wingspan 40 feet (12.2 m) wide.

**Weight:** 1000 to 2000 pounds (450 to 900 kg).

**Note:** Solitary hunters.



FOG  
STEVE





## The Aunyain — Tusked Magicians

These boar-men are not members of an alien race, but humans who are transformed after making an unholy pact with an evil god known as **Aunyaina**. The alien intelligence transforms their bodies and grants them great magical powers in return for providing him with human sacrifices and fundamental services. The Aunyain boar-men have always been very rare, but after the

Coming of the Rifts more have been created than at any point in the history of the world. No less than 2,000 Aunyain wander the Amazon rain forest and another 1D6X100 can be found scattered around the Yucatan peninsula (see **Rifts Vampire Kingdoms**), as well as Mexico and the American south and west. The creatures are mainly concentrated on the Eastern Bank of the Amazon (3D6X100 at any given time), where they live in small families of 1D6+1 members. An individual aunyain or small family occasionally leads **D-bee** and human **indian** tribes and are sometimes worshipped as gods.

The Aunyain (pronounced **Ah-oon-jah-een**) have formed several cults in the jungle and often launch raids into larger settlements to carry off sacrificial victims. The tusked sorcerers are deadly enemies of vampires and the **ellal**, whom they see as competitors. Their inhuman master, Aunyaina, is not currently interested in Rifts Earth (too many forces are involved in this dimension already), only in a steady supply of sacrificial P.P.E. Some Aunyain have become allies of, or have been manipulated by, other supernatural beings and sorcerers, including necromancers, **goqua** and **sowki**.

**Alignment:** Diabolic or miscreant

**Horror Factor:** 13

**Attributes:** I.Q. 4D6, M.E. 3D6, M.A. 3D6, P.S. 3D6+4, P.P. 3D6, P.E. 4D6, P.B. 2D6, Spd 4D6. Supernatural strength and endurance.

M.D.C.: 3D6X10 plus 10 per level or experience.

**Natural Abilities:** Shadow meld at will (identical to the spell), resistant to energy attacks (takes half damage), can see in total darkness 400 feet (122 m), see the invisible, **metamorphosis** into a giant tapir (South American boar) at will, and bio-regenerate 1D6 M.D.C. per melee round.

**Average Level of Experience:** 1D4+2

**Magical Knowledge:** Knows six spells selected from levels 1-4 at level one, plus two spells from levels 1-8 per each additional level of experience.

**Psionic Knowledge:** None.

**Bonuses:** +1 to initiative, +3 to save vs magic and psionics, +4 to save vs horror factor, immune to possession and mind control.

**R.C.C. Skills:** Pick skills as per the Totem Warrior O.C.C.

**Size:** 6 to 10 feet (1.8 to 3.0 m)

**Weight:** 300 to 600 lbs (135 to 270 kg).

**Standard Equipment:** None; rely exclusively on magic.

## Ships of \_\_\_\_\_ South America

### Splugorth Slaver Raider

This is a fast amphibious landing ship, designed to rush towards a beach, release a group of attackers on light assault boats or slave barges, and then leave. During an emergency, the vessel can travel on land (**slowly**), doubling as a giant tank or Armored Personnel Carrier (APC). The Slaver Raider uses a hydrofoil system while travelling over water. The ship skims over the waves at speeds of over 100 miles (160 km) per hour and it can use a hovercraft system for even greater speeds over calm waters. Its design is a **Kyidian** and **Kittani** collaboration.

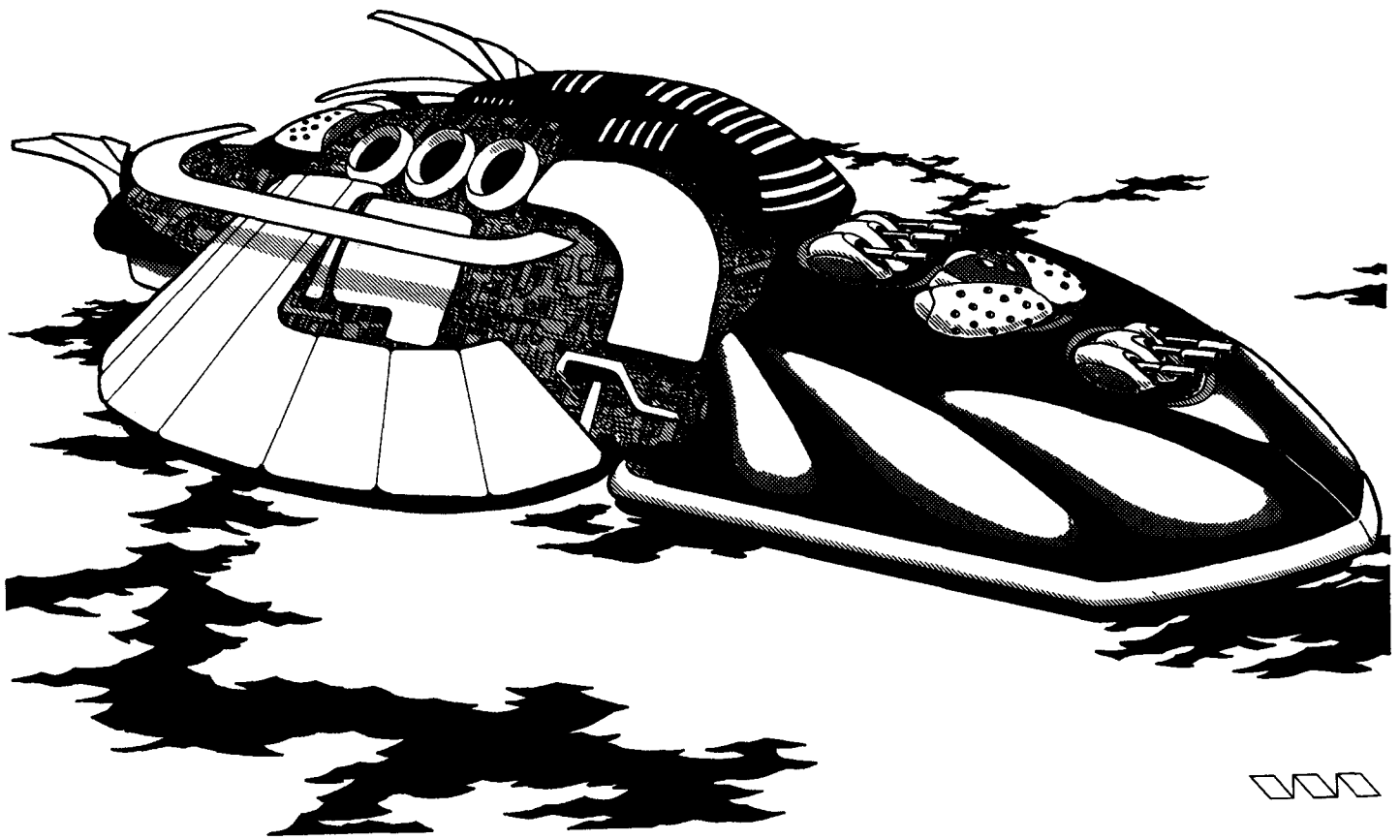

This is the ship of choice for **Splugorth Slavers** and **Blind Women Warriors**. Slaver Raiders can be encountered on coastlines around Africa, South America, North America/Canada and Europe.

**Model Type:** Kittani KY-HSS

**Class:** Hydrofoil/Hovercraft Assault Ship

**Crew:** Twenty-two total. A captain, two pilots, a navigator, two communications officers, two sensor officers, three petty officers, four weapons officers, and seven sailors (Kittani, Kydians or Altarians). It typically carries a company of 64 armored troops, usually Kittani Serpent or Equestrian power armor, plus 12 Splugorth Slavers on flying barges and 60 Blind Warrior Women (see **Rifts Atlantis** for descriptions).

Additionally, its cargo holds have room for 800 humanoid captives, in 100 special cells, complete with shackles and armored walls and doors. The cells will be uncomfortably cramped if more than four people are placed there, and downright nasty if they are filled to capacity. The Splugorth don't care. Often, the slaves are kept pacified with zombitron parasites, drugs, or shackles, especially if they are dangerous or have special powers.

**M.D.C. by Location:**

- Pulse Cannon Turrets (2) — 200 each
- Radar and Comm Towers (4) — 100 each
- Missile Launchers (2) — 120 each
- \*Command Bridge — 400
- Prison Cells (100) — 600 per wall
- \*\* Hull/Main Body — 2500

\* Destroying the Command Bridge will immobilize the ship and its main weapon systems until one of the Communications Towers comes on-line as a replacement. This will take 1D4 melees and even then the number of attacks per melee are reduced by two (slower) and communications are only at 80% efficiency.

Destroying the command bridge and all four of the communication towers will effectively cripple the ship, leaving it with two attacks per melee (-5 to strike), no long-range communications or sensors of any kind, and a maximum ocean speed of six miles per hour (9.6 km). Individual power armor troops can continue fighting, of course.

\*\* Depleting the M.D.C. of the main body will cause the ship to sink within 4D4 minutes. The sinking ship will create a whirlpool that will drag down anything in the water within 100 yards/meters of the vessel.

**Speed:**

Using Hydrofoil System: 100 mph (160 km)

Using Hovercraft System (only over calm waters): 400 mph (640 km)

On Dry Land: 40 mph (64 km)

**Statistical Data:**

Height: 55 feet (16.8 m)

Width: 65 feet (19.8 m)

Length: 200 feet (61.0 m)

Weight: 5,000 tons (4.5 million kg)

Cargo: Can carry up to 800 slaves and 500 tons (450,000 kg) of loot.

Power System: Nuclear; average energy life is 25 years.

Market Cost: Almost impossible to find. Would cost 500 million credits fully armed and loaded.

**Weapon Systems**

**1. Pulse Cannon Turret (2):** These triple-barreled pulse cannons are used for anti-ship or shore bombardment purposes. There are two turrets, both on the front section of the ship, one right below the bridge, and the other near the prow.

Primary Purpose: Anti-ship, anti-sea serpent and anti-aircraft.

Secondary Purpose: Defense

Mega-Damage: 1D4X10 for a single pulse, 2D4X10 for a dou-

**ble** blast or 3D4X10 for all three barrels firing simultaneously. Each single, double or triple blast counts as one attack.

Rate of Fire: Six per turret

Effective Range: 6000 feet (1830 m)

Payload: Effectively unlimited.

**2. Missile Launchers (2):** Two long-range missile launchers are built on turrets. One is near the rear section, the other is between the two pulse cannon turrets. The missiles are dual purpose and can attack underwater targets (these are specialty marine missiles that cost twice as much as normal missiles). Underwater, the missile speed drops to only 200 mph/320 km — still plenty to catch most water vehicles.

Primary Purpose: Anti-ship and anti-submarine or sea-serpent.

Secondary Purpose: Defense

Mega-Damage: Varies with missile type.

Rate of Fire: One at a time or volleys of two, four, six, eight, twelve or sixteen.

Effective Range: 500-1800 miles (800 to 2900 km)

Payload: 128; 64 per launcher, plus the missile magazine can be reloaded from the hold (the ships usually have a complement of 512 missiles total).

**3. Depth Charges (4):** Basically a bomb that is dropped into the water, sinks and detonates when it reaches a particular depth or hits an object. Four depth charge release units are concealed in the underbelly of the vessel; two in the forward section and two in the rear.

Maximum range/depth: 2000 feet (610 m) deep — automatically explodes at 2000 feet (or any depth between 200 and 2000 feet/61-610 m).

Mega-damage: 2D4X10 M.D.

Payload: 24 total; six for each launch unit.

## Splugorth Slaver Mothership

The Slaver Mothership is believed to be the largest oceangoing vessel currently on the planet — three times bigger than a 20th Century aircraft carrier! These vessels are more like floating cities than a ship. Only four Slaver Motherships are in use on Rifts Earth. Two are on long-range patrols of the Atlantic Ocean, one is on an exploratory mission in Asia and the last one concentrates on Africa, serving as a springboard for massive slave raids (in a pinch it can reach the South American coast in a week). 25% of the time, one of these four ships is in dry dock at Atlantis for preventive maintenance, refitting or repairs. The ship combines Kittani and Kydian designs and acts as the flagship for a fleet of smaller vessels.

This enormous ship has a strange design that vaguely resembles a four-legged creature with floaters on its feet. The main body of the ship is above water, resting on the four leg-like columns. Beneath the ship are docking spaces for up to eight KY-HSS Slaver Raider ships.

**Model Type:** Kittani KSM-100

**Class:** Dreadnought Combat Ship

**Crew:** 100 officers, 1200 ship crew. Additionally, the ship carries a defense force with the following troops:

- \* 960 Kittani warriors in Manling Power Armor with jet packs
- \* 240 Overlords in Overlord Power Armor
- \* 240 Blind Warrior Women
- \* 60 Splugorth Slavers

\* 60 Powerlords in Power Armor

\* Special Operations squad of 6 Conservators

\* 4-6 Murex or Volute Metzla (giant monsters, described in Rifts Atlantis).

The leaders of the marine force are usually 2-8 High Lords. This does not include the crews of the eight Splugorth Slaver Ships which add another 700 troops.

Slave Holds: These huge ships have four whole deck levels dedicated to holding the living cargo brought by the slaver ships. Up to 20,000 slaves can be carried in the 1,000 reinforced cells (20 humanoids in a cell under cramped conditions).

### M.D.C. by Location:

Main Missile Batteries (6) — 1200 each

Laser Turrets (8) — 700 each

Concealed Mini-Missile Launchers (12) — 140 each

Exterior Walls & Hatches — 200 per every 50 sq. ft (4.6 sq. m)

Interior Walls & Hatches — 100 per every 50 sq. ft (4.6 sq. m)

Holding Cells (1000) — 400 per wall (reinforced)

Support Legs (4) — 3400 each

Secondary Command Post & Communications — 1400

\*\* Main Command Post & Communications — 2800

\* Main Body — 28,000

\* Depleting the M.D.C. of the main body will cause the Mothership to sink within 3D6 minutes. The sinking ship will create a whirlpool that will drag down anything within 200 yards/meters.

\*\* Destroying the Main Command Post will immobilize the ship and its main weapon systems until the secondary command post comes on-line (this will take 1D4 melees). Destroying both posts will effectively cripple the ship's main systems, leaving it without its main missile launchers and long-range radar and communications. Individual gunners can continue fighting, of course.

### Speed:

Driving on the ground: Not possible.

On the Water: 40 mph (64 km) on the surface. It can submerge (usually done during very rough weather) and travel at 20 mph (32 km) underwater.

### Statistical Data:

Height: 400 feet/122 m (100 feet/30.5 m of the height are the four support pillars).

Width: 800 feet (244 m)

Length: 800 feet (244 m)

Weight: 300,000 tons (270 million kg)

Cargo: Up to 20,000 slaves

Power System: Nuclear; average energy life of 20 years.

Market Cost: Never sold; it would go for 100 billion credits or higher!

## Weapon Systems

**1. Main Missile Batteries (6):** These are giant turrets that fire volleys of long-range missiles. The firepower from those 6 batteries alone will sink most vessels on Rifts Earth before they even detect the mothership! **Note:** If the M.D.C. of a missile battery is depleted, its missile magazine will explode, inflicting 1D4X1,000 to the ship's main body. The missile batteries are controlled and directed from the command post.

Primary Purpose: Anti-Ship and Anti-Aircraft.

Secondary Purpose: Anti-Personnel and shore bombardment.

Mega-Damage: Varies with missile type. Can use any type of long-range missiles.

Rate of Fire: One at a time or in volleys of 4, 8 or 12 missiles per battery — 72 missiles (6X12) can be fired per melee round!

Effective Range: Varies; 500 to 1800 miles (804 to 2893 km).

Payload: 120 missiles per battery! That's 720 missiles total. The cargo hold of a slaver ship usually carries an additional 8,000 missiles; reloading the missile magazines takes 20 minutes.

2. **Mini-Missile Launchers** (12): Concealed beneath each of the six main missile stations are a pair of mini-missile launchers. These missiles are primarily for self-defense against comparatively close range missile, aircraft and power armor attacks.

Primary Purpose: Anti-Missile and Anti-Aircraft.

Secondary Purpose: Anti-Personnel and defense.

Mega-Damage: Varies with missile type. Can use any type of mini-missile, usually armor piercing (1D4X10 M.D.) or plasma (1D6X10).

Rate of Fire: Volleys of 2, 4, 6 or 8 per launchers; automatically reloads.

Effective Range: Varies; about one mile (1.6 km).

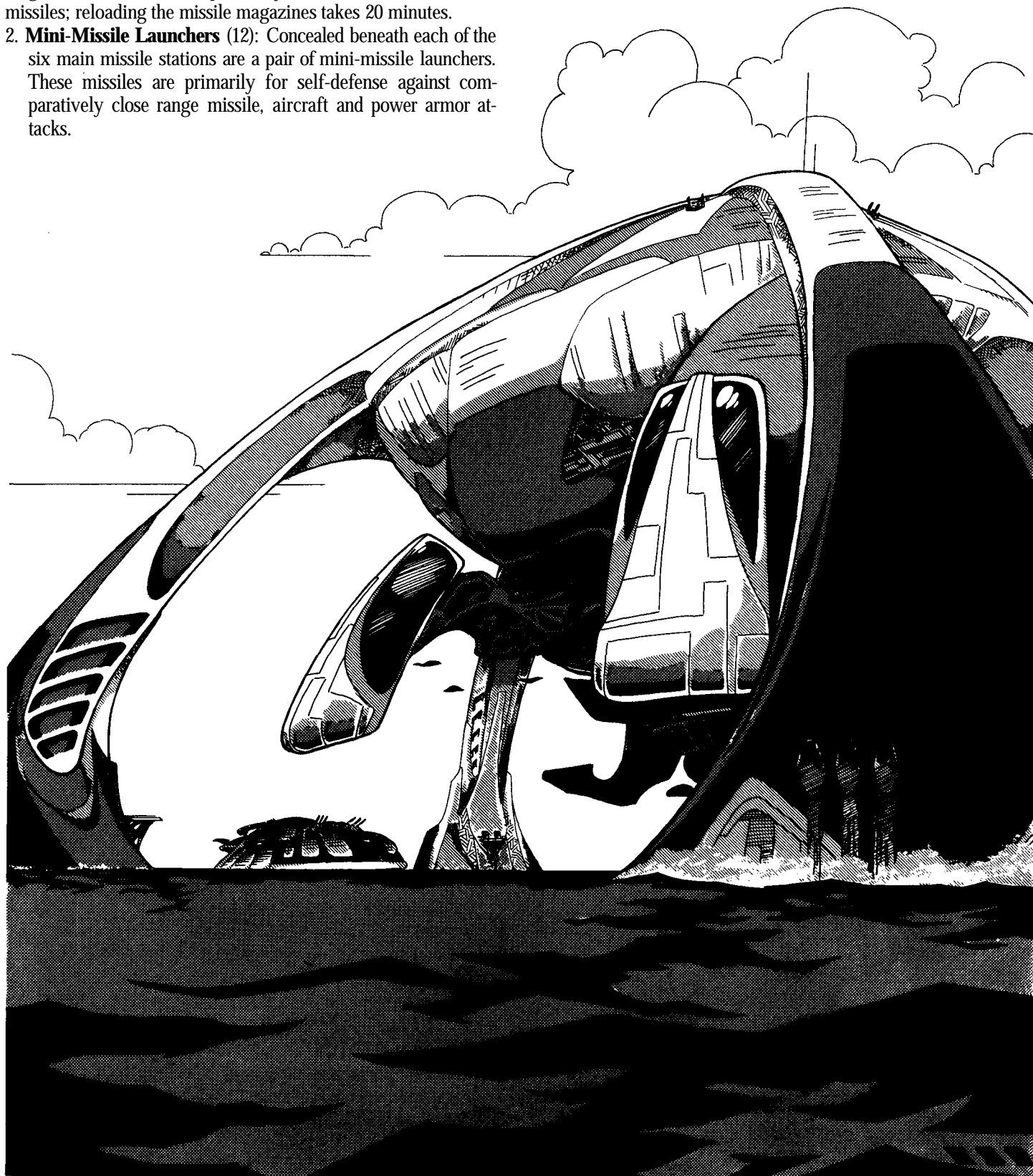

Payload: 960 missiles total. 80 missiles per launcher! The cargo hold of a slaver ship usually carries an additional 2,400 mini-missiles; completely reloading the missile magazines takes six minutes.

**3. Laser Turrets (8):** These are 8 laser turrets with very high-powered laser cannons. They are used mostly to eliminate airborne threats. The laser batteries can be operated from the Command Post or fired by gunner crews inside the turret itself.

Primary Purpose: Anti-Aircraft/Dragon and Anti-Missile.

Secondary Purpose: Anti-ship and defense.

Mega-Damage: 2D6×10 M.D. per blast.

Rate of Fire: Equal to the number of hand to hand attacks of the gunner or two attacks each when fired from the Command Post.

Effective Range: 10,000 feet (3050 m)

Payload: Effectively unlimited.

**4. Medium Torpedo Launch Tubes (6):** Located on the underside of the giant vessel. A concealed panel slides open and drops the torpedo into the water. The torpedo automatically speeds away to find and destroy its target. Torpedoes travel at 200 mph (321.8 km).

Primary Purpose: Anti-Submarine & Sea Monsters.

Secondary Purpose: Defense

Mega-Damage: 2D6×10 M.D. (plasma)

Effective Range: 10 miles (16 km).

Payload: 150 total; 25 per each launch tube.

Note: 2 to strike a target farther than two miles (3.2 km) away, but +3 to strike targets within its optimum range.

**5. Depth Charges (4):** Basically a bomb that is dropped into the water, sinks and detonates when it reaches a particular depth or hits an object. Four depth charge release units are concealed in the underbelly of the vessel; two in the forward section and two in the rear.

Maximum range/depth: 2000 feet (610m) deep — automatically explodes at 2000 feet (or any depth between 200 and 2000 feet/61-610 m).

Mega-Damage: 2D4×10 M.D.

**6. Armed forces:** In addition to the weapon systems, the troops aboard the mothership can deploy to defend it or to attack other sea vessels, aircraft, and island or coastal installations. Attackers have to deal with over a thousand warriors, monsters and wizards.

## Corsair Hydrobike

This hydrofoil, one-man, open vehicle is popular among pirates and river adventurers. The little "water bike" is brimming with weaponry, is very fast, and surprisingly quiet, making it ideal for raiding parties and espionage.

**Model Type:** CHB-5

**Class:** Personal Amphibious Assault Vehicle

**Crew:** One; a passenger can sit behind the pilot.

**M.D.C. by Location:**

Mini-Missile Launchers (2) — 25 each

Rocket Gun — 50

Concealed Forward Laser (1) — 25

\*\* Main Body — 126

\*\* Depleting the M.D.C. of the main body destroys the bike, making it useless.

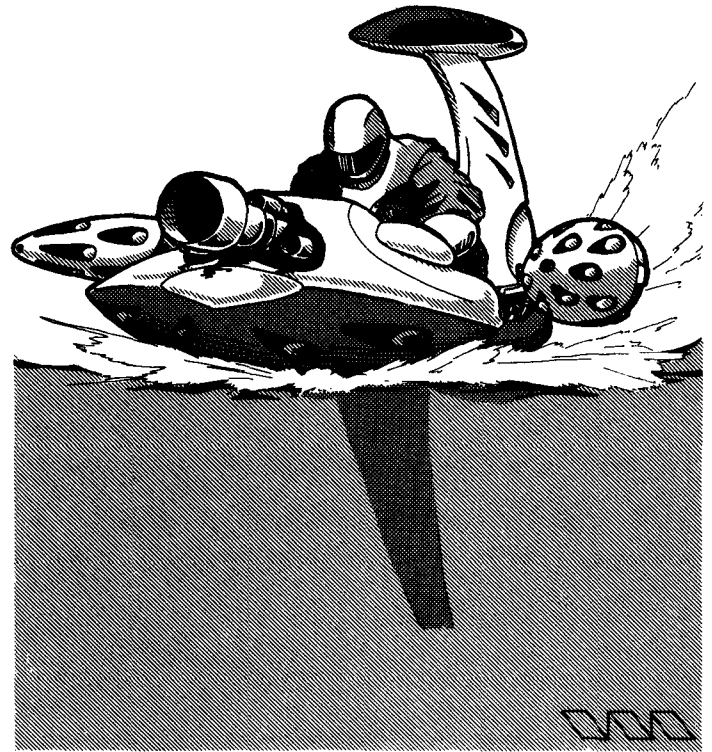

Speed:

Driving on the ground: Not possible.

On the Water: 60 mph (96 km)

**Statistical Data:**

Height: 5 feet (1.5 m)

Width: 3 feet (0.9 m)

Length: 8 feet (2.4 m)

Weight: 600 lbs (270 kg)

Cargo: Small, watertight, briefcase size area.

Power System: Gasoline.

Market Cost: 20,000 to 30,000 credits depending on the seller and availability.

### Weapon Systems

**1. Mini-Missile Launchers (2):** A mini-missile launcher is mounted on each side of the bike.

Primary Purpose: Assault

Secondary Purpose: Defense

Mega-Damage: Varies with missile type.

Rate of Fire: One at a time or volleys of two or four missiles.

Effective Range: About one mile (1.6 km).

Payload: Eight missiles, four per launcher.

**2. AC-15 Rocket Gun:** A rocket machinegun is mounted on the front of the bike.

Primary Purpose: Assault

Secondary Purpose: Defense

Mega-Damage: A round does 4D6 M.D. An 8-round burst inflicts 8D6 M.D. A long burst is 20 rounds and inflicts 2D6 x 10 M.D.

Rate of Fire: Standard

Effective Range: 2000 feet (610 m)

Payload: 100round belt.

**3. LC-20 Laser Gun:** Concealed under the rocket gun is a small, short-range laser gun.

Primary Purpose: Assault

Secondary Purpose: Defense

Mega-Damage: 3D6 M.D. per blast

Rate of Fire: Standard

Effective Range: 900 feet (274 m)

Payload: 20 shots per standard long E-clip.

## Piranha Submersible Attack Boat

This is a relatively small and very fast attack vessel, one of the last pre-Rift designs that were in service at the time of the Great Cataclysm. All of the few Piranha attack boats existing on Earth are ancient vessels that have been repaired by enterprising sailors and pirates, some of them descendants of the original crews! All Piranha boats are in the hands of pirates, smugglers, or adventurer parties. Both the Republic of Colombia and the Silver River Republics would like to acquire a complete sub and see if they could duplicate its manufacture.

The Piranha has two modes of travel. Underwater, with decent speed, and above water where it functions like a turbine-driven hydrofoil system that lets the ship skim over the waves at great speed.

**Model Type:** PTB-20AB

**Class:** Submersible Attack Boat.

**Crew:** Four: Pilot, copilot/gunner, communications/sensor officer, engineer. Can accommodate up to 20 passengers/troops.

**M.D.C. by Location:**

\* Hydrofoils (3) — 50 each

\*\* Sensor System — 100

Rail Gun Turret — 150

Missile/Torpedo Launchers (2) — 100 each

\*\*\* Main Body — 600

\* Destroying the hydrofoils prevents the ship from using the hydrofoil propulsion system although it can still surface and travel at a speed of 40 mph (64 km). The hydrofoils are very small targets, requiring a called shot at -4 to hit.

\*\* Destroying the sensor system eliminates all the radar and targeting bonuses; pilot and gunner are now limited to their

own senses. The sensor system is a small target, requiring a called shot at -3 to hit.

\*\*\* Destroying the main body causes the ship to sink in 1D4 minutes.

**Speed:** 40 mph (64 km) underwater or on the surface with the conventional propulsion system, or 80 mph (128 km) using the hydrofoil system.

**Statistical Data:**

Height: 25 feet (7.6 m)

Width: 21 feet (6.4 m)

Length: 100 feet (30.5 m)

Weight: 60 tons (54,000 kg)

Cargo: Up to 4 tons (3600 kg) of material.

Power System: Nuclear; average energy life 20 years.

Market Cost: 300 million credits; very hard to find.

### Weapon Systems

**1. Rail Gun Turret:** This gun is mounted on the prow of the vessel. The turret is capable of 90 degree rotation in all directions.

Primary Purpose: Anti-Ship & Anti-Aircraft.

Secondary Purpose: Defense

Mega-Damage: A burst is 80 rounds and does 1D6X10 M.D. Only fires bursts.

Rate of Fire: Equal to the number of hand to hand attacks of the gunner.

Effective Range: 4000 feet (1220 m)

Payload: 8000 rounds; that's 100 bursts. Can be reloaded with another ammo canister within one minute.

**2. Missile/Torpedo Launchers (2):** These side-mounted launchers can fire either regular medium-range missiles or special amphibious missiles (same damage as equivalent missile, double cost, but can travel to underwater targets and are +2 to strike). Missile speed underwater is 120 mph (192 km).

Primary Purpose: Anti-Ship.

Secondary Purpose: Shore Bombardment.

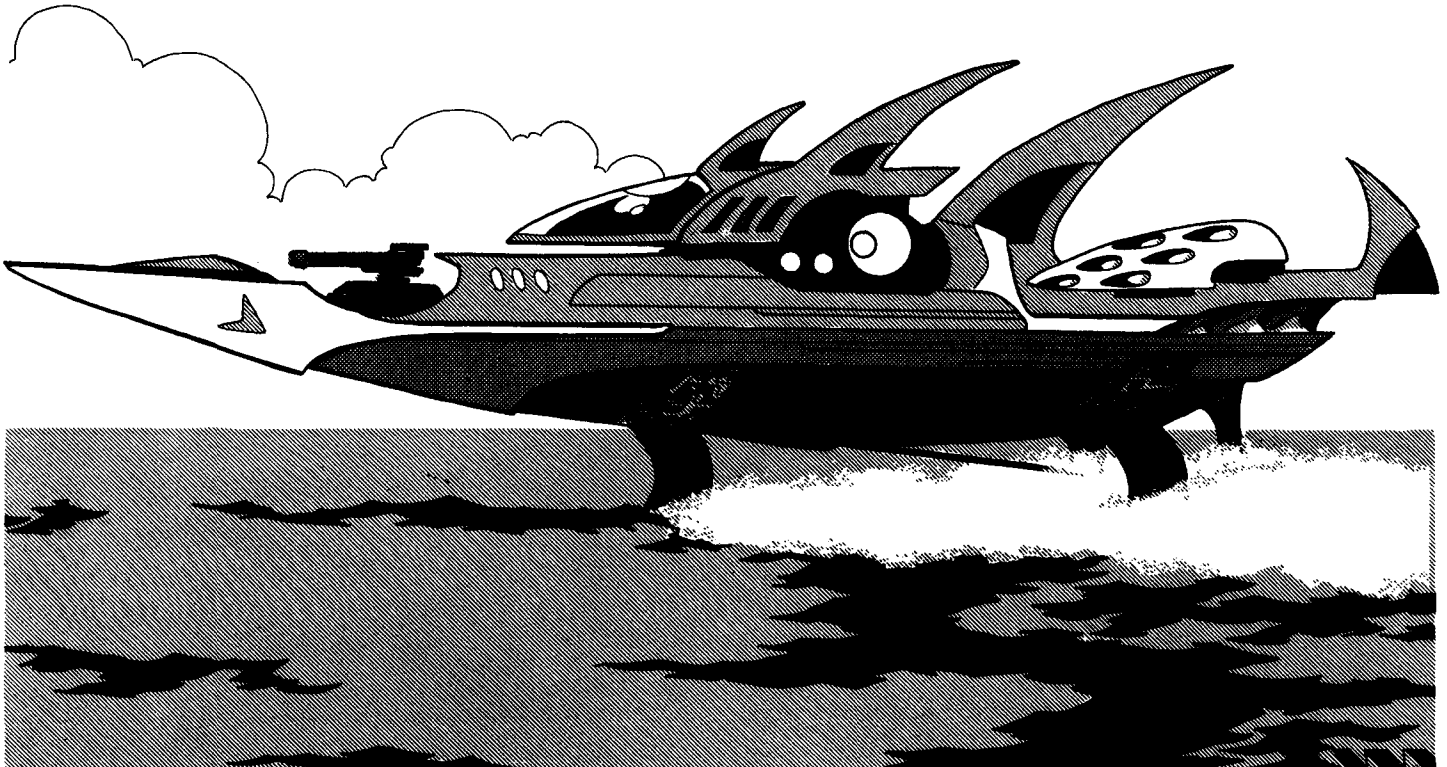

Mega-Damage: Varies with missile type.

Rate of Fire: One at a time or volleys of 2, 4, or 8 missiles.

Effective Range: Varies.

Payload: 32 total; 16 per launcher.

## "Black Galleon" Gunboat

This is the "ship of the line" for the Republic of Colombia. It is a small but well equipped and heavily armored patrol boat, designed to fight pirates and sea and river monsters. The Colombian Navy has 72 Black Galleons on active duty. Reputable (read: filthy rich) merchants and traders are allowed to buy Black Galleons, which are modified slightly to carry more cargo and then converted into armored freighters, ideal for fending off the occasional pirate.

**Model Type:** GB-30C

**Class:** Patrol boat

**Crew:** Six: a pilot, a captain, two gunners, one communications or sensor officer, and one engineer. Can accommodate an additional 20 passengers/soldiers.

### **M.D.C. by Location:**

Command Bridge — 300

Sensor Array — 160

Rocket Auto-cannons (2) — 300

Missile Turret — 150

\* Main Body — 900

\* Depleting the M.D.C. of the main body destroys the boat, making it useless.

**Speed:** 50 mph (80 mph)

### **Statistical Data:**

Height: 21 feet (6.4 m)

Width: 10 feet (3.0 m)

Length: 40 feet (12.2 m)

Weight: 120 tons (109,000 kg)

Cargo: About 10 tons (9,000 kg) of cargo.

Power System: Diesel engine.

Market Cost: 400,000 credits.

### **Weapon Systems**

**1. Rocket Auto-cannons (2):** Two turrets (one in front, one in back) are the main guns of the Black Galleon.

Primary Purpose: Anti-Ship.

Secondary Purpose: Defense.

Mega-Damage: A burst is 20 rounds and inflicts 2D4 x 10 M.D.

Can only fire bursts.

Rate of Fire: Equal to the gunner's hand to hand attacks.

Effective Range: 6000 feet (1830 m)

Payload: 4000 rounds; that's 200 bursts

**2. Missile Turret:** A medium-range missile turret is located near the back of the ship.

Primary Purpose: Anti-ship.

Secondary Purpose: Shore bombardment.

Mega-Damage: Varies with missile type.

Rate of Fire: One at a time or volleys of 2, 4, 8 or 12.

Effective Range: Varies.

Payload: 36 missiles in the turret. The cargo hold usually has 10 more reloads (360 missiles total).



**3. Light Torpedo Launch Tubes (2):** Located on both sides of the forward section, just above the waterline, are two torpedo launch tubes. Torpedoes travel at 200 mph (321.8 km).

Primary Purpose: Anti-Submarine & Sea Monsters.

Secondary Purpose: Defense

Mega-Damage: 2D4×10 M.D. (high explosive)

Effective Range: 3 miles (4.8 km).

Payload: 12 total; six per launch tube.

Cost: 8000 credits each torpedo.

Note: 2 to strike a target farther than one mile (1.6km) away.

**4. Forward Pulse Laser Cannon:** A small, secondary gun often built into the rocket cannon turrets or as an open air/deck anti-aircraft gun (with 90 M.D.C.).

Primary Purpose: Anti-Missile and Anti-Aircraft.

Secondary Purpose: Defense

Mega-Damage: 4D6 M.D. per single blast or 1D6×10 per pulse blast (both count as one melee attack action).

Rate of Fire: Equal to the gunner's hand to hand attacks.

Effective Range: 6000 feet (1830 m)

Payload: Effectively unlimited.

**5. Depth Charge Launchers (2; rear):** Basically a bomb that is dropped into the water, sinks and detonates when it reaches a particular depth or hits an object.

Maximum range/depth: 2000 feet (610 m) deep — automatically explodes at 2000 feet (or any depth between 200 and 2000 feet/61-610 m).

Mega-Damage: 2D4×10 M.D.

Payload: 16 total, eight per launcher.

Cost: 4500 credits per depth charge, 10,000 for the launcher.

---

# The Black Ship

## Scenario Outline

By C.J. Carella & Kevin Siembieda

Kharkon the Conqueror leaned over the railing as if to better observe the strange new sea before him. Sea gulls cried in distress and flew away from his black ship in abject fear. "Land must be near," he mused to himself. That was good. He was most interested in finding out what sort of world had welcomed him to its bosom.

Kharkon smiled. Archill, his trusted lieutenant, glanced at him and shuddered. His lieutenant's reaction only made him broaden his smile, distorting his inhuman face and displaying the three rows of needle-like teeth normally concealed behind his lips.

This too was good. He liked people to fear him and he took special delight that even a necromancer of Archill's caliber could be unnerved by his smile. His demonic appearance was just one more benefit from the little changes he had acquired through his dealings with the Nether Powers. No matter. Archill, like all the mortals, was a weakling. Oh, they had their limited usefulness, but ultimately they were too small-minded and impotent to understand his power or his destiny. This was a good example. Archill and even many of the demon crew member seemed frightened and disoriented by the events that had just transpired. Their small brains unable to react and respond as quickly as his. Hell, some even stood on deck as dumbfounded as motionless statues. Others still trembled and wiped the sweat and tears from their faces. Pathetic little creatures.

It was plain to him what happened. The storms that had overtaken his fleet had been no act of nature. The warlocks and wizards on the islands he was rushing to invade, sent storms born of elemental magic to oppose him. These sorcerers were smart. They knew that the greater part of his fleet would weather anything they could throw at him and that all they could do was delay the inevitable. Unable to destroy him, they sought to divide his forces and send him far away. That was the only answer. Surprisingly clever for mortals. They opened a dimensional portal obscured by the storms and sent him and part of his fleet to another world.

The Conqueror couldn't help chuckling out loud. "Amazingly clever," he chortled. Without him and the lead demon ships, the armada would break off its attack. Hell, his entire Empire would probably fall apart in a matter of months. If he ever returned home, he would have to show this opponent greater respect.

The seven foot tall pseudo-demon glanced his silver eyes over the calm, blue waters around him. Only a couple dozen of his hundred warships had survived the lightning storm and violent passage through space and time. Thankfully, 12 were the demon crewed Black Ships, which meant he still held onto great power.

"I think fate smiles upon us Archill. Ah, I see it in your eyes. You feel the power too. Mystic energy so strong that you can taste it in the air and feel it wrap around you like a lover in the wind."

The instant they emerged from the dimensional portal, Kharkon felt his magical powers increase a hundredfold. The mystic energies coursing through this world were greater than anything he (or his old master, **Drekkon**) had ever experienced. He had lost most of his fleet, but he might have gained the powers of a god. A fair trade, all things considered.

The necromancer nodded in the affirmative. Kharkon stretched, his muscles rippling and teeth glinting in the yellow sun. A groan of ecstasy slipped from his throat like the purr of a contented cat.

"Oh yes, I think this world shall prove to be a rewarding conquest, don't you think?"

This time it was Archill's time to smile. "Yes, sire. A wonderful world, I think. Ripe for plunder."

Kharkon turned towards his crew, barking orders in their hellish tongue. The **Baal-rog** first mate, his supernatural muscles rippling in the morning light, repeated the command, and cracked his whip for emphasis. The blood-red sails were hoisted; the wind was favorable. Slowly but inexorably, the Black Ship started heading towards land.



# Nightmare Island

**Population Breakdown:** 54,000 Total

Humans 32,000

Goblins 5000

Ogres 5000

Minotaurs 3000

Lizard Men 3000

Demons 1000

Other 5,000 (includes A **Splugorth** Trading Post That Has 5 Slavers, 30 Blind Warrior Women, 20 Overlords And A Guard Force Of 120 **Kittani** Warriors)

The Island Has A Transient Population Of 2D6X1000 And A Slave Population Of 30,000; Mostly Humans (60%), Lizard Men (20%), Dwarves (10%), Jungle Elves (10%), And Other Races (10%).

Nightmare Island, located in the Pirate Kingdom, is the headquarters of **Kharkon** and his minions.

A demonic fleet has been rifted into Earth. It is made up of the magic Black Ships that are well known in the Palladium World (see **Adventures on the High Seas**). They are mystic constructs crewed by demons and undead. This particular fleet came from another dimension, not the Palladium World. **Kharkon The Conqueror**, a **summoner/shifter** of great power, had successfully conquered 95% of his homeworld. Rifts Earth has become his new target.

The Demon Fleet's first weeks on Rifts Earth were spent in exploration. A vision from one of his oracles told them to travel south, then west, where they found the continent of South America. Probes sent into the northern coast returned with disturbing news of a vampire kingdoms and humans who wielded strange magic weapons (actually high-tech energy weapons). For the moment, he had no desire to compete with the Lords of the Undead. Perhaps later, with an Empire behind him, he'd make those one-eyed obscenities wish they had never been engendered. He has captured one of the larger islands in South America and is using it as a home base to launch explorations and raids around the world. This island is known as **Nightmare Island** because it has become the home of the demonic **Kharkon**, his Black Ships, demon minions and dark magic.

His fleets have since reached the shores of North America, Atlantis and Africa. **Kharkon** has struck a tentative alliance with Atlantis, providing the **Splugorth** with slaves and respecting their outposts in return for nonintervention against him. He has begun to work with members of the Pirate Kingdom, has visited **Cibola** and traded with New **Dragcona** at **Lagarto**.

**Kharkon** and his minions can become recurrent villains in many Rifts campaigns, whether they are set in North or South America, the Vampire Kingdoms, Atlantis or even the Mediterranean Sea, Africa or England! Our heroes may encounter **Kharkon's** other pirate captains and fleets led by one of the infamous Black Ships or **Kharkon** himself. Trying to determine the source of the demonic ships can lead the characters on a quest that will ultimately take them to Nightmare Island ... and perhaps beyond.

# Kharkon the Undaunted, A Transformed Shifter

**Kharkon** was a powerful shifter from a medieval and magical dimension somewhat similar to the Palladium World. His quest for power enticed him to make a diabolical pact and link with a powerful supernatural force. **Kharkon** would have eventually become the puppet of this alien intelligence (a monstrous creature that called itself *Drekkon the Destroyer*), but fate intervened. **Drekkon** met his match when he was attacked in its own dimensional realm by a band of demi-gods, Atlanteans, dragons and other powerful heroes. After an epic battle, **Drekkon** was wounded beyond hope. Prevented from escaping to another dimension, his only chance for survival was to send his essence away, to take over and consume a human host and slowly grow his powers back. The chosen vessel was **Kharkon**.

As the intelligence's body was destroyed in his home dimension, the last remains of his mind and spirit invaded **Kharkon** and tried to take over. The intrusion was easier due to the link and pact **Kharkon** had already made with the monster. However, **Drekkon** had miscalculated, not only was he very weak, but **Kharkon** was an unusually strong-willed individual. The two personalities struggled for control, but it was **Kharkon** who prevailed. The victorious shifter emerged with his body forever altered by the powers of the alien intelligence that had tried to control him. Thus, **Kharkon** is more demonic than human.

Empowered with supernatural abilities and free from the influence of **Drekkon**, Captain **Kharkon** embarked on a campaign of conquest. He built the mightiest fleet his world had ever seen, over a hundred Black Ships and several hundred lesser vessels. City after city fell to his fleet and demonic forces. Among his invading army were necromancers, demons, devils, and supernatural monsters, as well as some of the more savage giant and humanoid races. In less than a decade he had conquered all but one small island in a remote part of the world. The only ones who stood in the way of complete and total conquest were the elemental beings and a coalition of warlocks and wizards who lived on the island.

The islanders realized they could never stand against **Kharkon** and his demon fleet, thus they resorted to the desperate use of magic. When **Kharkon** led a quarter of his fleet against them, the mages sent storms to hold them at bay and reduce their numbers. Then they evoked an ancient ritual that opened an enormous Rift in the path of the fleet. First pummelled by unnatural storms, followed by a ley line storm, the fleet never saw the rift that swallowed **Kharkon's** flagship and about a dozen of his elite Black Ships. Most of the normal ships were sunk. The other surviving vessels turned back in fear. Thus, the threat of Captain **Kharkon** was removed from that world. Unfortunately, he was transported to the Bermuda Triangle on Rifts Earth.

The warlocks and mages hoped that if the storm didn't kill him, travel through the dimensional rifts would. Whether **Kharkon** lived or perished, he and his fleet would be swept away to another world. The spell casters didn't deliberately send the villain to Earth, but since Rifts Earth is now one of the cosmic crossroads of the megaverse, that's where the demon spawn conqueror went. **Kharkon** may be able to return to his home dimension, but he will have to learn more about Rifts and dimensional travel to do so.



Back on his homeworld, his underlings have assumed their leader is dead and revolts have erupted to oust the would-be minions of **Kharkon the Conqueror**. Meanwhile, the adaptive Kharkon is intrigued by this ocean planet. He also feels the magic power within him rippling with quiet energy. At least for the moment, he has forgotten about the world he was banished from. Rifts Earth seems to hold far greater potential.

He is perceived as a demon pirate with a "truly fascinating personality and unbridled ambition" by Lord **Splynncryth** of Atlantis. The Lord of Atlantis finds him so interesting and likeable that he has agreed to stay out of **Kharkon's** way and to trade slaves and stolen booty for weapons, equipment, supplies, and ships. If Captain Kharkon builds a powerful fleet and begins to conquer lands, it is inevitable that the two will become allies. But such an alliance will never last as Kharkon will someday seek to conquer Atlantis. The Conqueror also has made contact with some members of the Pirate Kingdom and is already lining up allies and assessing what is necessary to usurp control and unify that nation of freebooting rogues.

**Note:** A remnant of **Drekkon** still remains somewhere in **Kharkon's** subconscious. Once in a while, the sorcerer has flashes of memories belonging to his erstwhile master, and his personality has some marks of the monster that dwells within him.

### **Kharkon the Undaunted**

(Also known as Kharkon the Conqueror; his true name, **Rahkali Kharkon-Rah** is a closely guarded secret)

**Alignment:** Diabolic

**Species:** An anomaly: Once a human shifter/witch who has be-

come a pseudo-demon with special powers from a unique *bonding* with the life essence of an evil alien intelligence.

**Attributes:** **I.Q.** 22, **M.A.** 19, **M.E.** 19, **P.S.** 23, **P.P.** 17, **P.E.** 26, **P.B.** 5, **Spd.** 32. Supernatural strength and endurance.

**M.D.C.:** 1300plus any armor or magic he may be using.

**P.P.E.:** 1132

**Horror Factor:** 14

**Age:** 97 (looks vital and virile; but is inhuman so it's hard to determine age). With the essence and supernatural powers of **Drekkon** he could live for 10,000 years or longer.

**Natural Abilities:** Kharkon has all shifter O.C.C. abilities, plus he regenerates 2D6 M.D.C. per melee round, can summon 2D6 lesser demons twice a day (40% chance of success), animate and control 6D6 dead or command 1D6X10rats/mice, is invulnerable to fire (including mega-damage fires) and possession.

**Disposition & Motivation:** A grim and implacable conqueror and destroyer. Kharkon remains inhumanly calm even when he has suffered a major defeat (which doesn't happen often). He is an excellent strategist and tactician, and a master at inflaming emotions and motivating his troops. He has no compunctions about torturing, mutilating, or brainwashing his captives and lashes out to crush any who oppose him. He prefers direct confrontations and large scale battles, but he can be a disarming politician and appreciates the subtleties of espionage and assassination.

Although millions of his followers are lost to him back on his homeworld, he is bold from his many victories there and flush with his new, incredible power. He plans first to get an understanding of this strange, new world, establish a strong

base of operation (Nightmare Island), and build a new army before sweeping the oceans and seizing any continents. He believes his destiny is to become a transdimensional Emperor with Earth as the center gem in a crown of conquests.

He is curt and imperious with underlings and considers few people to be his equal. These exceptions include the occasional very powerful practitioners of magic, godlings, alien intelligences and adult dragons. Lord **Splynncryth** of Atlantis is one such individual. With time, he may meet and try to manipulate **Inix** of Cibola — but he will never consider this coniving creature an equal.

**Shadows of the Past:** **Kharkon the Conqueror** suffers from increasingly frequent flashbacks/memories from the alien intelligence that stirs inside him. The Conqueror believes his old master is dead and buried deep inside him, but he is mistaken.

The mystic energy of Rifts Earth has awakened *Drekkon the Destroyer* and he is slowly exerting more influence over **Kharkon**. It is possible (although only time will tell) that the monster inside the villain will someday gain full control over the body. However, this is likely to take hundreds of years. Fortunately, **Drekkon** is a very patient being. G.M. Note: It is possible that **Kharkon** may begin to hear a voice that makes suggestions, enflames emotions and supports violent actions — of course, that voice is **Drekkon**. After a hundred years or so, **Kharkon** may suffer from occasional blackouts and exhibit a split personality (**Drekkon**). Whether **Drekkon** ever becomes the dominant personality is unlikely, but the evil intelligence is glad to share the host body even for small intervals. Thus, he is unlikely to manipulate **Kharkon** to do anything too self-destructive.

**Experience Level:** 12th level shifter and 8th level witch (special)

**Magic Knowledge:** Knows all spells levels 1-15, at 8th level proficiency (the knowledge he gained from the union with **Drekkon**). The following spells are at 12th level proficiency: Sense P.P.E., sense magic, turn dead, trance, chameleon, concealment, shadow meld, time slip, call lightning, constrain being, summon and control canines, summon lesser being, and close rift.

**Psionic Powers:** Minor psionic; object read and see the invisible. I.S.P.: 100

**Combat Skills:** Hand to Hand: Basic, but enhanced by the abilities of the alien intelligence that shares his body. This is evident in combat, attacks per melee and bonuses.

**Attacks per Melee (Special):** Seven hand to hand attacks or two by magic.

**Bonuses (Special):** +3 on initiative, +5 to strike, +6 to parry and dodge, +4 to roll with **impact/punch**, +4 to pull punch, +8 to save vs poison and disease (recovers from poison, drugs and disease 10 times faster than **normal humans**), +7 to save vs magic, +6 to save vs psionics, +10 to save vs horror factor, and is immune to possession and mind control!

**Weapon Proficiencies:** W.P. sword and W.P. knife at 12th level proficiency, W.P. energy rifle at 2nd level proficiency.

**Weapons:** Magic sword: seems to be indestructible and inflicts 4D6 M.D., double damage against supernatural beings and dragons.

**Armor:** Crusader body armor, enchanted with **Armor of Ithan** at 6th level strength.

**Skills of Note:** Astronomy, basic math, demon lore, faerie lore, land navigation, wilderness survival, swim, pilot boat, ship and sailboat, all at 98%. Although he has never studied the languages, he knows **Demongogian**, **Dragonese**, **Gobblely** and **Ancient Greek/Atlantean** at 98% (just some of the memories he's acquired from **Drekkon**).

**Description:** The union with his former master, **Drekkon the Destroyer**, has stripped whatever humanity that once remained in the shifter. His features have been permanently transformed into a demonic visage, complete with three rows of needle-sharp teeth, glowing silver eyes, and dark leathery skin. He is also muscular and stands nearly seven feet (2.1 m) tall.

## Dalgon the Undying A Syvan Pirate

The only person in the whole Black Fleet that dares stand up to **Kharkon** (if only occasionally) is **Dalgon**, a Syvan Undead (see **Rifts Conversion Book One**, page 159). This grotesque, half-decayed humanoid is a powerful supernatural creature, one that shares **Kharkon's** dreams of conquest and power. **Dalgon** joined the evil wizard early in his career. His raw power and intelligence allowed him to rise high among the ranks. By the time the Great Armada was assembled, **Dalgon** was third in command, the captain of his own vessel and in overall control of a full third of the fleet. The **Syvan's** ship was among the dozen vessels that were Rifted to Earth.

**Dalgon** is the only person who knows that **Kharkon** has been partially possessed by an alien intelligence. The **Syvan** is sure that his telepathic powers could cause the creature to resurface to take over **Kharkon's** mind. He suspects that the conflict might end in the destruction of the evil sorcerer and give him the opportunity to usurp full command. For the time being (the next few centuries at least), his goals and **Kharkon's** are the same. Should the Conqueror turn against him, however, he will try to unleash the monster within and both creatures will face more than they bargained for.

**Dalgon** is sure that **Archill** is plotting against **Kharkon** and that he might even have become a spy. So far he hasn't been able to find any solid evidence and he knows **Kharkon** finds the necromancer too useful to dispose of him without proof. **Dalgon** is considering having **Archill** murdered. His current plan is to find a group of powerful do-gooders (maybe the player characters) and manipulate them into a deadly confrontation with **Archill**.

**Alignment:** Diabolic

**Species:** Syvan (supernatural being)

**Horror Factor:** 13

**Attributes:** I.Q. 19, M.A. 14, M.E. 23, P.S. 21, P.P. 17, P.E. 18, P.B. 4, Spd. 6.

**M.D.C.:** 400

**P.P.E.:** 30

**Natural Abilities:** See the invisible, nightvision 90 feet (27.4 m; can see in total darkness), recognize and immune to illusions. Automatically senses emotions around him. Can identify the source of specific emotions at 80% accuracy. Can also sense the presence of the supernatural (identical to the psi-stalker power).

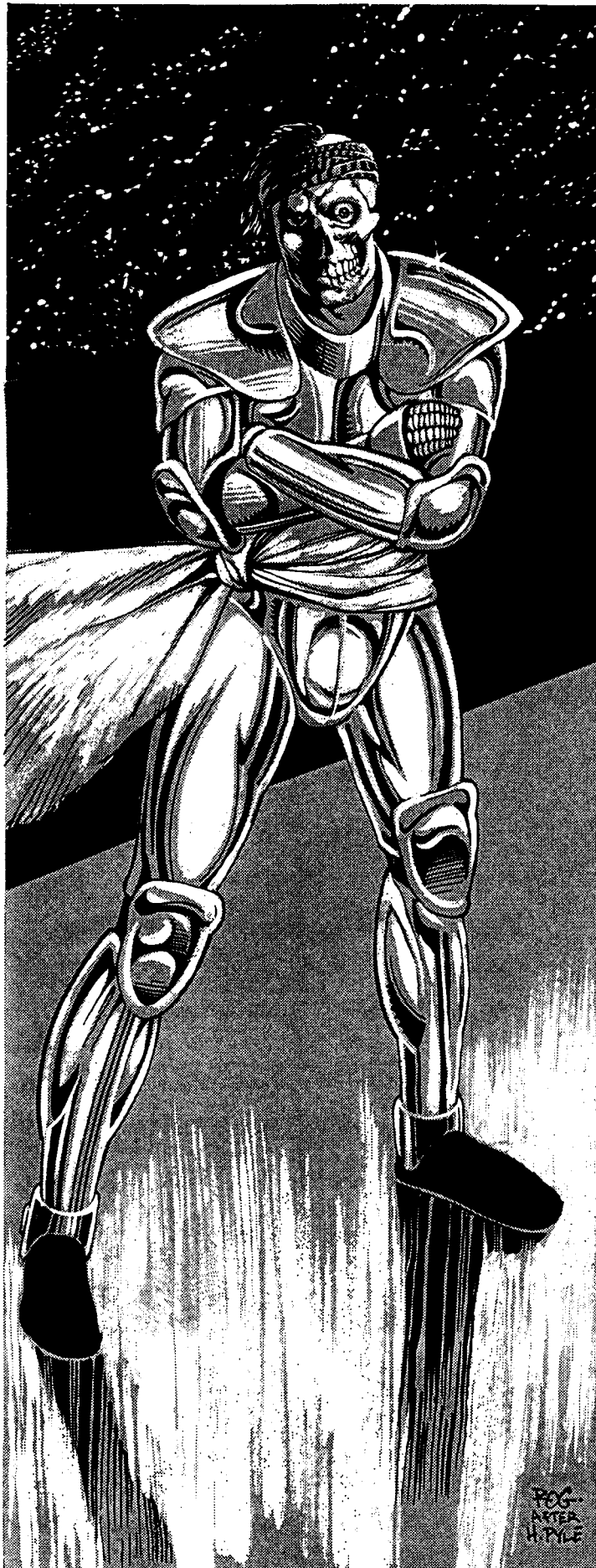

**Disposition:** Dalgon is an inhuman, cold-blooded murderer and a power-hungry manipulator. His advice to Kharkon led the summoner to attempt the daring conquest of his home planet. The syvan is very interested in Rifts Earth and is trying to learn as much as he can about technology and techno-wizardry. He loves to trick humans and other mortals into doing his bidding. A master tactician, his skill as a pirate captain is unsurpassed, except by Kharkon.

**Experience Level:** 10th level Syvan

**Magic Knowledge:** None

**Psionic Powers:** Knows all sensitive, healing and physical powers plus bio-regeneration (4D6 M.D.C. restored in a minute), bio-manipulation, empathic transmission, electrokinesis, telekinesis, telekinetic force field, mentally possess others, mind block auto-defense, mind bond, mind wipe, psi shield and psi sword. I.S.P.: 230

**Combat Skills:** Supernatural

**Attacks per Melee:** Two physical or three psionic attacks per melee.

**Bonuses:** +1 on initiative, +2 to strike, +3 to parry and dodge, +6 to S.D.C. damage, +3 to roll with impact/punch, +3 to pull punch, +6 to save vs magic, +7 to save vs psionics, +7 to save vs horror factor.

**Weapon Proficiencies:** W.P. sword, W.P. energy rifle, W.P. blunt, and power armor: basic (power armor at 3rd level only).

**Weapons:** Greater rune sword (4D6 M.D. plus can cast four spells a day from the following list, all at 6th level of power: thunder clap, change wind direction, call lightning and calm storm).

**Armor:** Kittani Explorer Armor (M.D.C. 85), or K-Universal Light Power Armor (M.D.C. 200).

**Skills of Note:** Horsemanship 98%, prowl 80%, violin playing 98%, Dragonese/Elven 98%, Human Tongue 98%, Spanish 98%, Creole 98%, American 98%, basic math 98%, basic radio 98%, detect ambush 95%, detect concealment 90%, intelligence 87%, boating 95%, and demon/monster lore 85%.

**Description:** Like all Syvans, Dalgon appears as a decaying, animated corpse. The left side of his face is little more than a skull with some shreds of flesh left on it; the right side looks a little better, but not much. He has taken to dressing himself in environmental armor. His latest favorite is a Kittani suit, painted in blue and silver, and before that he wore a captured suit of Coalition Dead Boy armor.

## Archill the Necromancer

Archill is a native of the same dimension Kharkon terrorized for centuries. This necromancer was the lord of a whole nation, but he decided to become Kharkon's second in command — at least, until he could get rid of the shifter and take over himself. Archill now bitterly regrets his choice. His dreams of becoming emperor of the world vanished in the same dimensional storm that stranded he and his master on this new world. Now the former king is reduced to playing the role of pirate leader and he doesn't like it one bit. Archill is also a very conservative person so he tends to lack the vision of Kharkon. To make matters worse, he cannot get used to the technology in this world, which he sees as unnatural and monstrous (even after living in Rifts Earth for years, he still refuses to touch a gun, let alone carry one).



The necromancer wants to return home more than anything. He believes the **Splogorth** can help him and has made a pact with agents for Lord **Splynncryth** to work as a double agent, providing the Splogorth with detailed information about **Kharkon's** activities. He has been assured that when he has proven his worth, a stone master will send him home. Even if his Splogorth masters betray him, Archill doesn't particularly care — he wants to punish **Kharkon**, whom he blames for his current predicament. Archill doesn't feel powerful enough to defeat the evil sorcerer in a fair fight, so he is biding his time to strike.

**Alignment:** Diabolic

**Species:** Human

**Horror Factor:** 10

**Attributes:** I.Q. 17, M.A. 15, M.E. 13, P.S. 11, **P.P.** 16, P.E. 18, P.B. 8, Spd. 10.

**S.D.C.:** 38 **Hit Points:** 61

**M.D.C.:** Dragon Claws and Dragon Skull: 50 M.D.C. from Union with the Dead power. Crusader Body Armor: M.D.C. 55 (total M.D.C. 105), plus magic.

**P.P.E.:** 151

**Natural Abilities:** Has all standard necromancer powers: Union with the Dead, augmentation and additional appendages, animate and control the dead, impervious to vampires' mind control and bite. See *Rifts Africa* for complete details.

**Disposition:** Archill takes his frustration out on any innocent target within his reach. A sadist even before joining **Kharkon**, he has gained a reputation as a master torturer without equal. To achieve maximum effectiveness, he uses his magic and psionic powers, as well as his considerable skill in the art of inflicting pain. He always remains quiet and subdued while conducting his "experiments," asking questions like "Does this hurt? Really? What about now?" (scream of pain from the victim). "Oh, dear. How about when I do this?"

The necromancer is very polite when dealing with **Kharkon**, playing to the hilt his role as trusted advisor. He also hates **Dalgon the Undying**.

**Experience Level:** 12th level necromancer

**Magic Knowledge:** Knows the following necromantic spells (see *Rifts Africa*): command ghouls, consume power and knowledge, death strike, maggots, shadow of doom, strength of the dead, summon maggot and summon worms of Taut, plus the following regular spells: death trance, sense magic, concealment, fear, ley line transmission, shadow meld, circle of flame, constrain being, life drain, spoil, protection: simple, banishment, control/enslave entity, create mummy, create zombie.

**Psionic Powers:** Minor psionic; with psychic surgery and bio-regeneration. I.S.P.: 42

**Combat Skills:** Hand to Hand: Basic

**Attacks per Melee:** Four hand to hand or two by magic.

**Bonuses:** +2 to strike, +3 to parry and dodge, +4 to roll with impact/punch, +4 to pull punch, +2 to save vs poison, +3 to save vs magic, +6 to save vs horror factor.

**Weapon Proficiencies:** W.P. sword and W.P. knife.

**Weapons:** Lesser rune sword (evil alignment); inflicts 6D6 M.D. and has all standard abilities. He also has a **TW** lightning rod (1D6 M.D. at 1200 feet/366 m).

**Armor:** Crusader body armor (55 M.D.C.), but prefers to wear two adult dragon claws and a dragon skull which, when activated, provide Archill with an additional 50 M.D.C.

**Skills of Note:** Human tongue 98% (language of his native dimension), **Dragonese/Elf** 98%, monster and demon lore 98%, basic math 98%, wilderness survival 98%, skin and prepare animal hides and bones 98%, horsemanship 98%, boat: sail (98%), disguise 88%, intelligence 63%, first aid 98%, prowl 93%, and fishing 98%.

**Description:** A pale-skinned, totally hairless man with flashing black eyes. His skin is cold and clammy to the touch and when he is not moving he can pass for a corpse. He favors black silk pants and tunics, with a flowing black cloak.

## The Black Ships Demonic Vessels

These ships are well known (and feared) in the Palladium world (see **Adventures on the High Seas**), as well as other areas of the Megaverse. The ships are not built normally, but are created in a complex and mysterious magical ceremony which is only known by evil shifters, summoners and necromancers. In the P.P.E. rich environment of *Rifts Earth*, the Black Ships become M.D.C. structures able to resist artillery and missile attacks as well as a high-tech warship! But the ship's true power comes from its crew of demons. All Black Ships have between 16 and 40 demons plus 40 to 120 skeletons or zombies as their crews, as well as several magicians (mostly shifters, diabolists and summoners; other types offend the demon crews). Note: The knowledge of building the Black Ships is not available to shifters and characters of *Rifts Earth* or most of the Megaverse. **Kharkon's** homeworld and the Palladium World are among the few who possess such dark knowledge (the latter because it was once a dimensional nexus and magic rich planet like Earth).

In the few years since **Kharkon's** fleet took over one of the pirate kingdoms, the black ships have added high-tech weaponry to augment their supernatural capabilities. That makes the twelve ships in the fleet some of the most dangerous vessels on the planet.

**GM's Note:** Most of the creatures, O.C.C.s and other NPC information described below is included in **Rifts Conversion Book One and Rifts Atlantis**.

**Demon Crews:** All twelve ships have the same amount of demon crew members. **Kharkon** always summons the same types of demons and has instructed his summoners to do the same. A ship on an extended expedition may have less demons than listed below, due to combat losses.

### 8 Greater Demons:

4 Baal-rogs

2 Green Jinn (air)

2 White Jinn (water)

### 24 Lesser Demons:

8 Aquatics

2 Succubus or Incubus

7 Gargoyles \*

7 Gargoyles \*

\* Although gargoyles are not, strictly speaking, demons, they can be summoned by shifters and summoners and are often

treated as demons by them. Ever since making contact with **Splugorth** outposts, many of the gargoyle and gurgyle crews are hired mercenaries, not summoned creatures.

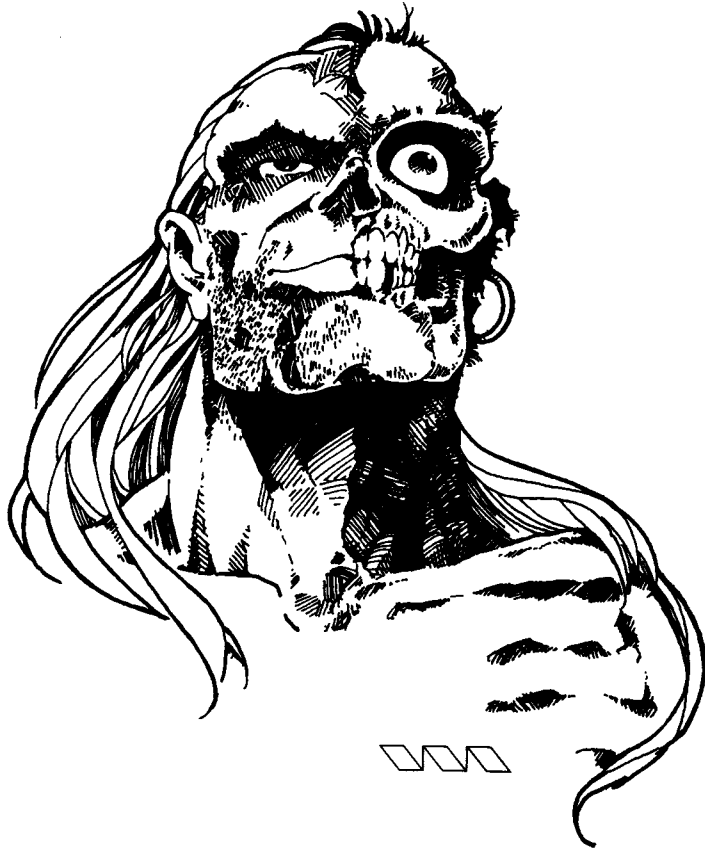

**Skeletons:** 40 to 120 skeletons. The skeletons are equipped with **Kittani** explorer armor (M.D.C. 85) and **vibro-sabers**.

**Humans and D-Bees:** 30 to 80 living crew members. At least 10 of them will be **Kittani** mercenaries equipped with **Kittani** Manling power armor and jet packs (ideal for boarding enemy ships). The rest are 80% human; most of them native to **Rifts Earth**. **Kharkon** decided that his previous crews were too ignorant of technology to be useful, although they continue serving him — many of them as skeleton warriors (nobody said he was a nice boss). The remaining 20% are assorted **D-bees**, including members of **Splugorth** slave races and lizard men.

**Magicians and special crew members:** Each ship has two 8th to 10th level **summoners/shifters**, eight 3rd to 6th level **summoners**, and six 3rd to 6th level **diabolists** among its crew. Six of the twelve ships have a gargoyle lord or a gargoyle mage (levels 4-6) and some ships have one or two tattooed men or **maxi-men** (see **Rifts Atlantis**). **Kharkon's** flagship has two 13th level **shifters/summoners** and **diabolists**, six 10th level **shifters**, six 8th level **diabolists**, two 7th level gargoyle lords, five 6th level gargoyle mages, and seven 6th level tattooed men (ogre slave warriors). He has also employed three 6th level, evil **techno-wizards** to develop new magic weapons, especially long-range weapons powered by mystic energy.

**Model Type:** Demon Black Ship

**Class:** Magic Warship

**Crew:** See above.

**M.D.C. by Location:**

* Front Mast — 65	Sails (3) — 35 each
* Mid-Mast — 90	Ram Prow — 600
* Rear Mast — 65	Rudder — 250

Protruding Spikes — 50 each

Kittani Swivel Lasers (10) — 50 each

\*\* Front Section — 1200

\*\* Mid-Ship — 800

\*\* Rear Section — 900

\*\*\* Hull per 20 ft (6 m) area — 250

\*\*\*\* Keel per 10 ft area — 500

\* Destroying a mast or a sail will reduce the ship's sailing speed by 30%;

\*\* Depleting the M.D.C. of any of these sections will sink the ship in 4D6 minutes.

\*\*\* Depleting the M.D.C. of a 20 ft (6 m) area in the hull will cause the ship to take on water and sink in 4D6X10 minutes. This damage is repairable.

\*\*\*\* Destroying a 10 ft (3 m) section of keel will reduce the ship's best speed by 20%; cumulative penalties for additional damage.

**Speed:** Sailing 16 mph (26 km); mystic propulsion 32 mph (51 km); 70 mph (112.6 km) along ley lines!

**Statistical Data:**

**Width:** 30 feet (9.1 m)

**Length:** 180 to 220 feet (55 to 67.1 m)

**Weight:** 100 tons (90,000kg)

**Cargo:** 20 ton (18,000 kg) capacity

**Power System:** Sail power or using magic; the mystic propulsion system requires 100 P.P.E. per hour of usage. Often, prisoners are systematically sacrificed to keep the ship going fast! If travelling along a ley line, however, the mystic propulsion system costs only 20 P.P.E. per hour and the maximum speed of the ship becomes an amazing (for such a large, sail driven watercraft) 70 mph (112.6 km), even against wind or current!!

**Magic Repairs:** On **Rifts Earth**, the **Black Ships** automatically repair themselves at a rate of 100 M.D.C. per 24 hours or 200 M.D.C. when anchored along a ley line or when inside the **Bermuda Triangle**.

**Market Cost:** If **Kharkon** deigned to offer one of his ships for sale (highly unlikely), he would charge no less than 10 billion credits! Only a spell-using society, and an evil one at that, would want such a hell spawned vessel.

**Note:** **Kharkon** has 12 ships that survived being **Rifted** to **Earth**. Eight more are currently under construction on **Nightmare Island**; five will be finished within 1D6 months.

## Weapon Systems

**1. Kittani Swivel Lasers (10):** These laser cannons were purchased from **Kharkon's** **Splugorth** allies to provide a technological long-range weapon system. The swivel lasers are nothing more than modified **K-1000 Spider Defenses Systems** (see **Rifts Atlantis**, page 138), with their propulsion system removed and mounted on a swivel post on the deck.

There are ten swivel lasers: two mounted above the prow, with the other eight spread four to a side. The weapons can either be fired by a human gunner or left under the control of the **Robot Defense System** built into each gun (+2 to strike, six attacks per melee). Usually, the weapons are left on automatic.

**Primary Purpose:** Anti-Ship

**Secondary Purpose:** Defense.

**Mega-Damage:** 1D4X10 M.D. per blast.

**Rate of Fire:** Six attacks if **RDS** is engaged.

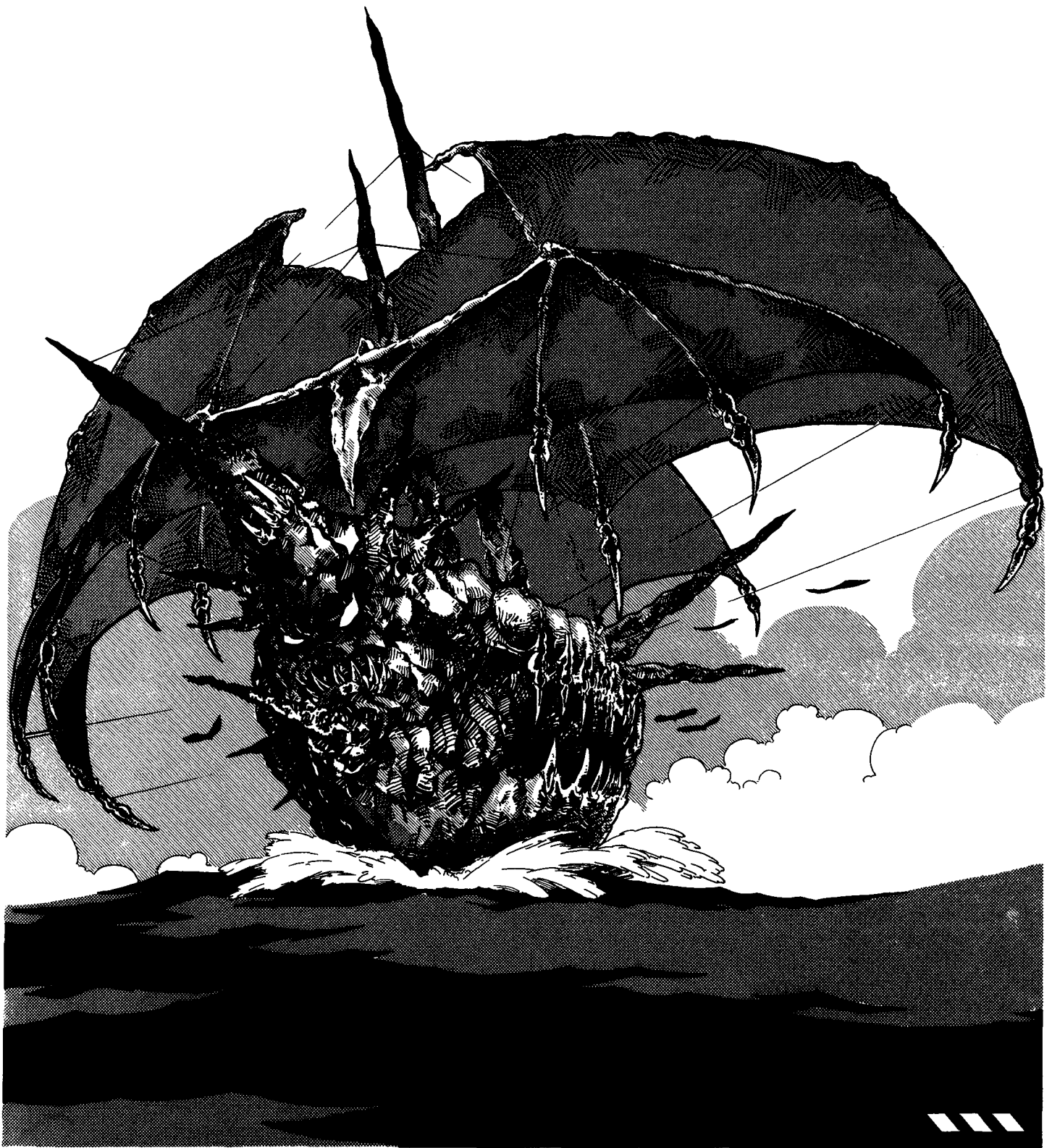

Effective Range: 3000 feet (914 m)

Payload: 40 blasts before requiring a two hour period to energize back to full capacity. An E-Clip can be used in case of emergency (5 blasts per clip). Loaders are dispatched on deck with E-Clips to reload the guns during combat.

**2. Ram Prow:** This ram is an enchanted construct that inflicts enormous damage to enemy ships without harming the Black Ship's superstructure. Usable only in close combat.

Primary Purpose: Anti-Ship

Secondary Purpose: None.

Mega-Damage: 3D6X10M.D. plus 5 M.D. foreach mile (1.6 km) per hour of speed (at maximum speed, hitting an unmoving

object, the ram will inflict 3D6X 10 + 160 M.D.!).

Rate of Fire: One attack on the melee when the ships make contact.

Effective Range: Contact weapon.

Payload: Not applicable.

**3. Magic:** Obviously, the many different practitioners of magic and the demon crew are not without their resources. A variety of different spells and magic can be used against attackers, especially at close range and against boarding parties.

**4. Demon Troops:** The powerful monster crew can be used to repel boarding parties, as well as serve as boarding parties, or fly or swim ahead to attack other boats, submarines, and even intercept, destroy or deflect missiles and torpedoes.



# Experience Tables

**Note:** Many races described in this book can choose several O.C.C.s. Use the experience table for the appropriate O.C.C. in those cases.

## Anti-Monster and Amazon

- 1 0,000-2,600
- 2 2,601-5,000
- 3 5,001-9,000
- 4 9,001-18,000
- 5 18,001-25,000
- 6 25,001-35,000
- 7 35,001-60,000
- 8 60,001-85,000
- 9 85,001-100,000
- 10 100,001-150,000
- 11 150,001-200,000
- 12 200,001-270,000
- 13 270,001-370,000
- 14 370,001-470,000
- 15 470,001-670,000

## Sailor & Felinoid Mutant

- 1 0,000-1,880
- 2 1,881-3,780
- 3 3,781-7,260
- 4 7,261-14,200
- 5 14,201-21,000
- 6 21,001-31,000
- 7 31,001-41,000
- 8 41,001-52,000
- 9 52,001-72,000
- 10 72,001-102,000
- 11 102,001-137,000
- 12 137,001-187,000
- 13 187,001-237,000
- 14 237,001-287,000
- 15 287,001-327,000

## Pirate & Lizard Man

- 1 0,000-1,900
- 2 1,901-3,800
- 3 3,801-7,300
- 4 7,301-14,300
- 5 14,301-21,000
- 6 21,001-31,000
- 7 31,001-41,000
- 8 41,001-53,000
- 9 53,001-73,000
- 10 73,001-103,000
- 11 103,001-138,000
- 12 138,001-188,000
- 13 188,001-238,000
- 14 238,001-288,000
- 15 288,001-328,000

## Voodoo Priest. Jungle Elf & Totem Warrior

- 1 0,000-2,100
- 2 2,101-4,150
- 3 4,151-8,300
- 4 8,301-16,600
- 5 16,601-25,000
- 6 25,001-35,000
- 7 35,001-50,000
- 8 50,001-70,000
- 9 70,001-95,000
- 10 95,001-130,000
- 11 130,001-180,000
- 12 180,001-231,000
- 13 231,001-280,000
- 14 280,001-341,000
- 15 341,001-401,000

## Biomancer

- 1 0,000-2,350
- 2 2,351-4,700
- 3 4,701-9,300
- 4 9,301-18,600
- 5 18,601-27,000
- 6 27,001-37,000
- 7 37,001-52,000
- 8 52,001-72,000
- 9 72,001-97,000
- 10 97,001-138,000
- 11 138,001-190,000
- 12 190,001-230,000
- 13 230,001-280,000
- 14 280,001-350,000
- 15 350,001-400,000

## Ewaipanoma

- 1 0,000-2,180
- 2 2,181-4,340
- 3 4,341-8,680
- 4 8,681-17,460
- 5 17,461-27,200
- 6 27,201-37,300
- 7 37,301-53,400
- 8 53,401-75,500
- 9 75,501-99,600
- 10 99,601-143,700
- 11 143,701-186,800
- 12 186,801-238,900
- 13 238,901-298,000
- 14 298,001-358,000
- 15 358,001-420,000

## Flame Panther, Flying Tiger & Oracle Cat

- 1 0,000-2,200
- 2 2,201-4,400
- 3 4,401-8,800
- 4 8,801-18,000
- 5 18,001-26,000
- 6 26,001-36,000
- 7 36,001-52,000
- 8 52,001-72,000
- 9 72,001-97,000
- 10 97,001-132,000
- 11 132,001-182,000
- 12 182,001-232,000
- 13 232,001-282,000
- 14 282,001-343,000
- 15 343,001-403,000

## Hunter Cat & Sekhmet

- 1 0,000-2,250
- 2 2,251-4,500
- 3 4,501-9,000
- 4 9,001-18,500
- 5 18,501-27,500
- 6 27,501-38,000
- 7 38,001-54,000
- 8 54,001-76,000
- 9 76,001-100,000
- 10 100,001-145,000
- 11 145,001-190,000
- 12 190,001-240,000
- 13 240,001-300,000
- 14 300,001-360,000
- 15 360,001-420,000

## Cibola Pincer Warriors & Cibola Gatherers

- 1 0,000-2,140
- 2 2,141-4,200
- 3 4,201-8,400
- 4 8,401-16,700
- 5 16,701-24,800
- 6 24,801-34,900
- 7 34,901-50,100
- 8 50,101-70,200
- 9 70,201-95,300
- 10 95,301-131,000
- 11 131,001-181,000
- 12 181,001-232,000
- 13 232,001-284,000
- 14 284,001-346,000
- 15 346,001-408,000

## Atlantean Monster Hunter Same as the Undead Slayer

## Pogtalian Dragon Slayer Same as the dragon R.C.C.

## Werejaguars & Werepanthers Same as the psi-stalker R.C.C.

## Grimbor Same as the Vagabond O.C.C.

## Tribal Shaman Same as the Mystic O.C.C.



Palladium Books® Presents:

# Atlantis

Rifts® World Book Two

By Kevin Siembieda

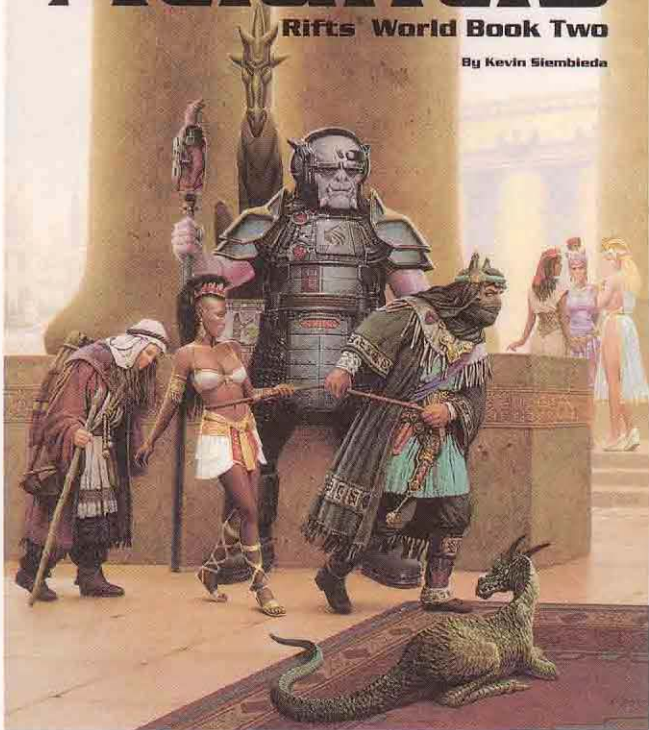

Also from Palladium Books®

## Rifts® World Book Two: Atlantis™

The dreaded secrets, power and dark forces behind the Splugorth's Atlantis. Plus, more world information, ley line storms, the Bermuda Triangle, Dragcona the City of Dragons, the transdimensional market at Splynn, the history of Atlantis, magic and adventure. Art by Long, Ewell, Gustovich and Siembieda.

- The Splugorth and their minions.
- Over 20 optional character classes.
- Tattoo magic, True Atlanteans and Sunaj assassins.
- The secrets of rune weapons and stone magic.
- Bio-wizardry, symbiotes and parasites.
- Kittani Weapons, vehicles & equipment.
- More about the Coalition States.
- Dark secrets, deadly villains, and adventure.
- Written by Kevin Siembieda.
- 160 pages -- \$15.95

Available at hobby shops, book,  
and comic stores everywhere!

Palladium Books® Presents:

## Rifts® South America™

- Nearly 20 new Occupational Characters Classes, including the anti-monster, biomancer, totem warrior, voodoo priest, hunter cat, flying tiger, pirate and more.
- Biomancy magic, spells and powers.
- Eight major kingdoms described. Each with its unique history, technology, and O.C.C.s.
- Transdimensional merchants, gods and invaders.
- More weapons, armor and equipment by the Kittani and others.
- Additional hints and data about Atlantis, Vampires, the Coalition States, and visitors from other dimensions.
- Tons of adventure ideas, characters and more!
- 168 pages

A supplement for the Rifts® RPG.

Compatible with the entire Palladium Books® Megaverse®!

\$16.95

Cat. No. 814

I.S.B.N. 0-916211-71-1



9 780916 211714

ISBN 0-916211-71-1