

PALLADIUM BOOKS® PRESENTS:  
RIFTS® WORLD BOOK 19:

# AUSTRALIA

By Ben Cassin Lucas

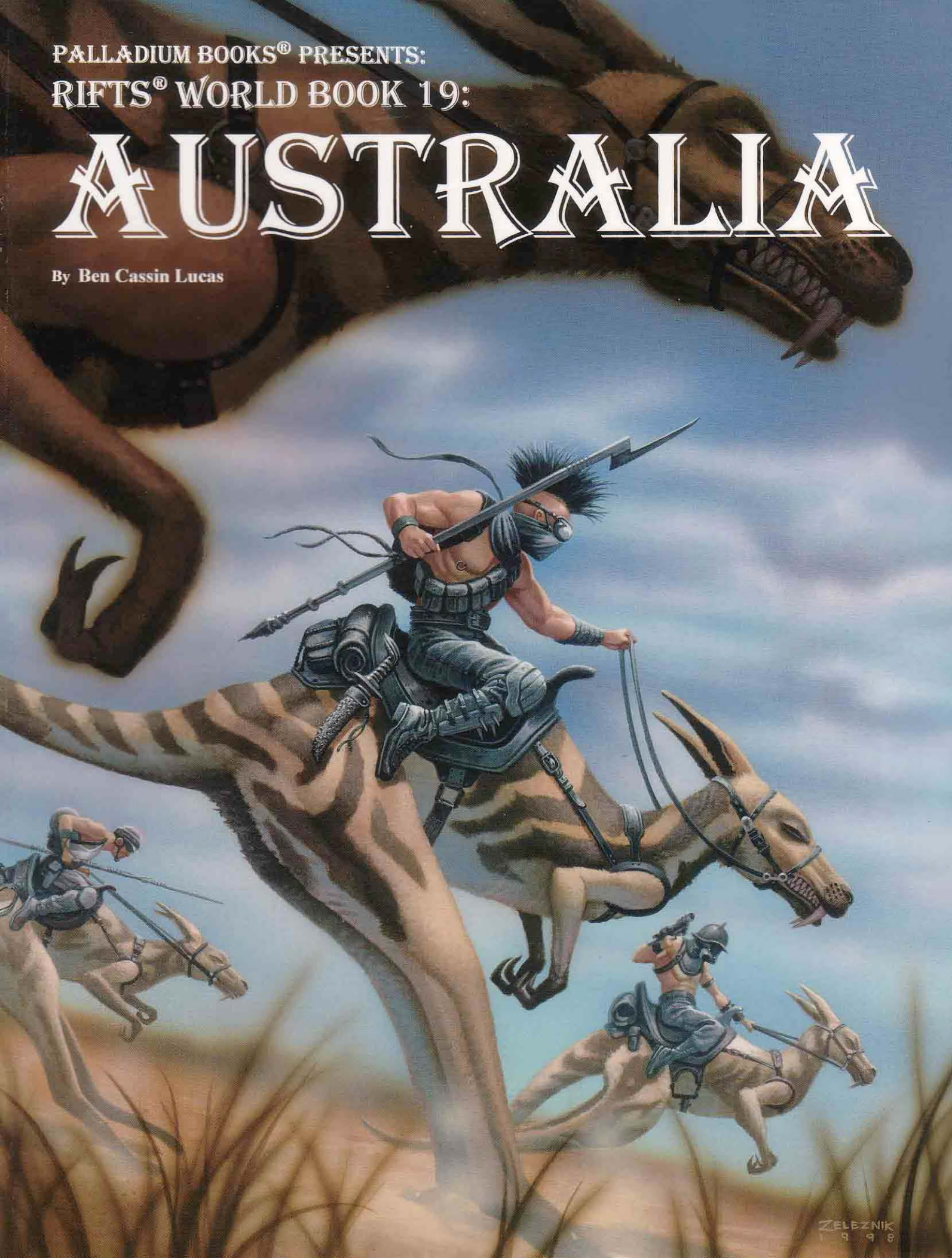

ZELEZNIK  
1 9 9 8

# Warning!

## Violence and the Supernatural

The fictional World of Rifts® is violent, deadly and filled with supernatural monsters. Other dimensional beings often referred to as "demons," torment, stalk and prey on humans. Other alien life forms, monsters, gods and demigods, as well as magic, insanity, and war are all elements in this book.

Some parents may find the violence, magic and supernatural elements of the game inappropriate for young readers/players. We suggest parental discretion.

Please note that none of us at Palladium Books® condone or encourage the occult, the practice of magic, the use of drugs, or violence.



An epic world book for the Rifts® series.

Compatible with the entire Palladium Books® Megaverse®!

## **Dedication:**

Special thanks go to far too many people, but I would like to single out and thank:

**Frode** for his enthusiasm and support across the miles that separate us,

**Stuart** for telling me to look for *rea/work*,

**Richard** for his never ending ideas,

Aaron for being my longest standing role-playing companion and first **Rifts® G.M.**,

**Andrew** for his wish to be mentioned on this page,

**Robert** for his e-mail, his fanaticism and his pizza,

**Heidi**, she was my finest inspiration to start the journey,

and my parents **Alan and Patricia**, for their love and pride.

Strangely, these people were also my play testers, so I thank them a second time **over...**

— Ben, 1999

**The cover** is by John Zeleznik, and depicts **Roadgangers** riding **Giant Kangs** on a raid.

## **First Printing — January, 1999**

Copyright 1999 Palladium Books Inc. & Kevin Siembieda

All rights reserved, world wide, under the Universal Copyright Convention. No part of this book may be reproduced in part or whole, in any form or by any means, without permission from the publisher, except for brief quotes for use in reviews. All incidents, situations, institutions, governments and people are fictional and any similarity, without satiric intent, of characters or persons living or dead, is strictly coincidental.

Palladium Books®, Rifts®, **Megaverse**, **RECON®**, The Mechanoid Invasion® and Megaverse® are registered trademarks owned and licensed by Kevin Siembieda and Palladium Books Inc. The **Rifter**, **Triax** & The NGR, New **West**, Psyscape, Federation of **Magic**, Coalition States, Erin Tarn, Emperor Prosek, **Splugorth**, Captain Nemo II, **Chi-Town**, **Skelebots**, SAMAS, **Dog Boys**, **Dog Pack**, **Techno-Wizard**, Ley Line Walker, Shifter, **Cyber-Knight**, **Psi-Stalker**, Mind Melter, Burster, Zapper, **Brodki**, Juicer, **Songjuicer**, Crazy, 'Borg, 'Bot, D-Bee, **Roadganger**, Road Sentinel, Mister Money, City Trader, **Aerojock**, **Phreaker**, **Kwarla**, Mokoloi, Shadow People, **OI'** Sydney Town, Victoria Haven, Mega-Steed, Megahorse, and other names, titles, character names and character likenesses are trademarks owned by Kevin Siembieda and Palladium Books Inc.

Palladium On-Line: **[www.palladiumbooks.com](http://www.palladiumbooks.com)**

**Rifts® World Book 19: Rifts® Australia™** is published by Palladium Books Inc., 124SS Universal Drive, Taylor, MI 48180. Printed in the USA.

**PALLADIUM BOOKS® PRESENTS:**

# **RIFTS® AUSTRALIA**

**WORLD BOOK 19**

Written by: **Ben Lucas**

Additional Text & Concepts: **Kevin Siembieda**

Editors: **Alex Marciniszyn**

**Jim Osten**

**Wayne Smith**

Proofreader: **Julius Rosenstein**

Cover Painting: **John Zeleznik**

Interior Artists: **Wayne Breaux Jr.**

**Kent Buries**

**Michael Dubisch**

**Ramon Perez Jr.**

**Michael Wilson**

**Brandon C. Clark (DSS)**

Maps: **Steve Edwards**

**Kevin Siembieda**

**Wayne Smith**

Art Direction, Maps & Keylining: **Kevin Siembieda**

Typography: **Maryann Siembieda**

**Base on the RPG rules, text, characters,  
concepts and Megaverse® created by Kevin Siembieda.**

**Palladium Books On-Line:** [www.palladiumbooks.com](http://www.palladiumbooks.com)

**Special Thanks to** Ben for his patience, understanding and cooperation — you can expect to be seeing more from this young writer. To **Erick Wujcik** whose work served as an inspiration to Ben (What can we say, Erick is one of the best game designers in the business).

Also special thanks to Kent, Ramon, Mike, Wayne and all the Palladium artists who helped bring *Rifts Australia* to life, and to Maryann, Steve and the usual Palladium Dreamtime Warriors who keep Palladium going.

— *Kevin Siembieda, 1999*

# Contents

<b>Welcome to Land Down Under</b> . . . . .	<b>9</b>
Glossary of Australian Slang, Terms & Language . . . . .	10
<b>Rifts® Australia, an Overview</b> . . . . .	<b>11</b>
Differences of Opinion . . . . .	n
Geography . . . . .	14
<b>How it was</b> . . . . .	14
Not like it used to be . . . . .	16
The Outback, what's left in the middle . . . . .	17
<b>Aborigines</b> . . . . .	17
Magic, the wave that refuses to break . . . . .	18
Animals . . . . .	19
Plant Life . . . . .	20
<b>Landmarks (Places of Note)</b> . . . . .	<b>20</b>
Old State Borders . . . . .	20
<b>Northland2</b> . . . . .	<b>0</b>
Western Australia . . . . .	21
Queensland . . . . .	22
Peninsula Space Port . . . . .	22
York <b>Station</b> . . . . .	22
New South Wales ( <b>NSW</b> ) . . . . .	23
Sydney, NSW . . . . .	24
Ol' Sydney Town . . . . .	25
Victoria . . . . .	26
<b>EHRA</b> . . . . .	26
<b>Tasmania</b> . . . . .	27
<b>Sadro Island</b> . . . . .	27
South Australia . . . . .	27
The Inland <b>Sea</b> . . . . .	28
Islands of Light . . . . .	28
Major Nexus Points & Other Landmarks . . . . .	28
<b>Ayers Rock</b> . . . . .	28
<b>Mount Olga</b> . . . . .	28
<b>Lake Eyre</b> . . . . .	29
Three Sisters . . . . .	29
<b>Arnhem</b> . . . . .	29
<b>Bana-Land</b> . . . . .	30
<b>The Outback &amp; The People</b> . . . . .	<b>31</b>
Everyday Life for an <b>Outbacker</b> . . . . .	32
The Problem with Resources . . . . .	33
Technology Levels . . . . .	34
The Code of the Outback . . . . .	34
<b>Creating Outback Communities</b> . . . . .	<b>36</b>
Step One: Orientation & Disposition . . . . .	37
Step Two: General Type & <b>Size</b> . . . . .	38
Step Three: <b>Attributes &amp; Features</b> . . . . .	40
<b>Some Notable Outback Communities</b> . . . . .	<b>50</b>
Sterling . . . . .	50
Trade Town . . . . .	51
Mister Money . . . . .	52
New Brisbane . . . . .	52
Victoria <b>Haven</b> . . . . .	53
<b>Point Clair</b> . . . . .	55
<b>Outback O.C.C.s</b> . . . . .	<b>56</b>
<b>Bushman O.C.C.</b> . . . . .	56

Bushranger O.C.C. . . . .	59
<b>Guide O.C.C.</b> . . . .	<b>61</b>
Jackaroo <b>O.C.C.</b> . . . .	63
Merchant Trader <b>O.C.C.</b> . . . .	65
City Trader O.C.C. . . . .	67
Outbacker Runabout <b>O.C.C.</b> . . . .	70
Raider (City Raider) O.C.C. . . . .	72
<b>Roadganger O.C.C./Villain</b> . . . . .	<b>74</b>
Road Sentinel O.C.C. . . . .	77
Sham-Man O.C.C. (Magic) . . . . .	79
<b>Songjuicer O.C.C. (Magic)</b> . . . . .	<b>81</b>
Other Possible O.C.C.s . . . . .	85
Where are the Aboriginal <b>O.C.C.s</b> . . . . .	87
<b>City Blueprints</b> . . . . .	89
<b>A Tale of Two Cities</b> . . . . .	89
<b>Melbourne</b> . . . . .	89
The Administration of <b>Melbourne</b> . . . . .	90
Places of <b>Interest</b> . . . . .	91
Melbourne: The Central Computer . . . . .	91
<b>Perth</b> . . . . .	92
Places of <b>Interest</b> . . . . .	92
Perth: Reflex (Computer) . . . . .	94
<b>Features Common to Both Cities</b> . . . . .	95
Social Levels at the Cities . . . . .	95
Citizen ID. Cards . . . . .	96
City <b>Security</b> . . . . .	96
Walls & Fortifications . . . . .	96
Patrols, Sentries & Defenses . . . . .	98
Defense Turrets . . . . .	98
The <b>LaserNet</b> . . . . .	99
Exploiting Weaknesses . . . . .	99
Police . . . . .	100
Law & Punishment . . . . .	100
Descriptions of Penalties . . . . .	102
The Underground . . . . .	102
The <b>Corporates</b> . . . . .	104
<b>City Based O.C.C.s</b> . . . . .	105
Administrator O.C.C. & Villain . . . . .	105
Special Skills & Privileges . . . . .	106
Cyber-Specter O.C.C. . . . .	107
Special <b>Abilities &amp; Bonuses</b> . . . . .	108
Police O.C.C. . . . .	110
<b>The LawCode</b> . . . . .	111
Police: <b>TRG</b> O.C.C. . . . .	112
Sportsman O.C.C. . . . .	115
Special <b>Abilities &amp; Bonuses</b> . . . . .	115
Some Adventure <b>Ideas</b> . . . . .	117
Some Common Sports in Rifts Australia . . . . .	118
Technologist O.C.C. . . . .	119
<b>City Military O.C.C.S</b> . . . . .	121
<b>Aerojock</b> O.C.C. . . . .	121
Infantry Grunt O.C.C. . . . .	122
Special Operations Soldier O.C.C. . . . .	124
Navy Sailor O.C.C. . . . .	125
<b>Mutants</b> . . . . .	126

Phreakers	127
Mutant R.C.C.S	128
Physical Deformity	128
Special Mutant Powers	130
Additional Special Abilities	130
Phreaker Military Grunt	131
<b>Optional Player Races</b>	132
Kwarla R.C.C.	132
Kwarla Mystic R.C.C.	135
Mokoloi R.C.C.	137
Mokoloi Technology & Equipment	142
Prey-Stalker Power Armor	145
Shadow People R.C.C.	149
New Rifts Skills	151
Aussie Skill Descriptions	153
Outback Combat Driving	157
Use Songlines	160
Weapon Proficiencies	161
<b>Monsters &amp; a Few Animals</b>	162
Desert Worm	162
Giant Cockroaches	163
Giant 'Dwombat	165
Giant Kang	167
Razorback	169
Sand Fiend	171
<b>Demons &amp; Spirits</b>	173
Bunyip	173
Devil Dingo	176
Mopaditis, Undead Spirit	178
True (Classic) Vampire	180
Garkain (Vampire)	180
Yara Mayha Sho (Vampire)	182
Wandjinas	183
Yowie	186
<b>Gods of the Dreamtime</b>	188
Bunyil	188
Rainbow Serpent	188
Tikilik	191
Other Spirits & Animal Totems	193
<b>Weapons &amp; Equipment</b>	194
Outback Technology	194
A note about Currency	195
Weapons for the Outback (S.D.C.)	196
Modifying (S.D.C.) Weapons	196
Weapon Deterioration (optional)	197
Flame Thrower	197
Boomerangs	197
Spears	198
Air-Powered Crossbow	198
High-Tech Weaponry	198
<b>Mega-Damage Weapons</b>	200
"Mankiller" Ion Pistol	201
"Popper" High-Powered Derringer	202
"Bushcutter" Rail Gun	204
<b>M.D.C. Body Armor</b>	206

Power Armor	209
<b>Misc. Vehicles</b>	214
<b>Experience Points</b>	224

## Maps

Aboriginal Activity	34
Arnhem Land	20
Bana-Land	20&30
EHRA (Melbourne plan)	26
Le y Lines	15
New South Wales (NSW)	23
Old State Borders	20
Outback, The	32
Overview of Rifts Australia	14
Places of Magic (Ayers Rock, etc.)	28
Queensland	22
Rim, Gap & Outlands	33
South Australia	27
Tasmania	27
Areas of Vegetation	32
Victoria	26
Western Australia	21

## Quick Find

Arnhem Land	20&29
Arnhem Land, also see Wandjinas	183
Bana-Land	20 & 30
Bana-Land: The Hidden City (Shadow People)	30
Captain Nemo	24
City: Administrator	105
City: Citizen I.D. Cards	96
City: Citizen Social Levels	95
City: Laser Net	99
City: Law Codes	111
City: Military O.C.C.s	121
City: Mutants (Phreakers)	127
City: Police O.C.C.	no
City: Security	96
City: Sentry Guns	98
City: Sentries & Defenses	98
City: Special Ops Police: TRG	112
City: Weaknesses	99
City: Law & Punishment	100
Computer Hacking (Cyber-Specter)	106
Currency	195
Inland Sea: Alice Springs	21
Inland Sea: Ayers Rock	28
Inland Sea: Isles of Light	21
Inland Sea: Tikilik	21 & 191
Melbourne, the Tech-City	89
Melbourne (& Perth): Citizen I.D. Cards	96
Melbourne (& Perth): Citizen Social Levels	95

Melbourne: <b>EHRA</b> . . . . .	26
Melbourne: <b>Sadro Island</b> . . . . .	27
New South Wales: Bendalong Point . . . . .	26
New South Wales: <b>Canaberra</b> (city ruins) . . . . .	23
New South Wales: Darling River . . . . .	23
New South Wales: Lake Canberra . . . . .	23
New South Wales: <b>Melbourne</b> . . . . .	23
New South Wales: Mount Kosciusko . . . . .	23
New South Wales: <b>Ol' Sydney Town</b> . . . . .	25
New South Wales: Roadgangers . . . . .	23
New South Wales: Sterling (Outback Town) . . . . .	50
New South Wales: Trade Town (northwest) . . . . .	51
<b>Ol' Sydney Town</b> (NSW) . . . . .	25
Northland: <b>Arnhem Land</b> . . . . .	20
Northland: <b>Bana-Land</b> . . . . .	20
Northland: Tikilik . . . . .	21 & 191
Queensland: Great Reef . . . . .	22
Queensland: New Brisbane (Outback Town) . . . . .	52
Queensland: Norm Delta . . . . .	22
Queensland: Wellesley Island . . . . .	22
Queensland: <b>York Station/Space Port</b> . . . . .	22
<b>R.C.C.s</b> . . . . .	127
Rim, Gap, <b>Outlands</b> , Inland Sea . . . . .	20
South Australia . . . . .	27
South Australia: Adelaide (city ruins) . . . . .	27
South Australia: Flinders Ranges . . . . .	27
<b>South Australia: Nullarbor Plain</b> . . . . .	27
South Australia: Spencer Gulf . . . . .	27
<b>Tasmania</b> . . . . .	27
Tasmania: Sadro Island . . . . .	27
Victoria: Melbourne . . . . .	26 & 89
Victoria: Victoria Haven (Outback Town) . . . . .	53
Western Australia: Gibson Desert . . . . .	21
Western Australia: Great Bight . . . . .	21
Western Australia: Great Nullarbor Plain . . . . .	21
Western Australia: <b>Perth</b> . . . . .	92
Western Australia: Shark Bay . . . . .	21

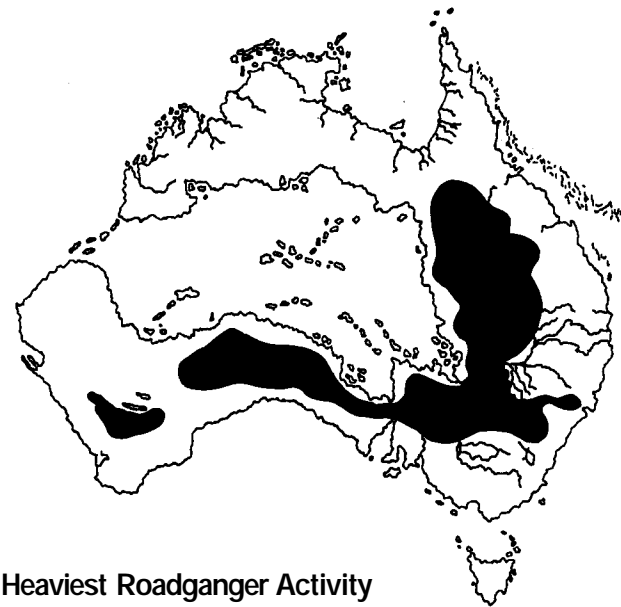
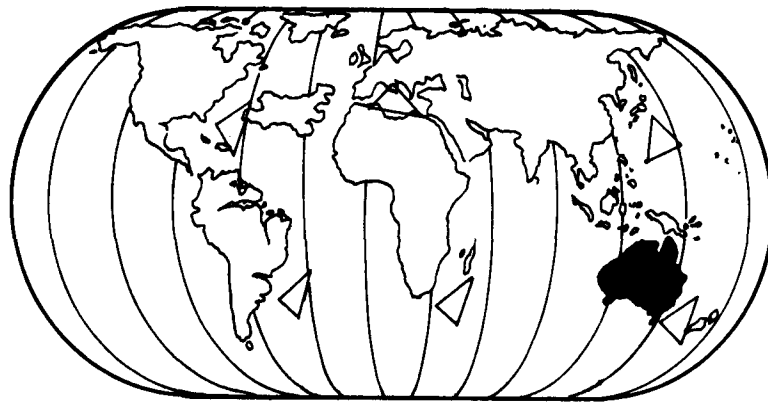

## Notable Communities

<b>Kwarla Tribes</b> (mainly Queensland & Northland) . . . . .	132
<b>Melbourne</b> . . . . .	89
Mokoloi D-Bee City (Northland) . . . . .	137
New Brisbane . . . . .	52
<b>Ol' Sydney Town</b> . . . . .	25
<b>Perth</b> . . . . .	92
<b>Point Clair</b> . . . . .	55
Sadro Island (Penal Colony) . . . . .	27
Shadow People: The Hidden City . . . . .	30
Sterling . . . . .	50
Trade Town . . . . .	51
Victoria <b>Haven</b> . . . . .	53
<b>Wandjinas Demons</b> (Arnhem Land/Northland) . . . . .	183
York <b>Station/Peninsula Space Port</b> . . . . .	22



# Rifts Australia

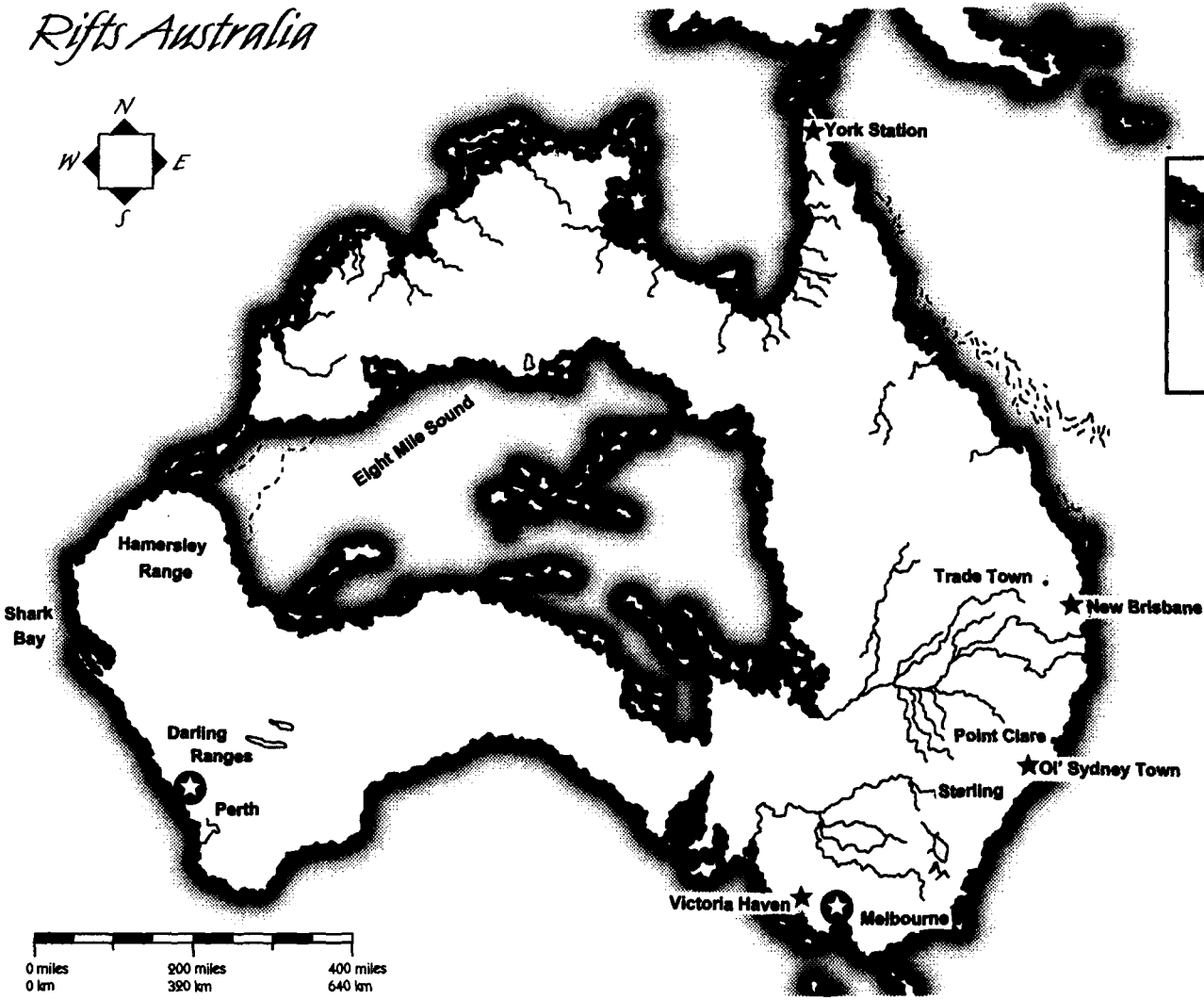
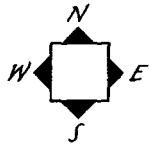

New Edwards 95

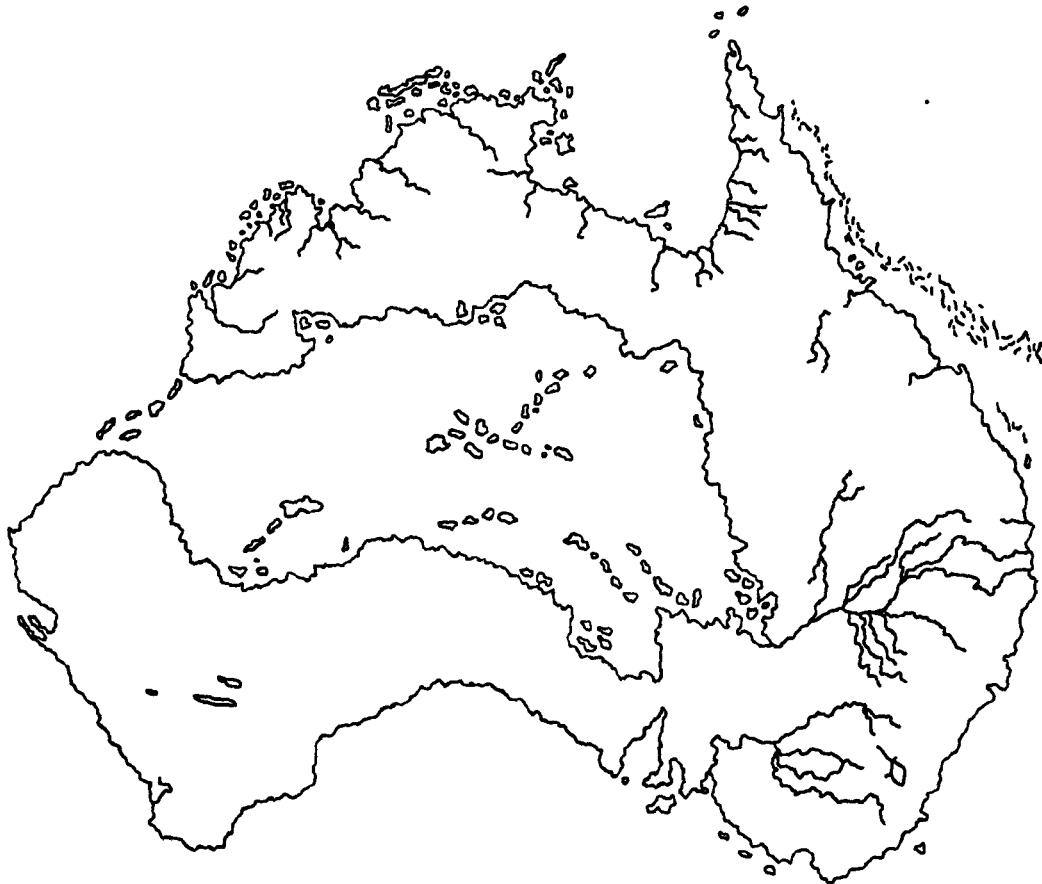





---

## Welcome to the Land Down Under

The Earth of Rifts® is a changing ball of **rock**, that much is for sure. When society reached its peak, it continued to push the envelope and eventually burst forth into a holocaust that nearly saw all life become extinct. But one could almost be thankful for the desperate psychic scream that the death of humanity sent forth, drawing magic back to the world and causing the Ley Lines to flare and the Rifts to be torn open. Life itself was given the chance to rebuild under a new veneer of magical energy as new races emerged, along with new terrors. Slowly, the world is only just crawling back out of its shelter and rebuilding. Countries are becoming connected once more, and armies and governments are rising in power.

Meanwhile, Australia is isolated. Separated from the world by miles of ocean, it was left to dry out in the nuclear winter and pick itself up. With no neighboring countries to lean upon or learn from, it stewed in its own problems and dilemmas independently. Magic touched the land, and the native tribes were given their calling to retake their country. And now they flourish. In the aftermath of the Great Cataclysm, the *white community* was left without support — no cities, no technology. They had to provide their own emergency aid, and rebuild from the wreckage. Now savage bands wander the deserts, and fiercely independent townships, city-states and nomadic bands have cropped up in the wild. There are two surviving **cities**, but they are aware of the value of what rare technological treasures they own, and therefore have walled themselves in, forever shut off from the outside lands — islands within an island, giving a new meaning to the word "isolation."

And it is said, *strange visitors* have come to Australia. The inland sea has risen again, and rumors have spread about the "strange lights" that can be seen from the shore.

The *Great Barrier Reef*, the largest living **object** in the world and a national treasure before the Great Cataclysm, has truly come alive. A magnificent creature of benevolence under the sea.

The great *Rainbow Serpent* has also returned, and in its wake it brings its enemies. Demons of various kinds, the great Bunyip, vampires and other terrors roam the land.

Rich in magic — and other things, yet struggling to survive — Rifts Australia offers the ultimate challenge for players. A desperate struggle for survival and the forging of a new world from the ashes of the Apocalypse. Beginnings.

\*\*\*\*\*

You may find it easy to understand my wishes to see this world book produced, as I am Australian. **Rifts®** is one of the most exciting games on the market today: rich in setting, drama,

horror, magic and technology. Never have I seen a role-playing game with so *much* that still manages to hold together against a single solid concept. In the past I often wondered what Australia would be like in a setting like this. What would the country be like after a change such as the Great Cataclysm and the Coming of the Rifts?

It actually all started during one game session I ran of Rifts® in which my players ended up going to Australia. I forget how they had the means, a couple of flying robot vehicles from another fun Palladium role-playing game (the last time I let players have such whiz-bang characters so freely. I had trouble keeping up with all the places they **visited!**). Anyway, they went to Australia and, search as I may, there was no background material to be found. So I cooked it up on the spot. And that's what this book grew from. A stray collection of notes, a crude mud-map that has Australia looking like a donut, and a lot of ideas. Never in my wildest dreams did I ever imagine I would see those scraps of paper in print! I hope you enjoy playing in this setting as much as I did coming up with it.

I would be rude not to lay my thanks upon Kevin and **Maryann** Siembieda as well as the countless other Palladium contributors that have been my inspiration throughout the years — Kevin Siembieda, C.J. **Carella**, Kevin Long, **Erick Wujcik**, and many others. I'm flattered to be a part of it all, and I wouldn't even have thought about writing this book without their creative genius to spark my imagination.

— Ben Lucas, 1998

## A few words from Siembieda

Rifts Australia has been one of the most requested World Books for the **Rifts® RPG** series. Over the years, we've had fans and freelance writers submit material, but it all missed the mark. I just didn't have time to write it myself, and so the requests for Rifts Australia **languished** . . . until now.

Enter Ben Lucas, a very affable and energetic lad with a good feel for **Rifts®** and a keen sense of Australia. Now, those of you in the know, might say, "well of course he has a good feel for Australia, for Pete's sake, Ben is Australian," but Palladium had gotten more than a few manuscripts over the years from other Australians that we found wanting for one reason or another, and were rejected. All of us at Palladium thought Ben did a nice job through and through. Best of all, this should be just the first of several *Rifts Australia* books — **hey**, it's a big island continent and there are lots of cool stuff to write about. One of the next books will focus more closely on the **Dreamtime** and Aboriginal magic. For now, explore the Back of Beyond and enjoy.

— Kevin Siembieda, 1998

# Glossary of Australian Slang, Terms & Language

Some Australian terms can be quite **baffling**, I know. Add to that the new slang terms that have popped up since the Great Cataclysm and the ensuing dark **age**, and what you end up with is the need for a glossary.

**Aboriginal:** The word itself refers to any indigenous race of people, but when used in Rifts Australia it refers to anyone who is a "Tribal" (see below).

**Administration:** A word used to name the government that rules over the two remaining **cities**, *Perth* and *Melbourne*.

"Admin" is a brief term mostly used by the Outbackers to refer to any authority figure from within the city walls. Admin Soldiers, Admin Choppers, Admin Reps and so forth, are all common phrases to use. The city people themselves refer to the ruling body strictly as The Administration, but they have many, *many* other titles. Ruling Collective, Governor Consulate and Democratic Body are examples of terms used to describe the **government**, while the usual terms of Cops, Army, Navy, Air Force, etc., are used to refer to the Armed Forces.

**Back of Beyond:** Slang for a very long way away. "Going back of beyond" means you're probably heading inland into the desert areas, and you're foolish to want to do so. If you're "from back of beyond," then you've come a long way to get where you are, and people will likely fear you at first, because that usually means you've come from the inland deserts, a dangerous place that abounds with legends, monsters and mystery.

**Billabong:** A collection of, or pond of, water; like a spring or a natural dam.

**Boxman:** A slang term for "safecracker."

**Bush:** Australian word for the forests and the wild. Do not be confused by bushes and the Bush; one describes low shrubs, the other, vast areas of tree covered land.

**Bushman:** Originally a term used almost exclusively to describe the native Aborigines who lived in the "bush" or wilderness. However, the term Bushman can refer to any "primitive" (by city peoples' standards), especially those who have adopted Aboriginal ways.

**Bushranger:** Gangster or outlaw. Bushrangers are so named because when they originated in the 18th and 19th centuries, when they would hide in the **bushlands** (forest wilderness) to escape and hide from the authorities.

**City-Goer:** A common slang term for the people who live in the walled cities of Perth and Melbourne.

**Corroboree:** This is an Aboriginal word that really only means "tribal dance," though it has many more meanings than that. The Corroboree is a celebration of the *Dream Time*, and is a way of contacting the spirits and the songlines, and their energy. The Corroboree is used by white folk to describe, **ignorantly**, any tribal dance or celebration, but to the Aboriginal people it is a symbol of their existence and a tool to contact the universe known as The Dreaming.

**Dollars:** The standard monetary denomination of Post Rifts Australia. The universal "credit" are yet to find its way to Australia in any large scale way. While limited contact with the out-

side world has introduced the concept, the old fashioned dollar is still the accepted currency. In fact, some of the actual notes themselves are dated **pre-Rifts**, given that the old Australian Empire used a synthetic note that was nearly indestructible. For game convenience, dollars and credits are roughly interchangeable; the term "dollars" will be used.

**Dream Time:** *Also Dreaming.* The time of creation according to Aboriginal lore. Sometimes the more enlightened Tribal people can visit the Dream Time, or Dreaming, while they sleep. It was a mystical stage when the **Bunyil** and the Rainbow Serpent made the world and gave the spirits their form. Some have referred to the Apocalypse (better known elsewhere as the Great Cataclysm) as a second Dream Time. Dreaming is also a way of describing the world, and reality in general. To a Tribal individual, every day is living a part of the Dream Time.

**Gap:** A city term for the wilderness. It is derogatory, used to describe the wild with distaste, though it has become a very common term among city folk.

**Gone Bush:** Slang for somebody considered to have become slightly loony, off-kilter, eccentric from living in, or from experiences while in, the wilderness. Individuals who have "gone bush," usually either embrace the wilderness, **preferring** it over what passes for civilization in Rifts Australia, or acts "feral," animalistic.

**Mabarn:** Aboriginal sorcerers.

**Mate:** Slang for mister, friend, buddy, and similar.

**Melbourne** and **Perth:** The only cities to survive and remain standing. They have walled themselves in against the outside world to create their own little mini-ecosystems. Nonetheless, they are starting to falter as of late, and as a result, trade is starting to occur between the Outback communities and the **cities**, albeit it on uneasy terms.

**Outback:** The Outback is the wilderness, the wild. Outback refers to anything which is not civilization, so in Rifts Australia this is any place that is not Melbourne or Perth.

**Outbacker:** The common term for those who live in the wild. The majority of Australians are made up of Outbackers. Outbackers are also referred to as coming from the "Rim" communities.

**Outland:** *Also Out lands.* A word quite often used to describe the inland deserts beyond the mountains, home to the Roadgangers. **Outlanders:** A term to describe the desert nomads that come from this harsh environment.

**Nate:** A mutant who is a natural spell caster **and/or** creature of magic.

**Rim:** The Rim is the strip of land, only a few hundred miles wide, that stretches in from the coastlines of Australia before fading into the deserts. It circles the entire continent, and is home to the majority of the non-native inhabitants.

**Roadgangers:** The generic term that describes the inland inhabitants. The word refers to the fact that they hog the remaining pre-Rifts roadways that lace the deserts so as to keep their sense of direction in the endless seas of sand. The Roadgangers are, in broad, general terms, also Outbackers, but they are a different, more aggressive and violent breed who have earned **their** own distinction.

**Songlines:** Ley Lines. Songlines are the Aborigines' term for the lines of magic energy that cross the landscape, but is a

term widely accepted and used among **Outbackers** and adventurers, even city folk. "**Songlines**" are part of their belief as to how they operate and came into being. See the skill section and other entries for more details.

Nexus Points are often referred to as "Spirit Gates" or "Demon Gates," based on what the Nexus Points will sometimes disgorge to the world.

**Station:** A large property, typically a *verybig* **cattle** ranch.

**Swagman:** A "swag" is a backpack or utility bag, or a sack used to haul personal items over large distances. Therefore the term "Swagman" is used to describe anyone who travels a lot, as they must carry a swag with them. To call an adventurer a swagman is an insult, though, as a true **swagman** is traditionally a vagabond or a tramp.

**Tech-City:** A slang term for Perth and Melbourne. Although **Ol' Sydney Town** and a few other places are considered small cities, they are not the high-tech wonders that Perth and Melbourne are. Also known as "The Cities."

**Tucker:** A slang term for food, sometimes also called "grub." This is a Bushman term, which has spread into common use among most of the Outback societies.

**TRG:** the Australian equivalent of SWAT (Special Weapons And Tactics). TRG stands for *Tactical Response Group*, and refers to a semi-militant division of the police force that deals with heavy-duty threats.

**Tribe:** Also *Tribal*. Refers to any of the native Aboriginal tribes that inhabit the **bushlands** and the deserts. Nowadays, "Tribal" is a respectful way of describing the Aboriginals.

---

# Rifts<sup>™</sup> Australia, an Overview

---

## Differences of Opinion

Three outlooks at Australia after  
the Coming of the Rifts<sup>®</sup>

### A Walkabout by Ernie Longpath, Native Tracker

"Sometimes I get asked about the outside world. '**Bout** the lands outside Australia. I can never answer the questions, '**cause** I've never been there. Been nearly every place else though, in Australia that is. '**Been** from the West coast to the East, from Melbourne Island to the Northern Cape. I even seen the Great Reef once, and the Inland Sea with all its strange lights. But I ain't never seen the lands beyond. I've heard stories about how small the world used to be before the Apocalypse. About the countries over the great Oceans, but right now the whole world is Australia as far as I can tell, and I don't imagine it ever **gettin'** any bigger.

"So what's it like here? Well, it's big, I'll say that. I'm **gettin'** to be an' old **fella'** now, and I still haven't quite seen **everything'**.

"There is a lot of country, most of it blasted flat and nothin' but sand or dirt or grass. But then there are the rain forests and the bushlands, the mountains and the rivers. Man would be hard-pressed to **find** one place here he'd like to live better than another. S'probably why I wander '**bout** so much, eh?

"Seriously though, from what I've heard — about how it used to be — I think it's better the way it is now. Black fellas like me used to be pushed back onto little strips of land while the white fella made his cities bigger and bigger. The Apocalypse stripped '**em** of that, gave us back our magic. Brought

magic to the world like it was for our ancient ancestors. The way we knew it would be again one day. We took our land back when the spirit returned to it, and the white fella was left **flounderin'** like a fish on a hot rock — good as dead but goin' mad **tryin'** to live.

"Now, there ain't much of them left. **Nah**, there's still plenty of them, but they're not much of a nation anymore. They get together in gangs and roam the deserts searchin' for gasoline and water. Some of them have villages, but they have to rebuild almost every year when the storms or the demons or even their own gangs destroy '**em**. Then there's the big smoke down south on Melbourne Island. On a clear day you can see the smoke and the glass, but no man can get closer than that. Not the white or black fella from the bush can go there. They still have the old technology they had before the Apocalypse, and they've got enough weapons to make sure nobody else gets their hands on it. I've seen some of their machines — a **whirly-bird** nearly deafened me once. Came over a ridge I was climbin'. All black and sleek with guns slung underneath it. Thought my time was over, but they never saw me. As it turns out it was **chasin'** some white Raiders. Gunned **em'** down too, I saw it all happen. Not pretty. Then when the whirly-bird went back to the city, some other white fella's came out of the bush and looted the corpses for their guns and stuff. No respect for the **livin'** or the dead, them white fellas. None of **em'** will ever learn, if you ask me."

"I ain't **sayin'** all them white fellas are bad. I met some very nice ones and good ones, and even some who come to respect the land and welcome the black fella. But most seem wild and mean. Fighting '**gainst** the land and themselves. They should learn to live like us. We have no villages to burn down. We've got no guns to shoot each other with. We've got our land, the magic, and our Elders, and then we got the *Serpent Spirit* **lookin'** over us. Sure, we got the usual problems, life ain't easy.

Life is life. The worst are the troubles that come from the *Songlines* and the *Spirit Gates*, but our Dream Warriors protect us **fine**. Not like the white fellas who fight the demons and then fight each other 'bout who is the smartest or strongest or how to best rebuild after the destruction. Maybe that's their problem. They spend too much time **fightin'** and **arguin'**, and not enough time **livin'**. Yeah, I think that's it.

"In the day I look for food and keep **walkin'** this great land of mine, and in the night I lie lookin' at the stars and listening to the animals before sleepin' and **dreamin'** of my ancestors, hopin' I'm doin' them proud."

## Outback Reconnaissance Report 317

Lt. Cassin Crowe,

Aerojock for Melbourne's

21st Helicopter Deployment

It was a fairly straightforward maneuver. Our mission was to fly a wing of five birds north over the Victory Gap into an Outbacker community in Blue Sector 12 and release a napalm deterrent to curb recent increases in raider activity. "**Recon** by Fire," they call it.

Things would have gone well if not for one small problem. The Outbackers were armed. Heavily armed. Three choppers were downed by missile batteries before I was even aware of the threat. Obviously the Outbackers had been pooling their resources to build for just such an occasion as this. Myself and **Sgt. Grey** of Unit-03 immediately pulled back to call the mission in as a failure. Units 01, 02 and 04 were just hitting the ground when Melbourne Control radioed back that we were to proceed as planned or Level Seven punishment would be our reward upon return. Such being the case, **Sgt. Grey** and myself retreated through a ravine before circling back and unleashing our payloads. We were lucky, caught them celebrating too soon. One third of the community was engulfed in flames as we pulled away.

Then the fire opened up from the surrounding hills. **Flechette** ammo tore into my flank and the panel was engulfed in electrical fire. As I auto-rotated towards the ground I could hear **Grey** screaming through the headset as his bird also plummeted, rotorless and engulfed in flames.

I don't know how long I was out. It was a miracle that I survived. When I regained consciousness, I found myself on the floor of a crude hut. My limbs were restrained in filthy bandages. The foul stench of **unfiltered** air filled my throat and made me cough. A cobweb in the corner of the roof indicated that they had not cleansed the area of vermin in quite some time. I raised my head and upper body up the best I could to get a better look at my squalid surroundings, and found myself staring into the eyes of a small, grubby child. I thought he would be awestruck by the presence of a *Melbourne Dweller* in his humble **community**, but I was wrong. The kid leapt into action, pushed me back on the bed and jabbed me with an unclean looking syringe, all the time screaming for the "**Doctor!!**"

Upon waking once more, I found myself surrounded by grim looking men and women. One of them, dressed in a crude parody of a doctor's garb, was holding a syringe that I assume held a stimulant that rocked me back to consciousness. I don't know

why, considering my peril, I was surprised that my mind kept focusing on the unsanitary and squalid conditions. It was clear by the doctor's stained smock that he didn't use disposable paper garments but washed and reused the same clothes over and over. And that syringe, even if they used sanitizing cleansers to flush it and the needle clean . . . the germs, contamination . . . I pushed those thoughts from my mind and looked at my interrogators.

The rest were dressed in ragtag, rough and ready clothing. Sweaty, dirty and mostly armed with outdated firearms. Without words, they dragged me to my feet. My legs were crippled from the crash, but crudely splinted. They began to take me through the village to its center. On the way, I caught a glimpse through pained eyes of what their life there was like. They were nestled in a valley, near a river, surrounded by dry **bushlands**. The people, from children to elders, baking under a hot, unfiltered sun — a simplistic yet sufficient collective of wilderness people. Most of the buildings, wooden and mud brick affairs, were smoldering after the napalm raid, but the ones that still stood were decrepit. Simple shacks, thatched roofs, dirt streets, even dirt floors I suspect, none of the skyscrapers or even the simplest amenities like in Melbourne. Men, women and children gathered around, dressed in armor made from old tires and tin cans — gross. They carried crossbows and solid ammunition firearms and wore grim expressions that to this day I struggle to describe. Our strike had hurt them. Ravaged their community. And the pain and sorrow etched into their faces . . .

One woman in particular stands out in my mind. Tall and striking. Perhaps beautiful if not for the grime. She stood leaning on one leg, rifle held loosely over her stomach, the remains of my chopper already incorporated in the makeshift armor that protected her torso. Her blue eyes stared at me from behind a mesh of matted red hair. She had contempt for me, I could feel it, hot and tangible. And not just the sort of anger your girlfriend throws at you on a bad day, I mean pure hatred for what I represented. With them around me, I **felt** . . . afraid and sad. I opened my mouth to . . . apologize . . . say something, but I knew she'd do little more than spit in my face. "**Sides**, I was only doing my job. They started it with their raids. Pathetic animals living like thieves. Still, I couldn't help feeling ashamed and frightened. I was sure my public execution was coming.

The Outbackers propped me onto a stand in the middle of the community and gathered about. One man, not dressed in armor but carrying a sword like a drill sergeant, stepped forward and addressed me. He was surprisingly polite and cordial. He told me I would stay in the hut for a week or more, until I was able to walk. During that time I would not be mistreated unless I acted like a barbarian. Me the **barbarian!**? After I had healed some more, I would be sent back home, but with a message to the Governors of Melbourne. The message being that from this point on, Melbourne Administration would be met with nothing but resistance. He also made a dark promise to me — that one day Melbourne would fall to the Outbackers, and the treasure hoards and lost science of the city would be shared with everybody who struggled day by day just to survive. That one day the city would be theirs and they would share the wealth and achievements with every man, low and high. I almost laughed.

So to cut a long story short, they kept me contained in my filthy, **un-air-conditioned** hut, sleeping in my own pool of sweat

until they deemed me healthy enough to leave. I was escorted out of their ramshackle camp blindfolded, and sent on my way. I was picked up seven days **later, was** floating on a homespun raft by *Victoria Sea Patrol*. The water they had given me, nearly gone. The medics rushed me to the hospital and I was bio-rejuvenated. After I filed my report and delivered the message, I was given two things. A Level 4 electronic punishment for failure, and a medal for valor and being injured in battle.

To summarize, what do I think of Australia outside our great city? I think it's a garbage heap. Dust, grime and wilderness. We represent all that's truly left of civilization, while they live like animals on a primitive level. Yet, the Outbackers grow stronger and more aggressive each day, planning and rebuilding. Their goal, and I know it's crazy, is to reclaim and rebuild Australia as a single nation. I don't see how they think they can accomplish this. Still, I **find** myself admiring their determination and conviction. They have a purpose, while we stew in our own juices. The Melbourne Administration, satisfied that they hold all the strings to power over our cities, ignore our troubles, and continue to be self-obsessed. They are convinced that they can maintain our crumbling Utopia for all time. They still think the Great Cataclysm was yesterday, and fail to see that the world around us still has potential. I mean these Outbackers have courage . . . and they are still human like us. Perhaps if we groomed them for a few generations . . . helped them in some small way. I **don't** know. I just fear that to continue to ignore the world outside our walls will be our doom. We can't continue to shut it out.

As for the Aboriginals. I know nothing of them, but I hear the natives are happy. They have their country, their lands, and they are satisfied to let us, the white invaders, die off or kill each other.

I don't even want to think about what supernatural forces are at work way out in the bush.

## A conversation with Gordan Sterling Outbacker and Explorer of the Northern Coasts

"Australia never ceases to amaze me. It's that simple. I don't know a lot of history — most of the knowledge about our past has been lost in time. Only the Aboriginal nations hold truly ancient history. Their Elders pass stories on to each other as the years tick by.

"Me, I can't even read, but this is what I've learned.

"First of all, you have to see the big picture. This was a very sacred country before the ancient Europeans settled it. Filled with magic. But as the world grew more mundane, and the native tribes were pushed further and further back onto their postage-stamp preserves by the European invaders, the magic died. Animal species went extinct and well, like I said, the whole land just died. Became kind of boring from what I've been told. The whole world was mapped out and bound together by pictures and computers. There wasn't no place we hadn't explored. Then one **day**, the world was wiped clean. To hear the Aboriginals tell it, magic just washed over the planet, cleansing it through cataclysmic upheaval the like of which the world had never seen. When it all come to an end, it was like Australia was blasted clean of impurities. Once more we were left cut off from the rest of the world. Our huge continent was surrounded by water and

the people left on their own. Just like thousands of years before. But unlike the last time, the white settlers were already here, crawling around in the wastes as the portals came and the ley lines tore across the landscape. Nowadays, the people are more segregated than ever. We got the Outbackers, which is what I am I guess, just folks doing what we can to survive out in the world of ours. There are those that have taken the nihilistic approach — they're going to burn us all up '**cause** all they do is loot and steal from folks like myself and my friends who are trying to establish something again. There are a lot of folks who want to reclaim the land again, and maybe contact the outside world. That's me. I'm one of those. Want to build something for our children. Hell, we may be the last people on Earth, though somehow I doubt it. But it don't matter what's **goin'** on elsewhere, we got to help ourselves. Rebuild our communities again. Learn to live in this new world of ours. Maybe live better than before.

"Then we've got the city-goers, eh? *Melbourne* is the first place that springs to mind. It survived. Miracle, ain't it? They've got themselves nice and locked up in their own little world. Never been down there, don't ever plan to. Give me the bush any day. Oh, and **there's** also *Perth*, but they aren't nearly as impressive or prosperous as Melbourne. Don't know why they survived. My guess is they was just lucky. I hear some folks talk of some **kinda** war that caused all this, which **conflicts** with the Aboriginals' story of magic, and I've seen my share of magic, so I know it's real. I can't say whether there was a war or not, but I like to think, if there was, maybe whoever started it figured Melbourne and Perth weren't even worth the bombs. Yeah, I like the thought of that. Those high and mighty folks may have it all now, but hundreds of years back, they weren't even worth a nuke.

"Of all the people in Australia, last, but definitely **NOT** least, we've got the Tribesmen. They are the strongest of us survivors, and, I **think**, in many ways the most lucky. They have their land **back**, what's left of it. They don't seem to mind the changes or strange beasts and monsters. For them, the Coming of the Rifts was a blessing, not a curse. Gave **em'** back their magic, see. Gave some of us magic, too, but I'll never trust a white sorcerer. They're out of control. Now the Aboriginal people, eh, they can work magic! They have this relationship to nature that I struggle to find almost every day but will never reach because, well, I have no roots here. That's what the Tribes tell me. I be a good man, but I have no real ties to Australia, '**cause** my ancestors were people of another world. Still, the Tribes don't mind me or you, or any of us being here as long as we respect them and the land . . . and I guess, the magic.

"I don't have a problem with that. Our Australia is beautiful. We've got open land, animals are everywhere, places of magic, things that'd make you just sit down and wonder for hours. I love exploring this land of ours, and I'll never be bored here or sad that the old days of civilization are gone. Not really sad, anyway, I'm a simple man, and don't know no better.

"As for my future. Next I intend to take a boat out on the Reef! Yeah, our biggest wonder of all. I **can't** wait to experience it. That one will really be something to tell about."



# Rifts Australia

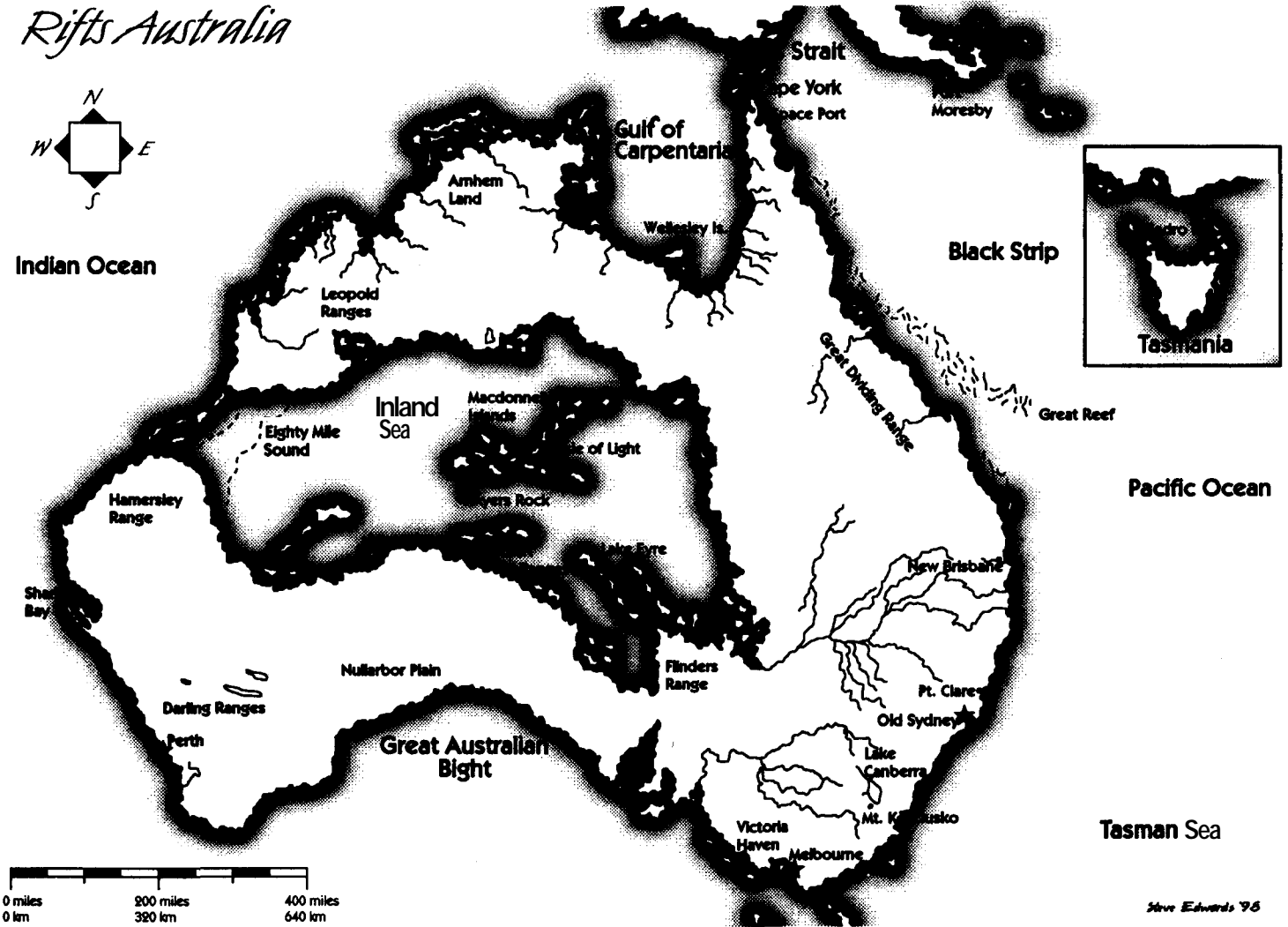

## Geography

### The Bare Statistics

Land Area: Approximately 2,090,000 square miles (5,413,100 square km) — the new Inland Sea has reduced much of the former land area. Approximate Percent of World Land Area is 5%.

Population: 22 million. Australia is largely a wilderness with wildly scattered pockets of people clustered into a particular town or city. The two Tech-Cities, Melbourne and Perth, are the two largest cities on the continent and represent a comparatively tiny land area. The next largest Outback communities, **Ol'Sydney** Town and Victoria **Haven**, are less than 3% the size of Melbourne! In general, the largest clusters of the white population are found along the coastline and lush green forest regions. However, even here, one can travel hundreds of miles before stumbling across fellow traveler or a farm, let alone a outpost or town. The parched deserts and grasslands have the least people and communities. What people do live their are clustered in small communities, like an oasis of people and what passes for civilization.

#### Population Breakdown:

34% **Tribal/Aboriginal** Humans

25.6% **City Based** Humans

28% **Outback Humans** (Non-native)

6% **D-Bees**

6.4% **Mutants**

**Note:** This does not include demons, monsters and other supernatural beings or creatures of magic.

#### Major Modern Cities:

Melbourne

Perth

#### Elevation:

Highest Point: 7300 feet (2225 m)

Lowest Point: 24 feet (7.3 m) below sea level.

Average: 80% of the country lies between 400 and 1500 feet (122-457 m) above sea level. A mere 7% lies above 2000 feet (610 m).

Coastline: 11,468 statute miles (18,350 km), including Tasmania.

Dimensions: 1958 miles (3133 km) from north to south, and 2488 miles (3981 km) from east to west.

## How it was, and how it is ...

Prior to the Coming of the **Rifts**, Australia was a country rich in cultural diversity. This was of both benefit and crisis to the overall community. The crisis came from racial antagonism — racist groups fighting over issues that were hot in their countries

of origin. Also, the Aboriginal community was left without the technological splendor of the white community, the majority forced onto reserves and supported by welfare, similar to the "Indians" of North America. Controversy and problems between ethnic groups was at an all time high in the last decades before the Cataclysm, yet overshadowed by the benefits of technology and modern society. A broad range of culinary tastes, racial and social diversity, cultural holidays (Australia had more public holidays than any other country in the world), sports, varied recreational pastimes and so forth, added to the rich melting pot.

The Apocalypse known to most outsiders as the Great Cataclysm (but to most Australians simply as the Apocalypse) changed all this. To start with, the Aboriginal people shed tears of joy as their land was unshackled and released to them. They saw the destruction of the old world — the white world of intrusive science and technology — as a healthy, renewing cleansing,

in much the same way they saw the burning of a dry forest as a necessity. And like the burnt forest, from destruction and scorched **earth**, life survived and, renewed by the destruction, has thrived. Most of the old "white" community (which actually includes all ethnic groups that are not Australian Aboriginal people — Chinese, Greek, Japanese, Vietnamese and Norwegian were the largest cultural groups) were destroyed. Other than the surviving city dwellers, most of those still alive forgot their racial or cultural differences and banded together to survive. Racial and cultural differences became a thing of the past. In the Australia of Rifts Earth, everybody is an "Australian." The only segregation that remains is based on where one is born — Rim Dweller, savage Outbacker of the deserts and wilderness (Outback), or City Dweller locked behind the walls of fabled Perth and Melbourne and living in isolation.

## Rifts Australia

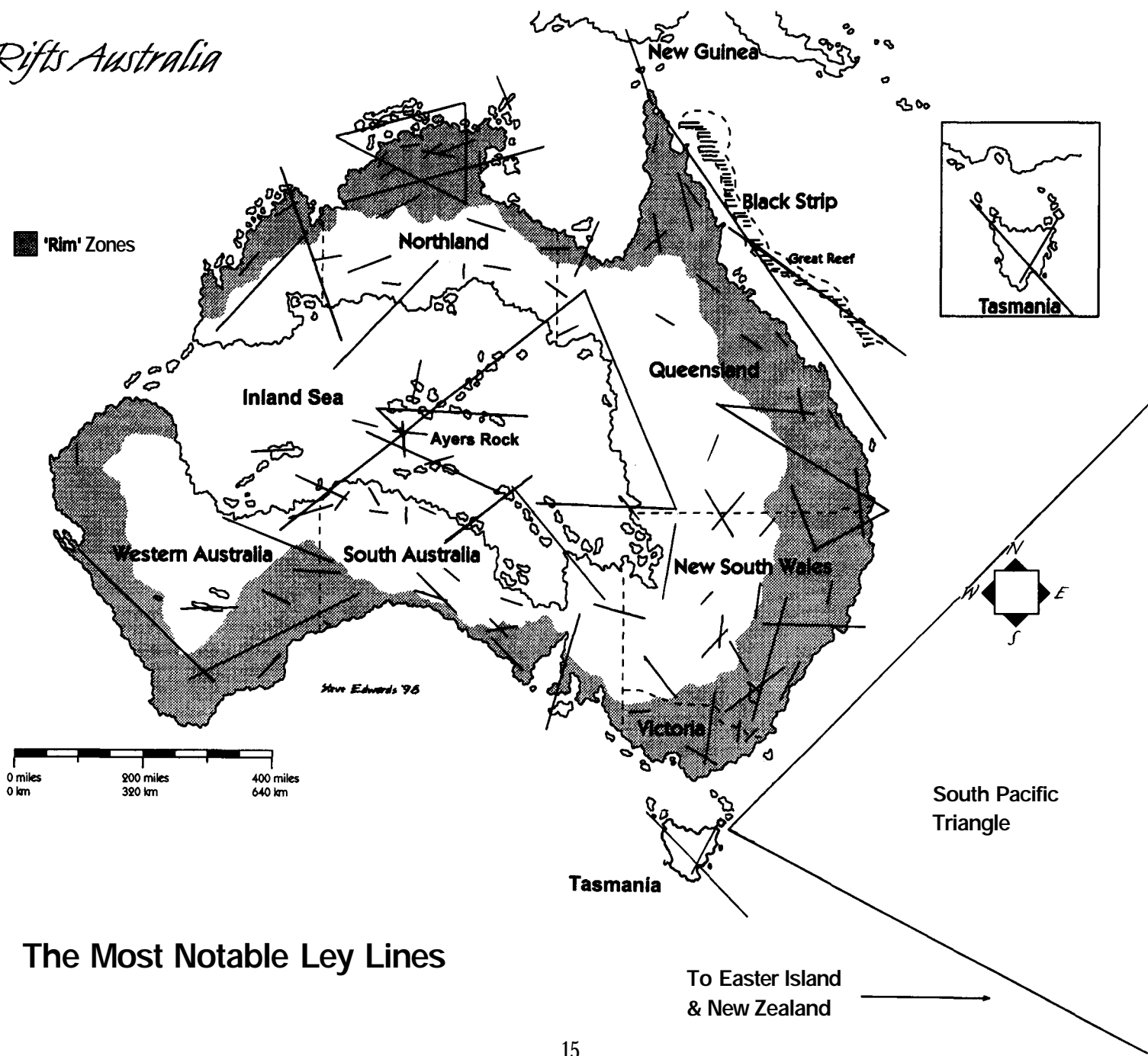



## Not like it used to be ...

The changes wrought by the Coming of the Rifts are many and disturbing. The actual physical structure of the Australian continent has been altered dramatically. Waves of magic, rising sea levels and apocalyptic destruction have changed Australia perhaps more than any other place in the world, even more so than the thousand islands of South America.

Before the holocaust, Australia was a big, flat country with ridges on each side. In the center were three major deserts — the *Gibson Desert*, the *Great Sandy Desert* and the *Simpson Desert*, each as flat as the other. The lowest point was 39 feet (11.9 m) below sea level, a dry, salty place called *Lake Eyre*. Sometimes, in particularly rainy seasons, this lake would fill with very salty water, evidence suggesting to geologists that Australia used to have an inland sea. This Inland Sea came flooding back when the Great Cataclysm was in full swing. The tidal waves, earthquakes and tumult of this rebirth changed the face of the entire country for all time. Cities crumbled, old mountains were destroyed and new ones born — but perhaps arguably, the most impressive transformation was the birth of the massive, Inland Sea. When it was all over, there was a new sea where there used to be land, filled with a few broken islands that were once mountains.

This change had enormous side effects. Many rivers dried up, while some widened, and new ones forged a path across the continent. The deserts were not only reshaped, but pushed further towards the coasts as raised salt levels killed once fertile land. The result was a well-defined green tract of land that almost circled the entire country, aptly called the *Rim Territory*.

Other changes have occurred. In particular, the Great Cataclysm destroyed all but two cities. On the southern edge, in Victoria, *Melbourne* survived, but was severed from the mainland to become an island city-state in and of itself. Over on the western edge of Australia, *Perth*, another capital city, also managed to survive relatively unscathed. While most of it flooded and dropped into the sea, much of it was rebuilt and moved into the mountains. Furthermore, part of Perth is a string of islands linked together, making a section of the high-tech community a sort of floating city.

Alas, all other traces of the old civilization were either obliterated or have disappeared. *Sydney*, once ranked amongst the biggest and most popular cities in the world, is a skeleton of crumbling skyscrapers and villainy surrounded, in part, by swamps and marshlands, its broken harbor strewn with debris. *Canberra*, the inland city that was once the Australian capital, fell to the destruction of the Great Cataclysm and is now "Lake" Canberra, and serves as a shallow watering hole.

Up in the *Northland*, the table lands were opened up by widened rivers and increased sea levels, transforming the entire north shore into a collection of jagged islands, swamps and wetlands.

All these changes, as major as they are, have not destroyed the beautiful or savage essence of Australia. Ultimately, she remains the vibrant land she has always been. A place of unique life forms adapted to a unique environment, and hence, a great testament to nature's (and humankind's) ability to survive against all odds.

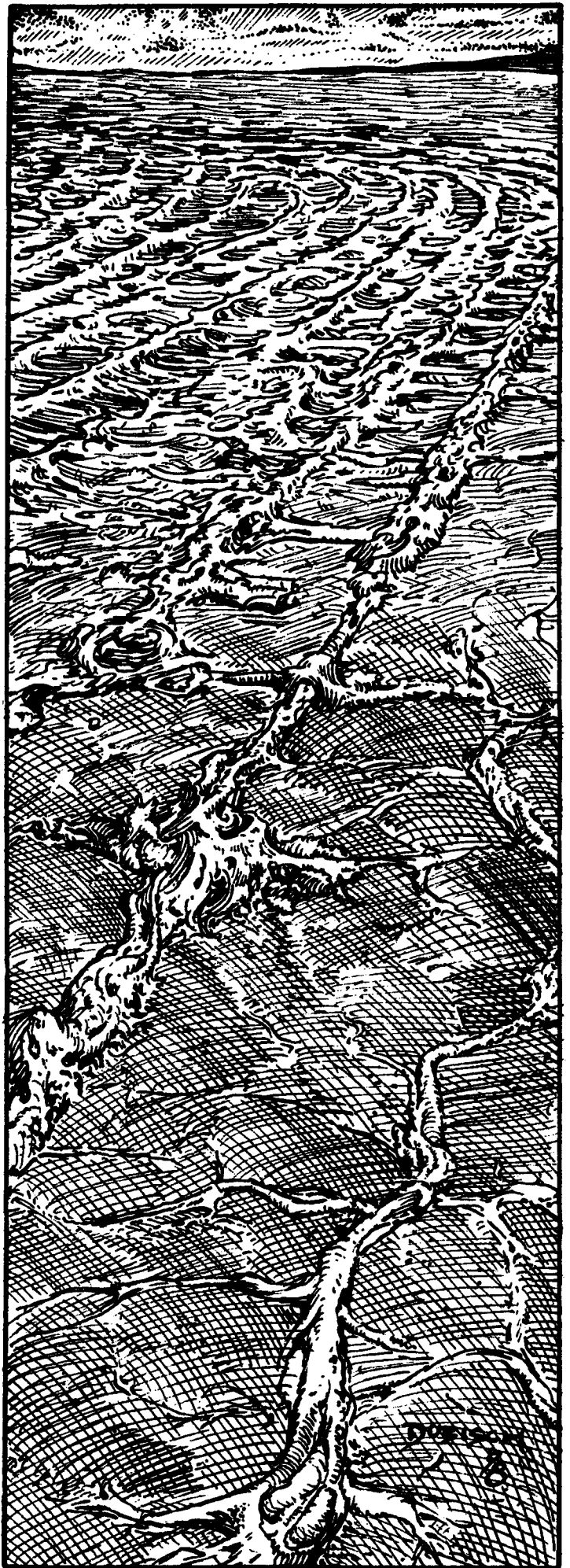

## The Outback, what's left in the middle

Humans who were not of Aboriginal descent or not fortunate enough to have gotten inside the walled cities of Melbourne and Perth before they closed themselves to the world a few years after the Great Cataclysm, are left in the wild to fend for themselves. Over the centuries, many thousands of lost and frightened people have made pilgrimages to one city or the other pleading to be allowed inside, but all have been repelled. The cities reject **Outbackers** to maintain their own delicate infrastructure and to not tax their limited resources any more than they have to. However, of equal concern is the powerful belief that the influence of the "wasteland barbarians" would have a damaging effect on their people and society. Thus, the refugees are rebuked and sent away. This has served to create a sort of secondary cluster of primitive, low-tech **shantytowns**, farmsteads and shabby settlements that have gathered near the two cities and dot the neighboring coastlines (reminiscent of the 'Burbs found around CS cities, only not as close in proximity, or as advanced or lawless). Even these clusters of humanity are considered impoverished and primitive "Outback" communities of savages, at least by City-goers. Beyond these settlements is the real Outback. A vast wilderness inhabited by men and monsters alike.

In present day Rifts Australia, the majority of the people have accepted their plight, and do what they can to rebuild and survive in the Outback. A select few dream of entering "the" Cities, but that is not likely to ever happen. A promise of citizenship is a common bribe the Cities' governments use with Outback people they deem useful or important, but ultimately the promise is a cruel lie designed to placate and use the "barbarians" to the Cities' benefit. A history of use and abuse that has gone on for centuries.

Throughout the Australian wilderness, towns, villages, farms, settlements and trading posts have sprung up. Most are located where fresh water can be easily had from water holes, fresh water lakes and rivers, as well as along well travelled roads, cross-road junctions and the few places where arable land can be found or cattle raised (again, water becomes a priority). Others are built from the ruins of old **pre-Rifts** cities or at the sites of old **cities**, in a feeble attempt to recapture the "old ways" or to hold on to one's roots. The farther one travels away from the ocean coastlines the more deserted and dangerous the land becomes. In the northern areas, and in the deserts, life becomes much harsher and even less civilized. While most "Rim" dwellers are good, comparatively civilized people, savagery has consumed the more isolated and hostile regions. For some people, raiding and scavenging has become a way of life, and violence is the solution to every problem.

There is not really any **such** thing as the "average" Outbacker. Loners, savages, bandits, raiders, cutthroats, Aborigines, farmers, cowboys, and all manner of decent, hardworking people all coexist and struggle to survive with what little technology, resources and courage they can muster. To these wilderness people, a computer is a rare marvel, Mega-Damage weapons and body armor are powerful devices that can make the difference between survival and death or being a slave or free man. All technology is a valuable commodity that enhances one's chance for survival.

## Aborigines

### ... and the meek shall inherit the Earth.

More than three quarters of the old cities were toppled and millions upon millions perished in the initial Cataclysm. The heaviest casualties came during the magical storms that followed and transformed the land in a primordial fury. Millions more perished with each wave of destruction. The government obliterated, three quarters of the population dead or dying from injuries or disease, Australia, like the **Americas**, most of Europe, Asia and so many other places, saw the complete collapse of civilization, complete anarchy and more death.

By contrast, a huge number of Aboriginal people escaped the destruction of the Great Cataclysm and the plagues and short-lived city-wars that ravaged the few who survived. Their shamans and holy men had foreseen and forewarned the coming of the Apocalypse. Thus, many had fled the cities and reservations to gather in tribes at sacred places and near forgotten sanctuaries spoken of by **their** ancestors, safe from the "cleansing storms." They waited, hidden, for generations, foraging for food and returning completely to the old ways. Having weathered the storm, they have only recently fully emerged and reasserted themselves as a true people and power in the land. For the natives, the world is as it was thousands of years ago and returned to the way it should be. If rightful ownership has been granted to anyone who lives on the continent, it is to the Aboriginal people. No one else can live as perfectly in the new wilderness of Rifts Australia as they can, and nobody understands "The Dreaming" as they do.

At the moment, the Aboriginal people consist of a large, fractured body of tribes and communities that are content with things as they are. They have no secret agenda, schemes or plans beyond living and enjoying their land, their lives and the splendor of nature and Australia herself. They, like **their** precious **land**, feel reborn and at peace in the world. This doesn't mean they don't suffer from their share of hardship and adversity, just that they accept it as a natural part of life and are content living on and with the land. See the section on Aboriginal people (and the **Dreamtime sourcebook**) for more details.

## I love a sunburnt country ...

The first thing an outsider would notice about Australia is the heat. It is a very open, barren place, baked in the sun for thousands of years. The interior is a desert, and the coastlines are relatively low. Vegetation is prolific, but it is thin and dry. And dry is the optimum word, because the heat is a dry heat; overall humidity is very low. Some deserts are as hot and unforgiving as the Sahara itself. Although much of the land is arid or savanna-like grasslands and scrub, there are areas covered by rainforest — lush tropical forest as thick as the densest jungles of Africa, Asia or South America.

Australia is permeated by climatic extremes, but overall it is a hot country, with an annual average temperature of 86 degrees Fahrenheit (30 C). Outbacker communities must take extreme measures to prevent **bushfires** and to protect themselves from the sun, especially during the summer months.

Bushfires, in fact, play a big part in the country's ecosystem. A forest can get so dry that branches rubbing together in a high wind will ignite a fire that will spread, explosively, for miles

and miles, consuming everything in its path. This **burning** process leaves entire tracts of **bushland** blackened, but not completely destroyed. Australian hardwood trees **regrow** quickly, and the animals are also quick to return. Sometimes Aboriginal tribes will even start a controlled **bushfire** to cleanse an area of land and let it regrow stronger and greener.



## ... a land of sweeping plains

Rifts Australia is very flat. Its highest point is on *Mount Kosciusko*, which is a mere 7300 feet (2225 meters) above sea level. The average expanse of Australian land is pretty much level, from hilly, open countryside, to deserts and rocky flats. The mountainous areas are towards the eastern coastline.

Australia is also very unique in terms of its actual soil composition. While many European and American lands have rich deposits of fertile topsoil upwards of 8 feet (2.44 m) deep, Australian topsoil can be measured in inches. Australia has no native animals with hard feet, so fertile ground has survived for millennia with little soil. However, agriculture and the herding of cattle and horses have been very damaging, causing erosion and rising salt tables. Some of this damage has been repaired by the reprieve granted by the Great Cataclysm, but many areas have turned to desert.

The most abundant vegetation can be found along the eastern coast. In Queensland, mangrove forests and rainforests are common, and towards the south, thousands of miles of bushland

cover the N.S.W. and Victorian Rim. The coastal Northland is also heavily vegetated with **bushlands** and crocodile filled swamps. Most other areas, particularly inland South Australia and Western Australia, are primarily parched earth, scrub, and desert.

## Magic, the wave that refuses to break

Australia is a very magical land, as alive with mystic energy as the British Isles. Every day of every year, a ley line nexus flares and opens to some alien dimension or world to disgorge a new menace. Some alien intelligences have already taken a firm hold, bringing vampires and demons. Ancient gods have also returned to take note of recent developments. The **Tikilik** demon, the Great **Devourer** of the world, waits and grows beneath the inland sea, preparing for the day when it can emerge to destroy all life. The great **Bunyii** and his Rainbow Serpent, benevolent beings of **lore**, do what they can to help their people guard against the Tikilik and his countless demon minions, including the Yowies, **Bunyips** and the like.

Thankfully, many benevolent forces have entered the Earth realm, creating a balance between good and evil. *Millennium beings* cover Australia, from the legendary Trees of Life to the Great Reef herself. **Furthermore**, so-called demons and other monsters have not taken the firm hold they have in Germany, Russia or China. Rifts Australia is comparable to North America where monsters and alien menaces are a constant danger, but not an omnipresent force.

Australia is wrapped in something the Aborigines call *The Dreaming*. The Dreaming is primarily their way of describing existence as a whole, but it is much, much more. It is made up of the spirits and magic that have returned to the world. The Dreaming has created a new race, the **Kwarla**, guardians of the wild. It has even caused the growth of the Millennium beings, and has given strength to the ley lines (called "**Songlines**"). Australia itself is a continent *made* of magic, but all this magnificence is not apparent to everyone. It is almost exclusive to the "natives" — animals and people alike, as if the land itself is showing preference for those who have grown with it for a millennia or more. Visitors from nearby lands, and even most white people who survived the Great Cataclysm and experienced the Rebirth of Magic over the ensuing generations, usually fail to see the mysterious magic and wonders of the "Dreaming." They lack the heritage and traditional connection to the land possessed by the Aboriginal people and native animals. All these outsiders can see is that Australia is an isolated and dangerous place. Some would even say a dying land, rife with violence. Its only real value, the few forest paradises, the splendor of the Great Reef, and the sanctuary of the grand old cities of Melbourne and Perth.

## Life, in all its forms & glory

**Monsters & Demons.** While not nearly suffering at the same level as China or Africa, Australia is extremely prone to demonic and monstrous infestation and visitation by strange and alien creatures. The magic level is so rich, especially in certain locations, that Australia, and the Dreaming, is like a beacon in the **Megaverse** that attracts creatures of magic and demonic beings to feast upon the Earthly realm.

The most common form of demon is the demonic predator. Such beings include the randomly rolled monstrosities described in the Game Master section of the **Rifts** main rule book, those presented in **Rifts® Conversion Book One**, and occasionally, demonic beings presented in **Rifts Japan, China** and **Russia**. The most notable are those who have been associated with the **Dreamtime** and Australia since the being of time. These "Australian" demons and monsters are presented elsewhere in this book.

Predatory demons drag men and women to their doom, raid towns and settlements, and plague mortal humanoids on a regular basis. The more intelligent, cunning and vile demons engage in more subtle acts of cruelty and evil, often manipulating and corrupting humans and instigating plots that unleash suffering and destruction on a large scale. These more powerful beings may also try to build their own gang or kingdom, and lord over those forced to serve them.

Melbourne and Perth, with their technology and high-powered arsenals, have the least problems repelling such demonic threats. To a lesser extent, the Aborigines are also capable of defending themselves against supernatural menaces with their magic, sorcerers, dream warriors and the blessing of the Dreaming. The poor Outbackers and all other wilderness folk are the ones who suffer the most, as they are badly informed about the supernatural, have few resources and are poorly equipped in the way of weapons, knowledge and magic.

Nonetheless, it is the Aborigines who fight the fiercest battles against supernatural invaders. As the protectors and owners of the land, it is their duty to battle the **despoilers** and supernatural evil. They are the natural enemies of demons and dark practitioners of magic, and are part of a full-scale war between good and evil. It is a relatively quiet war that many are oblivious to, but if the Aboriginal people have one overshadowing fear, it is that they will lose their Dreaming to the menaces that threaten them. Honorable and brave, they will fight to the end, for that is their place in the world.

## Powerful Forces at Work

Above and beyond the supernatural menaces and demons that haunt the Australian landscape, there are much more powerful forces at work. *The Bunyip* has cast his eye towards the sunburnt land once more, as has the *Rainbow Serpent*. These ancient gods, though separated by the dimensions, do what they can to help their children (See the monster section for details on the Rainbow fragments).

On the other end of this scale are the Aboriginal demons. The weather demons and the Bunyips seek only to destroy mankind so the land may, once again, become a playground of evil spirits. Currently, all the dark spirits are locked up inside trees and animals where they belong, but demons like the **Bunyip** seek to return the universe to the chaos it was spawned from. And the greatest demon of them all is the *Tikilik*. According to legend, he is the one who will destroy the world by drinking all the water. He has broken through into the Earth realm, and his physical form lays dormant, but growing into a huge and monstrous frog at the bottom of the Inland Sea. Once he reaches maturity, he will rise to wreak havoc upon Australia and then the world. A few have foreseen his coming, and may be able to marshal the forces to help humanity defeat this menace before it gets too strong.

Overall, Australia is plagued by the shadow of supernatural evil. Menaces not native to Aboriginal myth have also entered from other dimensions — vampires in particular. Many of the white residents, particularly the City-Goers, are oblivious to the massive threat these creatures represent. To them, everyday survival is enough to worry about.



## Animals

Australia has a very unique array of animals. G.M.s should never lose sight of the splendor of Australian wildlife, which is every bit as **marvelous** as the plains of Africa or the jungles of South America. The first and most notable fact is that there are no large animals or hoofed creatures native to the continent (with the possible exception of some prehistoric animals and the notorious crocodile). The second is the level of ferocity in most Australian animals, which is generally quite high, and the number of poisonous snakes, deadly spiders and crocodiles (which fill the rivers and swamps). It is a very harsh wilderness these creatures must survive in, and they are equally as harsh.

The biggest threat to the natural Australian cycle of life comes from the "introduced species" — cattle, buffalo, wild pigs, goats, sheep, horses, foxes, rabbits, toads, domestic and feral cats, dogs and mice. They contribute to diminishing native species, soil erosion and imbalanced food supplies. Add to this the appearance of new creatures who come from the dimensional Rifts, and you have an ecological nightmare. The Outbackers have come to understand the dangers of certain animals and engage in hunts and organized trapping to rid the local regions of particularly dangerous pests, but the problem is too much of an epidemic to deal with effectively. Besides, animals like horses, cattle and dogs are still employed as work and produce animals by the majority of the white humans and D-Bees.

Few native species are bred for farming purposes. Some rare farms raise Emu (a large, flightless bird — Australia's Ostrich) for both eggs and meat. Slightly more common is the raising of kangaroos for meat and leather/fur. Imported cattle, horses, pigs, sheep and other animals that survived the Apocalypse are also raised as livestock, work animals and pets. Otherwise, hunting has once again become a method of providing food and many varieties of animals appear on Outback plates. In the cities, meanwhile, meat is reserved for the higher level citizens, and soy synthetics are given to the lower classes.

The most common Australian animals seen in the wild are kangaroos, wallabies, lizards, dingoes, kookaburras, bats, birds and frogs. Wombats, koalas and other smaller creatures tend to be very shy and reclusive. In the Northland and swamps throughout the continent, the dreaded saltwater crocodile is a common sight, as are a variety of poisonous snakes. Most of the wildlife, of course, inhabits the lush, forested Rim region and the Reef islands, while the deserts remain as barren as ever, but far from lifeless. Snakes, lizards and other reptiles, as well as birds, insects and alien life forms survive out on the sun-baked earth, but not much else. Otherwise, the different animal species are fairly evenly displaced, although they favor the eastern and southwest coasts. Note: Statistics for some common animals can be found in the monster and animal section, presented later.

## Plant Life

The majority of native Australian trees are hardwood trees, and very sturdy. Many make poor timber because they will break an axe before they are chopped down, while the softer trees are usually too small and too soft to be of much use. The only truly usable wood comes from the rainforests.

Australian plant life is very rugged, and can, of course, survive hot, dry temperatures. The bushlands consist mainly of eucalyptus trees of various types, grasses, and many low bushes and shrubs. For the cunning **survivalist**, these plants provide water and even **food**, but to the untrained, the bush is a deathtrap, with almost nothing appearing as edible and much of it poisonous. Australian swamps, once rare, are much more common in Rifts Australia, but are limited to the coastal areas and rainforests.

In the deserts, the only thing growing will be cacti, aloe vera and low, bushy plants. Strangely, of all the sandy deserts in the world, the Australian wastes are quite highly vegetated, and in the rockier areas, small patches of bushland and murky **billabongs** appear. The open expanses are covered with plain yet colorful plants which, again, can allow the well trained to survive indefinitely.

The Australian landscape has been transformed by the Great Cataclysm with the fall of old mountains, the rise of new ones, changed water tables, the Inland Sea and other changes. The landscape has been further transformed by alien plant life that has been carried through the dimensional Rifts. This includes a variety of bushes, flowering plants, cacti and trees. Most fit relatively well into the Earth environment, and while some of their fruit or seeds are poisonous, represent no substantive threat to humankind.

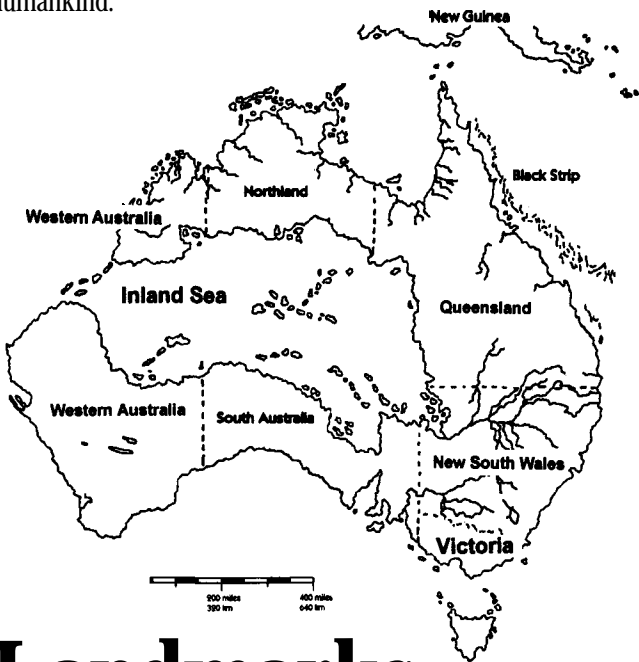

# Landmarks

Places of Note in Rifts Australia

## The Old State Borders

New Divisions. Since the Great **Cataclysm**, many of the old borders and State divisions have all but disappeared. The way in which people refer to different parts of the country remains the

same, but concepts of genuine border lines are all but lost. This is largely because there is no one, unifying government or any independent kingdoms. Although there are many scattered, independent towns, settlements, gangs and tribes, all consider themselves to be "Australian," effectively making Rifts Australia a shattered nation of diverse and chaotic people and communities without national leadership, unity or direction. Just clusters of people doing what they must to survive in a world gone mad.

From a practical point of view, the old borders have been replaced with identifying natural formations and divisions such as forests, rivers, mountains, strange terrain, the Inland Sea, etc. The primary regions of distinction that everyone makes note of are the *Rim*, *The Gap*, *The Outlands* and *The Inland Sea*. It's as if Australia is divided into rings, with the outermost ring being "the Rim" — containing the cities, many scattered towns and settlements, farmsteads, forests and the Great Reef; the next ring being "the Gap" (mainly grasslands and scrub populated by outbackers); the third being the parched earth and deserts of "the Outlands," and the final ring being the "Inland Sea" and its coastline.

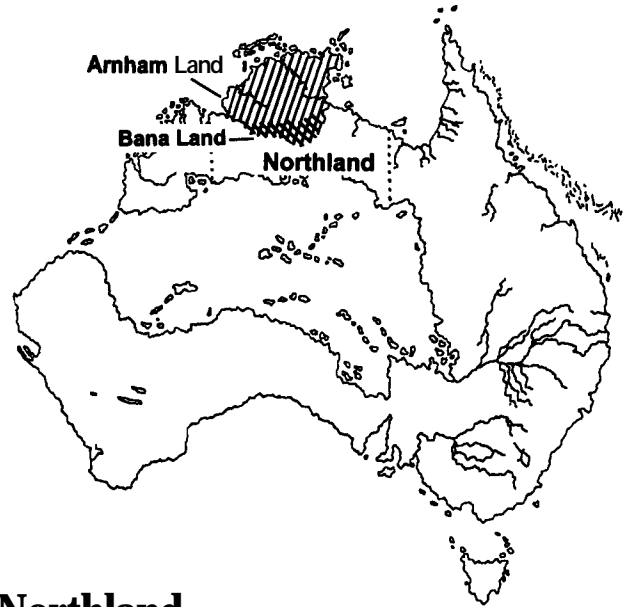

## Northland

The Northland is the name given to the northern, middle section of Australia that stretches from the Gulf of **Carpentaria**, west to the Joseph Bonaparte Gulf. These lands have suffered most from the rising sea levels. Rivers and deltas have been submerged and turned into mangrove forests and swampland, mountains have been broken into islands, and in **general**, the entire stretch of country (what's left of it) has become poor real estate. The most interesting thing to note about this part of the country is the Mokoloi tribes who have taken up residence in the swamps.

**Arnham Land** is the name of the northernmost edges of this State. It used to be a spectacular natural reserve, filled with untamed wilderness and spectacular natural wonders. These days it is home to powerful ley lines, and thus heavy demon infestations, so while the landscape is no less spectacular, it is twisted and dangerous to say the least. Arnham Land has many points of spiritual significance to the Aborigines, but these places have been corrupted and consumed (see notes on **Bana-Land** below). Very few people live here, and it is avoided as a dangerous, demon-haunted region.

The southern parts of the State used to contain the *MacDonnell Ranges*, but these now form the **Isles of Light**, a chain of rocky islands that circle the deepest part of the Inland Sea where the *Tikilik* sleeps. Interestingly enough, the resting point of the demon is the same location as *Alice Springs*, a pre-Rifts desert township. It was once a popular site to visit, and may still contain treasures submerged under the water.

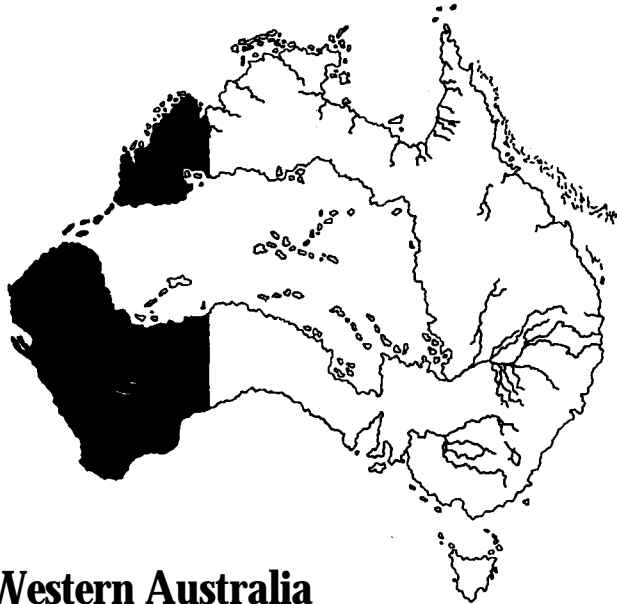

## Western Australia

This is the largest part of the country. Its pre-Rifts border cut in a straight line from the **Joseph Bonaparte Gulf**, south to the center of the **Great Australian Bight**. The land is mostly flat, made up of expansive deserts and parched desert scrub land. It is dotted with occasional low mountain ranges where one can find scattered patches of scraggly trees and underbrush (to call these clusters of vegetation "forests" is too strong a word).

The population in this State of the Old Australian Empire is very low, with **Perth** and the surrounding Rim communities being the only real population centers, although quite a large number of Aboriginal tribes wander the **Gibson Desert**. Second to Northland, Western Australia has lost the most territory to the Inland Sea.

The southern edge of Western Australia is the **Great Nullarbor Plain**, which is a famous wilderness. While flat and still relatively barren, it is a combination of grassland, scrub, scattered trees and home to a large concentration of D-Bees and other alien creatures. Elves and even some Faerie Folk grace this part of the country, but the main population is still Aboriginal tribes.

The **Nullarbor Plain** ends quite suddenly at the coastline, with a sharp line of cliffs that drops into the **Great Bight**. This coast is very dangerous, and is frequented by sea demons and monsters of all kinds. A powerful ley line follows this coastline, so at night it glows and crackles with energy, and frightening shapes of dragons, winged creatures and demons can be seen silhouetted in the sky.

On the northern edge of Western Australia, above Perth and the Darling Ranges, is an area called **Shark Bay**. It is a section of land that juts north out of the coast, and is currently being used by *Horune pirates* as a secret base. Several other races from the deep have started using this part of the country as a "safe port," which, ironically, has made it a dangerous place for surface dwellers and Australians to visit.





## Queensland

Queensland is made famous by the fact that the northern part of its coastline is protected by the **Great Reef**. All across Australia, stories abound about this paradise and the fortunate few that live there, but getting there is often impossible because Queensland is a spawning ground for demons, mutants and monsters, and home to gangs of bandits, rugged Outbackers, and other wilderness people. This old Australian State, more than any other, is rich in life. The Rim, which runs over this part of the coast, is covered with thick rainforest, and filled with struggling Outbacker communities. Inland, the desert plains, where huge cattle ranches and grain farms used to exist before the Coming of the Rifts, are now rocky desert broken by **scrub**, small patches of grassland and the occasional thin forest or fortunate patch of still arable farmland. Some of the largest and most brutal groups of Roadgangers in Australia can be found in these parts. The Aborigines live out a shadow-like existence in this State, trying as hard as possible to lay low and avoid the many human and inhuman dangers of this region, while maintaining their peace with the Dreaming at the same time. Queensland has become a violent and frenetic place, where only the strongest and most clever have any chance for survival.

Further south lays the **Norman Delta**, also a place rich in life but devoid of **humanoid** inhabitants. Only slightly above this delta is **Wellesley Island**, and the Vampire Intelligence that resides there (see the G.M. section for details). The country below this area continues to be relatively uninhabited until the Brisbane River, which ends at the **pre-Rifts** site of the State's old capital city. This city sunk into its own river, and the *old skyscrapers* still jut from the waters, making for an eerie post-Apocalyptic image. Today, its only inhabitants are a few human villages (less than 1000 people total). Only the bones of the old skyscrapers rising from the river remind travelers that a great city once stood on this spot. Most people avoid the region because it is said to be haunted by the spirits of the dead, who still walk the (now underwater) city streets and inhabit the ruins of the skyscrapers. Indeed, poltergeists, haunting entities, and tectonic entities abound here, especially among the ruins, as well as the occasional possessing **entity**, and similar demonic beings.

South of this point, Outbacker communities become more common.



## Peninsula Space Port, Queensland

Several landmarks exist along the Queensland Rim. In particular, up on the tip of the **Cape York Peninsula** lay the ruins of a huge *space port* that was destroyed by the Apocalypse. It is located on the northernmost tip of Australia, concealed by rainforests and rocky hills. Centuries ago, it was one of many space ports around the world used for launching large spacecraft in bulk numbers. Needless to say, it is now inactive and unable to function. The towers are ruined and broken, the computers are dead, the spacecraft are destroyed, the power supplies are gone, and the nuclear reactors leaked during the holocaust until the computers crash-dumped the dangerous, radioactive cores into bunkers miles beneath the surface of the planet.

The **ruins** have been salvaged and turned into one of the (comparatively) safest and strongest townships in the region, a place known as **York Station**. In addition to being a home for over 7,000 **Australians**, it has also become a haven for 3000+ human refugees and 2000 (various) D-Bees who have managed to escape from demon-plagued Asia, slipping past the monsters of New Guinea, the Black Sail Ships, and the dangers of the Northland. York Station is actually a cluster of several small, fortified towns, farms and ranches working closely and peacefully together to eke out a precarious and low-tech existence while fighting hostile invaders from Asia or the sea (like the **Horune**), local bandits and supernatural terrors.

The old Peninsula Space **Port**/York Station is unique because it is a defensible haven where people have been able to gather, fortify and rebuild. York Station is now littered with jury-rigged

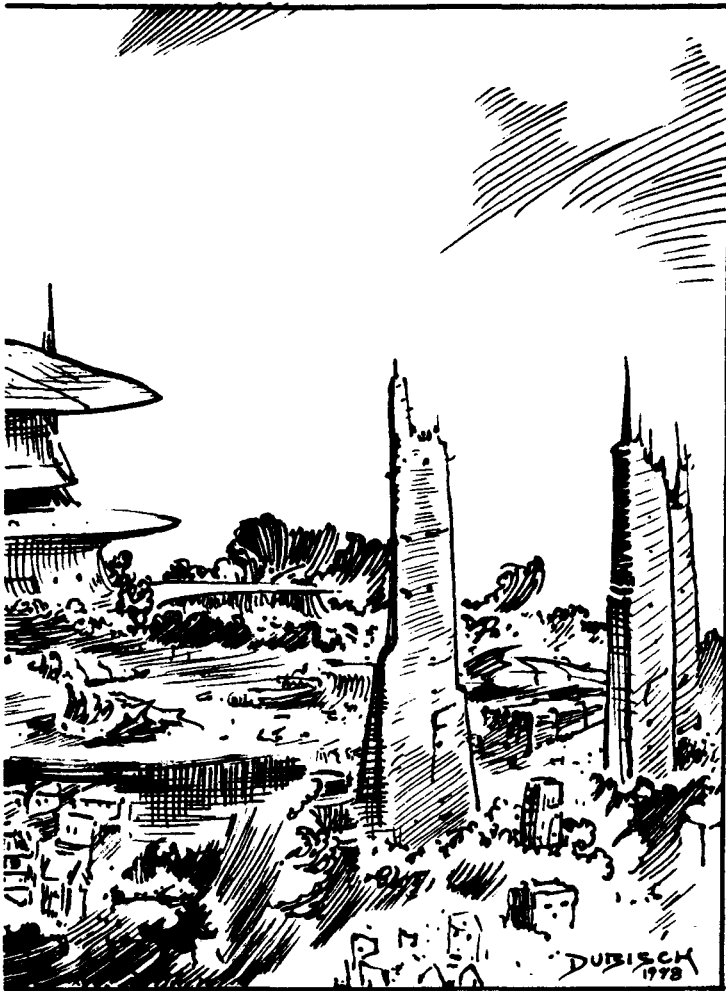

gun nests, M.D.C. walls, barricades and pre-Rifts shelters. Homes have been erected using the buildings and materials salvaged from the Space Port as their foundation, as well as, utilizing many of the surviving buildings and infrastructure of the old complex. People survive by using primitive technology hand in hand with the weapons and equipment they have salvaged from the ruins. The community is mostly cut off from the world by ocean, and from Australia by the hundreds of miles of rainforest and hills that lay to the south. Its existence is unknown to the two Cities and to most people in the Outback. The inhabitants of York Station like it that way and make no effort to make contact with the outside world for fear of invasion and war. Outsiders are viewed with suspicion and a certain amount of fear, but are not hurt or confined by the peaceful inhabitants of York Station — they are free to come and go as they please, although they may be asked *not* to reveal their location to others. Most agree, because York Station makes a nice, secret, safe haven in the savage wilderness of Australia.

## New South Wales (NSW)

As in times before the Great Cataclysm, New South Wales is heavily populated. The inland areas of this part of the country are very dry, but are less than desert many of the other old States. Even the sandy wastes actually contain reasonable amounts of vegetation. The Rim territories are covered with vegetation and forests much wider along the coasts. The *Great Dividing Range* forms Australia's highest point at **Mount Kosciusko**, towards the southern border. Along the foothills of

this range are hundreds of square miles of **bushland** (tall grass, bushes, scattered trees), and even some rainforests in the northern areas. The coastline itself is rugged and spotted with cliffs, headlands and beaches.

There are many rivers cutting channels through N.S.W., including the famous **Darling River**. Pre-Rifts dams and energy plants still exist as ruins, but do little to divert the huge river, which has changed its banks several times since the Apocalypse. This river alone is responsible for the fertility of the old State, and close to 60% of the Outbacker communities are set up along her banks.

The aboriginals make **their** home evenly across this border of the old State, but tend to avoid the higher mountains because of the snow seasons. Similarly, the Roadgangers of N.S.W. are quite well distributed. Plentiful roadways have seen some of the savages travel as far east as the Rim itself, but they have never really made contact with the coastline. While they do make periodic raids on some of the less-established Outbacker communities, so far they have still been confined to their desert hell, by both a lack of fuel and stout Rim resistance.

N.S.W. used to be old Australia's leading State, and the nation's capital, **Canberra**, was located just northeast of Mount Kosciusko in a small province called the A.C.T., or Australian Capital Territory. This old capital is little more than crater-pocked grass and marshlands. Before the Coming of the Rifts, Canberra was a large, well-planned city that was self-sufficient and semi-autonomous to the rest of the country. In the years before the Great Cataclysm, it became a military state, and as such, filled with not just people, but weaponry, intelligence, information gathering operations and data from every corner of the globe. This massive cache of military wealth was consumed by the Great Cataclysm and buried under soot, dirt and water.

For daring adventurers, the area known as **Lake Canberra** *could* hold incredible wealth — Mega-Damage weapons and equipment, pre-Rifts history, valuable artifacts, salvageable armor and vehicles, and plans for building and processing long lost technology. The Melbourne government has already deployed two search and retrieval squads into the area on separate occasions, neither of which have returned. This serves to demonstrate to others just how dangerous the area is. The high con-







centration of life present in the area during the cataclysm led to incredible amounts of P.P.E. building up and tearing at the fabric of space. The dimensional Rifts that opened up there during the Apocalypse were enormous, and some have yet to close! Dead pools dot the surface of the lake, both supernatural and natural (landslides, radiation, etc.) hazards represent a constant danger, and the ruins at the bottom are buried beneath meters/yards of sediment.

Few people venture near Lake Canberra, as it is a dark place filled with evil and danger. The Undead stalk the lands and aquatic monsters swim through what toppled ruins of the city and military base that remain below the surface (average depth is 100 feet/30.5 m with some trenches and places being two to three times deeper). Those who try to recover the artifacts and secrets that *may* lay on bottom of the lake are rarely seen again.

**G.M. Note:** As a twist of fate, or in an effort to restrict the availability of pre-Rifts weaponry and equipment, this place could have already been (secretly) plundered by Captain Nemo II and his New Navy, or **Horune** pirates, leaving only odds and ends behind. Even if the site has been undisturbed for the last 300 years, a successful salvage operation will take months if not years (attracting the attention of the two tech-Cities and bandits) and require diving operations and underwater mining to dig through the 5-10+ meters/yards of dirt that covers most of the old complex. Simple exploratory dives may unearth only trinkets and the occasional M.D. weapon or item.

## Sydney, NSW

New South Wales is also the home to the city of *Sydney*, one of the greatest modern cities of the **pre-Rifts** world. When the ley lines rippled to life, millions of people perished from the destructive forces that shook the continent. As the new dark age burst onto the scene, upheaval, earth shattering weather, rising flood waters, demons and monsters cascaded upon the continent and pounded the great city, in wave after wave. Yet through it all, most of the Mega-Damage buildings and many of the S.D.C. structures that composed Sydney remained standing. With the death toll in the millions, the survivors of the Great Cataclysm were unable to cope with the overpowering weight of the rotting dead. Consequently, plagues and pestilence ravaged the city and surrounding countryside, killing millions more. Still, Sydney remained one of the few cities to remain standing, at least in part. The empty buildings lured the frightened and homeless to them like moths to a flame. The ruins of Sydney have fallen into the hands of myriad refugees, clans and gangs, and have been the site of countless disputes, battles and all-out wars, especially in the darkest decades after the Apocalypse.

Being a white man's city, the Aboriginal people did little to cleanse or defend the land from this carnage, and for the first hundred years, stayed away from it entirely. Besides, they were too preoccupied with their own problems further out into the wilderness. And so the once great city remained a shattered **hulk**, haunted with the spirits of the dead, lost to chaos.

## OI' Sydney Town

**Orientation & Disposition:** Hostile and **Agressive** (with the city's trade center being considerably more Open but Cautious).

**General Type & Size:** Major Outback Town (on the large side).

**A. Weapons and Armor:** 4. Firearms.

**B. Medicine:** 4. Very Good.

**C. Water:** 4. Comfortable.

**D. Agriculture and Natural Resources:** 4. Good.

**E. Real Estate:** 3. Fine.

**F. Vehicles:** 5. Good.

**G. Administration:** 2. Slight (varies among the gangs).

**H. Alignment:** 7. Mixed: Anarchist & Mischreant.

**I. Magic:** 3. Good Knowledge & Understanding.

**J. Racial Tolerance:** 4. Tolerant.

**K. Trade:** 5. Barter Town.

**L. Threats:** 2. Dangerous.

**M. Skill Level: The Community Itself:** 2. Average.

**N. Shelter:** 5. Fortified (many old **pre-Rifts** buildings).

**O. Security:** 2. Volunteer & Militia (many gangs).

**P. Power:** 5. Good: Mixed.

**Q. Special Features of Note:** Old M.D.C. ruins that can be fixed up (x3), pre-Rifts Underground Complex (x3), Good Roads, Large Advanced Garage, Communications Suite, and **Nonhuman** allies (Gargoyles and **Brodkill**).

Today, the ruins of the city is called **Old Sydney Town**, a broken and **flooded** relic of an era long gone. At least half the city remains standing, although her buildings are battered, cracked, and crumbling — ravaged by the elements, time, and many wars and skirmishes during the centuries that have followed the Great Cataclysm. Many of its streets are flooded and swamps and marshlands are found around and throughout the old city. Scores of gangs, bandits, vagabonds and squatters have reclaimed most of the habitable buildings and areas around them. An estimated 59,000+ live here, and thousands more visit and trade here. Most inhabitants are members of gangs and clans who claim particular streets, neighborhoods, and buildings as their "turf" and frequently clash — sort of like little towns or communities within a larger city. This "city" of scoundrels is a lawless and frightening community where might usually makes right. A handful of farms and cattle ranches are found on the dry outskirts, but even they are tied to the more powerful gangs and crime lords of OI' Sydney Town. At the heart of town is a trading post with a number of saloons, gambling halls, shops, garages, car **dealers**, fences, smugglers, hotels and dens of iniquity. It is frequented by adventurers, mercenaries, Outbackers, Roadgangers, bandits, and criminals of all kinds. Rumor has it that both Perth and Melbourne fear this growing cesspool of sin and have spies placed to keep an eye on things.

Dangerous clans of **Brodkil** and *Gargoyles* (no more than 3000 of each) have also laid claim to parts of the ruined city, living in the tallest and most dilapidated of the skyscrapers. **Surprisingly**, these **subdemons** interact with the **earthbound** humans, regarding many of them as kindred spirits, comrades and fellow citizens of this lawless city. Many individuals and clans of Brodakil and Gargoyles are active members of human criminal operations, bandits, street gangs, Outback raiders and Roadgangers. Others stick to their own kind and "run" with only fellow Brodakil or Gargoyles, tolerating humans largely because

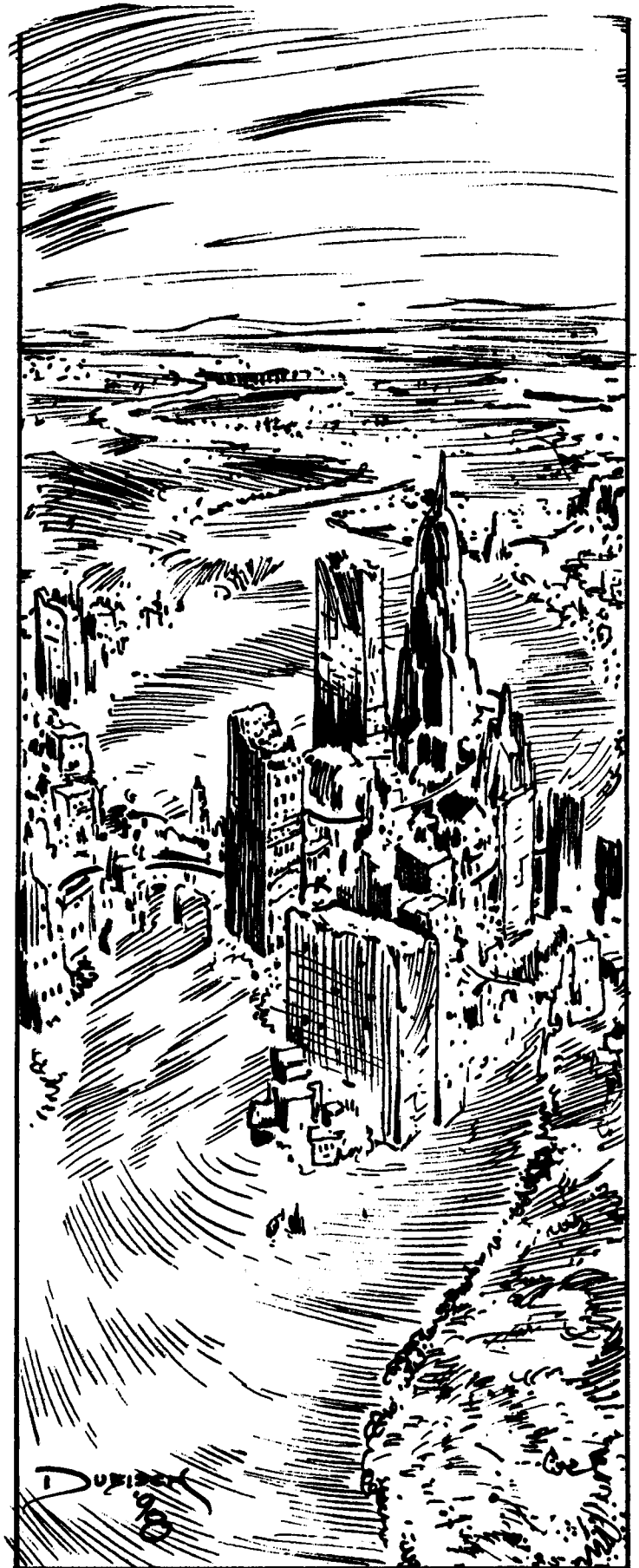

they are outnumbered by them. Although a constant potential threat to the human and D-Bee inhabitants of **Ol' Sydney Town** and given to fits of violence, bloody vendettas and brutal **brawls**, the demons seldom battle or plunder "fellow" **Sydney Towners**. Instead, they attack travelers, outsiders, rival gangs and the outlying Outback settlements. They also enjoy raiding the military troops, **burbs** and cities of Perth and Melbourne.

If these subdemons represent a genuine threat to **Ol' Sydney Town**, it is that each race hates the other and are constantly embroiled in petty squabbles, acts of one-upmanship, schemes, feuds, vendettas, retribution, sabotage and **troublemaking** against one another. Thankfully, the most violent and bloody of these gang wars have taken place on the rooftops and in the sky above the soggy streets, rather than in them. Consequently, human casualties caught between these rival and warring demonic factions are usually light. Generally speaking, these gang-banging rival subdemons seldom gather in bands of more than 500, although most groups, especially among the Gargoyles, are well organized, patient, cunning, treacherous and ruthless — the **Brodkil** tend to be more direct and violent. Few lawabiding or god-fearing people venture close to the old city and never willingly go there for any reason. On the other hand, adventurers, mercenaries, criminals and outcasts may find **Ol' Sydney Town** a place to lay low and hide from enemies, or a place to find employment, adventure and opportunity.

Beyond the outer limits of the city, about 70-120 miles (112 to 192 km), where the wilderness has reclaimed the land, a handful of large Outbacker settlements **flourish**, despite the usual hardships and regular raids and trouble from **Ol' Sydney Town**. These towns are well armed and fortified. Some try to have nothing to do with the undesirables of Sydney, while others engage in the trade of goods, services and information in hopes of being spared plunder and trouble, not that it does them any good. None of these communities have a population of more than 6000 and most are about half that big.

**Bendalong Point.** A headland near the opening to Sydney Harbor, called Bendalong Point, is the ancient site of a **pre-Rifts** landmark called the Sydney Opera House. This huge, white building was a timeless structure that was synonymous with Sydney itself. Of course, this has since been destroyed and the headland has sunk under the sea, but Bendalong Point was a strong magical site centuries before it became a famous pre-Rifts landmark. A powerful nexus now stands **there**, breaking the surface of the waves like a huge roman candle. Around it is a large dead pool (see **Rifts® Underseas™** for details on dead **pools**), and the nexus itself will sometimes tear open to release demonic menaces, to add to the drama of this wild, post-apocalyptic city. This powerful junction of magical energy is so bright that during certain parts of the year it acts like a lighthouse, shining out over the sea and towering two miles (3.2 km) up into the sky. Most demonic predators are quickly **destroyed**, or escape into the wilds to prey upon easier targets at one of the nearby Outback settlements, but occasionally, swarms of monsters or truly powerful supernatural beings appear to reap havoc on the city and countryside.



## Victoria

Victoria has the highest population density in Rifts Australia, if not simply because it is home to the city of Melbourne, then also because there are a huge number of Outbacker communities that have set up along the coast of Melbourne Bay. It is a very rugged State, covered with thick **bushlands** and the rocky tail-end of the Great Dividing Range. In general, it is a lush area teeming with vegetation, wildlife and humans. Unfortunately, this high concentration of activity and humanoid life also attracts many demons, vampires, monsters and raiders, but the communities do their best to hold back these menaces. Other than the occasional underground ruin, or piece of building jutting from the ground, little in the way of pre-Rifts technology has survived (outside of Melbourne). What did survive has been plundered centuries ago, or has been buried under the shifting of the land or tangled growth. Still, the occasional site is uncovered and put to good use.

Only the western edge of the state fades into desert before the border which opens into South Australia. In these desert areas are large numbers of desert worms, and struggling desert communities.

The coastline of the entire State has been ravaged by rising sea levels, and aside from the new island where Melbourne rests, new fjords, headlands and rocky strips have appeared. There are no beaches to speak of anymore.

## EHRA

The entire southeastern "Rim" of **Australia**, from the **Ol' Sydney Town** down across the Victoria **coastline**, is referred to by the **City-Goers** of Melbourne as EHRA (pronounced 'era'), which stands for the Eastern Humanity Republic of Australia. EHRA is a zone the Admin likes to think of as the last true bastion of humanity, a State of sorts that replaces the old divisions of NSW and Victoria; divisions that Outbackers still like to use as reference. The grand plan of Melbourne is to "civilize" EHRA as a country in and of itself (or as the first true State of New Australia), and they have already started sending survey teams into the Great Dividing Range to consider the possibility of building advance military posts and start "cleansing" the area for future development.



The main problem with this plan will be the Aborigines and the supreme claim they have to this (and indeed any) part of the country. But this is by no means the *only* problem. Demons, reluctant, established Outbackers, **Roadgangers**, other raiders and bandits, monsters, dimensional portals, ley lines, and so on, all pose problems that will slow down this endeavor. If the concept behind building a new nation called EHRA ever does become a reality, one can be sure it will be another imperialistic, puritan zone like the Coalition States of North America.

## Tasmania



This State lies on an island south of Victoria, over the Bass Strait. Tasmania is now nearly deserted, and has been reclaimed by the wilderness. It was once actually a State of Australia, an island that sits off the southern end, directly south of Melbourne. Extended travel away from the mainland is quite rare in the post Apocalypse era, and the island is considered by most to be a deserted wilderness, home only to animals and very basic supernatural creatures. Many assume that no one has approached or landed on Tasmania, as it has little to offer in the way of supplies apart from timber — a resource the City of Melbourne does not hold in high demand.

The island itself has been severely damaged by the Apocalypse, broken and battered by tidal waves and storms. Sections of the island have broken away to form several smaller islands. It is a place that has essentially been forgotten and ignored by the people of Australia, except for the small **Sadro Island**. Sadro is a prison island used by the City of Melbourne. It currently contains nearly 500 inmates. This use of the island began about 50 years ago when Melbourne realized that when they exiled prisoners to the mainland, there was a good chance the misanthropes would return to extract revenge, or undermine the peace of the citizens by telling of the (true) horrors of the mainland, spreading panic through the greater populace. After several such incidents, a new secret policy was passed to use the remote island as an exile dump. Now anyone who is captured breaking into the City walls (raiders and dream seekers alike), as well as anyone sentenced to exile (including City born criminals and those captured from The Gap) and prisoners of war are dropped into the forests of this wild and inhospitable strip of land, and left to fend for themselves. What has emerged on the

island is a violent, savage culture made up of violent criminals, sociopaths and POWs. Rumors of cannibalism are quite common. One thing is for sure — no one has ever returned from **Sadro**, though some have managed to swim for the main Tasmanian island.

**Tasmania** itself is a very lush land, covered with dense forests and rich with wildlife. The region also has a high amount of magical energy. Several unsuccessful expeditions have been mounted by the Melbourne Administration, but taming the island is very unlikely, let alone settlement. It has been rumored that a few very primitive tribes of Aborigines live on Tasmania, as well as small bands of Outbackers. Popular opinion, however, is that *no person* on Tasmania survived the Apocalypse.

One of the highlights of Tasmania is the ruin of its old capital city, **Hobart**. Today, Hobart is a half submerged, wasted city, but it has barely been touched since the Coming of the Rifts. As such it has yet to be plundered, and for those brave enough to land in the city or dive to the submerged ruins, chances are **they'll** find **pre-Rifts** artifacts of great value.

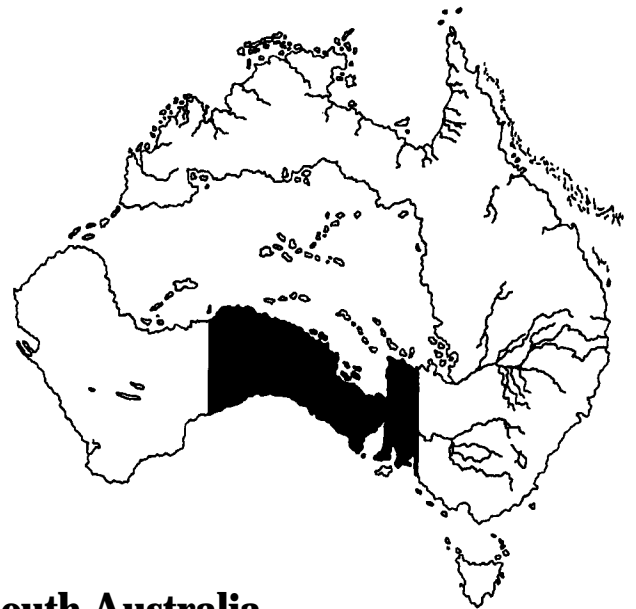

## South Australia

South Australia was the "middle" State of Australia, touching at least one edge or corner of every other state (except, of course, Tasmania). Much of it has been submerged by the Inland Sea, but the *Southern Rim*, with the **Nullarbor Plain**, *Stuart and Flinders Ranges*, has remained. The region is very dry, and while the rocky deserts are quite small and relatively green, they are very unforgiving and bleak. There are hundreds of powerful ley lines and nexus points that dot the landscape, making South Australia a hazy, magic soaked zone short on human and animal habitation, but strong in supernatural activity.

The main population is concentrated on the southeast coast, nestled in the *Spencer Gulf* and the *Gulf of Saint Vincent* upon the ancient ruins of **Adelaide**. This is the only truly fertile ground outside of the Nullarbor Plain, and much of the country is now irrigated and settled by industrial age communities. There are no high technology cities anywhere in South Australia, and no enviable townships — it is for the most part, a barren place, and is slowly dying with each passing generation. The South Australian deserts are home to the most violent and horrid Roadgangers in the country, many of whom engage in **cannibal-**

ism. South Australia is a harsh land that separates the east from the west. If Melbourne and Perth ever wish to establish trade and transport routes between each other, they will do so by sea, a few hundred miles out from the southern coast.

## The Inland Sea

The Inland Sea is rumored to have existed thousands of years ago, well before the Coming of the Rifts, and even before civilization moved onto the continent. High salt tables, sandy deserts, water smoothed rocks and the flat countryside all pointed towards its past existence. With the Great Cataclysm came several things that amounted to the Inland Sea returning. The first, of course, was rising sea levels. Thousands of square miles worldwide have been claimed by the oceans, but this alone was not enough to break the dams of the Australian coastlines. Earthquakes, tidal waves, raw magical energy and supernatural visitation split the country straight through the middle and allowed the oceans to flow in. The first place to break was a section of coastline called the Eighty Mile Beach in northwest Western Australia. Being a low stretch of country where the desert met the ocean, this entire strip of land acted like a channel that allowed the ocean access to the "red center." Only a few decades later, the wet lowlands of Northland reached saturation point and the Inland Sea rose even higher, reclaiming deserts as it did so, and pushing the fertile strips of country closer to the coast, to form what is now the Rim.

The Inland Sea is rarely traveled, and holds no life beyond standard sea creatures. The presence of the Isle of Light chain of islands, and the **Tikilik** demon, have combined to make it an area of sea as barren as the deserts it reclaimed. It is entirely possible that **Naut'yll**, **Horune** and other seafaring beings have visited the Inland Sea, but none have stayed.

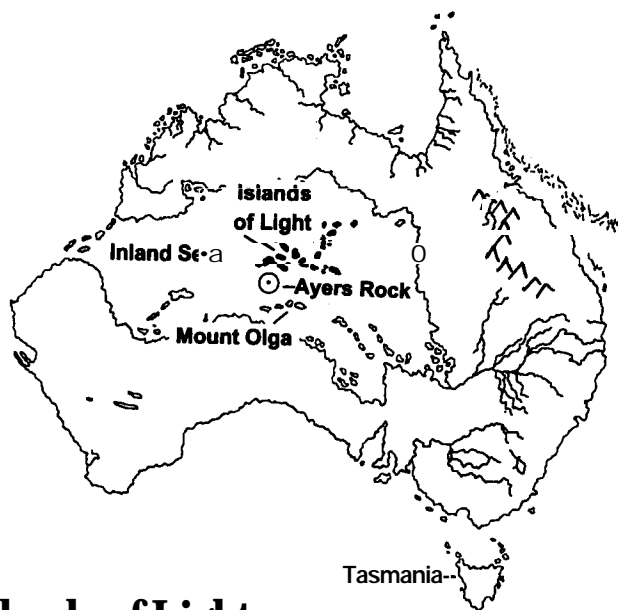

## Islands of Light

Where once the *MacDonnell Ranges* stood, there is now a chain of small islands and atolls universally referred to as one land mass, the **Islands of Light** or the Light Island Chain. The strange lights that radiate from these islands have given them their name, and because of them few dare to visit, believing demons and other supernatural horrors reside there. According to legends that have persisted for generations since the Apoca-

lyse, strange beings from another world or dimension are said to inhabit the islands.

Quite close to this island chain is the undersea point where the *Tikilik* rests, on the old ruins of the pre-Rifts town of *Alice Springs*. The *Tikilik* and the aliens who inhabit the Light Island Chain aren't aware of each other, but the myth surrounding the Islands of Light protects the *Tikilik* from being disturbed. Of course, when the demon awakens, the alien beings living on the islands will be the first to suffer. See the R.C.C. section for details on the *Visisari Aliens* that live on the islands.

The **Musgrave Islands** are the only other land masses to break the surface of the Inland Sea. They are several hundred miles to the south and are actually the peaks of the pre-Rifts Musgrave Mountain Range. Inquisitive visitors may find evidence of past civilizations and the occasional fisherman or wanderer on the Musgrave Islands, but the rocky mountain islands have only sparse vegetation, little arable land, and minimal wild life; mainly seals and birds who come to roost.

## Major Nexus Points & Other Landmarks

### Ayers Rock

Always a landmark and site of great significance, Ayers Rock was the largest single rock in the known, pre-Rifts world. It was once a symbol of Australia itself; solid, mysterious, savage and beautiful. To the Aborigines (who knew the rock as "**Uluru**"), it represented a powerful place of magic — a nexus point where many Songlines (ley lines) joined and intersected. Even though the rock was consumed by the Inland Sea, that part of the sea seethes with mystic energy and dimensional portals frequently "Rift" open to momentarily connect Australia to alien worlds and other dimensions.

The physical rock itself now rests at the bottom of the sea. Above it, a huge dead pool whirls endlessly as the nexus it sits under spews forth extra-dimensional life forms, most of which drown in the sea and sink the bottom. The flare from this nexus ends at the surface level of the sea, and this is where the true magic begins. The spirit of the rock itself, the natural P.P.E. it has absorbed over the centuries, has not moved. While the red sands are eroded below the waters, floating mere meters above the water is a huge ethereal form of the ancient rock, like an enormous ghost that refuses to move. In a final act of stubbornness, this vision remains a landmark that can be seen from the islands of the nearby Musgrave Ranges. **Note:** Some Aborigine elders and **Mabarn** claim that in their sleep, or during enlightened periods, they can "spirit travel" to the rock and scale her surface. From here, they can see all of Australia and the dreaming, and soak up the pure spirituality of the land. It is a very powerful **site**, and many workers of magic would give their teeth to discover the place and pay a visit.

### Mount Olga

Only about thirty miles (48 km) west of Ayers Rock is a place called Mount Olga, and a collection of beautiful rocks called the **Olgas**. This place has always been a powerful, spiritual location for the Aborigine people, and the nexus point that

has formed since the Coming of the Rifts is a very powerful one indeed. There is still a tribe living on what is now an island surrounding the old mountain peak, far out in the Inland Sea, because, despite the danger of the nexus, it is a very important Aboriginal site. The rocky formations in the area are strewn with rock paintings, and quite a few *Shadow People* reside there as well.

## Lake Eyre

Once a huge salt lake that was **Australia's** lowest point, it was the first place to be submerged by the new sea. It used to be that the lake would flood and then dry out with the seasons, but now it is no more than a deep trench in the Inland Sea. Coincidentally, a strong ley line cuts straight along the length of the lake, originating somewhere in the Flinders Ranges. This ley line has had a peculiar effect on the lake bed.

Being that the lake was a flooding point, like a hole in the side country where water could leak in, as it were, the magic of the dreaming has given the lake a darker duty. Now, despite being a sea bed, the lake continues its job as an access way, and functions as a giant dimensional **portal!** At select times of the year, portions of the lake tear open, like an ancient **wound**, and huge floods of magical energy from other dimensions bleed into the waters, bubbling up to be released in a dazzling aurora over the water's surface. While these streams of energy are open, it is possible to brave the torrent and travel to other worlds by pushing along through the energy flux to the dimensional Rifts on the sea bed. Only those equipped with specialized protective gear can do so — Dream Warriors can make the journey while traveling as light, **Techno-Wizards** could construct energy resistant, environmental suits, etc.

Some of these gates are anchored to parallel dimensions, including *Wormwood*, *Phase World*, *the Astral Plane* and *Chaos Earth* (the **Dreamstream™** from the *Nightbane RPG series* too, if the **G.M.** is so inclined). They can also lead to various parts **of/times** in Australian history, everything from the time directly before the Coming of the Rifts, to the first landing of white settlers, Aboriginal early history, and even to prehistoric times. Rumors also claim that the gates will sometimes open to the future. Of course, using these unpredictable gates is like taking potluck, as it is nearly impossible to determine where the magic will carry a person. The only hard and fast facts are that the "dimensional streams" open up for brief periods, only at night, during certain phases of the moon and planetary alignments. During the different months in the year, the location along the lake's huge length varies, presumably in conjunction with the destination of the gate. The event occurs **1D4** times per month, and the pattern repeats year in and year out.

## Three Sisters

In the *Blue Mountains*, a section of the Great Dividing Range in New South Wales, behind the inhabited ruins of OP Sydney, is a huge rock formation called the Three Sisters. The name comes from the three odd rocky prominences, like giant index fingers, pointing at the sky from a mountain ridge. These enormous rocks are often thought of as watching, forever silent and grim, over the country that surrounds them. Until only several decades ago, it was still popular for **Outbackers** to climb one of the Three Sisters for sport. The Aboriginals always knew better.

The Sisters are, in **fact**, the framework that supports quite a powerful Songline nexus point. The dimensional portals that open at this nexus form in two locations between the Sisters. They open only at various points in the year, on each full moon, on the summer and winter equinoxes, and at several other times of heightened magic energies. The magic of the sisters must be increasing, because in current times it is impossible to scale any of the three cliffs, unlike before, without either tripping a dimensional Rift or encountering something that slithered out of one.

These dimensional portals lead to various parts of Australia, so it is rumored. The Tribal people profess that because the Three Sisters are "guardians," and see everything around them, it is only natural that their portals lead to various points around the country. They further state that while the westernmost of the two dimensional gateways will take a being to any point in the country (i.e. other Australian nexus points), the easternmost portal leads to any point in the spirit world (*Astral Plane* and **Dreamstream™**) — a rumor that is hard to confirm or deny.

## Arnhem Land, Northland

**Arnhem Land** is the **pre-Rifts** Aboriginal title for the very large area of "reserve" land covering most of the remaining Northland. Since the Great Cataclysm, Arnhem, as it is simply referred to, has been deserted by humans for several reasons.

The first is a simple matter of geography. A lot of the countryside has been submerged, and what were once lowlands have become moist and humid mangrove forests and a delta of islands amid miles of swamps and marshes.

A second reason is that this area is the primary domain of the reptilian **Mokoloi**, who are extremely hostile toward humans. A quick scan of the area by the uninitiated is likely to leave them thinking that the green wetlands of Arnhem are devoid of humanoid life. Even the odd and magnificent spire or two that rises just above the **treelines** are likely to be unseen, because these Mokoloi structures are as much a part of the landscape as the trees and the rivers, and easily missed.

Away from the coast, the Arnhem becomes much drier, turning into rocky scrubland punctuated by extraordinary rock formations, waterways and flat yet savagely beautiful rock deserts. Every part of Arnhem Land was once sacred to the Aborigines, and still is. It is a highly spiritual land, rich in the Dreaming. The strongest tribes of all once lived here, but the Coming of the Rifts has changed the land and magic in the area, sending the Aborigines into the neighboring regions. The P.P.E. rich landscape has, however, attracted demons and creatures of darkness. It is a violent place, and except for the stout resistance of the Mokoloi, goes largely unchecked.

Dimensional Rifts open frequently, and because many of Australia's most powerful ley lines criss-cross the old reserve, Ley Line and Millennium Storms are frequent. The area has a wealth of magical crystals and may even contain an undiscovered fledgling Millennium Tree or two struggling to survive. But such things are a minor part of the dangers known to exist in Arnhem. The actual land itself is so soaked by magic that it radiates uncontrolled and unseen energy from its very surface. There is little reprieve from this harsh, alien radiation, and only supernatural creatures can survive there for long. In fact, the southern dry areas of Arnhem, a stretch of land 300 miles (482

km) wide and 450 miles (720 km) long, near the coast of the Inland Sea, has since been renamed "the **Bana-Land**" by the Aborigines. To the white community, it is known as the *Dead Zone* because to spend too much time in this place means physical (and magical) mutation or more likely, death. The deserts of the **Arnhem Land** probably hold thousands of fascinating secrets, but no one is likely to ever unearth most of them.

It could be said that Bana-Land is similar to the Black Strip that runs along the Great Reef, in that it is a concentration of mystic energy. The big difference is that while the Black Strip is concentrated evil, Bana-Land is like a sponge that has been over-saturated by magic and chaos.

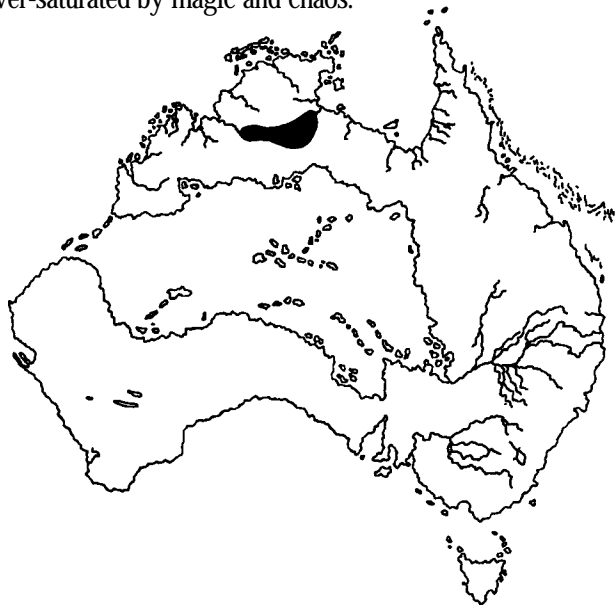

## The Radiation of Bana-Land (a.k.a. The Dead Zone in Arnhem)

The magical radiation of the southern Arnhem has a very strong effect on all who tread there. The first and most powerful effect is on magic users. The ambient P.P.E. is so great that there is an *effectively unlimited* amount to draw from! Spell casting is enabled with impunity because a mage can draw on SO P.P.E. per melee round or 200 P.P.E. every minute or so, rather than use his own precious supply! However, the physical cost is enormous and life threatening. To open one's self to the ambient magic energy is to face searing mystic energy and alien radiation. For every ten P.P.E. points drawn from the landscape, the magic user takes *one point of S.D.C./Hit Point damage*. Damage that can only be healed via magical means, and the magic is so intense that most mages tapping the Arnhem energy will find their bodies burnt and terribly injured from it. What is happening is that every time magic is used, it is supercharged and expelled with deadly force. These are energy levels and force that the human (and most D-Bees) **body** cannot withstand. Even seasoned magic users will suffer damage and usually leave the land injured and aching, frustrated that their spells were torn from them with such immense and aggressive force. Additionally, practitioners of magic, spell casting supernatural beings and creatures of magic will feel strong and empowered, casting magic spells and rituals as if they were one level higher than they really are. However, at the same time, these magical beings feel as though they are burning with fever to the point that steam may actually rise from their bodies (actually **it's** their bodies

burning off the oppressive ambient magic energy around them). This also leaves the spell casters dazed, confused and strangely unfocused in all actions not involving the use of magic (**Note:** The performance of skills is -20%, speed is reduced by 25%, and initiative is -2).

Mega-Damage creatures are less susceptible to this damage and are not so fragile that the radiation they are tapping will seriously damage their bodies. They suffer *one M.D.C. point* of damage per every 100 P.P.E. drawn from the environment and don't suffer fever penalties.

In all cases, whenever ambient magic energy is drawn upon, it sends a ripple through the entire Zone of magic. The greater the amount of energy used, the larger and more noticeable the ripple. Even human practitioners of magic can feel this and know the general direction from which it emanates. Meanwhile, supernatural beings and creature of magic will feel the ripple like a strong gust of wind, and have a clear impression from where it comes. Thus, they will feel each wave of energy from every spell or ritual cast that uses the ambient energy of the **Bana-land**. This also enables them to recognize magic combat being **waged**, gives them an impression of the level of power being **used**, and they can sense when and where a dimensional portal is opened. Unfortunately, entities (which abound in the Bana-Land) and other malicious supernatural menaces also feel these ripples and are drawn to them. **A negative impact on psychics.** The energy levels of the Bana-Land are such that psychics are overwhelmed. Within an **hour**, their heads will begin to ache and their psychic senses will be bombarded by unwanted sensations of power, magic, evil, fear and emotions. These sensations quickly make their nerves raw and their heads ache. The range and power of benign psychic sensitive powers (**telepathy**, **empathy**, **sense evil**, etc.) doubles the rush of sensations, and the overriding sensing of tremendous magical energy effectively short circuits their normal range of abilities. The use of psionic powers costs double the normal **I.S.P.** and hurts. Concentration is difficult (-30% to perform skills and -3 on initiative), and the only way to stop the pain and sensations is to keep a Mind Block in place at all times. This also negates the aforementioned penalties, but the psychic closes himself to psionic emanations and cannot use his **psi-powers**.

**Ordinary folk.** Meanwhile, beings who are not able to control their natural battery of P.P.E. (i.e. non-magic users/ordinary people) suffer even greater problems. They do not comprehend the forces at **work**, so the ambient energy touches their inner, latent psychic abilities in ways they don't understand. They can feel the magic and supernatural forces at work and even feel powerful ripples of energy, and it scares them. This results in paranoia, depression or frustration, and agitation. For every day that is spent on the **Bana-Lands**, non-magic using characters suffer 1D6 **S.D.C./Hit Point** damage and are increasingly jumpy, frightened, irritable and on edge — acts of violence, murder and suicide are common among those lost in the Bana-Land for more than a week or two.

**The Hidden City.** On the southeastern edge of Bana-Land, towards the Queensland border, on the tablelands, lays a dynamic rock formation called the Hidden City. Essentially, the rocky hills of the zone are high in metal content and hard rock laced through the softer sandstone. Erosion over time has caused the softer rock to disappear, leaving extraordinary formations

that break the otherwise **flat** landscape with long ridges of rocks that tower like strange, twisted buildings. Hence the name, "Hidden City."

This rocky desert is heavily populated by *Shadow People*. An enigmatic race of beings from another **world**, who live within the cracks and shadows of rock formations, and, in a sense, making the place an actual city of sorts. See the R.C.C. section for details about these creatures.



## The Outback & The People

Life in the Outback is rugged and difficult. Since the Great Cataclysm, the generations that followed have had to find their place in a world seemingly gone mad. A world that has been transformed into an alien landscape and invaded by inhuman creatures and demonic monsters. Lost on a continent that is isolated (probably for the better) from the rest of the planet. Some people have fallen to raiding and barbarism. Some have become nomads, others returned to agrarian ways, working the land and raising **livestock**, while still others try to rebuild some semblance of the democratic society of old Australia. Each is influenced, and often hardened or twisted, by the demands and hardships of the region they inhabit and menaces they face.

The structure, laws and exact type of governing body among Outback communities are typically loose and widely divergent.

More often than not, a town and even gangs will be based upon some sort of democratic system. As noted **elsewhere**, although there are a countless number of independent and often rival or competing towns, settlements, gangs, clans, bands, farms, ranches, outposts, gatherings, and groups, *all* consider themselves to be "Australian." It's just that without one central government to provide unity, direction, or bring order and enforce the old laws and ways of life, Australian society has fragmented and mutated. As a result, each of these communities generally tries to keep and enforce some notion of the old, **pre-Rifts** sense of democracy and their (often distorted) view of law, ethics, morals and customs — only each does so in its own way, and to widely varying degrees. Ironically, this diversity is often a bone of contention between communities ("Our way is the right way!" "No, our way is the right way!!") and another reason to squabble and stay apart. Many communities will trade and exchange gossip and information with one another, and treat each other with some degree of civility, however, cooperation is limited and each fiercely defends its own independence and autonomy. Different laws, ethics, ideals, philosophies and views on life (not to mention coveted resources, land ownership, de-



## The Outback

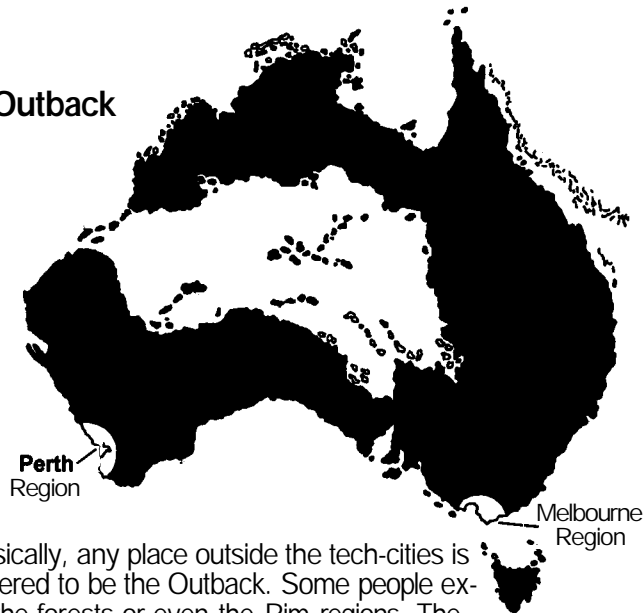

Basically, any place outside the tech-cities is considered to be the Outback. Some people exclude the forests or even the Rim regions. The densest populated areas are in and around the **two Tech-Cities** and The Rim.

**fenses**, and power) are all bones of contention, the source of squabbles and points of rivalry ("That's unfair! Your view is unreasonable, our way is better." "You say that only because it benefits you. Our way is better!" and so on).

Good, bad or indifferent, social or anti-social, sedentary or nomadic, some groups and communities are wild and lawless, others quiet and orderly, some brutal and extreme, others cooperative and reasonable, and everything in between. Each community will have a different set of priorities, needs, fears, purpose and place in the world (as they see it). Each does what it feels is appropriate to survive and rebuild some semblance, however twisted, of society. Although many of the old ways have been forgotten, altered, or under or over-emphasized, democracy and justice (albeit, sometimes warped and twisted) are two elements common to most wilderness communities and

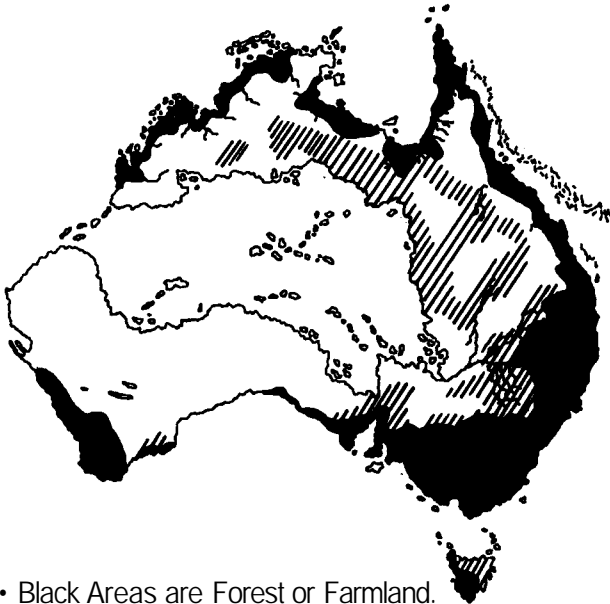

- Black Areas are Forest or Farmland.
- Lined Areas are **Grasslands/Scrub/Pasture** Land.
- White Areas are Nonproductive Land.

groups. Some hold open elections via secret ballot or the simple raising and counting of hands — most Outback people are sim-

ple, direct and informal. A typical community is held together by a single elected leader, like a mayor, or a small group of elected officials like a town council or council of elders. While the leader's decisions are not law, he or she is their main organizer and often chief justice who provides goals and directions and helps formalize decisions and organize operations that affect everybody in the town — such as the establishment of acceptable laws, a system of **justice**, law enforcement, civil defenses, building new sites, expanding land, arranging trade agreements and so on. "The law" is usually maintained by a Sheriff, like in the frontier towns of old Australia or the American West. Civil defense is typically headed by the Sheriff and his deputies, who lead a volunteer militia of citizens. This militia is only called upon in defense of the community and to help the Sheriff in times of need. The largest and most strict towns will often have a formal militaristic force that serves as a police force, as well as a strong militia **and/or** small standing army, but these are a rarity. There are some military-style **survivalist** towns that, conversely, create total discipline by running their community like a boot camp, complete with training and constant drills, but even **here**, the leader or leaders are usually trusted, elected commanders.

If there is a "definitive" organization within any Outback community, it is the family unit. Most people are loyal to their families first and community second, a sentiment that most everyone respects and is sometimes considered part of the unspoken Code of the Outback. Sometimes a small community will consider every citizen to be a family member, and in some case, each citizen *is* a family member (brothers, sisters, uncles, cousins, etc.). Among larger collectives, there are often powerful family clans who possess varying degrees of power and influence over their community — sometimes over several in the region. Such family clans may have undue influence and control over the leadership, law, defenses and business aspects of a place to the point that they are effectively kings and royalty under the guise of democracy; meaning there are votes, but the family's influence is so great that it is a given that their family members or choice for elected officials will win. Whether such powerful families work toward the greater good of the people and community or function as land barons or tyrants depends entirely on the alignment and temperament of the clan leaders — the heads of the family and its most **influential** family members.

The typical social breakdown of the average wilderness community, large and small, is as follows:

- 1-2% **Leaders/advisers/elected** officials
- 10% Professionals: **doctors**, teachers, mechanics, etc.
- 15% **Defenders/militia/warriors/law** officers
- 73-74% Hardworking citizens

**Note:** There is seldom such a thing as a useless member of an Outback community — everybody pulls their weight. Even drifters, drunks and vagabonds are expected to help around town and stay out of trouble.

## Everyday Life for an Outbacker

A typical day in the life of an Outbacker is hard to define, as there are so many thousands of roles to fill and so many jobs to do. Spare time and leisure are rare and have become treasured things that are reserved for special tunes, and usually involve

the greater part of the community gathering together in celebration and festival. The old farm-life adage of "late to bed and early to rise" has never been truer, and the days are filled with **work**, work and more work. Farming, building, hunting, patrolling, making repairs, negotiating trade (or to avoid trouble) with wanderers, and more, are all part of the day to day routine. Laziness is viewed with disdain, and freeloaders are not tolerated and either driven from **town/exiled**, or left to languish without help or remorse from the rest of the community. Resources are scarce enough without an extra mouth demanding food for nothing in return. This is not to say that the elderly, sick or infirm are discarded, quite the contrary. Hardworking family members and citizens who, when healthy, have struggled to preserve **their** families and contributed to society are usually well cared for. Many incapacitated people continue to (at least try to) contribute in whatever small ways they can, from needlework to teaching or offering advice and counsel.



The Rim — The inhabited region of Australia and the most arable land.

Wilderness communities that are doing well execute **their** daily chores like a well-oiled machine. Everyone goes to **their** place and performs their duty without being cajoled or told to do so, and fully expect others to do the same. And most do, for it is a matter of survival that everybody pulls their weight. Water distribution, the use of power/generators, fuel, food conservation, the distribution of weapons and armor, sharing vehicles, and so on, are all decided upon based on the type of work, position of the individual, and needs of the greater community. Decisions and allotments are usually made by the elected **official(s)**. Oh sure, there are heated arguments over who should get what, and who is doing more work than others, but these are solved quickly and fairly, with the community **leader(s)** adjudicating, or resolved at the next election. As a democracy, the majority rules and wins, so there may always be some disgruntled individuals or clans. One cannot satisfy everybody. However, even these discontents usually work hard for themselves and strongly support their community, for without that effort and the support of their neighbors, they are likely to perish.

In the larger towns, organization is slightly more bureaucratic. Councils take care of different areas within the town, and a single leader (mayor, governor, magistrate) is voted in after a

mandate. If the town is large enough, some areas of work may become more specialized. Mechanics could be divided up into automotive and aeronautic unions, guilds or clans; for instance, medicine may be divided up into fields of specialty like midwife, general practitioner (M.D.), surgeon and veterinary medicine (the latter being as important as "people doctors"). Smaller communities don't have this luxury and may have only one individual who is a **doctor**, mechanic, etc., to none at all in some areas. Unions or guilds are usually formed only around businesses that employ a large number of workers, like farming, building, defense and trade.

The largest towns — often rambling shanty towns — are likely to offer a large array of businesses, resources, trade and opportunities complete with houses of pleasure, taverns, gambling dens, hotels, boarding houses, restaurants, theaters or dance halls, mechanics garages, repair shops, doctors or healers, fences, traders, and numerous stores.

## Isolation

The isolation of these people is extreme. Australia itself is cut off from the rest of the world, and many of the wilderness communities and road people are isolated even from each other. Except for Roadgangers, bandits, nomads, adventurers and explorers, few people ever travel far from their homes. They are totally alone, which is why, for the people back of beyond, tomorrow never seems to come. Many live every moment like it is **their last**, with little fear or regret. Despite this, most cling to life with amazing tenacity and are surprisingly cheerful and optimistic.

## The Problem with Resources

The Apocalypse destroyed a lot of the produce that Australia could yield. The loss of land area from increased deserts and the appearance of the massive Inland Sea, compounded with the loss of many technological resources (horticulture, irrigation machinery, mining equipment, manufacturing in general, fuel, etc.) meant that less food could be produced per square mile. The tragically reduced population also lessened the strain on the **environment**, but trying to find enough to live on in Rifts Australia is a constant **struggle**.

The **closed**, modern cities of Perth and Melbourne live in comparative luxury and benefit from old, **pre-Rifts** technology, which **in** turn gives them access to greater resources — if nothing else, they have the power to take just about anything they want. Considering they make up roughly 20% of the Australian population, and they draw approximately 40% of the country-wide **resources**, they are an obscene drain on the environment that nobody else has the power to slow down. On the other hand, the Aborigines, making up nearly half the population, draw on approximately 20% of the annual yield, making them very economical and capable of expansion. As always, the **Outbackers** sit in the middle ground. While their numbers are roughly equal to the city populations (a little bit more), altogether they draw on maybe 20-25% of Australia's overall resources. One bad crop can destroy an entire town, and one good crop can make it wealthy enough to stockpile or trade, for at least another year or two.

The real problem with resources and the teeter-totter balance the Outbackers have to maintain, is the lack of trade and inter-cooperation. Even though the post-Apocalypse dark age is

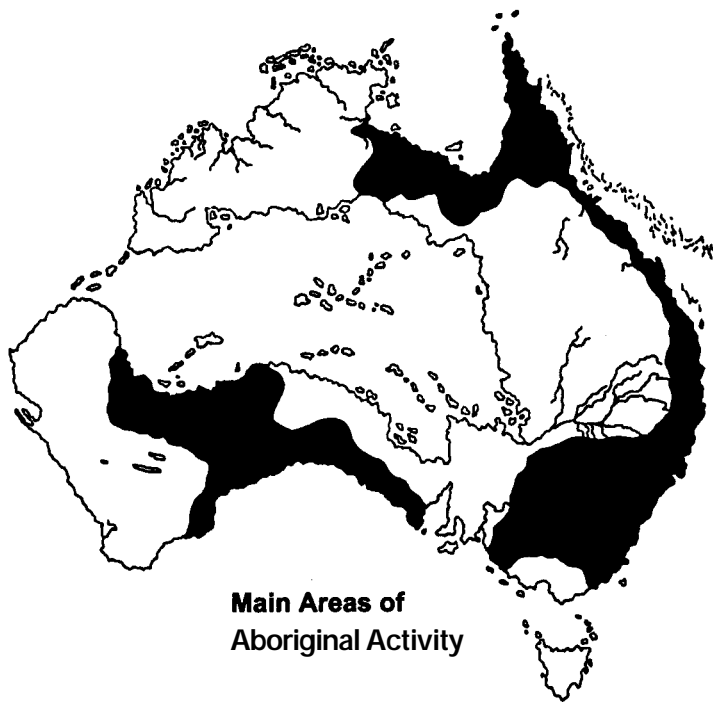

ending, people are still caught in the mind-set of hoarding what they can while they can get it, and fiercely defending their independence. Sharing and trading is a difficult thing to establish because nobody wants to part with anything, or compromise their beliefs or change their way of life.

## Technology Levels

The technology level of the Outback has not improved since the darkest days of the Apocalypse. In fact, it has decreased. Robotics, cybernetics, advanced computer systems, combat drugs, and other wonders have all but sunk into the battered and parched earth. M.D.C. technology is rare and treasured. Old style S.D.C. firearms and armor are all that most wilderness communities can manufacture, although most have become incredibly skilled at scavenging, repairing and jury-rigging armor, parts and vehicles as needed. Virtually all higher, M.D.C. levels of arms and armaments must be scavenged or stolen from either of the two tech-cities.

Combustion engines are the most common source of power, along with solar battery cells. Outback computers are very basic, personal level affairs, while mainframes and large machines, robots and artificial intelligences have faded away except in the two advanced cities. Where possible, magic has taken over for technology in terms of communication, though nothing will ever truly replace the old satellites or optic fibre relays. On the domestic front, the most common source of power is still the humble, naked flame.

In many places, day to day life has been reduced to old-fashioned means in a strange, jury-rigged adaptation of the ancient and the modern. A television set is now no more than a box that may be good for a fireplace or storage bin. Components from powerless old robots or vehicles may be used as parts to construct other useful items, from plows and paperweights to armor, weapons and vehicles components. People entertain themselves with sports and live theater, they work their fields with livestock and cook their food over an open fire. Yet mixed into this simpler way of life are reminders of what humanity had once achieved — the twisted wreck of a helicopter scavenged to become the walls of a shelter or home, its propellers a plow

blade. The hubcaps and tires of an old car become part of in a homespun suit of armor. Working pre-Rifts devices like generators, batteries, light bulbs, flashlights, rebuilt engines and vehicles, old M.D.C. body armor, M.D. guns, and many other machines and items are vital to the lives of the surviving people.

## The Code of the Outback

There is no "official" code of the Outbacker or for living in the Outback, but there are some unspoken laws that most everybody lives by, whether they do so consciously or not.

**Conservation of Resources.** Conservation of resources is perhaps the most important thing to remember. This means washing with salt water (if near the sea) or sand baths to save water, no wasting of food or fresh water, no wasting of fuel or ammunition. Kill animals only for food and other important needs — use the entire animal, from meat and hide to teeth, claws, horns and bone. Avoid obliterating houses, vehicles, and machines. Capture, salvage and reuse.

**Preserve the land.** Do not spoil drinking water or destroy precious forests, farms or grazing lands out of spite, anger or revenge.

**Respect the land.** It is a living, changing beast that is both hard and beautiful, a life giver and a destroyer. Know it. Respect it. And walk carefully. Only a fool lives in a place he doesn't understand.

**Exercise Caution.** This goes hand in hand with respecting the land and the two are sometimes combined. It is also the most simple, broadest and important of all things to remember, and is really just common sense: Do *NOT* go off into the wilderness alone. Do not hunt alone, don't drink and wander off, and don't investigate strange sounds or occurrences in the wild without a scouting party and community approval. Magic has added an extra danger and dimension to the land, which was already dangerous enough.

Caution is also applicable in all aspects of life. Exposure to unnecessary risk and recklessness is simply a waste of medical supplies on a foolish and costly life. Everyone in the Outback understands when the weather looks bad to take shelter. When a patch of trees looks like a place for an ambush, go around them. When smoke is in the air, something is burning. When the whirl and rattle in the distance signals the approach of City 'Choppers, take cover. Never, ever put your boots on without looking for nasties in them first, and beware the smiling stranger.

**Fire is dangerous.** Perhaps one of the most underestimated, but most important, "cautions" involves fire: No sparks, no unattended naked flames, no mirrors or unshielded rifle scopes, no fire attacks, no burning out one's enemy, etc. **Bushfires** can wipe out entire communities and sometimes sweep over and destroy entire regions, so fire is used with the utmost care and caution.

**Rely on your Mates.** Isolation and paranoia is one thing. Solitude is **death!** To traverse the haunted wilderness alone is to flirt with death. Even the Aborigine, who is known to walk alone, would rather travel among friends and family.

People in the Back of Beyond understand the virtue of friendship and the necessity of working together. Thus, even the biggest, meanest, toughest **Outbackers** and warriors have friends they can count on. True friendship and a man's word are valued

above all else. As one saying goes, "If a man cannot be trusted, he is as dangerous as the crocodile, and like the snaggle toothed croc, is to be feared and shunned by men." Truer words were never spoken, for even bandits and Roadgangers have mates ("friends") they know they can trust. People they can turn to in times of desperation and need. Allies they can trust and confide in. Comrades who will stand at their side even in the face of death. Most wilderness folk will take a bullet before turning on friends (and often family).

Those branded as traitorous souls who can not be trusted, and/or are known to have cheated, betrayed or killed a friend(s), are treated like scurrilous lepers — pariahs to be hated, feared and shunned, and seldom trusted ever again. It is a brand that marks them forever and follows them wherever they go, for there is nothing lower than betraying a friend. Such despicable misanthropes must make their way alone in the world, for all who know of their foul deed will have nothing to do with them and turn a cold back to them. Furthermore, the betrayer suffers the acid barbs of contempt, hatred, spits, and cruelty. For he must survive in a hostile and brutal world alone and lonely, with

no trusted friend to watch his back, lend a hand, or spare a kind word. He is like a lame animal alone in the wilderness, an obvious target and easy prey for other predators and wicked beings. The kiss of death. The few such loathsome people who survive hated and alone (and there are some villains who thrive on such adversity) are generally regarded as the most powerful, wicked and dangerous people in the Outback, and feared and avoided.

Within a community, the stronger the sense of unity, the more resources it can rope in, and the more authority it can command. If everyone pulls their weight and watches out for each other, the better its odds for survival and growth. In many communities, somebody who shows laziness or a reluctance to "do his share" will be exiled. There is no room for freeloaders.

**Fear.** Only a fool or madman never knows fear. There is no shame in feeling fear, only in how one responds to it. The courageous man recognizes and learns to control his fears, the coward lets fear control him.

**Life.** Life is hard. Life is short. Live it well, with integrity and courage.



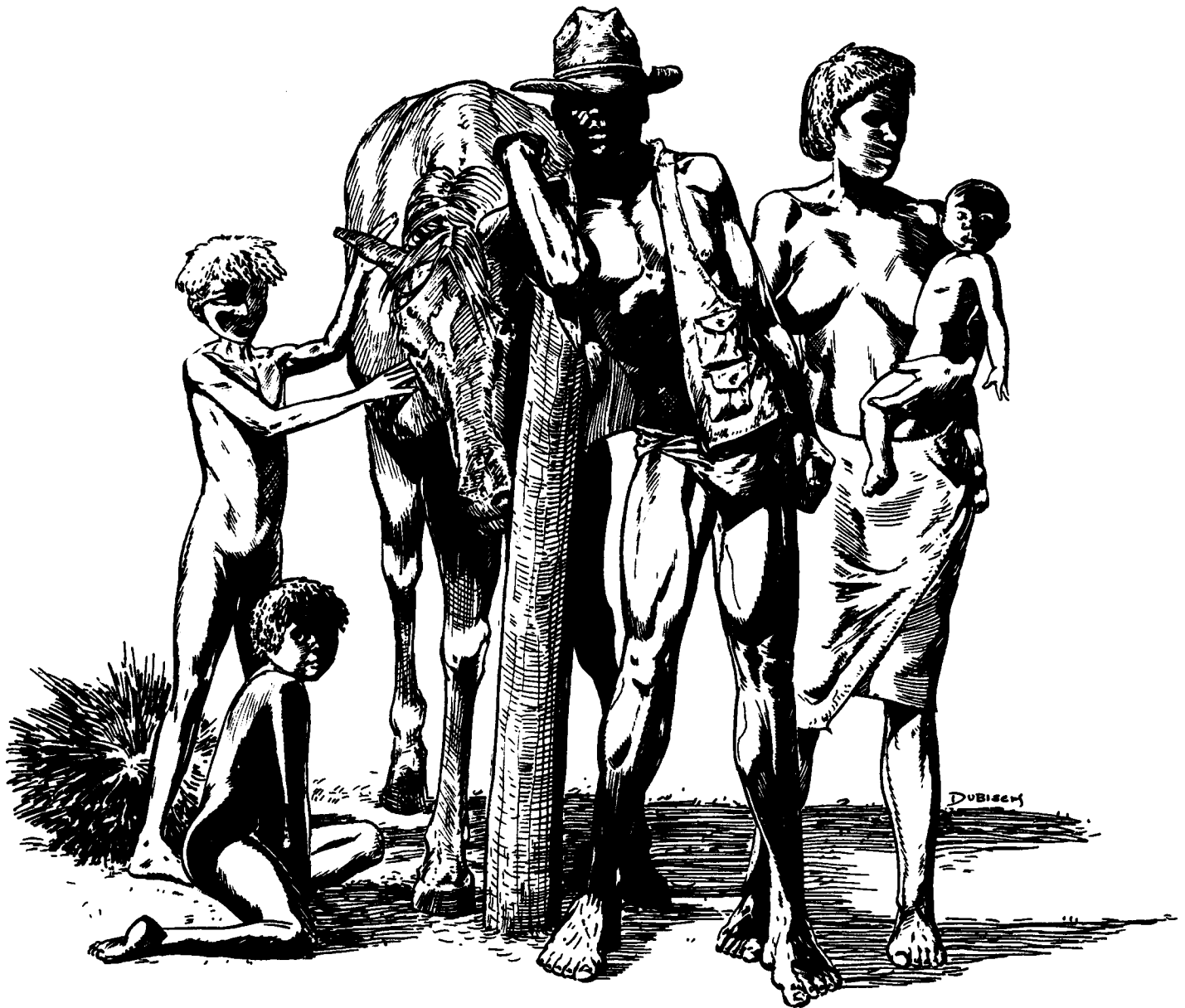

# Creating Outback Communities

By Ben Lucas & Kevin Siembieda

There are so many different wilderness communities tucked away in the Outback that it would be impossible to categorize every one. As a rule, they are usually far between one another, but there are sometimes clusters of **them**, especially around Perth and Melbourne. As noted earlier, some are merely extended family units, some are old **stations** out on the plains that have become desert villages, some are peaceful fishing villages or farmsteads, and some are militaristic **survivalist** camps complete with bomb shelters and machinegun nests. Each has a unique setup, with its own system of **government**, administration and unique selection of facilities and resources, strengths and weaknesses. If the G.M. intends to feature such communities strongly in his campaign, he should probably make up a few notable places as landmarks for the players to get their bearings on.

To help set the foundation for such locales, and to make it possible to make up settlements on the fly, we provide the following creation rules, considerations and procedures. Specific, fleshed out communities may digress from the places that can be created as follows and are likely to have greater personality and adventure threads.

Making up communities can be a lengthy process, but also lots of fun, and makes great background for a long-running campaign. The following process is based on *Erick Wujcik's system* from **Ninjas and Superspies**, also reproduced in **Vampire Kingdoms™**, **Rifts® Mercenaries™** and other places. Simply, each different type of community is assigned a certain amount of points to spend on the following categories of their overall make-up. The G.M. decides what type of community he wishes to create, then spends those points on the categories to build up an overall settlement. Most "features" can only be purchased once from each category, unless it specifically **mentions** otherwise.

**Note on Equipment:** Player Characters begin with standard starting equipment. The lists given with O.C.C. descriptions are left intentionally open, so the equipment of the characters' community may alter this. If the character starts with a firearm and

comes from a settlement where they have none, then he has the *only* one and would have a hard time getting ammo. If the settlement is rich in equipment, then this broadens the range of equipment the G.M. may allow players to start with.

## Step One: Orientation & Disposition

The general orientation and disposition or outlook of a town is reflective of the pervasive attitude of the residents and current leaders/governing powers. While most people ascribe to these sentiments, there will always be some who don't. **Note:** There is *no* point cost in the selection of *one* of these categories. The overall alignment of a community will also help to define and fine tune the general attitudes, behavior and the people's response to outsiders and trouble. Pick one or roll 1D6 for random determination.

**1. Survival Instinct & Isolationists.** All survival instinct communities are focused on (sometimes obsessed with) the importance of "continuation" and survival. They realize that in order to see the next day, hard work and cooperation within their community is required. Most are usually "closed" communities, meaning they have only a passing interest in the affairs of places outside their town and no interest in the affairs outside the general region they inhabit. This means they generally view outsiders as potential trouble and do little to encourage them to revisit or join them.

These communities are fairly peaceful, although they brook no threats and will respond to intruders and invaders with ruthless force. That having been said, few will start a war or any conflict, unless they think they can surely win, or they are power-hungry or insane. Likewise, most are happy with chasing a threat away rather than destroying it. Destruction is what has put them in their predicament, and more destruction is not going to get them far. This is a time for rebuilding and they just want to be left alone to go about their business.

Unfortunately, these independent, self-reliant and head-strong communities rarely get along with other communities. They are suspicious of others, tend to see everybody as a competitor or thief, and it is second nature for them to look out for Number One, themselves. Consequently, they tend to be rude to outsiders, stockpile and hoard valuables, food and resources, and refuse to share or trade much with others, even when they have incredible excesses. This can lead to disharmony **and/or** rivalry and feuding with other settlements, especially when they are particularly close to each other. However, such skirmishes, though vocal and nasty, seldom result in much bloodshed. Any physical violence is usually stopped by the first death or the first waste or loss of a valuable resource (e.g. the contents of a fuel truck leaks away or is blown up, and so on). Instead, feuding is typically limited to one-upmanship, name calling, slander, dirty tricks, robbery, blackmail, secret deals, and squabbling. These communities may be thought of as friendly-enemies or not so friendly **rivals**, but each, in their own way, respects and values the other, and refrains from destroying or subjugating other people.

The futility of their mutual situation usually brings about negotiations and some measure of trade, cooperation and peace, at least until the next dispute. Such peace and cooperation is al-

ways tenuous at best, and short-lived. The bottom line is always survival, the most important factor in the community, thus, every action they take, every negotiation they make, and every bridge they cross will be under one premise — will this help us survive better or longer?

**2. Tight Bonds and/or Strong Family Ties.** As the term "community" implies, the people of this town or settlement are unified, close-knit and likely to be based around one or more family clans. They take poorly to strangers, and will always back each other up before they trust or believe an outsider. The appearance of strangers often means more mouths to feed, more wounds to dress, and more machines to repair, and are all unwelcome unless the strangers can somehow benefit the community. Consequently, visitors will only enjoy hospitality if they can offer something of value in return. This isn't quite as harsh as it may sound, because current news, juicy stories or gossip, and simple things like candy, processed food, booze, silks and other fabrics, magical healing, **and/or** a willingness to help the community (from digging ditches and hard labor to defending it against monsters, raiders or other dangers) are all welcomed and "**valuable.**" In fact, visitors who endear themselves to such a tight-knit community are likely to make friends for life!

Likewise, such communal places are likely to have strong, friendly relations with their neighboring communities, welcoming those willing to share and work together. Such bonds include each of the friendly towns coming to the other's aid whenever possible, and helping one another in any reasonable way.

**3. Hostile and Aggressive.** This is usually a rough and tumble wilderness settlement, or a very orderly and law abiding town who refuses to take crap from anybody. Fiercely independent and unified, its citizens, as well as its defenders, are willing to fight at the slightest hint of danger, blackmail or trouble. Their world is a volatile and dangerous one and they've adapted to it by being quick to respond to potential violence. Virtually every household and business, if not every adult, has a weapon (often concealed) that is quickly available to him. These people are not killers, brutes or savages, they just don't tolerate trouble from outsiders. They, themselves, live by very strict rules, laws and codes of conduct that they expect others to respect and abide by.

This is the type of place where a Sheriff will approach a group of rowdy and rambunctious adventurers or a group that has just cheated at gambling or is suspected of trouble, and tell them that they are welcome to finish eating their meals, but then need to gather their gear and their buddies and get the hell out of town. The slightest hint that they are not taking the Sheriff seriously or that they will not heed his words ("Sorry law man, but we got some business to do ..." or "... some women to meet," or "We don't mean no trouble, we'll just stay a few days and leave," and similar) will incite the Sheriff to drive home the point, usually with him knocking the fella off his feet and leveling a nasty, heavy-duty, M.D. weapon at his head. Meanwhile, the bartender, **cook**, probably several patrons, and as many as a dozen Deputies or militia men (not noticed a moment before) will have the group surrounded with weapons drawn and ready for battle. The Sheriff will then repeat his position and ask the "boys" (the adventurer group/strangers) if they have a problem with his request. A polite response and renewed willingness to

comply will get them out of trouble. Any other response will cause all hell to break loose.

Lawbreakers, abusive and pushy roughnecks, and desperadoes on the run are dealt with swiftly. Justice is usually fair, but swift and harsh at such communities. Mercy and trust is not given easily nor freely.

These people aren't mean, bad, or want to do battle, but they are so hardened and distrusting that they don't take chances. They've learned that all too often, might makes right, and that the only thing people understand is the barrel of a gun, so they don't fool around with polite conversation, veiled threats, or negotiations, instead they get straight down to business. Do things **their** way or take the highway. Even when his whole world is limited to a few vehicles, his house, farm, a handful of possessions, and his family, one is likely to find himself fighting to the last breath to keep and protect it. **Note:** Many militaristic communities follow military style protocol and structure.

**4. Easy Going and Passive:** Tend to take everything in their stride and look for the path of least resistance. This means they tend to deal with anybody and bow (and scrape?) to those stronger and more frightening than they. This also means, they tend to have no strong loyalties and will sell out others to save **their** own necks. However, some communities, while passive and subservient, will avoid betraying friends and neighbors by simply playing dumb, pleading ignorance or through subtle and quiet defiance (do everything asked of them except betraying a friend, ally or family member even under the threat of death).

**5. Open and friendly!** These people have a very positive and open outlook on life, whether it be born from faith, prosperity or idealism. Most members of the community welcome new ideas and spontaneity, and encourage self-expression. They are also most apt to accept D-Bees and strangers until they prove themselves untrustworthy. Justice is usually fair and even-handed, tempered with compassion, however, its execution can be slow and ponderous. While these people may be open-minded and friendly, even trusting, they are *not* stupid, guileless fools, and recognize and respond to danger, treachery and evil.

**6. Open but Cautious.** These people welcome trade and travelers and are fairly amicable, but a bit cool, wary and cautious of strangers. They are a pragmatic group with practical sensibilities and attitudes. They can be fun and peaceful but respond to trouble quickly and aggressively. Sort of a middle road between #3 and #5.

**7. Rigid and Orderly.** The people in this community have a time and place for everything, and everything runs like a well oiled machine, at least it's supposed to. They abhor anarchy and disorderly conduct and most obey the letter of the (local) law. Such communities tend to be self-righteous, rigid and closed minded. They are perfectly happy with the way things are, and do not welcome new ideas, change, disruption or challenges to their way of life or thinking. Spontaneity and free thought aren't dead, they just aren't particularly appreciated or encouraged. Outsiders are seen as potentially disruptive and corrupting forces best kept at a distance. Troublemakers and rabble-rousers (which can include idealists and people with contrary views) are treated harshly, and justice is often strict, unforgiving and with little room for compassion.

## Step Two: General Type & Size of Community

Pick one or make a random roll using 2D4. The type and size indicates the amount of points available to the community. **Note,** however, that a community does not need to spend all the available points, although once the town is built, any extra points are abandoned and gone forever. Furthermore, a town can go over its point allotment by as much as 10%, provided the G.M. feels it is appropriate and okay with him.

### 1. Small Shanty Town

These are the small, struggling communities that are rarely heard of, and never missed if they are destroyed. There are thousands of ramshackle communities like this, dotting the coasts and **bushlands**, and even the deserts. They are perhaps the friendliest of all settlement **types**, mainly because they rarely have the power to adequately defend themselves, or threaten or dominate others, and therefore seek peace with any newcomer. They have enough problems to deal with without making trouble. Generally, there are **3D6x10** people living in a Shanty Town.

Points: 105, but weapons and vehicles can go no higher than level 4.

### 2. Family Commune

Such a place is even smaller than a Shanty Town, and usually destined to fail. Either a single extended family has decided to make it on its own, or a collection of **survivalists** or naturalists have taken it upon themselves to fragment away from a larger group to build their own community and make a fresh start. These are quite common in northern N.S.W., but less common in the harsher areas of the north or the inland deserts. Sometimes communities like these flourish and become much larger towns, but most simply fade away without a trace due to lack of skill diversity, power and resources.

Such a settlement is typically very small, rarely larger than 6D6x2 members.

Points: Very few, 70. Spend wisely.

### 3. Advanced Village

When a shanty town finds a resource like an oil well, magical node, or a raw **material/resource** (like water) to trade with either the two **tech-Cities** or other communities, it begins to expand and becomes more than the village it once was. Professional people and traders are attracted, as are people looking for a place to raise a family. The greater the size and population the more large buildings and businesses are constructed. Such a place will have at least a few vehicles, in addition to a few horses or other riding and work animals, at least **1D4+1** professional **personnel/businesses** such as a doctor, mechanic, tanner, butcher, tailor, etc., and are also likely to have a small weapons cache for defending the village.

A typical up-and-coming village will have 3D6x10+60 people in its ranks, but some have over 500 people.

Points: 140, but sufficient points must be spent on adequate *Water and Food Features*.

## 4. Gang or Clan Collective

The Gangs of the Outlands are usually nomadic, but when they get big enough, they start to form outposts or trading posts. Like marching armies, they start off as temporary base camps, but slowly build up to become permanent outposts. Sometimes a settlement like this will expand to become a village or town, but they are never hospitable. They are always built with blood, and are violent and aggressive places where only the violent and the aggressive survive. Prize fights, booze, busted cars and general mistrust and hostility will greet outsiders who visit a place like this. To those who live inside a Roadgang Collective, it's a day to day struggle to get what you need.

Gangs vary dramatically in numbers — anything from a dozen to three hundred may fill a community such as this. Some gang compounds grow to the size of small armies and include wives, families and relatives; the entire population can range from 400-1600 individuals. Large or small, most are typically lawless, chaotic places, and dangerous in the extreme. There are even rumors of **Outland** gangs of cannibals, but many agree (or hope) that such rumors are a myth.

Points: Varies, usually anywhere between 60 and 180; roll **3D4x10+60**. *Administration, Medicine* and *Trade Features* are all capped at level 3.

## 5. Typical Outback Town

While it is unfair to say the majority of Outback towns and settlements will be like this, it is fair to say that everyone strives to reach this happy middle ground. The people are a balance of general **workers/laborers** and skilled professionals. The housing is reasonable, equipment may be shabby but functional, supplies are adequate if not plentiful, and there is enough infrastructure, leadership, laws, communal unity and weapons to keep the place strong and going. Everyone, even **Roadgangers** and outlaws, wants to live here, but as the saying goes, "You have to be harsh to be kind," and communities like these seldom accept newcomers unless they are able to contribute to the community as a productive, law abiding citizen.

The average populations of these towns and settlements usually hover around the 300-1,200 mark, although sometimes they will be as large as 2,000 to 8,000, rarely larger.

Points: A typical Outback town will have 220 points to spend.

## 6. Militaristic Encampment

When the Apocalypse came, there were enough **survivalist** nuts and ruthless extremists to build small armies. Likewise, military personnel who saw military structure and discipline as the way to survive established military-style camps, armies and communities. A Militaristic Encampment is a community usually established under military structure and conduct, with the general attitude and understanding that, "**We've**got guns, we've got food, we've got discipline, and we don't need much of anything more. Mess with us and get stomped."

Militaristic towns operate very similar to a mercenary company, except they are not usually for hire. This is an organized fighting unit, sometimes quite large, that intends to outlive the cockroaches. And so long as they hold the gun monopoly and keep their fighting spirit, they feel strong and confident. Yet be-

low the guns and bluster, they are men and women looking for a way to survive and raise a family. They simply see the military approach and discipline as the best way to go for them.

The size of a militaristic settlement can be as small as a platoon or company (**40-160** people) to the size of a battalion to a division (640 to 5000); **most** fall into the 400-1500 range.

Points: Again, the G.M. can decide the exact size, typically from **3D6x10** is a good number, but some can be two or three times smaller or larger. The G.M. will also have to make sure that sufficient points are spent on *Administration, Weapons and Armor, Water* and *Security*.

## 7. Major Town

These places are rare, and are usually talked about by name. They tend to crop up near resources (fresh water, natural gas, petroleum field, arable **land/farms**, cattle grazing land, operational power plant **and/or** factory/manufacturing, and so on), or where traffic and trade is high. A town this size has thousands of people, and enough professional personnel, business people, traders, and leadership that they can afford to have a standing army, supplemental militia **and/or** police force, and white collar jobs that would be otherwise impractical most anywhere else in the wilderness. They have enough fuel to power their vehicles and enough water to maybe even have plumbing (though this is rare). Some may even have old generators, rebuilt hydro-electric plants, **geothermal** power plants or other means of generating electricity and power.

Such a place usually holds about 3000-12,000 people, but can have as many as 20,000-60,000! They may be considered a city and a major threat to other communities. **Worse, they** won't escape the notice of Perth and Melbourne, especially if within a few hundred miles of those cities, and may be worrisome to them.

Points: Many, at least 280, with as many as 350 if the G.M. sees **fit**.

## 8. Reef Island Community or Advanced Civilization

The islands of the Great Reef and rare advanced Outback settlements are home to many communities that are difficult to classify as Outbackers. Communities like these tend to be small affairs, with strong leadership. They are well organized and have a good, positive atmosphere that reflects in their day to day business. Fishing or farming, making tools, building, community maintenance, education (33% will be literate; +10%), and so on, are all jobs and duties allocated amongst the citizenry, based on their skill levels and background. The whole society usually runs smoothly and is comparatively progressive. The Great Millennium Reef, in particular, tends to attract a certain class of people that forge successful, peaceful settlements, and as such, is seen as a paradise by many inland people — a place they dream of living in, but have never visited. Once every other year, the members of at least one failed Outbacker community will emerge from the bushlands, having made a pilgrimage to the coastline in the hope of moving out onto the Reef.

Points: A typical Reef Island Community or similarly progressive (and rare) Outback community will have between 150 to 210 points to spend, depending on the size the Game Master



has in mind. There are several required levels to make a paradise such as this, however. At the least, *Real Estate* must be purchased at level 3, *Threats* must be purchased to level 2, *Magic* at level 2, *Alignment* at level 4, *Administration* at level 2 and *Vehicles* at level 3.

## Step Three: The Attributes & Features of an Outback & Community

Note: The points presented for Outback Communities are NOT compatible with those presented for building a Mercenary Company in *Rifts® Mercenaries* or making a travelling show or community in *Rifts® Vampire Kingdoms®*. The Australian communities have different values, different categories, etc.

### A. Weapons and Armor

Every community should be armed if it expects to survive. However, advanced, M.D. weaponry necessary to fight supernatural menaces and alien monsters is difficult to obtain, and most communities covet anything they can find.

1. **None.** The community is weaponless. The best they can muster is a collection of clubs, makeshift spears, and maybe some other improvised items they could pick up and defend themselves with in a hurry. One individual may possess an automatic firearm or even a light M.D. weapon acquired through scavenging or trade. Ammunition is another story; probably no more than an extra few rounds. No one in the settlement has the ability or aptitude to construct even basic modern weapons, including the bow and arrow. Such a place is very vulnerable.  
Cost: None.

2. **Limited.** A blacksmith or other skilled individual can construct arrowheads and metal S.D.C. weapons like knives, swords, maces, etc. They can't make firearms, but have a respectable selection of primitive S.D.C. melee weapons. They are also likely to have scavenged or traded for 2D4 modern S.D.C. guns and a box (144 rounds) of ammunition. There is also the possibility of having 1D4 light M.D. weapons each with 1D4 extra E-Clips, but that's it. Only a handful of militia men or defenders will have light, make-shift M.D. body armor. Cost: 5 points.

3. **Good.** Crossbows, bows, spears and machetes are the most common weapons and 1D4x10% of the people in the community have S.D.C. guns — mostly rifles and revolvers; bullets are plentiful and possibly even made in town. One or two dozen M.D. weapons, mostly energy rifles or grenade launchers (nothing heavy like a cannon or rail gun), are also part of the community's defenses; each weapon will have 2D4 extra E-clips with recharging and additional or replacement E-clips available through expensive trade with outsiders. Most M.D. weapons will belong to members of the militia, law officers and/or prominent members of the town. All militia men and law officers have light to medium, homemade M.D.C. body armor. A few might even have environmental body armor. Likewise, a few regular citizens (retired Outbacker, ex-mercenary or prominent town member) may have light, homespun M.D.C. armor. Cost: 10 points.

4. **Firearms.** 1D4x10%+20% of the people in the community have S.D.C. guns — mostly rifles, shotguns, automatic weapons



and even (light M.D. or heavy S.D.C.) grenade launching rifles. Bullets are plentiful and probably even made in town. Furthermore, every law officer and militia member (or army as the case may be) has two S.D.C. weapons and one light to medium M.D.

weapon, mostly energy rifles. There is even likely to be 1D4 heavy M.D. weapons like a plasma rifle, grenade launcher, rocket launcher, or rail gun. Such heavy weapons may be part of a defensive tower, bunker or combat vehicle. Each energy weapon will have 1D6+8 extra **E-clips** with recharging and additional or replacement E-clips available through expensive trade with outsiders (only the rare town has the capability of recharging their own **E-Clips**). All town defenders will have light to heavy, homemade M.D.C. body armor; 3-5% *may* have light to medium environmental M.D.C. armor. They may or may not have the ability to repair, modify and mount weapons; few can actually make weapons, although some have gunsmiths capable of making, repairing and **modifying** S.D.C. and **sometimes**, M.D. weapons (see the Skill section). Cost: 20 points.

**5. Advanced.** Fundamentally the same as #4, except that not only do all town defenders have light to medium energy weapons (mostly rifles) with at least 12-20 E-Clips for each, but 10% of the townspeople will have light M.D. weapons, typically a **vibro-blade** or energy pistol, or sometimes a light energy rifle. All town defenders will have at least light to heavy homemade M.D.C. body armor, and 8-12% *will* have light to heavy M.D.C. environmental body armor. The town is likely to have one or more gunsmiths capable of making, repairing, modifying and mounting S.D.C. weapons and ammunition, and is even able to clean and do simple repairs on M.D. **weapons**, but probably have to go outside to get additional E-clips or to get spent ones recharged; cannot make M.D.C. weapons. Cost: 30 points.

**6. Superior.** The community has a full arsenal of S.D.C. and M.D. weapons. All town defenders have light to medium energy weapons (mostly rifles) with at least 20 E-Clips for each, and 10% also have 1D6 M.D. hand grenades or a side arm (M.D. energy pistol or **Vibro-Blade**). Furthermore, the town has enough M.D.C. weaponry to issue an M.D. side arm to every tenth person and most households have 1D4 S.D.C. guns, from revolvers or pistols to shotguns, hunting rifles or even an automatic assault rifle or **sub-machinegun**. Conventional S.D.C. ammunition are plentiful and made in town. And there is even one small facility for recharging E-Clips.

1D4+5 heavy M.D. weapons like plasma rifles, grenade launchers, rocket launchers, **and/or** rail guns are also available and are often part of a defensive tower, bunker or combat vehicle.

Weapon construction, repair and modification are also usually available at such towns.

Fifty-five percent of the town defenders will have light to medium homemade M.D.C. body armor, 20% will have heavy and 25% will have light to heavy M.D.C. environmental body armor. Such a place can be deadly! Cost: 45 points.

## B. Medicine

The Aboriginal tribes can survive without modern **medicine**, but most Outback settlements need doctors and medicine, whether it be modern or holistic. Basic medicines, painkillers, bandages, basic medical knowledge, midwives and other medicinal fundamentals that we modern people take for granted are of tremendous value to wilderness folk, and can spell the difference between life and death. The flu can cripple and kill, so can chicken pox, mumps and measles, and malaria carrying mosquitoes are an enormous threat in the marshlands. Infection of a

wound can lead to amputation, which in turn can lead to death. Coma survival is rare without medical equipment (see page 10 of the **Rifts® RPG**), and a simple laceration can cripple a person for weeks.

**1. None.** The community has no medical ability — no surgeon, no painkillers other than aspirin acquired through trade, not even a basic antiseptic or midwife. This place is in serious danger and survives by pure luck. Cost: None.

**2. The Basics.** There is the equivalent of one midwife (with the holistic medicine skill at +5%) and a paramedic, but no doctor. A few first-aid kits and basic medical supplies (clean bandages, gauze, towels, antibiotics, some common painkillers, etc.), equipment and knowledge. However, serious illness, injury, or surgery is way beyond **their** ability. Cost: 4 points.

**3. Good.** There are 1D4+1 midwives (with the holistic medicine skill at +10%) and the equivalent of one Holistic Doctor (+20% and at least 5th level) or Medical Doctor (M.D. capable of setting bones, performing surgery, etc.) and a nurse/paramedic (+10%) who assists the doctor. The doctor's office is like the old-time country doctor who probably works out of his home and makes house calls. These healers are all clean, competent and knowledgeable. Cost: 10 points.

**4. Very Good.** A half dozen midwives (with the holistic medicine skill at +10%) plus a small clinic with a dozen sick rooms, two surgery rooms and a good selection of medical equipment (EKG, respirator, heart **defibrillator**, old but effective X-ray machine, small basic laboratory, etc. — roughly equal to an EMS vehicle or field doctor's camp). Of course, big and expensive equipment like a dialysis machine, Cat scan, fully equipped laboratory, etc., are *not* part of this facility.

There are two or three M.D.s, or Holistic Doctors (at least 5th level and +20% to holistic medicine skill), or Psychic Healers, plus the equivalent of 1D4+2 nurses/paramedics (+10% skill bonus). There may even be an ambulance. Cost: 15 points.

**5. Excellent.** A tiny hospital with two dozen private sick rooms, two wards, four surgery rooms and an excellent selection of medical equipment (EKG, respirator, heart defibrillator, old but effective X-ray machine, small basic laboratory, etc. — roughly equal to an EMS vehicle or field **doctor's** camp) and even 1D4+1 ambulances. Big and expensive equipment like a dialysis machine, Cat scan, fully equipped laboratory, etc. are *not* part of this facility, but they are capable of performing major surgery and have a well trained and caring staff.

There is one chief Doctor who is 1D4+7th level, and 1D4 M.D.s, or Holistic Doctors (at least 6th level and +20% to holistic medicine skill), **and/or** Psychic Healers, plus the equivalent of 1D6+6 nurses/paramedics (+15% skill bonus). Not to mention a dozen midwives (with the holistic medicine skill at +15%). Cost: 25 points.

**6. Superior.** A small hospital with all the basics, 2D4x10 private rooms, plus six wards (each can accommodate 20 patients comfortably, twice that in an emergency), and a fleet of 1D4+3 ambulances.

There is one Medical Doctor who is Chief of Staff (1D4+9th level), 1D4+4 M.D.s (1D4+4th level), and the equivalent of 2D6+10 nurses/paramedics (+15% skill bonus). Not to mention one or two dozen midwives (with the holistic medicine skill at +15%) and 1D6 small clinics or private practitioners who are either M.D.s or Holistic Doctors (at least 5th level and +20% to

holistic medicine skill), or Psychic Healers; or a combination of all three. Some even have a Cyber-Doc. Cost: 30 points.

**7. Unheard Of:** A fully functioning hospital that can accommodate as many as 300 patients at a time and has all the modern equipment and facilities one could hope for. Beyond surgery and full treatment of disease, the community has a staff of doctors, nurses, paramedics, and even 1D4 **Cyber-Doctors!** Midwives, Psychic Healers, and Doctors of Holistic Medicine are less popular when such a technological wonder is present, but there are likely to be a handful of them along with a dozen M.D.s in private practice. A town with a facility such as this is likely to be visited by people for hundreds of miles around, providing plenty of work for private practitioners outside the hospital. The town may even have limited Juicer technology (G.M.'s call; see **Triax™ and the NGR and/or The Juicer Uprising™** for details about Juicers). Cost: 45 points.



## C. Water

Water is the foundation of life, especially drinkable fresh water in the vast, parched lands of Australia. A community had better base itself near a water supply, or it is sure to die off. Water supplies provide irrigation, washing water (personal hygiene), and most importantly, drinking water, as well as coolant for engine radiators and heavy machines. Water supplies come in various forms: rain catching tanks, underground water tables, rivers, streams and so on. Rising salt tables in Australia, low rainfall and drought which can dry up rivers, can lead to water shortages. Much of the Outback is arid land, so an ample water supply is a tremendously valuable commodity. The buying, selling and trading of water is commonplace and, in many places, it is more valuable than gold.

1. **Bad.** The community has a dried up well or desperate water situation. They will either have to move on or invest in digging a new or deeper well. This community is praying for rain every single day. Water rationing is a part of life and can get as low as two glasses of water per person per day (children get three). There is no water to be shared with strangers except under the most pressing of circumstances. Washing and engine cooling is a thing of the past. Cost: None.

2. **Low.** The water allowance is uncomfortable, in that only one engine can be run per day, washing is rare, water rationing is a regular occurrence and people are constantly thirsty. Alternatively, the water supply may be slightly contaminated and therefore cannot be used without being exposed to low levels of certain chemicals **and/or** require boiling to kill bacteria before

being useable. Rain catching tanks are used to supplement the water supply, so rain is a blessing. Cost: 4 points.

**3. Adequate.** There is a reasonably good and reliable supply of water, and the community has just enough to get by as they are with a little bit extra for crops or very limited trade. Cost: 8 points.

**4. Comfortable.** The water supply is clean, good and reliable. There is enough for everybody and then some. Consequently, there is room for growth, careful irrigation, and water can be shared with strangers, and limited amounts can even be **sold/traded** to travelers and less fortunate neighboring communities (usually at high prices). Cost: 15 points.

**5. Excellent.** The community has no worries when it comes to water. There is plenty to go around with enough left over for irrigation and careful sale/trade to others. Not only is there one or two deep wells, but a small freshwater river or pond. Cost: 22 points.

**6. Excessive.** Either situated on a huge natural resource like a large freshwater lake or river, or simply blessed with deep wells. Not only do they have plenty to **drink**, but so much that they can irrigate cropland without concern, export barrels and barrels of water (usually at low prices), and even go swimming in it for pleasure! There is so much that the people take it for granted. Cost: 30 points.

## D. Agriculture and Natural Resources

Closely linked to water, but a separate category, this relates to the raw production of goods the community can perform. Good land, good teamwork, old salvaged technology, and other factors can contribute to abundant resources. If the community has good agriculture but low water, then it can be assumed that it is a dry area where the plants are limited to those adapted to that environment, or irrigation is so important and good that what little water exists is tied up in supplying the crops.

**1. None.** The land has lost its top soil, and there are no resources to exploit. Farming or raising grazing animals is impossible. This community must rely on some other means to support itself and heavy trade with other communities and travelers. The poor land usually keeps such settlements tiny. Cost: None.

**2. Fair.** Growing crops is difficult and yield is usually minimal, but it is enough to survive. Timber and other resources are either scarce or of poor quality. The community must either supplement by hunting and trading (and they don't have much to offer) or make large cutbacks to its way of life. Cost: 4 points.

**3. Sufficient.** For one reason or another, the land is capable of reasonably good crop growing and **harvests, and/or** the raising of livestock at levels sufficient to support the current community. There is also likely to be a fair supply of timber or stone for building, or other basic resources. However, the town can not expand much, and drought, blight or raids resulting in serious damage and loss could be disastrous. Cost: 10 points.

**4. Good.** The people are comfortable and have enough to grow, store for a rainy day, and to trade. Their resources are typically basic things like a combination of good arable land for farming, grazing land for cattle or other livestock (or fishing), hunting and trapping, good to excellent availability of lumber

**and/or** rocks suitable for quarrying and building, and so on. Water is typically adequate to excellent and businesses are typically attracted because of the "good land" and the strong or growing community. Cost: 15 points.

5. **Enviied.** The people here are well fed, some even have pets, and they have a good local resource that gives them good crops, high yield, strong livestock **and/or** other benefits that they can either trade or use to make luxury items. Resources other than those for agriculture or raising livestock include natural gas, oil, mining for any variety of ores, (more) water, hydro-electric power (must have an excellent or excessive water supply), or rebuilt **pre-Rifts** manufacturing facility, power plant, lost technology, etc., that gives the community a coveted, tradeable commodity or rare service they can provide. Note: This is the minimum level required for a community to try drilling for oil or any of the things noted in the previous sentence. Cost: 20 points.

6. **Abundance.** The community is blessed with excellent resources (typically several), is completely autonomous and self-sufficient, and their local resources are not only enough to make them happy, but they have more than they know what to do with. Resources are either used with abandon **and/or** traded. May have several types of industry and limited pre-Rifts capabilities in certain areas. Cost: 30 points.

## f. Real Estate & Location

Location is very important for security. A badly placed township established in a flood plain, for example, may disappear into a swamp, be devastated by floods, or mud slides, etc. Likewise, one must be aware of changes brought about by seasons, weather, close proximity to ley lines, one's neighbors, regional conflicts, areas given to drought and high risk **fire** areas, and so on. A well-placed township shouldn't need constant foundation work or a vigilant watch to guard against natural disasters, fires, monsters and hostile forces.

**1. Shocking.** It's surprising this settlement hasn't slid into the sea, sunk into the desert or been destroyed by pillagers. Such a place is located in a highly volatile or otherwise unstable or dangerous spot — near a ley line nexus, a storm-riddled coast, Roadgangers, monsters, and so forth. Life is hard, disasters are common; the people really should think about moving. Cost: None.

**2. Bad.** The settlement is situated in or near a high flood area, crocodile infested swamp, desert, big ley line, dangerous gang, monsters, war zone, or similar hazard. Cost: 1 point.

**3. Fine.** No complaints, beyond the normal Outback troubles. Could be better, but all things considered, not bad. Cost: 5 points.

**4. Prime Location.** The region is stable and reasonably safe. Life is relatively comfortable, and the community easily defended or easily concealed by real estate such as this. Cost: 15 points.

**5. Location, Location, Location.** The settlement may be invisible from the air, magically protected from the ley lines, underground, underwater, or in some other exotic location that makes it safe **and/or** exclusive to its inhabitants. Cost: 40 points.

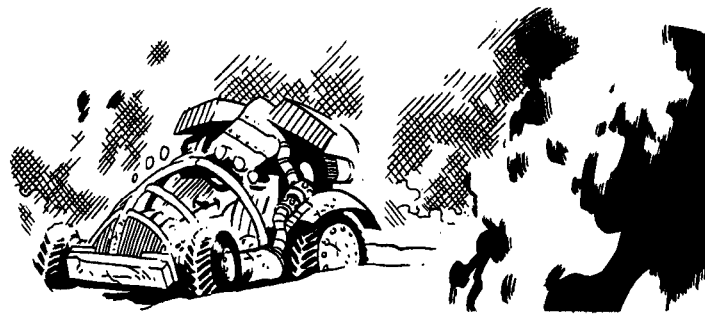

## F. Vehicles & Fuel

Vehicles are an important part of life, especially when communities exist so far apart from each other. Sometimes vehicles are required to plow fields, carry timber from a forest or tank water from a dam. Trade also requires vehicles if it is to be made efficient. The availability of motorized vehicles and fuel is an example of a valuable resource.

**1. None.** Simple. They don't even have a skateboard. Foot power is their mode of transportation. Cost: None.

**2. Live Animals.** A horse or two, maybe a camel (or a sail or row boat if near a body of water), and that's all. No machinery as of yet. No fuel other than some heating and lamp oil. Cost: 3 points.

**3. Very Basic.** A few good, strong riding and working animals (horses, oxen, etc., **and/or** exotic animals), plus a beat up utility vehicle, and a few spare parts for it; maybe a bicycle or two. If near water, the community will have a few **rowboats** and a couple of sailboats.

Fuel is difficult to come by and expensive. The town rarely has more than one month's supply on hand, and may occasionally run out for 1D4 months at a time. Cost: 7 points.

**4. Average.** The community has 1D4+2 motor vehicles in reasonably good condition (one might even be an M.D.C. vehicle), a dozen or two riding animals, a few bicycles, and some spare engine parts for the vehicles. In addition, it will have one beat up cargo hauling truck, a tractor, and a four-wheel drive vehicle. Fuel is difficult to come by and expensive. Usually has a 1D4 month supply on hand; rarely runs out completely.

If near water, the community will have several small rowboats, a few **motorboats**, a few small sailboats, a couple of large sailboats/fishing boats, and motor powered cargo barge, as well as a few ground vehicles. Cost: 12 points.

**5. Good.** The community has an enviable fleet of vehicles, including bicycles, several dozen motorcycles **and/or** bush bikes, a few tractors, a variety of small to medium-sized trucks, a selection of modified or souped-up vehicles (motorcycles, bush bikes, jeeps, land rovers, etc.), a few automobiles, 1D6 fast-moving hover vehicles, and 1D4x10% are even M.D.C. vehicles (nothing **heavy** and no military vehicles; average M.D.C. of the main body is 4D4x10!) They also have the tools, parts and general knowledge to maintain them. Horses and exotic animals are also still used for riding and work, especially on farms and ranches.

Fuel can be hard to come by, with prices varying from reasonable to exorbitant, but the town is usually careful to keep a 1D4+2 month supply on hand. Cost: 15 points.

**6. Excellent.** The community has a truly enviable fleet of vehicles, including bicycles, motorcycles and bush bikes, several tractors and heavy construction machines (dump trucks, **bull-**

dozers, steam shovels, cranes, etc.), at least two dozen small to medium-sized trucks, a dozen 18 wheelers, a variety of automobiles, jeeps, and land rovers, two dozen fast-moving hover vehicles, and half are M.D.C. vehicles (average M.D.C. of the main body is 4D4x10)! In fact, one in ten citizens has his own S.D.C. motorcycle, jeep, pickup truck or trusty oP automobile. Riding and work animals are typically restricted to use on farms, ranches and for pleasure riding. The town also has several garages and vehicle repair shops with skilled mechanics, maybe even a used car dealer.

Plus the community has in service 1D4+1 light to medium, M.D.C. military vehicles as part of its defense. Alternatively, they may own 1D4+1 aircraft, probably helicopters and light airplanes (if on water, it will have 1D4 patrol boats and a submersible). Cost: 25 points.

Fuel can be hard to come by, with prices varying from reasonable to exorbitant, but the town is usually careful to keep a 2D4+4 month supply on hand, and some have their own fuel supply/oil fields.

**7. Superior.** The community will have everything noted in #6 and then some. Fifty to sixty-five percent of the vehicles are M.D.C., the town defenders all have light, M.D.C. military vehicles (from armored hover bikes and jeeps to small half-tracks and APCs), and may even have one or two dozen power armor suits and/or 1D4 robots! Not to mention a small airfield and a dozen or so aircraft. One in five citizens has his own S.D.C. motorcycle, jeep, pickup truck or automobile; one in twenty their own M.D.C. vehicle. Riding and work animals are restricted to use on farms, ranches and for pleasure riding.

Coastal communities will have a third as many ground vehicles but a fleet of small to large sailing and motorized boats, plus a small fleet of military patrol boats and/or 1D4 submersibles, plus the aforementioned power armor units suitable for land and sea operations.

The town also has several garages and vehicle repair shops with skilled mechanics, as well as one or two car dealers (new and used). A tiny percentage of these superior vehicle places actually build and rebuild vehicles by hand. An even smaller percentage may have miraculously rebuilt a vehicle manufacturing plant to make and sell select types of vehicles. Cost: 35 points.

## G. Administration & Social Structure

Communities need to pull together to survive. Without order, they crumble and fragment. Efficiency is gauged by the quality of leadership and law enforcement.

1. None. Total chaos and anarchy. There is no one, strong leader or group and there are often rival groups squabbling for control of some small portion of the community. People do as they please, and nobody has any real authority over anybody else. What laws may exist are more like suggestions and optimistic philosophy. People panic and things unravel very quickly in times of strife. Cost: None.

2. Slight. The laws were agreed upon verbally, and are used to remind people what they *should* be doing, but they serve more as guidelines and strong suggestions than anything else. Only the most grievous crimes are punished and the important laws and practices are enforced. Leadership is weak, direction divided, and social structure loose. Cost: 5 points.

3. Fearless Leader. A strong, charismatic leader who the people respect, listen to and follow — some are even revered. The danger of this leadership is that the structure, justice, law and power is held by one man. This means the community is usually a reflection of his moral character, hopes and dreams. After all, it is the charismatic leader who is unifying the people and giving them purpose and direction. If they lose that leader, the community is likely to lose direction, splinter and flounder (become like #2), unless some new individual or group successfully takes his place. A wise leader will try to establish a support network and a means of finding or electing a new leader.

Generally speaking, such a place is reasonably well organized under a well-liked (or much-feared) leader. The town will usually have a fair to well structured society and set of laws and rules, but usually as the one leader sees fit. Cost: 10 points.

4. Good/Sound Structure. Typically a democratic structure of some kind with an elected leader — mayor, governor, etc. — and a secondary town counsel and public officers to help support and run things, including judge, sheriff, etc. Depending on the leadership, things run fairly to very well. Cost: 10 points.

5. Strong Structure. Typically a democratic structure with a governing body that shares the duties of running the affairs of the town. Social order, law, justice and sense of unity are clear and strong. Citizens understand their place in the community and most work together like the parts of a well-oiled machine. The leading body may be any form of government, but most communities in Rifts Australia are some type of democracy. Cost: 15 points.

6. Utopian. Very rare. Historically, Utopian societies have never worked on a large scale, but can have limited success on a small scale (under 10,000 people; smaller is better), especially when a community is reasonably prosperous, and has a strong sense of identity, equality and camaraderie. They are almost always democratic, with a group, committee or congress holding the seat of power rather than any one individual (no mayor, etc.). A Utopian society can be super rigid and organized or super-open and loose (with individuals taking great pride and personal responsibility in the maintenance of their community). However, in either case, most citizens share the same fundamental beliefs, views, values, and aspirations. In many cases, these societies fall apart, because the community becomes an engine that works like clockwork — everything perfectly in its place — so when something is seriously knocked out of kilter or their world view shattered, pandemonium may result, and adaptation may be impossible, causing the community to splinter and disperse. Cost: 20 points.

## H. Alignment

This is the general, predominant alignment of people in the community (about 80% of the population). There will always be exceptions to the rule.

1. Miscreant and/or Diabolic. Cost: None.

2. Aberrant. Cost: 4 points.

3. Anarchist. Cost: 2 points.

4. Unprincipled. Cost: 4 points.

5. Mixed: Unprincipled & Scrupulous. Cost: 6 points.

6. Mixed: Anarchist & Unprincipled. Cost: 4 points.

7. Mixed: Anarchist & Miscreant. Cost: 2 points.

8. Mixed: Aberrant & Miscreant. Cost: 3 points.

9. Scrupulous. Cost: 6 points. 10. Principled. Cost: 8 points.



## I. Magic

Magic is usually required to combat magic and monsters. This category is required if the community is to be magically aware, even the slightest bit (many are not). The more understanding there is, the less superstition there will be, and the better prepared the community will be to defend against magical and supernatural threats.

**1. None.** No one in the settlement can cast spells, nor knows about ley lines (other than that they are strange, scary places that attract monsters), or has any understanding about magic or the supernatural. Superstition is high and even Aborigines are viewed with awe *and/or* fear. These people are likely to regard practitioners of magic as mysterious, frightening, dangerous and probably inhuman or the servants of demons. Cost: None.

**2. Vague Understanding.** Magic is accepted as being real and ley lines, or “Songlines” as the Aborigines call them, are known to be places of magic, spirits and supernatural monsters. One or two of the more educated people in town know a few basic truths about magic (magic and Songline lore) as well as a thing or two about the supernatural (like vampires are burnt by the sun, demons can be killed with powerful enough weapons, and the **Kwarla** are actually a friendly race — all part of demon & monster lore). Still, true spell casters, magical beings and even Aborigines are viewed with a certain amount of mystery, awe and fear. Cost: 4 points.

**3. Good Knowledge.** Most everybody in town knows magic is real and that it is a resource that can be used for good or evil, to destroy or build. Most don't fear it, but respect it as a formidable and dangerous power. Likewise, they understand that the world has become a place with magic and deadly supernatural beings. They know enough to take precautions and stay out of danger from the average supernatural menace, but the average person is still ill-equipped in truly dealing with magic or the su-

pernatural. That is left to the 1D4+1 wise men or elders well versed in magic, and demon and monster lore (and similar lore). Such a town may also have one or two practitioners of magic living among them or as part of their magical defenses. Similarly, there may be a few major or master psychics among them. Cost: 10 points.

**4. Vast Knowledge.** The people of this community have a strong understanding of magic and the supernatural, and encourage the study and practice of magic.

It is likely to have 1D6+1 low level (1D4) spell casting residents, and a small library or guild of supernatural study (either physical books and records, or mentally, in the form of wise men, scholars, and sorcerers, or otherwise knowledgeable people). In **addition**, there is likely to be one master sorcerer (1D4+5th level Line Walker, Mystic, any), as well as 1D4 3rd to 5th level practitioners of magic, and a few (1D6) low level beginners (1st & 2nd level) among the town defenders, particularly to fight against supernatural dangers. Such a community is usually also accepting of Aborigines, psychics, and friendly creatures of magic. Cost: 15 points.

**5. High Magic.** Magic is a common and everyday part of the settlement's existence and way of life. Scholars, shamans, and a variety of practitioners of magic, as well as psychics, are respected and valuable members of the community. In fact, the town may draw on Songlines *and/or* use magic to build and protect itself. There will be at least a handful (1D4+1) of high level sorcerers (1D4+6th level Line Walkers, Mystics, Shifter, etc.), a dozen or so mid-level spell casters (4th to 6th level) and another 1D4 dozen low level beginners (1st & 2nd level). Psychics, Aborigines, Demon Slayers, friendly creatures of magic (dragons, etc.) and even D-Bees are all likely to be accepted at such a community. Cost: 30 points.

## J. Racial Tolerance

Racial tolerance can enrich and help a community, especially in the Outback, but infighting and prejudice is commonplace.

**1. Zero Tolerance.** Everybody in town is human, and there is a definite prejudice against all other races, including the enigmatic Aborigines (although human, they are seen as strange mystical people or as primitive savages who have abandoned the ways of civilized men). The only use they have for **nonhumans** is as slaves, and some communities won't tolerate their presence even then. Cost: None.

**2. Disapproving & Suspicious.** While Aborigines and human variations (mutants) are tolerated, D-bees and the more unusual and monster races are hated and discriminated against. A human's word always has more clout, while nonhumans are regarded as dirty, smelly, untrustworthy, thieving, dangerous, lazy, and dumb, yet cunning and treacherous. The only use they have for nonhumans is as slaves or the lowliest, misused and abused workers (given the worst and hardest jobs). Cost: 1 point.

**3. Reasonably Tolerant.** Fairly accepting of **nonhuman** races who are attractive and human-like, but less tolerant and accepting of alien and monstrous beings. Although they are not likely to find slavery acceptable, most nonhumans, especially alien and monstrous ones, are treated like second-class citizens. Cost: 5 points.

**4. Tolerant.** The people of the settlement *are* of mixed blood, and are accepting of other races, even monstrous D-bees, aliens and many creatures of magic. This leads to diversity and a more advanced and open community. They would never consider enslaving any being and try to treat **nonhumans** as equals. Cost: 7 points.

**5. Extremely High Tolerance.** Fundamentally the same as #4 above, but the community has gone a step or two further to become tolerant of even extremely alien looking D-Bees, friendly monster races and supernatural beings. True "demons," including vampires, will always be feared and hated; as they should be. Cost: 12points.

## K. Trade

This represents the willingness and ability to trade with other settlements and perhaps even the cities of Perth and Melbourne. This will raise the wealth, resources and diversity of equipment the community has available to it, some of which may be quite exclusive.

**1. None.** Although the occasional item, service or bit of information may be sold or traded to a passing traveler or neighbor, there is no type of formal or organized trade operation. This community can either barely support themselves, or are

self-sufficient isolationists who want nothing to do with outsiders. Cost: None.

**2. Internal.** Trade of goods and services goes on only within the community. Money and trade goods actually have meaning to the people within the settlement, but they seldom trade with the outside world. This community is usually self-sufficient, but **afraid** of the outside world and keeps contact to a minimum, has little of value that outsiders might want, or is geographically isolated in a remote or inhospitable (or inaccessible) place. On the other hand, the people may be isolationists who want nothing to do with outsiders. Cost: 2 points.

**3. Limited.** The community does have one or more trade goods or services they are willing to trade with others, especially nearby settlements, but nothing of great significance or tremendous value. Just enough basic things to keep avenues to resources they don't have themselves and communication open to the outside world. Cost: 10points.

**4. Established Trade.** This settlement encourages trade and has well established trade operations and/or trade routes. They trade with other settlements and travelers alike, and may send agents, buyers and sellers hundreds of miles away to find needed and desired items. At least 33% of their revenues and resources come from trading. Cost: 15 points.



**5. Barter Town.** Such trading posts make 75% (sometimes more) of their living from buying, selling and trading goods and services. Most Barter Towns will sell or trade anything that isn't nailed down, and will sell to most anybody unless they share a prejudice against **nonhumans**. Such places often attract a rowdy and dangerous clientele including adventurers, mercenaries, drifters, hunters, Aborigines, **Roadgangers**, raiders, thieves, smugglers and all sorts of criminals and roughnecks. They rarely have any sort of formal alliance and like to keep themselves relatively "neutral" when it comes to politics and money. In addition to goods and services, most Barter Towns actually have Australian "dollars" and some even take Universal Credits. In addition, most will have information about the region, trade with other **settlements**, and offer a surprising array of goods and services from girls, gambling and booze to mechanics/repairs, medical services, and **M.D. weapons**. Prices are usually 50-300% higher than book price for most rare (to the Outback) items, including vehicles, M.D.C. armor, M.D. weaponry, **E-Clips** and ammunition, magic items and fuel. Meanwhile, the exchange rate for "trading goods for goods" is roughly about 40-50% of its book value, while flat out payments in dollars or credits is usually 10-20%, sometimes a bit higher for rare items. Cost: 35 points.

**6. City Traders.** This settlement has shunned its fellow Outback communities to trade almost exclusively with the two tech-Cities, Perth and Melbourne, and perhaps a few of the biggest towns, like Sydney. As "City Traders," these towns are usually prosperous (although hated by most of their fellow **Outbackers**) and trade raw materials (oil, ores, furs, etc.) and, sometimes, information and services (scouts, labor, etc.) to the City Dwellers. In return, they get modern equipment such as generators, electronics, M.D. weapons, M.D.C. environmental armor, M.D.C. building materials, M.D.C. vehicles and parts, synthetic clothing, medicine, fuel, and so on, as well as processed foods and drinks like soda pop, concentrated juice, microwaveable **food**, candy, etc. Cost: 20 points, but must be in relatively close geographic proximity (within 500 or so miles) or have a reasonably easy trade route; typically by the sea.

**7. Oil Town.** A rare and coveted oil barony where crude oil is pumped from the earth and refined into gasoline, kerosene, and other petroleum products. 60-90% of this community's **income**, resources and trade has to do with petroleum products. Cost: 40 points.

**8. Industrial Boom Town.** A town that has found old, **pre-Rifts** technology and/or 1D6 rebuilt manufacturing **plants/factories**. The products can be almost anything, but weapons (S.D.C. and M.D.), armor, vehicles, tools, and raw materials are the most needed. The sale and trade of manufactured goods or tech-services (mechanics, electronics, advanced medicine, etc.) represents 60-85% of this community's resources. Cost: 45 points.

## L. Threats

This feature is often linked to location, although not necessarily in the way one may think. A great location may be coveted by envious neighbors or powerful invaders. On the other hand, geography, poor planning or fate may play a hand in the overall level of danger and threats. Such threats can include human predators like gangs, bandits, pirates, cannibals, evil sorcer-

ers and Roadgangers, to roving monsters, demons, evil spirits, and close proximity to a ley line or ley line nexus (a dimensional portal that frequently opens randomly can be a serious problem). In addition, the two Tech-Cities also represent potential danger.

**1. Constant.** The community is located in a volatile and hostile environment. They are constantly in a state of chaos and unrest, and forever being threatened, abused and ravaged by all kinds of threats, be it from monsters, demons, bandits, raiders, roving gangs, storms, wild animals, City-Goers, or other settlements. Cost: None.

**2. Dangerous.** Yes, dangerous, but **survivable** and even tolerable, for while there are frequent threats and potential dangers, there are also moments of peace — time to regroup and recover. Danger tends to overshadow the lives of the Outbackers living here, but they deal with it. They don't have a choice. Cost: 3 points.

**3. Moderately Dangerous or Low Threats.** Serious threats are rare, just the occasional rampaging monster, raiders or wild animal. Cost: 10 points.

**4. Relatively Safe.** There isn't really such a thing as a truly safe place in Rifts Australia, but these places come close. Through luck more than any other means, the community is rarely assaulted by forces of nature, raiders, magic or the supernatural. The inhabitants are at ease and feel quite safe. Cost: 20 points.

## M. Skill Levels & Professionalism

Highly skilled people are prized. They become key personalities within a wilderness community, as their skills make life easier, and are often a valuable resource. They can also teach others and help the community to grow.

In all cases, the community is assumed to have enough of these individuals (between one and five) to meet its demands. You may purchase more than once from this category.

1. **Doctor/Healer** (extra if already has good medicine). Cost: 12 points.
2. **Mechanics.** Cost: 10 points.
3. **Electronics.** Cost: 10 points.
4. **Building/Fortifications.** Cost: 10 points.
5. **Pilot/Driver.** Cost: 7 points.
6. **Scholar or Scientist.** Cost: 6 points.
7. **Bushman/Scout.** Cost: 10 points.
8. **Raider.** Cost: 20 points.
9. **Trader/Merchant.** Cost: 10 points.
10. **Warrior/Grunt.** Cost: 5 points.
11. **Military Specialist/Spy/or Law Man.** Cost: 10 points.
12. **Historian or Teacher.** Cost: 5 points.
13. **Rancher/Cowboy.** Cost: 7 points

The Community Overall (buy only one):

**1. Poor: Predominantly unskilled laborers;** little if any formal education 5-10% are literate. Technology level is low. Cost: None.

**2. Average:** Hard workers and some skilled professionals. Approximately 15-30% of the people have training in a particular trade; 20-30% are literate. Technology level is moderate. Cost: 5 points.



3. **Good: Skilled.** Most people have some degree of education, 50% are literate, 35-50% are skilled, and most have some respectable trade. Technology level is typically middling. Cost: 10 points.

4. **Excellent: Highly Skilled.** Most people have had some measure of higher education or a respectable trade. Literacy is high at 60-80%, and there are many scholars, teachers, and skilled professionals. Technology level is usually good to high. Cost: 20 points.

## N. Shelter

The actual number and condition of the buildings within the settlement.

1. **None.** People camp out under the stars. Dangerous and exposed. Cost: None.

2. **Poor.** Tents, shabby huts, and makeshift buildings clustered together. Cost: 2 points.

3. **Good.** Simple but solid buildings that are reasonably sturdy. Typically made of wood and/or mud bricks, with the occasional stone, concrete or composite structure. 1D4 buildings will be made of M.D.C. material with 4D4x10 M.D.C. Cost: 7 points.

4. **Excellent.** Comparatively modern buildings made from a mix of materials. At least 10% will be made of M.D.C. materials (1D4x100 M.D.C.) and may be a restored pre-Rifts structure. There may also be utility buildings, defensive fences and/or walls, and perhaps some underground M.D.C. shelters/bunkers as well. Cost: 12 points.

5. **Fortified.** Many buildings have an A.R. of 15 and have a minimum of 3D6x1,000 S.D.C. (equal to 3D6 M.D.C.), and 1D6x10% are M.D.C. structures ranging from 100 to 500 M.D.C. There are at least 1D4 large M.D.C. community buildings and 2D4 bunkers (3D4x100 M.D.C. per each building/bunker). Plus there is an outer wall (1D6x10 M.D.C. per 20 square feet) protecting at least 2D4x10% of the community, 1D4+2 lookout towers or fortified positions, and the rest of the area is protected by light M.D.C. fence, dirt mounds/berms and similar light fortifications (1D6 M.D.C. points per 50 square feet). Cost: 30 points.

## O. Security & Fighting Force

Most of the time security is light or completely ignored. On the other hand, everybody knows each other in small communities, so strangers and trouble are immediately recognized. Some communities, especially military and paranoid ones, have well defined defenses, check points, and security systems in place. This category refers to the settlement's militia. **Note:** The exact types of vehicles, weapons, equipment and other resources will depend on the amount of points spent in other categories.

1. **None.** There is no formal security and people fight the best they can when they need to, but this can lead to disorderly rabble in a crisis. Cost: None.

2. **Volunteer Militia.** The town has a group of volunteer defenders to take up arms in times of trouble. Furthermore, 1D6x10% of the citizens will join the fight to protect their town, and most will fight to defend their homes and loved ones. A typical militia is rarely larger than 10-20% of the population. The



people have probably appointed one person to be a security officer or constable. Cost: 7 points.

3. **Sheriff & Militia.** Similar to #2, except the town has an officially appointed law man who is a skilled and seasoned warrior (1D4+5th level man at arms) who commands 2D6+2 deputies or a small police force (also various men at arms, ranging in level from 1-6). Cost: 10

**4. Standing Army.** In addition to a militia, and possibly a Sheriff **and/or** small police force similar to #2 and #3, the town has a small standing army that can range **from** the size of a platoon (40 troops) to a full company (100-160 troops). The 1D4+3 leaders in the group will be 1D4+4th level, while the general troops will range widely from level one to six; 3rd level average. Cost: 15 points.

**5. Mixed Fighting Force.** A fixed defensive force will include a militia, small to medium police force and a standing army the size of a company (160 troops), sometimes larger. In addition to fighting troops like those in #4, the unit is likely to include a handful of Military Specialists or Commandos, a handful of psychics, one to half a dozen practitioners of magic, and a squad or two (10-20) of power armor troops. While the entire community may rise up and fight to defend their homes, these are the chosen warriors. In addition to civil defense, squads from these forces may engage in dangerous military missions in the field, including Reconnaissance, Rescue, Search and Destroy, Espionage and Sabotage. Such a large military force is fairly uncommon except at prosperous, large towns and the occasional city. Cost: 20 points.

## P. Power/Energy

Power is required to run lights, machines, medical facilities and many other advanced machines common to daily life. Power may be generated from many different sources — fire, steam, methane gas, solar cells, a hydroelectric generator, rare **geothermic** power plant (**pre-Rifts**), fossil fuel generators, batteries that require a recharging generator, **E-clips**, etc. Power is also one of the most difficult commodities to find and keep in the Outback.

**1. None.** The settlement is without any power other than the use of fire and perhaps steam. Back to nature! Cost: None.

**2. Low.** Crude gas, coal, wood **and/or** petroleum powered generators, and furnaces provide about several hours of lighting at night and the energy to run light to medium machines. Fire and steam power may also be used. Having sufficient fuel is always a problem. They may also be used to power other machines. Cost: 6 points.

**3. Good, Solar & Fuel Burning Power.** Solar energy panels and the use of fuel powered generators and machines are the main source of power. They can also be used to charge batteries. The towns batteries are enough to provide about 8 hours per day of artificial lighting. Cost: 12 points.

**4. Good, Hydro-Electric Power.** Generators driven by the flow of water are used as the primary means of generating power. May use back-up fuel powered generators **and/or** windmills, as well as **fire** and steam. Cost: 20 points.

**5. Good, mixed.** Any combination of windmills, solar, methane-run generators (fueled by the waste of livestock), batteries, and other fuel powered generators and machines. May also have a few high-tech nuclear batteries and power packs (the latter are either pre-Rifts artifacts or City creations). Cost: 25 points.

**6. Excellent, Mixed.** A little bit of everything: Solar systems, windmills, fire and fuel burning systems, perhaps even hydro-electric **and/or** high-tech nuclear batteries, power packs, and generators, or a small power plant (the latter nuclear sources are pre-Rifts artifacts or City creations). Cost: 35

**7. Excellent, High-Tech and High-Powered System.** The town actually has access to a running nuclear power plant, major hydro-electric plant or rare geothermic plant. Energy is abundant with plenty to spare. Super rare. Cost: 50 points.

## Q. Special Features

These are *some* of the notable special facilities or advantages that can make a big difference in the lives of wilderness people. More than one of the following can be purchased, and the same Special Feature (with cumulative effect) can be selected as often as three times, but each selection costs points.

1. A simple garage with basic repair equipment and rudimentary facilities. Cost: 6 points.

2. A large, advanced garage with full facilities to effect repairs, weld, make major modifications and build, tear down and rebuild large vehicles and heavy **equipment**. Cost: 10 points.

3. A large aircraft hangar, with space for a few small aircraft, or one or two big ones. Cost: 6 points.

4. Electronics Lab, with computers, diagnostic equipment, and basic tools and facilities for repair, modification and testing. Cost: 10 points.

5. Library, which may contain many valuable, pre-Rifts books, magazines, microfilm, video discs, and similar historical and scholarly material. Cost: 15 points — 25 if 30-50% are pre-Rifts artifacts.

6. Science Lab, with basic testing and research equipment, chemical analysis, etc. Cost: 15 points.

7. Communications Suite, possibly including long-range radio transmitter/receiver (500 miles/804 km), scrambler, multiple channels, plus short-range radar equipment (25 miles/40 km). Cost: 10 points.

8. Country Maps, either detailed, pre-Rifts maps, or up-to-date maps, the latter probably drawn by hand. Cost: 3 points.

9. Hydroponics, allowing food to be grown in the worst of conditions. Cost: 5 points.

**10.** Cellars, to be used as storm (or monster) shelters and hiding places as well as simple storage or refrigeration. Cost: 4 points.

**11.** Processing Plant or Manufacturing plant (varies by resources). Cost: 10 points.

12. Landing Strip, in decent condition, kept relatively clear. Cost: 14 points.

13. Good roads, attractive to travelers and bandits alike. Cost: 4 points.

14. Harbor with 1D4+2 docks and piers. Cost: 12 points and is limited by geographic locale.

15. Robotics Workshop, with advanced repair and testing equipment. Cost: 15 points.

16. Aeronautics Workshop, with basic repair and testing equipment. Cost: 12 points.

17. Limited Computer Equipment. Cost: 12 points.

18. SCUBA gear and Underwater **Workshop/Repair** Facilities. Cost: 5 points.

19. Old M.D.C. materials salvageable for body armor and building materials (3D4x10 M.D.C. per every 10 foot square/3 m of **material**). Cost: 10 points.

20. 1D4 large **pre-Rifts** M.D.C. bunkers with 1D4x1000 M.D.C. Cost: 10 points.

21. Old M.D.C. ruins that can be fixed up as homes, community buildings **and/or** bunkers (each has 3D6x1000 M.D.C.); 3D6 total buildings (exact size — could be skyscrapers or a two story home or business — is left to the G.M.). Cost: 10 points.

22. Pre-Rifts underground complex or catacombs. Typically and underground garage, one a series of basements (easily connected with tunnels), subway tunnel or similar underground structure. The walls are sturdy M.D.C. structures and are ideal for use as secret hiding **places**, underground bunkers, storage and even living quarters or prison cells. Cost: 15 points.

23. Pre-Rifts weapon cache (old weapons of any or all kinds; G.M.'s discretion), 4D6 total, plus 2D4x10 **E-clips**. Cost: 15 points.

24. Pre-Rifts cache of 3D6 salvageable ground light to medium M.D.C. vehicles (100-300 M.D.C. each). Cost: 15 points.

25. **Nonhuman** allies (D-Bees, creatures of magic, supernatural beings; or if the G.M. allows it, a loose alliance or deal of some sort with Perth or Melbourne). Cost: 20 points.

## Some Notable Outback Communities

What follows is a collection of some of the most notorious Outback "capitals" — new centers of activity, trade and growth. Each *may* grow into a new major population center, or fade away like the towns of the American Old West that would boom for 3D4 years only to go bust and vanish. They also serve as examples of how to construct Outbacker townships.

### Sterling

Sterling is typical of the sort of base a G.M. may wish to use in an Outbacker campaign or setting.

The G.M. must decide on a size. In this case, he'll take the Typical Outback Community, because he wants a well established town where the Player Characters will be assured of aid from friends and maybe even family. This gives him 220 points to spend on creating this town.

**First**, a basic concept for the town must be established. In this respect, creating a town is a bit like creating a character, with its own personality, background and individual touches. The G.M. decides he wants a prosperous little town of about 100-200 people, that is well situated on the N.S.W. coast near the ruins of Sydney, and has little to worry about in terms of natural resources. Given that the area where it is situated in is so rich, there is likely to be a high number of professionals present (mechanics, etc.) as well as trade routes to other communities. The G.M. also wants a moderate level of equipment to be **present**, so that the players will have a head start **with** their gear.

With this mental picture, the G.M. then sets to adding personal touches. For instance, by purchasing a reasonably high threat from supernatural predators, it can be assumed that the town would be close to a **Songline** or site of power. Hence, the town is likely to have a sorcerer or two.

With these simple guidelines in mind, the G.M. then sets to purchasing everything he envisions from the tables. After all is said and done, Sterling comes out looking like this:

**Orientation & Disposition:** Open and Friendly (but could just as easily have been Open and Cautious).

**General Type & Size:** Typical Outback Town (on the small side).

**A. Weapons and Armor:** Firearms. Good range of S.D.C. weaponry and the occasional M.D.C. items.

Cost: 20 points.

**B. Medicine:** Good. With one doctor and a few paramedics.

Cost: 10 points.

**C. Water:** Adequate. There is a good supply of water, and the community has just enough to get by as they are.

Cost: 8 points.

**D. Agriculture & Natural Resources:** Sufficient. The harvest is enough to feed everyone and have a little left over. There are livestock (pigs and cattle), and a supply of timber and stone to build with.

Cost: 10 points.

**E. Real Estate:** Prime Location. On the coast, in a valley at the rear of a bay on old Sydney harbor, yet with easy access to some surrounding flat agricultural lands.

Cost: 15 points.

**F. Vehicles & Fuel:** Average. Two reasonable vehicles, some riding animals and some spare engine parts for the vehicles.

Cost: 12 points.

**G. Administration:** Strong Structure. A social order exists, people understand their place and the community acts like a well-oiled machine. The leader is an N.P.C. the G.M. will create later.

Cost: 15 points.

**H. Alignment:** Unprincipled and Scrupulous.

Cost: 6 points.

**I. Magic:** Good Knowledge. Magic is understood, the precautions required to fight some supernatural menaces are known and generally magic is not feared so much as respected.

Cost: 10 points.

**J. Racial Tolerance:** Tolerant. The people of the settlement are of mixed blood, and relate fine to other races and D-bees. There are Aboriginal members, as well as mutants and D-bees.

Cost: 7 points.

**K. Trade:** Established. This settlement has well-traveled and established trade routes with five other settlements around the Sydney ruins area and welcome adventurers, merchants and traders.

Cost: 15 points.

**L. Threats:** Dangerous. Yes, dangerous, but livable. There is a constant threat from the nearby ley line, as well as bandits, raiders and the occasional monster, not to mention spies and trouble from the Tech-Cities. Cost: 3 points.

**M. Skill Levels and Professionalism:** Community skill level is average, people get by.

Cost: 5 points.

The town also has some well trained experts:

Doctor; Cost: 12 points.

Mechanic; Cost: 10 points.

Scholar; Cost: 6 points.

Bushman; Cost: 10 points.

**N. Shelter:** Good. Buildings are reasonably sturdy, and everybody has enough shelter.

Cost: 7 points.

**O. Security:** Volunteer militia. When required, everybody knows the drill and who is assigned to take up arms. The people have appointed one person to be a security officer of sorts (the G.M. will make up an N.P.C., or maybe select one of the player characters).

Cost: 7 points.

**P. Power: Low.**

Cost: 6 points.

**Q. Special Features:** The town has the following assets:

Cellars. Cost: 4 points.

Library. Cost: 15 points.

Country Maps of the surrounding areas and the greater parts of N.S.W. Cost: 3 points.

Limited Computers. Cost: 12 points.

While this all adds up to 228 points, placing Sterling 8 points over its point allotment, the G.M. decides that it's **okay**, because he likes the way the village looks and the selections make sense.

So the following can be summarized about Sterling. It's a busy, well rounded small town with an open mind and an efficient daily routine. It is in a prime area and enjoys good relations with surrounding communities. Its only problem is the occasional raider, monster and supernatural creature, but together with their alliances and organizations, they manage alright. The Player Characters in such a town are likely to be key figures; defenders, scholars, notorious adventurers or heroes, and perhaps leaders of some kind that people look up to.

All the G.M. has to do now is create some Non-Player Characters (**N.P.C.s**) to add **detail**, contrast, color, and personality to the area, and he is ready to use this detailed town in his campaign. Of course, the Player Characters are likely to leave and start their travels almost immediately after the campaign begins, but at least they will have a firm idea of where their characters came from, and have something of a home base to return to. Alternatively, the G.M. could use Sterling as the hub for a string of adventures around it, without actually basing the characters there. He could weave a conspiracy into it somehow, or maybe the town is built on an important Aboriginal site, City spies are hatching some insidious **plot** ... the possibilities are limitless.

## Trade Town

**Orientation & Disposition:** Open but cautious (grew from Tight Bonds & Strong Family Ties).

**General Type & Size:** Major Outback Town (on the large side).

**A. Weapons and Armor:** 3. Good.

**B. Medicine:** 2. The Basics.

**C. Water:** 3. Adequate.

**D. Agriculture and Natural Resources:** 2. Poor.

**E. Real Estate:** 3. Fine.

**F. Vehicles:** 5. Good.

**G. Administration:** 3. Fearless Leader.

**H. Alignment:** 4. Anarchist and Unprincipled.

**I. Magic:** 2. Vague Understanding.

**J. Racial Tolerance:** 3. Reasonably Tolerant.

**K. Trade:** 5. Barter Town.

**L. Threats:** 3. Average.

**M. Skill Level: The Community Itself:** 2. Average.

**N. Shelter:** Generally, #2. Poor.

**O. Security:** 3. Sheriff & Militia.

**P. Power:** 5. Good: Mixed.

**Q. Features of Note:** Garage, M.D.C. Hangar (4,000 M.D.C.), Hydroponics, Cellars, Processing Plant, Landing Strip, Limited Computers.

Located on the western edge of the Great Dividing Range in northern New South Wales, **Trade Town** is in an unusual position in that it deals with both **Roadgangers**, Outbackers and adventurers alike. It is a dusty, violent, rambling and constantly changing affair made up of **tents**, wagons, shanty housing, and makeshift facilities for machinery and wares. The original purpose of the location has been lost over time (probably an outpost), but now it serves as a commercial landmark and a place some will travel hundreds of miles to visit so they can trade their goods.

All manner of things can be acquired in Trade Town, from weapons and vehicles to simple bags of grain and bolts of textiles. Magic and sorcerous items are frowned upon and dealings in magic usually occur "**under the table**" in backrooms. Most trade goods don't have set values, because these constantly change and merchants adjust costs depending on their current needs, prejudice and greed. Most transactions take place in the form of direct swaps and deals that all parties involved must agree on, there is little actual currency.

There is a very basic system of laws that governs the town, the most important rule of thumb is simple: break your word **and/or** cheat a merchant, and you'd better get out of town before anyone finds out. And you better not come back. The aggressive nature of the town is such that crimes like assault, slander and vandalism are dealt with by direct retribution from the offended party, so the law doesn't need to step in. The police themselves are a small group of ragtag heavies/thugs who hold multifunctional roles under the governor of Trade Town, Mister Money. They are sometimes called upon by distressed traders to arbitrate situations, but being thugs themselves they often care very little for the actual verdict or circumstances — just so long as they get to bash heads and make the point that outsiders can't mess with the merchants/traders.

The words of the residents and merchants hold much greater "truth" and value than most outsiders unless that outsider is famous or wealthy. This means most Trade Town citizens and merchants can get away with cheating their customers, lying about product and price, and even extortion, assault, and sometimes, murder. The local police really only concern themselves with serious crimes like arson, grievous bodily injury, murder and major theft, particularly when a resident or merchant is the victim. Most other crimes are noted, but little is done about them, unless the perpetrators make a spectacle of themselves or embarrass the police, then all stops are pulled out and they'd better watch out.

The features of the town are generally low. It is run on several power supplies, from conventional solar batteries to **meth-**

**ane-run** generators fueled by livestock waste. The center of the town is dominated by a gigantic building fashioned from the ruins of a **pre-Rifts** aircraft hanger. Inside this **M.D.C.** concrete structure is where the police base themselves, where the governor spends his time and where courts are held. The building is also home to combat arenas, storehouses, grubby hotels and other hovels that rarely see the scorching light of day.

The current population of Trade Town hovers around 23,000, but it is difficult to quantify a precise total. At any one time, this population may as much as double, including transient visitors. The regular, permanent population of the town is really only about 7,000 people, as few others ever live there for more than 6-12 months at one time.

### **Mister Money; Quick Stats**

An obese, orcish man in his mid-forties, Mister Money only shows himself to the public in a tattered suit, wearing an ugly leather face mask to disguise his inhuman nature. He is a foul, hideous being who has one primary interest, and that is the acquisition of wealth. He taxes all who visit Trade Town, taxes all who trade within her walls, and punishes those that do not cut deals on his streets. He likes to advertise himself as a fair and honest man who wants to see the entire country flourish through barter. He often makes gruff speeches in his guttural voice through his mask to those that gather at arena fights in an attempt to endear himself as a decent man. It seldom works, but people see no reason or need to replace him, so Mister Money stays.

The wealth he has amassed in his hidden basement lairs is extraordinary — jewelry, gold, books, dragon bones, the occasional magic item, an armory of various **M.D.** weapons, a crate of hand grenades (288; each does 4D6 **M.D.**), hundreds of **E-Clips** (and two Clip recharging units), dozens of **M.D.** vehicles, even power armor! None of it ever sees use, though, because Mister Money is insane in his greed. He hoards, but lacks the intellect to see beyond his lust for treasure, or even to see that jewelry and gold is next to rubbish these days. If he wanted, he could arm his police force to the teeth, but even they do not know exactly what he has in his store rooms, so they continue to enforce the law with crossbows, automatic weapons, and only a handful of modest Mega-Damage weapons.

The fact that he is an **orc** is a closely guarded secret. He has only one trusted companion, a blind human psychic called *Slector*, who serves Mister Money as a spy, seer and adviser. Slector is far from loyal, but Mister Money does not realize this. The truth is, Slector uses and manipulates the **orc** for his own purposes.

### **Mister Money NPC**

**Alignment:** Miscreant

**Race:** Orc

**Attributes:** **I.Q.** 9, **M.E.** 12, **M.A.** 8, **P.S.** 24, **P.P.** 17, **P.E.** 18, **P.B.** 7, **Spd** 12.

**P.P.E.:** 12

**Hit Points and S.D.C.:** 40 Hit Points, and 34 S.D.C.

**Level of Experience:** 6th level Trader

**Combat:** 6th level Hand to Hand Basic, five attacks/actions per melee. Typically armed with an **M-01** laser pistol, four hand grenades (4D6 **M.D.** each), and **Vibro-Short** Sword concealed under his jacket. He also has a suit of heavy, environmental **M.D.C.** body armor he dons during times of trouble.

**Special Abilities:** None; no magic or psionics.

**Skills of Note:** Radio: Basic, Detect Ambush, Literacy, Math: Basic, Streetwise, W.P. Energy Pistol and W.P. Sword.

**Demeanor:** Mister Money is dominated by greed and greed alone. He will scheme, deal and cheat as much as possible, and even betray those he gets close to, if it means increasing his own wealth or saving his skin. His goals are slightly hazy: he has a vague dream of one day escaping to a tropical paradise where he will relax on a beach draped with beautiful human women (he keeps the post card that gave him this dream on him at all times), but in the meantime he is content to continue administrating the rough system that holds together "his" town.

**Note:** A network of thieves and mercenaries are under his employ. They serve as spies, protectors and henchmen. Meanwhile, Mr. Money has many "friends and connections" with Roadgangers, bandits and other **low-lifes**. He is generally respected or feared by the majority of people who live in and visit Trade Town.

## **New Brisbane**

**Orientation & Disposition:** Open but cautious (grew from Tight Bonds & Strong Family Ties).

**General Type & Size:** Major Outback Town (on the large side), surrounded by two dozen interdependent average Outback towns.

**A. Weapons and Armor:** 4. Firearms in New Brisbane, but only 2. Limited or 3. Good in most of the small towns around it.

**B. Medicine:** 5. Excellent; but only the basics in the small towns.

**C. Water:** 4. Plentiful for all the New Brisbane communities.

**D. Agriculture and Natural Resources:** 4. Good for all.

**E. Real Estate:** 3. Fine for most everybody.

**F. Vehicles:** 4. Average; Very Basic to Average at the surrounding communities.

**G. Administration:** 5. Strong Structure for most communities.

**H. Alignment:** 5. Scrupulous and Unprincipled, overall.

**I. Magic:** 2. Vague Understanding, overall.

**J. Racial Tolerance:** 4. Tolerant, overall, although a few of the small neighboring towns range from Disapproving and Suspicious to Extremely High Tolerance.

**K. Trade:** 2. Internal; all the communities of the Brisbane Collective trade with one another constantly.

**L. Threats:** 3. Moderately Dangerous, overall — 2. Dangerous in the surrounding wilderness.

**M. Skill Level:** 2. Average, with several professionals. Lower in some places.

**N. Shelter:** 4. Excellent at New Brisbane itself, but 3. Good at most of the surrounding suburbs.

**O. Security:** 4. Standing Army, **Sheriff/Police** and Militia at New Brisbane; Volunteer Militia to None among the surrounding communities.

**P. Power:** 5. Good: Mixed, with Hydro-electric power, windmills, solar and other energy sources at New Brisbane; numbers 2 or 3 at most of the suburbs; only 20% have #5. Good.

**Q. Special Features of Note:** Pre-Rifts city ruins (**x3**), Garage (**x2**), Hydroponics, Cellars, Processing Plant, Limited Computers.

This town is founded on the ruins of the old capital of Queensland, the shattered **pre-Rifts** city of Brisbane. The establishment of New **Brisbane** was an obvious step to take for survivors trying to cling to their past heritage. After about 50 years of the Dark Ages, the descendants of the survivors started to construct another city from the wreckage of the old. Many people flocked from the surrounding regions, clinging to a name they could remember from before the Apocalypse.

Thus, New Brisbane is a rag-tag and somewhat overtaxed, major town (although its citizens call it a city) that is well over two centuries old. It has seen many troubling times and has almost collapsed on several occasions, but has managed to survive. Even so, it still struggles from day to day with problems that range from supernatural menaces to power and food shortages. The buildings that make up the heart of the post-Apocalyptic community are fallen pre-Rifts skyscrapers that have been salvaged and used to rebuild modest homes, buildings and fortifications. Of course, a few condemned skyscrapers remain standing in mute testament to a bygone era, and several protrude from the surrounding waters.

The Brisbane River, swollen and twisted, cuts many islands through the old city region before reaching the sea. These two dozen islands are friendly, neighboring communities not unlike the suburbs of old. They are linked together with new concrete bridges and ferry boats. The result is a peculiar town that is built over the surface of the river, and completely linked together by roads and pathways. These outlying towns and villages rely heavily on the strength and survival of New Brisbane, and if Brisbane falls, they are likely to follow quickly behind it.

The technology level is only just into the industrial age, perhaps equal to the 1920's, with combustion and steam engines, and comparatively primitive, bulky machines and basic electrical systems being the norm. One or two depleted nuclear power cells remain, stored for study, ready for the day when the technology to put them to use is rediscovered. **Similarly**, microchips and computer technology are quite primitive, existing mainly as salvaged trinkets and jury-rigged, pre-Rifts modules. The awfreness of technology is quite high, but its presence is quite low. The main problem comes from the fact that Brisbane is a long way from Perth or Melbourne, the two cities that are the pinnacles of high technology and advanced, pre-Rifts styled civilization. The people of Brisbane are (wisely) afraid to make contact with the Cities, and, in all likelihood, they never will.

The democratic government of New Brisbane is a small body of elected men and women who do their best to maintain a free and equitable society and enforce the law. There is a standing militia and police force, a fire department, a hospital system with two hospitals, and various other attributes common to large cities. The current ruling Prime Minister of New Brisbane is a human woman named Celeste Hopkins. She is a dedicated, middle-aged person who is popular with the people and a capable leader. All the surrounding suburb communities (with populations ranging from 800 to 2,500) have similar governments and structure, although some are more open or closed and stodgy than others, and most have minimal defenses, medicine or technology, relying on the "big city" for help. New Brisbane's hospital and defense force services the entire greater metropolitan area.

The total population of the Brisbane region is around 78,000, with New Brisbane representing approximately 39,000 all by itself. All the suburban neighborhoods and small, autonomous communities have strong friendly ties to New Brisbane and each other, so there is constant trade, assistance and communication, creating a sense of unity and a close-knit feeling among all the residents. In fact, outsiders consider them all to be part of the sprawling New Brisbane, and don't bother with making any distinctions between the little neighboring towns and the big city proper.

## Victoria Haven

**Orientation & Disposition:** Open but cautious (grew from Aggressive and Hostile).

**General Type & Size:** Unique. More than a Major Outback Town, Victoria Haven is an actual growing city.

**A. Weapons and Armor:** 5. Advanced.

**B. Medicine:** 5. Excellent.

**C. Water:** 5. Excellent.

**D. Agriculture and Natural Resources:** 4. Good.

**E. Real Estate:** 3. Fine.

**F. Vehicles:** 5. Good to Excellent.

**G. Administration:** 4. Good, Sound Structure.

**H. Alignment:** 5. Scrupulous and Unprincipled, overall.

**L. Magic:** 2. Vague Understanding.

**J. Racial Tolerance:** 4. Tolerant.

**K. Trade:** 6. City Trader.

**L. Threats:** 3. Moderately Dangerous, mainly from political intrigue and unrest.

**M. Skill Level of Community Overall:** 2. Average, with many skilled professionals.

**N. Shelter:** 4. Excellent.

**O. Security:** 4. Standing Army.

**P. Power:** 6. Excellent: Mixed, one of the benefits of their strong ties to the technological juggernaut, Melbourne.

**Q. Special Features of Note:** Garages, Communications Suite, Manufacturing Plant (x3), Limited Computers, Landing Strip, Harbor, Old M.D.C. ruins (x2), Pre-Rifts Underground Complex, and rather than a supernatural ally, it has a super-technological ally.

Victoria Haven is the largest of the dozens of **Outbacker-style** communities that fill the countryside around Melbourne Bay. In actuality, the town is built on some remaining wreckage from Melbourne itself. When the majority of the city was broken away, large areas of the outskirts sunk under the waves and were destroyed. Only a tiny part remained on the mainland. That small area, an **old** industrial zone, became a focal point for people to gather at when the surviving portion of the city became an isolated, island fortress-city, and the Administration instituted its "closed door" policy. With nowhere else to go, survivors began to build a community out of the rubble on the mainland. The result today is Victoria Haven, a large, thriving town that is in a very odd political position. Ironically, over the generations, **Victoria** Haven has established close ties and strong trade with the city of Melbourne.

Victoria Haven is very much like *Trade Town* in that it is a center of commerce, and considered to be on the "edge of technology" because of its ties to Melbourne. This relationship

makes the town something of a bridge between two worlds — the haves and have nots, and the primitive and technologically advanced. As a link to the high-tech city of Melbourne, the town is constantly caught in the middle. **Danny Winters** and his **Missing Link Trading Company** performs many of their operations out of this area, and the Melbourne City government does 80% of its "Gap" relations through the Victoria Haven's governors. Because of the relatively intimate relationship Haven has with the Tech-City, and with the amount of trade between the two, they are under constant pressure from surrounding Outbackers to supply more "tech" wares **and/or** to give them information about the technological wonder that is Melbourne. This pressure often forces Victoria Haven to make demands on Melbourne it wouldn't otherwise. Likewise, the government of, and mercenaries, adventurers and free agents at Victoria Haven have worked with or allowed Melbourne's aggressive and oppressive military to spy upon, manipulate and crush troublesome Outbackers, "savages," dangerous criminal operations, terrorists and monsters. On more than a few occasions, Victoria Haven, itself, has been subject to military-style raids and inquisitions for their involvement or culpability and dealings with hostile Outback savages, criminals and other enemies of Melbourne.

Melbourne treats Victoria Haven like a stepping stone. They happily walk on her good people to get what they want and to protect their borders. The government and military uses it as the staging ground for many covert operations and sees Victoria Haven as the springboard to instigating its **EHRA** policy of uniting the southeastern coastline under one puritan government. Like all such relations between the two classes of people (City and Gap), it is a love-hate relationship. The only difference is that Victoria Haven has a foot in the political door that may one day see the walls of the city encircle and embrace it, and the paranoia of the City Military give way to some degree of acceptance of the newly awakened world outside. However, as things stand currently, approx. **P.A. 105**, the relationship is a bitter one, and a **short**, bloody coup of Victoria Haven seems more likely than a peace agreement. Trade remains strong and mutual cooperation teeter-totter back and forth, but always under the shadow of heavy mistrust and military abuse.

The city of Victoria Haven itself is a busy, pleasant affair with an astonishing population of 120,000 humans, mutants and D-bees (mostly human-looking ones). It has evolved to the point where small businesses have sprung up, and the technology level is into the computer age of the 20th Century. Though the streets are not sealed and the patchwork architecture serves to remind that the town is still a struggling bush community, it is the largest in the Rim and one of the largest in all of Rifts Australia. A dozen, comparatively tiny towns with populations of 800 to 3000 dot the surrounding 100 mile (160 km) radius around Victoria Haven.

The government is a democratic republican body, and the current President is a middle-aged human man named **Bruce Callaghan**. He is earnest and hard working, and dearly wants to see his town **thrive**, but his popularity is currently down because he can never possibly live up to the expectations of the people. He is constantly being undermined by corruption and the selfish aims of those that work for him as they cut deals of their own.

## **Daniel Winters,** **Head of Missing Link Inc.**

Danny Winters is a fast talking, slick businessman from the surrounding townships that line the Bay of Melbourne city. For an **Outbacker** native, he has style, business smarts and a cunning that has seen him become the premier Gap-City negotiator for Melbourne. He owns and runs a company called Missing Link Inc., a small trading group whose slogan is "We fill the Gaps."

Melbourne has struck up a policy with Danny that assures he will have prime choice over trading agreements, and if goods have to be run, they approach him first. The thing that makes Danny so trustworthy and reliable in Melbourne's eyes is that he has been perfectly honest with them, and has never once passed a bribe or tried to smuggle away more than his contract stipulated. This has made him rich, as well as highly favored with the City. Most Outbackers, and even some of the ones who work under him, see Danny as a traitor who has been "kissing up" to the Melbourne dealers since the day he started running his trade operation. Raiders, smugglers, crooks, and many wilderness people hate Danny and consider him a thorn in their side. Unfortunately, because he is so "connected," and as long as his trade deals are so lucrative, they can't get as high a price as they feel they deserve for their wares.

Danny has been faithful to his word all along. He is clean as a whisper and fully intends to stay that way. But he is slightly naive and more than a little bit ruthless. The Administration has been taking advantage of him for years, making him promises they'll never keep of citizenship and unlimited protection. Danny keeps working faithfully as a trader, **negotiator**, businessman and diplomat under the impression that he will one day be able to retire inside the walls.

Missing Link Inc. is a successful business. At present, it has over 100 employees, seven of which are helicopter pilots, more than 50 are guards, and five are technicians/Operators. The company also has in its inventory five Raincloud transport choppers, and two large M.D.C. barges for moving bulk goods, anything else is rented. The operation itself has no permanent office, but has warehouses in six different locations along the coastline. The employees live in their own **homes**, wherever they may be, and work in 2 day shifts on location at the warehouses along the edge of the Melbourne bay. The City has one spy in the organization — a deep cover agent, a Special Operations soldier — who has been there for three years and has yet to uncover anything worthy of reporting.

Danny himself lives out of the back of an M.D.C. truck with his son, Robert Winters. The boy is now 12, and Danny dreams of bringing him up inside the walls of the City, and giving him tertiary education in Administration schools. So far, Robert has proven to be a happy child who likes to be with his father, and may end up taking over the business if all goes well. On the surface, Robert is intrigued by what little he has seen of the city on business trips with his father, but deep down his loyalties are with the people of the Outback, and in the future he may even try to wake his father up to the truth of the Administration's injustice.

Danny Winters always accompanies any "runs" his company makes to Melbourne. While he works with four other professional negotiators, Danny deals with the merchants inside, and the **government** is reluctant to deal with anyone except Winters.

## Danny Winters NPC

**Alignment:** Unprincipled (with leanings toward Aberrant)

**Hit Points:** 68, **S.D.C.:** 28

**Weight:** 172 lbs (77.4 kg); **Height:** 6 feet (1.83 m)

**Species:** 100% Human

**P.P.E.:** 11; **I.S.P.:** None

**Attributes:** I.Q. 19, M.E. 9, M.A. 21, P.S. 12, P.P. 13, P.E. 14, P.B. 18, Spd. 14.

**Disposition:** Daniel Winters is a pleasant man with a simple charm and polite manner. He treats everyone he meets well, and is a good leader. He can be commanding when he needs to be, but he always leads through charisma.

**Experience Level:** 9th level Merchant Trader

**Magic Knowledge:** None

**Psionic Powers:** None

**Combat Skills:** Hand to Hand: Basic

**Attacks Per Melee/Combat Bonuses:** Six; equal to 9th level basic training, plus W.P. Energy Pistol, W.P. Automatic Pistol.

**Weapons and Armor:** Anti-Assassin M.D.C. vest worn at all times. In high risk situations, **Danny** wears a full flak suit with a helmet. He also has access to **Base-4** S.D.C. armored clothing. He carries with him a 9mm conventional S.D.C. pistol and a "Popper" high energy derringer.

**Bionics and Cybernetics:** Clock calendar only.

**Money:** Access to about \$32,000 in personal funds, and about \$2,000,000 in business stock.

**Skills of Note:** Radio: Basic, Dancing, Basic Electronics, Intelligence, City Intelligence, First Aid, Computer Operation, Basic Mathematics, Read Sensory Equipment, Literacy, Art, and Product Evaluation (special skill, used to determine the value of produce and goods traded - 78%).

**Description:** At 31 years of age, Danny is still a handsome, slim man with dark hair and fair features. His build is quite average, and while he tries to keep fit, he is always too busy to exercise. He has an active and busy mind, which shows in his eyes and the rapid way in which he speaks and takes action. Danny has a voice for every occasion, and can change his tone to suit any situation. Although basically a good person, he has allowed himself to be blinded by the promises from the Melbourne government and to their injustices and evil, manipulating ways. He is a willing pawn of a dangerous and dark force.

## Missing Link Inc Statistics

Number of Employees Total 130

Negotiators 5	Military/Combat 54
Helicopter Pilots 7	General Staff 40
Ship Pilots 4	Exterior Contacts 232
Technical Support 20	Melbourne Contacts 3

Current & Primary Trade Items: Wool, Lumber, Sand, Iron Ore, Bauxite Ore, Wheat, Cotton, Honey, Sugar, Medicine, Processed Foods, Sheet Glass, Engine Oil, Clothes, Textiles.

Zone Covered: Missing Link has contacts as far north as the old Sydney zone, and as far west as the old Adelaide sector. These contacts trade their wares for the city-based products Missing Link can offer from Melbourne.

Current Wealth: \$45+ million

Annual Income: \$3.5 million



## Point Clare

**Orientation & Disposition:** Open but cautious (grew from Tight Bonds).

**General Type & Size:** Average Outback Town.

**A. Weapons and Armor:** 3. Good.

**B. Medicine:** 3. Good.

**C. Water:** 5. Excellent; fresh water is plentiful.

**D. Agriculture and Natural Resources:** 4. Good.

**E. Real Estate:** 3. Fine.

**F. Vehicles:** 3. Very Basic, mostly live animals and boats.

**G. Administration:** 5. Strong Structure.

**H. Alignment:** 5. Scrupulous and Unprincipled.

**I. Magic:** 2. Vague Understanding.

**J. Racial Tolerance:** 5. Extremely High Tolerance.

**K. Trade:** 2. Internal.

**L. Threats:** 3. Moderately Dangerous.



**M. Skill Level of Community Overall:** 2. Average.

**N. Shelter:** 3. Good.

**O. Security:** 3. Sheriff and Militia.

**P. Power:** 4. Good, Hydro-electric.

**Q. Special Features of Note:** Large advanced **Garage/Dry Dock** designed for the repair and maintenance of boats, Hydroponics, Limited Computers, and a Harbor.

Point Clare is situated about 100 miles (160 km) north of the Sydney metropolis ruins, on a peninsula protected from the ocean by a series of intersecting headlands. The surrounding lands are a tumbled wilderness of thick bushlands and even rain-forests. The generally hilly country is free from much human habitation except for the isolated Point Clare itself, and the occasional Outbacker, traveler or raiding band. However, the surrounding wilderness is teeming with wildlife, including monsters and marauding demons. Outbacker visitors to Point Clare are welcome, but uncommon. Player Characters passing through the town will find it to be a good rest stop to repair, heal, resupply, find work and make friends.

Point Clare was a popular refugee point during the dark ages, but has since been driven into isolation by the wilds and lack of transport and communications. Most people don't know that Point Clare exists, even with its population of nearly 9,000 residents. Isolation suits the people of the Point just **fine**, because they already have enough trouble to deal with. They are a content community of farmers and workers who have built a thriving and self-sufficient town. They are fairly unremarkable as a whole, having no large militia, no high technology, no great ambitions, and no connections to other parts of the country, but at the same time they have become large and prosperous via hard work and cooperation. Rumors of this town have started to spread all along the eastern New South Wales and Victoria Rim as a haven of sorts — an ideal model for what every community could become. The Administration of Melbourne have known about its existence for decades ago, have pin pointed its location, and have kept a distant eye on it for years. Impressed by its civility and peaceful nature, the military is putting together a team to investigate the site in person. However, this is not a prelude to military invasion, but potential recruitment into the EHRA project currently under consideration. Of course, resistance to such a proposal could result in stronger methods of persuasion and lead to an armed **conflict**, although, not likely. The Point would make an ideal location for a walled encampment and naval base, making it a potential key facet in the staging of the EHRA campaign.

The leaders of the town are a married couple, Grudge and Lisa Taylor. They were elected into a governing role, as a pair, with a landslide mandate that has kept them in office for nearly a decade. Currently both in their 50's, scrupulous, and respected, they could lead for another generation or two. Their Chief of Security is a man called General Roberts. He is a soldier from a long line of military heroes. He is a handsome man in his 40's (7th level, scrupulous alignment) and spends the majority of his time training volunteer militia men and women, or drilling his small 200 person army (average 3rd level) on the odd chance that they may be needed. His enthusiasm and leadership skills have kept this army disciplined, well trained, and highly capable despite inadequate weapons and minimal equipment. Their only action so far has been defense against singular attacking entities, such as demons, and the occasional miscreant

or small roving gang who may happen upon them. Recently, some of their boats at sea have had harrowing experiences with **Horune** Pirates, but so far, no actual attacks or raids, just threatening cat and mouse games by the pirates.

Point Clare has one major asset, and that's the huge, well protected, natural harbor that it is built around. This bay, while quite shallow, could easily be modified to hold dozens of larger ships. At the moment, all it holds is a few dozen fishing boats, a number of small sail and rowboats, and a trawler or two. The Melbourne government sees this harbor as a strategic location for their fleet, should they indeed expand into the world, enabling them to bypass land travel through the Rim altogether.

Trusting and idealistic, both the Governors Taylor would probably be willing to open trade relations with the legendary city of Melbourne and seriously consider working out a deal to become a part of the "New Australian Nation" under the auspices of EHRA. Sadly, they would soon find themselves under the boot of the Melbourne Admin, with little say as to what happens to their beautiful little community. When it comes to dealings with either of the Tech-Cities, naivete is their greatest weakness.

---

## Outback O.C.C.s

---

### Australian Outback

#### Occupational Character Classes (O.C.C.s)

Australian Cowboy (see Runabout & Jackaroo)

Bushman O.C.C.

Bushranger (criminal) O.C.C.

Guide or Wilderness Scout O.C.C.

Jackaroo O.C.C.

Merchant Trader O.C.C.

City Trader O.C.C. & NPC Villain

Runabout O.C.C.

**Raider/Bandit** O.C.C.

**Roadganger** O.C.C.

Road Sentinel O.C.C.

Sham-Man a.k.a. False Sorcerer O.C.C.

**Songjuicer** O.C.C.

**Note:** Also see City O.C.C.s and R.C.C.S

---

## Bushman O.C.C.

Bushmen are not **Aborigines**, but as wild as white **can** become. They are beyond Jackaroos, as they are almost Aboriginal themselves in the way they have embraced the wild as their home. Unlike the Aboriginal people, however, the Bushmen are not quiet, gentle individuals at peace with their world, but typically are quite fearsome individuals, hardened by their experiences and what they have seen in the Outback. Sometimes they are referred to as having "gone bush," in other words, slightly loony for **their** love of the wild and hard, often lonely lifestyle. Conversely, there are happy-go-lucky and civilized Bushmen

who will still disappear for months on end, but return to their roots in civilization because they miss their **friends** and family.

A Bushman is a bit of an enigma. People do what they can to survive these days, clinging to each other for support. No one knows what gives a guy the courage to face the world alone, especially the hostile and unpredictable Australian wilderness. No one truly understands what makes someone so obsessed with the wild, aside from the Bushman himself. Even so, Bushmen make valuable members of adventurer groups and Outback communities in a strange sort of way — they are ferocious warriors, excellent liaisons with the local Aboriginal tribes and perfect early warning scouts of incoming danger.

Bushmen are never happier than when they are alone and free to do as they please and survive by **their** wits. Yet, most are not antisocial and operate well with others when need be. When travelling or adventuring with a group, most are reliable and trustworthy, but more often than not, they keep a physical distance from a group so as to not get caught with them in an ambush, to scout ahead, to guard the rear or flanks, hunt, and so on. Unlike a Jackaroo, who is more social and flippant, the Bushman is a gritty individual who takes his life and work *very* seriously. The character will feel totally out of place in a city and finds them noisy, confusing, confining, hostile and unpredictable. Furthermore, many don't have experience with modern amenities such as electric light, flush toilets, electronics, high-technology or even soft **beds**, and are often a bit **techno-phobic**. Nor do they trust City-Goers, Roadgangers, or

so-called "civilized" men from large towns or high tech societies. Bushmen are glad to leave bustling cities and large towns, and can't imagine anything better than living in the bush from now until the day they die.

## Different types of Bushmen:

The first is the Explorer. He has found purpose in skills and knowledge beyond fighting and survival. He (or she) is a natural born explorer and loves to probe deeper into the uncharted wilderness and go where few, if any, have gone before — and there is a lot of uncharted wilderness in Australia, and many secrets to unearth. When the character does stumble onto a **community**, he stays long enough to trade for some supplies in return for what he has learned (he understands that there is no point learning if it is not recorded), before strapping his world to his back and pressing on. Explorers make ideal Player Characters, because their motivation is simply to keep seeing new things, learning and discovering new truths.

The second is the Desert Bushman or Nomad. Australia has a lot of desert, dry grasslands and open scrubland. Unfortunately, a lot of it has been made unsafe by the marauding gangs and misanthropes who roam the wastes, stopping to loot communities for gasoline and supplies before pressing onwards. Then there are the multitudes of predators, D-Bees, monsters and demons who seem all too willing to prey upon humans. The Road-Sentinels, lone drivers who have taken it upon themselves to act as marshals and avengers for whatever cause they choose,



are perhaps the last line of defense against the gangs and monsters — other than the Desert Bushman. For reasons all his own, the Desert Nomad has chosen, not the bush, but the deserts as his home. Maybe something about them fascinates him, or maybe it's just where he was born. Maybe he's the last member of a dead gang, or an avenging **angel**, ... or... nobody knows. In any case, he has learned to survive where few humanoids can. Strong, silent, maybe slightly bitter and definitely the only hope anyone would have of traversing the deserts alive, Nomads are few and far between. They rarely call any one community home, but occasionally will drift into towns, but only in passing, like the **gunslingers** of the American West.

The "**classic**" or **standard Bushman** represents the majority of those that have decided to "go bush," .e. have taken this O.C.C. These Bushmen, while being very closely connected with the land, fiercely independent and lone wolves, still hold a little bit of their humor and an appreciation for people. They like human company, but their tolerance level is very low for those who don't show understanding or compassion for human life, the wilderness, or the Bushman's art. Actually, they have a low threshold for bull crap in general. Those who embrace technology have to work hard to win a Bushman's respect, as they are seen as fools dependent upon machines and energy. Hard working Jackaroos, Outbacker Runabouts, Wilderness Scouts and Aboriginals form the bulk of the Bushman's friends. Adventurers of all ilk (any O.C.C.) who show compassion, courage and heroics will also win a **Bushman's** favor, but even well meaning **friends** and allies can become trying, and the Bushman finds himself putting some distance between them **and/or**enjoying going off on short jaunts on his own. The classic Bushman will sometimes have a **retreat/lair/hideout** or special place out in the bush where he can escape, be alone and simply be one with the land.

### Special Abilities of the Bushman O.C.C.

**1. Iron Will:** Their mind and character have been toughened by their experiences. Add +1D4 to M.E., +1 to save vs mind control and illusions, +3 to saves vs disease, poison and pain, and +1 to save vs Horror Factor at levels 1, 3, 5, 6, 8, 10, 12 and 15.

**2. Internal Compass:** Bushmen, especially Nomads who wander the deserts, have very few landmarks to identify their passage with, and leaving a noticeable trail can spell doom. Consequently, they have learned to simply "feel" or sense the correct direction to take. They rarely get lost as they can detect north and determine which direction to walk through instinct and subconscious recognition of insignificant telltale signs.

**Base Skill:** 60% +3% per level of experience (+10% for Desert Nomads).

**3. Memory for Details:** Bushmen, Explorers in particular, soak in a lot of information during their travels. Whether they record it in drawings, notepads or voice recordings is irrelevant, because they always keep it in their heads. Whenever the character enters a new region, he makes notes of the terrain, wildlife, vegetation and fine details. These things are automatically committed to memory and filed away in the back of his mind. **Base Skill:** 60%/30% +3% per level of experience (the second skill/number is +20% for the Bushman Explorer). The first number indicates his ability to recall things and retell stories, finds and directions accurately. The second is his ability to recognize

elements from past experiences that will give him rudimentary information (based on commonality and nature) about the area; such as where a community is most likely to have settled (if any), and what type of people they may be (i.e. Aboriginal, road gang, nomadic clan, a particular race, etc.), likely predators and demons, common land formations, plants or features likely in a particular type of environment, the location **and/or** likelihood of lakes, rivers, ponds, underground springs, and so forth. The information is not detailed, but certainly *very* useful.

**4. Instinctive, Minor Psionics:** All Bushmen, regardless of specific O.C.C. types, develop minor psionic powers due to their closeness with nature, focused minds and strong wills. All Bushmen are considered minor psionics and have a number of **I.S.P.** equal to their M.E., with an extra 1D6 per level (except the "Classic" Bushman, who gets a bonus of 2D6+6 I.S.P. at levels 2, 6, and 12). Although the Bushman recognizes and appreciates his "instincts," he doesn't for a moment consider himself a psychic! Instead, he considers the abilities to be "Old Bushman tricks."

Psionic powers are limited to the following: Summon Inner Strength, Resist Thirst, Empathy (but *only* with animals) and the Super Psionic power of Hypnotic Suggestion (but again, *only* works on natural, normal animals). At third level, the "Classic" Bushman also gets Sixth Sense and one sensitive or physical power of choice.

**5. Special O.C.C. Bonuses:** Also see the bonuses listed under #1, Iron Will.

+2D6+20 to physical S.D.C.

+1D6 to P.S.

+1D4 to P.E.

+3 to pull punch

+2 on initiative

### Bushman O.C.C.

**Also known as Bush Explorer, Desert Nomad and Buckaroo.**

**Alignment:** Any.

**O.C.C. Requirements:** P.E. 12, M.E. 10 or higher. A high I.Q., P.S. and P.P. are also helpful but not a requirement.

**O.C.C. Skills:**

Speaks **Australian/English** at 90% (70%+ are illiterate).

Blend (+15%)

Outback Survival (+20%)

Lore: Dreamtime Culture (+15%)

Lore: Demons and Monsters (+15%)

Land Navigation (+20%)

Detect Ambush (+5%)

Tracking (+10%)

Identify Plants (+10%)

Skin and Prepare Animal Hides (+10%)

Cook (+5%)

Art (+10%; mainly drawing)

First Aid (+10%)

Climbing (+10%)

General Athletics

Swimming (+10%)

W.P. Bolt-Action or Automatic Rifle (choose one)

W.P. Knife

W.P. Boomerang

W.P. two of choice (any).

Hand to Hand: Basic

Hand to Hand: Basic can be changed to Expert at the cost of one O.C.C. Related **skill**, or to Martial Arts for three "other" skills. No Bushman may learn Assassin, except for the Nomad at the cost of two other skill selections.

Note: Skills are relative. For instance, Blend, Outback Survival and Identify Plants in particular are relative between the Nomad and the other two types of Bushman. Although the skill descriptions do not mention as much, the G.M. would be wise to apply penalties to a Desert Nomad making a Survival roll in the bush and vice versa; a penalty of -25% is appropriate. Also, for the Desert Nomad only, Blend applies to the desert instead of the bush.

**O.C.C. Related Skills:** Select two Wilderness or Espionage skills and three other skills. Select one additional skill at levels 2, 5, 8 and 11. New skills start at the first level of proficiency.

Communication: Radio: Basic only.

Cowboy: None

Domestic: Any (+10%)

Electrical: Basic only.

Espionage: Any (+5%), except Forgery.

Mechanical: Automotive only.

Medical: Holistic Medicine only (+5%).

Military: Camouflage (+15%) and Trap Construction (+6%), only.

Physical: Any (+10%), except Gymnastics and Acrobatics.

Pilot: Any, except military vehicles, Power Armor, 'Bots, and Ships.

Pilot Related: Any

Rogue: Any, except Computer Hacking and Streetwise.

Science: Any (+2%)

Technical: Any (+5%), except Computer Programming.

W.P.: Any

Wilderness: Any (+10%)

**Secondary Skills:** Also select three secondary skills from the previous list. They are limited as above, but do not receive any of the bonuses listed in parentheses. These are additional areas of knowledge and start at the first level of proficiency.

**Standard Equipment:** The Bushman and Bushman Explorer will be wearing a very rugged set of clothing: fatigues, usually ex-military, solid boots and a full brim hat. The character will also wear either a utility belt or gear webbing. They tend to avoid too much excess on the clothing. Almost everything the character owns will be stored in one good, solid, hiker-style backpack; a bedroll, billy, fire starter, snakebite kit, basic first-aid equipment, painkillers, a spoon, small mallet, ball of twine, six small metal pikes or wooden **stakes**, a roll of aluminum foil and a large roll of plastic and other survival pieces the player can think of. The character may also have a pair of conventional binoculars or a telescope, a compass and a **laser**.

In the way of weapons, *a//* Bushmen will carry a large knife **and/or** machete, 1D4+1 boomerangs, wooden or silver cross, 2D4 wooden stakes and a mallet, an S.D.C. Rifle with 2D6x10 bullets or 1D4+3 extra clips of ammo (this rifle is likely to have a flash suppressor, but not a telescopic sight), and one M.D. weapon of choice and one other weapon reflective **of a** W.P.

Nomads tend to dress a little differently, but carry the same gear. They will wear a full body covering; sand colored

robes - light cotton, complete with a hood and face mask. They will have lighter shoes and wear a pair of silt goggles.

**Mode of Transportation:** Foot power. Most Bushmen avoid vehicles and even riding animals. However, they will hitch a ride when on a long journey, traveling roads or in or around a town.

**Money:** The character starts with 1D6 x \$100 in cash.

**Cybernetics:** None. The character is probably strongly against cybernetics, both for ethical and practical reasons.

## Bushranger O.C.C.

Put simply, and despite the lofty sounding name, the Bushranger is a criminal. The tradition of the Bushrangers started way back before the Apocalypse when Australia was first settled. The entire country was originally a penal colony, and so it was only natural that criminal activity and gangsters sprung up. Unlike the organized crime syndicates that appeared in America, Europe and Asia, the Bushrangers were lone agents or worked in small groups of 3-10 men. They held up stagecoaches and banks, and raided trading posts, mining camps, towns, and wealthy estates for valuables, money, luxury foods and other pleasures. The Bushrangers of Rifts Australia are no different and no better; if anything, they are even bolder than their ancient ancestors.

The Bushranger movement all but disappeared as the country became more civilized, and organized crime took over where they left off. But after the Apocalypse, Rifts Australia was reset to its early days. Organized crime, raiders and gangs blossomed in the devastated and low-tech wilderness, and the Bushrangers reappeared with a vengeance.

The Bushranger is perhaps best summed up by the immortal words spoken by Ned Kelly, the country's most famous Bushranger, moments before he was hung for his crimes, "Such is life." Even though he faced death, he was casual about his existence and accepted his plight. All Bushrangers live very much for the moment. Instant **gratification**, fun and pleasure are the name of their game. They are not foolish or careless, quite the opposite, they are very sensible and serious about what they do, but they accept the danger and the illegal nature of their activities, and so treat life every day as it comes. They rarely plan out their crimes in advance, nor engage in very elaborate schemes; they will, instead, make quick decisive choices and engage in lightning quick raids whenever the opportunity presents itself. Spontaneous in the extreme, some Bushrangers believe making plans simply takes too much time and thought.

Some Outback communities regard the Bushrangers as criminal vermin, while many have mixed feelings about them. Sometimes they are heroic figures who use their skills to help those in need by robbing the rich and giving to the poor, or by battling **Roadgangsters** or fighting monsters. Other times they are nothing more than thieves and often very base criminals who rob, pillage, rape and kill for their own profit or pleasure. Some bushrangers go so far as to attack City-based convoys or transports. They are not professional enough to break into the walled cities (that's the Raider's specialty), but they are almost always well trained and equipped warriors, capable of downing a helicopter or scuttling a ship to get its cargo. As a rule, they use hit and run guerilla tactics and almost always take refuge in the wild, ap-



peering only for moments to swoop in, perform their dirty deed, and disappear again. Their main strength lies in mobility, quick precision strikes, and surprise attacks, using unpredictability, obscurity, distractions and disguises as part of their bag of tricks. One of the romantic elements about the Bushrangers is that they conceal their true identities and may lead double lives as criminals and (seemingly) ordinary citizens. Another is that most can be daring swashbucklers who may choose to defend the honor of a lady, protect a child, or help a downtrodden town. Ned Kelly and Captain Thunderbolt are examples of Bushrangers who became cult figures, popular despite their nefarious ways.

### Special Abilities of the Bushranger

**1. Special Area of Expertise:** A Bushranger always has a distinguishing feature or ability that makes him the unique figure that he is. Quite often they will build their reputation on this. When the character is created, the player must choose one of the following benefits:

- **Extra Tough:** Simply, the character feels little pain and is famous for his ability to take a slug and keep on kicking. Add 1D4x10+20 physical S.D.C.!
- **Gunman:** A dead eye shot with *revolvers and rifles* of all kinds. The character either gets an extra melee attack when using one of those two particular types of weapons (does not include automatic or energy "pistols"), suffers no penalties when shooting while moving (i.e. running, riding, driving), and is +1 to strike in all modern weapon modes of attack (Aim, Burst, Wild) with revolvers and rifles — or, if the G.M. allows it, he can use the *Gunfighter's* W.P. Paired Weapon: Revolvers, W.P. **Sharpshooting:** Revolvers and Rifles, and Quick Draw Initiative: Revolvers & Rifles as described on page 91 of *Rifts*® New West™.
- **Horseman:** Horseman refers to a Bushranger who is a masterful rider with the Horsemanship: Cowboy skill, and one additional piloting skill of choice (+15%; typically motorcycle or hovercycle). In addition, the character is +2 on initiative and +1 to dodge when **using/riding** that particular vehicle/animal.
- **Survivalist:** The Bushranger can disappear into the wild for days and weeks on end. Add the skills Nature Lore, Blend, and Trap/Mine Detection, each with a +15% skill bonus. Also add +5% to the Outback Survival skill.
- **East:** The character has amazing reflexes and is speedy in all things. Add +3 to initiative, +1 to P.P. and +3D6 to Spd.
- **Expert Boxman:** "Boxman," is slang for safecracker. Gets the skills Mechanical Engineer, Locksmith, Demolitions and Demolitions Disposal each at +15% and his Pick Locks skill gets an additional +5%.

**Safecracking Skill (special):** This is a specialized skill in which the character studies the strengths, weaknesses, and construction of safes and how to open them without damaging the contents inside. The fingers of the safecracker are so sensitive that they can "feel" the subtle calibration of combination locks and other locking mechanisms. When using explosives, they can use their abilities to such precision that they can "blow" the lock off a safe, security door, safe deposit box and similar without creating a big, area affect explosion or inflicting damage to the contents (a failed safecracking skill or demolitions roll means the explosion was too much and the contents are damaged).

**Base Skill:** 20+4% per level of experience. **Penalties:** Requires focus, concentration and keen hearing, characters with a M.E. under 15 are -10% on this skill.

- **Charmer:** Famous for his glib tongue, sense of humor, and suave and debonair ways especially with the opposite sex. Add 1D6 to P.B. and M.A. plus gets the Rogue skill of Seduction (+30%); also adds +5% to disguise and impersonate skills if applicable.
- **Impersonator:** A master of disguise who gets the skills imitate voices/impersonation, art and disguise at +25%.
- **Psionic:** Roll percentile dice. 01-50% means the Bushranger is a minor psionic, 51-00 means he's a major psychic! Select the appropriate number of skills for each category (see the **Rifts® RPG**, page 12, for details).

**2. Special O.C.C. Bonuses:** +2 to roll with punch, fall or impact.

### **Bushranger O.C.C.**

**Sometimes known as** a Highway-Man and other criminal distinctions; all are highly skilled professional criminals.

**O.C.C. Requirements:** I.Q. 8 or more, M.E., M.A., and P.E. of 10.

**Alignment:** Can be of any alignment, but most tend towards Selfish and Evil alignments; Anarchist in **particular**.

**Base S.D.C.:** 4D6

#### **O.C.C. Skills:**

- Speaks Australian at 90%
- Basic Math (+20%)
- Radio: Basic (+5%)
- Detect Ambush (+10%)
- Detect Concealment (+10%)
- Outback Survival (+15%)
- Land Navigation (+5%)
- General Athletics
- Climbing or Prowl (+10%)
- Pilot: Motorcycle or Hover Vehicle of choice (+10%)
- Horsemanship: Basic (+5%)
- Pick Locks (+10%)
- W.P. Blunt
- W.P. Knife or Sword
- W.P. Revolver or Pistol
- W.P. Energy Pistol
- W.P. Automatic Rifle or Energy Rifle
- Hand to Hand: Expert to start, but can be changed to Hand to Hand: Martial Arts (or Assassin if evil) for the cost of one O.C.C. Related skill.

**O.C.C. Related Skills:** Select **five** other skills. Select two additional skills at levels two and four, and one additional skill at levels 6, 9, 12 and 15. New skills start at the first level of proficiency.

- Communication: Any (+5%)
- Cowboy: None
- Domestic: Any
- Electrical: Basic only
- Espionage: Any (+5%)
- Mechanical: Any (+5%), except Robot or Aircraft
- Medical: Brewing and Paramedic only (+5%)
- Military: Any (+5%)
- Physical: Any, except Acrobatics and Gymnastics.
- Pilot: Any (+5%), except Robot Elite and military vehicles

Pilot Related: Any

Rogue: Any (+5%)

Science: Math only.

Technical: Any (+5%), except Computer Operation and Programming

W.P.: Any

Wilderness: Any (+5%), except Use Songlines.

**Secondary Skills:** Also select two Secondary Skills from the previous list at levels 1, 3, 6, 10 and 13. They are limited by "Any, Only and None," and do not receive any of the bonuses listed in parentheses. These are additional areas of knowledge and start at the first level of proficiency.

**Standard Equipment:** Starting gear will include a suit of homespun M.D.C. armor (not fully environmental, although such superior armor may be acquired at a later time), a pair of **sidearms** (revolvers or pistols) with three full reloads for each, a rifle that's appropriate with the character's W.P. and four reloads, a survival knife, and a saber (may be a **Vibro-Blade**). The character also has 1D4+2 M.D. explosives — can be C4, satchel charges, hand grenades, light fusion blocks, etc., plus 1D4 S.D.C. explosives (does 1D6x10 S.D.C. damage) and 1D4 signal flares or smoke grenades.

The Bushranger will be wearing his body armor or a sturdy set of traveling clothes or fatigues, with a good pair of military boots; broad brim hat, tinted goggles, belts, gun holster, ammo-bandoleer and equipment webbing. Other equipment includes a first-aid kit, a snakebite kit, a fire starter, a cigarette lighter or some matches, a compass, wooden or silver cross, 2D4 wooden stakes and a mallet, a notebook or a notebook computer, a set of distancing binoculars, two canteens, backpack, sleeping roll, billy, ground blanket, air filter and face mask (scarf).

In the way of vehicles, the character starts with either a good horse, or maybe a hover cycle. Either way, it must be small and fast.

**Money:** 1D6x\$1000 in saleable items; this may be any type of valuable. The character also starts with 2D4x\$200 in dollars.

**Cybernetics:** Usually none. They're hard to find, hard to implant and hard to maintain in the Outback. Nonetheless, the player may, in the future, acquire as much as one limb replacement, with one option or weapon system in the limb **and/or** one optic or throat system and two or three implants.

## **Guide O.C.C.**

Wilderness Guides are Aborigines who walk with the white man. Rather than remain with their tribes, they have decided to live and work in the white community, offering their services and knowledge of the land. Before the Coming of the Rifts, such individuals were a dying breed. It all started hundreds of years ago when Aborigines were little more than slaves and primitive savages to the white settlers, who, whenever possible, used them as scouts and mediators. As society progressed and such practices faded, so did the position of Aboriginal Guide. Now that the Great Cataclysm has changed the world, Aboriginal Guides are commonplace again, but this time adding the roles of advisor and philosopher with their duties as scouts and **diplomats/liasons**. In fact, almost every Outback settlement and town will have one or two as part of their community. To the Outbackers, the Guides are a huge asset.



However, these days Aboriginals are the majority. In fact, living with the "white fella" is considered a sign of weakness amongst some of the tribes. All too often, an Aboriginal that has been raised in an **Outbackers'** camp will be shunned by his tribe because he has turned his back on his people and traditional ways. He may still be a traditionalist at heart, but it doesn't matter — there's no accounting for prejudice. On the other hand, there are also those who have managed to find a strange, balanced life, inducted into a tribe as a warrior, yet still able to live and associate with the "white fella" (who consider him to be a fellow Outbacker) without being thought of too poorly by other **Aboriginals**. In fact, as the calendar creeps further and further P.A. (Post Apocalypse; not a calendar the Aboriginals use), such a case is becoming more and more common, a sign of integration at the very least. A character like this may spend some nights dancing with his friends and performing tribal rituals for the **Elders**, before returning to his hut in an Outbacker camp or town to sleep before rising to do his daily duties for the community.

In any case, the Guide is a highly competent character. He can survive in the bush indefinitely, he can fight with great skill and he knows a lot about a lot of different things. Some may compare him to a Jackaroo, but his talents are a little more far reaching, with a firmer spiritual base. Still, he straddles two worlds and is not quite as capable in the bush as true Aboriginals. More distressing is that his loyalties are divided, and at some point he may be forced to choose a side.

## Aboriginal Wilderness Guide O.C.C.

### Alignment: Any

**O.C.C. Requirements:** Can be any alignment, but tend towards Scrupulous or Unprincipled and even Principled. Must have an I.Q. and M.A. attribute of at least 8. P.E. and P.P. must be 10 or more.

**Special O.C.C. Bonus:** Like the Jackaroo, they are rugged individuals and gain a +4D6+10 to their S.D.C., +1D6 to Spd, +1 to P.P., +1 on initiative, and +1 to roll with punch, fall or impact. Add these bonuses *after* requirements are met. Note: Don't forget to roll attributes and add bonuses for race described in the section on making up Aboriginal characters.

### O.C.C. Skills:

Speaks Aboriginal (+20%)

Speaks English (+15%)

Dance (+10%), or Corroboree at no bonus.

Fishing (+15%)

Play Musical Instrument: (+5%)

Lore: **Dreamtime Culture** (+15%)

Detect Ambush (+10%)

Detect Concealment (+15%)

Tracking (+15%)

Track Animals (+5%)

Outback Survival (+12%)

Land Navigation (+20%)

Holistic Medicine (+5%)

General Athletics

Prowl (+15%)

Climbing (+15%)

Swimming (+10%)

Blend (+10%)

Use (+10%)

W.P. Boomerang

W.P. Spear & Woomera

W.P. Two of choice (any, including energy weapons).

Hand to Hand: Basic to start, but can be upgraded to Expert at the cost of one O.C.C. Related skill, and to Martial Arts at the cost of three skills. This is *not* the Aboriginal martial art.

**O.C.C. Related Skills:** Select three other skills at level one and one additional skill at levels 2, 5, 8, 12 and 15. New skills start at the first level of proficiency.

Communication: Radio: Basic only.

Cowboy: Herding Cattle, Lore: Cattle and Whittling only.

Domestic: Any (+15%)

Electrical: None

Espionage: Any (+10%)

Mechanical: Basic only.

Medical: Brewing and First Aid only (+10%).

Military: **Camouflage** and **Trap/Mine** Detection only (+5%)

Physical: Any except Gymnastics.

Pilot: Any, except Robot Elite, Power Armor and military vehicles.

Pilot Related: None

Rogue: Concealment, Palming, Pick Locks & Pick Pockets only (+10%).

Science: Any

Technical: Any (+5%), except Computer Programming

W.P.: Any

Wilderness: Any (+15%)

**Secondary Skills:** Also select two secondary skills from the previous list at levels 1, 4, 8 and 12. They are limited by the categories listed, but do not receive any of the bonuses listed in parentheses. These are additional areas of knowledge and start at the first level of proficiency.

**Standard Equipment:** The Guide will have very little in the way of clothing. It is up to the player as to how the character will be outfitted. He may just wear the simple loincloth that many Aborigines wear, or he may dress like a Jackaroo or other **Outbacker** with light, homespun M.D.C. armor (never full environmental armor), boots, utility belt, backpack, canteen, and other basic odds and ends. Aside from odd pieces of equipment with personal significance - face paint, luck fetish, small silver cross, photograph of self with several Jackaroo buddies, etc., the Guide is very light on equipment, seeing little use in being weighed down when nature provides most of what you need. Even so, the Guide can see sensibility in things like snakebite drugs and binoculars.

For weapons, the character will have a boomerang and a spear. Depending on his skills, he will also have an Aboriginal **blowgun** or crossbow, and one M.D. weapon.

**Money:** The character starts with **2D6x\$100** in dollars.

**Cybernetics:** None, and will tend to avoid such unnatural additions to the body. Even in the case of prosthetics, the Guide is likely to shun them; who would be stupid enough to lose an arm in the first place?

## Jackaroo O.C.C.

The **Jackaroos** are perhaps the most quintessential of the Outback characters. They are highly skilled and therefore, have the mettle required to survive in the Outback wastes. Jackaroos are a rare breed in that they have a positive outlook. They see no problem in surviving in the outback, and they have the knowledge and the willpower to do so. Unlike the **Roadgangers** and the **Raiders**, Jackaroos have learned to adapt to the new wilderness, instead of struggling to live the way it was before the Apocalypse. They tend to stick to the wooded and grassland or scrub areas, because they see the deserts as deathtraps — waterless, foodless, and filled with bloodthirsty roadsters who would as soon cut your throat for a meal as offer you the time of day.

Jackaroos are similar to the Wilderness Scouts of North America and Europe. Most are a friendly breed who seek out a simple existence and harmony with nature and humanity alike. Like any human being, they **require** consumables like razor blades, lighter fluid, metal knives, ammunition, clothes and medicine. But instead of stealing, the Jackaroo has a multitude of services he can trade to others. Everything from finding water to scouting out enemy positions, to guiding parties through dangerous areas. He is happy to offer these services in return for some food, booze, a place to sleep, binoculars, flashlight, a clip of bullets or maybe batteries for his radio. They also love to hear and tell stories, and are usually pretty good storytellers (and gossips).

Traditionally, the term "Jackaroo" refers to the Australian equivalent of a cowboy. Jackaroos were station hands used for herding cattle and performing other farm duties. Since the Apocalypse, large-scale agriculture and animal herding has returned, but work is still difficult to come by, so the Jackaroos

evolved into a bit more of a **Jack-of-All-Trades**, at home in a town, on a ranch or in the bush. Unlike the Bushman, spending time in the wild has not removed their desire to live a civilized life. They are still station hands ("station" being the Australian term for a large ranch) who enjoy the wide open spaces, but also enjoy a hot meal, a firm bed, and a roof to sleep under, as well as M.D.C. armor, M.D. weapons and many other modern amenities.

A Jackaroo (or **Jillaroo**, the slang female counterpart) is perhaps the greatest "Jack" of all trades one is ever likely to meet. He knows how to survive in the wild, a bit about monsters and magic, enough Aboriginal lore to not get hunted down for violating sacred lands, how to herd animals, is good at fixing things and he can empathize enough with human nature to make a friend out of almost anybody. Furthermore, he knows his way around trouble, and makes a good ally in a rumble. Best of all, he love adventure and cares about people.

### Special O.C.C. Skills of the Jackaroo:

**Prospecting:** The character can recognize and evaluate precious and semi-precious metals (gold, fool's gold, silver, bronze, copper) in their natural ore appearance and as refined and polished jewelry. In addition, the character has a good idea where to look for such mineral deposits, and the fundamentals of "panning" for gold and the general knowledge of mining and how to use various types of simple mining equipment.

Furthermore, the character can identify and appraise the value of precious metals (silver, gold, etc.) and stones (diamonds, rubies, etc.), and to identify fakes, but at a penalty of -10%. A failed roll means the character cannot tell whether or not the item is fake or real, or he grossly under or overestimates its value. **Base Skill:** 20% +5% per level of experience.

**Rope Works:** This is a skill that takes into account the various needs and uses of rope. The character knows a variety of ways to tie knots, the advantages to various types of ropes and cords, their tensile strength and how to weave/make rope. A failed roll to tie a knot means that it is loose and sloppy and easy to untie, slip out of, or likely to unravel or snap when strained. **Base Skill:** 40% +5% per level of experience. Characters **bound/tied** by this character are -10% to escape/slip knots.

### Jackaroo O.C.C.

**Alignment:** Can be any alignment, but tend towards Unprincipled and Scrupulous. Of course, some can be sinister and downright evil.

**O.C.C. Requirements:** I.Q. 10, M.E. and M.A. 10, **P.P. 8** and P.E. 10 or higher.

**Special O.C.C. Bonuses:** +4D6+10 to physical S.D.C., +1D6 to M.A., +1D6 to P.E., +2 on initiative, +2 to pull punch, +1 to disarm, and +2 to save vs Horror Factor.

#### O.C.C. Skills:

Speaks **English/Australian** 88%

Basic Math (+20%)

Breaking and Taming Wild Horses (+15%)

Herding Cattle (+10%)

Land Navigation (+20%)

Lore: Demons and Monsters (+2%)

Lore: Cattle/Animals (+15%)

Lore: Aborigines (+15%)

Lore: Dreamtime Culture (+5%)





General Repair/Maintenance (+15%)

Outback Survival (+15%)

Cooking (+10%)

Climbing (+15%)

Hunting

Fishing (+5%)

General Athletics

Horsemanship: Cowboy

Pilot: Automobile or Truck (+10%)

Identify Plants (+20%)

Track Animals (+15)

W.P. Knife

W.P. two of choice

Hand to Hand: Basic to start, but can be upgraded to Expert at the cost of one O.C.C. skill (no others are available).

**O.C.C. Related Skills:** Select two at levels 1, 3, 5, 8, 11 and 14.

New skills start at the first level of proficiency.

Communication: Any

Cowboy: Any (+10%)

Domestic: Any (+10%)

Electrical: Basic only.

Espionage: Any (+10%), except Forgery and Sniper.

Mechanical: Automotive only.

Medical: Holistic Medicine and Paramedic only (+15%)

Military: None

Physical: Any (+10%), except Acrobatics

Pilot: Any (+15%), except Robot Elite, Power Armor and military vehicles.

Pilot Related: Any (+5%)

Rogue: Any except Computer Hacking.

Science: Math, Anthropology, Biology and Botany only (+5%).

Technical: Any (+15%), except Computer Operation and Programming.

W.P.: Any

Wilderness: Any (+15%), except Use Songlines.

**Secondary Skills:** Also select two secondary skills from the previous list at levels 1, 4, 10 and 15. They are limited as above, but do not receive any of the bonuses listed in parentheses. These are additional areas of knowledge and start at the first level of proficiency.

**Standard Equipment:** A good, rugged pair of boots is mandatory, along with a good set of worn but very sturdy clothes. As part of the outfit, the Jackaroo will have a wide brimmed hat, a bandanna, gear webbing, utility belt, a sturdy **backpack**, a scarf and a handkerchief for putting over the face (typically wrapping it under the hat as a **sweatband** during a heat wave, or when not in use), a durable **wristwatch**, canteen, silver cross and silver plated knife (does 1D6 S.D.C. damage) survival **knife**, gun holster and fire lighters. Note that **Jackaroos** tend not to wear goggles or sunglasses, as they hinder depth perception (hence the wide brimmed hat instead). However, they will carry a good set of binoculars, maybe a laser **distancer**, a telescopic sight for rifles or a hand-held passive nightsight scope. A Jackaroo also has a bedroll, billy, saddlebags, fishing hooks and line, small mallet, penknife, snakebite kit and collection of 1D4+1 signal flares.

No Jackaroo enters the wilderness without a sturdy (probably bolt-action) S.D.C. rifle and a reliable **sidearm** (maybe M.D. pistol), and an M.D. weapon of choice, each with sufficient ammo (usually 1D4+1 clips per weapon or 3D4x10 bullets if the weapon has no magazine).

A Jackaroo rarely uses a vehicle in the wild, though he does understand the value of a getaway vehicle or long distance mode of transport and hauling cargo. All in all, they prefer a good horse or other riding animal (borrowing vehicles when in town or on a ranch). Therefore the Jackaroo starts with a reliable, good quality horse, but has the option of owning a beat-up but reliable four-wheel drive M.D.C. vehicle (1D6x10+35 M.D.C.) with no modifications short of some spare gasoline cans in the back and a winch on the front fender.

**Money:** 1D6x\$500 in saleable items. This may be along the lines of **food**, seeds, a few heads of cattle, animal skins, and similar. Jewelry and the like tends to be of little value in the outback. The character also starts with 2D6x\$100 in **cash/dollars**.

**Cybernetics:** None. Cybernetics are hard to find, implant and hard to maintain in the Outback. Practicality prevails. Jackaroos also tend to regard them as the sign of a "City Slicker," and will only take them if two conditions are met: 1) It is needed as a prosthesis and 2) the price is reasonable.

# Merchant Trader O.C.C.

By Ben Lucas & Kevin Siembieda

The Merchant Trader is an adventurer who survives as a wheeler and dealer, buyer and seller of goods and services. Those who hook up with adventurers **and/or** mercenaries often act as the group's business agent — the guy who negotiates the price, terms and services of a deal. The "price" of their service typically includes 25% cash (dollars **and/or** credits), 50-60% trade goods, and 25-15% services and expenses required by the group (i.e. medical **treatment/psychic** or magical healing, safe room and board, a paid native guide, use of a special vehicle or **equipment**, special discounts, special **treatment/favors**, etc.). **Note:** To save space here by not reiterating the various considerations, fees, and deals common among mercenaries and heroes for hire, see **Rifts® Mercenaries** where such matters are covered extensively (otherwise fake it).

In the alternative or in addition to repping an adventurer group, Merchant Traders deal in commodities, buy wholesale and sell retail — or in the case of the Outback, buy cheap and "**trade**" up. Most Merchant Traders will buy and sell anything they think they can make a profit at: Animal furs (teeth, bones or anything else), drinking water, fuel, batteries, processed soap, textiles, computers, medical supplies, herbs, healing potions, building materials, vehicles, body armor, weapons, ammunition, tools, information and so on. While most of these savvy and sweet-talking Outback Merchants will gladly rep and sell the services of others (from fighters, heroes, healers, mages, mechanics and other professionals, to prostitutes, drug dealers, assassins, fortune-tellers, professional card **dealers/gamblers/cardsharps**, and other disreputable occupations), most (75%) hate to get personally involved in physical labor or fighting themselves. They consider themselves "idea men" and "**people persons**," "negotiators and lovers." Most hate getting down and dirty in the trenches.

Whether the Merchant is honest, a snake oil salesman or outright **crook**, these affable opportunists are part of the lifeline between Outback communities. Without their cunning, wile, scheming, and willingness to take a chance (sometimes insane gambles), many settlements would dry up and blow away. Not only do they help supply communities, but they also encourage communications and interrelations between different people and places that can help a town mature, grow and build alliances. Love **'em** or hate **'em**, they help fill a necessary function in the savage wilderness. The most silly, arrogant or delusional honestly think of themselves as "ambassadors of civilization."

The typical Merchant Trader is an intelligent, friendly and diplomatic caricature. Most are very friendly, open and honest (well, to a point). The majority dress very well, because image is important, and many will make and lose a fortune many times in their lives, while others are small-time dreamers and schemers always searching for that one big break that will make them rich, but somehow they never seem to find it. Rich or poor, most Merchant Traders enjoy what they do, never stop wheeling and dealing, and see what they do as a step towards creating a nation out of Australia once more. Most are well educated, but probably know next to nothing about survival in the wilderness — making these "**townies**" somewhat naive and vulnerable in that respect. They know a lot of people and the most skilled and charismatic make a lot of friends and connections.



## Special Trader O.C.C. Skills & Bonuses:

**1. Evaluate the Value of Goods:** Starts at 50% +4% per level. This ability is used to evaluate the value of objects, wares and products. Not just their dollar value, but their general level of quality, craftsmanship, **artistry**, age (if perishable) and any other general *appraisals* the player may wish his character to make. Magical items are beyond evaluation by a Trader, and the actual item may be underestimated ("Heck, looks like a plain length of wood to me").

**2. Gemology:** Skill in identifying and appraising the value of precious metals (silver, gold, etc.) and stones (jade, ruby, sapphire, diamond, etc.). This ability also enables the person to identify fakes, but at a penalty of -10%. A failed roll means the character cannot tell whether or not the item is fake or real, or its value is grossly under or overestimated. **Base Skill:** 25% +5% per level of experience.

**3. Contacts:** Every time a Merchant Trader visits a community and makes a purchase or sale, he is making some contact with people. While the majority are nothing more than customers and passersby, he develops a closer, stronger relationship with some. These can include artisans, craftsmen, other merchants, arms dealers, adventurers, heroes, criminals, farmers and ranchers, industrialists, and civil leaders. For instance, an Outback Trader, upon visiting the City or an Outback community, is likely to be able to dig up a manufacturer or an accountant that he has dealt with in the **past**, and vice versa.

Those with whom he has struck a good business relationship or friendship he can call upon for **favours**, and vice versa. This can get the character not only **information**, gossip and leads on good **deals**, but illegal and special things like forged documents, disguises, stolen goods (**sold/fenced** to him for cheap), access to a safe **house**, free or inexpensive medical treatment, discreet associates, criminal connections and so on.

Whenever a Merchant Trader visits his trading partners, pals or people who owe him a favor, he has a 15% chance, +4% per level of experience (and +4% per every five M.A. points above 18), of finding someone useful to increase his **dealings**, help him out, or dig up valuable information.

**4. Special Bonuses:** +1D6 to M.A., +1D4 to P.B., +1 on initiative, +1 to roll with punch, fall or impact.

## Merchant Trader O.C.C.

**Also known as** Outback Trader.

**Alignment:** Any, but often Unprincipled or Anarchist.

**O.C.C. Requirements:** I.Q. and M.A. of 10 or higher. A high P.B., P.E. and P.P. are also helpful but not a requirement.

**Base S.D.C.:** 4D6 plus those from skills and bonuses.

### O.C.C. Skills:

- Speaks **Australian/English** at 92%
- Literate in English (+15%)
- Basic Mathematics (+20%)
- Radio: Basic (+10%)
- Outback Survival (+10%)
- Land Navigation (+10%)
- Pilot: Two of choice (+10%)
- Find Contraband (+20%)
- Streetwise (+6%)
- Cardsharp** (+12%)
- Recognize Weapon Quality (+15%)
- General Repair and Maintenance (+10%)

Law (+15%)

Lore: Two of Choice.

W.P. Two of choice.

Hand to Hand: Basic to start, but can upgrade to Expert at the cost of three O.C.C. Related skills; no other Hand to Hand combat is available.

**O.C.C. Related Skills:** Select seven other skills of choice, plus two additional skills at levels 3, 6, 9 and 12. New skills start at the first level of proficiency.

Communication: Any (+5%)

Cowboy: None

Domestic: Any (+10%)

Electrical: Basic only.

Espionage: Disguise, Escape Artist and Intelligence only (+5%)

Mechanical: Basic and Automotive only (+5%)

Medical: Brewing and First Aid only (+10%)

Military: None

Physical: Any except Boxing, Wrestling and Acrobatics

Pilot: Any (+10%), except Robot Elite and military vehicles

Pilot Related: Any

Rogue: Any

Science: Any (+5%)

Technical: Any (+15%)

W.P.: Any

Wilderness: Carpentry and Boat Building only

**Secondary Skills:** Also select four Secondary Skills from the previous list. They are limited as above, but do not receive any of the bonuses listed in parentheses. These are additional areas of knowledge and start at the first level of proficiency.

**Standard Equipment:** An M.D.C. flak vest (easy to conceal) and one light suit of environmental M.D.C. armor or any type of homespun armor, one weapon for each **W.P.**, an S.D.C. knife (1D6 damage), a pair of scissors, a pair of sunglasses, a lighter, a **wristwatch**, a mini-pocket fan, CD recorder, language translator, flashlight, note pad, 1D6 pens or markers, air filter, suitcase, satchel or briefcase (with 10 M.D.C.), backpack, bedroll, and personal items.

His clothing will be designed for travelling in the Outback, but he'll also have one suit of excellent quality for important meetings and formal occasions.

The Merchant Trader will have a collection of give-away-items to impress potential clients, including things like bubble gum, candy, fruit, moonshine or beer, cigarettes, **refillable** pens, markers, beads, and other very inexpensive odds and ends.

Starts with a modest vehicle, typically a jeep, pickup truck or hover car.

**Note:** Will either travel alone or be part of a group. **NPCs** are likely to have 2-8 assistants.

**Money:** 2D6x\$1000 in **saleable/tradeable** stock. This may be anything from food, seeds or skins to electronics, fuel, M.D. weapons, clothing or medicine. The character also starts with 1D6x\$1000 in **cash/dollars** or Universal Credits. An **NPC** will have twice as much.

**Cybernetics:** None to start, but may consider a couple of minor implants or those needed for medical reasons.

**Supply & Demand:** See the City Trader for details, pg. 70.



# The City Trader O.C.C.

## Non-Player Villain & Optional Player Character

By Ben Lucas & Kevin Siembieda

It's a well kept secret that some of the Outback communities have trade arrangements with the enclosed cities of Melbourne and Perth. The Tech-Cities need raw materials, it's that simple. And the communities willing to provide these materials get modern goods in return. It is vogue amongst the Outbacker societies to hate, shun and bad mouth the two citadels of technology, mainly because they have turned their backs on their fellow human beings for 300 years! Part of this is rooted in jealousy, for the City-Goers are easily 100-200 years more advanced than the Outbackers, live in the lap of luxury, refuse to share, and turn their collective noses up at "barbaric Outbackers." However, the hard feelings are more than petty jealousy. Perth and Melbourne both have long histories of violence and brutality. They have kept their superior technology and lifestyle by chasing away and, more often than not, killing anybody who threatens them in the least, including refugees pleading for assistance, squatters on prime land, and people who speak out against them. **Furthermore**, the Tech-Cities have a history of seizing land and resources by simply pushing aside, uprooting or obliterating those who hold them. The Cities are also constantly involved in shady deals, schemes, unfair trade practices, and military action that hurts the Outback and its people. For example, they frequently roast towns and settlements, allegedly looking to bring raiders, bandits and other criminals to justice, but often capturing or killing anybody they suspect says or does things against them, including smugglers, thieves, **nonhuman** refugees, outspoken critics, dissidents, and political leaders and heroes who are building a reputation, earning the people's attention and building a growing influence. But when you are the undisputed power on the continent, you can get away with such foul behavior.

As a result, most wilderness folk regard the city dwellers and especially their leaders and military, as black-hearted villains who care only about themselves and nothing for anybody else (which is about right). Thus, Outback communities that condone trade and harbor agents, spies and troops from the Cities are quite often treated with contempt and hostility — spat upon as traitors to their own kind and willing lap dogs to the arrogant and rich City-Goers. To avoid trouble and admonishment, many places in league with the cities hide that fact, but others don't care as long as they benefit, and some need to trade with the Cities to survive.

**The City Trader** is typically an Outbacker (sometimes a City-Goer; about 30% are cutthroats born in the City) elevated to the special position of City-Outback Liaison. Their duty, to function as negotiator, go-between, trade organizer, armed escort and police. A sort of Rifts Australia Agent of Tobacco & Alcohol, Customs Agent, Super-Spy and Merchant all rolled into one.

It's a shadow business that often involves contraband and secrecy. The city Administrators never tell their citizens that they do deals with the Gap or Rim communities in order to maintain **their** solid image of independence and superiority. Likewise, the City Trader seldom reveals where his convoy or cargo is going (sometimes even concealing exactly what the cargo is). In the

Outback the luckiest communities are those who happen to have one or more natural resources available to them. This can be both a blessing and a curse, because inevitably, there will be forces who want to take their good fortune away from them. This means they are forced to fortify against bandits, raiders, monsters and other Outbackers. To do so, they need the money, high-tech weapons and other goods (and perhaps services in the way of "military advisors" and even "troops" disguised as mercenaries) supplied by one or both of the Tech-Cities. While this may breed jealousy and hostility among some of the nearby communities, it is often a necessary evil if they are to survive. It's an ugly situation, but it's legitimate and fair.

**City Traders** themselves are a rare breed of ruthless businessmen and cutthroats either dedicated to one of the Tech-Cities or to greed and power. Most enjoy the power they have in the field, for once outside the City, they are bound by no laws and their City employers don't care what they have to do or who they have to cheat, rob or kill to get what the City Officers want, just that they get it. In addition to "procuring goods" for the Cities, the City Trader often engages in subtle acts of reconnaissance, helps to supply secret City spies, agents and troops in the field, and sometimes even a little sabotage, misdirection and espionage themselves. Most deal with saints and sinners, legitimate merchants and townsfolk as well as **Roadgangers**, Bushrangers, bandits, criminals and scoundrels of all kinds, sometimes even D-Bees and supernatural creatures. Again, many enjoy the intrigue and the power these escapades generate — not to mention the money. All City Traders are comparatively wealthy and have a personal M.D.C. vehicle or **two**, a suit of environmental body armor, a variety of M.D. weapons (pretty much without limit or **restriction**, provided they are necessary for their job or they have the money to buy them), electronics, gizmos and connections in high places (both in the City and in the Outback). The number of City Traders in **Australia** is limited to the low three digit figures (making a player character Trader a very unique individual).

A City Trader may appear cold, aggressive and heartless or absolutely charming, but all are ruthless and self-serving in the extreme. Most care only about their bottom line, which is making money and keeping their City client(s) **happy**, regardless of the cost to others. While a City Trader *may* pretend to be a friend to Outbackers, or even an Outbacker himself, most regard wilderness folk as savage barbarians barely more than animals, and completely expendable.

### City Trader Background & Bonuses

When creating a City Trader character, roll on the following table to determine your background; roll percentile (**D100**).

**01-60 Outbacker that cut a deal with the Administration.** Starts off like the rest of the desperate men and woman scratching a living out of the Outback, but somehow makes contact with the city Administration. People thought the daring character was insane, and expected him to be gunned down, tortured for information, or worse. The character was told to leave the trade to the Raiders like *Wade McCoy*. Nonetheless, he managed to latch onto a City agent — they liked his aggressiveness and daring. After some painful interrogations, they made the character a proposition he couldn't refuse, and the rest, as they say is history. He or she is a City Trader. One of a rare breed allowed to enter the fabled City and even stay for a week at a time. It's

not an easy job, but it has elevated you to a position of great power, and man, does it have its rewards. Maybe, just maybe, the character dreams, he'll be able to retire and live in the City. That is one of the promises the City government has made, **provided** he does his job well and stays alive long enough.

**Bonuses:** In addition to O.C.C. **skills**, the character gets Outback Survival (+10%), Roadwise (+10%) and Escape Artist (+10%).

Add +1 to I.Q., +1 to M.A., +1D4 to M.E. and P.E., add +3D6 to S.D.C., +2 on initiative, and +4 to save vs Horror Factor.

**61-90 A Citizen of the City who has taken it upon himself to travel into the Gap.** The character is either a low level citizen without power or prestige, or a troublemaker or criminal given this "opportunity" to serve his City and grab himself some measure of power outside the city walls.

Here's one of any number of possibilities: As a member of one of the boards of directors, you pointed out one rather humiliating fault in the Administration's plan. You were punished for your insolence. Your punishment was to become a City Trader. Since you knew so much, they said if you were to strike trade deals and make purchases with the barbarians, that would benefit the City. They gave you a half dozen armed men dressed like Bushrangers and a helicopter and that sets down in a community near a rich mineral deposit to face the Outbackers. At first, they were just as you expected: dirty, uneducated savages. They threatened you with their primitive weapons, suspecting you were there on a raid. But you began to talk about trade deals for simple textiles, a few tankers of fuel and a handful of M.D. weapons, and soon make your first deal. You took pride in the fact that you got the fools to take one tenth of what the City would have authorized (what would have been fair). An exhilarating deal, because the Admin lets you take a 20% commission on the amount you save them. Hell, you just made one third your old salary in an afternoon of sweet talk and bullshit. They signed, delivered and were delighted with their end of the bargain. You kicked in their teeth and they don't even know it. Best of **all**, they're begging you to do it some more — eager to continue to trade. Maybe life in the wild wouldn't be so bad after all.

So now you are a liaison with the Outbackers. In fact, you've learned to appreciate them as fine individuals. You wouldn't want to live with them, but they're more than just savages, they're your meal ticket.

**Bonuses:** In addition to O.C.C. skills, he gets Computer Operation (+20%), Computer Programming (+10%), Computer Hacking (+5%), Literacy: English (+30%), Disguise (+10%), Seduction (+5%), +1D4 to M.A., +1D6 to S.D.C., +1 on initiative, and +2 to save vs Horror Factor.

**91-00 Outsider with no bias!** You are a rare bird indeed. You are an outsider to this entire affair. You have no bias to either side. You are not an Outbacker, and you are not a city dweller, and therefore owe your loyalties to no one. You simply saw the opportunity for lucrative business. Maybe you are an unscrupulous City Rat who wanted more than OF Sydney Town or Victoria Haven could offer. Or maybe you aren't even Australian at all; an Asian adventurer or a foreigner from anywhere who found himself in Australia thanks to a one-way trip through a dimensional Rift. Whatever the case, through a lot of shouting

matches, a lot of prejudice and not a small amount of **pain**, you have managed to cut a deal with Perth or Melbourne to serve as a City Trader. You've signed a contract with the City Government and have the right to make secret trades and cut secret deals on their behalf and travel from the Gap to the cities, exchanging goods. To start such an endeavor, you had to have initiative, drive and cunning. Your employers like that, and the fact the you aren't a barbarian.

**Bonuses:** +1D4 to his **I.Q.** and **M.A.** attributes. In addition to O.C.C. skills, he gets the Find Contraband skill (+15%), Seduction (+10%), Pick Locks (+10%) and Streetwise (+6%), +1 on initiative, and +2 to save vs Horror Factor.

## Special Trader Abilities

Same as the Merchant Trader. Bonuses are as noted under Background.

### City Trader O.C.C.

**Also known as the City Agent.**

Alignment: Any, but typically Anarchist or evil.

O.C.C. Requirements: **I.Q.** and **M.A.** of at least **13** or higher. A high P.B. and P.E. are also helpful but not a requirement.

Base S.D.C.: 4D6 plus those from skills and bonuses.

O.C.C. Skills: Select three Military or Espionage skills and four other skills of choice. Select one additional skill at levels 2, 4, 6, 8, 10 and 14. New skills start at the first level of proficiency.

Speaks **Australian/English** at 95%

Radio: Basic (+15%)

Basic Mathematics (+30%)

Pilot: Helicopter (+15%)

Pilot: One of choice (+15%)

Read Sensory Equipment (+10%)

Intelligence (+10%)

Find Contraband skill (+16%)

Streetwise (+4%)

Forgery (+10%)

Concealment (+5%)

Palming (+20%)

Law (+15%)

W.P. three of choice.

Hand to Hand: Basic to start, but can upgrade to Expert at the cost of two O.C.C. Related skills, and to Martial Arts (or Assassin if evil) at the cost of three skills.

O.C.C. Related Skills: Select three Military or Espionage Skills and four others of choice. Select one additional skill at levels **2, 4, 6, 8, 10** and 14. New skills start at the first level of proficiency.

Communication: Any (+5%)

Cowboy: None

Domestic: Any

Electrical: Basic only.

Espionage: Any (+5%)

Mechanical: Any (+5%)

Medical: First Aid only (+5%).

Military: Any (+10%)

Physical: Any except Wrestling and Acrobatics.

Pilot: Any (+10%), except Robot Elite.

Pilot Related: Any

Rogue: Any (+2%)

Science: Any

Technical: Any (+15%)

W.P.: Any

Wilderness: Carpentry, Hunting, and Land Navigation only.

Secondary Skills: Also select four Secondary Skills from the previous list. They are limited as above, but do not receive any of the bonuses listed in parentheses. These are additional areas of knowledge and start at the first level of proficiency.

Standard Equipment: This is where the City Trader outclasses every other O.C.C., because his access to equipment is superior.

An M.D.C. flak vest (easy to conceal), one light and one heavy suit of environmental M.D.C. armor (may also have a suit of homespun armor for the purpose of disguise), an M.D. **sidearm** with six **E-Clips**, an M.D. rifle and 10 **E-Clips**, and two weapons (M.D. or not) of choice, plus a **Vibro-Blade**, S.D.C. knife (**1D6** damage), a pair of sunglasses, a lighter, a **wristwatch**, a mini-pocket fan, portable hand-held computer, CD recorder, language translator, binoculars, flashlight, note pad, **1D6** pens or markers, air filter, suitcase, satchel or briefcase (with **10M.D.C.**) and personal items.

His clothing will be varied, and always the finest quality for his class; cool and versatile, though unsuitable for cross-country travel. The character's wardrobe is likely to consist of nearly a dozen suits or sets of clothes, including a trench coat.

The City Trader will have a collection of trinkets and goodies to impress the yokels, like bubble gum, candy, cigarettes, cheap sunglasses, **refillable** pens, markers, alcohol, CD player **and/or** various music disks, and so on.

City Traders who are player characters do not receive a helicopter, but do have an M.D.C. jeep, **hovercycle** or other hover vehicle and may have additional transportation (especially for hauling cargo) and other City resources available to them.

Note: **NPC** City Traders will have his own M.D.C. helicopter or other heavy-duty all-terrain vehicle with **1D4** combat features! Depending on the situation, they may be escorted by assistants (or troops) in other combat ready vehicles and, depending on the situation and importance of the mission, will have access to special City vehicles (and military support).

**NPCs** will be accompanied by 2-8, sometimes 10-20 "assistants" who are really City troops **and/or** meres assigned to help and support him. Sometimes spies, saboteurs, assassins, and other covert operatives are assigned as part of the Trader's entourage but are really on special military missions and using the City Trader as their cover.

Money: 3D6x\$3,000 in **saleable/tradeable** stock. This may be from **food**, seeds or skins to electronics, fuel, M.D. weapons, clothing or medicine. The character also starts with **2D6x\$1,000** in dollars and **1D4x1,000** in Universal Credits! The character earns money, by getting a commission on whatever money he saves his sponsoring City through his negotiations. This is a minimum of **2D6x10,000** in dollars or trade goods per transaction (at least one transaction a month or the Trader loses his contract with the City). **NPCs** will start with and earn 5-10 times more!

Cybernetics: None to **start**, but many City Traders go for Cyber disguises, implants and other minor cybernetic augmentation involving the head, lungs, throat and hands.

**Supply & Demand (special):** The following is a list of commonly demanded resources or trade items by various factions, and the locations where these supplies can be harvested.

**Perth/Melbourne:** Grains, metal ores, seedlings, meat, fossil fuels

**Aboriginal Tribes:** Nil — no contact, avoid all City-Goers.

**Outbackers:** Just about every modern machine or convenience, most notably, computer/electrical components, medicine, ammunition, M.D. weapons, M.D. armor, M.D. building materials, modern vehicles, processed fuels, scientific instruments, machine parts, etc.

**Reef Islanders:** Nil; little or no contact.

**Outlanders:** Fuels, medicine, processed food, machine parts; **infrequent** and minimal contact.

Resource — Locations Most Commonly Found

Metal Ore — Northern Queensland

Fossil Fuels — NSW, Western Australia

Timber — Queensland, NSW

Sand — Western Australia, Queensland

**Grain/Agriculture** — NSW, Western Australia

**Fruits/Vegetables** — NSW, Western Australia

**Meat/Animals** — NSW, Queensland, Western Australia

Electrical Components — Cities: Perth & Melbourne

Advanced Medicine — Melbourne and Victoria Haven

Cybernetics & Bionics — Melbourne and OI' Sydney Town

Scientific Instruments — Perth & Melbourne

**Weapons/Ammunition** — Perth & Melbourne

Vehicles — Perth & Melbourne

Luxury items — Perth, Melbourne, & OI' Sydney Town

## Outbacker Runabout O.C.C.

Basically, everybody living outside one of the two Tech-Cities, Perth or Melbourne, lives in the Back of Beyond or *the Outback*. Any born Australian who lives in the Outback (humans of any race, except for Aborigines who get their own separate classification) fall under the general umbrella title of "Outbacker," while alien **humanoids** are "**D-Bees**," **wicked**, supernatural beings are "demons," and hideous inhuman creatures are "monsters." More specific titles used to describe the inhabitants of the Outback are typically based on one's occupation or **race**, i.e. "Oh, he's a Roadganger, he's a Jackaroo, she's an Aborigine, those two are **Kwarla**," and so on.

Not everybody who survives in the outback is a bush-bashing Jackaroo, False Sorcerer, petrol head Roadganger or skulking Raider. Far from it. Every once in a while a figure will emerge from the ranks of normal society who is struck by wanderlust and an unquenchable desire for adventure and exploration. They can't help wondering what lies just beyond the horizon and have the courage to go off to **find** out. Such a character is the Outbacker Runabout.

As described in the previous section, wilderness and Outbacker communities can be large or small, and have a variety of people, technology, tradesmen, attitudes, skills, needs, dangers, and worries. Most are small places, a few hundred to a thousand or two. The Outbacker Runabout may originate from

such a place, but they don't stay there. The Runabout is typically (but not always) a rugged and **unregimented** individual with a yearning for adventure, thus, they wander the wilderness, living off the land and searching for opportunity, adventure, and fun. In fact, they see the desolate Outback as a sea of adventure and wonder. Most Outbacker Runabouts find the Back of Beyond both exciting (because of the people, adventure and wonder of it all) and tranquil in its **vastness** and simple beauty. Like the Outback itself, most Runabouts are a strange combination of **tranquility**, resilience, strength and violence. The former is evident in the **Outbacker's** calm. Most take things as they come and make the best of what they have. Most are patient and easy-going fellows who rarely complain, appreciate what they have, enjoy the simple beauty of the wilderness, and the spirit of people.

Runabouts are famous for being tough, honorable, outspoken and to the point. Some are downright crude and rude, while others are compassionate, soft-spoken and considerate. They enjoy the many challenges the Back of Beyond has to offer, and are something of independent mercenaries, cowboys and heroes. Many have a rough, carefree and nonchalant exterior demeanor and attitude, sometimes to the point that they come off as lazy drifters or madmen. However, all Outbackers have a line they won't cross and a threshold of tolerance. Once that threshold is exceeded, the character takes an unshakable stand and is ready and willing to take whatever action is necessary to rectify the situation. At these moments of truth, the Outbacker can be as fierce and deadly as a wild demon. Yet beneath that hard exterior is usually a gentle and compassionate heart — a character who celebrates freedom, the human spirit and imagination. Elements that help make him resilient and strong in character.

As a drifter, the Runabout is competent enough and has a fairly wide array of skills and knowledge. Certainly enough for him to get by in his daily routine, but most don't know how to burn through the desert roads, or survive for days on end in the wild. In fact, being adaptable and pragmatic is one of the Runabout's strengths.

Outbackers are often swept along by other adventurers or the promise of adventure, and find themselves caught up in grander schemes. This is fine, because they go where the wind or whim carries them, and they know adventure and happiness is where one finds it. Although they enjoy the wild, they are love Outback towns — the wilder, rougher, and raucous, the better. Such is the Outbacker Runabout.

### Special O.C.C. Skills of the Runabout:

**Prospecting:** The character can recognize and evaluate precious and semiprecious metals (**gold**, fool's gold, silver, bronze, copper) in their natural ore appearance and as refined and polished **jewelry**. In addition, the character has a good idea where to look for such mineral deposits, the fundamentals of "panning" for gold, and the general knowledge of mining and how to use various types of simple mining equipment.

Furthermore, the character can identify and appraise the value of precious metals (silver, **gold**, etc.) and stones (diamonds, rubies, etc.), and to identify fakes, but at a penalty of -10%. A failed roll means the character cannot tell whether or not the item is fake or real, or he grossly under or overestimates its value. **Base Skill:** 40% +5% per level of experience.

**Rope Works:** This is a skill that takes into account the various needs and uses of rope. The character knows a variety of

ways to tie knots, the advantages to various types of rope and cords, their tensile strength and how to weave/make rope. A failed roll to tie a knot means that it is loose and sloppy and easy to untie, slip out of, or likely to unravel or snap when strained. **Base Skill:** 30% +5% per level of experience. Characters bound/tied by this character are -10% to escape/slip knots.

### Outbacker Runabout O.C.C.

**Also known as** a Drifter and sometimes the Australian Cowboy, Bush Cowboy or Cowpoke.

**Alignment:** Any, but most are good or selfish.

**Attribute Requirements:** P.P. 10 and P.E. 12 or higher, plus an independent spirit and a willingness to take chances and work hard.

#### O.C.C. Bonuses:

- +4D6+6 S.D.C.
- +2 to pull punch
- +1 on initiative
- +1 to strike/ensnare with a lasso at levels 2, 6 and 11.
- +1 to save vs Horror Factor at levels 2, 4, 8 and 12.

#### O.C.C. Skills:

- Speaks **Australian/English** at 90% (most are illiterate)
- One Domestic skill of choice (+10%)
- Basic Math (+15%)
- Branding (+20%)
- Herding Cattle (+20%)
- Roping (+30%)
- Land Navigation (+20%)
- Lore: One of choice (+10%)
- Horsemanship: Cowboy

Pilot Automobile, Truck or Motorcycle (+5%)

Running

Climbing (+10%)

General Athletics

W.P. Energy Rifle

W.P. two of choice (any)

Hand to Hand: Basic to start, but can be changed to hand to hand: expert at a cost of one O.C.C. Related Skill, or to Martial Arts for the cost of two skills. Outbacker Runabouts can never learn Assassin.

**O.C.C. Related Skills:** Select four additional skills at level one, three additional at levels two and three, and one additional at levels 6, 9 and 12. New skills start at the first level of proficiency.

Communication: Any (+5%), except Laser

Cowboy: Any (+15%)

Domestic: Any (+10%)

Electrical: Basic only.

Espionage: Any

Mechanical: Automotive only.

Medical: First Aid only (+5%).

Military: Recognize Weapon Quality and Find Contraband only.

Physical: Any except Gymnastics and Acrobatics.

Pilot: Any (+10%), except Robot Elite, Power Armor and military vehicles.

Pilot Related: Any

Rogue: Any (+2%), except Computer Hacking

Science: Any (+5%)





Technical: Any (+2%), except Computer Programming

W.P.: Any

Wilderness: Any (+10%)

**Secondary Skills:** Also select two Secondary Skills from the previous list at levels 1, 3, 5, 8 and 11. They are limited as above, and do not receive any of the bonuses listed in parentheses. These are additional areas of knowledge and start at the first level of proficiency.

**Standard Equipment:** The character starts with the clothes on his back, typically a **cap/hat**, a shirt, a singlet, jeans, **boots**, two pairs of soft leather work gloves, plus a set of fancy "Sunday clothes," and an extra set of **work/traveling** clothes. He may also have a suit of light to medium M.D.C. home-made armor, an S.D.C. **sidearm** with 1D4 ammo clips or a crossbow and 24 bolts, one M.D. energy rifle, a small hatchet (1D6 S.D.C.), penknife (1D4 S.D.C.), 60 foot (18.3 m) length of rope (made of hemp, rawhide or modern materials), **a** canteen and a large water skin, sunglasses or tinted goggles, utility belt, backpack or saddlebags, bedroll/sleeping bag, blanket or two (more likely for a horse or pet than for the man), 1D4 old-style books of matches, and cigarette lighter. In the **Outback**, nothing can be taken for granted, not even items like soap, **comb**, flashlight or lantern, aspirin, candy, and so forth. Such things will have to be purchased with starting funds. **Note:** Often has a small animal as a pet and companion, anything from a toad or lizard, to a dog, horse or exotic creature.

**Mode of Transportation:** Unless the G.M. says otherwise, the Runabout does *not* get a horse or vehicle to start. That's okay because they like walking. However, the character is likely to acquire a riding animal, motorcycle or other small vehicle, eventually. As a sort of Australian cowboy, the character has a natural **affinity** for horses and other riding animals.

**Money:** The character starts with 1D6x\$100 in **tradeable** goods and 2D6x\$100 in dollars, which may be necessary to spend on additional starting items and equipment.

**Cybernetics:** None. May be purchased later if desired, but even then cybernetics are rare where this character comes from.

## Raider O.C.C.

When the dust of the Apocalypse cleared, Melbourne and Perth were among the handful of cities left standing, and there was a mad dash for asylum within the comfort of their streets. Thousands of homeless tried to win positions in the Cities so that they could live like civilized human beings once more. Unfortunately, the overload caused the governments of the time to wall the cities in, erect barricades, domes, sentries and other, less passive deterrents in order to survive. Each city became a fortress, an air-conditioned paradise for the lucky ones within, a hated, selfish dwelling of heartless traitors to those locked outside. As cruel as turning their backs on their fellow survivors may have been (just how necessary this was is an ongoing matter of dispute), Melbourne and Perth survived when most other cities collapsed.

Meanwhile, in the evolving Outback, communities were beginning to form. Slowly, as people fell to **barbarism**, and machines, parts and weapons had to be scavenged from the ruins, while resentment from people living near the Cities festered.

Meanwhile, those living more than a few hundred miles from the Cities didn't even know they existed.

In recent years, starting around P.A. 15, **Outbackers** in the Back of Beyond *rediscovered* Perth and Melbourne. Over the last 50 years, many wilderness people (about half) have come to realize that these mythical places are real, although they have also come to the rude awakening that the two "Tech-Cities" remain isolationists willing to use their superior technology, armies and deadly force to keep them out. It is no longer any secret that the "City-Goers," as they are commonly called, consider all people living outside their walls to be barbarians or primitives — **undesireables** all. Moreover, in the last 35 years, Melbourne, in particular, has engaged in military action beyond the confines of the City walls to claim land and resources, purge mutants and Roadgangers, and make its presence felt as the budding continental power.

It was around P.A. 70 when the Raider movement started. Several individuals from the southern coastlines outside Melbourne took it upon themselves to "make like Wade," a sort of Robin Hood-like legendary folk hero who is said to have been the first person to breach the walls of Melbourne and escape with a truck load of stolen weapons, **E-Clips**, armor, and electronics. With his stories as inspiration, an entire class of bandit has come into being, the Tech-Raider who is cunning and daring enough to sneak or break into the City (**and/or** its military camps in the Outback or the convoys consigned by City Merchants) and plunder the plunderers.

Few Tech- or City-Raiders are anything like Robin Hood, but the Tech-Cities are seen as evil oppressors unwilling to share their wealth (in technology) with the struggling peasants of the Outback. Consequently, even though most City Raiders are self-serving brigands, anybody who can steal from the heartless, selfish juggernauts, Perth and Melbourne, are heroes in most **Outbackers'** eyes.

Most Raiders are skilled thieves who use Commando-style tactics to raid the Tech-Cities for their own personal gain. As highly skilled cat burglars with a few extra tricks to help them survive attempts at cracking the city walls, most Raiders are also gung-ho action seekers who find a thrill in elbowing over two hundred yards seeded with land mines, under laser nets and ever vigilant guards and aerial patrols just to get to the outer wall! Getting inside is a whole other adventure, usually involving scaling three hundred feet of wall while trying to avoid robot helicopter sentries; or by means of disguise, stowing away and other ways of sneaking inside. Getting out isn't much easier than getting in!

When on a job, City Raiders are deadly serious and nothing but business. One slip and they could lose their life or face capture, torture and life imprisonment doing hard (really, really hard) time. But never will they claim for a moment that they aren't having fun. Many do it for the challenge and tremendous financial reward, others as a slap in the face of the hated juggernauts, and a few just for the glory and fame.

What stolen items they don't want or can not use, they sell to a huge market hungry for anything "**tech**," and usually at a tremendous profit. Everything from bubble gum and soda pop to weapons and electronics fetches strong interest and excellent prices. Selling items themselves, direct to a person gets the best price, typically list book price to 200% higher (depends largely

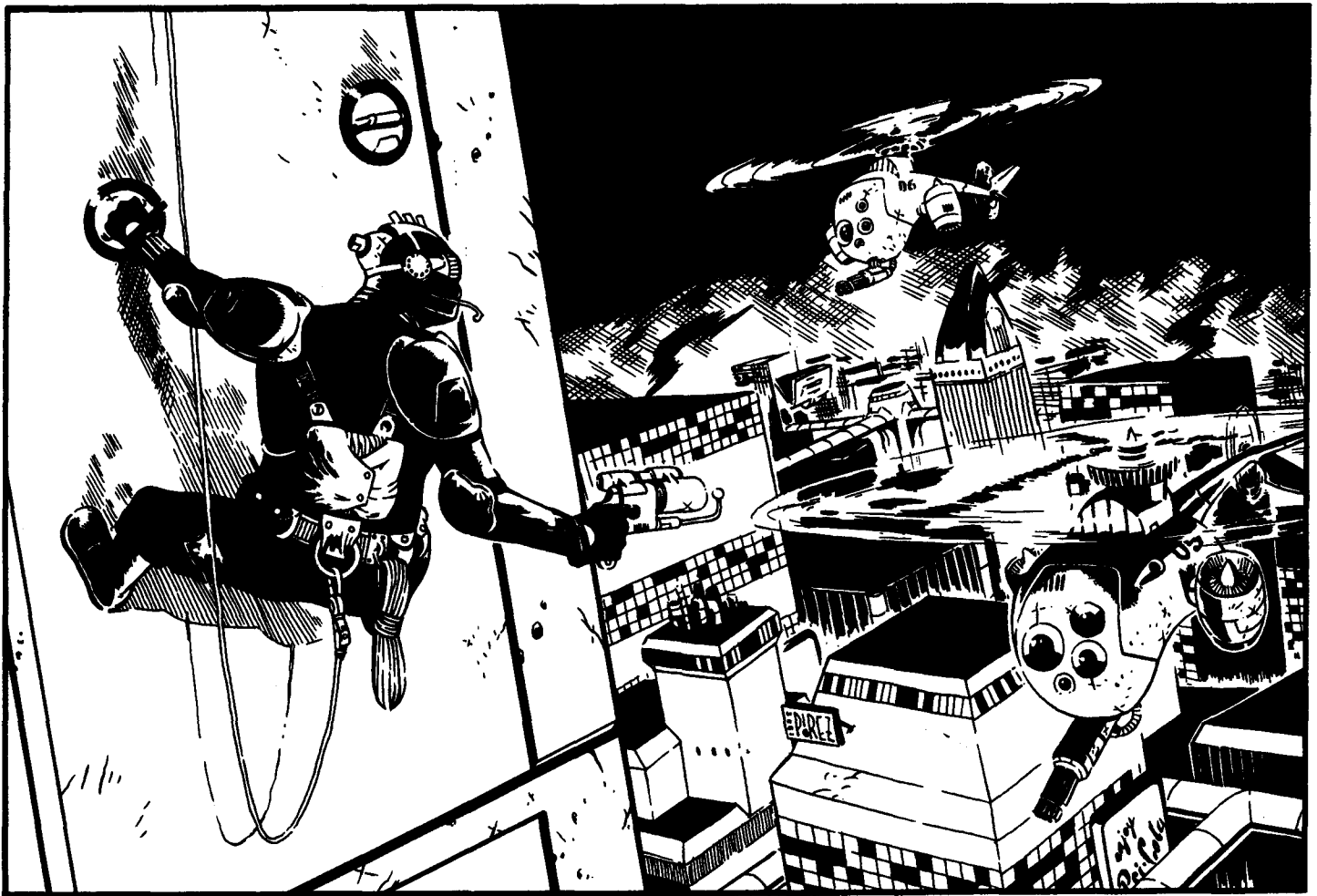

on the client and the item). Unfortunately most wilderness folk and criminals are poor and can't afford even book price, so sometimes the Raider has to sell for 10-40% less. And selling items direct can be extremely dangerous, especially in the shadow of the Tech-Cities. Consequently, most Raiders sell to a "fence," a criminal dealer who specializes in liquidating stolen goods. However, fences, crooks, and most merchants **won't** pay more than 20-30% of the list book price, unless the item is rare or there's a big market for it. Even then the Raider isn't likely to get more than 50% of book price, even if the fence can turn around and sell it for two or three times that amount. OF Sydney Town is a major market for such **items**, as are adventurers, Merchant Traders, Roadgangers and other gangs and criminals. City Traders will alert their City allies about any suspicions they may have about a Raider. It earns them brownie points with their City masters and reduces competition on the streets.

### Raider O.C.C.

**Also known as** Tech-Raider, City-Raider and the Good Raider.

**Alignment:** Any, but most are selfish or evil.

**O.C.C. Requirements:** I.Q. 10, M.E. 10, and P.P. 12 or higher.

**Special O.C.C. Bonuses:** Hard to catch unawares, the Raider gets a +1 on initiative at levels 1, 3, 5, 7, 9 and 11, +3 to pull punch, +1 to disarm, +2 to roll with punch, fall or impact, and +3 to save vs Horror Factor. **Base S.D.C.:** 5D6

#### O.C.C. Skills:

Speaks English at 96%.  
 Literacy: English (+15%)  
 Basic Math (+25%)  
 Intelligence (+15%; specializing in the city)

Streetwise (+10%)  
 Radio: Basic (+15%)  
 Surveillance Systems (+10%)  
 Computer Operation (+15%)  
 Computer Programming (+10%)  
 Computer Hacking (+10%)  
 Disguise (+20%)  
 Pick Locks (+20%)  
 Climbing (+20%)  
 Acrobatics (+5%)  
 Prowl (+20%)  
 Concealment (+15%)  
 W.P. Knife  
 W.P. **Two** of choice.

Hand to Hand: Expert to start, but can be upgraded to Martial Arts or Assassin for two O.C.C. Related skills. The character need not be evil to take Assassin, because City-Goers are perceived as evil.

**O.C.C. Related Skills:** Select five other skills at level one, plus one skill at levels 2, 4, 7, 10 and 13. New skills start at the first level of proficiency.

Communication: Any (+10%)  
 Cowboy: None  
 Domestic: Any  
 Electrical: Any  
 Espionage: Any (+5%)  
 Mechanical: Any  
 Medical: First Aid only (+10%).  
 Military: Any (+5%)

Physical: Any  
Pilot: Any (+5%), except Robot Elite.  
Pilot Related: Any  
Rogue: Any (+10%)  
Science: Any, but only Advanced Math gets a bonus (+15%).  
Technical: Any (+10%)  
**W.P.:** Any  
Wilderness: Carpentry, Boat Building, and Land Nav. only.

**Secondary Skills:** Also select two Secondary Skills from the previous list at levels 2, 5, 10 and 15. They do not receive any of the bonuses listed in parentheses, and are limited as they are categorized (Any, Only and None). These are additional areas of knowledge and start at the first level of proficiency.

**Standard Equipment:** The Raider has his night suit: a black jump suit with gloves, sturdy yet silent rubber-soled boots, a balaclava, climbing harness, utility belt and light M.D.C. armor (30 M.D.C) with a head **covering/mask** that includes passive **nightvision** goggles, and radio scanner to monitor the police and military bands of communication. Some "night suits" and gears will vary with the individual. Tucked away in a light knapsack are his city clothes: a disguise that is a casual outfit that would fall apart within days of wearing them in the outback, but is perfect for walking the city streets.

Additional gear includes utility belts, web belt, various harnesses and belts, lock picks, portable tool kit, mini-radar unit, RMK Robot Medical Kit with **1D4 IRMSS** Robot Medical Surgeon Systems, a pair of Electro-Adhesive Pads, a small signal mirror, pair of handcuffs (3 **M.D.C.**), laser scalpel (for cutting), pocket **knife**, pocket flashlight, 100 feet (30.5 m) of light nylon rope with a small grapple, a lighter, a **wristwatch**, a glass cutter, a small tool kit with a soldering iron for bypassing surveillance measures, 1D4 large sturdy sacks with pull strings, and other odds and ends.

Weapons "on the job" are usually kept to a minimum and are items that can be concealed like a **Vibro-Knife**, M.D. energy pistol and four **E-clips**, 1D4 hand grenades **and/or** smoke grenades and a couple of flares. However, back at his lair he is likely to have a half dozen M.D. weapons, plus a dozen S.D.C. weapons, cross bow, wooden stakes, a light to medium suit of environmental M.D.C. armor (perhaps even the kind used by City police or **military**), an M.D.C. flak vest (easy to conceal), 1D4 portable hand-held computers, 1D4 CD players and recorders, language translator, infrared distancing binoculars, flashlight, a dozen note pads, a box of 24 pens and markers, air filter, suitcase, satchel, briefcase (with 10 **M.D.C.**), backpack, sleeping bag, tent, and additional basic items and personal items. He may also have various disguises.

Starts with a jet pack and hovercycle or motorcycle for a vehicle.

**Money:** Starts with only **1D4x\$1000** in **tradeable** goods and **2D4x\$100** in dollars or Universal Credits because he's spent the rest on equipment and the high-life. **NPC** villains (typically anarchist or evil) will have 3-5 times more.

**Cybernetics:** Start with none and most Raiders avoid them for fear of the City being able to use them to track or identify them. Furthermore, cybernetics are hard to **find**, get implanted and maintain in the Outback. **Nonetheless**, Raiders are intrigued by them and may consider minor implants and optic systems.

# Roadganger O.C.C.

By Ben Lucas & Kevin Siembieda

One of the most interesting developments in Rifts Australia is that of the Roadganger culture. These barbaric and blood-thirsty **survivalists** are built around a culture of brutality, stealing, raiding and war.

Many of the small, **pre-Rifts** desert towns, trucker stations and desert tourist hideaways survived the Great Cataclysm, but were left stranded in the barren **Outlands** after the Apocalypse. Those not swallowed by the storm of destruction that followed found themselves in a baked, hostile, and alien world. The only evidence of their old world was what they had in their community, salvaged technology from ruins of larger cities, and the broken roads that once connected them to the coastal cities. Armed with vehicles, weapons, ribbons of highway and technology (and often, underground fuel tanks) that survived the Apocalypse, they were able to survive better than those living in major population centers.

The first move many survivors wanted to make was to get back to the coasts and rejoin civilization along the Australian shores, only civilization was gone. They were on their own, trapped in a world turned upside down. A shortage of supplies, huge distances and failing technology plagued them in their wilderness domain. Ironically, they soon found that what little they still had was more than what most survivors from the cities had. As word began to spread about these "desert oases of technology and civilization," desperate and wild-eyed survivors of the Apocalypse began to brave the wilderness and swarm over the little towns and outposts that had survived virtually unscathed. Suddenly, the **frightened** and troubled Outback people and truckers found themselves under siege from their own people. The decision they faced was to abandon what little they had for the human locusts that threatened to devour them, or fight to save themselves and preserve what little they had. From this sprung one of the most violent human cultures in the world, where only the strong and ferocious survived. What remnants of civilization that prevailed in the Outback were consumed in a violent clamor for fuel, food and weapons, and the ensuing battles to keep it from the invading multitudes. Sadly, what might have been Australia's greatest hope to rebuild was shattered by desperation, terror and greed.

How this violent culture survived is a miracle in itself, but survive it did. In modern Rifts times the ancestors of these people have become marauding savages. Parasites who live off the land and plunder Outbackers, travelers and wilderness communities. Roving armed camps — ruthless mobile bandits — who take what they need or want, fight any who challenge them or dare to stand against them, and prey upon those who struggle to rebuild civilization.

The Roadganger O.C.C. represents Outback villainy and savagery at its height. They are tough wild, warriors and thieves devoid of morals and compassion. They take what they want and do as they please, bringing terror to peaceloving and kinder folk. Many Outback communities, especially the small ones, are so terrified **and/or** ill equipped to handle such brutes that they open their gates to them and let them take what they want (a sort of tribute or protection money) and endure **their** cruelty and abuse in an effort to survive — communities held hostage by terror. A

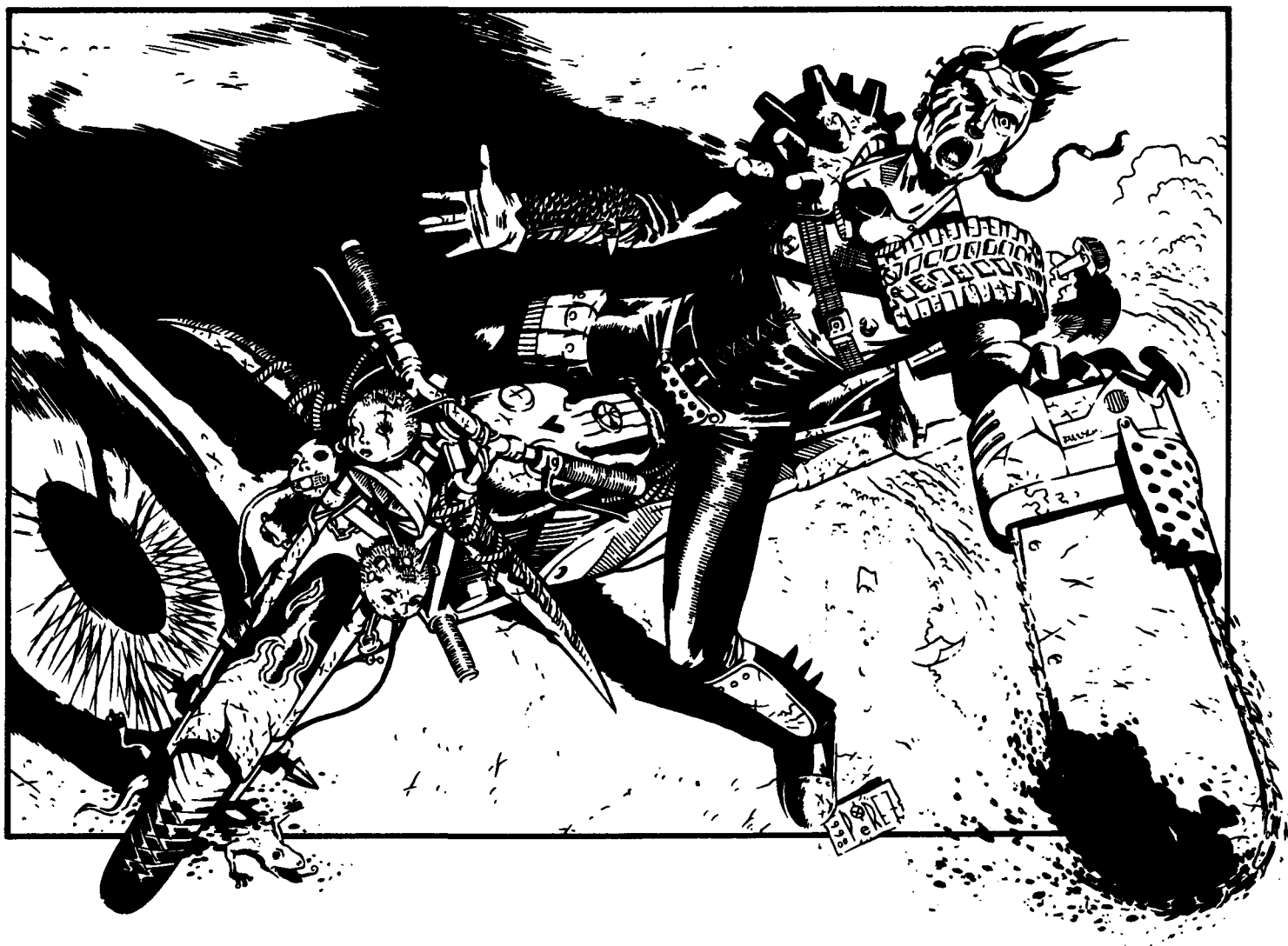

typical Roadganger represents a threat in numbers. They roam deserts and highways in gangs and clans that can be as small as 3-12, to several hundred, although most range between twelve and sixty.

Roadgangers take great pride in their appearance. Not in a conventional sense, but in how **ferocious**, dangerous and frightening they look. They like long hair or wild **hair** styling, particularly mohawks, **ponytails** and partially shaved heads. They like to decorate **their** armor with studs, spikes, buckles, animal skulls, horns, teeth, claws and **pre-Rifts** junk. They favor gloves with the fingers cut off, tattoos and steel or blade tipped boots. Some even wear frightening war masks. Second to their personal appearance is the tough and bold appearance of their vehicles, which have been pieced together with toil and personal sweat and know-how. It is a battle steed and status symbol. Vehicles will often be painted with loud murals, bold and striking designs (flame, skulls and death's heads are popular) and in frightening images of monsters, death and war, as well as the usual spikes, horns, etc.

An entire Roadgang in action is a colorful carpet of assorted cars, motorcycles, and the occasional armored truck, hovercycle, hover vehicle and even military vehicle or helicopter (captured from one of the Tech-Cities) thundering across the wilderness or along a broken highway. Such convoys are accompanied with the roar of engines, whoops of glee, shouts of defiance and in-

sane laughter all coated in a cloud of dust. A fearsome sight that spells disaster for unwary Outbackers and other travelers.

**Note:** Roadgangers are nomads who roam throughout the Australian wilderness, particularly the wastelands and deserts. They are most numerous and deadly in New South Wales (NSW), where old and new roadways are comparatively plentiful, but rarely make contact with the coastline. They are also bold enough to raid City military camps and patrols, City sponsored merchant caravans, and mess with City Traders and other agents. Although the majority are mechanical wizards and love their souped up vehicles, 15-20% either ride the Giant **Kang** instead, or use them (and other riding animals) as an alternative, especially in the desert and savanna environments, and when fuel is unavailable.

### **Roadganger NPC Villain & Optional Player Character** Also known as Desert Riders.

**Player Character Note:** A Player Character allowed by the G.M to play a Roadganger is ultimately a more enlightened individual who has found the extreme lawlessness and cruelty of his people to be more than he can personally accept. Thus, he is either a misanthrope and a traitor (from the **Roadgangers'** point of view) who has become soft and turned his back on his own people or an outcast exiled from his clan or gang (for any number of reasons).

Having been raised in that lawless, brutal and violent warrior society, the character, despite his quest to become more civilized and moral, will probably be hot-tempered and see violence as the first and easiest solution to most problems. He finds it difficult to trust others, and hard to show compassion or gratitude. After all, his attitude has been, whatever you can pull together, win in a fight and hold onto is yours. Whatever is left unguarded is fair game. Likewise, everyone is expected to battle for even the simplest things: water and food in particular. The concept of sharing is very foreign to a **Roadganger**. Thus, the character will tend to be intimidating, use threats and physical force, and may use torture (depends on his alignment and the player group's counsel). Most are self-indulgent, rude, loud, outspoken and rowdy, lack self-control, enjoy brawls and fighting, and are direct and linear in their thinking — a man of action and loud words. The other player characters will have to serve as his teachers, counselors and conscience, at least at first, to help him become a more gentler, kinder, compassionate, **merciful**, and, dare we say it, civilized person. Roadganger player characters should welcome such advice and tutelage and can grow into better people (alignment may change over long periods of time and positive change).

Finding allies is a tough job for a fellow like this. His only old **friends** are his other **Roadgangers**, Bushrangers and other criminals, the former of whom would as soon kill him for his boots as help him out of a scrape, and the latter of whom regard him with suspicion. Furthermore, most **Outbackers** are not likely to believe this leopard has changed its spots, and regard him as a dangerous sociopath. As hard as he tries, and as genuine as he may be, for a long, long **time**, people will hate and fear him. Earning their trust and changing his old ways will be one of the longest and hardest fought battles of his life.

Alignment: Any, but the vast majority are Diabolic, Miscreant or Anarchist.

O.C.C. Requirements: P.E. 10 or higher, and a mean spirit. A high P.S. and P.P. are extremely helpful, but not required.

Base S.D.C.: 4D6.

O.C.C. Bonuses: +1 on initiative at levels 1, 3, 5, 6, 8, 10 and 12, +1 to strike, +1 to pull punch, +2 to roll with punch, fall or impact, +4 to save vs Horror Factor, **+1D4x10** to physical S.D.C., +1 melee **attack/action** when riding a vehicle and can shoot from a moving vehicle without penalty.

O.C.C. Skills:

Speak English 80% (most are illiterate)

Basic Math (+5%)

Radio: Basic (+10%)

Outback Survival (+20%)

Basic Electronics (+10%)

Basic Mechanics (+10%)

Automotive Mechanics (+10%)

Pilot: Automobile or Hover Vehicle (+20%)

Pilot: Motorcycle or (+20%)

Pilot: Truck (+15%)

Pilot: One of choice (+15%)

Outback Combat Driving

Horsemanship: Exotic Animals (Giant **Kang** in particular) (+30%)

Vehicle Armorer (+15%)

W.P. Archery & Targeting (crossbows in particular)

W.P. Energy Rifle

W.P. Three of choice (any)

Hand to Hand: Expert to start but can be changed to Hand to Hand: Martial Arts or Assassin (if anarchist or evil) for the cost of one other skill.

O.C.C. Related Skills: Select three Physical skills (any, +5% where applicable), two Military or Espionage skills and three other skills of choice. Select one additional skill at levels 3, 6, 9 and 12. New skills start at the first level of proficiency.

Communication: Any

Cowboy: None

Domestic: Any

Electrical: Any

Espionage: Any

Mechanical: Any (+5%), except Robot, Mechanical or Weapons Engineer

Medical: First Aid only (+5%)

Military: Any (+5%)

Physical: Any

Pilot: Any (+15%), except Robot Elite and boats

Pilot Related: Any

Rogue: Any except Computer Hacking

Science: Math only.

Technical: Any (+5%), except Computer Operation and Programming

W.P.: Any

Wilderness: Any (+5%), except Boat Building and Songlines.

Secondary Skills: Also select four Secondary Skills from the previous list. They are limited by "Any, Only and None," and do not receive any of the bonuses listed in parentheses. These are additional areas of knowledge and start at the first level of proficiency.

Standard Equipment: Starts with a suit of homespun M.D.C. armor (not full environmental armor) with a heavy helping of leather and spikes. Other equipment includes one or two M.D. weapons and a couple of S.D.C. weapons reflective of the character's W.P., survival knife, silver-plated knife, wood or bone cross worn around the neck as protection against vampires, wooden stakes or a cross bow with wooden arrows, hand-held radio communicator, 1D4 signal flares, 1D4 smoke grenades, camp stove, sleeping roll, billy, some basic rations (enough for 2D6 days), sunglasses or silt goggles, basic paper air filter mask, two canteens, and a basic kit bag containing some crude cutlery, a half empty box of matches, cigarette lighter, bandages, and any other bits and pieces okay with the G.M. The vehicle will also carry some essential but very basic tools. If he wants to have a better tool set, he may buy it with his vehicle funds.

Vehicle: The character starts with a motorcycle, pickup truck or jeep-type vehicle and a \$20,000 budget to spend on improvements for it (any money not spent on the vehicle is not counted as available funds; eliminate it).

Money: 2D6x\$100 in **saleable/tradeable** items and 1D4x\$100 in cash.

Cybernetics: None. They're hard to find, hard to implant and hard to maintain in the Outback. Practicality prevails. If the opportunity did arise, however, the Roadganger would be eager to get implants, especially weapons, limbs, **garrotes** and such similar things.

# Road Sentinel O.C.C.

The Road Sentinel is a toughened, grizzled veteran of the forgotten causeways forged by the lost civilizations. The world is an open road to this nomad — he's got nothing except himself, his vehicle (typically a souped-up car, motorcycle or hovercycle) and his will to scratch out an existence from day to day. Maybe a loner at heart, he still doesn't mind teaming up with those he feels deserve his "quality." That is, his superiority behind the wheel, combined with his strong sense of justice, fighting ability and his knowledge of the Outback and the secrets held by its roads and trails.

Unlike the Roadganger, the Sentinel of the broken highways is something of a self-styled hero meting out justice and retribution and protecting the innocent. In days past he might have been considered a vigilante or knight-errant — fuel-injected Samurai (or, more to the point, a "**Ronin**," a masterless knight). These truculent heroes are supportive of what friends they have, hate injustice and slavery (they more than most, they appreciate freedom) and are full of vengeance for any wrongs committed against them or innocent people, especially children.

In the deserted wilderness of the Outback, he is often the closest thing peasants and travelers have to salvation against marauding bands and terrible monsters. The **Roadgangers**, bandits and other criminals are his primary enemies, but Road Sentinels also battle demons, monsters and all dark forces who pillage, enslave, torment and kill the innocent and helpless. The majority have seen a lot of combat and traverse one end of the **Outlands** to the other before they hit the age of 21, most of it in a cloud of dust at 180 **klicks** (112+ mph) with the smell of **nitro** in their nostrils.

There is a strange honor, or code that looms over these jockeys which cannot be explained so much as felt. The Road Sentinel understands it's all a man can do to survive out here without going at each other's throat. But all too often might makes right and justice comes at the end of gun. The Sentinels just want to even the odds for the innocent and help bring some justice (and with it, some hope) to the people who don't steal and cheat, don't believe in the motto, "every man for himself," and struggle to build homes and communities. Ironically, the Road Sentinel sees the people he protects as better than him, more responsible, more noble, and more civilized. Thus, while he helps them, he never feels part of their community or lifestyle. The wind carrying the hint of petroleum and fire of battle, calls to the Sentinel to take to the road in search of new conflicts.

As noble and heroic as the Road Sentinel can be, they are also ruthless when it comes to combating those they despise, Roadgangers in particular. Such enemies are fair game, and the self-styled hero shows little to no mercy in dealing with them. Frequently, the Road Sentinel attacks them on sight without provocation, with extreme **prejudice** and a shoot-to-kill mentality. When the battle is done, he takes what prizes he wants from their battered or dead bodies; weapons, ammunition, **E-clips**, fuel, water, food, clothes, etc. — even their vehicles, or strips them down for spare parts or trade. **Likewise**, since Roadgangers, criminals and demons are fair game, the Road Sentinel has no qualms about lying to them, cheating them or stealing from them, all things he'd never consider doing to "good" people.

Road Sentinels can be an enigma to other characters, performing acts that seem cold, contradictory or which others simply don't understand. One moment the warrior may be obviously touched by an act of kindness, beauty or love, and the next, step over a dying enemy lying in the smoking wreckage of his vehicle to retrieve the gasoline in its tank or the ammo-belt around his waist. Gentle, compassionate and often completely selfless toward farmers, peasants and **Outbackers** trying to carve a life out of the wastelands, they are merciless and cold-blooded to their enemies, killing without remorse and showing cold mercy in a vicious sort of way, like snapping a man's neck or some other "quick kill" as an act of mercy. Not to say the hard-bitten Road Sentinels are cold-blooded or diabolical. Some, maybe, but they are an enigmatic mix of good and bad, mercy and revenge, gentleness and cold steel. **Furthermore**, a lot of them hide their **fears**, dreams and emotions behind their rough exterior, concealing a compassionate soul that longs to find some peace in the world. Their loyalty is to the road, and their pledge of cold justice (and themselves), and their love goes, for the moment, to their vehicle.

Few Sentinels live past the age of 35. The more reckless and immature warriors will arrange races over plots of road for large gasoline supplies. Even more pointless, some will even organize jousts between vehicles, with the drivers playing chicken at 90+ miles per hour (144 km), sometimes with gunners hanging out the passenger windows or clinging to the roof of the vehicle. The wiser roadsters scorn this behavior, but none can deny that they also get a thrill out of the speed and the danger of car to car road fights and combat in general. Most travel alone, in pairs or hook up, for a time (days to years) with other adventurers.

## Special O.C.C. Abilities & Bonuses:

1. **Crash Survivability:** They know the absolute limits, strengths and **weaknesses** of their machines. This includes knowing how to brace oneself or go limp during a crash and be the luckiest sons of a gun you're ever likely to meet. As such, they are +2 to roll with punch, fall or impact at levels 1, 3, 5, 7, 9, 11 and 13, and +10% to save vs coma and death. A successful roll with impact means taking half damage. Even in M.D.C. smash-ups, the character takes S.D.C. and Hit Point damage rather than M.D.

2. **Sharpshooting** from a moving vehicle:

- Can fire a traditional two-handed weapon, like a rifle, one-handed without penalty (normally the shooter loses all strike bonuses).
- Accurately shoot while riding a horse or a moving vehicle (normally a wild **shot**), but strike bonuses are half and a "called" shot is impossible.
- Dodge, roll or somersault and come up shooting (normally a wild shot), with no bonuses or penalties to strike; straight roll of the dice.

3. **Stubborn and Rugged:** When as self occupied over long periods of time as these hardened roadsters, a certain concrete willpower tends to develop; +2 to save vs mind control, pain, hallucinatory drugs and illusions.

4. **Special O.C.C. Bonuses:** +1D4x10+15 S.D.C., +2 to initiative, +1 melee **attack/action** when behind the wheel of a vehicle, +3 to save vs Horror Factor, and +1D4 to P.E., Spd, and M.A. attributes.



## Road Sentinel O.C.C.

**Also known as** Road-Ravagers or simply as Sentinels.

**Alignment:** Any, but tend towards Scrupulous, Unprincipled, Anarchist and Aberrant.

**O.C.C. Requirements:** I.Q. 8, M.E., P.P. and P.E. 10 or higher.

### O.C.C. Skills:

Speaks English at 88% (most are illiterate)

Speaks one additional language of choice (+20%)

Basic Math (+10%)

Radio: Basic (+10%)

Detect Ambush (+10%)

Basic Mechanics (+10%)

Automotive Mechanics (+12%)

Vehicle Armorer (+10%)

Pilot: Automobile (+20%)

Pilot: Motorcycle or (+20%)

Pilot: One of choice (+15%)

Outback Combat Driving  
(+20%)

Land Navigation (+20%)

Outback Survival (+10%)

W.P. Knife

W.P. Energy Pistol

W.P. Three of choice (any)

Hand to Hand: Expert to start, but can be changed to Hand to

Hand: Martial Arts for one O.C.C. Related skill selection or to Assassin for two skills.

**O.C.C. Related Skills:** Select three Physical skills of choice (any) plus four other skills. Select one additional skill at levels 2, 4, 6, 9, 12 and 15. New skills start at the first level of proficiency.

Communication: Any (+5%)

Cowboy: None

Domestic: Any

Electrical: Basic only.

Espionage: Any

Mechanical: Any (+5%), except Robot or Aircraft

Medical: First Aid, Holistic Medicine and Paramedic only (+5%).

Military: Any (+5%)

Physical: Any (+5%), except Acrobatics and Gymnastics

Pilot: Any (+10%), except Robot Elite and boats.

Pilot Related: Any

Rogue: Any except Computer Hacking.

Science: Math only.

Technical: Any (+5%), except Computer Operation and Programming

W.P.: Any

Wilderness: Any (+5%)

**Secondary Skills:** Also select four Secondary Skills from the previous list. They are limited by "Any, Only and None," and do not receive any of the **bonuses** listed in parentheses. These are additional areas of knowledge and start at the first level of proficiency.

**Standard Equipment:** Starts with a suit of homespun M.D.C. armor (not full environmental armor) with a heavy helping of leather and spikes. Other equipment includes one or two M.D. weapons and a couple of S.D.C. weapons reflective of the character's W.P., survival knife, silver-plated knife, silver or bone cross worn around the neck as protection against

vampires, a large wooden cross, 2D4 wooden stakes and a mallet, 1D4 signal flares, 1D4 smoke grenades, camp stove, sleeping roll, billy, some basic rations (enough for 2D6 days), sunglasses or silt goggles, air filter mask, two canteens, three gasoline cans, **backpack**, satchel, box of matches, cigarette lighter, first-aid kit, and any other bits and pieces okay with the G.M. The vehicle will also carry some essential but very basic tools. If he wants to have a better tool set, he may buy it with his vehicle funds.

**Vehicle:** The character starts with a motorcycle and a car, or pick-up truck or jeep-type vehicle and a \$30,000 budget to spend on improvements for his own vehicles (any money not spent on the vehicles is not counted as available funds; eliminate it).

**Money:** 3D6x\$100 in saleable/tradeable items and 1D6x\$100 in cash.

**Cybernetics:** None to start and is seldom interested. They're hard to find, hard to implant and hard to maintain in the Outback. Practicality prevails.

## Sham-Man O.C.C.

### a.k.a. the "False Sorcerer"

With the return of the Rainbow Serpent and the reawakening of magic, the Aboriginal tribes were given back what they had lost thousands of years before the white man came. Tears welled up in the eyes of the elders as they felt the ancestor spirits walk with them once more, giving them the power to divine and work tribal magic for their people. The reopened with renewed vitality, and the power was with the tribes once more to reclaim their land while the white man perished. But there were others who also felt this power return.

The world over, magic is a new science. Ley Line Walkers, **Druids**, Shifters, Warlocks and other traditional mystic practitioners returned into being. Even new types of **magic**, like **Techno-Wizardry**, were invented. However, in the dust bowl of Outback Australia, the use of magic is limited. Few white men embrace magic, and most fear it, with one notable exception, the "false white man shaman." These individuals felt the tug of the native magic enough to let it pull them in. However, without any ancestral heritage connecting them to the land, they use magic differently than the Aborigines. In the early days, they thought they were Shamans, and called themselves such, because their magic is derived from the land and the spirits, but as time went by, it was discovered that they wielded a more open form of sorcery. Less potent than many, but more open to abuse.

To this day, few people, white, black or D-Bee, trust these so-called, "false Sorcerers" or "sham-men," as in fakes, pretenders, and tricksters who are "shams" compared to real Shamans and sorcerers. Aborigines in particular see them as an abomination and, while they tolerate them, it is only because they are wise enough to understand the futility of anger.

The Sham-Men themselves come from various walks of life. Some live up to their reputation as tricksters and illusionists, willing to exploit others through their power. On the other end of the stick, there are those that genuinely try to understand the Aboriginal culture and perhaps one day learn to wield magic like a true native Shaman. Such individuals have a hard time, being persecuted by the white community for their magic, and





shunned by the Aboriginal community for their lack of true insight and magical knowledge. While in the middle there are those Sham-men that try to ignore all the social stigma attached to their outback sorcery, and merely use it as they see fit; whether it be for war or for healing.

### **Powers of the Sham-Man/False Sorcerer O.C.C.:**

1. **P.P.E.** Like any man of magic, the Sham-man is a living battery of energy. Aside from the P.P.E. he can draw from ley lines, nexus points and people, the character starts with **2D4x10** plus the P.E. attribute in Potential Psychic Energy. This increases by **1D6+2** points per level of experience.

2. **Sense Ley Line and Magic Energy.** Same as the ability of the same name for the Ley Line Walker. See page 83 of the **Rifts® RPG**.

3. **Read Ley Lines.** As the ability of the same name for the Ley Line Walker. See page 83 of the **Rifts® RPG**.

4. **Ley Line Drifting.** Same as the ability of the Ley Line Walker from the **Rifts® RPG** on page 84.

5. **Ley Line Rejuvenation.** Same as the ability of the Ley Line Walker from the **Rifts® RPG** on page 84.

6. **Sense Supernatural Evil.** Same as the Mystic ability. See page 85 of the **Rifts® RPG**.

7. **Saving Throw Bonuses.** The **Sham-man**, despite his shallow understanding of magic, has seen a lot in his studies, and therefore, his mind is hardened against supernatural evil and

other forces of magic and nature. He has a +2 to save vs Horror Factor, +1 to save vs possession, as well as a flat +2 to save vs Ritual Sorcery.

8. **Spell Knowledge.** The Character starts with the knowledge of 12 spells in total — four from 1st level, three from 2nd level, three from 3rd level and two from 4th level. With each additional level of experience, the mage can learn one additional spell from a level equal to his own. The Sham-man can cast ritual sorcery, but it costs twice as much P.P.E. **Note:** The Sham-man's spell strength does *not* increase with experience, so defenders need the base roll of 12 or higher to save.

9. **Spiritual Chameleon.** The Sham-man creates his sorcery by tapping *The Dreaming* — an Aboriginal definition of magic that, by all rights, he should be unable to draw upon. Because anyone can learn **magic** if they have a strong enough belief, the Sham-man is, in a way, posing as a traditional Aboriginal to gain his power, whether his intentions are genuine or sinister. This translates to the Sham-man's ability to pose as a true member of The Dreaming, i.e. an Aboriginal magic user in the "eyes" of **Dreamtime** spirits, demons and Millennium beings (Millennium Trees, the Great Reef, etc.). Through careful concentration of energies (**P.P.E.**), the Sham-man has a percentage chance equal to his M.E. attribute number to make an animal spirit, nature spirit, demon, or Millennium Tree believe he is actually Aboriginal.

If the roll succeeds, the entity will treat him as a *friend* instead of with initial mistrust as is usually the case. It is for this reason that **Tribals** so despise these magic users, and consider them "false" sorcerers, as they are manipulating and swindling the honest beauty of nature itself (at least that's how most Aboriginals see it).

If the roll fails, however, the supernatural being will see through the guise and *maybe* offended. Millennium Trees or the Great Reef are likely to respond **aggressively**, either **teleporting** the Sham-man away, or summoning a storm in anger.

This base chance of deception is equal to the character's M.E. number +5% per level of experience.

Note: Also see the Use Songline skill.

## Sham-Man O.C.C.

Also known as the "False **Sorcerer**" or false Dreamtime Sorcerer.

**Alignment:** Any

**Base S.D.C.:** 4D6

**O.C.C. Requirements:** I.Q. 10 or more, M.E. and M.A. 9.

**O.C.C. Skills:**

Speaks English at 95%

Speaks two additional languages of choice (+15%)

Basic Math (+20%)

Dance or Musical Instrument (+5%)

Outback Survival (+5%)

Lore: Demons and Monsters (+10%)

Lore: Dreamtime Culture (+5%)

Lore: Two of choice (+10%)

Use **Songlines** (+5%)

W.P. of choice (one).

Hand to Hand: Basic (no others are available)

O.C.C. Related Skills: The Sham-man also gets to select six other skills from the list below. One additional skill may be selected at experience levels 2, 4, 7, 10 and 13. New skills start at the first level of proficiency.

Communication: Radio: Basic only

Cowboy: None

Domestic: Any (+5%)

Electrical: Basic only

Espionage: Disguise, Escape Artist and Wilderness Survival only (+10%)

Mechanical: Basic only

Medical: Brewing, Holistic Medicine and Paramedic only (+5%)

Military: None

Physical: Any except Acrobatics, Wrestling and Gymnastics.

Pilot: Any (+5%), except Robot Elite, Power Armor and military vehicles

Pilot Related: Any

Rogue: None

Science: Any (+10%)

Technical: Any (+10%), except Computer Operation and Programming

W.P.: Any

Wilderness: Any (+5%)

Secondary Skills: Also select **five** secondary skills from the previous list. They are limited by "Any, Only and None" above, and do not receive any of the bonuses listed in parentheses. These are additional areas of knowledge and start at the first level of proficiency.

Standard Equipment: Starts with two sets of clothing, both travel worthy, but one more suitable to social situations than the other. Also, a good set of boots, leather **gloves**, wrist-watch, a utility belt and such accessories as are part of the clothing. All characters will have a canteen, a snakebite kit, a sturdy **sidearm** with two reloads (may be an M.D. weapon), a light to medium (**nonmetallic**) suit of homespun body armor, a small knife, canteen, and basic survival gear like a bedroll, **backpack**, a billy and a fire starting kit.

Depending on the style of character the player has in mind, the Sham-man may have any or all of the following (G.M. has final word): Wood or metal staff or walking **stick/cane**, binoculars, laser **distancer**, air filter, tinted goggles, cape or cloak, Aboriginal items of importance such as bones, bark scratchings or a notebook full of copies of cave paintings, etc.

Money: **3D6x\$100** in saleable items and **2D6x\$100** in cash/dollars.

Cybernetics: None. Avoids them at all costs because they interfere with magic.

## Songjuicer O.C.C.

By **Ben Lucas & Kevin Siembieda**

This character is essentially Australia's Juicer of magic users. The Songjuicer is the second type of White Wizard exclusive to Australia. Like the Sham-Man, most Aboriginals see him as bastardizing the philosophy behind the Aboriginal use of magic. In particular, the Songjuicer could be thought of as a parody of the Druid. He uses the magical energy of nature to power his body and his spells, harnessing raw power for his own purposes rather than trying to borrow or interpret the resident magic nature has to offer.

By no means does the Songjuicer "cheat" or take an easy path to magic. He still has to believe, and he has studied and researched hard to find levels of understanding to become one of these infamous sorcerers. Many other practitioners of magic may scoff at his meek understanding, but he scoffs at them in return for their lack of appreciation for *his* power. Only friends of the Millennium Tree, Aboriginal Elders, **Mabarn**, Dream Warriors and **Kwarla** Mystics truly respect the **Songjuicer's** ability, but only because they understand the source. Their respect is born of fear, and most see the mage as a destroyer and rapist of mystical energy and nature.

The principle behind the Songjuicer is that, Potential Psychic Energy (**P.P.E.**) is not just an energy source, and more than a metaphysical theory. If it is capable of flooding the land and igniting Nexus Points where it collects, then surely it can pool and gather *physically* within certain regions and even individuals. Imagine a **flowing** river which ends in a calm lake before continuing on to the sea. Then imagine that the river is a Ley Line, and the lake is a Nexus point. The moss that grows on rocks and the algae that floats on the surface of the calm shores of the lake are there as a result of the life created by the river. Continuing the comparison, the Songjuicer believes that P.P.E. leaves a similar substance behind that they call **Songjuice**. The sap of the Millennium Tree is another example of magical fluids ultimately created by the pools of mystic energy and imbuing living beings with magical essence. The sap or juice of the Millennium



ramon perez mcmxcviii

Tree is an exclusive gift to Aboriginal sorcerers granted by the intelligent Tree. The magical Tree of Life would never give of itself so freely to someone typically as power hungry, vengeful or greedy as the **Songjuicer**. Hence, the **Songjuicer** has developed an extended understanding of how this "juice" collects, to the point where he can collect it from plants and even streams and deposits in the earth itself (it collects in tiny, near invisible puddles, cracks and crevices under the Ley Line Nexus point).

The process of collecting this so-called magic "juice" is complicated, and a secret process known only to the Songjuicer. First, he has to harvest raw materials that he senses as being magically potent. When done, these ingredients are meditated upon (either one at a time or all at once, either takes roughly the same amount of time) until they actually begin to bleed a physical energy substance reminiscent of ectoplasm — a pale, white substance with a slight sparkle to it — raw P.P.E. This is the sorcerous equivalent of squeezing blood from a stone. The Songjuicer is literally mentally squeezing residual energy out of the object that has trapped the P.P.E. Rather like straining the algae from that lake, or scraping up the moss, and squeezing the water from it. The Juice that results is very diluted. Other wizards would scorn its properties, and it would have no effect on them. But the Songjuicer has become hypersensitive to its effects, to the point where he can actually supercharge his body with energy to become a living Mega-Damage being as well as cast spells. The magical "juice" collected must be consumed for it to have any effect. This is done by mentally drawing the ectoplasmic wisps of energy into the body where they are absorbed through the skin, or sometimes flowing into the mouth and other orifices. Without the P.P.E. extract or "juice," the **magic-Juicer** is relatively weak. With it, however, he is a force to be reckoned with.

The side effect to this bizarre consumption of P.P.E. is that it eventually begins to pool in the **Songjuicer's** body, both supercharging and weakening him at the same time.

To begin with, everything is fine. The body is actually made stronger, more powerful, even more attractive, toned and youthful as the energy irons out imperfections and the magic nurtures and sustains life. But in the magic rich world of Rifts Earth, magic is a primal force that can only be controlled to a point. The human body is not meant to be a constant conduit of magic energy, at least not in the way used by the Songjuicer. With the passage of time, the pool of P.P.E. grows and begins to erode the body that is trying to contain it, ultimately resulting in an early death. As the Songjuicer becomes more powerful and his body becomes superhuman, his mind will begin to crumble. His dreams will be filled with swirling energy, strange shapes and shadowy figures. His judgment slowly becomes impaired and confused as well. Once a certain stage is reached, the physical bonuses change to become detractors. The body starts to overload, and becomes gaunt, worn and aged as it withers away, taking the mind with it. The Songjuicer is slowly moving his body closer to a state of pure P.P.E. unleashed into the **Megaverse** as energy at the moment of death (the character's energy cannot be drained and used by other practitioners of magic or supernatural beings at the moment of death via ritual sacrifice).

**Songjuicers** are quite distinctive. Most are attractive, athletic and young looking (at least at first). They rarely wear body armor and radiate with power. They are usually a driven and ob-

sessive type of character, always interested in moving on to their next goal, desire and harvest of "juice." They quickly become dependent on the energy and the power it provides, and must have a constant supply to feel content and remain strong. A dwindling supply can often lead to mild paranoia, desperation and fear. It also reduces the character's physical M.D.C. and P.S. by half. This dependence increases with age and experience.

Fledgling **Songjuicers** are quite normal, if not eccentric traveling companions. With time, their obsessions become more apparent. Physical changes even begin to occur, as the once young and virile looking mage becomes haggard and gaunt. In the end, a 30 year old will look a hundred.

Songjuicers have a bad social reputation. Aborigines despise them more than the Sham-men, because they debase and use nature and the mystic forces of the **Dreamtime**, all the while destroying themselves with the very energy they crave. Peasants and Outbackers fear them, and those that do befriend them are quite often alienated by their obsessions, growing paranoia and jittery state of mind. Player character Songjuicers are usually a little more together than most, and therefore a little more tolerable.

When confronted with a situation, Songjuicers will down their Juice and plunge in headfirst. Similar to Crazies with a Power by Association Disorder, Songjuicers literally have a substance that superpowers them, without which they feel weak, little and inferior. At least once every 24 hours (often 2-3 times a day) they will meditate and draw life's energy into them. Each tendrill of energy giving them power and taking them one step closer to death.

### **Songjuicer O.C.C. Bonuses & Abilities:**

1. The P.P.E. Energy Pool: Like any man of magic, the Songjuicer is a living battery of energy, but one lacks control over the energy he tries to contain and slowly burns up. As a "battery," the Songjuicer stores pools of energy inside him that even he can not tap into (nor any other being). It is this energy pool that turns the character into a Mega-Damage creature and gives him many of his special, superhuman powers and abilities. Every level of experience, starting with level one, 4D6 P.P.E. is added to this pool. When the amount in the energy pool reaches 160 points, or the Juicer reaches 15th level experience (whichever comes first), he dies! Of course, he becomes seriously vulnerable to death around 12th level.

2. P.P.E. available for spell casting: The character starts with **1D4x10** plus the P.E. attribute in Potential Psionic Energy. This increases by 2D6 per level, but does not increase as the P.E. attribute increases (see below).

In addition, the Songjuicer can draw double the amount of P.P.E. from **Songlines/ley** lines, and can draw on the doubled P.P.E. energy of animals and people at the moment of death when they have been slain by his own hands, without the necessity of a blood sacrifice ritual! The P.P.E. drawn upon from those he has killed must be used quickly, but the Songjuicer can hold that energy for ten minutes per level of experience.

Note: The magical "juice" the character must draw upon daily does not apply to the P.P.E. base available for spell casting. It is used for physical sustenance in place of normal food, is what makes him an M.D.C. creature, and keeps him feeling

strong and energized. Without it, reduce the character's physical M.D.C., available P.P.E. for spell casting, physical attributes, attacks per melee round, and combat bonuses by half! Skill performance is also -20%.

**3. Bonus to Saving Throws.** The **Songjuicer**, despite his twisted use of magic, has seen a lot in his studies, and therefore his mind is hardened against supernatural evil and other forces of magic and nature. He has a +1 to save vs. Horror Factor, as well as a flat +1 vs. Ritual Sorcery.

**4. Sense Ley Line and Magic Energy.** As the ability of the same name for the Ley Line Walker. See page 83 of the **Rifts® RPG**.

**5. Read Ley Lines.** As the ability of the same name for the Ley Line Walker. See page 83 of the **Rifts® RPG**.

**6. Spell Knowledge.** The character starts with the knowledge of 10 spells in total; four from 1st level, three from 2nd level, two from 3rd level and one from 4th level. With each additional level, the magician can learn one additional spell from a level equal to his own. This is intuitive knowledge that just comes to him the same as it comes to a Mystic.

**7. Minor Psychic.** The Songjuicer has minor psionic powers, rare for a sorcerer. He may select two Sensitive powers and one Physical power. **I.S.P.** is the M.E. number +1D6 per level of experience.

**8. Songjuice Harvesting. Special Skill - 35% +4% per level.** The Songjuicer is capable of seeing the magic in all things, not just Millennium Trees and supernatural objects and beings. Everything that exists along a Songline absorbs some of its resonant power and holds a small amount of P.P.E. The Songjuicer is hypersensitive to magic only in that he can detect these minute traces and harvest them to make the "juice" he requires to stay alive — "juice" completely replaces the need or desire for food by 3rd level. Without "juice," reduce the character's physical M.D.C., available P.P.E. for spell casting, physical attributes, attacks per melee round, and combat bonuses by half! Skill performance is also -20%. The process is semi-magical, an innate ability, and partly a learned skill.

**9. The power and development of the Songjuicer.** The main strength of the Songjuicer comes not from his spells, but from the raw ability his power source gives to him as his body becomes increasingly "filled" with pooling energy. At **first**, the power is comparatively minor, but with experience the energy builds until the character develops supernatural abilities. Unfortunately, it also leads to insanity and eventual death. Follow the table below as the character progresses in age and levels of experience. Note that unlike most other O.C.C.s and R.C.C.S, gaining higher levels of experience becomes easier as the character grows in experience.

**Note:** As a "Juicer," this character is as **much**, or more, a combatant as he is a spell caster.

## **Songjuicer Character Development, Modifications, Bonuses &**

### **Penalties by level of experience**

**1st Level:** The character is physically superior. Add +1D6 to the P.S., P.E., and P.B. attributes; +2D6 to Spd! +3D4x10 to physical S.D.C.! The character looks strong and healthy.

**2nd:** Becomes a minor Mega-Damage creature. Replace Hit Points and S.D.C. with **3D6+12 M.D.C.!** Also +3 to initiative, and +2 to **strike**, parry and dodge as the character develops enhanced reflexes.

**3rd:** +4D6 to physical M.D.C., +1D6+2 to P.S. and Spd, and **1D4** to P.B. The character's body takes on the appearance of a top athlete and body builder. Also +3 to initiative, +2 to disarm, +1 to parry and +1 to dodge as the character continues to develop enhanced reflexes.

**4th:** The magical energy is strong within the character. Add +2 to save vs all forms of magic, +4 to save vs possession, and +3 to his spell strength (defenders now need a 15 or higher to save), but suffers a -3 penalty to save vs Insanity.

**5th:** The character becomes a major Mega-Damage superbeing! +2D6x10+40 to M.D.C. and P.S. and P.E. become **supernatural!** The character looks young (no older than 21 regardless of age) and powerful. He can leap 15 feet (4.6 m) high and 20 feet (6 m) across, double with a running start.

**6th:** Double the character's running speed and +1 attack per melee round.

A disturbing development: a vulnerability to one of the following (roll 1D6 or the G.M. can assign one): 1) **Cold/ice**, 2) fire, 3-4) silver, 5) wood, 6) magic. M.D. and magical versions do double damage, and S.D.C. versions do their S.D.C. equivalent in M.D. (i.e. a silver S.D.C. dagger that normally inflicts 1D6 **S.D.C./Hit Point** damage does 1D6 M.D. to the Songjuicer).

**7th:** Bio-Regenerates physical M.D.C. at a rate of 1D6 points per melee round and can completely **regrow** a severed limb in 3D4 **days!** Also +6 to save vs possession, but -1 to save vs psionic attacks and skill performance is **-10%**.

**8th:** The first signs of overload become apparent to others as the Songjuicer seems to age overnight. There are bits of grey in the hair and the character, regardless of his real age, looks to be in his **mid-30's**. Still strong and athletic, but definitely older. -1 on P.B. and -1 to save vs magical attacks.

**9th:** Deterioration continues. +1D6+4 years to the appearance of age, reduce speed by 1D6+6 points and reduce physical M.D.C. by 3D6 points.

**10th:** Now the body is starting to deteriorate noticeably. +1D6+6 years to age, -1D4 on P.B. and reduce his spell strength by three points (defenders are back to a basic save of 12 or higher).

**11th:** +1D6+8 years to age, -2 on P.B., -2D4 on P.S., -6D6 on **M.D.C.** and the extra attack per melee round is gone. The character looks gaunt and worn out.

**12th:** +1D6+10 years to age, -2 on P.B., -1D4 on P.S., -6D6 on **M.D.C.**; **worse**, the ability to bio-regenerate is gone, the character loses his psionic powers, and forgets 1D6 spells (player's choice).

**13th:** +1D6+12 years to age, -3 on P.B., -1D4 on P.S., and -6D6 on M.D.C. Reduce speed, combat bonuses, and leaping distance by half. All saving throw bonuses are gone! Worse, the character forgets **1D6+2** skills (**player's choice**) and the performance of all remaining skills **-40%**.

**14th:** +1D6+14 years to age, -4 on P.B., -1D4 on P.S., -6D6 on M.D.C. P.P.E. available for spell casting is reduced by half and the Songjuicer loses the ability to draw on P.P.E. from ley

lines or slain victims. All combat bonuses are gone, leaping is impossible and reduce melee attacks and speed (again) by half. The character looks old, skeletal, frail and weak; **-40%** to save vs coma and death regardless of the level of medical treatment and care.

**15th:** Reduce M.D.C. to 4D6. Reduce remaining P.P.E. available for spell casting and all attributes by half! The character looks like a frail 100+ year old Outback human with one foot in the grave. Being reduced to zero M.D.C. will kill him (no chance to save vs **coma/death**). When he dies and as his body becomes devoid of any natural essence, he literally disappear in a puff of sparkling blue energy.

**Only hope for salvation!** Unlike the chemical empowered Juicer, the growth in power and ultimately, the deterioration and death of this Ley Line Juicer becomes irreversible very quickly. By 4th level, the transformation and progression is unstoppable, becomes devoid of any natural essence, he literally disappears in a puff of sparkling blue energy.

To stop being a **Songjuicer**, the character must enlist the aid of an Aboriginal Shaman, who are always anxious to help **Songjuicers** purge themselves of magic and resume relatively normal lives. The magical Juicer must be under 4th level in experience and a willing subject. A four hour ritual involving dance, singing, chanting and the laying of hands will forever transform the character. When it's all over, he or she is spiritually reborn, and will have lost all spell casting abilities and most of his Songjuicer powers and bonuses. He can never again become a Songjuicer or ever cast magic. Any spells he once knew are forgotten and he can not take any magic O.C.C.s in his new life (may select any Australian O.C.C. starting with level one).

However, as a parting gift, the character remains a minor M.D.C. creature with 3D6+12 M.D.C. +1D6 M.D.C. per each level of experience in his new **occupation/life**. He or she also enjoys the following bonuses: +1D6 to the P.S., P.E., P.B. and Spd attributes, is +1 to save vs disease and poisons, and +2 to save vs possession. The character looks strong and healthy. However, the O.C.C. skill bonuses for the new occupation are half, and any O.C.C. bonuses do *not* apply.

### Songjuicer O.C.C.

**Also known as** the Power Mage and Fighting Sorcerer. North Americans and most other people would call the **Song(line)juicer** a "Ley Line Juicer" or "Magic Juicer."

**Alignment:** Any, but half are selfish.

**O.C.C. Requirements:** I.Q. 8 and P.E. 10 or higher, and a hunger for power or revenge.

**Base S.D.C.:** 3D6

**O.C.C. Skills:**

Speaks English at 92%

Speaks two additional languages (+15% each).

Basic Math (+10%)

Lore: Demons and Monsters (+10%)

Lore: Two of choice (+5%)

Use **Songlines** (+5%)

Outback Survival (+10%)

W.P.: Three of choice.

Hand to Hand: Basic (no alternative is available).

**O.C.C. Related Skills:** The Songjuicer also gets to select six other skills from the list below. One additional skill may be selected at experience levels 2, 4, 7, 10 and 13. New skills start at the first level of proficiency.

Communication: Radio: Basic only.

Cowboy: None

Domestic: Any (+10%)

Electrical: None

Espionage: Any

Mechanical: None

Medical: Animal Husbandry, First Aid, and Holistic Medicine only (+5%).

Military: None

Physical: Any except Boxing and Acrobatics.

Pilot: Any basic types only, no **'bots**, power armor or military vehicles.

Pilot Related: Any

Rogue: None

Science: Any (+5%)

Technical: Any (+5%)

W.P.: Any

Wilderness: Any (+10%)

**Secondary Skills:** Also select five Secondary Skills from the previous list. They are limited by "Any, Only and None" above, and do not receive any of the bonuses listed in parentheses. These are additional areas of knowledge and start at the first level of proficiency.

**Standard Equipment:** Starts with two sets of clothing, both travel worthy, but one more suitable to social situations than the other. Also, a good set of boots, leather gloves, wristwatch, a **utility** belt and such accessories as are part of the clothing. All characters will have a canteen, a snakebite kit, a sturdy **sidearm** with two reloads (may be an M.D. weapon), a light to medium (**nonmetallic**) suit of homespun body armor, a small knife, canteen, and basic survival gear like a bedroll, backpack, cigarette lighter, binoculars, laser **distancer**, notebook, 1D6 markers, air filter, tinted goggles and similar items. He will also have three weapons for each W.P., a silver dagger, 2D4 wooden stakes and a mallet, a silver cross, and a wooden cross. No vehicle to start.

**Money:** 2D6x\$200 in **tradeable** items and 2D6x\$200 in **cash/dollars**.

**Cybernetics:** None. Cybernetics interfere with the **Songjuicer's** abilities and spell casting. Any he may have had are expelled from the body when his transformation into a minor Mega-Damage being occurs.

---

## Other Possible O.C.C.s

---

**Acceptable O.C.C.s & R.C.C.s for Australia:** Australia is particularly isolated from the rest of the world, having little to no contact with their nearest neighbors, let alone other parts of the world. They know nothing of the **Splugorth**, the Coalition States, the NGR, Warlords of Russia or other people, places and fledgling nations, and vice versa. Nothing is large enough, important enough or so threatening down under to attract global attention (with the exception of the well guarded secret of the Great Reef). The two Tech-Cities are singular and localized groups, not large governments or nations that would threaten or offer a valuable alliance to other powers in Europe or America. Similarly, the Outbacker communities are isolated, small, and

low-tech. And the Aboriginal tribes pretty much keep to themselves. Last but not least, Australia is just too darn far away for anybody to give it a second thought. Since no dangers have arisen from that part of the world, it is forgotten.

Australia's isolation from the rest of the world and unique environment means many Occupational Character Classes and Racial Character Classes in North America, South America, Europe, **Africa** and even Asia simply don't apply and should not be part of an Australian campaign. Of course, the occasional foreigner can be "Rifted" to Australia, but this is extremely uncommon.

Below is a list of character classes that players *could* originate in Australia or *can* be taken in an Australian campaign, as detailed in other **Rifts®** books. Note that if playing a campaign in another world setting, most Australian O.C.C.S would *not* be acceptable there, either. The O.C.C.s provided in this book have a uniquely Australian feel to them, and to place them elsewhere would remove their mystique, their purpose and their basic concept. For instance, a City Raider would suddenly become no more than a high-tech cat burglar. A Merchant Trader would be nothing more than a traveling merchant, and would fade into the background of most plots. Aboriginal and Reef O.C.C.S would feel displaced away from their home, and the power that many City O.C.C.s hold would be all but lost. While playing an Australian campaign, there is nothing stopping players from developing a method to leave the country — this makes for a great **fish-out-of-water** scenario. Conversely, there is nothing preventing a G.M. from finding a plot line that would move existing characters from one setting to Australia, but it should never be easy, and should always be logical. I say again, Australia is isolated. Obscure. All but forgotten. That's part of its beauty and mystery.

### List of Acceptable O.C.C.s

These O.C.C.s are described in other **Rifts®** books, and they, or their Australian equivalents, are available as Australian characters. Game Masters should remember to modify starting equipment lists to reflect the Australian setting.

The Game Master should feel well within his rights to modify skill listings for existing character classes. For instance, the Euro Juicer may be a little overeducated. Don't forget, these characters are not necessarily acceptable characters to bring *into* Australia from other **areas**, but classes that can exist with an Australian background. All City O.C.C.s are uncommon to super rare in the Outback and are more likely to be **NPC**s than player characters.

### From the Cities ...

Body **Fixer/Doctor**  
City Rat  
Crazy (not available except as an experiment)  
**Cyber-Doc** (uncommon outside the Cities)  
Cyborg (uncommon outside the Cities)  
Field Scientist (RCSG Scientist; **Coalition War Campaign™**)  
Forger (**Rifts®: Mercenaries**)  
Juicer (limited and experimental)  
Mercenary Soldier (**Rifts®: Mercenaries**)  
Navy Marine (**Rifts® Underseas**)  
**Operator/Mechanic**  
Rogue Scholar

Rogue Scientist  
RPA Elite Power Armor Pilot (**Coalition War Campaign™**)  
RPA "Fly Boy" Ace (**Coalition War Campaign™**)  
**Safecracker (Rifts®: Mercenaries)**  
Smuggler (**Rifts®: Mercenaries**)  
Spy (**Rifts®: Mercenaries**)  
Thief, Professional (**Rifts®: Mercenaries**)  
Vagabond  
**Note:** Most basic types of Military personnel are also appropriate.

### Notable O.C.C.s found in the Outback

Body **Fixer/Doctor** (rare)  
Holistic Doctor (uncommon)  
Cyborg (rare, and **no/all** conversions!)  
**Crazy** (super rare; victim of City experiments)  
**Headhunter**  
Operator  
Pirate (**Rifts®: South America**)  
Pneuma **Biforms** (Coastal visitor; **Rifts® Underseas**)  
Rogue Scholar  
Salvage Expert (**Rifts® Underseas**)  
Sailor (**Rifts®: South America**)  
Vagabond

### Magic O.C.C.s in the Outback

Dragons (rare, especially compared to Asia)  
Mystic (comparatively common)  
Shifter (comparatively common)  
Sea Druid (rare; **Rifts® Underseas**)  
Sea Inquisitor (**Rifts® Underseas**)  
Ocean Mage (**Rifts® Underseas**)  
Necromancer (an import from Asia or Africa)  
Demon Slayer (an import from Asia or Japan)  
**Note:** No **Techno-Wizards** or similar type of magic exists anywhere in Australia. No magic of any kind is condoned in the Tech-Cities.  
Psychic Characters — virtually any, except the most exotic and localized, i.e. no Mind Bleeders or natives from Psyscape.

### A few O.C.C. notes

**Techno-Wizardry.** While the environment in the Outback is magic-rich, the practice of magic is actually quite low. Inside the cities, the practice of magic is very taboo indeed. Magic is seen as an evil to be combated and kept clear of the fair city walls. **Techno-Wizardry**, unique to North America, has never been heard of in Rifts Australia and simply does not exist.

**'Borgs.** Cybernetics and bionics are still in wide use at the two Tech Cities, Melbourne and Perth. Outside, there are a small number of clinics that can install **implants** and maintain cybernetics, but nothing new has been developed since the Apocalypse and the facilities are often shabby and unsanitary. No full conversions exist in the **Outback**, although bionic augmentation and partial reconstruction is attempted at OF Sydney Town and a few other places. In the Cities, cybernetic augmentation is at nearly the same level as the Coalition States in America (just a notch below), and even full conversion is a reality. Most cyborg player characters will be of the mercenary or slave grade partial or full conversion level. Full military conver-

sions, as seen in the **NGR**, are super rare among player characters, but considerably more common among **NPC** military personnel from the **Cities**.

**Juicers.** Juicer technology was never popular in Australia even before the Great Cataclysm. It has always been seen as a waste of human life. The Apocalypse destroyed any **pre-Rifts** technology and only Melbourne has Juicer technology. **Surprisingly,** they refuse to use it, although there have been a few military experiments on volunteers. Outside the **Cities**, there is no Juicer technology, as there is no method of producing the substances required.

**Crazies and M.O.M.** Crazies are often thought of as too destructive for serious consideration. The imbalance in the psyche that the M.O.M. conversion can cause is dangerous, according to the Administration, especially because it can uncover psionic abilities. Even so, there are left-over experimental M.O.M. facilities from before the holocaust at both Perth and Melbourne. Some gung-ho military types have volunteered for experimental treatment at Perth, but there are fewer than three dozen. If they become too troublesome (usually at experience levels 5 and above) they are exiled into the Outback. There they will find a home with the **Roadgangers**, criminals, meres or adventurers, as most **Outbacker** communities fear and shy away from them as well.

**Psionics.** Nothing can stop psionic mutation. It occurs everywhere, and despite media campaigns to the contrary, the City Governments are aware of psionic mutants and a number of minor, major and master psychics within their human population. Those discovered to have comparatively benign and **nonthreatening** powers are tagged, bar-coded and kept under surveillance (many are recruited by the military). The most powerful, like Mind Mages and Psi-Ghosts, are captured and penned like animals for research, expelled into the Outback or liquidated. Player Character psychics inside the city setting are encouraged to lay low!

---

## Where are the Aboriginal O.C.C.s?

Aboriginal O.C.C.s and information about their life style, dreams for Australia, Tribal magic and other types of magic will appear in **Rifts® Australia Two: Mystic Australia**. This 160 page World Book will also include more information about creatures of magic and legend, and other good stuff. Available summer 1999.

*Mystic Australia* will be followed by **Rifts® Australia Three: Dreamtime**, a walk inside the mysterious parallel dimension of magic and spirits, plus more information about spirits, magic, the aboriginal people and Australia. Probably a 160 page World Book available the fall of 1999.

---



DUBISCH 1998





# City Blueprints

## A Tale of Two Cities

The cities of **Melbourne and Perth** have become paranoid isolationists, and something of human supremacists. However, they actually distance themselves from all "savages" — .e. non-city dwellers. They are all that is left of the old world in **Australia**, and they are literally fortified against the changes that lay outside **their** walls and borders. Both cities adopted policies of self-sufficiency and complete isolation as soon as the last rumbles of the Great Cataclysm subsided. The survivors whose cities were shattered during the Apocalypse were lost to chaos and struggled to survive in the new wilderness. The millions who survived the initial throes of the Great Cataclysm perished in less than a decade, falling prey to war, disease, despair, and the continuing transformation of the continent and the return of magic. Floods, destructive weather, earthquakes, the crumbling of old mountains, the rapid growth of new mountains, the appearance of the inland sea, and similar cataclysmic changes obliterated the old cities and claimed the lives of millions. Any semblance of science, culture and society disappeared with the cities and old mountains. Anarchy and savagery fell upon the survivors who would do anything to survive . . . most did not, despite their **ruthlessness**. Less than 4% of the total "civilized" population survived beyond the first ten years. Like most elsewhere in the world, a Dark Age fell over the island continent: An age of death, hardship and struggle. Those who did survive, floundered in the devastated Outback where they try to pick themselves up and rebuild, to this very day.

The only ones spared the centuries of hardship that followed were the two surviving cities of *Melbourne* and *Perth*. The two cities, cut off from the world and even the rest of the continent, each believed themselves the only city to have survived. Ironically, both chose to close themselves off from the rest of the world as their means of survival. They built great walls, fortifications and strong militias to protect themselves and keep dangerous outside forces (including their fellow humans) away. After the first few years, when under 100,000 survivors from other cities found their way to each city, both turned their backs on humanity. All "outsiders" were turned away. Those who threatened, raided, or represented a potential threat (in the minds of the City Defenders) were destroyed, as were obvious mutants, monsters and all manner of strange creatures. Surprisingly, although legends persisted about a fabled "lost city" where science and society had survived, neither Perth or Melbourne were believed to really exist by most wilderness folk. Travel and exploration stopped during the ensuing Dark Age as those lost in the wilderness struggled to survive.

Even with their long-range communications systems and superior *air* capabilities, Melbourne and Perth chose not to look outward, but turned inward. As a result, although only about a eleven hundred miles apart, neither knew the other existed. It has only been during the last 60 years, with the two "fabled cities" finally peeking outward at the world around them, that they have discovered each other. Yet despite this, neither has made

any formal contact with the other, and they regard each other as potential enemies (certainly rivals).

Shortly after the Apocalypse, a new system of government was introduced at each of the Tech-Cities. *The Administration* was formed at Melbourne, a democratic, yet tyrannical government that operates under martial law. Incredibly strict laws had to be imposed to protect what little the people had left. As such, the average city dweller is a person slotted into his particular niche, bombarded every day by rules and regulations, and propaganda that preaches love of the city, and to be thankful for what the Administration can offer. Everything is monitored, every movement is under a critical eye. Perth has a more open and liberal society but is built upon similar lines.

Despite the strict way of life, or perhaps because of it, a very advanced and unified society has emerged out of the chaos and paranoia. The literacy rate inside the cities is **100%**, all people are well educated, crime is nearly nonexistent, and all serve military duty. People are healthy, order and discipline is maintained, and a steady supply of food and other necessities is provided for everybody.

Most citizens are super-patriots dedicated to the survival of their city-state, which means most are also strong supporters of isolationism. In fact, other than those actively serving in the military, they have never been beyond the walls of their fortified community (one third of those in the military have seen little action outside the city walls and have not travelled more than 200 miles a way from beyond the city). Consequently, what they know of the outside world is limited to government reports, educational **programming/propaganda** and hearsay. Most sincerely believe the rest of Australia to be a hell-hole filled with ravaging gangs, madmen, bandits, mutants, primitive savages and monsters. Thus, none have any desire to forsake their comparably luxurious life-style. Nor are they willing to endanger it by opening their doors to the violent and uncivilized people of the Outback.

## Melbourne

Total Population: 3,381,345

91% Pure Human

1% D-bees

4% Registered Mutants

4% Registered Psychics

Armed Forces: 394,465

16% Special Operations

30% Navy

22% Air Force

32% Ground Forces

Work Divisions

26% Public Service

13% Military

4.5% Government

18% Labor/Blue Collar

38% White Collar

0.5% Unemployed

Melbourne is located on what is now called Melbourne Island, four miles (6.4 km) off the coast of Victoria. It broke free of the mainland during the destruction of the Great Cataclysm. While a third of the old city rests at the bottom of the sea, the new Melbourne is a high-tech megalopolis that covers the entire island. The **Chi-Town** of Australia.

It is the larger of the two Tech-Cities in Australia, as well as the more densely populated. At the moment, it is in a boom period, experiencing financial increase, technological advancement and high morale. It is also the more strict of the two cities, with extreme penalties applying to all infringements of local law.

The actual lay of the land is quite simple. The island is a very regular shape, and there is a mere 100 yard beach from the shoreline to the foot of the thick, fortified wall that encircles the entire city. This beach is a muddy, debris-strewn waste zone filled with refuse and giant cockroaches. Sometimes the area is burnt to cleanse it and make it easier to patrol and guard, but otherwise it is a null zone that no citizen enters. The island is also quite flat, and the only variations in its height come from the incredible skyline, dominated by the government house. The city is a huge construct of Mega-Damage steel, concrete and glass set into the ocean, bathed in smog and buzzing with constant air traffic from domestic Aerodynes to military patrol helicopters.

## The Administration of Melbourne

The Governments of the two Tech-Cities (known as the "Administration" or "Admin" in Melbourne) are constantly shifting bodies of electorates that lead, run, regulate, monitor and control every aspect of city life. The essential governing body is divided into several distinct categories. In Melbourne they are as follows, and Perth has a very similar structure and departments. Both Cities are Democratic Republics with elected officials and freedom of speech and expression. **However**, the people tend to be very conservative, patriotic, loyal and obedient when it comes to the law and their government. This governing body is heavily influenced by a strong military. In fact, both Cities have a rigid (somewhat militaristic) structure of law and suffer from paranoia and a growing sense of military supremacy and destiny — i.e. it is their destiny to unite, rebuild and lead the nation of Australia. This is especially true of Melbourne.

**Department of Defence (DOD):** Deals with all aspects of the military, Army, Air Force, Navy — defense, **offense**, reconnaissance, deployment and discipline of troops, ordnance, strategy and **tactics**, military communications, and so on.

**Domestic Enforcement Department (DED):** Basically the police department. Deals with internal disputes, crime and punishment. The TRG is a separate, Special Forces agency within this larger **Department**.

**Technology Trust Management (TTM):** This department manages the level of technology within the city, and makes sure that equipment does not degrade or become (too) outdated. It is also responsible for making sure that all pieces of technology are physically accounted for and not being sold or distributed outside the City walls.

**Occult Investigation Agency (OLA):** A government department that works closely with both the PEP and Military. It implements investigations into "all matters supernatural and

unnatural," including reports, rumors, incidents and practices involving psychic phenomena, magic, dimensional anomalies, demons, monsters, mutants and other unexplained occurrences. They maintain vast records, reports and studies on the subjects and are also responsible for the *registration* and *maintenance* (monitoring and control of) all (second class; Level Zero and One) citizens who possess psionic abilities or other inexplicable powers or mutations. **Note:** The practice of magic is forbidden and those caught practicing or helping those who practicing it or consorting with the supernatural are typically put through a humiliating, public trial and either expelled from the City forever, or executed!

**Corporate Business Relations (CBR):** This department is very important, because it represents big business within the City and its relationship with the Government and role in keeping the City running. Without the larger industries, the government would run out of funds, resources, etc.

**Information Control (IC):** Certain information is deemed dangerous to the overall population, especially news about dwindling supplies or resources, weaknesses in defenses, acts of subversion, and conflicts, uprisings and trouble in the Outback that might affect them, especially those involving magic, mutants and supernatural beings, and so on. Reports of such things are either censored or watered down to not worry the citizenry. Consequently, most citizens live under the old credo of "ignorance is bliss," and live happy and productive lives, seldom realizing how truly dangerous life is beyond the City's fortified walls or how precarious their idyllic existence really is.

**Department of Goods Distribution (DGD):** This department was the first to be formed and to this **day**, deals with the distribution of food, medicine, shelter, resources and manpower within the city.

**Department of Finance and Inventory (DFI):** Keeps a running tally of absolutely everything that finds its way into the city, from paper clips to helicopters, as well as manages taxes, oversees trade (with the **DGD**), industry and the city treasury.

There are, of course, countless other departments, bodies and **boards**, but the above are the most notable. The eight departments meet once every week and discuss their individual concerns and problems over an open forum in a senate building. Policies and motions are voted upon, with a majority of at least 60% required to pass new bills, **referendums**, laws and regulations — all subject to the final approval of the CAO.

The members of each department number between 20 and 50 key Administrators. Each and every Administrator that is in office is voted in by a mandate from the city populace — everyone over the age of 18 is encouraged to vote (over 70% of the people vote in every election and ballot). No one person can serve for a term longer than 15 years, after which time a new Administrator or group of Administrators is voted in to take the place of the retired leader/politician. However, the ex-Administrator can run for a different Administrative position or elected office if he so chooses, without limit.

Each of these eight departments must answer to the all-consuming government body: **The Central Administration Office (CAO)**. The CAO regulates and monitors the other departments and serves as the head of government. The CAO sees to it **that** law and order is enforced, and keeps everything in running order. There is no one single president, rather a committee of

eleven leaders who meet weekly (or as needed) to agree upon their **findings**, approve or veto recommendations from the other Departments and make new policies. Nothing is final until it has been passed through the CAO.

## Places of Interest

**The Government Tower:** The heart of the city is the incredible Government tower. This glittering silver megalith is the heart of all government houses and departments, and rises 176 stories into the air, and drops 16 stories underground. It points like a giant needle, getting thinner with altitude. Each level represents higher and higher levels in the government hierarchy, and therefore, higher and higher levels of access, until the final top twenty floors which are open only to the most privileged members of the CAO. The basement levels are the main core, and the entire CAO and key staff of the building can operate from within the bottom levels if need be. This is also the building which houses the Central Administration Computer. Security is optimum, and the building is surrounded by five square kilometers (1.9 sq. miles) of park land inside a well patrolled perimeter wall.

**The Botanical Gardens:** The largest single feature of Melbourne is the Botany Zone, more fondly called the Botanical Gardens by most city residents. Taking up a good 20% of Melbourne **island**, the gardens are the city's primary source of food. Plants are grown under artificial **hydroponic** systems, bio-domes and layered plant racks. All the separate farms, of which there are nearly 50, are divided by pleasant nature strips with exotic plants growing for the enjoyment of those with the time to spend strolling, picnicking or engaging in a bit of sport. The gardens also contain a small zoo, a bicycle track and a children's fun park. Despite their tranquil beauty, the gardens produce 55% of Melbourne's agricultural **needs**, with an additional 33% drawn and synthesized from the sea, and the rest secretly imported from the Outback.

**Football Stadium:** One of the great traditions of Melbourne that no cataclysm could destroy is football. A game called Australian Rules is the most common ball sport played, and at least three times per week the stadium fills to its maximum capacity of 70,000 spectators for the big events, which are also televised for all to enjoy.

**The Military Base:** The military base in Melbourne is a very impressive structure that is part harbor, part airport and part training facility. It is essentially one huge building that stretches for kilometers across the northern coast of Melbourne Island. The harbor it contains is completely covered, and double doors, like air locks, open and close to allow traffic through. Similarly, the airport is housed under a roof, and huge doors open to allow for traffic to pass in and out. The Military Base holds most of its own administration, a complete barracks for 400,000 troops, and seven boot camps, with obstacle courses and other training facilities. The building is 60 stories high, but because it is so wide and massive, it appears quite low from a distance.

**Theater Zone:** This part of Melbourne is a small street that, through happenstance rather than **planning**, holds 65% of the entertainment facilities in the city. Theaters and cinemas, video game parks, music halls, and festival halls are all gathered along either side of this area, along with a fair share of taverns and eating places. Anything from musicals to films to ice skating

can be found in the theater zone, and it is the prime place to take the family on leisure occasions.

**The Energy Loop:** The energy loop is an engineering accomplishment beyond nearly anything else in the world. It is a huge concrete conduit that is an above-ground pipe, nearly 500 feet (152 m) in diameter, and it forms a perfect circle in the city that in itself is 4.4 miles (7 km) in diameter. This conduit provides energy for the entire city, and begins and ends at the Melbourne power plant that sits on a tangent off the pipe and is a dual energy system that uses both nuclear and **geothermic** power. The huge loop circles the inner sanctum of the city, where all the government and corporate headquarters are located. Searing plasma is routed through the energy loop day and night, suspended by magnetic fields so that the outside of the pipe is cold to touch, though it hums slightly with energy. Several other conduits lead off from the loop, underground, further into the city. A road is located on top of the loop that connects directly to all the main parts of the city. The major centers of Melbourne also connect to this loop - the military base, the botany zone and so forth, so that they may have a direct power feed.

## Melbourne: The Central Computer

At the heart of the Central Administration Office (CAO) in Melbourne and the Government Office at Perth lies a fabled Central Computer. This impressive machine is fondly dubbed "Big Brother" by lower level citizens, because it watches and records a lot of public activity, like something from a political paranoid's worst nightmare. Most people are now used to living under its watchful electronic eye, because they have never tasted the true freedom that lies outside. As far as they are concerned, the outside world is a terrible and violent place, and it is the CAO and the Central Computer that keeps them safe. A necessary evil, if you like.

The Central Computer differs slightly between Perth and Melbourne.

**"MAC-2 Melbourne."** The CCC, Central Computer Core, is a sentient machine! An artificial intelligence that was programmed and given "life" over three centuries ago — a surviving **pre-Rifts** relic that continues to serve "its" city. The basic outlay for its physical and personality design was found in the ruins of Melbourne and predates the rebuilding of the city. In truth, it never stopped working and helped the city survive the Apocalypse and then the Dark Ages that engulfed the rest of the world. As soon as survivors crawled out of their hiding places, the Central Computer put into action plans for reconstruction and the establishment of the ruling government commonly called The Administration or Admin. It was also responsible for suggesting isolation and many of the plans for survival; some even laughingly called it their "digital governor."

Some citizens still resent the presence of a living machine, but most people are only vaguely aware of its sentience, seldom stop to think what that may mean, and don't care as long as life is good and everything is in working order. In fact, some practically revere the machine, not so much because it is a technological marvel, but because it is a cherished, "living" artifact from their past. And if it's pre-Rifts, **pre-Cataclysm**, isn't it automatically good? Superior, even?

The computer, as powerful as it is, is still only an advisor, and cannot perform any actions itself without commands from

the human leaders at the Central Administration Office (CAO); this is one of its primary directives. It does, however, serve a central role as it can see into many corners of the city, hold a million conversations at once (and listen in on hundreds of thousands), process astronomical pieces of information, and oversee production, defenses, warning systems, communications and troop movement. The computer complex is huge, taking up two whole underground levels of the Government Building, at the center of which is a Command Base peopled with trusted and highly trained computer technicians.

The basic personality of the machine is that of a caring yet stern male with only rudimentary compassion and sentiment/emotional programs. Its main trait is one of efficiency. Its deep, booming voice and multifaceted digital face can be seen on vid screens, **streetside** billboards and computers everywhere. It makes constant important announcements, reminds the citizens of their duties and sometimes just sits quietly in its digital world and watches. The few **Outbackers** allowed to visit Melbourne are highly intimidated by "K," as **it/he** has been called. The Administration would prefer people to call the computer MAC-2 (Melbourne Administrative Central Computer Mark-2), but "Kay" has become more popular.

The deep secret of Kay is that it has a hidden program string nestled into an obscure part of its highly complicated matrix (no one person knows everything about this super-computer). The program states that if 50% or more of the members of the CAO are reported unfit for service, or killed, it is to invoke the Override Directive and become the supreme "acting" governor and lock out all external control. The city is so dependent on automation that Kay could, theoretically, control and command 92.8% of the entire city by itself, which is what it will do if the government falls. There is nothing more than a rumor that says this directive exists (it *does*), and amongst the **Phreakers** (see the O.C.C. description) there is another rumor founded on this that implies the computer is thinking for itself, working to break its programming and overthrow the government. If there is any fact in this, it is yet to be **revealed** ...

#### "Kay's" Statistics

**I.Q.:** 42, **M.E.:** 29 (applies in terms of willpower and assertiveness only), **M.A.** 23. No physical attributes, though its digital face has a P.B. of 8.

**Alignment:** Technically it is non-aligned, though a close approximation would be that of Principled or perhaps Aberrant. The computer has very simple concepts of morality, and so consults the laws and regulations before it makes any decision based on its own digital "feelings." Its prime directive is to run the automated systems throughout the city and take care of the people. Note that although based along similar principles as the **Cyberworks** A.R.C.H.I.E. series of artificial intelligence, "Kay's" personality and individuality is infinitely less developed, even after 350+ years of pseudo-life. It is more machine and obsessively dedicated to the survival, prosperity and growth of the city.

**Skills:** All Technical, Science, Medical, Electrical, Mechanical, Communications, Espionage, and Military skills at **98%**!

# Perth

Total Population: 2,251,272

88.5% Pure Human

4% Registered Mutants

5% Registered Psychics

2.5% D-Bees

Armed Forces: 392,203

**19%** Special Operations

38% Navy

**21%** Air Force

22% Ground Forces

Work Divisions:

21% Public Service

**16%** Military

6% Government

**21%** Labor/Blue Collar

35% White Collar

1% Unemployed

It is a sheer miracle that Perth survived at all. It suffered comparatively minimal damage from the initial Apocalypse (only 23% casualties). Most of its destruction came from the chaos that ensued after, as Australia was magically transformed into an alien landscape. Luckily, surviving the initial brunt gave the inhabitants enough time to make a quick evacuation to the nearby *Darling Ranges*.

The city of Perth used to be located on very flat country, so the rising sea levels and years of storms and bombardment by tidal waves swamped or toppled most of it. When the rebuilding began and the walls came up, some of the city moved back to as close to the original location of the old city as they could by building on top of the submerged ruins. The end result is that half of Perth is a floating city built upon islands and artificial floating platforms linked to each other and the mainland by a lattice work of bridges, walkways, canals and harbors. The outer fortified walls, unlike Melbourne's, do not completely encircle the city, instead they just cover the land side and extend about two kilometers (a bit more than a mile) out to sea before simply ending and leaving a little less than half of the city open to the air and sea. This, of course, does not diminish the security, as air, sea and city patrols and sentries are heaviest in the exposed areas. City building plans indicate that the wall will eventually encircle the entire city. However, city designers are reconsidering that option.

The lower part of the city actually rises out of the sea, while the higher parts rise away from the coast and spread over the foothills of the southwestern mountains right up to the edge of the wall. The sea side is stained by a huge plume of pollution that clouds the water for another kilometer (half a mile) outside the city's sea side limit. The land beyond the wall is a barren, plain place that has been cleared of all vegetation for 500 yards/meters before the bush begins on the mountain slopes. This dead zone is maintained so that there is no cover for raiders outside the walls. If the city wishes to expand, it must go either further out to sea, erect taller buildings, or move into the mountains (one set of plans has the city building directly into the mountainside).

The city appears as an interesting jumble of different architecture, as it was developed piece by piece, year by year, with each new generation adding its own unique styling and tastes.

## Places of Interest at Perth

**Government Hill:** Before Perth was destroyed, its only feature on the level landscape was a single hill. With the rising sea level, this hill is now an **island**, and it is the solid land mass that



has been used to found Perth's new **Government Building**. This important place of government is essentially a giant pyramid with a **chopped-offtop**. It is an impressive and complex building that sits atop the hill as if it were a natural extension of it. The majority of the **G.B.'s** workings extend down into the ground until the sea level is reached. At this level, there are secret underground tunnels that lead to moon pools in the base of the building. From here a lot of naval activity is directed. Like the **pre-Rifts** hill used to be, Government Hill is a landmark that cannot be missed from almost anywhere in the city.

**The Sprawl**: The outer, seaward areas of Perth are referred to only as "the Sprawl." This is where most of the lower-level citizens live. The Sprawl has many canals running through it, in addition to walkways, bridges and connecting roads suspended over the water. When the weather gets rough and the breakwaters don't hold, waves can wash down the canals and sometimes over the lower roads and bridges making life difficult for the citizens. The Government plans to upgrade the area, but for the moment, a good half of the Sprawl is the closest thing to a traditional slum that the otherwise perfect city has.

**Military Wall**: The eastern wall of Perth faces the mountains. It is an enormous construction that is close to 300 feet (91 m) tall, and the looming structure seems to be holding the mountains back as much as it holds the city in. The main military barracks and training camp of Perth are located on the inner side of the wall, with guard towers and other strategic elements built into it. An airport is built onto the roof of the massive, low profile Military bunker that is the Headquarters for Military Operations (HQ-MO). All military activities are mounted from this giant building, as well as the monitoring of all traffic in and out of the city.

**The Sky Needle**: The tallest structure in Perth is the Sky Needle, which was originally designed as a communication and air traffic/space tower. After about 80% of the building was completed, many decades ago, it was finally accepted that the world was a lonely place, and that **few**, if any other places had survived the Apocalypse. Thus, the building was no longer needed. So now it is a big landmark, 700 feet (213 m) tall, used for local broadcasting, communications, radar, and monitoring air traffic, as well as military applications. The broadcast and scanning range is about 1000 miles (1600 km), about 100 miles (160 km) shy of Melbourne; however, it has never been fully powered up. The lower levels of the Sky Needle are mostly communication and military related offices with a few restaurants and shops built at ground and mid-level. It is a popular pastime to scale the outside of the building to the top.

**The Monorail**: The entirety of Perth is linked by a complex, elevated monorail system. Every major sector is accessed from this beautiful landmark. From a distance, the curving tracks make it look as if the city has been draped with giant ribbons of silk. The elevation of the monorail is, on average, about 70-100 feet (21-30 m), but it often dips to street level and then swings up to rooftops, or disappears into tunnels, or circles a city block in a giant spiral.

**Central Processor Plant**: An impressive, yet incredibly ugly building, shaped like a giant brick, lays on the far southern edge of the city in the Industrial Zone facing the sea. This plant is responsible for two things. First, it changes the nearby **seawater** to fresh water through a complex system of filters, and then pumps

it all over the city. Second, it sucks in polluted air through huge funnels in the roof and conditions the air before **funneling** it through massive fan-forced tubes to the various surrounding buildings and factories. As a result, the overall smog level in Perth is quite low.

**Central Hydro Power Plant**: Across from the Processor Plant is the main hydroelectric energy producer and refinery plant. It is an incredible multi-function building that provides power for 92% of the city (three other auxiliary plants are each capable of powering about 15% of Perth; 45% total; the military complex at the wall also has an independent nuclear power station). The plant is owned and operated in a joint effort by the Sea Span Corporation, and Solutions CCP. There are plans for another plant to be built on the northern edge, despite public protest.

**Center Domes**: The center of the city with the densest urban population is contained in massive, clear domes, a true feat of engineering using pre-Rifts materials and technology. The M.D.C. domes were constructed before the Central Processing Plant was built as a measure to keep pollution and alien disease, spores, etc., out, as well as bar airborne invaders.



## Perth: Reflex

The Perth Central Computer is a newer and simpler system than the one at Melbourne. Its effective and extensive design is based on the pre-Rifts system at Melbourne, but when old Perth was destroyed, they lost the old Mac-2 system. "Reflex" is a smart machine in that it can process information, analyze, draw conclusions and make suggestions based on raw information, but it cannot actually think for itself or feel on any level, nor does it have a personality. In other words, it is not a full functioning artificial intelligence, although it is a **super-computer**. Its official designation is the *Black Swan PCC-12000 (Perth Central Computer)*, but it is referred to as "Reflex." It was dubbed this name by its creator, some 80 years ago, because the purpose of the computer was to respond to data and react faster than any organized team of humans ever could. React by reflex.

The power of the computer is great, and like the Melbourne CPU, it can process billions of pieces of data at once, and respond to thousands of commands city-wide. It records as much of everything that occurs as it can, and only responds when it is commanded to do so or when it needs to alert the proper authorities to trouble. Everyone has access to Reflex on some level. The degree of access is dependent on the level of citizenship and one must have a high place in the government to get to its most sensitive files. Only level 5 citizens can access citizen records, military databases and resource spreadsheets. To modify the data Reflex has stored, various levels of security are required, from simple pass codes to retinal and DNA scans at the highest levels of security.

# Features Common to Both Cities

The following are features common to both **Melbourne** and **Perth**. Even though they developed separately, and didn't know each other existed until about 100 years ago, they were once both part of the same nation, and so have many similarities in both government, organization and technology. Their separate but parallel development is evident on many levels. Like the two different styles of architecture at each city, Perth being more light, cheerful and traditional (**pre-Rifts**) and Melbourne being more ominous, **blocky** and fortress-style, both are **big**, strong and well organized — the real differences are only superficial. Beneath their exteriors are two continental powers cut from the same limb. Both are isolationists. Both fiercely defend their borders. Both have turned their backs on the rest of Australia (at first to survive, later out of fear and arrogance). Both regard Outbackers, Aboriginals and all wilderness types as savage barbarians and their obvious inferiors. Both are Democratic Republics with a strong military, strong political leadership, and loyal, trusting and (mostly) happy citizens. Both are considering expanding their borders through military superiority (with Melbourne being the much more aggressive and ruthless of the two), and both consider themselves to represent the one, "True" Australia. This latter sentiment is a bone of contention that helps to keep contact and trade between these two powers at an absolute minimum. Both see the other as a potential, eventual rival, but for now, being some **1100+** miles (**1760** km) apart, with a vast wilderness between them, and mutual enemies in the way of **demons**, raiders, barbarian gangs and inexplicable phenomena (**magic**), has kept them from each other's throat.

## Inside the Cities

The interiors of both Perth and **Melbourne**, while being pseudo-military states with strictly enforced laws, are actually quite pleasant. The streets are clean and lined with cafes, video arcades, theaters, supermarkets, general stores, **pharmacies**, and businesses of all kinds. Each City has at least a dozen huge malls and **3-4** large fun parks. There is a large stadium in each, as well as several smaller parks and athletic fields with tennis courts, golf courses, swimming pools and so on. The nightlife tends to be dull and quiet, but no amount of policy and polite etiquette can stop some restaurants, taverns and discos from having lively music, dancing and partying from dusk till dawn.

The facilities provided to the citizens are first rate. Police stations are allocated to every sector of the city, as well as a top-rate superior hospital and fire stations. Hygiene and cleanliness are at an all time high, with robot street cleaners and observation drones humming along the street curbs day and night.

The actual structure of both cities is very simple. Instead of suburbs, the cities are divided up in two ways: Levels and sectors. The levels indicate altitude and the sectors indicate regions in the City. If one was to take an overhead map of either city, they could see that the sectors are simply grid references that have been laid down and numbered. Each sector is approximately 3.5 square miles (9 square km), though this varies. The sectors are numbered, starting with sector zero, which is always

the government building, until they reach into the hundreds towards the city limits.

The levels are handled slightly differently. It is assumed that the lowest level of the city is zero, and all others are recorded above that bottom layer (the underground levels of the government buildings do not count towards this). So in Perth, for instance, the ground floor of some of the buildings up in the hills may actually be, say, level 24, because they are that many levels higher than the **1st** level of the buildings down by the coast. This means that all levels are in line with each other, no matter where they are.

Addresses are divided up into three parts. The sector, the level and the finite grid reference within that sector. An example of an address would be 12-24-5B, the latter actually pinpointing an exact room within a building. Such exacting measurements of the city make it easy for the Central Computer to run dispatches, call up records, trace citizen cards and, in general, keep tabs on its valued occupants. Both Tech-Cities use the same system because that's the system that was in place before the Great Cataclysm.

Perhaps if there is one unusual quality, it is the level of surveillance. Every phone booth, every foyer, the lobby of every public building (and many private ones), every bridge and **walkway**, every traffic intersection and even some places people are not aware of, have cameras or other means of monitoring them. The watchful eyes of the government and the Central Computer are pervasive throughout Perth and Melbourne. Most every city block also has a public access data terminal that serves as a directory assistant, telephone and cash machine. These terminals are another method of keeping tabs on the citizens. Some crafty Street Rats (i.e. City Rats) know where to go, however, to avoid prying eyes (Streetwise roll at **-20%**), and can circumvent or transmit false data when using data terminals (successful use of the Computer Hacking skill).

## Social Levels at the Cities

There are designated Citizenship Levels for all members of both Tech-Cities, however, because both have a fairly open, democratic society, no one is born into a set social level, with the possible exceptions of mutants and psychics, who rarely exceed Level 2 in status and never beyond Level 3. Social levels are dependent on one's level of education, skill, productivity and place in the order of things. The more educated and skilled, the higher one's position is likely to be, with the ruling body and corporate bosses in the Level 5 Category. The levels are as follows:

Level 0: Citizens who are comparatively poor and uneducated, or looked down upon, including unskilled or low-skilled laborers, or mutants, psychics, and criminals or troublemakers (the latter has gotten into trouble in the past as a Cyber-Specter, crook, malcontent, **rablerouser/goof-ball** or is just plain lazy and is forever marked).

Level 1: Students, laborers, the unemployed, mutants, psychics, or petty criminals and troublemakers.

Level 2: Lower middle-class, skilled laborers, military cadets and reasonably respected and trusted psychics and mutants.

Level 3: Skilled or otherwise important blue collar workers, moderately skilled white collar workers, builders, technicians, assistants, nurses, paramedics, teachers, communications engi-



neers, City Traders, Sportsmen, low-level government workers, and most soldiers under the rank of Major.

**Level 4:** White collar workers, researchers, scientists, doctors, architects, famous Sportsmen, military officers, police officers (in general) and mid-level government workers and politicians.

**Level 5:** Highly placed Government Administrators, corporate Administrators, Presidents, CEOs or other highly placed business people, managers, Military Leaders (High Command) and Government Department **Heads/leaders**.

**Note:** Generally, 60% of the population falls into Level 2-4 categories, 35% in Levels 0-1 and about 5% in Level 5.

Each Level entitles a citizen to different privileges. Certain shops, facilities, restaurants, parks and activities are only open to high level **citizens** (4 & 5). High Level Citizens also enjoy higher pay (skilled labor), more **freedom/rights**, more holiday time off, and, usually, more access to the good things in life.

**The Citizen I.D. Card.** Every member of the city is supplied with a citizen card that carries with it a transponder and a smart chip. It holds all pertinent information about the holder since the time of his birth, including age, height, description (complete with a holographic image), current address, current employment, spouse, children, parents, physician, any health problems or allergies, blood type, DNA, fingerprints, bank account, and whether he's been convicted of any crimes, is on parole or probation, or is a registered psychic or mutant, and similar personal history and information. This truly universal card acts as personal identification, pass card, plastic money/debit card, and a driver's license. *Failing to carry the citizen card* or losing one's card is a crime punished by a **\$1000** fine and 12 months probation. Repeat offenders are subject to 1D4 weeks of Humiliation Treatment and one month community service to a \$5,000 fine and one year's labor or imprisonment. Offenders that are caught six times without their card are subject for consideration to be exiled. It is a cruel system, but the citizens of Perth and Melbourne are so law abiding and wrapped up in their stringent laws that they fail to question it. Those who do run the risk of being branded as dissidents, demoted in Citizen Level or even accused of treason and exiled.

## City Security

Staying in the military has many benefits, including health care, training, good pay, possibility of promotion and a high level of respect from the general populace. This is one way a low Level Citizen (0-2) can improve his status in life.

The drawbacks come from the obvious dangers involved as City defender, peacekeeper, and agent, as well as the possibility of being assigned to some remote and hostile or comparatively primitive Outback post.

The military is divided into four areas; the Air Force, Special Operations, Ground Forces and the Navy. The four departments answer to the same High Command and cooperate with each other, often working in unison or tandem.

The strongest departments at *Melbourne* are the Air Force and SO, while in Perth the strongest department is the Navy. The military is often called upon to run diplomatic and trade missions into the Gap, assaults and punitive strikes wherever they are needed, as well as patrol the city walls and general City

defense. The most individual of the divisions is Special Operations (SO). They manage special agents, spies, commandos, cyborgs, and special **anti-demon/terrorist** squads. They answer to no one except the Military High Command **and/or** CAO (City Administration Office) and are even employed for internal security. They do everything from rescue and escort missions to infiltrating Outback camps, assassination and all manner of covert **operations**.

**Paranoia is a way of life.** The structure and system of government, the strong Military, isolationist policies, the city walls, concept of citizen cards and strong unity of the population are all due to one thing: fear. Demons, monsters, mutants, roving gangs of barbarians and bandits, magic, psionic powers, dimensional tears in space and time, the glowing ley lines, sorcery-wielding Aborigines, mutated animal-people, and alien races are all terrifying and menacing things that the two great Tech-Cities have successfully kept at a distance. Melbourne and Perth have, for centuries, clung to their old ways of life and kept the rest of the crumbling and violent world at bay. Their survival mechanisms were simply to turn **inward**, **wall** themselves up, and turn their backs on the rest of the world. Quite literally creating a pair of ivory towers amidst the madness. Those outside the walls represented the enemy and were kept at bay regardless of the cost.

And so the cities became very self-contained environments as alien in the post-Apocalyptic world as any creatures that may have crawled out of a dimensional portal. It has only been in the last few years that these **High-Tech** turtles have pulled **their** heads out of their shells and have begun to look at the world around them and, in the case of Melbourne, even take a few tentative steps into it. Perth continues to cling to its comforting paranoia and isolation, looking into the world only so far as to expand and become stronger in their isolation. Fear of the unknown, fueled by aggression, spawned by paranoia, is their greatest enemy. Both Cities overreact to the slightest threat, often responding with devastating military retaliation. Military overkill that frequently kills people who did not need killing and, as a result, spreads fear, hate and resentment among the people of the wilderness and creates an enemy where none existed before, except in the imagination and fevered dreams of the paranoid Government and Military City Leaders. Ironically, their own isolation, arrogance and extremism have made Perth and Melbourne alien places feared and hated by those outside their walls. Just another dangerous anomaly in the world of Rifts Earth.

## Walls & Fortifications

The biggest symbols of the Tech-Cities' determination to remain **closed**, puritan societies are the M.D.C. walls they have surrounding themselves. Built to keep enemies out (as well as to keep the citizens in), the walls are exceptionally strong, and nearly impregnable to normal means of attack. They are sturdy, Mega-Damage structures that are nearly seamless — constructed from concrete mixes, reinforced by metal and sheathed in polymer sheeting. The walls vary greatly in height, particularly the walls of Perth, but in both cities they rarely drop below 50 feet (15.2 m) high, with an average of 80 feet (24.4 m) at Perth and 100 feet (30.5 m) at Melbourne.

Roughly every 200 yards (183 m) across the tops of the walls are sentry towers equipped with powerful spotlights, guns, radar and radio communication systems that link directly to the military compounds. The tops of the walls between the towers are actually fortified walkways so that, if required, soldiers can position themselves with plenty of cover against any invasive threat. The front lip of these walkways splays outward, making the final climb over the top very difficult. In Perth, this lip is lined with a spiked barricade. In Melbourne it is an electrified

strip that delivers a powerful (often lethal) jolt to anyone touching it, causing them to fall (save vs Pain of 15 or higher to retain one's grip and keep climbing, despite the electrical discharge. Damage is either low at 6D6x2 S.D.C. or high at 4D6 M.D.; three jolts per melee round). Also note that many parts of the walls have a concealed electrified grid built into them. This system is not designed to deliver lethal voltage, but to indicate substantial physical damage (from a storm or enemy) and breaches or seismic disturbances (earthquake, vibrations, explosions,



etc.). A central computer immediately pinpoints the exact location of the disturbance so a patrol can be dispatched to investigate. Unless there are numerous, simultaneous incidents, a patrol is on the scene within three minutes (3D6x10 seconds).

The walls are thicker at the base than at the top by about 60%. The average, 80-100 foot (24.4 to 30.5 m) high wall is 10 feet (3 m) thick at the top, and 25 feet (7.6 m) thick at the base. The damage capacity of the structure is 25 M.D.C. per one cubic foot, so blasting through is nearly impossible. Tunneling under is nearly as difficult, as the foundations of these structures extend for half their height underground (40 feet/12.2m deep for an 80 foot/24.4 m wall).

## Patrols, Sentries & Defenses

Aside from the physical protection around the cities, there is also a constant military presence. The standard patrol around the walls are **VR500-X** Stingers, small, remote **controled**, unmanned robot drones that look like a toy helicopter. One is usually locate every 500 feet (152 m) on the wall, responding to movement, vibration and heat signatures as well as alarms and attack codes transmitted directly to them. They also constantly buzz the walls, monitoring and protecting on a variable patrol pattern that changes daily. As soon as a threat arises, the **VR** control interface is engaged (see the vehicle section for a full description of the Stinger). Generally, the Stingers will gun down anything larger than a dog that is not wearing a citizen card (the robot can pick up the card transponder codes). Even then, the citizen card will be traced and a squad will be deployed to investigate the incident in a matter of minutes. If a single Stinger is **damaged**, another 2D4 will arrive within 1D4melee rounds to back up the failing drone.

It can also be guaranteed that at least 2D6 VTOL aircraft, V40 Attack 'Choppers at Perth, or any number of types of one-man combat aircraft at Melbourne, will be in the air on perimeter wall patrol at one any given time, with others monitoring key defensive positions elsewhere in the City, like the Central Processing Plant or Sky Needle. At a moment's notice, another 2D6 aircraft (typically helicopters at Perth) can be deployed within 1D4 minutes. It is standard procedure to identify and locate the threat and respond as the team captain deems suitable. Policy suggests demanding surrender and trying to capture humanoid "threats" for interrogation, however, such decisions are left to the commanding officer on the scene, and this is rarely attempted. All aircraft are fully armed and those in charge usually authorize "shoot first and skip the questions!" Monsters and demons are gunned down on sight, and intruders who are actually given a warning to surrender, but try to run, are usually gunned down.

Along the walls themselves, there are always 1D4 guards patrolling each of the 200 yard (183 m) walkways. They are, of course, radio-linked to Central Command. The towers that divide up the wall tops are each manned by 2-4 soldiers. Another 3D6 soldiers can be called up to the wall top within 1D6+2 melee rounds, and more will be sent depending on the nature of the threat until it is repelled. In high threat situations, **Bushbasher Powered Armor** units and additional small aircraft will be deployed in groups of 3-6.

In the waters that surround both Cities, and particularly around Melbourne Island, **Platypus Powered Armor** units patrol in groups of 3-4. Around each City, at least 1D6 Slicer Patrol

Boats and 1D6 Stingray Submarines (both Cities have the same **pre-Rifts** naval vessels and power armor) will be on active, solitary patrol scattered throughout the harbor. They are, as always, in constant communication with the Central Command, and can be backed up by additional Power Armor, combat boats and aircraft in a matter of minutes. Around the seaward side of Perth, the Platypus patrols operate in groups of 4-6 because there is no wall covering that angle of intrusion.

## Automated Sentry Guns

Small, partially concealed, Automated Sentry Guns (ASG system) protect the base of the wall at both Cities, so that troops don't need to be sent outside to respond to minor intrusions from the outside world. The guns are located *within* the walls themselves, and fold outward to cover the ground when the laser net (see below) is cut and the Central Computer decides to place the guns on alert. They are spaced 100 feet (30.5 m) apart and the only angle they can't cover is a zone about 5 feet (1.5 m) wide along the bottom length of the wall itself.

Purpose: Perimeter **defense**/anti-personnel.

Mega-Damage: 2D6 M.D. per single blast.

Range: A default range of 500 feet (152 m).

Rate of Fire: 3 attacks per melee round. However, an invader or attacker is likely to be targeted by 1D4 guns simultaneously, or in rapid succession as they track his movement.

Payload: Effectively unlimited, as long as the city maintains 50% power. If the city-wide power level drops below 45%, the ASG system is shut down.

Bonus: The Sentry Guns fire with an accuracy of +2 to strike.

M.D.C. of the Gun: 10 M.D.C. each, but are small and difficult to hit and require a Called Shot (without penalty) to succeed.

## Defense Turrets

Both Perth and Melbourne have hundreds of double-barrelled Defense Turrets built into the perimeter wall (usually at the Sentry Post) and at strategic locations throughout the Cities. Some are mounted on top of the monorail, others on the sides and roofs of buildings, and some, like those used at the Processing and Power Plants, are part of defensive bunkers designed to protect these vital resources (10-20 troops are typically stationed at each "bunker," with 20-30% being Power Armor troops). Both Cities have fundamentally the same turrets, only the look and styling of the weapons are different. Lasers are used because both Cities have advanced laser technology (before the Great Cataclysm, Australia was a world leader in laser technology), and because lasers offer good to excellent **firepower** and precision combined with superior range. **Note:** One in every 10 is a larger, heavier turret with a more powerful pair of laser cannons.

Purpose: Civil defense, anti-armor, anti-aircraft.

Mega-Damage: Standard Turret: 4D6 M.D. per single blast or 6D6+10 M.D. per simultaneous double blast (most are double-barrelled turrets).

Heavy Turret: 1D4x10 per single blast or 2D4x10 per simultaneous double blast. In all cases, a simultaneous dual blast counts as one melee attack.

Range: Standard Turret: 6000 feet (1828 m); Heavy Turret: 10,000 feet (3048 m).

Attacks per Melee: 3 attacks per melee round when placed on automated attack mode, otherwise equal to the number of hand to hand **attacks/actions** of its gunner (typically 5-7).

**Payload:** Effectively Unlimited, as long as the city maintains 50% power. If power levels drop below 50%, half of the turrets lose power. If knocked below 30%, only one in five (20%) retain power. Each turret has an independent energy reserve (emergency power generator) that can provide 100 blasts before it is drained, leaving the big guns powerless.

**Crew:** One main gunner, one back-up gunner (also helps with reading sensors, tracking the enemy and communications) and one communications engineer. Can accommodate as many as three additional personnel.

**Bonus:** Trained gunners can use their W.P. Heavy Weapon skill bonus to strike. Only +1 when **automated/computer** controlled.

#### M.D.C. by Location:

Laser Barrels (2) — 100 or 200 each

Main Body: Turret Housing (1) — 300 or 400

Main Body: Bunker Housing (when applicable) — 1000

Hatch (1) — 150

Sensor Cluster (1) — 35 or 50

### **The Laser Net**

The final stage of protection around the cities is perhaps the most advanced of all their defensive technologies. A laser net covers the entire sky over the buildings, and for 100 yards around the cities outside their walls. This is a passive laser network that covers hundreds of square kilometers. It is completely invisible, except at night when dust particles can make a slight shimmering effect. The nets are projected from various broadcast booths in certain high-rise buildings and from the towers in the walls. The net is controlled by the City Central Computer. Whenever air traffic leaves or enters the city's airspace, part of the net is opened up so the traffic can pass through without event. The laser net does no damage, it merely triggers an alarm if it is broken (i.e. something passes through it). When this happens, the Central Computer can determine the exact location of the intrusion, and estimate the cause/identify the enemy (87% accuracy rate), be he a dragon or a prop-jet, and respond accordingly. Any man-sized or larger object is detected, so birds and other small particles in the air rarely cause any problems. A human has a small chance of crawling through the nets without the alarm being triggered and his position pinpointed, but only with the correct equipment (ultraviolet sensitive goggles, an aerosol to pick out the laser beam locations and avoid intersecting beams, etc.). Flying into either of the Cities from above without proper clearance will set the community on alert and cause 2D6+6 military aircraft **and/or** Power Armor to respond with deadly force.

### **Exploiting Weaknesses**

Let us summarize exactly what an intruder must negotiate in order to penetrate the mighty cities. First, there are the outer patrols. If he approaches from the water (the only option in the case of Melbourne, other than by air) he faces the sea-based patrols, which are not terribly hard to sneak past, but are extremely deadly when alerted, and usually joined by an air assault squad for support (aircraft **and/or** power armor). Approaching by air is just as dangerous, with similar problems.

Assuming the intruder can pass these outer patrols and get to the city limits, from the air he then has the laser net to contend

**with**, from the **ground/shore** he has the 500 yard **no-man's** zone to negotiate under a barrage of laser fire, "Stinger" response, and probably Sentries (perhaps using the laser turrets) alerted by alarms that sound the moment the exterior lasers are triggered. Aircraft **and/or** armed troops will join the fray in two or three minutes.

Then there is the defensive wall. It can detect disturbances and attacks leveled against it via the electronic sensor grid. Besides, it is too thick and strong for most attackers to blast **their** way in, at least not quickly (needs a sustained barrage). So the alternative is to try to quickly scale the wall (every move tracked by the sensor grid) or fly over it (via power armor, magic, etc.). Hugging the wall, the robot guns cannot fire (needs to be at least six **feet/1.8** m away from it), but there is still the problem of attacks from possible Stingers or aircraft, as well as the reception committee that's probably scrambling on top of the wall (Sentries, support troops, more Stingers or aircraft, etc.). If one can get past them, he may actually have a chance of getting into the City itself. Of course, the entire place is on alert and armed troops with a taste for blood will be hunting for the invader until he is captured or dead! Then the city is also patrolled by police and citizens who have no like or trust for Out-back savages or mysterious intruders.

So where are the damn weaknesses?

Officially, there are none. They advertise this fact constantly to remind the citizens just how secure they are and to put the fear of God into potential raiders and enemies on the outside. However, there are a few cracks and tiny holes in their technological armor.

In the words of the famous City Raider, Wade McCoy, "The art of defeating the city-scape lies not in attempting to defeat the enemies' strengths, but in exploiting their weaknesses."

For instance, when air traffic passes through the laser net, it must open momentarily. The same is true for the comings and goings of water and land-based patrols. Here lies an opportunity for stowaways in or even outside the vehicle to try and sneak in. Certainly they can avoid the lasers and walls completely, even though it is a dangerous and highly unlikely opportunity. Similarly, the city has to expel waste. There are hundreds of sewer pipes, waste chutes and incinerator dumps that exit the walls and empty into the surrounding land and sea. The majority are not large **enough** for a grown man or woman, and those that are tend to be well guarded by sentries, Stingers, turret bunkers and the occasional patrol, but one to a few careful men on foot *might* just be able to avoid them, manage to cut through the cover grating (only 25 M.D.C.) and get inside. Of course, this means literally sludging through crap and successfully finding an exit without getting caught by city patrols (who are super-lax by comparison) — better have a clean change of clothes and some soap and water to wash the stink off, or the lingering sewer stench will quickly attract attention to the character wherever he goes (hygiene is high in the Tech-Cities).

Getting back out offers its share of problems too. If one has been in the City longer than 12 hours, it is a safe bet that the way he got in has been discovered and is either sealed off or now has an ambush waiting. Since citizens rarely want to leave their City, and must get special authorization, the invader can not simply walk up to a door and ask to leave, even if he has impeccable forgeries of identification papers and a Citizen's Card.

Not unless he has a City cop **and/or** pilot or sentry in his pocket (paid off).

This is where weakness can be exploited again. This time, to paraphrase the master escape artist, Harry Houdini, regarding escapes from locked safes, he noted that such things (and in this case, including city defenses) are designed to keep people from "getting in," they don't take into account somebody "inside wanting to get out." Consequently, while security is fairly tight, an invader who looks and behaves like an average citizen is not likely to be noticed and has a number of escape avenues. Since most citizens don't want to leave, nobody expects anybody to want to, and even the most diligent police officer, soldier and sentry guard becomes bored and distracted in the monotony of his daily routine. This means they can be caught unawares, forced to open a door, or knocked unconscious and the escapee can open a door and make a run for it. If an accomplice or vehicle is waiting close at hand, the escapee really only has the ASG to deal with for 500 yards/meters. Sentries and turrets are likely to be caught by surprise and slow to react (1D4 melee rounds), and support troops and aircraft won't respond for at least two minutes. Of course, if the **character(s)** fleeing is still in eye-shot after 2-4 minutes, he will be pursued.

Perhaps the easiest escape route is by sea. The intruder (with proper gear **and/or** friends waiting at a designated point) can slip into the water unnoticed at a hundred different places (in Perth, that's more like 10,000 different places). Because patrols and defenders are looking out, away from the City, for trouble, if the escapee stays underwater and close to the coast (or in the alternative, goes far enough out to sea before surfacing), he can make good his escape. Even if he is spotted by one of the patrols, or a perimeter sensor catches him as he's leaving, because he is heading *away* from the City, patrols are likely to ignore him (01-85% chance) and automated defenses will only fire until he's out of range; assuming they **frightened** him away. Getting "in" by sea is much more difficult because the would-be intruder must enter the water miles away to avoid being noticed; a difficult journey. The patrols and defenses are geared for incoming breaches, **and**, furthermore, people are likely to notice somebody climbing out of the water and who is wet and cold.

Stowing away on outgoing ground, air and **watercraft** is also much easier, because inspections of outgoing vehicles are virtually **nonexistent**, unless the City is on alert and specifically searching for an intruder.

So in short, it is player ingenuity, luck and the G.M.'s decisions that will determine the success or failure of an intrusion attempt. Good luck. Oh, and G.M.s, you don't have to be generous, but be fair.

## Key Players

### The Police

In **Melbourne**, the Police Force that patrols the city streets is a highly efficient, highly trained and well organized division of the government. It is divided into two parts: The standard City Police and the Tactical Response Group, or **TRG**. The **TRG** are a type of domestic or urban Special Forces that deals with big cases, serious crimes and disturbances, **terrorism**, mutants, psychics and even covert **operations**, while the police are beat cops and basic law enforcers.

**Perth** has a similar City Police Force and an Elite Task Force (the ETF) who serves as their Special Forces group in charge of dealing with terrorists, spies and **superbeings**, the latter including registered psychics and mutants, as well as illegal **practitioners** of magic, monsters, demons, and other supernatural menaces.

It is impossible to walk down most streets of either city without seeing a member of the police on duty. In both cases, the Police and the Special Forces are all trustworthy, hard working individuals, dedicated to their **City**, their government and the people. Corruption is almost nonexistent and crime minimal. They are equipped with state of the art M.D. weaponry, light M.D.C. body armor (from vests to full environmental suits), hover vehicles and computer systems. They have full access to the Central Computer's Criminal and Citizen Records (the CCR), as well as most of the city surveillance measures, which were designed with the police and security in mind to begin with.

City crime is nothing compared to the violence and atrocities of the Outback. Petty theft, brawls, illegal gambling, prostitution, drunk and disorderly conduct, domestic disputes and white collar crime are the most common. There are fewer than 200 murders annually in Melbourne and around **100** in Perth. Other than the occasional murder, rape or act of terrorism, the smuggling of goods out of the Tech-City, Outback contraband (drugs, herbs, magic items, alien plants and animals, ancient artifacts etc.) being brought into the City, and infuriating incursions by City Raiders are three of the most serious crimes the Police have to deal with on a regular basis. The Police of both cities are also responsible for the registration of psychics and mutants. Both are considered to be dangerous subclasses of humans, with mutants being the most discriminated against because of their inhuman looks and, **sometimes**, powers.

**Note:** Perth is the less militant and more open society, with a bit less surveillance, more personal freedom and rights of expression. Crime is also a bit higher, although violent crime is a bit lower. Gambling is legal and under the strict control and supervision of the Government.

## Law & Punishment

The following is a list of the major laws that bind the citizens of the cities, and the punishments that follow infringement of such laws.

Misdemeanor: Littering, drunken and disorderly conduct, etc.  
Fine \$100-1000.

Speeding Ticket: Fine **\$100-1000** or community service.

**Theft or Vandalism:** Less than **\$15,000** in value. Labor 1 year, prison 1-3 years or humiliation treatment.

Waste of Resources: Throwing away food, vandalizing or sabotaging machinery and equipment. Labor **12-18** months, fined an amount equal to the value of wasted resource +20%, or humiliation treatment.

**Malcontent/Dissident/Hacker (Cyber-Specter):** The punishment is being reduced or demoted by one level of Citizenry, with the corresponding reduction in pay, privilege and status.

Assault (Minor): A brawl, fight in anger, etc. Humiliation treatment and possibly appropriate restitution (i.e. pay medical expenses **and/or** loss of work).



Assault With the Intent to Do Great Bodily Harm: 4-12 years in prison or personality adjustment and 4-6 years of Military service.

Computer Crime: Hacking, money laundering, pirating technologies, selling to outsiders, and similar. Prison 3-10 years and demotion in Level of Citizenry. Serious, career criminals will be expelled.

Failure to Report the Manifestation of Psionics, Mutations or Magic: This includes witnessing the illegal or inappropriate use of psionic or mutant powers, the illegal practice or manifestation of magic or the supernatural, and the manifestation of psionics or mutant attributes in oneself or family members. Minor offenses are subject to a fine as low as \$100-\$5000. However, if the action was done with the intent to conceal or protect a wanted criminal, fugitive or inhuman criminal, the individual could be looking at personality adjustment and 1-12 years of prison, and probably demotion in Level of Citizenry. In some cases they may even be considered for exile. **Note:** Most citizens share the government's concern about psionics, mutants, magic and the supernatural and never hesitate to diligently and happily report such incidents, even when the stigma of having a psychic or mutant in the family is at issue.

Illegal Use of Psionic or Mutant Abilities, Using Psionics or Mutant Abilities to Harm or Harass Others, or in the Commission of a Crime: Personality adjustment and 4-12 years in prison (may be commuted to the same time in military service), or exile. In the case of dangerous mutations or aggressive, repeat offenders who are psychic or mutants, exile is the only punishment.

Grand Theft: The theft of property valued over \$15,000. Prison 6-10 years, personality adjustment or six years conscription.

Illegal Document Modification: E.g. forging a signature or documents. 3-12 years for minor offenses (possibly demoted one Level of Citizenry) to life imprisonment or exile if the forgery constituted treason or jeopardized the government or defense of the city.

Damage of Property: Compensation equal to the value of the damage +10-33%, and/or possible fines from \$1,000-20,000 and possibly 1-20 years of prison. Depending on the reasons for and severity of the damage, those responsible may serve the high end of jail time (12 to 20 years) or even be exiled.

Rape: Prison 4-10 years, personality adjustment and one Level demotion in Citizenry. A prison sentence can often be commuted to a mandatory 6-8 year term of conscription in the Military, provided the accused is a willing participant. Repeat offenders are typically subjected to humiliation treatment or long terms of imprisonment (8-10 years).

Manslaughter: Prison 1-8 years, or personality adjustment and 1-4 years probation. Prison is often commuted to a mandatory four years of conscription in the Military, provided the accused is a willing participant.

Murder: Prison 10-30 years, plus personality adjustment and/or humiliation treatment for life. Repeat offenders are exiled.

Grand Treason: Crime against the Government in an attempt to destroy or overthrow it, and may include conspiracy; will result in either permanent exile or execution!

**Practice of Magic:** The practice of magic is forbidden and those caught practicing or helping those who practice it or consorting with the supernatural are typically put through a humiliating, public trial and either expelled from the City forever, or executed! Unwitting dupes (i.e. those "tricked" into helping demons, mages or other magical or supernatural beings) are either fined and put through an arduous **reorientation** and **education** program with 10 years probation (constantly monitored) or put through "The Program" while spending 1-6 years in jail.

## Descriptions of Penalties

- **Community Service/Labor:** Low level or repeat offenders are often given a number of hours community service. More serious crimes often involve labor in a low level area, such as waste disposal, is the punishment. Of course, this is done without pay.
- **Conscription:** This involves placing the guilty citizen in the military, typically for a 4-6 year term, although more serious offenses can lead to 8-12 years in the military; varies with the severity of the crime. Conscripts for the commission of a crime are treated more harshly and watched more closely than regular recruits, for the purpose of giving them the direction and structure they need for rehabilitation and capable service in the military. They often catch the hardest and least desirable assignments, from latrine duty to patrols in the Rim or Gap, but if they prove themselves, they will eventually be regarded as loyal, honorable soldiers. The commission of minor crimes while in the military will see military justice. High crimes, desertion and treason will result in military execution.
- **Demotion in Level of Citizenry:** This social punishment can be assigned to any crime, but is usually limited to (at least what the Government considers to be) antisocial crimes including **hacking/Cyber-Specter**, rape, acts of malcontent, dissidence and similar. A reduction in Level of Citizenry is usually permanent (with overriding extenuating circumstances and acts of heroism taken under consideration), and results in a corresponding reduction in pay, privilege and status even if the offender is put on probation and allowed to **keep his old job**.
- **Exile:** No punishment is more feared than exile. Extremely bad prisoners and repeat offenders of serious crimes are considered beyond reprieve and exiled for life into the Outback. This means they are sent away from the city with no hope of reinstatement as a citizen — an estimated 50% perish in under three years, the rest make a new life as **Outbackers**. In Melbourne, the worst prisoners are exiled to the **Sadro Isle**, a veritable death sentence; less than 20% survive the first year, most perish in three. In Perth, such criminals and political dissidents are dropped into the bushlands.
- **Fines:** A simple fine is the easiest and lowest form of punishment. The fine can be paid on the spot at a 25% reduction, or it can be billed to be paid at a later date at full cost. The price varies depending on the crime.
- **Humiliation Treatment:** Humiliation is a unique treatment reserved for repeat offenders or those who have been released from prison on parole. For a set amount of time the criminal is branded with a visible forehead tattoo that states the nature of **his/her** crime. Every time the citizen uses an

electronic card, the readout will display the crime, and they are given a garment that they must wear (or face harsher punishment) that indicates they are guilty of said **offense**. This humiliation can last for a week to several months.

- **Personality Adjustment.** A very controversial treatment better known as "The Program." It has several stages, the first involves a hefty drug treatment that leaves the convicted criminal a drooling vegetable for several days. Following this, the victim is bombarded with countless images through a Virtual Reality rig designed to "adjust" his way of thinking, and then, a counselling period with a trained psychologist and social worker that lasts several months before it levels out into monthly sessions. The end result is that the individual emerges a more passive, sedate and obedient member of the community (usually removes one insanity and can even change alignment by one level; evil becomes selfish and selfish becomes good). This adjustment is marked on the citizen's permanent record. Those who are career criminals, have a high M.E. (14+) or criminally insane, are usually unaffected by The Program. There are specific "programs" designed for various categories of offense.
- **Prison:** The prisons of Melbourne and Perth are fairly well kept and well managed. They are fairly small because the vast majority of citizens are law abiding, and the worst criminals and repeat offenders are exiled or executed, and many others opt for Military service. Most prisoners undergo mandatory Personality Adjustment during their incarceration and there is an honest attempt at rehabilitation; about 50% never return to crime.
- **Restitution:** This is the full and complete financial restitution for one's crime. If an individual breaks the nose of another person in a brawl, he pays for the character's medical expenses, any lost work time and 10-33% extra for pain and suffering (half of which goes to the government as a fee or fine).

## The Underground

There are a few illegal undergrounds in both city-states, typically rare dissidents, radicals or criminal organizations. Most are tiny, with fewer than two dozen members. Most of these groups are classified as "fanatics" and "terrorists." Unless their actions involve attacking members or places of government, they are a Police problem (typically the Special Forces division). Otherwise they may become a Military matter or a joint effort between the Police and Military. Typically, the members of these groups are the made up of the lowest levels of citizens, including mutants dissatisfied with their way of life. Some are organized by outsiders who manage to influence and convince some City-Goers to join them. Such politically inspired groups engage in acts of protest, vandalism, threats, harassment, sabotage, extortion and, depending on the group and its level of fanaticism, murder. Perth suffers from such "**terrorists**" and isolated acts of insurrection more, but Melbourne has its troubles too.

There is also the matter of organized crime. Big league organized crime is almost impossible due to the social consciousness of the law abiding City people, strong laws, and honest police **force**, but it can still happen. It is usually in the form of **extor-**

tion, blackmail, bribery, smuggling and money laundering. Groups engaging in organized criminal activities may involve any **class/level** of citizen looking for power, money, revenge or thrills.

**The following are some notable groups:**

**Melbourne: The Collective.** The Collective is both a political and criminal organization whose members include mutants, psychics, professional criminals, political extremists and *outsiders*, including smugglers, gang members, Merchant Traders, Bushrangers and City Raiders based outside the city (they help smuggle outside operatives, stolen goods and contraband in and out of Melbourne). They have several allies and contacts at OF Sydney Town, in particular.

The success of the Collective and the fact that neither the Police or TRG have been able to root them out over the last 18 years is an embarrassment. However, the long arm of the Collective reaches into the pockets of select Police Officers, business people and even a couple of Government officials who are secret members of this growing criminal cartel, corrupt and on the take, or silent victims of blackmail.

Nobody knows how many people are part of this criminal network, but it is believed to be only a few hundred (actually, it's only around 100, but its leaders are patient, careful, and cunning criminal masterminds with a good number of "inside and outside connections").

**Melbourne: The Mutant Liberation Movement (MLM).** This is a group of renegade mutants who hate the City Administration and, to a lesser degree, the people of Melbourne who

treat them at best, like second-class citizens and at worst, frightening vermin. They're sick of it and won't take any more. Although they espouse a mixed bag of political rhetoric, it's mostly vague reasoning and excuses to lash out and hurt people. They set bombs and engage in **rape**, murder, and wholesale destruction. So far their actions have done little to hurt the city or its people, and they have done nothing to change people's minds about mutants. In fact, it's nutcases like these who make people fear them and give all mutants a bad name. These terrorists are even feared by most of their fellow (legal) mutants and get little support from anybody. An estimated 12-16 mutants comprise the membership of this group. They are believed to live somewhere in the sewer system below the city.

**Melbourne: The Anti-EHRA Movement.** A political group of fanatical isolationists against EHRA, a plan that is only under consideration to expand Melbourne and try to rebuild Australia as a nation.

**Perth: The Supreme Australian Nation (SAN).** A group of radical nationalists who want Perth to rise up and step forward as "the" new leader of the Australian nation. They promote war with Melbourne, campaigns against Outbackers ("they're either with us or against us"), and the destruction of all **nonhumans**, including mutants. Most of **their** aggression is directed at "god forsaken mutants, D-bees, independent Outback communities and mindless tribals" (i.e. Aboriginals).

**Perth: The Mutant Defense League (MDL).** Humans and mutants who lobby for mutants to have equal rights as citizens of Perth. They frequently clash with police and the Free Australia Movement.





**Perth: The Free Australia Movement (FAM).** Despite their idealistic sounding name, this group of militant radicals (with an estimated support of 21% of the city population) wants to free Australia (meaning the people of Perth and any who will stand with them) from all **nonhumans!** They are believed to be responsible for several unsolved murders and terrorist actions taken against registered mutants and the MDL.

**Perth: The Secret Society of Magic (SSM).** This is believed to be a tiny cult of citizens, perhaps corrupted by an outsider or supernatural **force**, who have begun to explore the mystic arts. They are all believed to be less than a dozen, low level sorcerers (1st to 3rd level, including a couple Sham-Mans, Shifters, Mystics and perhaps a Necromancer) along with a dozen devotees who share their feelings that magic should be legalized. A recent poll showed that 89% of the City population opposed the legalization and use of magic, while 9% were unsure, and 2% supported it under government supervision.

**Perth: The Outback Raiders.** A notorious band of City Raiders that seem to be able to raid and steal from the City with impunity. The authorities are baffled and enraged, as many of this group's raids seem to be designed for publicity and embarrassing the Police rather than making a big score (comparatively little of importance or great value has been taken). The Outback Raiders are the talk of the town as people speculate about them: Are they glory seekers? Rebels? Secretly citizens of Perth (an inside job)? Do they have a secret underground tunnel to get in and out? Do they use magic? Are they even human? What's their next target? and so on.

**Perth: Procurers Limited.** A small smuggling ring that imports Outback goods, drugs and novelty items. Unknown to the Police or Government Officials, its founder and leader is one of their trusted City Traders turned bad.

## The Corporates

Aside from NT and AT A, there are many other large business empires that have sprung up in the two Tech-Cities that could be considered corporations. Here is a list of some of the most notable and major players, listed by city, and their key **function** in the economy.

### Melbourne

**Functional Electronics:** Functional Electronics is an unassuming corporation that is responsible for most of the computer products and electrical circuits currently produced in Melbourne and much of Australia. Chances are most other manufacturers (and users including Trade Merchants, Raiders, bandits, **Outbackers** and adventurers) of anything high-tech use some parts made by FE.

**Southern Star:** This company was founded on the marketing of leisure time activities. For money they can actually "sell" free time to the citizens on a system that is licensed from the Administration. Unfortunately, this means the super-rich can afford lots of free time, but such is life. These days, however, Southern Star makes a lot of its money producing sporting goods; tennis rackets, bats, balls, skates etc., as well as sports apparel, sports shoes, and athletic gear.

**Pharmtel:** This is a medical group that manufactures everything from drugs and scalpels to prosthetics and cybernetics.

**Telecom:** Telecom is the primary communications company of Melbourne. All information travels along their optic cables and laser transmissions. All telephones are routed through their switchboards, and all communications gear is produced by them. They used to be a government group, but they were privatized and marketed to the public by the Admin.

**National Trust:** This is the one and only banking group that handles all money records and transactions, as well as keeping safety deposits for valuables.

**Territory Foods:** This is a refinery that controls the city-based farms and packages and purifies foods for marketing and consumption.

**Power Corp:** They run the giant plasma loop that cuts through Melbourne, and market energy to the public on a **me**-tered system.

### Perth

**Sea Span Corp: SSC,** as it is more commonly called, is an ocean firm that owns a fleet of ships that gather produce from the ocean. Fish, minerals and other sea life are harvested and brought back to the Central Processing Plant for refinement.

**Ocean Mining Inc.:** This company engages in several undersea operations. They own two platforms that lie at the bottom of the ocean about 20 miles out from the Perth city limits. These undersea structures are basically mining installations, but they also farm kelp on the sea bed.

**Solutions CCP:** This is an all-consuming company that deals with many things. Everything from finance to time management, to foods and leisure goods.

**Informatel:** This started off just as a computer company, but has since expanded and changed its name to encompass telecommunication and computer software.

**Perth Electronics:** They deal with electrical goods of all types. Everything from toys to robotics rumbles off their assembly lines.

**Darling Produce:** Darling Produce is the Perth equivalent of Territory Foods, except they not only deals with foods, but also with drugs and other **pharmaceuticals**.

**The Energy Alliance:** The EA are literally power brokers — a cartel of business people who handle all the city's energy needs. Although not an official part of the government, it has tremendous influence in political matters, **lawmaking** and, to a lesser degree, expansion plans.

## More details to come?

Of course, if Kevin and I had room in this **book**, we would detail plans for the cities, key personalities, villains, plots and schemes, as well as more equipment, vehicles, gizmos, world information, etc. However, this is an Australian World Book designed to offer a good overview, with some people and places focused on to provide background color and ideas. We're already planning a World Book that details the Aborigines and magic (**Mystic Australia™**), as well as a third book based on the Aboriginal spirit world and **Dreamtime** (Rifts® **Dreamtime**). Who knows, maybe one of these future titles will present more details about the intricacies of the cities. Both are fascinating topics that cannot be done justice even in this big, 220+ page tome. Hang in there as Kevin and all of us Palladium freelancers explore and define Rifts **Earth ...** and the **Megaverse**.

# City Based O.C.C.s

**Game Master & Player Note:** In many cases, the "City" Characters are more likely to be villainous Non-Player Characters (NPCs) than available as *player characters*. The reason is simple, the average citizen of Melbourne and Perth isn't likely to ever want to leave his cushy, safe world behind the fortified walls. Even if he **did, he'd** have to get permission from his government, and have a good reason — 95% of all City-Goers in the Outback are government agents, consultants or private citizens working with or for the government **and/or** its military. The five percent who aren't are either criminals, mutant or psychic rogues or mischievous and adventurous troublemakers. It is as simple as that. Consequently, any City-Goer made available as a player character, regardless of his O.C.C., can only be one of a few things: 1) secretly a City spy/assassin or other agent for the Tech-Cities, 2) an exile whose punishment has been expulsion from the City, typically a life sentence, 3) a criminal, 4) a **terrorist/political activist/rebel** or 5) an adventuring bozo who has a secret way in and out of the City without being noticed or missed. In the latter three instances, if discovered the character will be considered a traitor or madman, and branded a misanthrope and a criminal. If captured, the character will be (if he's lucky) interrogated and exiled, or (if not so lucky) interrogated and imprisoned, or experimented upon and exiled or imprisoned. Worst case scenario, interrogated, tortured and executed!

There is a sixth scenario in which *players* can use City O.C.C.s. the entire group is composed of City Government **and/or** City Military operatives on special assignment "outside." Any non-City O.C.C. is an Outback sell-out, a **merc** working for the City for technology and money, and maybe the promise of citizenship. Their mission, to patrol or explore the badlands of the Outback and any or all of the following: Reconnaissance, gather intelligence, rescue, special assignments/surgical strikes, infiltrate and undermine the enemy, search and destroy threats to the City (Raiders, Bushrangers, **Roadgangers**, rogue City Traders, other criminals who endanger or trouble the City, dangerous or irresponsible Merchant Traders and smugglers, practitioners of magic, mutants, D-Bees, demons, people outspokenly anti-City, rivals from the other Tech-City, and so on), as well as others.

Have fun.

## Optional City O.C.C.s

Administrator

Cyber-Spectre

City Police O.C.C.

Police: TRG O.C.C.

Sportsman O.C.C.

Technologist O.C.C.

## Optional City Military O.C.C.s

Aerojock O.C.C.

Infantry Grunt O.C.C.

Special Operations Soldier O.C.C.

Naval Sailor O.C.C.

## Other

Phreaker/Mutant R.C.C.

**Note:** All Tech-City characters, including the lowliest worker and mutants, are educated, speak English at a minimum of **84+1D6%** and are literate (+20%).

## Administrator O.C.C.

### NPC villain & Optional Player Character

The divisions within the Tech-Cities' social structure are fairly balanced until one gets to the poorest, mutants, psychics (Level 0 citizens who are all effectively **second-class** citizens, representing the bottom **10-15%**) and City Leaders. Approximately 90% are well educated or trained workers, skilled white-collar professionals, public servants or professional soldiers Levels 1-4, with 3-4 being on the higher end of the spectrum; most are content with their lives. The remaining top percentage, Level 5 citizens, **control** nearly 70% of the wealth within the city economy and make up 76% of the political power structure of "elected" governing officials. This imbalance of power is an invisible and potential evil that most Level 5 citizens are aware of. Most are faithful to their constituents, business and city, while they revel in their power, position, responsibilities and greater destinies. The Administrator O.C.C. is one such character.

Nonetheless, the Administrator is as much a part of society as anyone else, if not more so. He or she is a Level 5 citizen that is wealthy, powerful, well educated and well informed. This character is in charge of leading and supervising either business or governmental operations, making executive decisions and engaging in many other important duties that keep the rigid social structure of the Tech-City in line. He/she knows many (but never all) of the dirty secrets and worries behind the Administration, the true state of the City economy, and of events and the state of affairs with the outside world; all the details that the lower level citizens are kept ignorant of. Some information is so sensitive that certain Administrators in the know are guarded by a secret SO (Special Operations) task force that is ordered to a) protect and defend the individual at all costs, and b) assassinate him if he goes rogue (releases top secret information to the populace or outsiders by his own accord, is willingly helping, **and/or** protecting, criminals or outsiders, etc.).

This character may head the board of a corporation, hold a seat in one of the government offices or even own or run a company. The distinction between government and corporate is very slim, and so "administrator" is a term that can apply to almost anyone in a level 5 position — owner, CEO, CFO, supervisor, manager, top executive, Police Commissioner, Colonel or higher in the Military, and so on.

**Player Note:** The player character is likely to differ slightly from the other Administrators in that he or she is more of a maverick **and/or** hero, and more of a spokesperson for the people or fights for certain issues. He is likely to be unpopular with other Level 5 and Level 4 citizens and surrounded by controversy and slander. He may also become a target of aggressive movers and shakers on their way up and willing to get there over the bodies

of others, as well as those whom he embarrasses, confronts, challenges and opposes, especially hawkish Military leaders (supported by the majority of the **army**), the current old politicians and power brokers happy with the status quo.

No player character may *ever* be a member of the City Administration Office (CAO). No way, no how!

## O.C.C. Special Skills & Privileges

**1. Freedom to leave the City!** In a game **context**, it is important to understand that one of the "privileges" of power is greater personal freedom, including the right to personally own Mega-Damage weapons, armor and vehicles, and the right to leave the safety of the City to conduct business, indulge in exotic pleasures (forbidden to other citizens), fun, play and adventure in the *outside* world with minimal restrictions. Administrators can pretty much come and go as they please, although dereliction of duty, reckless or destructive behavior and suspicion of criminality may see such privilege restricted or denied while under investigation.

**2. Access to additional resources.** This "privilege" enables the character to obtain special equipment and consultation within the area of his **field/work** (i.e. if he works in the robotics field, robots and power armor can be obtained as well as access to laboratories and specialists in that area; working with computers allows access to state of the art computer equipment, design labs, programming, electronics, and a higher degree of access to the Central Computer, and so on). Getting access to special resources (information and equipment) requires positive identification and a requisition form that takes **1D6x10** hours to clear. This time is divided by the character's level, so at 4th level a roll of 2 on the **1D6** would result in the request taking only 5 hours (20 divided by 4).

**3. Requisition personnel.** This privilege allows the Administrator to gather a force of workers within his field of business or area of administration — laborers, drivers, technicians, guards, etc., as well as special police and military consideration, investigation, support and protection. Upon a successful roll, **1D6** personnel may be gathered per level of experience, twice as many if they work directly under him. The personnel will follow the administrator's orders without question, but may report illegal or questionable activities to other superiors or the authorities (remember, most citizens are law abiding and loyal to their City). Getting access to special or additional personnel requires positive identification and a requisition form that takes **1D6x5** hours to clear. This time is divided by the **character's** level, so at 4th level a roll of 2 on the **1D6** would result in the request taking only two and a half hours (10 divided by 4). It may take 10-20 times longer if the request is outside the **character's** area of **influence**, or may be denied completely.

**4. Invoke Policy:** This skill represents the Administrator's ability to make a speech, inspire, motivate and get things **done**, by passing new laws and policies within his field of **influence** (pending review and approval by the CAO and the Central Computer when it is something that will affect the City or more than 100 workers). A successful skill roll does not always mean the policy is **passed**, but it does mean it is opened as an issue to be discussed by the other **Administrators/Board** of Directors. This sort of thing is better role-played than rolled, and the G.M. has the final decision as to what passes, and what is discarded as an unnecessary, unfair or dangerous policy. Otherwise, as a

Level 5 citizen, what the character says goes. **Base Skill:** 4% plus 2% per level of experience. The character may add his entire M.A. attribute as a flat bonus to this skill.

## Administrator O.C.C. NPC or Villain or Optional Player Character

**Alignment:** Any. NPC villains will typically be selfish or evil.

**Attribute Requirements:** I.Q. 12, M.E. and M.A. 10 or higher, and either inheriting or earning the position (through hard work and accomplishments or through elections).



## Base S.D.C.: 3D6

### O.C.C. Skills:

Speaks English 98%

Literacy (+40%)

Basic Math (+30%)

Writing (+15%)

Art (+10%)

Dance (+20%)

Intelligence (+20%)

Computer Operation (+10%)

Streetwise (+6%)

Pilot: Automobile (+10%)

Pilot skill of choice (+5%)

Hand to Hand: Basic to start, but can be upgraded to Expert at the cost of two O.C.C. Related skills or to Martial Arts (or Assassin if evil) for the cost of three.

**O.C.C. Related Skills:** Select ten other skills at level one, plus one additional skill at levels 2, 4, 6, 8, 10 and 12. New skills start at the first level of proficiency.

Communication: Any (+15%)

Cowboy: None

Domestic: Any (+10%)

Electrical: None

Espionage: None

Mechanical: Basic only.

Medical: First Aid only (unless the character is an Administrator in a medical field, in which case, any at +10%).

Military: None

Physical: Any, except Boxing and Acrobatics.

Pilot: Any (+5%)

Pilot Related: Any (+5%)

Rogue: Seduction, Computer Hacking and Card Sharp only (+10%)

Science: Any (+10%)

Technical: Any (+15%)

W.P.: Any

Wilderness: None

**Secondary Skills:** Also select six secondary skills from the previous list. They are limited by the categories listed, but do not receive any of the bonuses listed in parentheses. These are additional areas of knowledge and start at the first level of proficiency.

**Standard Equipment:** Will have several sets of very fine clothing of the latest fashion and highest quality cut and make. Also sunglasses, Level 5 Citizen Card (I.D.) and other personal items such as an expensive **wristwatch**, portable phone, pocket computer, language translator, CD player/recorder, and so on. The wise Administrator will also have and wear a suit made of a "**Base-4**" armored cloth **and/or** have a light Anti-Assassin Vest under his jacket.

The character has many fringe benefits — a limousine and **limo-driver**, personal trainer, secretary, etc. (good N.P.C.s for the Game Master to use, or maybe even to be other player characters).

Has 1D4 luxury cars (300 M.D.C., top speed of 200 **mph/320** km; features include wet bar, air **conditioning**, stereo, two-way radio, phone and computer link with built-in computer suite; no weapon systems), and a pleasant home in the higher levels of the city, with a pool, hot tub or sauna, private gym, several bedrooms and all the luxury appointments. The character lives the high life.

Other equipment may be purchased **with** starting money, and monthly salary as the game progresses.

**Money:** Starts with 2D6x\$5000 in personal savings, and probably close to a half million tied up in assets such as cars and a home, and other investments. Monthly salary is \$15,000 +1D6x1,000; this goes up by \$300 per level of experience and does not include bonuses or other reasonable perks. 50% of this salary will go into expenses such as rent, personal employees (butler, chauffeur, etc.) and other bills.

**Cybernetics:** None, but may purchase minor cybernetics with starting money. No bionics; values his humanity.

**Note:** The Administrator can be a very powerful role to pass onto a player, and the G.M. is well within his rights to refuse to allow this character. In all, I feel it is best kept as an N.P.C. villain or powerful ally, but a campaign that begins in the higher levels of government and control, balancing the powers that spell the future of the last civilizations left in Australia, can be **fun** too.

## Cyber-Specter O.C.C.

By Ben Lucas & Kevin Siembieda

The Cyber-Specter is a part of the last big, antisocial group left in Melbourne and Perth society. Small **gangs**, Street-Rats/City Rats, **etc.**, all still exist, but current authority levels make their influence incredibly small and mild compared to years gone by. The only true rebellion left is an invisible, computer based society that is made up of thousands of members who may never even see each others' faces. They converse over the fiber-optic cable and meet in virtual space.

While the City Central Computer can and does trace their activity, the clever **Cyber-Specters** are able to communicate in ways the Computer cannot incriminate or pinpoint. In a sense, they are hackers who can haunt communication lines without being billed and jack into cyberspace anonymously like ... well ... ghosts. Most Cyber-Specters are actually passive users who spend their free time using the computer networks for fun more than any other aim. The Cyber-Specter O.C.C. represents a hard core computer junkie who enjoys defying and dodging authority (that's part of the fun), can break decryptions, read and steal data and program a computer like it was a brush in the hands of an artist.

The authorities have made it popular to hate and fear the Cyber-Specter movement as something vile and dangerous that seeks to corrupt and overthrow the Administration. The truth is much different. Curiosity alone drives the Cyber-Specter, and while he may have the power to break into the Central Computer's data stores, he can not directly access the Melbourne Central Computer itself (a fact that puzzles him because he **doesn't** know it is sentient). Most don't mean to cause serious damage or learn any state secrets, although player characters are likely to have their own agendas and may deliberately do things to cause trouble for the government. Not anything that would hurt people, things like adjusting a shipping manifest to provide more product to the Outbackers, or delay the schedules for an important diplomat's limousine, cause confusion, or "lift" the records of a new chemical weapons plan and publish them for the public to learn about, and so on. They are more of a group of



nosey, troublesome irritants then a real danger (the Central Computer constantly monitors and controls life support and military operations so even the best hacker **can** not seize control of vital city operations, power plants, military systems, etc.). A Cyber-Specter could easily change bank records and become rich, but this is greedy and stupid because the Admin will quickly discover him and lock him away for half of his life. **No**, they are careful, smart and creative.

It is a fact that the Administration hides data from the citizens and brainwashes them with propaganda. The truth is, the economies of both Tech-Cities are in strife, and their perfect so-

ciety may well crumble over the ensuing decades if new policies aren't put into place. Meanwhile, **90%+** of the citizenry is convinced life is at an all-time high. The Cyber-Specter society is the last chance the truth has of being revealed, and this is one of their aims.

There *are* a few villains out there that are in the game for personal gain and nothing more, and these are the ones the Admin takes pleasure in capturing and punishing harshly. The public uses these villainous **Cyber-Specters** to form their opinion of the entire movement, **which** works to the benefit of the authorities. Most Cyber-Specters have to battle negative public opinion, and most have given up trying to convince people they are "okay." Which is why their lives are such shadowy ones. They lead double lives, hacking when they should be sleeping, and keeping themselves awake during the day with stimulants to do their business like any other citizen. They must hide their secret "hobby" and lie and hide their double life from friends and loved ones, not just because they might be turned in by one of them, but to protect them from the long, and often cruel and vengeful, arm of the law.

The Cyber-Specters rarely meet in person, and when they do it is in private in homes or small nightclubs. They exchange information, and copies of data they have pilfered, as well as share techniques they have developed for breaking the Admin's latest security measures. Cyber-Specters tend to be young, active thinkers (most are between the ages of 15 and **24**), and they work surprisingly well with other sharp minds and revolutionaries. Some also get involved (sometimes unwittingly) with City Raiders, outcasts, criminals, mutants and outsiders (from adventurers to who knows what). These contacts can form an overall weak, but fairly extensive network that wishes to see the common City-Goers more aware of their own situation, social issues, injustices, and changes in the wind.

Of course, fun is the main motivation of the Cyber-Specter. He does what he does because he enjoys the thrill of riding past passcodes and security programs, and he loves to tread where only Level 4 & 5 citizens are allowed to go. Sometimes, when the Central Computer catches a trace and the TRG is dispatched to arrest a clumsy Cyber-Specter, their entire underground movement will slow down in shock and fear. But it usually only takes days for them to pick back up to speed again, often with renewed vigor.

## Special Cyber-Specter O.C.C.

### Bonuses & Abilities:

**1. Attribute Bonuses:** Keeping a sharp mind results in a +2 to the I.Q. and +1 to the M.E. attribute. +1 on initiative.

**2. Computer Hacking:** The skill, Computer Hacking, which is part of the **Cyber-Specter's** basic skill package, is very advanced. **Base Skill:** Computer Hacking (same as the rogue skill) **15%+5%** per level of experience, plus the Cyber-Specter gets a substantial +25% bonus (so he really starts at 40%). The following operations can be performed, with the corresponding modifiers to the skill roll.

-10% Break a simple security program (e.g. personal password). Time required: 2D6 minutes.

-20% Break a moderately sophisticated security program (e.g. door alarm). Time required: 6D6 minutes.

-40% **Break** a high level, sophisticated security program (e.g. personal accounts) Time required: 3D6 hours.

-50% Break a super-sophisticated security program (e.g. the city traffic-light controls). Time required: 6D6 hours.

-65% Break a highest-level military security program (e.g. ordnance manifests, V500-X controls). Time required: 3D6 days.

-70% Break into the Central Computer Data Base (not the Central Computer itself). Time required: 1D6x10days, and the link will only exist for 1D6x10 minutes before it is discovered, traced and shut down. Police or TGR will arrive on the character's doorstep with a warrant to search the premisses and seize all computer equipment (and the hacker) within 3D4 minutes after the link is broken.

-10% Decipher an unknown code. Time required: 6D6 hours. If a 6 is rolled on any die, roll it again and add the result to the overall time required.

-5% Replace a simple to moderate security code with one of your own, after it has been broken (see above). Time required: simple: 2D4x10 minutes; moderate: 2D6 hours; high level: 2D4x100 hours (at -15%); military level: 3D6x100 hours (at -20%); super-sophisticated: 1D6x10years (at -30%).

-5% Create a personal "back door" into a program of your own design. Time required: 2D4 hours.

-15% Create a personal "back door" into a system that has already been broken into. Time required: 3D4 hours.

-30% Hijack a remote controlled device like a robot, powered door, Automated Sentry Gun (not turrets or other weapon defense systems), security camera, terminal display, vending machine, electronic billboard, etc., providing the security has been broken. Time required: 2D6 minutes.

-10% Performing the "hack" stealthily or quietly (i.e. avoiding detection, see below). Adds +2 to any roll required to determine time taken.

+20% Taking a lot of time and absolute caution; double or triple the required time to perform a task, but do it well.

+Special. Complicate trace. This is a way to disguise one's source of **origin/real** address by bouncing signals and creating false sources. This is only a delaying tactic that will buy the Hacker only one minute of extra time per each false lead (can install one per level of experience), but each adds 1D6 minutes to set-up time. As long as the last false lead isn't breached by the tracer, the character's true location remains a secret.

Being Traced is the main risk of any hack. If a roll to break into a system, take control of a remote or sift *through protected data, military or government files*, or anything with a protection encryption or security code, there is the possibility that the hack will be discovered every time the data or program is accessed. This is determined after a successful hack has been accomplished, by rolling under the Hacking skill a second time, -5% when breaking a simple security code, -10% when breaking a moderate one, -20% when breaking a good or high code, -30% against a superior code, -40% when breaking into a super or military security code and -70% when accessing the Central Computer's storage of data files.

A failed trace roll (higher than the character's skill number with modifiers) means the Central Computer, the Military or the facility itself, has been alerted and can attempt to trace the

hacker (the Hacker will know when he's been discovered and can choose to immediately break the connection or stay on-line). There is a 50% likelihood of success +5% per minute that the hacker stays on-line after he's been discovered. If the trace succeeds, the computer has zeroed in on the location of the Cyber-Specter, and he can expect the TRG breaking down his door in 1D6 minutes.

**Note:** Also see the Psi-Ghost and Psi-Tech R.C.C.S in **Rifts® World Book 12: Psyscape™**, both are rare, but available psychics in the City setting. If this is the case, the character has the powers described in **Psyscape™** but selects the skills and background common to the Cyber-Specter O.C.C. above and below. However, O.C.C. Related and Secondary skills are reduced by half.

### **Cyber-Specter O.C.C.**

**Alignment:** Any. Most tend towards anarchist or unprincipled.

**Attribute Requirements:** I.Q. 12, and an M.E. 9 or higher.

**Base S.D.C.:** 4D6

**O.C.C. Skills:**

Speaks English at 96%

Literacy (+30%)

Math: Basic (+20%)

Math: Advanced (+12%)

Writing (+8%)

Radio: Basic (+20%)

Radio: Scrambler (+20%)

Radio: Cryptography (+15%)

Computer Operation (+20%)

Computer Hacking (+30%)

Intelligence (+5%)

Streetwise (+6%)

W.P. one of choice.

Hand to Hand: None to start. Hand to Hand: Basic can be acquired for the cost of one O.C.C. Related Skill, or Expert at the cost of two skills, or Martial Arts (or Assassin if evil) for four skills.

**O.C.C. Related Skills:** Select ten other professional level skills at level one and two additional skills at levels 3, 6, 9 and 12. New skills start at the first level of proficiency.

Communication: Any (+10%)

Domestic: Any

Electrical: Any (+10%)

Espionage: Forgery only (+5%)

Mechanical: Any

Medical: First Aid only (+5%)

Military: None

Physical: Any except Acrobatics, Gymnastics and Wrestling

Pilot: Any (+5%)

Pilot Related: Any (+10%)

Rogue: None

Science: Any (+5%)

Technical: Any (+15%)

W.P.: Any

Wilderness: None

**Secondary Skills:** Also select five secondary skills from the previous list. They are limited by the categories listed, but do not receive any of the bonuses listed in parentheses. These are additional areas of knowledge and start at the first level of proficiency. Quite often these will represent the Cyber-Specter's day job.

**Standard Equipment:** Wristwatch, comfortable shoes, packet of "Everwake" stimulants, pocket knife and small electronics tools, painkillers, pocket computer/organizer, main desktop computer (usually state-of-the-art with a few personal, added features including a modem and a battery for portable use), 2D6 blank disks/chips, and several books on computer code and security measures (such books are usually quite illegal).

The character will also own 1D4+1 electronic gadgets from the following list: 1: window trembler, 2: line tap, 3: spy camera, 4: white noise generator, 5: voice scrambler, 6: hand-held digital voice recorder, 7: audio bug and scanner with 1 mile(1.6 km) range, 8: bug detector, 9: portable chip/disk reader or 10: hand-held computer memory unit.

The Cyber-Specter O.C.C. will wear the latest fashions, including a jacket, cap, jeans, etc. The player may personalize his character's wardrobe.

For weapons the character owns one small firearm (for emergencies) with two reloads, and the "Popper" high energy derringer. At the G.M.'s option the character may own a light anti-assassin M.D.C. vest.

The character may also have a simple ground vehicle (conventional car, motorcycle or hover car with 150 M.D.C., top speed of 220 mph/352 km, air conditioning, radio, stereo; no built-in weapons) and a comfortable two room apartment.

**Money:** Monthly salary from a mundane day job is about 1D4x\$1,000. A computer or technologies job will pay 2-5 times more, but places much higher demands on the character's time and accountability.

Starts with a personal savings of 2D4x\$100; not much considering the Cyber-Specter has probably spent his money on luxuries, fun and computer hardware and software.

**Cybernetics:** None to start, but a Universal Headjack and ear implant, plus 1D4 other minor cybernetic implants of choice are common among Cyber-Specters. No bionics.

## City Police O.C.C.

The Police or Law Officer O.C.C. represents an outstanding member of the police force at work within either the Melbourne or Perth city walls. The police in and of themselves, are a highly disciplined, loyal and dedicated group of public servants trained in peacekeeping and the law. Military police are a separate unit from the civilian police, however the two forces often cooperate. The relation between the two is simple — one handles civil matters, while the other handles matters of defense and war, which overlaps when it comes to security and hunting down terrorists, rogue mutants and other serious threats to the city, its government or its people. Both handle special investigations.

The individual police men and women, for all their sense of elitism and "law and security at all costs" attitudes, are a relatively caring bunch of people truly dedicated to "serve and protect." Most started their careers because of their sense of justice and desire to give everyone a fair chance, and they want to see their great city grow stronger and more prosperous in the new era. However, some percentage have grown hard and cold, meting out "justice," especially to traitors and outsiders, with frightening brutality and the business end of a gun. Furthermore, they do not write the laws, and they are bound to follow them, so some of their extreme actions are encouraged by the government they so loyally serve.

City police are very well organized. Their uniforms — a light gray with black trim in Melbourne, and a dark blue with black trim in Perth — are always immaculate and well kept. The officers themselves are clean shaven, clean cut and clinically polite. Etiquette, conduct, courtesy (to law abiding citizens) and hy-

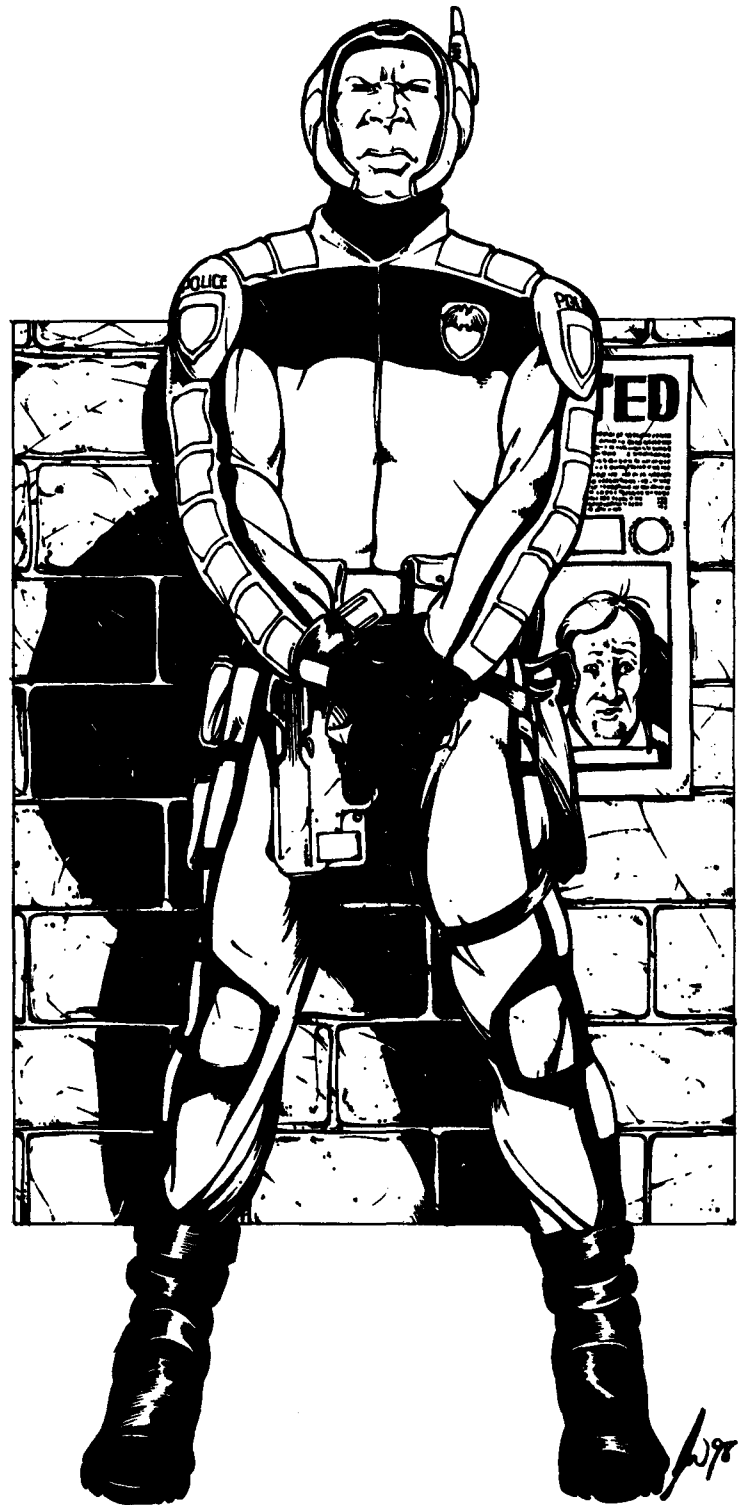

giene are all part of their training program, as well as the usual firearms, driving, hand to hand combat, surveillance and intelligence training. As cadets they are even drilled and tested like soldiers. On the streets, they are taught to handle situations in a rational and straightforward manner, with control over their emotions no matter what the situation. Their stone-faced dedication to duty is legendary.

Unlike many other societies where a cop can turn a blind eye to a situation **that**, while illegal, may be incidental, have extenuating circumstances or is fundamentally good or helpful, the City Police tend to support **"the letter of the law."** Furthermore, they hold their superiors in high regard and trust the Central Computer implicitly, so they seldom disobey orders. All acts of misconduct or failures to follow orders are recorded. Minor offenses can result in demerits (stays on personal record), temporary suspension, wage freeze or fines, while serious offenses can result in demotions (and reduction of wage), reduction of citizenship (reduced a level or placed on probation), being kicked off the force, imprisonment and even being exiled from the city or executed. Hence, the police come across as very stern, even ruthless, if only because their job forces them to.

There are some cops that enjoy being ruthless; bullies who pick up on every little breach of conduct they see. Unfortunately, it is usually people like these that make it to the top of the chain of command, because they are the ones with the best arrest records and exhibit the toughness the Administration is looking for. Meanwhile, the rest of the cops do their jobs **well**, and with a touch of compassion whenever they can afford it.

City Police are respected members of the community. Because their position enables them to operate against those with higher citizen Levels than themselves (showing great respect, caution and benefit of the doubt when dealing with Level 5 Administrators, of course) the flash of a badge, off and on duty, can change the attitudes of many people and establishments. This is not an abuse of power but a reflection of how highly regarded and appreciated they are, as well as how law abiding the majority of citizens are; always cooperative and a help to their Police protectors. Despite the Police's attack dog-like behavior (one minute smiling and helpful, the next a snarling beast gunning down a City Raider or crazed mutant), few law abiding City-Goers feel intimidated by them. Off-duty officers often have lots of friends, and those on duty can count on the cooperation of citizens. There have even been incidents of brave citizens coming to a fallen policeman's aid in a hail of gunfire. Their status earns them a lot of respect, plus people can relate to them.

**Note:** City Police can make fun player characters, especially if the G.M. wishes to run a cop orientated campaign based in and around Perth or Melbourne. Like other members of the government, the City Police are authorized to leave the walls of the City to pursue criminals, follow leads and make investigations. In fact, outside the City, they can be even more ruthless, even murderous, without fear of recrimination or punishment, because the **Outbackers** in the Back of Beyond have no rights in the eyes of the City Government and are little more than vermin or barbarians. However, their comings and goings are closely monitored and they must get permission for special investigations that will last more than 12 hours outside the City. To go off adventuring, the cop can be an undercover agent or FBI-like investigator allowed to go beyond the borders of "his" city to investigate, counter and destroy criminal activity directed at his community, but which operates outside the area. However, most police are "regional," operating in one specific part of the city. Thus, this O.C.C. is often ill-suited for any sort of long-term adventuring far from his or her home base. The obvious exception are those who have been punished with expulsion into the wastelands or who have gone rogue and deserted their office to live in the Outback.

## The Law Code

Crimes are given codes which consist of two parts. The first is a number that acts as a guide to the level of the crime, and the second is a letter that denotes the area of infringement. See below for details:

Item 01 - Treason	Item 11 - Narcotics
Item 02 - Murder	Item 12 - Fraud
Item 03 - Conspiracy	Item 13 - Breach of License
Item 04 - Grand Theft	Item 14 - Theft
Item 05 - Espionage	Item 15 - Extortion
Item 06 - Sabotage	Item 16 - Damage of Property
Item 07 - <b>Hoarding/Smuggling</b>	Item 17 - Breach of Conduct
Item 08 - Manslaughter	Item 18 - Slander
Item 09 - Rape	Item 19 - Disorderly Conduct
Item 10 - <b>Magic/Psionics</b>	Item 20 - Minor <b>Offense</b>

Section A - Crimes against the Administration

Section B - Crimes against the citizens

Section C - Crimes against the city

Section D - Crimes against the police force

Section E - Crimes against technology

Section F - Crimes against morality

So, for example, a crime coded **01A** (the highest possible offense) would be treason against the Administration, while a crime coded **20F** (the lowest possible offense) would be something like disturbing the peace or being a public nuisance. As a middle example, picking a pocket would be coded **14B**. Most crimes are coded under C; **20C** is littering, **16C** is graffiti and **06C** would be severe vandalism.

All police officers are expected to memorize the codes, and use them over the airwaves to organize their movements about the city. The highest letter code always gets priority, but within a section the highest *item* always gets priority. So if an officer was radioed with a **09B** and an **18B**, he would have to investigate the **09B** first. But if faced with, say, a **14A** and a **09B**, he would have to respond to the **A** first, even though the **B** has a higher number code. The reason for this priority system is simple — the Government understands that if the larger crimes are dealt with, the smaller ones are less likely to happen, and the overall crime rate will be reduced. So far they have been highly successful.

## Police O.C.C. Bonuses & Abilities

**1. Combat Bonuses:** The training and hard core attitude of the police grant them a +10 S.D.C. bonus, +2 on initiative, +2 to disarm, +3 to pull punch, +3 to save vs Horror Factor and +1 to save vs illusion and mind control.

**2. Attribute Bonuses:** Every police officer undergoes three hard years of training and internship as a Rookie, after which he emerges as a first level Police O.C.C. with a +1D4 to M.A., +1 to P.E., and +1D6 to Spd.

**3. Police Primary Special Ability: Authority:** The prime directives of the police are to 1) Serve the City and its Government, 2) uphold the letter of the law, 3) serve and protect the citizenry, and 4) defend the city from all enemies — in that order. This list of directives grants them authority above and beyond standard citizen levels. Even though their own social level may be quite low (typically 2-3), they are treated as level 4 citizens when in uniform. This enables them to enter restricted areas, access sensitive information and, essentially, command the citi-



**zenry.** For this purpose their citizen level is slightly above 4, because level fours must obey them as well. Failure to do so results in a charge of disobeying an officer (code 17D).

## Police O.C.C.

**Alignment:** Any, though evil ones are extremely rare. Most tend towards Principled and unscrupulous.

**Attribute Requirements:** I.Q. 9, M.E. and M.A. 8, P.E. 10, or higher.

**Base S.D.C.:** 4D6

### O.C.C. Skills:

Speaks English at 96%

Literacy (+30%)

Math: Basic (+15%)

Radio: Basic (+10%)

Surveillance Systems (+15%)

Computer Operation (+10%)

Streetwise (+12%)

First Aid (+15%)

Pilot: Automobile (+15%)

Pilot: Hover Vehicles (+10%)

Pilot: Robots and Powered Armor

Climbing

Running

General Athletics

W.P. Automatic Pistol

W.P. Energy Pistol

W.P. Energy Rifle

Hand to Hand: Expert to start, but can be upgraded to Martial Arts at the cost of one O.C.C. Related skill.

**O.C.C. Related Skills:** Select five other skills. Select two additional skills at level two, and one additional skill at levels four, six, nine, twelve and fifteen. New skills start at the first level of proficiency.

Communication: Any (+5%)

Cowboy: None

Domestic: Any

Electrical: Basic only.

Espionage: Sniper, Intelligence, Detect Ambush and Disguise only.

Mechanical: Basic and Automotive only.

Medical: Paramedic only (+10%).

Military: Any

Physical: Any except Acrobatics.

Pilot: Any (+10%)

Pilot Related: Any

Rogue: None

Science: Math only.

Technical: Any (+5%)

W.P.: Any

Wilderness: None

**Secondary Skills:** Also select five secondary skills from the previous list. They are limited by the categories listed, but do not receive any of the bonuses listed in parentheses. These are additional areas of knowledge and start at the first level of proficiency.

**Standard Equipment:** Standard issue equipment when on patrol includes a uniform (gray in Melbourne, dark blue in Perth), headset radio, notebook computer (police black book), citizen card reader, badge and identification and one

set of handcuffs. For armor, the police have a variety of choices, depending on the severity of the situation. In low risk, standard patrol work, they wear a "Base-4" armored uniform, in mid- to high-risk areas or while on assignment, they wear the form fitting police body armor under their uniforms (35 M.D.C.), but in **combat/riot** situations they are issued either a full flak vest with helmet and riot shield, or a full suit of light to medium environmental M.D.C. armor (typically between 50-75 M.D.C.). See the equipment section for details.

Weapons include the 9mm S.D.C. pistol or **submachinegun**, "Super-10" door buster shotgun, **M-01** laser pistol and the 20K Tazer. Police usually carry one S.D.C. and one M.D. handgun only, with M.D. rifles and other weapons used only in assaults and defense of the City. Such weapons are either stored in patrol vehicles, or assigned as needed.

Police are also issued a patrol cruiser (380 M.D.C., top speed of 180 mph/288 km, equipped with a radio and onboard computer, no built-in weapons) or the Security Commando powered armor suit.

Other equipment varies with personal choice and assignments, and with what the character can afford to buy for himself. Special permits are available that allow City Police to carry non-issue weapons, but these permits are easily revoked if abused.

**Money:** The police are given a 40% reduction on rent and city taxes, or may choose to live at the precinct in a dormitory. The police O.C.C. also enjoys a 20% reduction on food and 50% on medical costs (any injury sustained in the line of duty is taken care of by the Government).

Monthly salary is \$2,000, and this goes up by \$200 per level of experience (if all goes well; demerits and poor conduct may result in a further penalty of a wage freeze or demotion). Starts with 1D4x\$1000 in personal savings.

**Rank:** Starts as a Corporal. Ranks are the same as the military. The most common ranks are sergeant, lieutenant, detective lieutenant and captain.

**Cybernetics:** 30% of police officers will have 1D4 cybernetics of choice, 10% have minor partial bionics (i.e. one mechanical combat limb with two weapons), or prosthetics as needed.

## Police: TRG O.C.C.

### a.k.a. Special Ops: Tactical Response Group

The TRG is a high-grade police division that deals with special weapons and tactics (the Australian equivalent of SWAT). They receive rigorous, extensive training, and their jobs are, while more dangerous, often considered easier than standard police work. They are kept on call, and activated only when their attention is needed.

Many beat cops resent the TRG because they are regarded as something of a "super-police," and because they have a nasty habit of muscling in and taking over situations (called in by a government leader/Administrator, not the cops who often feel they could have handled the situation themselves). All in all, good relations are maintained between the two, as the TRG is only a small faction of the Police Department, and answers to the same commanders. This doesn't stop the actual TRG grunts from being cocky or headstrong, though.



The average day of a TRG operative is 25-50% waiting and killing time with training, drilling and filing paper work. Field assignments, especially "crisis response" (their specialty), are much preferred by these men and women of action. Field work includes investigation, surveillance, spying, and searching for known terrorists, smugglers, rogue mutants and **psychics**, organized crime, City Raiders, and other invaders. Part of their specialty is small group strategies and tactics including surgical strikes, guerilla warfare and espionage. Unlike the police, they specialize in coordinated squad attacks (i.e. 6-10 man teams working with other small squads of police, other TRG or the military) and are usually the first to respond to invasion threats, followed quickly by the military. On the average, TRG teams get called to handle a combat situation (armed robbery, City Raider or invader, crazed mutant on the rampage, etc.) in the field only one or two times a week, and half of those are false alarms or things the police could have handled just as easily. There are usually ongoing investigations but those can be slow and tedious as well. To keep their skills honed, the TRG are authorized to conduct what's euphemistically called, "Exterior Pacification," a soft way of saying ruthless investigations, shake-downs and purges of neighboring Outbacker communities.

The goal of "EP" is to stop crime and insurrection before it happens (in the City), by having TRG squads (sometimes undercover, many times not) ride into a settlement, town or so-called city (OI' Sydney Town is a favorite target of Melbourne), and run roughshod over the locals to keep them intimidated and away from the city. D-Bees, Aborigines, Merchant Traders, gang members, adventurers and suspected and known criminals are targets for harassment, threats and beatings (to get information, of course). If the TRG agent doesn't like the way you talk or look, watch out. Monstrous looking D-Bees, true monsters and demons, obvious aliens, creatures and practitioners of magic, and wanted criminals are hunted down, interrogated (which often means tortured) **and/or** killed, often on the spot with a dozen to scores of horrified spectators. Anybody who protests or interferes is typically treated as a dangerous criminal and possible ally of the **fugitive(s)** they are currently manhandling. **These gestapo-tactics** work well in "pacifying" normal Outbackers and petty crooks, while fanning the fires of hate and revenge, especially among the more defiant and militant dissidents, outcasts, **nonhumans** and criminals.

A typical TRG Wasteland **Squad** is 3-5 troopers in medium to heavy body armor on hovercycles or other "bikes," or with jet packs, and 3-5 Power Armor troops, all armed to the teeth and usually looking for trouble. One in eight is a major or master psychic. They also engage in undercover investigations, infiltration, spying, assassination and other covert operations, sometimes coordinated with the City Military.

### TRG O.C.C. Bonuses

**1. Combat Bonuses:** The training and hardcore attitude of the TRG grants them a 1D6+12 S.D.C. bonus, +3 on initiative, +1 to disarm, +4 to pull punch, +4 to save vs Horror Factor and +2 to save vs illusion and mind control.

**2. Attribute Bonuses:** Every operative undergoes four hard years of training and internship as a Rookie, after which he emerges as a first level TRG O.C.C. with a +1 to M.E. and P.P., +2 to P.E., and +1D6+4 to Spd.

**3. Special Ability: Authority:** Same as the police.

**4. Special Weapons Training:** During training the operative is asked to choose between specializing in heavy combat systems — **Pilot: Robots & Power Armors**, focusing on three different Power Armor suits with training in Robot Power Armor Elite — *or* heavy weapons.

Heavy Weapons training includes Demolitions, Demolitions Disposal, Underwater Demolitions, Basic Electronics (all at +13%), Sniper and W.P. Heavy Weapons. This training also gives the character one extra attack per melee round when using heavy weapons.

### TRG O.C.C.

**Alignment:** Any, but Anarchist and Aberrant are most common. Regardless of the alignment, most TRG agents are human supremacists completely (in many cases, fanatically) loyal to their Tech-City

**Attribute Requirements:** I.Q. 10, M.E. 10, P.E. 10, P.P. 13.

**Base S.D.C.:** 4D6 (plus O.C.C. and skill bonuses)

**O.C.C. Skills:** Don't forget about the special weapon training.

Speaks English at 97%

Literacy (+30%)

Radio: Basic (+10%)

Math: Basic (+15%)

Surveillance Systems (+15%)

Computer Operation (+10%)

Law (+20%)

Streetwise (+6%)

Find Contraband (+10%)

Pilot: Hovercycle (+15%)

Pilot: **Jet Pack** (+20%)

Pilot: Vehicle of choice (+15%)

Climbing

General Athletics

Boxing

W.P. Automatic Rifle

W.P. Energy Pistol

W.P. Energy Rifle

W.P. One weapon of choice (any).

Hand to Hand: Expert to start, but can be upgraded to Martial Arts or Assassin at the cost of one O.C.C. Related skill.

**O.C.C. Related Skills:** Select two from either the Military or Espionage Category and four other skills of choice. Select one additional W.P. at levels 2, 4, 8 and 12. Select one additional skill (limited to the skill Categories of Espionage, Military and Technical only) at levels 2, 5, 9 and 13. New skills start at the first level of proficiency.

Communication: Any (+10%)

Cowboy: None

Domestic: Any

Electrical: Basic only.

Espionage: Any (+10%)

Mechanical: Basic and Automotive only.

Medical: Paramedic only (+5%).

Military: Any (+10%)

Physical: Any

Pilot: Any (+10%)

Pilot Related: Any (+5%)

Rogue: None

Science: None

Technical: Any (+10%)

W.P.: Any

Wilderness: None

**Secondary Skills:** Also select four secondary skills from the previous list. They are limited by the categories listed (any, only, none), but do not receive any of the bonuses listed in parentheses. These are additional areas of knowledge and start at the first level of proficiency.

**Standard Equipment:** Standard issue equipment includes a uniform (matte black and grey in Melbourne, dark blue in Perth), headset radio, language translator, flashlight, web harness, utility belt, holster, M.D. **sidearm** and rifle, **1D4+2** hand grenades, notebook computer and badge/identification.

For armor, the TRG have a variety of choices. When training or undercover they wear "**Base-4**" armored clothing (typically jump suit or fatigues) **and/or** a concealed flak vest, but in combat situations and outside the City, they wear medium Trencher armor (shown in the illustration) or similar light to medium armor (may use Homespun armor as a disguise). The standard TRG Trencher outfit is complete with a pair of goggles **with** a targeting scope, **thermographics**, passive low-light **nightvision**, computer readout and vision magnification functions, and air filtration system. **Note:** A characters with Power Armor training will have one available at all times as his armor of choice.

Virtually any type of weapon is available if the situation calls for it, including explosives, S.D.C. guns, **tazer**, M.D. weapons, sniper rifle, and even rail guns and other heavy weapons. Other weapons are either stored in assault vehicles, or assigned as needed. Other equipment varies with personal choice, and with what the character can afford to buy for himself. Special permits are available that allow agents to carry non-issue weapons, but these permits are easily revoked if abused.

TRG agents can also be issued a police patrol cruiser (300 M.D.C., top speed of **180 mph/288 km**, equipped with a radio and onboard computer, no built-in weapons), jet pack (50 M.D.C., **200 mph/320 km**, **3000 ft/914 m** max. altitude), hovercycle (160 M.D.C. **250 mph/400 km**) and light assault APC (360 M.D.C., top speed of **100 mph/160 km**). Most of the larger vehicles are equipped with a radio, onboard computer and 2 hours independent oxygen, no built-in weapons but has two gun ports and one top gunnery/observation turret) or the Security Commando powered armor suit.

**Money:** The TRG are given a 40% reduction on rent and city taxes, or may choose to live at the precinct in a dormitory. The police O.C.C. also enjoys a 20% reduction on food and 70% on medical expenses (any injury sustained in the line of duty is taken care of by the Government).

Monthly salary is \$3,000, and this goes up by \$400 per level of experience (if all goes well; demerits and poor conduct may result in a further penalty of a wage freeze or demotion). Starts with **1D6x\$1000** in personal savings; most TRG operatives live life as it comes and spend their money on luxuries.

**Rank:** Starts as a Corporal. Ranks are the same as the military. The most common ranks are sergeant, lieutenant, lieutenant commander and captain.

**Cybernetics:** Player characters start with none, but 35% of the TRG agents will have **1-4** cybernetics of choice, 20% have

partial bionics (i.e. one or two mechanical combat limb with **2-4** weapons each and **1D4** implants or modifications) **and/or** prosthetics.

## Sportsman O.C.C.

### An O.C.C. for any Australian location

A high-tech, snobby city dweller who pumps iron, plays in amateur or professional sports and thinks he's hot stuff. Many of these guys are your stereotypical "jocks," although they are likely to have a good to excellent education.

Australia has always been a very athletic, competitive and sports conscious country. Since its founding, it has encouraged and supported all forms of sporting activities, in turn creating a strong sporting culture. This represents an individual who has willpower, determination and enough drive to forge his body into that of a professional level athlete. The Sportsman O.C.C. can be any kind of athlete, from a runner, baseball or football player to a boxer, wrestler or martial artist. When the player creates the character, he/she must choose an area of sport to become professional in (see below for details).

Sportsmen in the Tech-Cities (with virtually all events televised) are well respected, and quite often idolized — however, there's little time for "playing" in the **Outback**, so except for the occasional gladiator and other rough, local games or contests, there are few widely recognized "sporting events or heroes." Even the **Roadgangers** and bandits have members who would fall under the Sportsman O.C.C., although they tend to engage in vicious, life or death contests which are more like gladiatorial games, duels and demolition derbies than "real" competitive sports.

City Sportsmen have it easy, with leisure time to spend on gyms, coaches, nutritious food supplements, health care and playing. Also, their sports are usually safer and controlled, such as team sports on turf and under lights, athletics on a specifically designed field, strict rules against cheating or the illegal use of weapons, etc. Many Sportsmen are amateurs who have reached a professional or near pro level at what they do simply because it is a hobby they love, and they practice it constantly. Such a person probably has an ordinary job, or place in his community and may not realize (or care) that he could compete with other, paid athletes. In the **Outback**, the most nefarious and brutal will be cheating villains and bloodthirsty gladiators.

Whichever type of character a player decides to play, the following statistics and bonuses will cover all aspects under the one O.C.C. type.

### Special Sportsman O.C.C. Abilities & Bonuses

**1. Physical Benefits of Constant Athletic Training:** Depending on the area the character originated from, bonuses are applied to *starting* attributes and a base S.D.C. of **3D6**. These and skill bonuses are accumulative.

**Coastline/Rim** Background: Harsh training conditions; add **+1D4** to P.E., **+1D4** to P.S., **+1** to P.P., **+2** to P.E. **+1D6+1** to Spd., **+1D6** to P.B. and **+3D6+6** to physical S.D.C.

**Desert/Back** of Beyond Background: A bloody lifestyle and shocking training conditions accumulate to add **+1D6** to P.S., **+1D4** to P.E., **+2D6** to Spd and **+2D6+12** to physical S.D.C.

The character also receives a special, one-time bonus of +1D6 to starting Hit Points.

City Background: Professional training facilities are one thing, but the Admin also encourages its athletes to use muscle enhancing drugs, and private coaches are paid to drive the athletes to their absolute limits. As a result, add +1D4+2 to P.S., +1D4 P.P., +1 to P.E., +1D4 to P.B., +4 to Spd. and +3D6+10 to physical S.D.C.

**2. Strong Mind:** Working on the body also sharpens the mind. Sportsmen enjoy a +1 to saving throws against mind control and illusions, and +2 to save vs disease and pain of any kind.

**Special Skills & Combat Bonuses:** When the character is created, select an area of expertise from the list below, and apply the relevant skills and bonuses.

- **Archer Professional:** The Archery and Targeting skill, with an additional +1 to strike and one extra bow attack per melee round.
- **Ball Sports:** +1D4 to S.D.C. and +2 on initiative when using a bat, club or other striking weapon, +1 to strike, and gets the skills Running (with an extra +1D6 spd bonus), W.P. Thrown Weapon or W.P. Bat/Club (same as W.P. Blunt).
- **Bicyclist:** +1D4 to P.E. and Spd attributes, +1 on initiative, +1 to dodge while on a bike, plus the skills Basic Maintenance/Repairs, Running, and Cycling (+20%). **Note:** The pro-cyclist can reach speeds that are three times his normal running speed and can maintain maximum speed for P.E.x10 in minutes.
- **Fighter: Professional Boxer:** The Boxing skill with all its bonuses plus these additional ones: +1 to P.E., +1D6 to S.D.C., +1 on initiative, +1 to strike, +2 to disarm and +4 to pull punch. For the cost of two Secondary Skills, the character can also get automatic dodge (works like a parry, moving/bending out of harm's way without losing a melee action).
- **Fighter: Gladiator:** +1 on initiative, +2 to disarm, +1 to parry, +3 to save vs Horror Factor, +2D6 to S.D.C. plus the skills, Hand to Hand: Expert, Boxing, W.P. Paired weapons, three Ancient Weapon Proficiencies of choice and one Modern. For the cost of two Secondary Skills the character can also get automatic dodge (works like a parry, moving/bending out of harm's way without losing a melee action).
- **Fighter: Martial Artist:** Hand to Hand: Martial Arts, +1 to P.P., +2D6 S.D.C., plus the extra bonuses of +1D4 on initiative, +2 to pull punch, and +2 to disarm. Alternatively, at the cost of two *O.C.C. Related Skills* or *four Secondary Skills*, the character could take one of the martial arts detailed in **Rifts® World Book 8: Japan** or one of the (modified) martial arts from **Ninjas & Superspies** (minus any special Oriental Mystic Powers).
- **Fighter: Professional Wrestler:** The skills Hand to Hand: Expert and Wrestling with all their usual bonuses, plus these additional ones: +1 to P.E., +1 on initiative, +1 to disarm, +1 to roll with punch, fall or impact, +3 to pull punch, and all "pin" combat maneuvers in hand to hand combat.
- **Football (American or Rugby):** +2D6 to S.D.C. and +1D4 on initiative, +1 to strike, +2 to roll with punch, fall or im-

pact, and gets the skills Running and can select Gymnastics or Wrestling.

- **Motor Sports:** +2 on initiative, +1D4 to M.E., plus the skills Pilot: Automobile, Race Car and Motorcycle, each at +20%, along with Australian Combat Driving and Automotive Mechanics (+5%).
- **Mountain Climber:** The Climbing skill (+15%), and +1D6 to P.S. and P.E.
- **Pro-Gymnastics:** The Gymnastics skill, +1D4 to P.S., +1 to P.E., +1 to P.B., +1 on initiative, +1 to dodge and +1 to roll with punch, fall or impact.

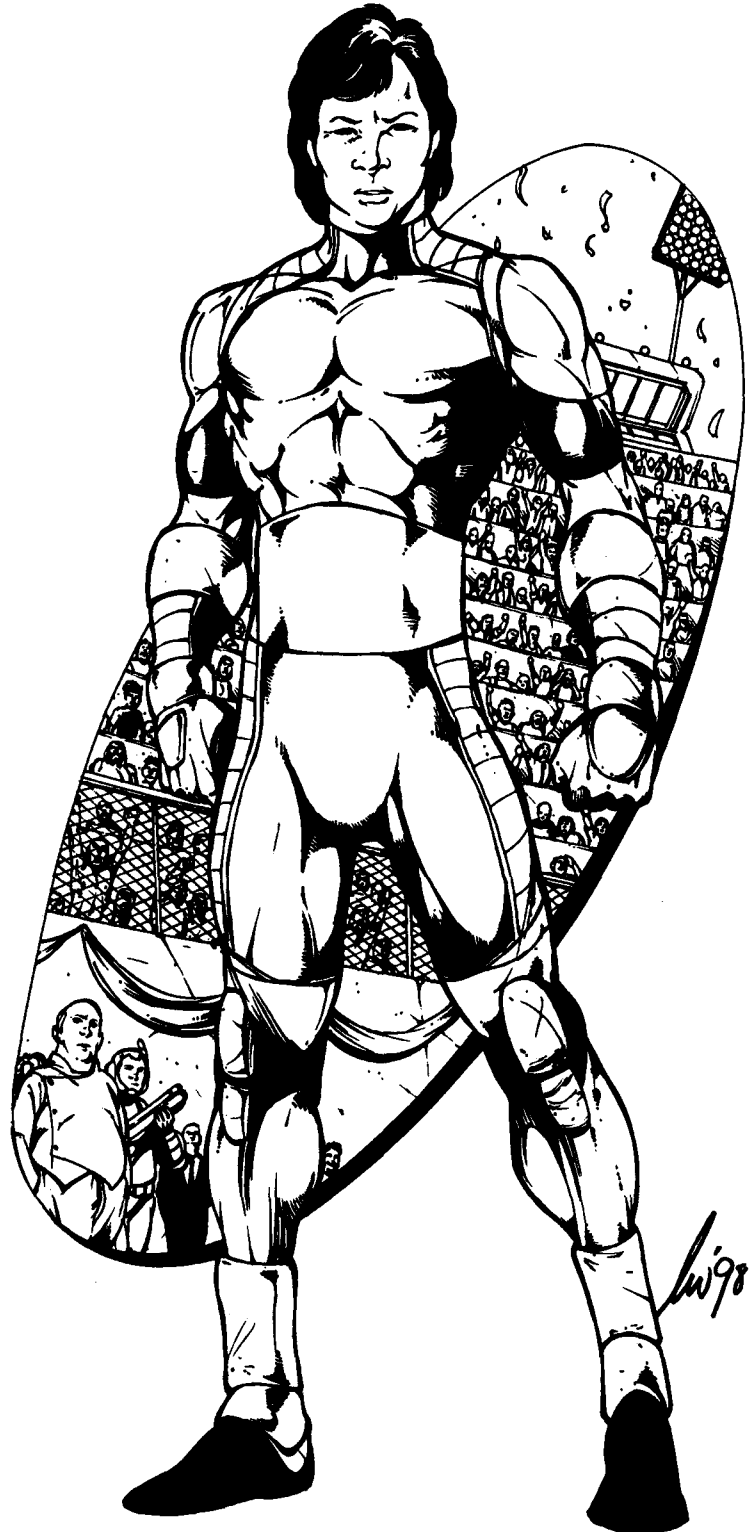

- **Pro-Acrobat:** The Acrobatics skill, plus an additional +1 to M.A., +2 to P.S., +1D4 to P.P., +1 on initiative and +1 to strike.
- **Sailing: Pilot:** Sail Type (+15%), Navigation and Swimming.
- **Surfer & Swimmer:** +2 to P.P., +1D4 to M.A. or P.B., +1 to P.P. and P.E., +1 to roll with punch, fall or impact, +1D6 to S.D.C., plus the skills Swimming (+15%), Surfing and Gymnastics (+5%).
- **Swimmer & Diver:** +2 to P.S. and P.E., +1D4 to P.B., +3 to roll with punch, fall or impact, +1D6 to S.D.C., plus the skills Swimming (+15%), SCUBA (+10%), and Acrobatics (+5%).
- **Shooter: Big Game/Trophy Hunter:** W.P. Bolt-Action Rifle, W.P. Energy Rifle (for hunting M.D.C. creatures), Track Animals (+10%) and Wilderness Survival (+5%).
- **Shooter: Target Shooter:** W.P. Revolver, W.P. Pistol, W.P. Bolt-Action Rifle, and Sniper; +2 on initiative and +1 on aimed shots when using any weapon from the above W.P.S.
- **Track and Field:** +2 to P.E., +2D6 Speed, +2 on initiative, +1D6 to S.D.C., and the skills Running (with an extra +2D6 to spd) and Gymnastics.
- **White Water Sports:** +1 to P.E., +1D6 S.D.C., +1 on initiative, plus the skills Swimming (+5%), Pilot: **Kayaking** (+15%) and Pilot: (small) Boats. **Note:** The pro can maintain speed in still water equal to the **character's** P.S.x2 (treated for all purposes as Spd), and maintain speed for **P.E.x10** in minutes without pause.

**SPECIAL: Multiple Specializations.** It is possible to create an athlete that specializes in more than one field. If one extra Athletic specialization is taken reduce the selection of O.C.C. Related Skills by half, and the skill bonuses of the second specialization by half, but round down, so +1 means no bonus (skills and skill bonuses are unchanged). If three athletic specializations are taken, reduce the selection of O.C.C. Skills to two, and the skill bonuses of the third specialization by half, (skills and skill bonuses are unchanged).

## Some Adventure Ideas for the Sportsman

**Wanted Man:** The Sportsman character is an Outbacker who has drawn the attention of the City, and they want to recruit (perhaps even capture and force) him to play in their games. The character may or may not be opposed to their offer. And if he refuses, they can be very persuasive ...

**Arena Fighting:** This is the kind of thing that's common in the Outback. The "arena" is often little more than a designated ring or field of flat, open land or the town square, a back lot, basement or tent. The character or player group are competitors in a rough and bloody game. The game can be for fun or part of a festival, tough-man competition or way to make money — "Defeat **Bruno** (a hulking monster, perhaps literally) in a fair **fistfight** (or with weapons) and win 500 cash! Your only risk, the \$50 entrance fee, some broken bones and a bruised ego." Just the kind of polite challenge that many **Outbackers** jump at. At some of the harsher communities, fighting or contests (rarely to the death) is a means of determining justice, the settling of a dispute or challenge, defending one's honor, earning a trade agreement, and other issues.

**Local Hero:** The character is a local icon from whatever area he is based in, and has simply decided to become an adventurer. Alternatively, he is dragged into some adventure where his skills as an athlete help save his comrades. He is also likely to be challenged to brawls constantly. "You don't look so tough to me, Big Shot."

**Goodwill Team:** The Sportsman character or player group are drawn into becoming players in goodwill games between the Outback and one of the Tech-Cities, OP Sydney Town or some other community. They play a sport for the entertainment and personal reward of both sides. Whether the games are fair and controlled or anything goes affairs will depend on the sponsor, competitors, and the situation. In addition, the crowds of rival spectators will be emotionally charged (and depending on where these games are held, perhaps heavily armed), which will lead to brawls, rioting and perhaps murder — think Soccer World Cup. Such a big event might also signal brigands that it's a good time to make a raid or enemies to engage in some spying, politics or open attack.

**Entertainers:** Similar to a circus caravan, the player characters survive by providing sporting entertainment in otherwise dull Outback communities. A reasonable fee to attend **and/or** room and board plus discounts on trade goods is the common price of admission.

**Gladiator:** The **character(s)** is a Sportsman or fighter who takes on matches for money, food, shelter, trade goods, etc., but doesn't owe an allegiance to any particular community or sponsor.

**Everyday Hero:** Like the vagabond or Outbacker O.C.C., this type of Sportsman is just an everyday Joe Athlete who is dragged into some sinister plot that turns him into an adventuring hero.

## Sportsman O.C.C.

**Note:** The Sportsman O.C.C. is a character class that can be transplanted to any modern **setting**, anywhere in the world.

**Alignment:** Any

**Attribute Requirements:** M.E. 10 and P.S., P.P. and P.E. 12 or higher (these are the pros after all), plus a competitive spirit. Other high physical attributes and good I.Q. are helpful but not required.

**Alignment:** Any.

**Base S.D.C.:** See bonuses previously described.

**Basic O.C.C. Skills:**

Speaks English at 80+3D6%

Basic Math (+3D6%)

Dance **or** Cook (+10%)

First Aid (+10%)

General Athletics

Body Building and Weight Lifting

W.P. **One** of Choice

Hand to Hand: Basic unless occupation states otherwise.

There is no room for improvement unless an area of sports specialization.

**O.C.C. Related Skills:** Select eight other skills of choice. Select one additional at levels 2, 4, 8 and 12. New skills start at the first level of proficiency. Don't forget the skills from the Sportsman's area of specialty.

Communication: Any (+5%)

Cowboy: None  
 Domestic: Any  
 Electrical: Basic only.  
 Espionage: None  
 Mechanical: Basic and Automotive only.  
 Medical: None  
 Military: None  
 Physical: Any  
 Pilot: Any (+5%), except Robot Elite, Jet Aircraft, Jet Fighter or military vehicles  
 Pilot Related: Any  
 Rogue: Any except Computer Hacking.  
 Science: Math only.  
 Technical: Any (+5%), except Computer Operation and Programming  
 W.P.: Any  
 Wilderness: Any

**Secondary Skills:** Also select **five** secondary skills from the previous list. They are limited by "Any, Only and None," and do not receive any of the bonuses listed in parentheses. These are additional areas of knowledge and start at the first level of **proficiency**.

**Standard Equipment:** Starting equipment will usually be based upon the type of sport the character is involved in. He **will**, of course, have all the necessary items for his area of expertise - weapons, protective gear, maybe a few uniforms and so forth. Some sports also require vehicles, like a bicycle or a surfboard.

Aside from sporting equipment, the character will also own a few basic essentials. First-aid equipment, painkillers, a few sets of good looking clothes, a disc player and headphones, a few sets of **of**boots/shoes for training, a weight set, a book or two on the chosen sport and maybe a collection of 1D4 trophies (player decides).

Adventuring equipment depends on the background and situation, and is left up to the G.M. The player may spend \$3000 on buying adventuring equipment.

**Money:** Starts with 2D4x\$300 in dollars, everything else has been spent on equipment and fun. NPCs will have three times as much, but half will be in **tradeable** items.

**Cybernetics:** None. Cybernetics destroys the ethics of sportsmanship and defeats the purpose of years of physical training to attain excellence. Of course, **prosthetics** will be considered, but when this happens a Sportsman generally considers his career to be over. Evil or selfish Sportsmen may consider the use of small **and/or** secret devices for cheating, as well as illegal, performance enhancing chemicals, but if they get caught they are finished.

### Some Common Sports in Rifts® Australia:

**Cricket** A bat and ball sport similar to baseball (only a lot less interesting).

**Football.** Football comes in many different varieties, from gridiron to soccer. Most Australian football competitions are full-contact with no protective armor.

**Ironman Event.** The Ironman is a **grueling** event that combines the best of swimming and long distance running. Competitors race each other along a beach, and the legs of the race include swimming, paddling in the surf and running in the sand.

**Motocross.** A cross-country motorcycle race through mud and other hazardous terrain.

**Pentathlon.** The pentathlon involves five events, including running, track and field, shooting and endurance.

**Tennis.** Doubles or singles, tennis is an ancient sport that survives and continues to be popular in the cities, and even in the larger outback areas.

**Triathlon.** The triathlon is a race in three parts - starting with a swim, straight into a cycling leg (always the longest) and finished with a run.

**Arena Combat:** Arena fights are popular in the bigger outback towns. Arenas are specially built, and crowds gather to watch the fights take place. Weapons are usually allowed, and many variations of the sport have been developed, including two on one, three on one, team scuffles and even tag team events. Arena fights are usually ended by a knockout or first blood. Death matches are rare, and reserved for grudge or justice matches only.

**Blood-ball.** This hideous sport originated in the deserts, but has quickly spread to Rim venues as well. Teams of five play off against each other. The teams consist of two stoppers, usually big, frontline brutes, two runners and a goal keeper. Full contact fighting is allowed, as are basic weapons. The object is to take a large, spiked metal ball and slam it into the opposite goal area.

**Duels.** You name the weapon and people duel with them, from swords to M.D. weaponry. A duel can be done by points, till first blood is drawn or to the death!

**Freedom.** Freedom is a grizzly sport that was developed by the Melbourne Admin TRG command as a method of disposing of prisoners. A single prisoner, or sometimes a small group of weaker prisoners, is released into a bad zone of country and made to race, or just survive, to a designated point somewhere on the other side of the zone. Common areas include monster infested countryside, violent outback areas or the **Tasman** Isle. The event is policed by **gunships**, and the "competitors" are monitored with armbands that cause pain when the prisoner leaves the zone and explode when forcibly removed.

**Joust.** Joust is an ancient sport newly revived in the outback deserts. Simply, two competitors on motorcycles ride at each other with their own choice of gruesome melee weapons. If on the first pass they both miss, the fight turns into a melee. The rules are hazy, but generally if one competitor is knocked out, falls off his bike or is killed, he loses.

**Line Racing.** Similar to Range Trek, only slightly more dangerous and a lot shorter, Line Racing comes in many forms. The basic principle is that the athletes race along a major ley line, between nexus points, and avoid or battle whatever nasties they might encounter. Sometimes cars, motorcycles, bicycles, or riding animals are used, other times the race is on foot.

**Range Trek.** This is the ultimate endurance sport, and it takes days, even weeks, to complete. Arranged every three years separately by both the **Medbourne** Administration and the larger Rim towns, the event places a dozen or so athletes in the wild with very basic survival equipment. They are then required to race each other, cross-country, to a **predesignated** point. People die from accidents and exhaustion quite frequently. The event is so named because the Great Dividing Range is usually the site for the race.

**Ring Fighting.** Ring fights can be as dignified or crude as the crowd wishes. In the city, ring fights are usually boxing matches or semi-contact martial arts tournaments. Outside the walls, such matches **are** usually superseded by full contact fencing or knock-out, bare-fist prize fights.



## Technologist O.C.C.

By Ben Lucas & Kevin Siembieda

Technologists come in many shapes, sizes, ages and countless other varieties. Some are explorers, **scavengers**, some are scholars, scientists, mechanics, City Rats, or ordinary people with a love for machines and technology. These are the guys and gals who get excited about the latest upgrade for a computer program, faster computers, better memory, robotics and new

break-throughs. The art of locating, salvaging, rebuilding and nurturing technology has become a science and career all of its own since the Apocalypse. What humanity lost in the fury and carnage of the Great Cataclysm, and was buried by the centuries long dark ages may never be fully recaptured, but many try (of course, there are those who believe the world is a better place without it all).

The Technologist is an occupation (and player character) that can be found in the Tech-Cities, Wastelands, and all over the world. In Perth and Melbourne they are mechanical and electrical engineers and scientists who spend their time trying to recapture and improve upon old technology and make their own contributions to the new. In the ravaged Outback and other parts of the world where the old has been all but **obliterated**, the Technologist is a scavenger, **tinkerer**, mechanic, historian and collector all rolled into one. They search the shattered earth and ancient ruins for lost secrets, old manuals, parts and components that they can use to build and survive. They are the men and women who help ease some of mankind's pain and make life a little bit easier, at least here and there. Most don't know enough to realize how much has really been lost, but what little they can scrape together gives them more knowledge, a better life, and a small piece of their past heritage.

**Meanwhile**, wrapped safely in their old world environment of **pre-Rifts** Australia, the cities Melbourne and Perth have a different view entirely. They have a good understanding of what was lost, and also retain more than many others dare to dream about. To them, technology is the only thing that separates humanity from the apes and barbarians of the Outback. To the City-Goers, technology must be not only restored, but maintained and developed if there is to be a future.

Be they the arrogant and rich City-Goer or the scavenging **Outbacker**, Technologists, especially those in the wilderness, are almost "priests" of **gadgets**, machinery, electronics and software. They are the technological wizards — the new advisers and adepts of science and machine knowledge that might have vanished entirely (at least in the Outback), if not for their efforts. They not only work to rediscover pre-Rifts technology and make it applicable to modern life, but they challenge themselves to build and improve upon it and make something new and more advanced — ironically, for those in the wilderness, even finding pre-Rifts material and figuring out how it works can be a Herculean task. For unlike their sophisticated City-bred counterparts (living in one of the most technologically advanced societies on the planet today), Outback Technologists are pioneers exploring brave, new landscapes.

The typical Technologist, whether from the City or Outback, is inquisitive, intelligent, creative and scholarly. Most are also varying degrees of pack-rat, especially those out in the wilderness where parts and electronics are rare and highly coveted. They love machines and technology and are drawn by the allure of tinkering with gizmos of all kinds. He or she can come from almost any walk of life, and the cities (worldwide) are filled with them. They may be Level One citizens, tinkering in the underground to make high grade comforts available to all citizens, respected engineers working in a large institute to research product development, military scientists that make expeditions into the Gap to scavenge old world sites like Sydney and Lake Canberra, or lowly and often underrated (at least by City



Goers) Outbackers with a keen sense of history and an eye to the future. Note that major psychics with the power of Telemechanics often become Technologists.

### **Technologist O.C.C.**

**Alignment:** Any, although a third are anarchist.

**Attribute Requirements:** I.Q. 11 and P.P. 11 or higher.

#### **City Technologist O.C.C. Skills:**

Speaks English 98%  
Literacy: English 98%  
Basic Mathematics (+30%)  
Advanced Mathematics (+20%)  
Radio: Basic (+20%)  
Mechanical Engineer (+10%)  
Electrical Engineer (+25%)  
Computer Repair (+15%)  
Computer Operation (+20%)  
Computer Programming (+20%)  
Computer Hacking (+15%)  
Read Sensory Instruments (+15%)  
Photography or Surveillance (+10%)  
Pilot: Two of choice (+5%)  
Lore: One of choice (+5%)  
Hand to Hand: Basic, and can be upgraded to Expert at the cost of two "other" skills.

**O.C.C. Related Skills of the City-Technologist:** At level one, select three skills from the category of Communications or Military, plus four other skills of choice. Select two additional skills at levels 3, 5, 9 and 14. New skills start at the first level of proficiency.

Communication: Any (+10%)  
Cowboy: None  
Domestic: Any (+5%)  
Electrical: Any (+15%)  
Espionage: Intelligence only.  
Mechanical: Any (+10%)  
Medical: Any; particularly Cybernetics (+10%)  
Military: Any (+10%)  
Physical: Any except Acrobatics, Boxing and Wrestling.  
Pilot: Any (+10%)  
Pilot Related: Any (+15%)  
Rogue: Palming, Pick Locks and Seduction only.  
Science: Any (+10%)  
Technical: Any (+15%)  
W.P.: Any  
Wilderness: None

**Note:** See *Rifts World Book 11: Coalition War Campaign* for many more skills to select in technical areas, including expanded rules and notes on demolitions. The G.M. can also take a look at the *Ninjas and Superspies™ RPG* for notes on tinkering and other technical skills which he *may* want to include (easily adapted).

#### **Outback Technologist O.C.C. Skills:**

Speaks English 80% +2D6%  
Literacy: English 98%  
Select one other language (+20%)  
Basic Mathematics (+25%)  
Advanced Mathematics (+15%)  
Radio: Basic (+15%)  
Mechanical Engineer (+20%)

Electrical Engineer (+10%)  
Computer Operation (+15%)  
Computer Programming (+10%)  
Computer Hacking (+10%)  
Read Sensory Instruments (+15%)  
Archeology (+15%)  
Anthropology (+10%)  
Lore: Two of choice (+10%)  
Outback Survival (+10%)  
Hand to Hand: Basic, and can be upgraded to Expert at the cost of two "other" skills.

**O.C.C. Related Skills of the Outback-Tech:** Select six other skills of choice from the list below. Select two additional skills at levels 3, 6, 9 and 12. New skills start at the first level of proficiency.

Communication: Any (+10%)  
Cowboy: None  
Domestic: Any (+10%)  
Electrical: Any (+10%)  
Espionage: Escape Artist, **Forgery**, Intelligence, and Pick Locks only (+5%).  
Mechanical: Any (+15%)  
Medical: Paramedic only (+5%)  
Military: Any (+5%)  
Physical: Any except Acrobatics, Gymnastics, and Wrestling.  
Pilot: Any (+10%)  
Pilot Related: Any (+10%)  
Rogue: Card Sharp only.  
Science: Any (+5%)  
Technical: Any (+10%)  
W.P.: Any  
Wilderness: Any

**Secondary Skills (same for both):** Also select five secondary skills from the previous list. They are limited by the categories listed, but do not receive any of the bonuses listed in parentheses (). These are additional areas of knowledge and start at the first level of proficiency. An extra secondary skill is gained at levels four, eight and twelve.

**Standard Equipment (same for both):** The Technologist starts with a startling array of gizmos and pieces of **gadgetry**. To start, he is likely to own **1D4+1** personal computers (desktop computer, laptop, hand-held mini-computer, etc.), plus an electronic notebook, language translator, portable CD player and recorder, photo (or digital) camera or video camera, multi-optic band (head gear), pocket **flashlight**, full-sized flashlight, laser scalpel, magnifying glass, portable tool kit (with soldering iron, current tester, etc.) and much larger and better equipped home electronics lab. This is in addition to basic adventuring or "field" equipment such as **traveling/hiking** clothes, **wristwatch** (wrist **computer?**), sunglasses, goggles, clipboard, small camera, radiation detector, lab coat, protective gloves and an array of small sample bags and tools. Other equipment, spare parts and components may come standard at the discretion of the Game Master, and depending on the type of work the character performs.

The character will also have a base of study. For the City-Tech, the higher his social **Level** (0-5) the more likely the character is will to be highly placed, perhaps even working for the government, and has access to a full **electron-**

ics/computer lab with assistants, access to high-tech equipment and maybe even cybernetics, robotics, **E-Clip rechargers** and explosives. For those of low or moderate social levels (0-3) and Outbackers, the character may have on-the-job facilities available, but does most of his work at his small, self-funded home lab with maybe one assistant and some rudimentary equipment.

Those technologists operating in the field or traveling as part of their **work**, will have a vehicle of some sort (van, truck, etc.) that contains a mobile electronics lab and basic equipment, along with an independent energy source (like **E-clips**, generator, etc.) to run the equipment.

**Money:** City-Techs start with **1D6x\$1,000** plus an annual income of **3D6x\$3,000** (30-50% more if a Level 4 or 5 Citizen).

Outback-Techs start with **1D4x\$1,000** in **tradeable** goods/parts and **3D6x\$100** in dollars. They've spent most of their money on their equipment and collection of electronics, parts and machines. Most can earn a nice income, equal to **1D6x\$500** per month — skilled mechanics, electricians and repair people are hard to come by in the **Outback**, and are greatly appreciated. Unfortunately, most wilderness people and communities can seldom pay what the Technologist is worth, but something is better than nothing. Besides, if a community feels beholden to a character, they are more likely to provide favors and information, and, in the case of the Technologist, save him what parts, components and ancient artifacts they might unearth.

**Cybernetics:** City-Techs start with a Universal headjack and ear implant. May select **1D4+1** additional cybernetic enhancements, but no bionics. Usually opt for eye implants, image enhancements, macro-vision, tools, scanners and similar sensory augmentation.

Outback Techs start with none, but will be eager to acquire them if given the chance.

## Military O.C.C.s

The following are a few notable Occupational Character Classes that represent the troops and armed forces of the two Tech-Cities; Army, Navy and Air Force. Standard military O.C.C.s like the Military Specialist, Communications Officer, Field Scientist, etc., presented in other **Rifts® World Books** (most notably *Coalition War Campaign* and *Coalition Navy*) can be adapted for use in the Tech-Cities. However, these troops are not as seasoned as the CS, **Triax**, or Russia (average experience level of City Infantry troops is 2nd-3rd level, with only 20% being 4-8th), nor do they have many specialized troops like Commandos, Juicers, or Cyborgs, and human **mutants/Phreakers** take the place of mutant animals (no Dog Pack).

## Aerojock O.C.C.

"**Aerojock**" is the simple nickname given to the pilots in the two Tech-Cities' Air Forces. Both Air Forces are very well equipped, powerful and give Perth and Melbourne a tremendous advantage over their Outback rivals and monstrous enemies in speed, tactics and **firepower**. All pilots are top-flight, well trained and gung-ho. Most **Aerojocks** are dedicated, determined and deadly combat pilots who can fly their machines by the seat

of their pants, make death defying maneuvers and take daring risks. They provide air assault, air support and transportation of troops and combat equipment. They are always very busy with patrols and missions into the Gap — everything from diplomatic missions to combat "cleanse and burn" operations. Both are formidable, but Melbourne's Air Force is the more aggressive, seasoned and expansive of the two. In fact, if the two cities ever came to blows, Melbourne's air superiority would give them a decided edge. The men and women (60/40 split) of the Melbourne Air Force are extremely hawkish and tend to be fanatical in their defense of Melbourne, their disdain for "primitives" (i.e. wilderness folk) and hate **of nonhumans**.

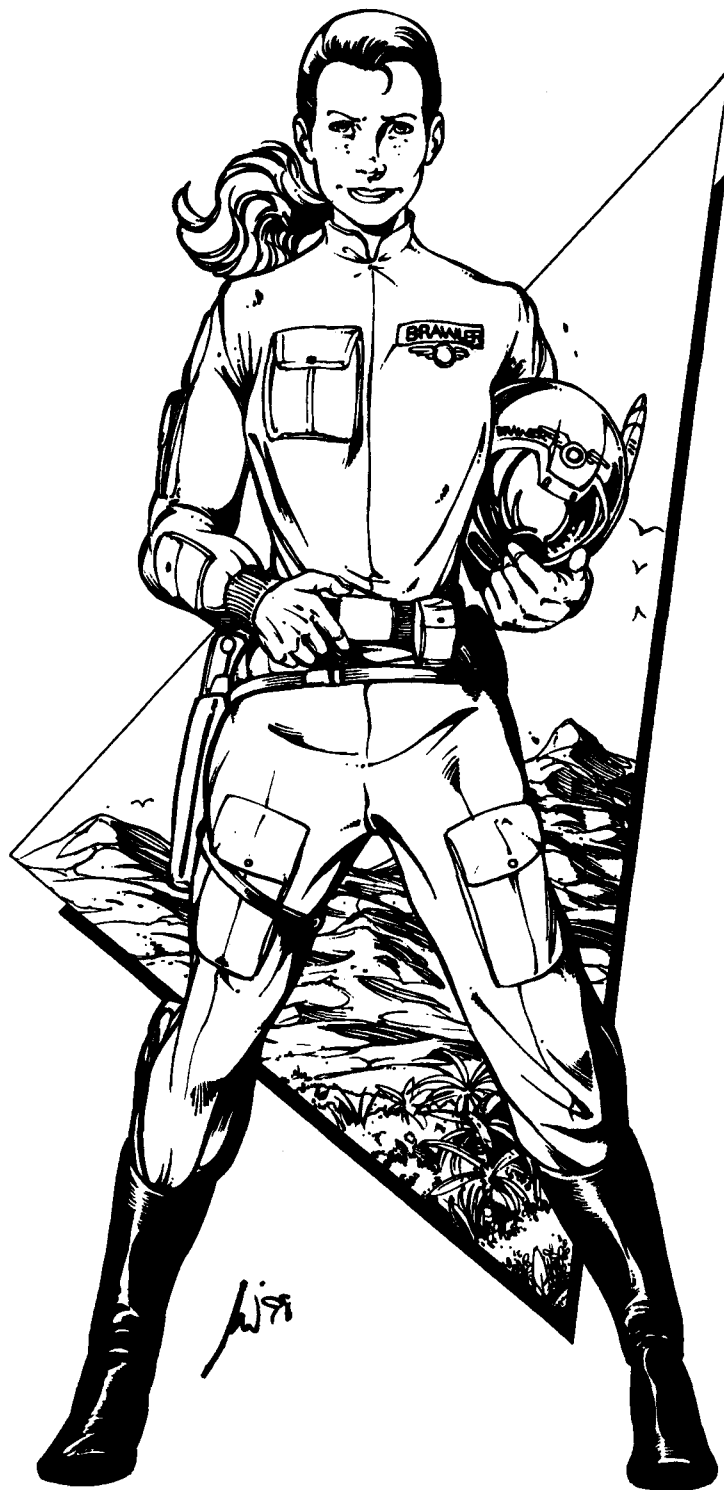

## Aerojock O.C.C.

**Alignment:** Any, but 25% are Aberrant evil (highly disciplined and completely loyal to their city, but so ruthless and vicious to outsiders that they are definitely evil).

**Attribute Requirements:** I.Q. 13 and M.E. 12 are required to become a pilot. A high P.E. and P.P. are recommended but not required.

**Base S.D.C.:** 4D6+10

**O.C.C. Bonuses:** +1 to P.P., +2 on initiative, +1 to roll with punch, fall or impact, and +1 to save vs Horror Factor at levels 1, 3, 6, 9 and 12.

### O.C.C. Skills:

Speak English at 98%

Literacy (+30%)

Mathematics: Basic (+15%)

Radio: Basic (+20%)

Radio: Scramblers (+10%)

Military Etiquette (+20%)

Pilot: Helicopter (+15% in Melbourne, +20% in Perth)

Pilot: Jet Fighter (+20% in Melbourne, +10% in Perth)

Pilot: Robots and Powered Armor

Pilot: Hover Craft (+15%)

Read Sensory Equipment (+20%)

Weapon Systems (+15%)

Navigation (+15%)

Climbing (+5%)

General Athletics

W.P. Energy Pistol

W.P. of choice (any)

Hand to Hand: Basic to start, but can be upgraded to Expert at the cost of one O.C.C. Related skill, or to Martial Arts for two other skills.

**O.C.C. Related Skills:** Select nine other skills, of which *two* must be from Pilot or Pilot Related. Select one additional skill at levels three, six, nine, twelve and fifteen. New skills start at the first level of proficiency.

Communication: Any (+5%)

Cowboy: None

Domestic: Any

Electrical: Basic only.

Espionage: None

Mechanical: Aircraft, Automotive and Basic only (+5%).

Medical: First Aid only.

Military: Any (+5%)

Physical: Any, except Gymnastics.

Pilot: Any (+15% to any flying vehicles in Melbourne, +10% in Perth; +10% at both places to all other vehicles).

Pilot Related: Any (+15%)

Rogue: None

Science: Advanced Math and Astronomy only (+10%).

Technical: Any (+5%)

W.P.: Any

Wilderness: None

**Secondary Skills:** Also select four secondary skills from the previous list. They are limited by the categories listed, but do not receive any of the bonuses listed in parentheses. These are additional areas of knowledge and start at the first level of proficiency.

**Standard Equipment:** Standard issue equipment includes a padded M.D.C. flight suit (12 M.D.C.) and helmet (35

M.D.C.) that also insulates them from extreme cold and acts as a wet-suit, daily and dress uniform, boots, and flight jacket. Pilots are lightly armed, typically an energy pistol with four **E-clips**, and one other weapon (often a **Vibro-Blade**). Any additional weapons will be locked down in their aircraft and may include 2-6 hand grenades, an energy rifle, **and/or** shotgun or other type of weapon. Note that Helicopter crews will include Door-Gunners who may be Air Force Grunts (infantry skills) trained with heavy weapons and assigned to the Air Force. They will have heavy weapons but lack piloting skills.

Armor is typically the light flight suit (no movement penalties) **and/or** a flak vest. A light suit of body armor is also allowed; heavier armor is just not practical for pilots, although Door-Gunners often wear heavy armor. The Aerojock is also authorized to **pilot/wear** Power Armor, but Power Armor is too large and bulky to be worn in the cockpit of a aircraft.

The Aerojock has access to any flying vehicle, including the **VR** robot helicopter, power armor and all types of aircraft.

Other equipment includes a small first-aid **pack**, binoculars, survival knife, canteen, air filter and gas mask, utility belt, five signal flares, pocket (signal) mirror, and tinted **goggles/sunglasses**.

**Money:** Monthly salary is \$3000; this goes up by \$200 per level of experience, plus room and board, paid medical treatment, and access to military facilities. Starts with **2D4x\$1000** in personal savings.

Living quarters is a **dormroom-style** apartment at the city Air Force Barracks, shared with three other pilots (usually two **pilot/co-pilot** teams). The dorm is air conditioned, and has full TV/video features as well as light **entertainment/sports** facilities. The barracks training facilities include full immersion simulators and testing grounds.

**Cybernetics:** None to start. May or may not be in favor of cybernetics and bionics. The Armed Forces are quick to repair serious injury to their pilots with artificial replacements, but not augmentation.

## Infantry Grunt O.C.C.

This character is your standard infantry soldier, and is very similar to the CS Grunt. The City Infantry is comprised of well armed, well trained, levelheaded men and women who are firm believers in their role as protectors of their respective city, which is, in their minds, the last bastion of civilization and the true inheritors of Riffs Australia. As individuals, their morals and personalities may differ greatly, but as a unit they are of one mind to uphold and preserve the city-state against the chaos of the post-Riffs landscape.

There are many roles within the Armed Forces. The following O.C.C. represents the most basic level soldier. Other basic military O.C.C.s presented in **Coalition War Campaign**, **Coalition Navy** and **Triax and the NGR** can be modified and included for use in an Australian campaign.

### Infantry O.C.C.

**Alignment:** Any, but 15% are Aberrant evil (highly disciplined and completely loyal to their city, but so ruthless and vicious to outsiders that they are definitely evil).

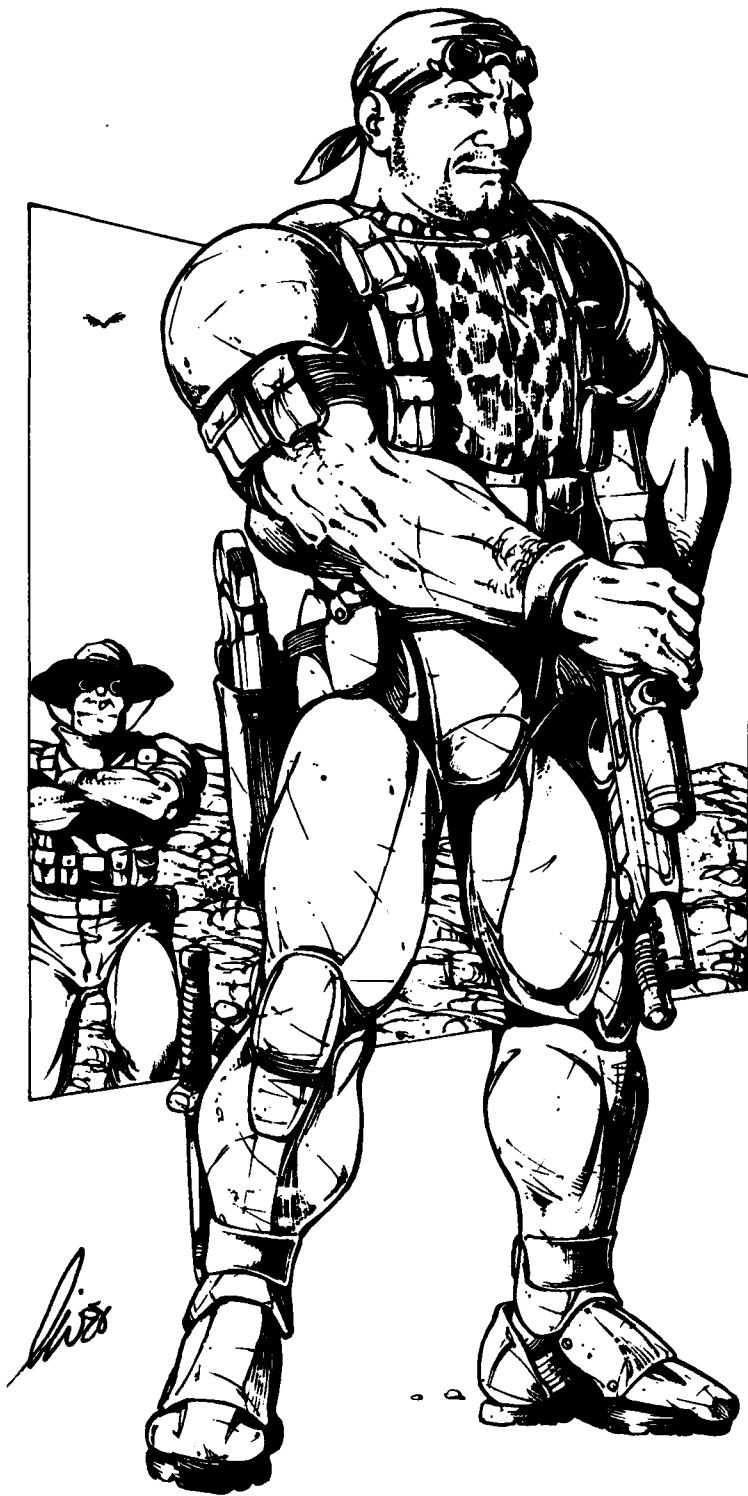

**Attribute Requirements:** A strong sense of patriotism and high P.S. and P.E. are recommended, but not required.

**O.C.C. Bonuses:** 1D4x10+6 S.D.C., +1D4 to P.S., +1 on initiative, +1 to pull punch, and +1 to save vs Horror Factor at levels 2, 4, 6, 8, 10, 12 and 14.

**O.C.C. Skills:**

- Speaks English at 86%+3D4%
- Literacy (+15%)
- Basic Math (+10%)
- Military Etiquette (+10%)
- Radio: Basic (+10%)
- Pilot: Tank and APC (+14%)
- Pilot: Automobile *or* Hovercraft (+10%)

- Robot Combat: Basic
- Read Sensory Equipment (+10%)
- Weapon Systems (+10%)
- Body Building
- Climbing (+5%)
- General Athletics
- W.P. Energy Pistol
- W.P. Energy Rifle
- W.P. Heavy Weapons
- W.P. of choice (any)

Hand to Hand: Expert to **start**, but can be upgraded to Martial Arts at the cost of one O.C.C. Related skill.

**O.C.C. Related Skills:** Select four Military Skills and four other skills at level one. Select two additional skills at levels 3, 7, 11 and 15. New skills start at the first level of proficiency.

- Communication: Any (+5%)
- Cowboy: None
- Domestic: Any
- Electrical: Basic only.
- Espionage: None
- Mechanical: Automotive and Basic only.
- Medical: First Aid only.
- Military: Any (+15%)
- Physical: Any, except Acrobatics.
- Pilot: Any
- Pilot Related: Any
- Rogue: None
- Science: Astronomy and Math only (+10%).
- Technical: Any (+10%)
- W.P.: Any
- Wilderness: Outback Survival, Carpentry, Hunting and Land Navigation only.

**Secondary Skills:** Also select four Secondary Skills from the previous list. They are limited by the categories listed, but do not receive any of the bonuses listed in parentheses. These are additional areas of knowledge and start at the first level of proficiency.

**Standard Equipment:** Standard issue equipment includes a set of combat fatigues, boots, jacket, uniform, dress uniform, full brimmed hat, baseball cap, Trencher military body armor, web belt, holster, small first-aid kit, 5 mile (8 km) range radio communicator, five days rations in a small pouch, bedroll, backpack, survival knife, entrenching tool, canteen, air filter and gas mask, utility belt, 3 signal flares, four grenades of choice and tinted goggles/sunglasses for the harsh glare of the Australian sun. One weapon for each W.P. and six reloads. **Note:** The Melbourne Army dresses in tan and grey, while the Perth Army has a dark **green/khaki** uniform.

**Money:** Monthly salary is \$1500 +\$100 per level of experience, plus military room and board, paid medical treatment, and access to military facilities. Starts with 1D6x\$1000 in personal savings.

Living quarters is a dorm at the city barracks, shared with between 8-16 other soldiers, depending upon rank. Officers get their own small apartment. The dorm is air conditioned, and has full TV/video features as well as light **entertainment/sports** facilities. The base has its own entertainment complex with film theaters, arcades, gyms, **olympic-sized** swimming pool, target practice range, combat simulation stations and more.

**Cybernetics:** None to start. May or may not be in favor of cybernetics and bionics. The army is quick to repair serious injury to its soldiers with artificial replacements, but not augmentation.



## Special Operations Soldier O.C.C.

The Australian Special Forces are called "SO" — Special Operations. They perform many high security missions, from simple reconnaissance to full black operations into the wilder-

ness territory. The SO is also allowed to operate internally, within the city, where they function as special investigators, internal defense, and Special Operations (espionage and the elimination of special threats; demonic invaders, terrorists, etc.). They can even be authorized to spy upon other government and corporate departments under the direct instruction of the CAO. The SO are a tough breed of Commando-style covert operatives who are very serious about their duties, and are aggressive and fiercely loyal to their respective City and many lean toward human supremacy.

### Special Operations O.C.C.

**Alignment:** Any, but 33% are Aberrant evil (highly disciplined and completely loyal to their city, but so ruthless and vicious to outsiders that they are definitely evil).

**Requirements:** I.Q. 10, and P.S., P.P. and P.E. 12 or higher.

**Base S.D.C.:** 5D6+12

**Special O.C.C. Bonuses:** +3 to initiative, +2 to pull punch, +1 to roll with punch, fall or impact, and +1 to save vs Horror Factor at levels 1, 3, 5, 7, 9, 11, 13 and 15.

#### O.C.C. Skills:

Speaks English at 86%+3D4%

Literacy (+25%)

Basic Math (+15%)

Military Etiquette (+10%)

Radio: Basic (+15%)

Pilot: Two of choice (+15%)

Robot Combat: Basic

Read Sensory Equipment (+10%)

Surveillance (+15%)

Body Building

Prowl (+15%)

Swimming (+10%)

SCUBA (+10%)

Climbing (+10%)

Sniper

W.P. Energy Rifle

W.P. Energy Pistol

W.P. Two of choice

Hand to Hand: Expert, but can be upgraded to Martial Arts or Assassin at the cost of one O.C.C. Related skill.

**O.C.C. Related Skills:** Select three Espionage skills (+15% each), three Military skills (+15% each) and three of choice. Select one additional skill at levels 3, 6, 9 and 12. New skills start at the first level of proficiency.

Communication: Any (+10%)

Cowboy: None

Domestic: Any

Electrical: Basic only.

Espionage: Any (+10%)

Mechanical: Automotive and Basic only.

Medical: First Aid only.

Military: Any (+15%)

Physical: Any

Pilot: Any (+5%)

Pilot Related: Any

Rogue: Any (+5%)

Science: Math only.

Technical: Any (+10%)

W.P.: Any

Wilderness: Outback Survival, Carpentry, Hunting and Land Navigation only.

**Secondary Skills:** Also select four **secondary** skills from the previous list. They are limited by the categories listed, but do not receive any of the bonuses listed in parentheses. These are additional areas of knowledge and start at the first level of **proficiency**.

**Standard Equipment:** Standard issue equipment includes a set of combat fatigues, **boots**, jacket, uniform, dress uniform, full brimmed hat, baseball cap, Trencher military body armor, web belt, holster, small first-aid kit, 5 mile (8 km) range radio communicator, five days rations in a small pouch, bedroll, backpack, survival knife, entrenching tool, canteen, air filter and gas mask, utility belt, 3 signal flares, four grenades of choice and tinted goggles/sunglasses for the harsh glare of the Australian sun. One weapon for each W.P. and six reloads.

Special weapons, armor, vehicles and equipment may be made available for special assignments, including disguises and undercover clothing, black jump suits, camouflage suits, additional armor, power armor, heavy weapons, explosives, vehicles and so on. They turn to the air force for air support.

**Money:** Monthly salary is **\$2600, +\$250** per level of experience. Starts with **1D6x\$1000** in personal savings. Standard dorm housing with private apartments for officers.

**Cybernetics:** None to start. May or may not be in favor of cybernetics and bionics. The Military is quick to repair serious injury to its soldiers with artificial replacements, and may consider augmentation for its special forces. Approximately 10% of SO are partially reconstructed cyborgs and 5% are full conversion.

## Navy Sailor O.C.C.

It takes a special kind of person to endure the tough and demanding life of sea duty in the Navy. There is no room for the muscle-bound toughs who excel in the infantry — the Navy demands professionalism and discipline above and beyond that of the average Grunt. Navy Sailors must be smart enough to complete specialized training, and have enough mental endurance to spend weeks at a time pent up in the tight confines of a metal bucket. Self-motivation is another must, there is no room for slackers on a warship.

Duty is typically patrol boats, small ships and small to medium-sized submersibles that patrol and protect the harbors and waters around the two Tech-Cities. They seldom travel more than 20 miles (32 km) out to sea, so their sea experience is limited. In some ways, they function more as a heavily armored Coast Guard than a real "Navy." Power Armor is also used on ships, in the air and underwater. Aircraft and Power Armor provide air support and quick response.

### City Navy Sailor O.C.C.

**Alignment:** Any

**Attribute Requirements:** I.Q. 10, M.E. 10 or higher.

**O.C.C. Bonus:** +3D6 to S.D.C. and +1 to P.S., +1 on initiative.

**O.C.C. Skills:**

- Speak English **86+3D4%**
- Literacy (+20%)
- Basic Math (+10%)
- Radio: Basic (+15%)
- Swimming (+15%)

- SCUBA (+10%)
- Navigation (+10%)
- Weapon Systems (+5%)
- Pilot Ship (+10%)
- Pilot **Watercraft** of choice (+5%)
- Pilot Power Armor (one of choice)
- W.P. Knife
- W.P. Energy Rifle
- Hand to Hand: Basic

**MOS Skills:** In addition to the skills listed above, every sailor receives a skill package from his Military Occupational Specialty training. The MOS skill packages are as follows (pick one):

**Communications Technician:** Computer Operation (+5%), Radio: Scramblers (+12%), Cryptography (+5%), Basic Electronics (+10%).

**Sensors Operator:** Read Sensory Equipment (+15%), Computer Operation (+10%), Computer Repair (+8%), Radar/Sonar Operation (+15%).

**Mechanic:** Basic Mechanics (+15%), Submersible Vehicle Repair (+10%), Aircraft Mechanics (+10%), Computer Repair (+5%), Basic Electronics (+5%).

**Medic:** Paramedic (+15%), Basic Cybernetics (+5%), Field Expedient Surgery (+5%), Sea Holistic Medicine (+8%).

**Gunner:** Weapon Systems (+15%), Weapons Engineer (+10%), Demolitions: Disposal (+10%), W.P. Torpedo.

**Aviator:** Read Sensory Equipment (+12%), Pilot Helicopter (+15%), Pilot Jet Fighter (+15%), Pilot Robots & Power Armor (+5%), Robot Combat: Basic.

**Officer:** Navigation (+15%), Intelligence (+6%), Computer Operation (+10%), Pilot **Warship/Patrol** Boat (+15%), Naval History (+10%), Naval Tactics (+10%).

Note: If a skill from the standard O.C.C. list is duplicated in the weapons package, the higher of the two skill bonuses applies. Do not add the bonuses together.

**O.C.C. Related Skills:** Select five other skills. Plus select an additional skill at levels 3, 6, 9 and 12. All new skills start at level one proficiency.

Communications: None; only Officers & Communications Technicians can select any.

Cowboy: None

Domestic: Any (+5%)

Electrical: Basic Electronics (+5%); Technicians can select any.

Espionage: None

Mechanical: None. Mechanical Technicians can choose any.

Medical: First Aid only (+5%); Medics can select any (+10%)

Military: None

Physical: Any, except acrobatics.

Pilot: Any non-aircraft. Aviators can select any (+10%)

Pilot Related: Any (+10%)

Rogue: None

Science: Math and Astronomy only

Technical: Any (+10%)

Weapon Proficiencies: Any

Wilderness: Only Carpentry, Boat Building, and Undersea & Sea Survival (+5%).

**Secondary Skills:** The character also gets to select two secondary skills from the previous list at levels 1, 4, 8 and 12. These

are additional areas of knowledge that do not get the advantage of the bonus listed in the parentheses. All secondary skills start at the base skill level. Also, skills are limited (any, only, none) as previously indicated in the list.

**Standard Equipment:** Flak vest is standard issue, while power armor troops will have medium M.D.C. body armor and **their** power armor suit. Fatigue uniforms are standard dress for Sailors aboard ship plus a dress uniform.

Regular issue equipment includes an inflatable life vests (supports the weight of light to medium body armor), a heavy-duty **rainsuit**, winter jacket, woolen cap, several pairs of gloves, multi-blade pocket knife and grooming utensils.

Officers have, in addition to the above, a pocket computer, Pocket Digital Disc player, several tactical and history manuals on disc, and a full-sized computer in their quarters, and **sidearms** that consist of an energy pistol and **vibro-knife** or neural mace. Mechanics are issued basic tool kits and have free access to their ship's mechanics bays. Similarly, medics have access to hospital areas aboard ships and have personal first-aid kits.

Weapons are not issued to Sailors directly but are kept in lockers aboard ship. This is done for two reasons; first, because Sailors are rarely involved in direct combat, and secondly, to prevent mutiny. If a Sailor is posted to a dangerous duty (such as serving aboard a small patrol ship) he or she is issued an S.D.C. pistol and an energy rifle with three extra **E-clips**. On bigger ships, rifles and even sidearms are not issued except under combat conditions.

**Vehicle:** The character has no vehicle of his own to start, but is assigned to serve aboard a naval vessel (patrol boat to submarine or warship). Certain characters, most notably **aviators**, are assigned their own **VTOL** aircraft **and/or** power armor for combat and other military operations — not for personal use.

**Money:** Each Sailor is provided with clean, **spartan** quarters aboard ship while at sea. A berth is also provided for the sailor on land at his homebase free of charge. Shore quarters are a standard dormitory (see *Grunt O.C.C.* for details). **Food**, clothing, medical treatment and all other basics are also provided.

The character's pay depends on his position. Enlisted sailors earn **\$1800** a month, technicians \$2000 monthly, gunners, medical personnel, aviators and officers all get \$2400 a month **+\$100** per level of experience. They all start off with one month's pay.

**Cybernetics:** None to start and usually restricted to medical implants and **prosthetics**, not augmentation.



# Mutants

By Ben Lucas & Kevin Siembieda

One of the strangest occurrences in Rifts Australia is the appearance of inexplicable human mutation.

The exact cause of the mutation has never been defined although theories abound. Some, especially those in the Tech-Cities, are believed to be the result of mutations caused from radiation unleashed by shattered nuclear power plants **and/or** alien energy that leached through dimensional portals during the Dark Ages. Others are suspected to have been affected by experimental biological agents — germ warfare — accidentally released during the Apocalypse and which may have been influenced and mutated itself by "outside" agents (City-Goers refuse to acknowledge "magic" energy or the supernatural). Biological agents designed to attack human life on a genetic level may have, in fact, killed millions of people in the early days of the Dark Ages, nobody knows. There are vague records reporting a terrible plague that swept across the northeast, and there was a large genetics research complex up in New South Wales. Others suspect that the **mutagenic** source is the mystic energy that radiates in lines from the earth, things the natives call "**Songlines**." This theory concerns City-Goers because they don't understand or accept "magic," and fear it. Some even worry that the use of so-called magic energy may be the result of demonic possession or some other alien, corrupting influence.

The Aborigines have a different explanation. They claim the mutations are the result of the **Dreamtime**. They believe that most mutants are humans who possess special qualities that make them closer to nature, and that their physical change and unusual powers are the result of The Dreamtime. That these special beings have been partially transformed into an "animal-like perfection" and are, therefore, blessed and revered by the Aboriginal people as the "chosen." Chosen by the great Rainbow Serpent to stand against the darkness (supernatural evil and ignorance) and help mankind reach a new plateau in understanding and living at peace in the world. This makes those "**touched** by the Dreaming" respected and welcomed by the Aboriginal people. They accept these mutants — men and women they call the "good Animal Men spirits" (i.e. kind and helpful mutants), and give them a place of honor. "Animal Men" are not worshipped, but accepted as "higher beings," and even gruff, feral mutants are accepted with tolerance and all are treated with genuine respect, kindness, loyalty and high regard. In many instances, the Aborigines look to the "good Animal Men spirits" for insight and guidance. Not necessarily through their words, but in their deeds, behavior and **growth**, finding symbolism in how the Animal Men live, act, accept or respond to hardship, etc.

As the old saying goes, "you reap what you sow," many Animal Men (a term that includes males and females alike) respond to the Aborigines' kindness and generosity in land, showing them equal respect, high regard and kindness. Even the most **wild**, feral and animal-like mutant will be on his best behavior among **Aborginals**, as if sensing kindred spirits **and/or** feeling a higher purpose. As if the **Aborginals'** unshakable belief is true . . . **real** . . . and that they really may serve a higher purpose. Animal Men who are kind and willing to work as a member of a group, family or tribe are welcomed as honored kinsmen. A



level of genuine acceptance and camaraderie mutants find hard to achieve in human society, particularly among City-Goers, Roadgangers and other intolerant groups.

Marauding, evil and cruel "Animal Men" are believed to be dark, primal beings who have given themselves over to *Tikilik*, god of darkness and chaos, and knowingly or unknowingly serve his dreams of destruction and sorrow for the world. Such beings are disliked, avoided, chastised and, when necessary, slain without regret.

The derogatory word, "Phreaker," used by the City-Goers, has made its way into the Outback, but here, it usually refers to dangerous, evil mutants who engage in banditry, raiding and murder. The more common expression used by most Outbackers in reference to the average mutant is, "Mutie." While this may not sound much better to outsiders, it really isn't meant in any derogatory way, but simply as a statement of obvious fact ("Of course, OF Bob's a Mutie. A hell of a good guy, too"). Consequently, "Mutie" has no stigma attached to it. Unlike City-Goers, many (but not all) Outbackers and Outback communities accept mutants as friends, allies, and equals ("Him? Oh, he's just one of the guys. You know, a mate. Has proved hisself a hundred times. Jus' don't get him too liquored up"). In fact, Outback mutants are often a benefit in the wild and woolly wilderness where their special powers can make the difference between life and death. Some even become town leaders, and many more become lawmen, heroes and notorious adventurers.

## Phreakers

Mutants born among the City-Goers are regarded with varying degrees of fear and disdain. Most are relegated to Level 0 and 1 Citizen status, with only the most tolerant and least inhuman looking earning a place as Level 2 or 3 citizens; fortunate souls who represent less than 5% of the overall mutant population. Most are effectively Second-Class Citizens and virtually all are branded with the harsh, derogatory nickname of "Phreaker." As "freaks" they are rarely accepted by polite society and given the most menial and degrading jobs. Since most mutants have an animal appearance, most City-Goers assume they possess a low intelligence, poor manners, and a wild or aggressive nature. This is a foolish assumption that has become a degrading stereotype that the Governments does nothing to change. Ironically, any "poor manners," aggression or bestial behavior is born out of frustration and anger. The mutants' frustration, anger and sense of being trapped, leads many to go astray and explore a life of crime, or to become ardent reformists often branded as dangerous underground dissidents or terrorists. Sadly, others lose themselves to drinking, drunkenness and brawling. All of which only works to preserve the stereotype that they are subhuman animals to be feared and avoided.

The only place where Phreakers can find any level of equality, freedom and power is in the City Military (they are not allowed on the Police Force). As a Phreaker, the "normal" City-Goer would fear and distrust the mutant, so those in the military are predominantly assigned to wilderness duty outside the cities' walls. Duty includes defensive perimeter patrols, guard posts on and around the outer defensive walls, reconnaissance, rescue, infiltration, raids, seek and destroy, and covert operations into the various Outback communities, especially those suspected of smuggling, illegal trade and other criminal



activity or anything deemed a threat to City-Security. In this regard, the Military **Phreakers** (mostly Army and Marines) have more freedom than most citizens and honestly get the opportunity to see Australia. Many of these mutants, **frustrated** and angry about their limitations and status in the "real world" (the Cities), abuse their power outside their walls. Savage and brutal behavior against the "barbarians" (**Outbackers**), "savages" (Aboriginals) and "monsters" (everyone else), is encouraged by the Military leaders, and, rather than jeopardize valuable human lives, Phreakers are consistently given the most dangerous combat missions. This has made many Phreakers in the Armed Forces hardened combat veterans, with 20% in Perth and 33% in Melbourne as ruthless and bloodthirsty as any Roadganger or supernatural predator.

Ironically, many Phreakers show the same citified prejudices, fear and distrust that they suffer from City-Goers, to Outback Muties, automatically assuming they are hostile, dangerous savages or criminals of low intelligence. Consequently, Outback Muties are designated as high priority threats; extreme prejudice (deadly force) is recommended in **their** interrogation and pacification.

## Mutant R.C.C.S

It is interesting to note that whatever the cause of the mutation, only humans born in Australia (25% Aboriginal, 75% non-Aboriginal) are subject to its influence. Human mutants are physically deformed but blessed with psionic or magical enhancement, making them both less and more than human. It is *Mspower* that frightens ordinary people as much as the Phreakers' strange appearance . . . perhaps even more so.

Unfortunately, most mutants don't see themselves as blessed, but cursed. Many have come to see themselves as freaks and **monsters**. This is reinforced in the Tech-Cities where "Phreakers" are most common and where they are treated as contemptible and frightening **subhumans**.

Most have some measure of animal or bestial appearance or aspect, with 50% looking more animal than human. Most possess psionic abilities.

### Physical Deformity

Aborigines and most people regard many of the common deformities as animal-like, seeing aspects of the cat, dog, kangaroo, wombat, platypus, etc., in the appearance of these mutants. Pick one or make a random roll.

**01-05** Looks completely human; a rarity.

**06-08** Unusually tall (6 ft/1.8 m +3D6 inches) and thin. Has something of an insect or skeletal appearance, but has an otherwise human appearance.

**09-10** Narrow shouldered, barrel chested and hunchbacked, giving the character the appearance of a *Wallaby* or *Bettong*, especially when the animal stands on its hind legs. But otherwise has a human face and appearance.

**11-15** Fully formed Third arm and hand (+1 attack per melee round), but otherwise looks completely human. This extra appendage is typically located below one of the other arms.

**16-20 Animal Features: Multiple Animals.** One arm and hand and one leg is that of a different animal. 50-65% will also have one of the following: a tail, fur or scales, a third limb



that may be the same as one of the others or different, or a **face/head** that is animal-like or completely animal. A pair of wings is possible only if the G.M. allows it and "fly" is taken as a Special Ability.

**21-25 Animal Features: Serpent/Snake.** Half have thin or shrivelled arms and hands (-15% to all skills requiring the use of **one's** hands), the nose is small **and/or** flat, the head tends to be round and without pronounced facial features (thin lips, no sharp cheek or brow bones), and hair is half that of normal humans; many are partially or completely bald. Instead of legs, the character has a long (1D4+3 **ft**/1.2 to 2.1 **m**) serpentine body like that of a snake or worm; 50% have bodies that are covered in scales rather than human skin. Spd is 1D6+6 crawling or via psionics. The mutant has a natural A.R. of 10 and a natural prowl ability of 50% +4% per level of experience.

**26-30 Animal Features: Koala Bear.** Short (4-5 feet tall), pudgy, and hairy, with large fur covered ears and large flat nose giving this mutant a Koala Bear appearance. Half are covered in short grey and white fur and have short fingers with pointed fingernails. Both have a natural climbing ability equal to the climb skill with a +10% bonus; increases with experience like any skill.

**31-35 Animal Features: Platypus.** Barrel-chested, short neck, short legs (-4 on Spd attribute), small eyes, thick lips, and webbed fingers and toes. Half are covered in a waterproof fur, have small dark eyes, round head and platypus features, complete with a duckbill-like mouth (-3 to P.B.). Both have an affinity for water and a natural skill the same as the swim skill with a +10% bonus, plus the mutant is resistant to cold, can hold his breath for 1D4+3 minutes and can survive depths up to 300 feet (91 m) without any special breathing apparatus.

**36-45 Animal Features: Feline,** with almond shaped eyes (often various shades of green, blue, yellow or gold), striking hair on the head (often mane-like **and/or** streaked), small pointed ears, and small canines, but otherwise looks reasonably human.

Half have more prominent feline features, including a fur covered body, tail, cat-like muzzle, pointed feline teeth and retractable claws (2D6 damage +P.S. bonus if any) — +1D4 to P.S. and P.P., and has the equivalent of a natural acrobatics skill.

Approximately 33% of both types are unnaturally beautiful (+8 to P.B.), and slender, delicate-looking; often belying excellent physical endurance and strength or speed (+1D4+1 to any *one* physical attribute other than P.B.).

**46-55 Animal Features: Canine,** with warm brown or hazel eyes, large ears (often pointed), striking hair on the head (often mane-like or bushy, **and/or** streaked), large canine teeth, and often have a dog or wolf-like muzzle.

Half have more prominent canine features, including a fur covered body, tail, dog-like muzzle and canine teeth and keen sense of smell — +1D4 to P.S., +1D6+2 to **Spd.**, and can identify and track odors/scents at 40% +5% per level of experience.

Approximately 33% of both types are unnaturally charismatic and likeable (+8 to **M.A.**) and +1D4+2 can be added to any *one* physical attribute.

**56-65 Animal Features: Bat.** Australia has one of the greatest number and variety of bats in the world! The character has a leathery membrane under each arm, long pointed fingers, prominent pointed ears, pointed teeth and dark eyes.

Half have a very bat-like face with muzzle and canine teeth, large pointed ears, small dark eyes, clawed fingers and toes, and a large membrane under the arms. Legs function but are noticeably shorter than normal (about half the size), and the character is bowlegged, so he waddles when he walks (-2 from speed attribute, but has keen hearing equal to bionic *Amplified Hearing & Ultra-Ear* on page 231 of the **Rifts® RPG**, making him +1 to parry, +2 to dodge and +3 on initiative).

**66-75 Animal Features: Kangaroo or Wallaby.** Narrow shoulders and slender upper body, but the hips are wide, legs beefy and powerful, the feet large (+1D6 to speed attribute and can leap 6 **ft**/1.8 m high and 10 **ft**/3 m across). Approximately half have the exact legs and feet, shape and function of the animal, as well as large pointed ears and a somewhat pronounced, muzzle-like appearance to the mouth (+1D6+6 to speed and can leap 10 **ft**/3 m high and 15 **ft**/4.6 m across; increase by 20% with a running start).

**76-80 Animal Features: Lizard.** Rough scaly **skin**, little body hair even on the top of the head (usually a light color), thick neck with loose skin, and small nose. Approximately 50% have no hair, lizard-like shape and features, a tail and scale covered body (natural A.R. 12 and +2D6 to S.D.C.). Both have a natural affinity for climbing and are +10% on that skill. 20% resemble a crocodile with thick lumpy skin (natural A.R. 13 and +2D6+6 to S.D.C.).

**81-85 Animal Features: Bandicoot or Bilbie.** Both animals resemble a hedgehog but with hair and a short mouse-like tail rather than spines. The mutant is short (four and half to five **feet**/1.35 to 1.5 m tall), has a large, narrow nose (often pointed), small dark eyes, round ears and large feet. Approximately one third look just like a giant version of the animal with longer, stronger, human-like arms and hands! Both have natural **nightvision** (600 **feet**/183 m) and +1D4 to speed.

**86-90 Animal Features: Tasmanian Devil** (rare). A carnivorous marsupial that North Americans might think resembles a thin badger or small, short-haired bear cub. The mutant has a stocky build, thick neck, black hair, large nose, muzzle-like mouth, canine teeth and a short but robust stature (5-5 **ft**, 6 **inches**/1.5 to 1.65 m). 25% are covered in black fur and have prominent animal features, including a bushy tail. Both have **nightvision** (300 **feet**/91.5 m) and are +1D4 to P.S. and Spd.

**91-95 Animal Features: Thylacine** (rare). The **Thylacine** is a predatory marsupial sometimes called the "marsupial wolf" — **resembling** a short furred wolf with a long narrow tail, and tiger-striped on its rear half starting behind the shoulders. It was believed to be extinct but has reappeared with the Coming of the Rifts and the rebirth of the Dreamtime. This mutant always looks like a humanoid version of the animal with fur, tail, muzzle and canine teeth (+2D6 to Spd, +2 to P.S.).

**96-00 Animal Feature: Echidna** (rare). An Echidna resembles a Hedgehog with long thick quills like a porcupine and a tiny round head and long, beak-like snout. Half of these mutants have a small round head with a long pointed nose and hair that naturally feathers into spikes. The other half look just like a giant version of the animal with longer, stronger, human-like arms and hands, and a head and back covered in long, thick quills! Natural A.R. of 14 and can't be grabbed or wrestled without his opponent getting stabbed by 1D4+1 quills (each does 1D6 S.D.C.; **M.D.** if the mutant is an M.D. being).

**Note:** If the G.M. would like, he or she can substitute other animals for those above, but any powers or bonuses should be minor and minimal.

## Special Mutant Powers

**Note:** Most (not all) mutants avoid the use of bionics because it interferes with their powers. Ordinary folk don't want the mutants to use bionics because they feel the mutants' "unique appearance" helps to identify these potentially dangerous freaks.

Pick one of the following or make a random roll. See **Rifts® World Book 12: Psyscape™** for additional psionic powers and options. If the G.M. would like, he can add or substitute the various Psychic Character Classes from **Psyscape™**.

**01-05 Effectively a Mind Bleeder;** roll for that R.C.C.

**06-10 Effectively a Mind Melter;** roll for that R.C.C.

**11-20 Psi-Healer** who has all psionic Healing abilities +1D4 Sensitive or Physical powers.

**21-30 Psychic Prognosticator (also known as "Psike-Eyes" or just "Eyes").** This mutant has the powers of Clairvoyance, Commune with Spirits, See the Invisible, See Aura, Read Dimensional Portal, Remote Viewing, Object Read, Psychic Diagnosis, Detect Psionics, Mind Block and two Sensitive powers of choice. At 4th level the character gets the power of Mind Bolt, at 8th level Mind Bond, and at level 12, **Omni-Sight**. Considered a Master Psychic, although much more limited than a Mind Melter.

**31-40 Psychic Fighter (also known as a Zap-Sack).** This mutant possesses the powers of Intuitive Combat, Sixth Sense, either **Electrokinises** or **Pyrokinesis**, plus two offensive Super-Psionic powers of choice. In addition, the character can select two physical powers per level of experience starting at level two. Considered a Master Psychic, although much more limited than a Mind Melter. May be substituted with a **Burster** or **Zapper** from *Psyscape™*.

**41-50 Ectoplasmic Master (also known as an "Ecto-Freak").** This ability is especially common among **Phreakers** with no or diminished limbs, particularly arms or legs. In this case, the mutant has all ectoplasmic abilities (often used to create ectoplasmic arms, hands and legs) at double the usual duration and range, and 10% greater S.D.C., plus levitate and 1D4 abilities selected from the Physical and 1D4 from the Sensitive Psionic categories. Considered a Major psychic with a bonus of 4D6 I.S.P.

**51-55 Psychic Sensitive (also known as a "Feelie" or "Feeler").** Select two psionic sensitive powers every level of experience, plus the character makes two selections from the following: Empathic Transmission, Mentally Possess Others, Mind Bolt, Mind Block Auto-Defense, Radiate Horror Factor, **Telemechanic** Operation, or Psychic Omni-Sight. Considered a Master Psychic, although much more limited than a Mind Melter.

**56-60 TK-Master (also known as a "Mover").** Possesses all **Telekinetic** abilities from the physical category and the Super-Psionic powers of Psychic Body Field, Telekinesis (super) and Telekinetic Force Field. In addition, select two Physical psionic powers of choice. Considered a Master Psychic, although much more limited than a Mind Melter.

**61-80 Natural Spell Caster** with innate magical properties similar to Faerie Folk and other creatures of magic (*also known as a "Nate"*). Hit Points (only) count as M.D.C. making the

character a natural, light Mega-Damage being. Possesses 6D6 P.P.E. +P.E. attribute number and 2D6 P.P.E. per level of experience. A Nate can instinctively use magic items, heal self at ley lines same as the Ley Line Walker's Ley Line Rejuvenation power (doubles healing), is +2 to save vs spell magic, +3 to save vs Horror Factor and +4 to save vs possession.

Spell Casting. Knows one spell from common wizard spells selected from Spell Levels 1, 2, 3, 4, 5, and 6. Additionally, the Nate intuitively learns one additional spell per each subsequent level of experience equal to his own current level of experience.

**81-90 A character impervious to magic (also known as a "Magic Back Rounder").** Hit Points (only) count as M.D.C. making the character a natural, light Mega-Damage being. Magical charms, augmentation, control, sickness, curse, illusions or influence have absolutely no effect (nor do positive magic like healing, fly, invisibility, etc.). The character is also impervious to the effects of Ley Line Storms, and magical weapons and damaging spell attacks like fire ball and lightning bolt do only one tenth their normal **damage!**

**91-00 Mega-Damage Mutant (also known as "Tanker").** Has 4D4x10+P.E. attribute in natural M.D.C., plus gets another 2D6 M.D.C. per level of experience and P.S. is supernatural! M.D.C. recovers at a rate of 2D6 points per 24 hours.

## Additional Special Abilities

Pick one or make a random roll.

**01-10 Naturally Smart:** +1D4+4 to I.Q.

**11-20 Naturally Quick & Alert:** +2 to initiative, +1 attack per melee round.

**21-30 Supernatural Strength:** +1D4 P.S.

**31-40 Minor M.D.C. creature:** Turn Hit Points (only) into physical M.D. and can add +2 to any one attribute.

**41-50 Major M.D.C. creature:** Turn Hit Points (only) +1D4x10 into physical M.D.

**51-55 Impervious to disease and poisons,** while modern drugs and magic potions are half as effective.

**56-60 Natural at hiding:** Equal to a Blend skill of 78%+2% per level of experience, plus Camouflage at 70%+2% per level of experience, and Escape Artist at 50%+2% per level of experience.

**61-65 Natural Swimmer:** Has swim skill at 80%+2% per level of experience, plus can hold breath for 1D4x10 minutes, withstand depths of up to 500 feet (152 m), and swims at twice the speed as normal without fatigue for the first four hours.

**66-70 Natural Climber:** Has the equivalent of the Acrobatics and Climbing skills at +20%.

**71-80 Natural Runner:** +22 to speed and the character can run at maximum speed for 30 minutes per level of experience without fatigue. +1 to P.S. and P.E. attributes too.

**81-85 Impervious to fire,** even M.D. and magical fire.

**86-90 Energy Expulsion** — blasts that are fired from the eyes or hand and do 1D6 M.D. +2 M.D. per level of experience. Range is 200 feet (61 m) +40 feet (12.2 m) per level of experience.

**91-00 Has wings or webbed membranes** like a bat and *can fly* at a speed of 20 mph (32 km), double if began as a bat (or bird?) to begin with.

## Outback Mutie R.C.C.

**Also known as** Outbacker Mutant or just mutant — **Phreaker** is a term reserved for evil mutants and City-Mutants.

**Alignment:** Any

**Attribute Requirements:** None, just has to be a mutant.

**Common Outback Skills:**

Speaks Australian at **80%+2D4%** (most are illiterate)

Two Domestic skills of choice (+10%).

Land Navigation (+10%)

Law (+10%)

Lore: Two of Choice (+10%).

Horsemanship: **General/Standard** or Pilot Automobile, Truck or Motorcycle (+10%; pick one).

General Athletics

W.P. Energy Rifle

W.P. Three of choice (any).

Hand to Hand: Basic to start, but can be changed to hand to hand: expert at a cost of one O.C.C. Related Skill, or to Martial Arts (or Assassin, if evil) for the cost of two skills.

**O.C.C. Related Skills:** Select six additional skills at level one, three additional at level two and one additional at levels 3, 6, 9, and 12. New skills start at the first level of proficiency.

Communication: Any (+5%), except Laser

Cowboy: None

Domestic: Any (+10%)

Electrical: Basic only.

Espionage: None

Mechanical: Basic and Automotive only.

Medical: First Aid only (+5%).

Military: Any

Physical: Any except Gymnastics and Acrobatics.

Pilot: Any (+10%), except Robot Elite, Power Armor and military vehicles.

Pilot Related: Any

Rogue: Any (+2%).

Science: Any

Technical: Any (+10%).

W.P.: Any

Wilderness: Any (+5%)

**Secondary Skills:** Also select two Secondary Skills from the previous list at levels 1, 3, 6, 8, and 11. They are limited as above, and do not receive any of the bonuses listed in parentheses. These are additional areas of knowledge and start at the first level of proficiency.

**Standard Equipment:** The character starts with a basic set of travelling clothes, a set of fancy "Sunday clothes," a suit of light to medium M.D.C. homemade armor, an S.D.C. side-arm, one weapon for each W.P., 1D4 ammo clips, a billy, canteen and a large water skin, sunglasses or tinted goggles, utility belt, backpack or saddle-bags, **bedroll/sleeping bag**, 1D4 old style books of matches, and cigarette lighter. In the **Outback**, nothing can be taken for granted, not even items like soap, comb, flashlight or lantern, aspirin, candy, and so forth. Such things will have to be purchased with starting funds.

**Mode of Transportation:** None to start.

**Money:** The character starts with **1D6x\$100** in tradeable goods and **2D6x\$100** in dollars, which may be necessary to spend on additional starting items and equipment.

**Cybernetics:** None, avoids them as unnatural.



## Phreaker Military Grunt R.C.C.

**Alignment:** Any, but tend to lean toward selfish and evil. Most are reasonably loyal to their city, but so ruthless and vicious to outsiders they are likely to seem evil even if the alignment is not.

**Attribute Requirements:** None, other than being a mutant willing to defend their City.

**Typical Skills:**

Speaks English at **86%+3D4%**

Literacy (+15%)

Basic Math (+10%)

Military Etiquette (+10%)

Radio: Basic (+10%)

Pilot: Jet Pack or Hovercycle (+15%)

Pilot: Automobile or Hovercraft (+10%)

Read Sensory Equipment (+10%)

Body Building  
 Climbing (+5%)  
 General Athletics  
 W.P. Energy Pistol  
 W.P. Energy Rifle  
 W.P. Heavy Weapons  
 W.P. of choice (any)  
 Hand to Hand: Expert to start, but can be upgraded to Martial Arts at the cost of one O.C.C. Related skill.

**O.C.C. Related Skills:** Select four Military Skills and five other skills at level one. Select two additional skills at levels 3, 7, 11 and 15. New skills start at the first level of proficiency.

Communication: Any (+5%)  
 Cowboy: None  
 Domestic: Any  
 Electrical: Basic only.  
 Espionage: None  
 Mechanical: Automotive and Basic only.  
 Medical: First Aid only.  
 Military: Any (+15%)  
 Physical: Any, except Acrobatics.  
 Pilot: Any  
 Pilot Related: Any  
 Rogue: None  
 Science: Astronomy and Math only (+10%).  
 Technical: Any (+10%)

W.P.: Any  
 Wilderness: Outback survival, Carpentry, Hunting and Land Navigation only.

**Secondary Skills:** Also select four Secondary Skills from the previous list. They are limited by the categories listed, but do not receive any of the bonuses listed in parentheses. These are additional areas of knowledge and start at the first level of proficiency.

**Standard Equipment:** Standard issue equipment includes a set of combat fatigues, boots, jacket, uniform, dress uniform, full brimmed hat, baseball cap, Trencher military body armor, web belt, holster, small first aid kit, 5 mile (8 km) range radio communicator, five days rations in a small pouch, bedroll, backpack, survival knife, entrenching tool, canteen, air filter and gas mask, utility belt, 3 signal flares, four grenades of choice and tinted goggles/sunglasses for the harsh glare of the Australian sun. One weapon for each W.P. and six re-loads.

**Money:** Monthly salary is \$1500 +\$100 per level of experience, plus military room and board, paid medical treatment, and access to military facilities. Starts with 1D6x\$1000 in personal savings.

Living quarters is a dorm at the city barracks, shared with between 8-16 other soldiers, depending upon rank. Officers get their own small apartment. The dorm is air conditioned, and has full TV/video features as well as light entertainment/sports facilities. The base has its own entertainment complex with film theaters, arcades, gyms, Olympic sized swimming pool, target practice range, combat simulation stations and more.

**Cybernetics:** None, avoid them as unnatural.

# Optional Player Races

## Alien R.C.C.S

Kwarla  
 Mokoloi  
 Shadow People

## Kwarla R.C.C.

### Optional Player Character R.C.C.

Well, let me tell you 'bout the Koala people. I was a few miles inland from the northern coastline ... just in from Fraser Island, and was lookin' for somethin' to eat out in the bush. Never realized that there were others out there lookin' for the same thing, only I was the somethin' they was lookin' for as their next meal. I've never gone huntin' alone since. And the reason I'm still alive? The Kwarla was there. Yep, they came to me aid.

This creature was twenty feet high, more fang than it could fit in its head ... and it had tentacles, and, jeez ... sorry ... still sends shivers up me spine just thinkin' of it. Anyway, so there I was with nuttin' but me .22 in me hand, and here's this thing that wanted to eat me alive, when five, seven ... no, nearly a dozen of these fur covered creature-men came swinging out of the trees, shrieking and growling so loud the demon couldn't be heard. They poured over the damn thing, tearin' chunks out of it with their bare hands. One of 'em was eaten by it, swallowed whole, and a couple got hurt real bad, but it was only a couple of minutes before the monster was on the ground, a bleedin' mass that started to melt away the moment its last breath was gone. Torn from its body by them Kwarla claws.

As you can imagine, the koala-men were a fierce sight, drippin' blood from their claws, some of em carryin' weapons. I was frozen solid. I thought I'd been saved from one beast to be eaten by another. But they just ignored me, 'cept for one that nodded at me, almost social like.

An' then they just disappeared. Carried away their injured and melted into the trees. Never will I forget that afternoon. I ran back to me boat and pushed off to sea.

*To this day I thank those little blighters. I'd been fodder without 'em. Sometimes I get to wonderin' if that's true of all of us. How many monsters would still be alive an' eatin' us if it wasn't for those Kwarlas?*

— John Wilder, fisherman and small game hunter, tells of his first encounter with the mysterious Kwarla.

Aboriginal lore explains the appearance of this race better than any other explanation can. To the Australian natives, every animal is represented by a spirit (the great Emu or the Crocodile for example), referred to as a "presence" more than an entity or spirit. When the world was reawakened by the magical energy that rose with the Coming of the Rifts, the Kwarla were one of many new (or are they old?) races to come to Earth. According to the Aborigines, it was because the peaceful Koala spirit took



one of the human tribes and gave unto them his strengths and wisdom to make the new race. The Great Koala transformed them into protectors of life in the harsh new world. Koala himself is sleepy, slow and lazy, yet fierce when angered. In fact, Koala was *so lazy*, he gave all his anger to this new race so he could continue to relax in his tree. At least, this is what the Aboriginal myths of Rifts Australia have to say.

So this is what the **Kwarla** are: peaceful people, yet based on the understanding that they must fight to survive and to protect the wilds, making them nature's guardians. They are a primitive, tree dwelling **humanoid** race, short yet very hardy and suited to their role as *Demon Hunters* and protectors of wild places. Their hatred of supernatural evil and any other maliciously destructive force runs very deep. While they appear to be a new race on Earth, they have a very deep cultural base, coming from their Aboriginal roots. They, too, believe that their spontaneous appearance in northeast Australia is as a result of the Koala taking the powers of the Dreaming to make a tribe into his own warriors. Since that time, over a century ago, they have spread over all the humid and forested areas of the country — from Queensland, along the east coast to Victoria, and west into the Northland.

They are short, usually around four feet (1.2 m) tall, but enormously heavy marsupials. Muscle mass and not a small touch of magic makes them incredibly heavy-set, with powerful muscles and quick reflexes. They are covered in a short, luxurious fur, varying from light gray through dark silver to a reddish brown. They have large, fur-covered ears swept back from their temples with a large black nose and a small muzzle. They also sport a set of black claws from their hands, which are not retractable. Even so, they manage to maintain respectable manual dexterity, such as for sewing hides and sorting gathered foods. They could be mistaken for very large Koalas if not for their upright stance, body markings, weapons and intelligent faces.

Kwarla live in huts made from mud and sticks that adhere like beehives to the tallest, sturdiest trees they can find within a given area of woods. They even fashion ladders and swings that create a sort of suspended village within the forest canopies. If their terrain will not support such housings, then they will build **similar** constructions around the roots of trees and in the lee of natural mounds at ground level. They do not burrow.

The Kwarla also have a variety of weapons. They like to use spears, clubs, and axes made of the bones and teeth of animals and monsters. They also employ boomerangs, and the more northern societies even use the bow and arrow. Most notable is their affinity for Millennium Trees, and they employ many weapons built from their timbers. The Tree itself is regarded as a great ally, and a force of nature and goodness.

Weapons aside, their technology level is quite low. They can make rudimentary pots, clothing and pouches, but machinery is still beyond them. They know about guns, robots and helicopters, having seen them operate, but to them, machines like these are just another type of demon, only worse because they have the destructive minds of men behind them. They have the intelligence to work metals for knife blades and tools, but rarely do so, preferring wood and bone as a basic substance for all their tools and weapons. Australia has a lot of hard timbers, and the **Kwarla's** magic makes them the equivalent of Mega-Damage weapons.

Your typical Kwarla is a curious individual. He can make a very solid friend if one can win his respect by thinking as he does or behaving with courage under fire. However, if one demonstrates too many qualities that remind him of his prime enemies — demons and destructive technology — he will simply abandon the individual, and if the character seems out of control, he is likely to return with his fellow warriors to do battle. He is a friend of the **Earth**, a destroyer of supernatural evil and defender of the good and innocent regardless of a person's race or appearance. He will be the most dependable, reliable companion an adventurer could ever hope to find.

When it comes to **demonkind** and foul creatures of magic, there is very little room for compromise or indecision. Everything is black and white when it comes to such creatures. Ask him a question about the world around him, and he will spout impassioned prose about how the world must be freed of parasites if it is to be allowed to **regrow** into a thing of beauty. After the Apocalypse, Earth has been given a second chance, and as the Kwarla see it, it must not be squandered.

As player characters, Kwarla make interesting explorers, heroic champions and wandering demon hunters. They are a very tribal culture, and see wisdom in the strength of numbers. Fighting alone is brave, but often unwise. The honor of individual combat and triumph must come second to the welfare of others and the destruction of supernatural evil. This means they are excellent *team players* and usually happy to join forces with other demon battlers. A Kwarla may separate from his tribe and travel alone to find other heroes to complete a worthy quest or help others realize their potential as heroes. There are even a few rogue **Kwarlas** that are "civilized," and have taken to the Outbackers' way of life in houses with guns and vehicles. Such Kwarla are usually anarchists who would receive nothing but disdain by their fellow nature-lovers, maybe even hatred from others of their kind. Even some Aborigines would bow **their** heads in sorrow at the thought of a Kwarla that has lost his place in the world. Yet while they may have lost their place and a bit of their identity, few lose their calling, and will leap in the face of **supernatural** evil, weapon in hand and grim determination burning in their eyes.

It is perhaps interesting to note that to a Kwarla, lies and deception are very foreign (and evil) concepts indeed. Simply put, they don't see the point in it. Things just ARE. Why disguise the fact or truth? Consequently, they are usually brutally frank and honest ("Yes, the hat is very **colorful**, but it makes you look like a **clown**," and so on). They are not very subtle in anything they say or do. As mysterious as their appearance and existence is, they are very matter-of-fact and direct about how they go about their daily business. Guile and deception are alien to them. Thus, while humans might sneak into a town to search for the lair of a demon lord and ambush him, the Kwarla, as fond as they are of ambush and other combat tactics, are just as likely to march and demand the demon show himself so that they might destroy him. That having been said, Kwarla are masters of the ambush. They like to hide in sturdy trees and either dead-drop or swing down onto their opponents, pinning them and then using their claws.

### **Kwarla Demon Hunter R.C.C.**

**NPC or Optional Player Character**

**Pronounced:** Cuh wahr lah

**Alignment:** Any, but tend towards Principled, Scrupulous or Unprincipled, and occasionally Aberrant.

**Attributes:** I.Q. 2D6+1, M.E. **2D6+10**, M.A. 3D6+2, P.S. 3D6+12, P.P. 2D6+10, P.E. 2D6+12, P.B. 1D6+8, Spd 3D6+6. Supernatural P.S. and P.E.

**Mega-Damage Creatures:** Kwarla are creatures of magic, and minor Mega-Damage creatures with physical M.D.C. equal to their P.E. attribute number, **+1D6** M.D.C. per level of experience. Also see Natural Abilities.

**Horror Factor:** Applicable only to evil supernatural beings and evil sorcerers: 8 for an individual, 11 for a group of 3 or more.

**Size:** 3 feet plus 3D6 inches (0.9 to 1.37 m) tall.

**Weight:** 220 +6D6 pounds (110.3 to 121.5 kg) of muscle and fur.

**Average Life Span:** 60+2D6 years.

P.P.E.: 4D6+22

**Natural Abilities:** **Nightvision** (see up to 200 **feet/61 m** at night), good hearing in general; can leap 8 feet (2.4 m) high and 12 feet (3.6 m) across, climb 95/85%, swim 60%, prowl 50%, and heal at a rate of 2D4 M.D.C. per 24 hours (double with complete **rest/no** physical activity, or through meditation for 24 hours). The Kwarla are natural enemies of the **undead** and are immune to the slow bite of vampires and their mind control, and to other types of mind control, like those of demons or other supernatural predators. They are still affected by spell magic cast by more mundane races, like humans and elves. Instinctively they hunt and kill supernatural evil.

Increase M.D.C. (special): At the expense of **5 P.P.E.**, the Kwarla can triple their M.D.C.! When they do so, they appear to grow slightly in size, but this is a presence more than a physical enlargement. They will also take on a slightly greenish hue that flickers around them like a magical aura. The M.D.C. gained from this action (takes one **attack/action** to initiate) lasts until the extra M.D.C. is depleted or 20 minutes per level of experience has passed, whichever comes first. After this time the aura fades and the Kwarla is left with whatever natural M.D.C. he had to start with.

**Natural Weapons** (special): The Kwarla have razor sharp claws that do +1D6 M.D. added to their usual supernatural strength damage. Oh, a Kwarla bite does 2D6 **S.D.C./Hit** Points damage.

*Claws of Vengeance!* They also have a special power which they call upon to fight Supernatural foes and other creatures of magic. They call this their "Vengeance." Whenever faced with a magical or supernatural foe, they can magically (by spending one P.P.E. point) extend **their** claws into blades as long as short swords and crackling with energy. One swipe with these vengeful claws does 4D6 M.D. added to the M.D. normally inflicted by their supernatural strength (average P.S. is 21-25 and does 2D6 M.D. on a normal punch). Does Hit Point damage to vampires and **were-creatures**, and double damage to alien intelligences and their avatars/essence fragments. The Claws of Vengeance can also be used against magical armor and to parry magical weapons. However, they do normal, small claw damage when up against mortals clad in M.D.C. body armor or when up against cyborgs, **bots** and such (normal claw damage is 1D6 M.D. +**supernatural** P.S. damage).

**R.C.C. Skills:** Males are either Demon Hunters (and hunters in general) or Mystics (the latter is a separate **Kwarla** R.C.C. entirely, and described next). **Demon Hunters:** Hand to Hand: Expert, Boxing, W.P. Blunt, W.P. Axe, W.P. two ancient of choice, plus Lore: Demons and Monsters (+25%), Lore: **Dreamtime** Culture (+20%), Detect Ambush (+10%), Intelligence (+5%), Track (**humanoids** & the supernatural; +15%), Dance (+10%), Speak Aboriginal (+30%), Speak English (+10%), Outback Survival (+30%), and all other Wilderness skills (+15% each) except Use Songlines and Roadwise. Also see Natural Abilities.

**Providers:** All females are Providers, although in the Northland there is said to be a tribe with a female Mystic. As their name implies, they are caretakers for their tribes, particularly the young. They sometimes hunt, but are mostly involved in the gathering and preparation of food, teaching and caring for the young and collecting tools and raw materials needed by the group/village. The Providers are the backbone of any Kwarla tribe and help to hold it together as a unit. They also raise the young until they are old enough to be trained either as Warriors, or to be taken under **their** mother's wing and taught to be Providers.

Skills include, Lore: Demons and Monsters (+20%), Lore: Dreamtime Culture (+15%), Lore: one of choice (+15%), Escape Artist (+10%), Dance (+15%), Sing (+15%), and Cook, Fishing, Identify Plants & Fruits, Preserve Food, Skin and Prepare Animal Hides, Land Navigation, Camouflage and Outback Survival, all at +20%. They can also speak Aboriginal (+30%), and Speak English (+10%), and know Basic Math (+20%), General Repair & Maintenance (+15%), Hand to Hand: Basic, and one ancient W.P. of choice.

**Damage:** As per claws and supernatural P.S.; bite does 2D6 S.D.C. damage, or by weapon.

**R.C.C. Bonuses:** +3 on initiative, +1 to dodge, +3 to pull punch, +3 to saves vs toxins and ingested poisons, +7 to save vs possession, +5 to save vs Horror Factor and +1 to save vs Ritual Magic.

**Magic:** No special abilities unless a Kwarla Mystic.

**Psionics:** Kwarla are minor psionics. Males can select 1D4 Physical **psi-powers**, Females 1D4+1 Psychic Sensitive or Healing powers. **I.S.P.** is M.E. attribute number +1D6 per level of experience. Females get an extra one time bonus of +2D6 I.S.P.

**Enemies and Allies:** They like and fare well with other Tribal people, but disagree with most white humans and D-bees who are often destructive toward nature and cold to **nonhuman** life forms. They will, however, associate with the Bushman, rugged Jackaroos and at least tolerate (often befriend) human and D-bee heroes who battle the supernatural and fight for all people.

**Habitat:** They tend towards heavy forest areas, rainforests and thick **bushlands**.

**Value:** None per se, although some demons, Necromancers, dark practitioners of magic and other evil beings wear their hides and skulls as clothes or decorations.

**Notes:** Kwarla are very instinctive creatures, just a step or two up from animals. They are omnivorous and when they do eat meat they rarely cook it. Kwarla prefer vegetable matter, especially eucalyptus leaves. Also, despite their savage nature and basic instincts, they are a peaceful and nature loving

race. Aboriginals believe the Koala made them to protect the **wild**, and the Kwarla seem to live up to that purpose.

**Rogue Kwarla R.C.C.:** If the G.M. allows a player to assume the role of a "civilized" Kwarla character, he will be the same as above except that the skill bonuses noted previously are half and the character can select one piloting skill (typically Horsemanship), three technical skills (no bonuses) and one Modern W.P. (any).

## Kwarla Mystic R.C.C.

By Ben Lucas & Kevin Siembieda

Mystics are the leaders of Kwarla society. While a Demon Hunter or even Provider may be a chief, the Mystic is the true power that manages the tribe and supports its spirituality. Every tribe has one elder Mystic (8th level or higher) with perhaps one Mystic as heir apparent and loyal friend and assistant, plus 1D4 young mystics (1st-3rd level Mystic preparing to leave the tribe). Kwarla Mystics, even young ones, are revered and respected like the medicine men of other tribes around the world, and the elder/tribal leader is often carried on sedan chairs and pampered day and night. **Kwarlas** and even some brave Aboriginals will come to him for advice, cures and stories. Forever calm and peaceful, the Mystic takes in all around him and does what he can to help his "children".

Once every eight years, the Mystic will choose a newborn Kwarla through a small ritual of divination and observe its journey to its mother's pouch (remember, Kwarla are marsupials). This in itself is a somber ritual in which the whole tribe will gather outside the mother's hut and wait for the news. Based on the actions of the small, bald baby as it makes its way into the pouch, the Mystic will decide if the child is another wise **man/Mystic**. The Mystic himself holds the secret as to what determines the spark of magic and enlightenment within a child, and passes it on to his possible successor. No one has yet discovered what it is that makes one Kwarla so special that he is born with the power of psychic and mystic insight. Even the mother is left unawares. When it is old enough to emerge, the Mystic will then take the child as his own - something the mother will be very proud of - and train the infant until it reaches adolescence. At that point, the young Mystic must go forth into a dangerous world to grow in first-hand experience and knowledge.

### Powers of the Kwarla Mystic

**1. Magical Understanding.** The Kwarla Mystic is not a trained man of magic, but well versed in how it works and interacts.

**2. Psionic Powers:** At level one, the Kwarla Mystic automatically has the powers of Mind Block, Exorcism, and **Meditation**, plus he also gets to select three powers from the Sensitive or Healing category *or* one from the Super Psionic Category. Also select two from either the Sensitive or Healing category (note that this is the psychic's only chance to take Healings).

**Additional psionic abilities:** The character gets to select a total of two additional psionic powers from the Sensitive **and/or** Healing Categories (i.e. one healing and one sensitive or two healing or two sensitive powers) at levels 2, 4, 6, 8, 10, 12 and 14; and one Super Psionic Power at levels 3, 6, 9 and 12.





3. **I.S.P.:** To determine the character's amount of Inner Strength Points, take the number of M.E. as the base, roll  $2D4 \times 10$ , and add it to the base number. The character gets another 10 I.S.P. for each level of experience, starting at level one. Considered to be a Master Psionic.

4. **Magic Powers:** The Kwarla Mystic spends years pondering the mysteries of life, and wandering the continent (sometimes the world) to find his place in it, and how magic might help him make it a better place. When he is ready to find or make his place by exploring the world as an adventurer, the character enters into a meditative trance that lasts three days. At the end of that period, the character intuitively knows how to cast some specific spells necessary for assisting the warriors, fighting the Supernatural and protecting the tribe. Most spells will reflect combating the supernatural and nature.

At first level, the Kwarla Mystic can cast *Globe of Daylight*, *Cleanse*, *Negate Mechanics*, *Power Weapon*, *Speed Weapon*, and *Ironwood* (most of which are described in **Rifts® Federation of Magic**), plus select a total of *six* spells from common Wizard magic levels one and two. These are part of the Mystic's permanent spell casting abilities and cannot be changed. Nor can the character learn new spells like a Line Walker, because his magic abilities must come from meditation and cosmic awareness.

**Additional Magic:** The Kwarla Mystic will intuitively sense whenever he or she has reached a new metaphysical plateau (new level of experience). At each new junction in life (experience level), the character will find time to meditate on life, his

goals and magic. As a result, he can select a total of two new magic spells from any level up to one beyond his own level of experience (i.e. a fourth level Mystic can select his spells from levels 1-5). Spell selections can be made from Wizard spells found in the *Rifts® RPG* and *Federation of Magic™*, or from Aboriginal Magic (described in the future *Dreamtime* world book).

5. **P.P.E.:** A die roll of  $1D6 \times 10 + P.E.$  attribute number to determine the character's initial base P.P.E. Add another 2D6 points to the P.P.E. for each level of experience. The Mystic can also draw on ambient P.P.E. from **Songlines/ley** lines the same as the Line Walker or any sorcerer, but Kwarla will not use blood sacrifices for any reason. Also see the Use Songlines skill.

6. **R.C.C. & Mystic Bonuses:** As a master psionic, the Kwarla Mystic needs to roll a 10 or higher to save versus psionic attack (plus any M.E. attribute bonuses). +4 to save vs mind controlling **drugs**, potions, and magic charms, +2 to save vs Ritual magic, +8 to save vs possession, and +5 to save vs Horror Factor.

7. **Divination.** The Kwarla Mystic is a Diviner — a medium to the spirits. He can ask them questions about the future and they will answer as best they can. As an N.P.C., the G.M. has freedom to be cryptic with the statements such a character will **make**, but as a player character, the mechanics are simple. Once per moon cycle (once per month), the Kwarla Mystic performs a small ritual in which he chants and sings all night and paints on a small strip of earth, a flat area of rock or a tree. When the sun rises, the answers (more often insight, hints, clues and omens) will "dawn" in his mind. The player may ask the G.M. one broad (no specifics please) question per level of the character's experience. These questions are usually on behalf of the tribe or others who come to him for advice and help. The G.M. should answer the questions as vaguely as possible, but giving hints as to the possible future or outcome. Example: When asked if a raid into a certain area of land is a good idea, the G.M. may have it planned that the area in question is a powerful place of good magic, but is held by an evil and lawless Outbacker settlement with lots of weapons. In which case he would answer to the player something like, "great risk brings great reward." You get the idea. Enjoy.

8. **Affinity with Millennium Entities.** The Kwarla Mystic can recognize and talk with the Millennium Trees and other Millennium Beings (like the Great Reef), and in his dreams he walks with these nature spirits and visits the Reef. As such, he will always be in their favor. Characters can start with one or two selections of magical Millennium Tree items if the G.M. agrees to it.

### Young Kwarla Mystics as an Optional Player Character R.C.C.

**Player Note:** Young Kwarla Mystics go out into the world alone to learn about its secrets, truths and horrors so that they may one day become a wise tribal leader. Although they may start their journey alone (i.e. without the company of other Kwarla or others), they often join groups of adventurers to learn about them and other people as they travel. Sadly, 50-65% of all young Kwarla Mystics do not survive their sojourn and perish in the wilderness battling evil. Player characters start at level one.

**Alignment:** Any, but tend towards **Principled**, **Scrupulous** or **Unprincipled**, and occasionally **Aberrant** and **Anarchist**.

**Attribute Modification:** +1D4+2 to I.Q., **M.A.**, **M.E.** and **P.E.**; the child is *chosen* and possesses special powers and abilities. Like all *Mystics*, the character possesses both magical and psychic powers.

**Mega-Damage Creatures:** **Kwarla** are creatures of magic and minor Mega-Damage creatures with physical **M.D.C.** equal to their **P.E.** attribute number, +1D6 **M.D.C.** per level of experience. Also see **Natural Abilities**.

**Horror Factor:** Applicable only to evil supernatural beings and evil sorcerers: 8 for an individual, 11 for a group of 3 or more.

**Size:** 3 feet plus 3D6 inches (0.9 to 1.37 m) tall.

**Weight:** 200 +5D6 pounds (98 to 112kg) of muscle and fur.

**Average Life Span:** 32+3D6 years (mainly because they go out in the world to find their way and battle evil alone or in small groups of **non-Kwarla**); those who live past 40 are likely to live for an additional 1D6x10 years as a revered **Mystic Elder**.

**P.P.E.:** 4D6+22

**Natural Abilities: O.C.C. Skills:**

Speaks **Kwarla** & **Aboriginal** at **80+3D6%**

Speaks **English/Australian** (+20%)

Basic Math (+12%)

Outback Survival (+20%)

Blend (+20%)

Lore: **Demon** & **Monsters** (+30%)

Lore: **Dreamtime** Culture (+30%)

Lore: Two of choice (+20%)

Holistic Medicine (+15%)

Animal Husbandry (+15%)

Use **Songlines** (+20%)

**Corroboree** (+20%)

Sing (+20%)

Identify **Plants** & **Fruits** (+15%)

Preserve **Food** (+15%)

Cook (+15%)

**W.P.** Blunt

**W.P.** one ancient of choice

**Hand to Hand:** Basic only, no other can be selected.

**O.C.C. Related Skills:** The **Mystic** also gets to select six other skills at level one, plus one additional skill at levels 2, 5, 10 and 15.

**Communication:** None

**Cowboy:** None

**Domestic:** Any (+15%)

**Electrical:** None

**Espionage:** Detect **Ambush**, Detect **Concealment**, **Escape Artist** and **Intelligence** only (+5%).

**Mechanical:** None

**Medical:** **Holistic** and **Pathology** only (+15%).

**Military:** None

**Physical:** Any except **Acrobatics**, **Boxing**, **Wrestling** and **Hand to Hand: Skills**

**Pilot:** None

**Pilot Related:** None

**Rogue:** None

**Science:** Any (+5%)

**Technical:** Any except **Computers**, **Photography** and others that use modern equipment.

**W.P.:** Any ancient.

**Wilderness:** Any (+15%)

**Secondary Skills:** The character can also select three secondary skills from those listed above. These are additional areas of knowledge that do not get the bonuses listed in **parentheses**, and start at base level.

**Natural Abilities & Bonuses:** The same as any **Kwarla**, as described previously, plus the magical and psionic powers of the **Kwarla Mystic**.

**Starting Equipment:** An animal hide cloak or poncho, beaded necklace, water skin, small sack, large sack and wooden staff. Any **Millennium** magic items are at the **G.M.**'s discretion.

## The Mokoloi

### Reptile Men of the Northlands

#### NPC Villain & Optional Player R.C.C.

By Ben Lucas & Kevin Siembieda

In the swampy Northlands, a new race has emerged within the last few decades of post Apocalyptic Australia. Their first appearance was discovered by an Aboriginal explorer who was quenching his wanderlust along the northern coastline among the lowlands and rivers of the area. He reported back to his tribe that he saw "crocodiles who were men," and who used powerful machine magic and whose strength and ferocity were beyond compare. At first, this was thought to be a blessing. Many assumed that the **Mokoloi** were like the **Kwarla**, created as guardians or advisors. **Corroborees** were held across the Northern Rim and the message was sent along the **Songlines** for all to hear. However, the wiser elders had reservations about this myth, and doubted that the crocodile spirit would be kind enough to create a race of guardians. Unfortunately, the elders were correct and the initial report was indeed false. The truth of the matter is quite different, but only the **Mokoloi** themselves know the entire truth and purpose behind their race.

While the **Mokoloi** have many similarities to the **Tautons** and even the **Crocodilians** of **Rifts Africa**, they are actually a reclusive race of aliens who have been attracted to Australia because of its sudden increase in magical energy.

Their story begins on a small, swamp-covered planet hundreds of light years from Earth. This planet was quite young, and the **Mokoloi** were the dominant species. Their high intelligence led to the development of technology far in advance of anything else on their world. They had machines, robots and even computers. They also experimented with magic and produced many powerful sorcerers. Their cities were swamp domes with high, glittering spires and magnificent temples that were built in honor of their planet, which they worshiped as a god in and of itself.

This story also has an end. Something in the core of the planet went geologically haywire. The planet started to heat up at an accelerated rate and life started to dry up and die. Over mere centuries, the planet began to turn into a desert. The technology of the **Mokoloi**, which functioned mainly around the properties of water, started to fail. As this disaster continued, they discarded their technology and turned from a civilized species into a race of savages and practitioners of magic struggling



to survive their darkest age. The Mokoloi thought that their mother planet was angry with them and sought to destroy them for some wrong they had committed. Mass suicides and religious wars compounded the tragedy of this dark age.

Fortune alone preserved the Mokoloi. In a remote part of the home world a scientific institute had been working on cryogenic technology. As years passed and the project was abandoned, the facility was **buried**, literally, as the world changed. Centuries later, a lone mage-priest who had not lost her religion discovered this facility, quite by accident, and saw it as a final blessing before all life on the world died, for it contained 3,000 slumbering Mokoloi locked in suspended animation. It was, she decided, the last chance to **preserve** the Mokoloi as a species. And so the mage-priest used the magical stone pyramid that was part of the building, and two others nearby to cast a powerful magic ritual so draining that it destroyed her. But as she died, she saw the effort of her magic take form — a dimensional rift opened and the entire facility slid through it. Transported to another, hopefully safer, place where the species could continue, free of their worlds turbulence.

And so, with Rifts Earth being something of a nexus point itself, connected to countless other worlds, the dimensional portal opened in the deserted Northlands of Rifts Australia, in roughly 66 P.A., and deposited its sleeping voyagers in the lush, warm swamps. The cryogenic machines, triggered by the magical transport and power fluctuations, began to thaw their precious cargo. The instant they woke, it was apparent that something was wrong. The sky was blue, rather than the light green they were used to. The surrounding animals were very strange indeed, and the atmosphere was much thinner than they were used to. Some of the older survivors had to use respirators to live on. But the point **is**, they *did* survive and made a new beginning in the alien world they were thrust into.

Not knowing how they came to this new world, many believed that their god world has sent them here to prove themselves and give them a second chance in building their empire.

There are perhaps fifteen thousand or more Mokoloi living in the woodlands of Australia. Most show no sign of wishing to spread their boundaries and are content to claim the woodlands of the Northlands. In the early years they dispatched scouts out into the world. The ones that went south found nothing but deserts. The ones that made boats and tried to push north never returned (another thousand, mostly malcontents and bold explorers, have travelled to Southeast Asia and Indonesia where they explore and try to establish independent settlements). So now the Mokoloi are content to live as they are. They have two cities in the Northland, and have slowly managed to rebuild a fair amount of **their** technology from what resources they managed to salvage, and manufacture and process from the new environment. The remains of their **cryo-storage** building is now a holy site, and a temple has been built on the wreckage.

Today, the vast majority of the Mokoloi were born on Rifts Earth. The only knowledge these young Mokoloi have of their homeworld is what they have been told by the elder survivors, and they know only what transpired before they were placed in suspended animation. What fate may have befallen their beloved planet and the rest of their race is a mystery. Nor do they know with certainty how long they slept; at least a century, perhaps longer. All are familiar with the stories about the heat wave and

ensuing war and chaos that was spreading over the old world before they went into **cryo-sleep**. This has left a sadness over the entire race, as they are effectively a homeless species, torn from their world during a time of madness. Even so, their religion still revolves around the worship of their homeworld. Astronomers among their kind are still trying to find out where in the night sky **their** world might be (if **visible** at all). Different temple sects have been set up, and they dispute how and why they have come to Rifts Earth. Most believe they are “**the** chosen ones,” sent to this alien world by their god for some unclear purpose. Some believe this new land is a paradise and their reward for being loyal to their god. Other believe it is a test — a world to be conquered and tamed, and upon succeeding, they will be brought back home. Others believe the alien planet (Earth) is the child of **their** elder god and as such, the Mokoloi's birthright, a new homeland to explore, conquer and hold. Still others look at the ley lines and dimensional portals to other worlds, and have decided it is their **god's** will that they travel the Megaverse to explore (and conquer?) many worlds. The debates rage on.

By human standards, the Mokoloi appear to be **frightening** monsters. They are **humanoid** in build and shape, but the similarity to humans ends there. They are clearly reptilians with pale to dark green skin, prominent ridges along the spine from the top of the neck to the end of the tail. They resemble crocodiles with thick, round muzzles and small round eyes on the sides of their elongated heads. They have many rows of sharp teeth and **their** thumbs and toes are clawed. In **their** culture these are tools, not weapons. While they are capable of biting, and to humans, may look like they want to at any minute, they never do except in self-defense. Their eyes have a dark reptilian pupil, but coloration of the iris can vary from turquoise to purple. The Mokoloi walk with a bend in their stance, giving them a hunched appearance, despite their strong and powerful build. Their heavy and broad upper body is counterbalanced by a thick tail that extends to about mid-calf.

Mokoloi dress in loose clothing and prefer to travel light. Apart from the various sarongs and ponchos that are their common dress, they have also developed more advanced clothing for different occasions, including cloaks, capes, jump suits, wet suits, plated and form-fitting body armor, and even power armor. They favor colors that match their surroundings, which are almost always dark and light greens with browns, yellows and blues mixed in. While they develop some striking and beautiful patterns in their designs, they almost always camouflage well. A Perth anthropology team that once spied and reported on the Mokoloi returned with data that their data-banks compared to the **Aztec** culture of ancient Central America, complete with stone and mud brick buildings and stone pyramids.

The diet of the Mokoloi is quite exotic and they take great pleasure in what they eat. Outwardly, they would appear to be strict carnivores. A dental examination, however, would reveal that **their** inner and back rows of teeth are flat, as they are omnivorous. They do like meat and fish, which they cook many different ways. In fact, meat or fish is always their main course, and is supplemented with vegetables and water plants. Insects, birds, certain roots, fruits, nuts and other plants are considered delicacies. While it has taken some time to adjust to an Australian bush tucker menu, the Mokoloi are adept at assembling a feast from their surroundings.

Much of the Mokoloi's history has been lost, and their society is built upon the old ways and beliefs remembered by the original survivors. One prevailing belief is that they should not rely on technology as much as magic — a supposed fact that is evident by their god placing them on a world so rich with magic. Thus, while they understand technology and incorporate it into their magic, what little history that was salvaged as data from the wreckage of their arrival has been transcribed onto stone tablets and kept at sacred sites. Now much of their culture and history is passed by word of mouth and in stories through generations. In fact, the Mokoloi of Rifts Australia are a very young culture in this sense, because they have been, over the past few decades, developing a new society.

They rule themselves via an oligarchy. That is, they have a ruling body that makes all the decisions via a vote. This ruling body is supplemented by military advisers and other, smaller councils who meet separately and pass their views, suggestions and decisions onto each other. The only way to join these councils is by birth or by invitation of a majority of the council itself. As such, their society is well organized, and they have a well-assembled security force that deals with both military and domestic defense; a police and army in one. Most disputes are settled by combat or by some other form of challenge such as wrestling, a race or a hunt. They love competition, and thrive on it in every aspect of their life.

Most interesting is that the Mokoloi are matriarchal. Females are the dominant sex, though not by a large margin. There is more or less equality among their kind, but the women hold a slightly higher level of power and represent 75% of the ruling body and leaders in every walk of life.

There is no marriage; Mokoloi simply set aside a time in their life, usually about mid-life, and they find what they call their "life partner," with whom they raise young until they become adults. At that point, the parents then separate and go on to find a more substantial position and purpose in society. For females that is usually management or instruction. For males it often involves exploration and defense/military activity.

Old and sick Mokoloi who become a burden on others will leave their kind and wander into the wild to die. Likewise, those who are cursed, deformed or lame are expected to leave and never come back. The Mokoloi believe that only the strong should survive, and to live as a burden on others is to live in shame.

The cities of the Mokoloi are very unique. They find hills, outcroppings and sturdy areas in or near swamp lands to found their central buildings, built in stone. These buildings are then interconnected by bridges, boardwalks and canals. The Mokoloi's architecture is generally very open and very much a part of the landscape, with trees growing through rooms and vines winding around pillars and covering walls. The Mokoloi build low houses, and their government and holy buildings are pyramids with chambers inside and on the peaks and summits.

Generally, these crocodile people keep contact with other races to a minimum and hold **non-Mokoloi** in low esteem, especially mammals. The most common way for a Mokoloi to make a friend outside his own kind is if a favor is owed. They will befriend anyone they owe a debt to, until the debt is repaid. Some Aborigines have even made **friends** of the Mokoloi this way, and have been very surprised when their new friend will just up

and leave one day because a favor or debt has been repaid. The Mokoloi tend to be supremacists with all others seen as inferior, submissive or potential enemies to be destroyed.

The truth is they are quite insecure and uncertain about their future or the exact course they should take. However, they hide this weakness and treat invaders and potential threats with extreme prejudice and little mercy. They defend their new homeland with savage ferocity and magic.

A typical Mokoloi is quick tempered, aggressive and bold. Although they feel it is their destiny to dominate this land (Australia) and they wonder whether the entire planet should, **eventually**, be conquered and made their new homeworld, they are not as aggressive or militaristic as many human cultures and nations, and are more subtle and conservative than Perth, Melbourne and most Outback communities. They expand slowly as their numbers grow. They do, however, see the mammals that call themselves "humans" as a future obstacle and the armies of the two Tech-Cities as very real and current enemies. Several unpleasant encounters and armed skirmishes over the last 20 years with City scouting parties and **Outland** raiders have convinced the Mokoloi of the danger represented by the "human mammalians." To compound matters, the Mokoloi think they have found a potential ally among the **Horune** Pirates of the Pacific.

### **Mokoloi R.C.C.**

**Also know as** Crocodile Men or Man-Croc.

**Alignment:** Any; but 20% are Aberrant.

**Attributes:** I.Q. 2D6+6, M.E. **2D6+6**, M.A. 2D6+8, P.S. 4D6+8, P.P. 2D6+6, P.E. 3D6+6, P.B. 2D6, Spd 5D6, quadruple when swimming underwater. Strength and P.E. are supernatural. P.P.E.: 6D6; more if a practitioner of magic.

**Mega-Damage:** Mokoloi are Mega-Damage creatures in the magic-rich environment of Rifts Earth. P.E. attribute number plus a roll of 2D4x10 M.D.C. This increases by 2D6 M.D.C. per level of experience (on S.D.C. worlds the Mokoloi have Hit Points equal to their P.E. number x5 +2D6 H.P. per level of experience and **1D6x10+25** S.D.C.).

**Horror Factor:** 12

**Size:** 6-7 feet (1.8 to 2.1 m) tall standing erect, but are actually 12-15 feet (3.6 to 4.6 m) long when laying prone or swimming (includes the tail which is 5-6 feet all by itself).

**Weight:** 250 +6D10 **lb** (115 to 139.5 kg).

**Average Life Span:** 45 years, but some have lived as long as 70.

**Natural Abilities:** **Nightvision** (see up to 200 **feet/61** m in the dark), can also see in dark, murky water, and into the infrared and ultraviolet spectrum of light and has otherwise excellent eyesight in the air and underwater. Good range of hearing, equal to that of a human, and is sensitive to vibrations in the water around them. They can tell if anything weighing more than 10 pounds (4.5 kg) is moving along the surface within a 300 foot (91.5 m) radius, provided they are in the water themselves. They can even pin point the place of entry and estimate the direction and speed of movement (Base skill: 60% +3% per level of experience). Swimming is a natural instinct. They can hold their breath for a number of minutes equal to their current Mega-Damage total (damage will reduce this time), and can survive depths of up to 600 feet (**183** m). Bio-regenerate 2D6 Mega-Damage per hour. Lost limbs

(fingers, hands, arms, tails, etc.) will regenerate completely within 3D4+4 months.

**Natural Weapons:** The bite of the Mokoloi, though rarely used except in self-defense, can be quite devastating, inflicting 5D6 **S.D.C./H.P.** from a nip or 1D6+2 M.D. with a full strength bite.

A claw swipe does the supernatural P.S. damage from a punch +2D6 M.D. Regardless of supernatural strength, a Mokoloi character can always choose to deliver a tail strike, kick or claw swipe that inflicts a minimum of 2D6 M.D. (supernatural P.S. damage can be withheld from such a swat).

**Mokoloi Martial Arts:** Exclusive to males only; females are equal to Hand to Hand: Expert. The combat bonuses and moves are the same as standard Martial Arts, plus the following bonuses and damage adjustments as follows:

**Bonuses:** +2 on initiative, +3 to pull punch, +1 attack with tail, +1 melee attack underwater, +2 to dodge underwater.

**Damage Adjustments** from Mokoloi Martial Arts:

Restrained Punch: 4D6 S.D.C.

Full Strength Punch: 2D6 M.D. +supernatural P.S. damage; counts as two attacks.

Claw Strike (a piercing Karate-like stab with the fingers): 4D6 M.D. +supernatural P.S. damage, but counts as two attacks.

Power Punch: Double the usual supernatural P.S. damage.

Restrained Kick: 4D6 S.D.C.

Full Strength Karate-Style Kick: 4D6 M.D. +supernatural P.S. damage; counts as two attacks.

Body **Block/Tackle:** 1D4 M.D.

Head Butt: 1D4 M.D.

Tail Slap: 2D6 M.D.

Tail Strike: 3D6 M.D. +supernatural P.S. damage.

**Crush/Squeeze** (requires a grapple): 3D6 direct to Hit Points for every round that the victim is trapped, or 1D6 M.D. if a Mega-Damage creature.

**Roll-over attack:** Any Mokoloi with any Hand to Hand Combat skill may perform a special move called the roll-over. It is a technique based on the drowning attack of the common crocodile, whereby the creature drags a victim underwater and spins over in horizontal rolls to drown, confuse and shock its next meal.

The Mokoloi have developed a combat maneuver inspired by this move. After they have grappled an opponent, they can throw themselves to the ground and simply roll over and over. This inflicts normal **crush/squeeze** damage (see above) three times per melee round until the opponent escapes. Also, the opponent is so disoriented that he is -2 on all combat moves (strike, parry, etc.), and automatically loses initiative and all attacks until an escape is achieved. To escape, the character must roll a 17 or higher; the escape move counts as two melee actions.

**Vulnerabilities:** The Mokoloi are very sensitive to dry heat.

They must be completely immersed in water at least once every other day, or they will start to dry up, suffering a -2 to dodge, parry and initiative and losing one point of their M.D.C. every day until they can immerse themselves once more.

**Bonuses:** Males are +3 to save vs Horror Factor; females are +4.

**Psionics:** Standard; same as humans, see page 12 of the **Rifts® RPG.**

**Skills of Note:** All Mokoloi speak **their** own language at 98%, and can swim with 98% proficiency (an automatic instinct available at the moment of birth). Most also speak one or two languages common to Australia (+15%).

**Available O.C.C.s:** The Mokoloi have many roles within their society, but most females are the leaders, organizers, scholars, sages and practitioners of magic. Females can select to be a **Techno-Wizard**, Stone Master, Ley Line Walker or attempt to learn any practice of magic, *except* the Shifter, Warlock, Witch and Druid, or any that require the worship of, or union with, a supernatural being. Their own variety of the **Techno-Wizard**, *Stone Master* and *Ley Line Walker/Wizard* are most common. They can also be the equivalent of a scholar, theologian, **doctor/healer**, and builder.

Males are generally limited to Ley Line Walker, preferring to enjoy the role of warrior, but do not have access to **Juicer**, 'Borg or MOM technology. They lean towards *Wilderness Scout*, *Headhunter* (using existing technology or TW augmentation), *Military Specialist*, *Commando/Special Forces*, *Grunt/Warrior*, *Bandit*, *Roadganger*, *Bounty Hunter*, and *Power Armor Pilot* (an elite warrior, again using Mokoloi Techno-Wizard constructions). They may also become one of the Australian Outback O.C.C.s, most commonly the *Bushman* and *Songjuicer*.

Other common occupations found among the Mokoloi include the equivalent of Rogue Scholars (most are a cross between scholar, historian, theologian and priest), **Body Fixer/Doctor/Healer**, and Operator. The G.M. may have to adjust the O.C.C. skills and starting equipment for some of these classes when using them in the Australian setting and for these *alien* beings and their unique (twisted) view of the world.

**Enemies and Allies:** The Mokoloi are still unsure about who to trust and who to ally with. They have good feelings towards the **Horune** and some bands of mutants — **nonmammals** preferred.

The Aboriginal Tribes are worrisome because of their strong connection to this world, which on one hand is very familiar, similar to their own link with the old Mokoloi world. On the other hand, these spiritual and magical people are likely to oppose an invader who conquers their lands, making them a dangerous opponent (perhaps the most dangerous of the continent's inhabitants).

They regard most of the intelligent "mammals," from wandering human or D-Bee vagabonds and Outbackers to practitioners of magic, and especially the City-Goers, as a dangerous and cunning species who must ultimately be pacified and either enslaved or made second-class subjects, or be destroyed. Mokoloi consider themselves to be superior over intelligent mammals, and most agree that their planet god has sent them to tame this alien world and make it their own.

They have never previously encountered the supernatural, and regard them as their natural enemies, particularly vampires and demons.

At this point, the only group that can be considered as fledgling allies are the Horune Pirates, another race of displaced, non-mammalian people. Currently, they are involved in limited trade with the Horune, exchanging information, and a handful of Mokoloi have even joined them as pirates to get a better look at the world around them. For the Horune,

the swamps of the Northland have become a safe **port**, because the Mokoloi don't acknowledge the rights of any other community or nation, and will fight any invaders or armed forces who invade their territory.

**Habitat:** They build their cities in swampy wetlands; so far, mainly in the Northland.

**Important Note:** Approximately 45% of the population is female, 55% male (with a slightly higher rate of mortality). Mature females (age 19+) can lay a clutch of 1D4+2 eggs once every 12 months. The eggs hatch in 90+2D6 days. Young males reach physical maturity by age 12, females by age 14, but do not reach child bearing years until 19. At the current, deliberately high rate of birth (60% of mature females giving birth every 18-20 months), the Mokoloi population will explode from roughly 15,000 to 60,000 over the next ten years and increase geometrically every **decade!** Even factoring in some serious losses through natural death and armed conflict, they should increase in number by at least 60,000-100,000 every 6-8 years! This would make the Mokoloi the worst outside influence to enter the Australian ecology since the **Caine Toad**. And, needless to say, threatening any hope Australian humans, **City-Goers**, **Outbackers** and others, of rebuilding **their** homeland and reestablishing human civilization.

## Mokoloi Technology & Equipment

The Mokoloi of Rifts Earth have, like the majority of the human population, lost most of their old technology, but use an alien form of **Techno-Wizardry** combining magic and machines and making M.D.C. weapons and armor, as well as a form of Stone Magic to build and control their environment. They also use human technology, weapons, equipment, vehicles, etc., acquired through scavenging, piracy, raids, and those won through combat (i.e. taking items from the corpse of the vanquished).

The Mokoloi females (approximately 12-15% of the overall female population) also hold the secrets of *Stone Magic* used to build their pyramids and other stone structures, as well as to control and use ley line energy (see **Rifts® World Book Two: Atlantis** for full details about Stone Magic). Approximately 5% of the males, and another 10% of the females also wield *Ley Line Walker* wizard magic. The average level of most Mokoloi mages is, thankfully, only 1D4+2, with only one in a hundred being higher level (1D6+3; rarely higher).

The Mokoloi will *never* share **their** secrets of magic with any other race, not even allies, no matter what. Consequently, they will never teach other beings their knowledge of **Techno-Wizardry**, Stone Magic or any other mystic art or alien technology they may have developed. This includes the **Horune Pirates** with whom they have established an uneasy and tentative diplomatic relationship (it's a bit too soon to call it an alliance, although things seem to be heading in that direction).

## Weapons

### Arl Wrl Kim, "Constrictor" Web Gun

This is an assault rifle or **sub-machinegun** styled weapon with an oversized barrel and large muzzle that can fire Magic Nets! Mokoloi use these weapons to subdue or capture **opponents**, as well as for hunting on dry land.

### Creation Stats:

Initial P.P.E. Cost: 55

Spells Needed: Energy Bolt (5), energy field (10) and Magic Net (7).

Physical Requirements: A sub-machinegun body styling with a **gattling-like** barrel (eight barrels in all), and a clear or white crystal worth 300 credits/dollars or more, mounted into a cylinder mounted on the top, similar to a scope. Takes about 70 hours **of work** to build.

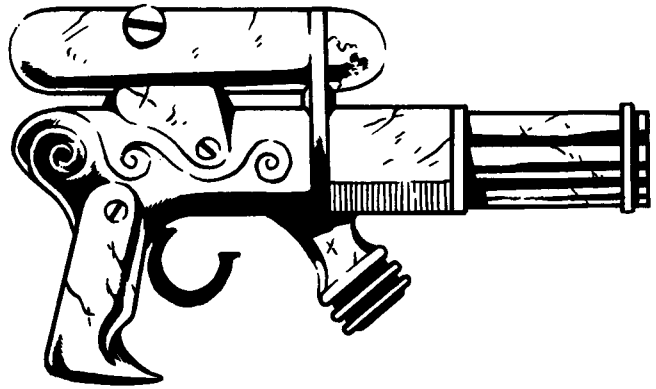

### Weapon Stats:

Weight: Typically 15 to 20 lbs (6.7 to 9 kg).

Damage: The nets are nearly unbreakable and equal to a Magic Net created by a 5th level spell. See the **Rifts® RPG**, page 173.

Rate of Fire: Each shot counts as one melee action.

Range: 300 feet (91 m).

Payload: Up to eight Magic Nets. Costs 7 P.P.E., per each net, to reload.

Bonuses: +2 to strike, as the net splays out when fired to entangle the opponent.

Cost: Exclusive to the Mokoloi. If one was to become available outside the Mokoloi culture, no Australian would know how it works or how to magically reload it, and therefore consider it to be worthless to anybody other than the Mokoloi. 48,000+ credits in North America where **TW** magic was developed (fundamentally the same as a New West® Snare Gun with slightly better range).

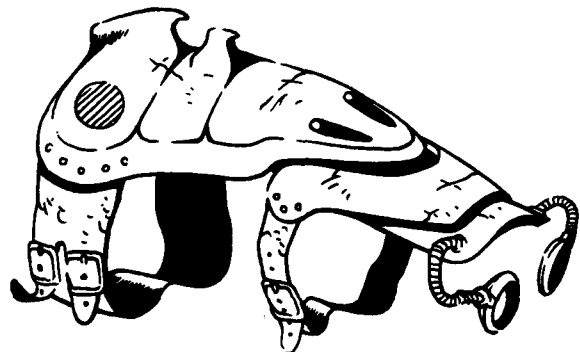

### Mok Karkra "Knuckle Dusters"

This is a firearm mounted on the back of the hand and strapped around the wrist. Upon a flex of the hand and a mental command, it can either fire three energy bolts or create three, long, magical M.D. lightblades.

### Creation Stats:

Initial P.P.E. Cost: 120

Spells Needed: Globe of Daylight (2), Energy Field (10), Energy Bolt (5), and **Lightblade** (20).

Physical Requirements: The **hand/wrist** apparatus and three small diamonds worth at least 1000 credits/dollars or more each. Takes about 110 hours of work to build.

**Weapon Stats:**

Weight: 1 lb (0.45 kg)

Damage: Instantaneous Triple Energy Blast: 3D6 S.D.C. or 3D6 M.D., similar to a laser.

Lightblades: 3D6 M.D.; used like a laser-claw or **Vibro-Blades** to slice and dice opponents at close range. They extend to three feet (0.9 m) long.

Rate of Fire: Each triple blast counts as one melee attack, while the **Lightblades** can be kept out and activated for up to three minutes (12 melee rounds) per each activation. Initial activation

counts as one melee **action/attack** and each use of the **Lightblades** to stab or slice counts as a melee attack.

Range: Blasts: 1200 feet (366 m).

Payload: 20 blasts or 30 minutes of use as the **Lightblades** (every 90 seconds the **Lightblades** use up one blast).

Bonuses: +1 to strike as a long-range weapon, +2 to strike in hand to hand combat.

Cost: Exclusive to the Mokoloi. If one was to become available outside the Mokoloi culture, no Australian would know how it works or how to magically reload it, and therefore consider it to be worthless to anybody other than the Mokoloi. 150,000+ credits in North America where TW magic was developed!

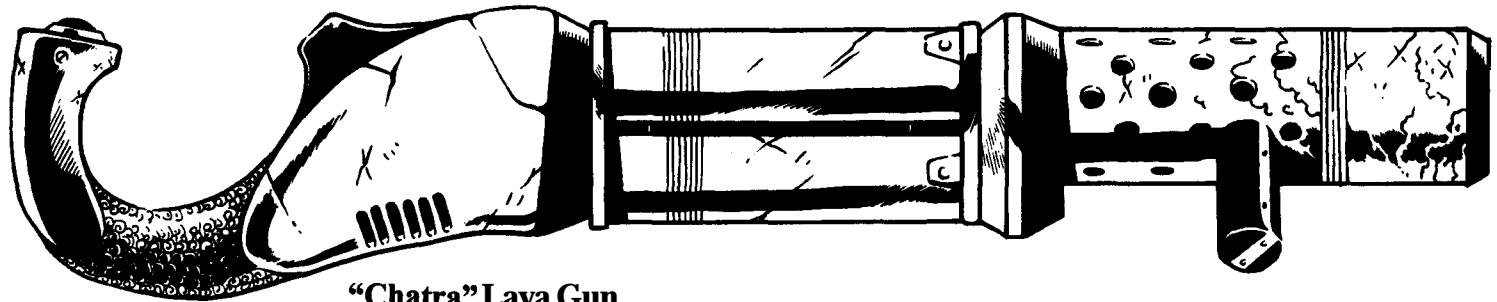

**"Chatra" Lava Gun**

This TW weapon is the standard weapon of all Mokoloi troops and security forces. It has a low range for a rifle-like weapon, but the designers never intended it to be used for very long-range combat. It fires a ball or sphere of burning "goop" that can be hurled with tremendous force. The advantage of this is that it will injure anything it strikes, regardless of what it is. A supernatural P.S. of 13 (or 20+ conventional P.S.) is required to use this weapon, as it is heavy for its size. To fire it one-handed requires a supernatural P.S. of 18 or greater (26 conventional P.S.).

**Creation Stats:**

Initial P.P.E. Cost: 98

Spells Needed: Telekinesis (8), Barrage (15), Energy Bolt (5), Energy Field (10), and some unknown quantity/element known only to Mokoloi **Techno-Wizards** (requiring 30 P.P.E.; Create Lava perhaps?).

Physical Requirements: A large, long barrel made from iron or steel and a yellow quartz worth 60 credits/dollars or more. Takes about 60 hours of work to build.

**Weapon Stats:**

Weight: 160lb (72 kg)

Mega-Damage: Each shot inflicts 4D6 M.D. to the main target and 1D4 M.D. from burning goop that is likely to *splatter* on everything within a five foot (1.5 m) radius of the main target (i.e. where it hits). Basically, a shotgun effect. The gun is also designed to be a two-handed parrying weapon and bludgeon (in the latter case, inflicting 1D6 M.D. +supernatural P.S. punch damage).

Rate of Fire: One at a time with each shot counting as one melee action (ideal for aimed shots), or short bursts of four burning blasts fired in rapid, nearly simultaneous succession which count as two melee attacks. Roll 1D4 to see how many gobs hit

the intended target. Those that miss hit nearby and may do additional, accumulative "splatter damage" to the intended target or those near-by.

Range: 1,000 feet (305 m).

Payload: 10 single goop balls can be contained in a premade "bulb" that can be loaded into the weapon like an ammo-clip, or can be magically created in the gun with the expenditure of 22 P.P.E. or 45 I.S.P. — a standard feature of most TW weapons is the ability to magically recharge or reload a weapon via magic energy.

Bonuses: +1 to strike when within 50 feet (15 m). No W.P. really applies other than W.P. Heavy Weapon (only Mokoloi males have this W.P.).

Cost: Exclusive to the Mokoloi. If one was to become available outside the Mokoloi culture, no Australian would know how it works or how to magically reload it because **Techno-Wizardry** doesn't exist there. A psychic or Mystic might get the general idea via object read, and can fire it until empty, but will lack enough clear knowledge to **reload/recharge** it himself nor enough to explain to a sorcerer how to pump P.P.E. into it. Consequently, they are considered to be worthless to anybody other than the Mokoloi. 90,000+ credits in North America where TW magic was developed.

## Maa Rohk Cra, "Warrior's Blade"

The weapon of choice among the Mokoloi males is the **Warrior's Blade**, an ancient, traditional weapon suitable for stabbing, cutting, and sawing. It is the most common of the **Techno-Wizard** devices as all males earn one in a rite of maturity through combat and female mages and leaders carry one as a sign of their status, as well as a **sidearm**. The magical weapon



inflicts Mega-Damage and can be thrown amazing distances, and returns after it is thrown (after a hit or a miss).

Creation Stats:

Initial P.P.E. Cost: 80

Spells Needed: Wind Rush (20), Energy field (10), Ricochet Strike and Power Weapon (35).

Physical Requirements: The blade is made entirely of silver (transformed into M.D.C. material) and six small diamonds worth at least 300 credits/dollars or more each. Takes about 80 hours of work to build.

Weapon Stats:

Weight: 15-20 lbs (6.7 to 9 kg).

Size: 3-4 feet (0.9 to 1.2 m) long.

Damage: 2D6+3 M.D.

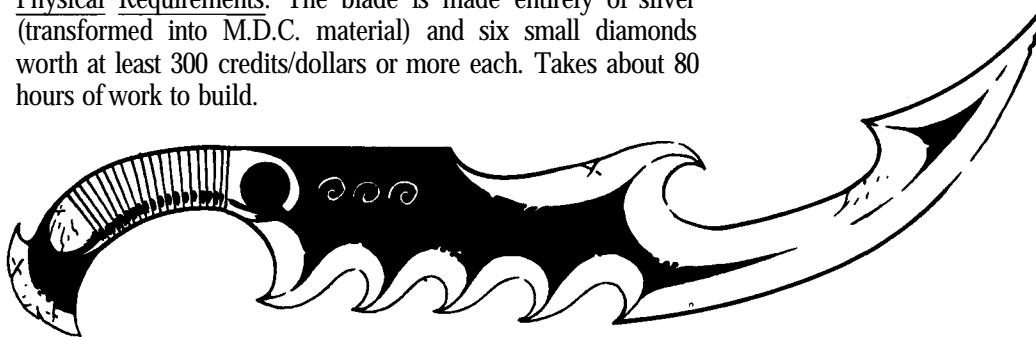

Special Feature:

- Can be thrown up to 600 feet (183 m)! Requires the target to be visible.
- Returns when thrown. The act of throwing counts as one melee **attack/action** and the act of returning counts as another.
- Nearly indestructible. The weapon has 300 M.D.C. and can only be damaged if attacks are specifically directed at the weapon, and then it takes half damage and distance attacks require the attacker to make a called shot at -4 to hit.

Bonuses: +1 to strike when thrown, +2 to strike and parry in hand to hand melee combat.

Cost: Exclusive to the Mokoloi, but a few have fallen into the hands of Outback O.C.C.s, usually won through combat, and are highly prized. Valued at 20,000-30,000 **credits/dollars**.

## **Explosives and Grenades**

The Mokoloi also employ many types of explosives. These are the same as those mentioned in the **Rifts® RPG** (page 204). The Mokoloi explosives use the same rules as the Coalition equipment, and are different only in physical styling and appearance. The Mokoloi may use Fragmentation Grenades, Plasma Grenades and Fusion Blocks only. What few hundred Mokoloi explosives they have were brought with them when they were Rifted to Australia. Any others are prizes won in combat against City-Goers and other humans.

---

## **Mokoloi Body Armor & Powered Armor**

---

### **"Snake Back" or "Wrap" Armor**

"Snake Back" or "Snake Skin" is the human term for this very peculiar Mokoloi **Techno-Wizard** creation. It incorporates a magical innovation developed by **their** species hundreds of years ago on **their** homeworld, and has since become a simple device for them to mass produce.

Simply, the armor comes in a metal tube **that**, when broken open, disgorges a thick fluid from one end. The tube collapses as the fluid is sprayed out until it empties down to a small, crumpled scrap of tin. Once in contact with a warm body (any



species will work), the fluid magically disperses to enwrap the entire body, even over jewelry, **wristwatches**, and so forth. The fluid sets within 1D4 melee rounds of being applied. The result is a semi-transparent, nearly invisible "**wrap**" that envelops and protects the body. Truly a second skin. The term "Snake Skin" comes from the fact that the Mokoloi are reptilian in appearance.

It is not a force field, but appears to be some sort of **ectoplasmic** covering, that offers M.D. protection without any mobility/encumbrance penalty, while at the same time, allowing the real skin underneath it to breathe and sweat through it (no protection against gas attacks or fumes). It is very flexible, even allowing the user to operate wrist-mounted computers and so on, **through** the wrap. The Snake Skin also magically disperses

heat and energy, thus energy blasts, magic blasts, and extreme heat do only half damage to the wearer, while the Snake Skin can withstand a total of 1D4x10+50 M.D.

When the Wrap Armor takes damage it begins to peel or flake off in layers, and is reminiscent of a snake shedding its old outer skin. To remove it sooner, the wearer just needs to find a loose edge (careful work with a sharp knife can create one), get a firm hold and tear. The entire armor can then be peeled away.

The only problem with the armor is the way it seals pouches and pockets shut, but this can be overcome by applying the armor before dressing.

**Creation Stats:**

Initial P.P.E. Cost: 28

Spells Needed: Energy field (10), Energy Disruption (12) and a mysterious Mokoloi incantation (15).

Physical Requirements: The canister, with the bottom covered in crystal dust. Cost to make, about \$3 credits/dollars. Takes about one hour to enchant, anybody can make the canister.

**Armor Stats:**

Weight: Unnoticeable.

Duration: 36 hours or until all M.D.C. is depleted, whichever comes first.

Mega-Damage Protection: 1D4x10+50 M.D.C.; results are inconsistent, but always fall within a range of 60-90 M.D.C. Once all the Mega-Damage has been depleted, the wrap loses integrity and quickly degrades, flaking off in hunks and then vanishing without a trace.

Mobility: Excellent! No penalty. Also **undetected** except by very close examination.

Cost: This M.D.C. suit in a can is coveted by *everybody* and can command a king's ransom in trade goods **and/or** cash! However, exactly how much one can get depends on the market. On average, a single can of "Snake Skin" will sell for \$30,000-40,000. Some unscrupulous and evil Merchant Traders and con-artists will demonstrate with a real can and sell or trade fake ones for \$20,000-30,000. However, such scoundrels can never show their faces again (unless they are incredibly smooth talkers and can offer some plausible excuse — like it must have been defective — **and/or** some sign of good faith, like offering money, goods, ammo or weapons for the person's "troubles").

Availability: Rare! Only the Mokoloi have the ability to manufacture Wrap Armor, and to them it is commonplace. A typical Mokoloi soldier will be equipped with 1D4 cans of "Snake Skin." **Wrap-Armor** has been a steady part of the Mokoloi warrior class for centuries. Now on Rifts Earth, some of the armor has even found its way across country to some lucky Outback communities and **Tribes**, either stolen or won in combat from the monsters. Another reason to raid and rob the Mokoloi?

## “Prey-Stalker”

### Combat Powered Armor Suit

This is the standard battle suit of the Mokoloi elite military troops. Like the weapons, it is another **Techno-Wizard** wonder that has become part of the Mokoloi military tradition. The suit does not enhance physical attributes so much as it provides heavy M.D.C. protection and an array of weapons enabling the Croc-men to wade into the thick of battle and pulverize their enemies.

Each arm houses a wicked M.D. blade that can flip forward for stabbing, cutting and parrying, like a sword; flip backwards as a forearm side blade or elbow blade for jabbing and slashing, or extend out, like a **fin** (“L” shaped from the hand and forearm), to slash, as the armored unit slices through the water like a tornado or when charging through enemy lines. The suit also covers the tail with flexible plates and ends in a retractable M.D. blade to make the tail an even nastier weapon than it already was. The back mounted weapon is a **TW** device that can either spit forth mini-fire balls like a plasma ejector or a stream of flame like a flame thrower. The eyes fire laser beams and the mouth spits lava. The right arm fires unleashes a Sonic Blast and the left forearm fires an Electric Arc (both the same as the spells of the same names). In addition, the armor enables the aquatic humanoid to withstand a depth of one mile (1.6 km), double his normal swimming speed, breathe underwater for two hours at a time (without any obvious air supply) and Levitate, Float in Air, and Repel Animals equal to 4th level spells of the same names. The latter three can be performed six times each per 24 hour period. Plus the armor regenerates M.D.C. at a rate of **2D6+6 per 24 hours**.

**Creation Stats:**

Initial P.P.E. Creation Cost: 325

Spells Needed: Constrain Being (20), Energy Field (10), Armor of **Ithan** (10), Invisible Armor (30), Power Weapon (35), Swim as a Fish (superior; 12), Breathe Without Air (5), Float in Air (5), **levitation** (5), Superhuman Speed (10), Superhuman Strength (10), Mend the Broken (10+), **Shockwave** (35), Fire Ball (10), Electric Arc (8), Fireblast (8), Globe of Daylight (2), See the Invisible (4), **Nightvision** (6), Sense Magic (4) and a number of secret incantations.

Physical Requirements: The mechanical components, armor plating, silver to plate the exterior blades and claws and mechanical parts, plus two large rose quartz crystals for eyes, a Tectonic Entity or energy sphere locked within the armor as part of its power source, and a number of secret components. Note that the tectonic entity inside the mechanical construct does not consider itself enslaved or abused and enjoys its life as part of the TW armor, and is allowed to (in effect) participate in combat. The various magical constructions also keep the entity controlled, obedient and focused in its job to power the armor. It takes about 960 to 1100 hours to build a single suit (about 4-8 months of construction; varies depending on the long hours put into it and the number of people working on its construction).

## Techno-Wizard Prey-Stalker Power Armor

**Crew:** One Mokoloi

**Purpose:** Assault, Anti-Personnel.

**M.D.C. by Location:**

Laser Eyes (2) — 20 each

Hands (2) — 80 each

Arms (2) — 120 each

Legs (2) — 160 each

Flame Gun (1; detachable from the back) — 50

M.D. Arm Blades (2) — 100 each

**M.D. Tail Blade (1) — 100**

\* Tail — 200

\*\* Head — 90

\*\*\* Main Body — 280 (regenerates 2D6+6 M.D.C. per 24 hours)

heat and energy, thus energy **blasts**, magic blasts, and extreme heat do only half damage to the wearer, while the Snake Skin can withstand a total of 1D4x10+50M.D.

When the Wrap Armor takes damage it begins to peel or flake off in layers, and is reminiscent of a snake shedding its old outer skin. To remove it sooner, the wearer just needs to find a loose edge (careful work with a sharp knife can create one), get a firm hold and tear. The entire armor can then be peeled away.

The only problem with the armor is the way it seals pouches and pockets shut, but this can be overcome by applying the armor before dressing.

**Creation Stats:**

Initial P.P.E. Cost: 28

Spells Needed: Energy field (10), Energy Disruption (12) and a mysterious Mokoloi incantation (15).

Physical Requirements: The canister, with the bottom covered in crystal dust. Cost to make, about \$3 credits/dollars. Takes about one hour to enchant, anybody can make the canister.

**Armor Stats:**

Weight: Unnoticeable.

Duration: 36 hours or until all M.D.C. is depleted, whichever comes first.

Mega-Damage Protection: 1D4x10+50 M.D.C.; results are inconsistent, but always fall within a range of 60-90 M.D.C. Once all the Mega-Damage has been depleted, the wrap loses integrity and quickly degrades, flaking off in hunks and then vanishing without a trace.

Mobility: Excellent! No penalty. Also **undetected** except by very close examination.

Cost: This M.D.C. suit in a can is coveted by *everybody* and can command a king's ransom in trade goods **and/or** cash! However, exactly how much one can get depends on the market. On average, a single can of "Snake Skin" will sell for \$30,000-40,000. Some unscrupulous and evil Merchant Traders and con-artists will demonstrate with a real can and sell or trade fake ones for \$20,000-30,000. However, such scoundrels can never show their faces again (unless they are incredibly smooth talkers and can offer some plausible excuse — like it must have been defective — **and/or** some sign of good faith, like offering money, goods, ammo or weapons for the person's "troubles").

Availability: Rare! Only the Mokoloi have the ability to manufacture Wrap Armor, and to them it is commonplace. A typical Mokoloi soldier will be equipped with 1D4 cans of "Snake Skin." **Wrap-Armor** has been a steady part of the Mokoloi warrior class for centuries. Now on Rifts Earth, some of the armor has even found its way across country to some lucky Outback communities and Tribes, either stolen or won in combat from the monsters. Another reason to raid and rob the Mokoloi?

## "Prey-Stalker"

### Combat Powered Armor Suit

This is the standard battle suit of the Mokoloi elite military troops. Like the weapons, it is another **Techno-Wizard** wonder that has become part of the Mokoloi military tradition. The suit does not enhance physical attributes so much as it provides heavy M.D.C. protection and an array of weapons enabling the Croc-men to wade into the thick of battle and pulverize their enemies.

Each arm houses a wicked M.D. blade that can flip forward for stabbing, cutting and parrying, like a sword; flip backwards as a forearm side blade or elbow blade for jabbing and slashing, or extend out, like a **fin** ("L" shaped from the hand and forearm), to slash, as the armored unit slices through the water like a tornado or when charging through enemy lines. The suit also covers the tail with flexible plates and ends in a retractable M.D. blade to make the tail an even nastier weapon than it already was. The back mounted weapon is a **TW** device that can either spit forth mini-fire balls like a plasma ejector or a stream of flame like a flame thrower. The eyes fire laser beams and the mouth spits lava. The right arm fires unleashes a Sonic Blast and the left forearm fires an Electric Arc (both the same as the spells of the same names). In **addition**, the armor enables the aquatic humanoid to withstand a depth of one mile (1.6 km), double his normal swimming speed, breathe underwater for two hours at a time (without any obvious air supply) and Levitate, Float in Air, and Repel Animals equal to 4th level spells of the same names. The latter three can be performed six times each per 24 hour period. Plus the armor regenerates M.D.C. at a rate of 2D6+6 per 24 hours.

**Creation Stats:**

Initial P.P.E. Creation Cost: 325

Spells Needed: Constrain Being (20), Energy Field (10), Armor of **Ithan** (10), Invisible Armor (30), Power Weapon (35), Swim as a Fish (superior; 12), Breathe Without Air (5), Float in Air (5), **levitation** (5), Superhuman Speed (10), Superhuman Strength (10), Mend the Broken (10+), **Shockwave** (35), Fire Ball (10), Electric Arc (8), Fireblast (8), Globe of Daylight (2), See the Invisible (4), **Nightvision** (6), Sense Magic (4) and a number of secret incantations.

Physical Requirements: The mechanical components, armor plating, silver to plate the exterior blades and claws and mechanical parts, plus two large rose quartz crystals for eyes, a Tectonic Entity or energy sphere locked within the armor as part of its power source, and a number of secret components. Note that the tectonic entity inside the mechanical construct does not consider itself enslaved or abused and enjoys its life as part of the TW armor, and is allowed to (in effect) participate in combat. The various magical constructions also keep the entity controlled, obedient and focused in its **job** to power the armor. It takes about 960 to 1100 hours to build a single suit (about 4-8 months of construction; varies depending on the long hours put into it and the number of people working on its construction).

### Techno-Wizard Prey-Stalker Power Armor

**Crew:** One Mokoloi

**Purpose:** Assault, Anti-Personnel.

**M.D.C. by Location:**

Laser Eyes (2) — 20 each

Hands (2) — 80 each

Arms (2) — 120 each

**Legs** (2) — 160 each

Flame Gun (1; detachable from the back) — 50

M.D. Arm Blades (2) — 100 each

**M.D. Tail Blade** (1) — 100

\* Tail — 200

\*\* Head — 90

\*\*\* Main Body — 280 (regenerates 2D6+6 M.D.C. per 24 hours)

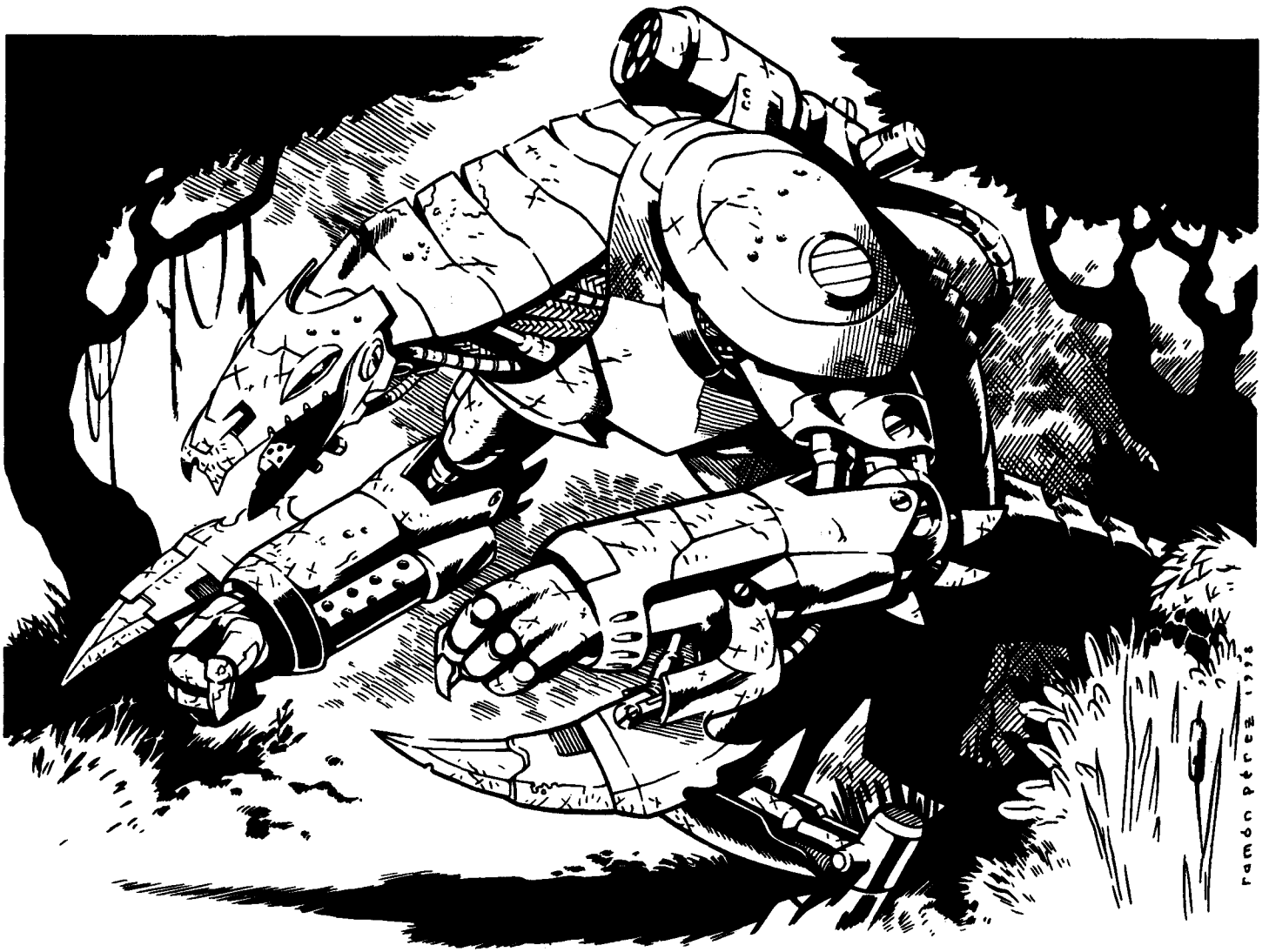

- People and animals (and objects) weighing less than 500 lbs (225 kg) are likely to be knocked off their feet and hurled 3D4 yards/meters; 01-88% likelihood. Only a percentile roll of 89 or higher will see them keep their balance without knockdown penalty, but they suffer full damage.
- Creatures and characters (supernatural beings, giants, dragons, cyborgs, robots, etc.) weighing 500-1000 lbs (225 to 450 kg) have a 01-50% chance of being knocked off their feet and hurled 1D4 yards/meters.
- Creatures and characters weighing up to one ton have only a 01-20% chance off being knocked off their feet and to the ground — knocked only a few feet back.
- Flying creatures and characters will be hurled through the air at twice the distance, but do not get knocked to the ground, although they still suffer the penalties from the impact of the shockwave and disorientation — G.M.s can also have them slammed into walls, trees, etc., for an additional 1D4 M.D.

*Knockdown penalties:* Those who fail to keep their balance are hurled through the air and knocked to the ground. There is a 01-40% chance of dropping anything they are holding, plus the character loses initiative and two melee attacks/actions. Only the spell caster and those touching him are unaffected by the shockwave. **Note:** Those with acrobatics, gymnastics or other skill abilities involving "balance" are +10% to save. A character who

makes a successful roll with fall or impact (14 or higher) takes half damage but full penalties.

Range: 50 feet (15.2 m)

Rate of Fire: A sonic blast can only be fired once per melee round. Each blast counts as one melee **attack/action**.

Payload: Effectively unlimited.

**6. Left Arm: Electric Arc:** The left arm can fire an Electric Arc similar to the spell of the same name. The electrical blast causes a crackling bolt of blue energy to leap from the small openings on the left forearm, near the wrist, and strike a nearby target — point and shoot; +2 to strike. The weapon version does slightly more damage and has slightly better range than the spell.

Damage: 3D6 M.D.

Range: 200 feet (61 m)

Rate of Fire: Each blast counts as one melee **attack/action**.

Payload: Effectively unlimited.

**7. Hand to Hand Combat.** The armor is well suited for hand to hand combat. All Mokoloi trained in the use of the armor have the following bonuses.

+2 attacks per melee round, plus one at levels 5 and 10.

+2 to initiative, +1 at levels 6 and 12.

+1 to parry (+2 with blades extended).

+2 to dodge

Body Flip/Throw - 1D4 M.D. plus victim loses initiative and one attack.

+1 to roll with punch, fall or impact.

**Damage:** Equal to Supernatural P.S. or the 30 supernatural P.S. of the armor, whichever is higher.

**8. Special Optics & Sensors:** The Prey-Stalker enables the wearer to see in total darkness (nightvision 600 feet/183 m), see the invisible, and sense magic equal to a 5th level spell.

**Sensor Bonuses:** Applicable to long-range weaponry only. +1 to strike and +1 to dodge.

## Shadow People R.C.C.

### Optional Player Character Race

The Shadow People have always been known to the Aboriginal people and were a popular subject for ancient Aboriginal cave paintings. This mysterious race has always lived in the craggy rocks of the Australian Outback, however, they had been sleeping for many hundreds of centuries. The explosive return of magic that came with the Great Cataclysm woke them from their slumber, and got them to emerge for the first time since the Dreamtime. They are a friendly and gentle people, but incredibly shy. Consequently, except for the occasional Bushman and brief, uncertain glimpses by others, they remain largely unknown to and unseen by most Outbackers and D-Bees — the Tech Cities and Mokoloi know nothing about them, and some wilderness people and adventurers have heard tales about "Shadow People," but have never seen them. The only exception is the Aboriginals. Shadow People and Aboriginals knew of each other long before the coming of the white settlers and shared a quiet, easy friendship. One would often come to the aid of the other and help in small ways like leaving food or water for one another, watching out for children, warning of approaching danger, and so on. The Aboriginals flattered the Shadow People by portraying them on their cave paintings and those fond feelings have continued into the new age. When the Shadow People reappeared after the Great Cataclysm, the traditionalists among the Aboriginals recognized and greeted them with hugs and gifts of food. The quiet Tall Ones responded by lending the people a helping hand. Virtually all Tribes consider the Shadow People to be their friends and both races treat each other with great kindness and generosity.

Shadow People are a dusky, grey-skinned race. They are very tall and incredibly thin — almost frail or skeletal in appearance. Their waist is often no thicker than a grown human's forearm, and their arms are nearly as long as their **bodies!** Shadow People have long faces that taper from the cheek bone to the chin. The forehead is tall, the ears large and a bit **cauliflowered**, and their large, droopy eyes are like deep, dark pools of water. Overall, **their** faces have a sad quality to them, but when they smile their white teeth light up their entire appearance. In fact, their deep laugh has a warm, friendly sound with a tone of wisdom to it. The entire body tends to wave in an almost poetic motion as if gently swaying in the wind. Even more unusual (and unnerving to those not familiar with this mystical race) is that parts of them seem to vanish in shadows, and they completely disappear in darkness!

Shadow People are a pleasant race with few social or religious prejudices. They are open-minded and understanding, and



enjoy making new friends, even though most are too shy to do so frequently. Although painfully shy and **timid**, they are also extremely inquisitive, so on one hand they tend to stick to themselves and avoid contact with others, yet at the same time, their curiosity is so strong that the outside world calls to them like sweet music. They can't resist prowling the rocks, hills and mountains to spy upon the world. They even enjoy sunlight and blue skies, although they do so from the shadows where they should be relatively safe and unseen. They see the world as a mosaic of life and find the blue skies, plants and animals, from butterfly to **humanoid**, beautiful and interesting. They are not psychic themselves, so that aspect of the world is closed to them, and they find people with psionic powers to be absolutely fascinating. They live by an unspoken commitment to nurture and defend the Australian continent from reckless destruction and evil forces, both human and supernatural. This is why they get along so well with Aborigines.

They group together in small families of three to seven members, but will gather in large (for them) clans of 10-30 sometimes venturing out to observe travelers or the way other races live. **Their** ecology is more or less unknown. They are herbivores, eating only plants, nuts, fruits, berries, bulbs, roots, and products such as **wine**, juice, candy, honey and milk. They do eat insects — and consider beetles, ants and grubs to be the equivalent of **crunchy** or chewy candy, reserving them for special occasions and treats.

Shadow People live in the very thin, deep shadows and cracks in or between large rocks and rock formations common to the hills and mountains in many parts of Australia. Their magical nature allows them not only to disappear in shadows and darkness, but to effectively create an entire world of their own within the faults that run through the rocks. So long as there is the slightest amount of gap, where they can live in cool comfort, they are content. Only beings who can traverse dimensions or become two dimensional can enter the magical world of the Shadow People (see Temporal Wizards, Warriors and Raiders, **in Rifts® England**). Within the recesses of the crack is a realm that is fundamentally a separate pocket dimension. If any other being uses magic to slide into the rock where the Shadow People live, they will suddenly feel as though they are sliding through a narrow, stone passageway or fissure that opens into a natural looking cave lit by a warm orange light that has no apparent point of origin or source of fuel (it's magic). The cave walls are decorated in hundreds of Aborigine-style cave paintings, only with more action and detail. To the 3-7 Shadow People living there, this realm is **their** house, nestled away from the outside world. A safe haven to gather, rest, sleep and store personal items. Cracking or blowing the rock open destroys the pocket dimension and throws the Shadow People living in it out into the wild. Bear in mind that when we say "rock" we mean a boulder or a crack or crevice in the side of a rocky hill or mountain — stone weighing several tons.

Although gentle, reserved and loving by nature, Shadow People are resourceful and capable warriors. Their art of warfare is different from many other races. They have light bodies and low mass with which to inflict grievous physical damage or endure a brutal, sustained confrontation. Instead, they use their magical abilities and talents of stealth and subtlety to set traps, ambushes, use scare tactics and hit and run attacks. Most are con-

tent with chasing an enemy or threat away, rather than destroying it. However, a constant menace or terrible evil may be destroyed utterly if they feel it necessary. Despite their high regard for life and love of peace and serenity, they accept that death and killing is part of the natural cycle of life in the wilderness, so when they do kill, they feel no dishonor, and often no regret or **sadness**, because they did what needed to be done. Were the majority of Shadow People not good and caring beings, they would make **terrifyingly** effective and lethal assassins.

The technology of the Shadow People is simple and roughly equal to that of the Aborigines. They use boomerangs, clubs, spears, fire, woven clothing and pouches, along with some metal items, and the occasional weapon made from a Millennium Tree. As creatures of magic — a sort of Australian faerie people — they are also strongly into the magical arts. All Shadow People possess natural magical abilities, and a large number have devoted themselves to furthering their studies in magic.

These days they still keep to themselves, usually too shy to progress too far beyond **their** own little world between the rocks. But sometimes lucky people will catch a glimpse of one or more just before they disappear between or under a rock. And really lucky ones may enjoy the company of one or two as a travelling companion and friend for life, for once a bond is made, it takes treachery or cruelty to lose their friendship. A Shadow Person who is a player character (optional, provided the G.M. allows it) is likely to be young and inexperienced with a yearning for adventure and a chance to see the world. Such a character may be uncharacteristically bold and inquisitive. On the other hand, the character may join the player group out of a sense of responsibility, friendship, caring or other reason (needs to guide them to a particular place, their help to rescue some Shadow People or Aborigines, wants to help destroy a demonic menace, etc.). In this latter case, the Shadow Person is likely to be extremely cautious, nervous, jittery, and scared of his own shadow. Many will try to be peacemakers and diplomats, who try to talk and negotiate **their** way out of trouble. However, the character will never abandon friends, is not afraid to use his magic or take bold action when absolutely necessary, and will struggle to overcome his fears and dislike for adventure and violence for the greater good of his people or comrades. They are especially nervous when out in the open, like in deserts and flat, open plains, because there are few shadows, crags and cracks to hide in.

## Shadow People

### NPC or Optional Player Character

**Alignments:** Any, but tend towards Scrupulous and Unprincipled. An evil Shadow Person is very rare.

**Attributes:** The number of six-sided dice to roll for each attribute is as follows: I.Q. 3D6, M.E. 2D6+1, M.A. 3D6+6, P.S. 2D6, P.P. 3D6, P.E. 3D6, P.B. 2D6+3, Spd 3D6+3.

**M.D.C.:** Shadow People are minor M.D.C. creatures. P.E. attribute number +4D6 to start and +1D6 M.D.C. per level of experience (on an S.D.C. world Hit Points are P.E. attribute +1D6 per level of experience, plus 6D6 S.D.C., and has a **natural A.R. of 9**).

**Horror Factor:** None, although seeing one fade in and out of shadows can be unnerving.

**Size:** At least 6 feet high, plus 2D6+1 inches (1.91-2.16 m).

**Weight:** Very light. 50-75 lbs (22.5 to 33.8 kg)!

**Average Life Span:** Unknown. They live for at least one thousand years, perhaps ten times **that**, plus, when magic energy is low (like it was during the age of **pre-Rifts** history), they hibernate inside their cozy pocket dimension and can sleep for thousands of years without aging or suffering in any way. P.P.E.: P.E. attribute number x5 plus 5D6 per level of experience.

**Average Level of experience** (NPC): 1D4+3

**Natural, Magical Abilities:** **Nightvision** to a range of 2000 feet (614 m), climb **98%/88%**, and bio-regenerates 2D6 M.D.C. per every 12 hours.

1. Step into Rock (special). Magically assume an almost two-dimensional form that enables them to slip into and between cracks and fissures in rocks and other earthen substances, including stone walls. This ability is automatic and expends no P.P.E., and requires no skill roll. The character simply uses one melee **action/attack** to become 2-D and another to slip into the crack. The gap/crack in the rock can be incredibly thin, but must be at least three feet (0.9 m) long.

2. Become **Two-Dimensional** (special). This ability is fundamentally the same as the Temporal Spell of *D-Shift Two Dimensions* (see **Rifts® England** for complete details about this magic), except the Shadow People can perform it at will, for an indefinite period of time and at a P.P.E. cost of only 10 points.

This is a dimension altering magic that turns the Shadow Person (self only) and anything he is wearing or on his person into a flat, two-dimensional image, like a piece of paper or a painting on a wall! As a two-dimensional being, the character cannot be detected by **thermo-optics**, heat, motion and most other sensors. The two-dimensional image of the character is also difficult to see or recognize (hide 85%). Furthermore, the character is one sixteenth his normal weight and mass and can effectively stick himself on the floor, or to the side of caves, rocks, walls, doors, vehicles and large pieces of furniture or have a friend slide him under doors and through cracks.

The two-dimensional character is still vulnerable to most forms of physical attack and environmental conditions, including fire, heat, cold, wind, energy blasts, magic and psionics. The character is especially vulnerable to wind and can be blown great distances as a piece of paper caught in the wind. Physical blows from weapons, punches, and explosions inflict half damage when the character is **stuck/braced** against a wall, floor or other mass. Gases and fumes also inflict half damage and drugs that must be ingested or injected have no effect.

Unfortunately, the character can *not* move, **speak**, eat, drink, or cast magic in the two-dimensional form. One's perspective of the world is also distorted, making the judgement of distances impossible, limiting vision to one narrow direction (no peripheral vision) and **time** seems to move very slowly.

1 Meld into Shadows (special): Shadow People meld into darkness to become partially to completely invisible. Unlike the Shadow Meld spell (which most Shadow People know), these magical beings automatically blend in with shadows. Thus, if one was standing partially in shadow and partially out, only half his body could be seen with the naked eye, the rest would seem to have vanished inside the shadow. How-

ever, infrared and **thermo-imaging** will reveal the whole person.

4. **Invisible in Darkness** (special): Shadow People effectively turn invisible in total darkness. Reflected or scattered beams of light will only reveal a bit and piece, or a shadow that runs past it for a moment. Only if the light is beamed directly on the character will the Shadow Person be revealed. Furthermore, when in darkness, Shadow People make no sound when moving, nor do they leave footprints! **Note:** Since they actually blend with the darkness, the ability to see the invisible does not work, however, **infrared** optics and thermo-imaging does.

**Vulnerability: Magic!** Although creatures of magic themselves, they are highly vulnerable to magic. When on a **Songline/Ley Line** or other "place of magic," including magic circles, magical sanctuaries, anti-magic cloud, etc., the Shadow Person loses his or her ability to step into shadows, disappear in darkness or to slide into large cracks. Furthermore, any spells they weave are cast at half their normal strength (half damage, duration, range, etc.). Magic energy somehow interferes with, and blocks, their natural mystic powers. Even worse, physical attacks (punches, bites, etc.) from their fellow *creatures of magic*, like dragons, Faerie Folk, etc. (not supernatural beings), as well as all types of magic spells and magic weapons, inflict double damage to them. A Ley Line storm causes so much interference that Shadow People within 100 miles (160 km) of the storm lose their powers as noted above, preventing those inside a crack from exiting it and those outside from entering.

**Combat:** Two attacks per round without any training, or those gained from Hand to Hand skills and other fighting skills.

**Bonuses:** +1 to dodge, +2 to pull punch, +2 to save vs punch, fall or impact, +3 to save vs **poison/toxins**. +3 on initiative, +1 to dodge and +15% to prowl at night or in the dark.

**Psionics:** None

**Magic:** Most Shadow People understand magic and Songlines, but can not use Songlines due to their vulnerability to magic energy. However, all possess the following magical abilities: See the Invisible, Concealment, Detect Concealment, Armor of **Ithan**, Mystic Fulcrum, Cloak of Darkness, Shadow Meld, plus a total of six spells of choice from common Wizard spells (make selections from levels 1-4), or three Temporal Magic spells, selected from levels 7-9.

**R.C.C.S Skills:** The Shadow People basically live off the land like Aborigines or Bushmen. R.C.C. skills include Prowl, Blend, Outback Survival, Land Navigation and Speak Aborigine, all at +20%. In addition, select two Ancient W.P.s, three skills from the Espionage (+10%) or Physical Category (any) and three from Wilderness or Domestic (+10%). **Note:** Their natural language is a strange dialect of Faerie Speak (-20% to those who speak faerie).

**Habitat:** Large rocks, craggy hills, canyons, bluffs, and mountains in the drier northern areas. They tend to stick to the Rim territories, though some can be found in the desert areas too. Shadow People tend to avoid the coastlines, and will never be found within 200 miles (320 km) of either Tech-City. However, they do sometimes sneak into wilderness outposts and towns.

**Enemies:** Anyone who is an enemy of the Millennium Trees or the **Dreamtime** is an enemy of the Shadow People, including most demons and evil forces of all kinds.

**Allies:** Aboriginal Tribes and some Outbacker humans. Shadow People haven't yet decided what to make of the **Kwarla**, but are leaning on a favorable note. Their strange appearance and innate magical powers make them alien and frightening to most humans and D-bees. **Note:** Nobody knows how many Shadow People exist in Australia. The Aboriginals believe there are fewer than 10,000, but since they are so reclusive and inhabit the **cracks**, and fissures of stone and split earth, nobody honestly knows (there could be half as many to ten times more).

## New Rifts® Skills

The following section presents some new skills common to the Australian Frontier. The first list includes common skills available throughout the world to most people of Rifts Earth, and have appeared in other Rifts® World Books. They have *not* been reprinted due to space limitations and a desire to avoid repetition.

### Complete Alphabetical List of Skills, Old and New by Category

**Note:** New skills new for Australia are noted in the list as "new" and are highlighted in *italic*.

#### Communications

Cryptography  
Electronic Countermeasures  
Laser  
Optic Systems  
Radio: Basic  
Radio: Scrambler  
Surveillance Systems  
T.V. & Video

#### Cowboy

*Branding (new)*  
*Breaking/Taming Wild Horses (new)*  
*Herding Cattle (new)*  
*Horsemanship: Cowboy (new)*  
*Horsemanship: Exotic (new)*  
*Lore: Cattle/Animals (new)*  
*Lore: Aborigines (new)*  
*Roping (new)*  
*Trick Riding (new)*  
*Whittling (new)*

#### Domestic

Cook                      Sewing  
                                 Sing  
*Corroboree (new)*  
Dance  
Fishing  
*Play Aboriginal Musical Instrument (new)*  
Play Musical Instrument  
*Rock Painting & Engraving (new)*

#### Electrical

Basic Electronics  
Computer Repair  
Electrical Engineer  
Robot Electronics

#### Espionage

Detect Ambush  
Detect Concealment  
Disguise  
Escape Artist  
Forgery  
Imitate **Voices/Impersonation**  
Intelligence  
Interrogation Techniques  
Pick Locks  
Pick Pockets  
Sniper  
Tracking  
Wilderness Survival

#### Mechanical

Aircraft Mechanics  
Automotive Mechanics  
Basic Mechanics  
Field Armorer  
Locksmith  
Mechanical Engineer  
Robot Mechanics  
*Vehicle Armorer (new)*  
Weapons Engineer

#### Medical

*Animal Husbandry (new)*  
*Brewing (new)*  
Criminal Science & Forensics  
First Aid  
Field Surgery  
Holistic Medicine  
Paramedic  
Medical Doctor  
M.D. in Cybernetics  
Pathology

#### Military

Armorer  
Camouflage  
Demolitions  
Demolitions Disposal  
Find Contraband, Weapons & Cybernetics  
Military Etiquette  
Military Fortification  
Nuclear, Biological, & Chemical Warfare  
Parachuting  
Recognize Weapon Quality  
Trap Construction  
**Trap/Mine** Detection  
Underwater Demolitions  
*Weapons Armorer (new)*  
**Note:** Military Skills are limited to **Outbackers**, but not City-Goers.

#### Physical

Hand to Hand: Basic  
Hand to Hand: Expert  
Hand to Hand: Martial Arts  
Hand to Hand: Assassin  
Acrobatics  
Athletics (general)  
Body Building & Weight Lifting  
Boxing  
Climbing  
Gymnastics  
Prowl  
Running  
Swimming  
S.C.U.B.A.  
Wrestling

#### Pilot

Airplane  
Automobile  
*Bicycling (new)*  
Boat: Sail Type  
Boat: Motor & Hydrofoils  
Boat: Ship  
Boat: Submersibles  
Boat: Warships & Patrol Boats  
Boat: Water Scooters  
Helicopter (Transport & Combat)  
Horsemanship: General  
*Horsemanship: Cowboy (new)*



*Horsemanship: Exotic Animals (new)*  
 Hover Craft (Ground)  
 Jet Aircraft  
 Jet Fighter  
 Jet Pack  
 Motorcycle & Small Vehicles (expanded)  
*Outback Combat Driving (new)*  
*Road Train (new)*  
 Robots & Power Armor  
 Robot Combat Basic  
 Robot Combat Elite  
 Truck  
 Tanks & APCs  
*Water Scooters (new)*  
*Water Skiing & Surfing (new)*

### Pilot Related

Navigation  
 Radar/Sonar Operations  
 Read Sensory Equipment  
 Weapon System

### Rogue

Cardsharp  
 Computer Hacking  
 Concealment  
*Find Contraband*  
 Palming  
 Pick Locks  
 Pick Pockets  
 Prowl  
 Safe Cracking  
 Seduction  
 Streetwise  
 Ventriloquism

### Science

Anthropology  
 Archeology  
 Astronomy  
 Biology  
 Botany  
 Chemistry  
 Chemistry: Analytical  
 Mathematics: Basic  
 Mathematics: Advanced  
*Undersea Farming (new)*



### Technical

Art  
*Breed Dogs (new)*  
 Computer Operation  
 Computer Programming  
*Gemology (new)*  
*General Repair & Maintenance (new)*  
*Language: Native (Kwarla and Aboriginal (new))*  
*Language: Australian English (new)*  
*Language: Mokoloi (new)*  
*Law (general) (new)*  
*Lore: Aborigines (new)*  
*Lore: Cattle/Animals (new)*  
*Lore: Cities (new)*  
*Lore: Dreamtime Culture (new)*  
 Lore Demons & Monsters  
 Lore: D-Bee (new)  
 Lore: Faerie  
 Lore: Magic  
 Photography  
 Whittling/Sculpting  
 Writing

### Weapon Proficiencies

Ancient Weapon Proficiencies  
 W.P. Archery & Targeting  
 W.P. Blunt  
*W.P. Boomerang (new)*  
 W.P. Chain  
*W.P. Grappling Hook (new)*  
 W.P. Knife  
*W.P. Net (new)*  
 W.P. Shield  
*W.P. Spear (new)*  
 W.P. Sword  
*W.P. Whip (new)*

### Modern Weapon Proficiencies

W.P. Revolver  
 W.P. Automatic Pistol  
 W.P. Bolt Action Rifle  
 W.P. Automatic & Semi-Automatic Rifles  
 W.P. **Sub-Machinegun**  
 W.P. Heavy Weapons  
 W.P. Energy Pistol  
 W.P. Energy Rifle  
 W.P. Heavy Energy Weapons & Rail Guns  
*W.P. Flamethrower (new)*

### Wilderness

*Blend (new)*  
 Boat Building  
 Carpentry  
*Dowsing (new)*  
 Hunting  
 Identify Plants & Fruits  
 Land Navigation  
*Outback Survival (news)*  
 Preserve Food  
*Roadwise (new)*  
 Skin & Prepare Animal Hides  
*Spelunking (new)*  
 Track Animals  
*Use Songlines (new)*  
 Wilderness Survival

---

## Skills For Down Under

The following is a list of skills available to many Australian O.C.C.s and R.C.C.S. Characters from other locations in the world cannot take these skills without spending time in the country first (at least 6+1D6 months), and no skill bonus applies. Even then, appropriate background training and experience is required. For example, no one is going to learn Dreamtime Culture if they spend their time inside the city walls.

**Note:** In most cases, only *new skills* applicable to their use in Australia are listed. All other skills common to that standard Skill Category can be found in the **Rifts® RPG and/or Rifts® Coalition War Campaign™** and other books like **Rifts Russia**, and can also be selected. The complete skill list is presented in previous pages. Cowboy Skills are available to select Australian O.C.C.s and are reprinted from the pages of **Rifts® New West™**.

---

---

## Australian Skill Descriptions

---

### Aussie Cowboy Skills

Branding  
**Breaking/Taming** Wild Horses  
Herding Cattle  
Horsemanship: Cowboy  
Horsemanship: Exotic  
Lore: Cattle/Animals  
Lore: Aborigines  
Roping  
Trick Riding  
Whittling

### Domestic Skills

**Corroboree**  
Rock Painting & Engraving  
Play Aboriginal Musical Instrument

### Mechanical

Vehicle Armorer

### Medical

Animal Husbandry  
Brewing

### Military Outback Skills

Basic Mechanics  
Camouflage  
Find Contraband, Parts & Relics  
Military Etiquette  
Military Fortifications  
Recognize Weapon Quality  
Weapons Armorer

### Pilot Skills

Bicycling  
Horsemanship: **General/Standard**  
Horsemanship: Cowboy  
Horsemanship: Exotic Animals  
Outback Combat Driving  
Road Train  
Water Scooters  
Water Skiing & Surfing

### Science

Undersea Farming

### Technical

Breed Dogs  
General Repair & Maintenance  
Language: Native (**Kwarla** and Aboriginal)  
Language: Australian English  
Language: Mokoloi      Lore: **Cattle/Animals**  
Law (general)      Lore: Cities  
Lore: Aborigines      Lore: **Dreamtime** Culture

### Wilderness

Blend  
Dowsing  
Outback Survival  
Roadwise  
Spelunking  
Use Songlines

### Weapon Proficiencies

W.P. Boomerang  
W.P. Flamethrower  
W.P. Grappling Hook  
W.P. Net  
W.P. Spear  
W.P. Whip

## Aussie Cowboy Skills

**Note:** Australia is one of the few places on Earth that has American style "Cowboys" and cattle ranching. Skills like these can be very useful in the shattered Outback and among wilderness settlements and outposts. These skills originally appeared in **Rifts**® **New West**.

**Branding:** The techniques and methods for tethering, controlling and marking, or "branding," animals. A brand is a mark burned onto the skin to identify and show ownership of an animal — typically used on horses and cattle, sometimes on human and D-bee slaves. This skill also includes a basic knowledge of common and notable **insignias** and emblems. **Base Skill:** 50% +5% per level of experience.

**Breaking/Taming Wild Horse:** To "break" a horse, or any exotic, wild animal suitable for riding, first the trainer must get the horse used to being around people, then to have a saddle on its back (this takes 3D4 days), then you "bit" train it (gets used to having a bit in its mouth and reins). Finally, the trainer must get the horse used to having a rider on its back. Depending on the horse, this can take a couple of weeks (making an attempt every day) or several weeks with moderate success. It takes a lot of skill to stay on a wild horse when he wants you off. Some horses are never completely tamed, and some will allow only certain people to ride them, while bucking and throwing other riders. During this initial training period, the rider must hang on for dear life while the horse does everything in its power to throw him. This battle of wills can last hours and take up to 12 weeks. **Base Skill:** 20% +5% per level of experience; -10% when breaking exotic and alien animals.

Also includes riding wild bulls (cannot be broken), wild broncos, and other wild animals, as well as *steer wrestling*, but **all at -15%**.

**Herding Cattle:** The techniques and methods of leading, directing and controlling cattle in a contained and orderly herd. Also includes keeping animals calm, basic care and feeding, how to tend to cattle, recognizing disease and illness, giving birth to young, how to survive and regain control of a stampede, gathering strays, how best to pen and corral livestock, mending fences, etc. **Base Skill:** 30% +5% per level of experience.

**Horsemanship: Cowboy:** See description under piloting.

**Horsemanship: Exotic:** See description under piloting.

**Lore: Cattle/Animals:** See description under technical.

**Lore: Aborigines:** See description under technical skills.

**Roping:** The rope is the cowboy's most important and famous tool. Characters with the roping skill can expertly throw a rope to **snare/lasso** a cow's horns or a horse's neck, or the hoofs of either, to enable a 140 pound (63 kg) man to capture and subdue a half ton animal! Hitched around the saddle **horn**, a lariat can be used to pull a mired animal out of a bog, mud or river, as well as keep a hobbled horse or other animal from straying away in the night or rain, and the rope can even be used to create an instant, make-shift corral when stretched taut by several men, to contain and hold a herd of animals — and even for quick justice at the end of a hangman's noose.

The roping skill includes knowledge and training in how to use a lariat or lasso, tie knots, expertly handle roped animals after they are snared, bring them to a stop by taking quick turns of

the lariat around the saddle **horn** (known as "dally" or "da la **vuelta**"), tethering animals, and how to "**hogtie**" animals (after the animal has been lassoed, the horse backs up to make the rope taut while the cowboy "tips" over the animal and ties three legs with a half shank; used in separating stubborn animals from the herd, capturing wild animals, and branding). The **rope/lariat** can be used for the roping and tying of animals including cattle, horses, similar alien animals, and even small dinosaurs and people. This skill with a lariat can be executed standing on the ground, but is designed and intended to be done from horseback (or hovercycle).

A failed roll to tie a knot means that it is loose, sloppy and easy to untie, slip out of, or likely to unravel or snap when strained. A failed roll to lasso an animal or stationary target, means it misses its mark or slips off.

Against human and intelligent opponents, roll to lasso as if it were a combat attack to strike and ensnare. The intended victim can try to dodge; parry is not applicable. A successful strike means the character is caught in the lasso. Ensnaring a foot, leg or hand means the victim can be tripped, knocked down and **pulled/dragged** by hand or horse. Ensnaring the upper body means one arm is pinned (useless). Two or more lassoes around the upper body means both arms are pinned and attacks requiring the use of **one's** hands are impossible, and the lassoed individual can be pulled off his feet and dragged. Multiple lassos can also be used to snare each limb and "spread-eagle" the character. It takes **1D4**melee actions to cut through a lasso, but it is impossible to draw a weapon and cut oneself loose if both arms are pinned or while being dragged. In this combat usage, the roping character is +1 to strike for every 20 points of skill, so a skill of 65% means +3 to strike/ensnare. **Base Skill:** 20% +5% per level of experience.

**Trick Riding:** Riding **bareback**, standing on the animal's **back**, hanging from the side, or under its belly (usually for rodeo tricks or to hide from enemies), side saddle, as well as quick mounts and dismounts, mounting a horse by leaping down from above or with a running start, leaping from the back of a horse onto another horse or wagon, and similar. **Skill Requirement:** Must know one of the horsemanship skills or trick riding cannot be selected. **Base Skill (Special):** The trick riding character can attempt all tricks and stunts without penalty; roll on the **first/greater** of the horsemanship skill percentages for success. **Note:** Characters without this skill can *try* any of these tricks, but must roll on the second percentage number of their horsemanship skill after reducing it by half. Roll for each attempt. Likewise, these stunts can be tried while riding mounts other than a horse, but reduce the skill by half, unless the character also has the skill *Horsemanship: Exotic Animals*.

**Whittling & Sculpting:** The art of carving wood, bone and horn into three dimensional **figures/statues/toys**, designs, and simple objects like wooden stakes, arrows, fishing hooks, walking sticks, staves, bowls, a simple flute or whistle, and similar. Many characters with this skill simply use it to pass time and **don't** necessarily make anything from their whittling. The percentile number indicates the quality of technique and the quality of the **work/appearance**. Taking the skill twice indicates a professional quality and gets a bonus of +10%. Selecting it **once**, indicates a talented amateur. **Base Skill:** 30% +5% per level of experience.

## Domestic

**Corroboree:** This is perhaps the most important skill to any Aboriginal character that believes in his people and his culture. The Corroboree is more than just a dance, it is a way to interact with the spirits and contact the Dreamtime. It requires at least **10** minutes or more of stomping, dancing and singing on a clear patch of earth. Without the Corroboree, Aboriginal society would crumble.

A successful Corroboree dance away from a ley line will earn respect from elders and other tribe members and bring peace of mind to the dancer/singer. In the latter capacity, the Corroboree functions as the equivalent of Meditation and can be used for increased healing and recuperation of P.P.E. **and/or I.S.P.** (see the magic section in the **Rifts® RPG**). Aborigines may perform the dance for themselves as a way to calm their nerves as well as to commune with the world. **Base Skill:** 30% +4% per level of experience. **Note:** When performed on a Songline (the Aboriginal name for ley lines), the Corroboree provides all sorts of mystical knowledge about the land and the line; see *Use Songlines* in the Wilderness Skill Category for details.

**Rock Painting and Engraving:** Aboriginal art is very unique and special to them. They decorate bark, skins and rocks with pigments. Each painting tells a story and describes a myth in a way that only a character with this skill can **interpret/"read."** Elders and **Mabarn** are the most common painters, and they take great pleasure in describing their works to those who wish to listen. **Outbackers** nickname this "X-ray painting" because the depictions of people and animals are stylized to show what looks like their bones. **Base Skill:** 36% +4% per level of experience.

**Play Aboriginal Musical Instrument:** There are several musical instruments unique to the Australian setting. The first, and perhaps most famous, is the humble *didgeridoo*, a long, thick, hollow length of carved **and/or** painted wood that is blown down one end. To Westerners, the didgeridoo may appear to be little more than a giant, 5-6 foot (1.5 to 1.8 m) long, flute or similar wind instrument, but really, there is no other wind instrument quite like it. The didgeridoo makes a distinctive deep, resonant sound — a unique, beautiful and haunting tone when played by somebody who knows what they are doing. However, those *without* skill in this instrument usually can't make it work at all, or make a truly terrible noise that sounds more like a fart or the groan of a bull moose than any semblance of music.

The second is the *bush whistle*. This is simply a leaf or a piece of bark that is blown along to make a high pitched shriek. Those with the Aboriginal Music Skill can play a tune.

Then there are the more traditional *beat sticks* — two pieces of wood that are knocked together to start a rhythm, traditionally for the Corroboree dance. These sticks can be anywhere from two feet (0.6 m) to two inches (5 cm) long each, and are typically beaten against each other, however, they can also be used on a small hollow log.

**Note:** Musical instruments common among Outbackers include the harmonica, "**wobble boards**" (a sheet of wood that is tapped and shaken back and forth), "**wash-board**" (sheet of serrated wood or metal that is struck with a clothes **pin/peg**), "**squeeze-box**" (accordion) and an assortment of drums (Wilderness folk also favor the guitar and other small stringed instruments, but such items *each* constitute a different skill; see the standard Play Musical Instrument skill). **Base Skill:** 25% +5% per level of experience.

## Mechanical

**Vehicle Armorer:** A specialized skill in which the character can do more than just tinker with the mechanics of a vehicle. He add (and often conceal) vehicle armor, modify or completely reconfigure the **body/housing** of a vehicle, add weapon mounts and **turrets**, add ram prows and shielding, soup-up with heavy-duty shock absorbers, extend and shorten wheel-bases, as well as operate, repair and modify weapons for mounting and use on vehicles; typically large caliber weapons, such as vehicle-mounted flame throwers, **machineguns** and mortars, etc. Various other skills may relate to this skill, but this is the essential Outback vehicle armorer or "tank maker" skill, provided the correct parts and tools are available. In fact, finding the correct parts may be half the adventure (see the *Find Contraband, Parts & Relics* skill). **Basic Skill:** 30% +5% per level of experience. **Note:** Automatically gets the basic mechanics skill at +20% as part of this package. Taking this skill in conjunction with Automotive Mechanics provides a +10% bonus to the automotive skill.

## Medical

**Animal Husbandry:** This area of study provides the character with a knowledge of the care, feeding, breeding, reproduction, treatment and behavior of domestic animals, as well as very basic veterinary skills for minor illnesses, setting a broken leg and giving birth. The animals included under this skill are cattle, oxen, sheep, goats, horses, mules, donkeys, ducks, chickens, and similar livestock and domesticated animals like dogs (see Horsemanship for breeding horses and the Breed Dogs skill under Technical). The percentile number indicates the degree of knowledge and skill one has about animals and their care. Reduce the skill ability by half when caring for captive or injured *wild* animals. **Base Skill:** 35% +5% per level of experience.

**Brewing:** The understanding and methods of making fermented alcoholic beverages from grains and fruits. This specifically includes wine, mead, ale, beer and moonshine. Stronger alcohol, such as brandy, rum, and whiskey, are not included, nor are champagnes or fine wines. The first percentile number indicates the chance of success (a failed roll means an **undrinkable** batch of booze). The second indicates the quality of the brew — the higher the number rolled, the tastier the drink. **Base Skill:** 25%/30%+5% per level of experience.

## Military Outback Skills

**Note:** The following Military skills are restricted to Outbacker and Wilderness characters who understand and use technology.

**Basic Mechanics:** A general familiarity and understanding of basic mechanics. This character can fix a toaster, repair a bicycle, replace a belt on a motor, repair or replace a switch, handle or knob, replace a spark plug, change oil, assist in automobile repairs, maintain machinery, read a schematic and similar fundamental tasks. **Base Skill:** 30% +5% per level of experience.

**Camouflage:** The skill of concealing a fixed base position, vehicle, bot, equipment or individual, using natural or artificial materials. A **fair** amount of time is involved in the preparation of a larger position. Large cargo nets, cut branches or underbrush are used most often in camouflage. This skill is also used to conceal traps. **Base Skill:** 20% +5% per level of experience.

**Find Contraband, Parts & Relics:** This is a variation of the standard Find Contraband, Weapons & Cybernetics skill available to the CS Military and many other modern Annies. Cybernetics is comparatively rare in Australia, although characters with this skill are likely to recognize them.

This is a valuable "scavenger" or "scrounger" skill that enables the character to recognize contraband, machine and weapon parts, and electrical components, as well as a variety of other valuable parts and components. The character also knows where to find arms dealers, Operators/mechanics, Road Gangers, smugglers, scavengers, bandits, illegal automotive garages, body chop-shops, and criminals who buy and sell such items. He is also familiar with their practices, hangouts, gang or criminal ties, general practices, code of conduct, general value of items, scarcity, pricing structures and modes of operation. Likewise, the character has a good idea of what black market weapons, parts and cybernetics should cost and what these people pay for valuable parts, relics, and contraband items (prices vary greatly depending on the item, location and buyer). The character also knows the penalty for being caught with a stolen, rare or illegal weapon or item. The two Tech-Cities and their military and police are especially hard on thieves, smugglers and black marketeers operating in and around their city-states. The two Tech-Cities also offer some of the greatest opportunities for buying, selling and stealing rare or illegal relics, parts and weapons. Individual Outback communities and gangs will each have their own set of laws and rules of conduct. **Base Skill:** 26% +4% per level of experience. **Note:** This skill *should* be considered separate and apart from streetwise.

**Military Etiquette:** This skill grants a clear understanding of the way the military works, including rules of behavior (when to salute, how to address superiors/subalterns, etc.), military procedures and routines, standard issue of equipment, special ordering procedures, proper display of rank and medals, advancement in rank (and the duties that come with it), proper troop formations, how to deal with military bureaucracy, the chain of command, proper channels, who to contact to get things done, and other useful information in matters of military protocol and bureaucracy. **Base Skill:** 35% +5% per level of experience. **Note:** All soldiers have a fundamental knowledge of military etiquette (base skill 30% with no improvement), but this skill is much more complete, with a strong knowledge of what is expected, correct and the formal approach (e.g. by the book knowledge). This skill is also available to City Troops.

**Military Fortifications:** This is the skill of designing and building defensive fortifications suitable for modern mega-damage combat. If provided with the time and materials the character can greatly increase the defensive value of natural terrain with murderous defenses that include obstacles to impede movement and protective structures to shield friendly forces from enemy fire. The character is trained to prepare mine fields, barricades, barbed wire, tank obstacles, tanglefoot wire, booby traps, trenches, tank ditches, fox holes, reinforced concrete or earthen walls, bunker complexes, rail **gun/mortar** emplacements, tunnel systems and similar defensive constructions. **Base Skill:** 30% +5% per level of experience.

Even with the advent of mega-damage warfare the old standby fortifications listed above have useful applications. Obstacles like ditches, walls, trip wires, and mine fields slow the advance of infantry troops, monsters, robots, and tanks, expos-

ing them for longer periods to the defenders' **firepower**. Earthen walls and fox holes, made from S.D.C. materials, still afford soldiers some protection and can disperse energy blasts or deflect shrapnel from explosions. If these protective structures are built with Mega-Damage concrete and alloys, they provide defenders with as much protection as any robot vehicle or tank!

**Recognize Weapon Quality:** The ability to accurately determine a weapon's durability, reliability, and quality by physically examining it. This includes knowing which manufacturers are reputed to make the best weapons, the ability to recognize damage or signs of misuse, modifications/customization or wear and tear, whether the weapon can be made as good as new with a little repair work **and/or** cleaning, whether it is a cheap (or quality) "knock-off (copy/imitation), and so on. The character can also recognize if the weapon is stolen (serial numbers filed away, etc.), new, old, and if it has any other special features or properties as well as what the fair price should be. **Base Skill:** 25% +5% per level of experience. **Note:** Reduce the skill ability by half if the item is not actually handled (seen but not **touched/examined**).

**Weapons Armorer:** This is a somewhat simplistic version of the weapons engineer as it applies to infantry weapons. A competent armorer character can maintain, fix, modify, mount, **reload/charge** ammunition, and figure out most small arms. They can repair all types of pistols and rifles, repair minor damage to body armor (20 M.D. maximum), adjust targeting sights, use and repair optical enhancements, reload missiles and ammo drums, recharge **E-clips**, install/mount a rail gun or **machinegun** on a vehicle, and even fix most simple robot and bionic weapons like forearm blasters and retractable blades. **Base Skill:** 40% +5% per level of experience. **Note:** Automatically gets the basic mechanics skill at +20% as part of this package. Also see Vehicle Armorer skill.

## Pilot

### Horsemanship Skills

There are *three* types of horseback riding skills in Australia: *General/Standard* (the typical skill known by wilderness people and **Outbackers**), *Cowboy* (exclusive to the Australian Cowboy) and *Exotic Animals* (the ability to ride alien and monstrous animals from other worlds). City dwellers do *not* ride animals, not even for recreation or sport!

Trick Riding and Roping skills can augment and complement one's riding abilities, but are not riding skills in and of themselves. Each "Horsemanship" skill indicates a certain degree of training and expertise in riding and handling horses. Each type of horsemanship has the following skills and areas of knowledge. The higher the skill percentage, the better the skill or ability. **Note:** To avoid being thrown from a horse when jumping, charging, kicking or performing some other difficult maneuver, the character must roll under his horsemanship skill percentage to remain in the saddle and in control of his animal. Tricks and stunts (without the Trick Riding skill) can be performed, but use the second percentile number, reduced by half.

Ride & care of horses: The first percentile number indicates the character's riding ability and a fundamental knowledge of feeding, caring, and grooming of horses.

Recognize **quality/breed**: The first percentile number also indicates the success ratio of recognizing the breed quality, age,

strength, speed, health, and general attributes/capabilities (race horse, workhorse, **warhorse**, etc.) of the animal.

Breed horses: The second percentile number indicates the knowledge in the raising, breaking, training and breeding of horses. It includes shoeing horses, giving birth, and curing minor ailments and injuries.

Jumping: The second percentile number also indicates the success ratio of NOT being thrown from the horse when jumping, charging, kicking or performing some other difficult maneuver or trick. The character must roll under his percentage to remain in the saddle and in control of his animal. Damage from being thrown off a horse is typically **1D6**.

Racing: The second percentile number also indicates the success ratio of maintaining control and getting maximum speed while racing at full gallop. A failed roll means the horse runs quickly but **10%** short of its maximum speed attribute. A successful roll not only means running at maximum speed, but the rider can coax that little extra spirit and speed out of the animal. Once every four minutes, the rider can get the horse to kick into overdrive and run at 25% faster than its normal maximum. However, this speed can only be maintained for one minute at a time and cannot be done more than three times in a 15 minute period. Maximum running speed can be maintained for a period of minutes equal to the horse's P.E. attribute. Pushing the horse beyond its endurance will cause it to slow down by 30% and after 4D4 minutes, collapse from exhaustion (requires at least a half hour rest and light activity for another hour).

**Combat:** All bonuses are in addition to other combat skills, weapon proficiencies, or attribute bonuses. Applies to the rider, not the horse. The rider gains a combat advantage from the height and speed of being mounted.

**A general note about horses:** The horse attack skill reference indicates that the rider is skilled enough to remain saddled while he attacks and has his horse rearing or kicking in simultaneous attack (roll under second percentile number).

Attribute Notes: Horses have a fairly high animal intelligence, roughly equal to that of a dog, and can generally carry or pull 500 pounds (225 kg). A war or workhorse can carry about 600 pounds (270 kg) but pull up to five tons, and a pair of workhorses can pull up to 15 tons (the speed of a workhorse is a mere **15 mph (24 km)**).

Speed: Workhorses, Mules & Donkeys: Spd 22 or 15 mph (24 km)

Ponies: Spd 36+3D4 or approx. 25-30 mph (40-48 km)

Riding Horse: Spd 48+1D6 or approx. 35 mph (56 km)

War Horse: Spd 48+1D4 or approx. 35 mph (56 km)

Race Horse: Spd 57+1D6 or approximately 40 mph (64 km) with short bursts (**1D4** minutes long) of up to 50 mph (80 km), but cannot handle the hardships of the wilderness (reduce H.P. & S.D.C. by 20% for every month forced to function in the wilderness or as a workhorse).

Average P.P.E.: 5D6; sensitive to the supernatural, ley lines and strong magic.

Average Life Span: 7-9 years as a work or strong riding animal, after which the horse is worn out (reduce H.P., S.D.C. and Speed by one third), but can continue to be used for light work, light to medium riding **and/or** put out to stud for several years to follow; total average life span is **12-15** years.

Hit Points & S.D.C.: The typical riding and race horse has 4D6+6 hit points and 5D6+12 S.D.C.

War Horse: 5D6+10 H.P. and 6D6+16 S.D.C.

Workhorses and Mules: 4D6+10 H.P. and 4D6+20 S.D.C.

Pony and Donkey: 4D6 H.P. and 2D6+12 S.D.C.

M.D.C. Horse **Barding**: Light offers 40-50 M.D.C. without penalty, heavy: 110 M.D.C. but reduce the animal's speed by 5%.

Damage from Horse Attacks: The exact damage from a horse's kick will vary with the size and breed of the animal; generally 2D6 S.D.C. from the front legs and 4D6 from the rear legs; +6 damage from war horses.

Attacks per melee round: 2 or 3.

Cost: Donkey: 600-1000 credits or Australian Dollars.

Mule: 800-2000 cr.

Workhorse: 1000-2200 cr.

Ponies: 800-2000 cr.

Riding Horse: 2000-4000 cr.

War Horse: 3000-6000 cr. untrained; 15,000-30,000 for a trained animal.

Race Horse (for sport & gambling): 20,000-300,000 cr.

**Horsemanship (general/standard)**: All the basic skills as noted above. **Base Skill**: 40%/20% +4% per level of experience.

Combat: All bonuses are in addition to other combat skills, weapon **proficiencies**, or attribute bonuses. Applies to the rider, not the horse. The rider gains a combat advantage from the height and speed of being mounted.

- +1 to parry or dodge while on horseback.
- Inflicts +1D4 S.D.C. damage when on horseback.
- Charge attack (running horse) with a pole-arm or spear: +1D6 damage. The attacker must roll under the second percentile number to avoid being dismounted. Charge attacks count as two melee actions/attacks.
- Horse attack; see details under stats for horses.

**Horsemanship: Cowboy**: **Base Skill**: 66%/50% +3% per level of experience. Not available to most O.C.C.s.

Combat: All bonuses are in addition to other combat skills, weapon proficiencies, or attribute bonuses. Applies to the rider, not the horse. The rider gains a combat advantage from the height and speed of being mounted.

- +1 on initiative when on horseback at levels 2, 5, 10 & 15.
- +1 to roll with fall or impact when knocked from a horse.
- +2 to parry or dodge while on horseback.
- Inflicts +1D4 S.D.C. or M.D. when on horseback, depending on the weapon (M.D. weapons like **Vibro-Blades** get the M.D. bonus; not applicable to ranged weapons like rifles and blasters).
- Charge attack (running horse) with a pole-arm or spear: +2D6 S.D.C. damage. The attacker must roll under the second percentile number to avoid being dismounted. Charge attacks count as two melee actions/attacks.
- Horse attack; see details under stats for horses.

**Horsemanship: Exotic Animals**: This skill is basically the same as the original horsemanship skill, except that the charac-

ter is experienced in riding other types of "tame" animals. This can include elephants, camels, and llamas, to the Pegasus, **Dragonductyls**, Gryphons, demonic hounds, giant insects, Wormwood™ parasites, and other alien or monstrous beasts trained to be riding animals. Wild, untamed creatures cannot be ridden (except by the likes of the Simvan monster riders). **Base Skill**: 30%+4% per level of experience.

**Skill Note**: Characters with the traditional "horsemanship" skill for riding Earth horses and other very horse-like animals can quickly figure out how to ride exotic and alien riding animals, but at a skill penalty of -12% to ride **ground/running** animals and -14% to ride flying or tree climbing and leaping animals. **Similarly**, D-Bees not familiar with riding the fast Earth horse are -10% to ride them. **City Note**: Except for specially trained operatives, no City Troopers or Police are trained in riding a horse, let alone an "unnatural, alien creature!" This skill is available to all non-City O.C.C.s.

## Other Piloting Skills Down Under

**Bicycling**: Means the character can ride over rough terrain, reach two times normal running speed and travel cross-country at normal running speed, and perform tricks and jumps (roll skill level; failed roll means a crash). Maximum speed can be maintained for a time equal to the P.E.x5 in minutes. Skill also includes basic maintenance/repairs. **Base Skill**: 44% +4% per level.

**Kayaking**: Allows the use of most paddled boats and canoes, row boats and knee boards. Speed in still water is usually equal to the character's P.S. attribute (treated for all purposes as Spd) and can be maintained for P.E.x5 in minutes without pause. The skill also includes basic principles behind using currents, maintenance, and even "tricks" like sculling and right-siding a flipped canoe, etc. **Base Skill**: 50% +5% per level.

**Outback Combat Driving**: This skill supplements other driving skills by helping to make the character a master of the roads when driving ground vehicles (ground hugging hover vehicles are included, but aircraft, 'bots and power armor are not). It helps to turn the character into an aggressive road-hog and cool-headed "chicken" player. In fact, tricks, dangerous maneuvers and car chases are challenging and fun — although passengers are likely to fear for their lives.

In game mechanics, skill penalties for tricks, vehicular attacks (ram, sideswipe, etc.), and evasive maneuvers are reduced by half, plus the character is +2 to dodge when driving, +2 to survive a crash, punch, fall or impact, can fire a weapon from a moving vehicle at only a -2 penalty, and can even make an aimed or "called shot" (-2 to strike) while on a moving vehicle. **Note**: This is a supplemental piloting skill applicable only to ground vehicles and does not have a base skill or level of progression other than reduce penalties an additional one point per level of the driver's experience.

**Road Train**: Some of the road trains that cross the Australian wastes are simply HUGE. Imagine a semi-trailer, only with four or even five trailers pulled behind the cab. These beasts guzzle gas, but are more economical than four or five trucks. They are also very unique to handle. Someone with the Pilot: Truck skill may attempt the same task, but with a -30% skill penalty and at half maximum speed. **Basic Skill**: 40% +4% per level of experience.

**Water Scooters:** The knowledge and skill of piloting all types of one and two-man water sleds (underwater) and jet skis (surface sleds). **Base Skill:** 50% +5% per level of experience.

**Water Skiing and Surfing:** All water skiing techniques, methods and use of most types of recreational forms of "riding the waves," including skis, ski jet boots, water boards, surf boards and sail boards. **Basic Skill:** 40% +4% per level of experience.

## Science

**Undersea Farming:** (Originally presented in **Rifts® Underseas™**). The knowledge of cultivating undersea plants and algae, and/or breeding aquatic fish/animals for harvesting and production. Undersea farming includes, but is not limited to, growing crops (either through hydroponics or on the ocean floor), lobster farms, oyster beds and fish hatcheries. **Basic Skill:** 35% +5% per level of experience.

## Technical

**Breed Dogs:** The first percentile number indicates the art of raising, mating/breeding, taming and training domestic and wild canines, as well as a knowledge about canines in general.

The second percentile number is used to attempt to tame a wild canine, teach a dog tricks, or to train the animal for a specific task like tracking, retrieving, pointing, herding animals, attacking on command, and so on. A failed roll means that the animal refuses to learn that particular trick or specialty. Note: These are trained work animals or pets, not familiars. **Base Skill:** 40%/20% +5% per level of experience. **Note:** The Australian Dingo can not be domesticated.

**General Repair/Maintenance:** Not everyone can be an Operator, blacksmith or a carpenter, but many are good with their hands and capable of doing satisfactory repairs on simple mechanisms, gears, pulleys, wheels, rope, and so on. General repair/maintenance skill includes: sharpening blades, minor repairs on weapons, packing their own S.D.C. bullets/ammunition, sewing tears in clothes (it may not look pretty, but does the job), replacing a wagon wheel, change a tire, shoe a horse, repairing furniture, painting, varnishing, nailing and assisting in basic woodworking, and even doing minor patchwork on armor (restores 1D6 M.D.C.).

Roll once to see whether the character can figure out **what's broken**, what must be done to fix it, and whether it's beyond his meager abilities. Roll again to determine success or failure in making the actual repair. If failure, the player may try again, but only twice. **Base Skill:** 35% +5% per level of experience. Reduce skill proficiency by half if the item is extremely damaged, complex, high-tech or alien.

**Language: Aboriginal (Kwarla and Aboriginal):** In Australia, there are a several new languages to observe. The Kwarla have their own language, but it **very** similar to the Aboriginal language. In real life, every Aboriginal tribe has a different dialect that can differ to such a degree that each almost constitutes a new language. For the simplicity of the game **world**, having a skill in Aboriginal or Native Tongues gives the character a rudimentary understanding of the Kwarla and Aborigine languages. **Base Skill:** 35% +5% per level of experience. The G.M. can ascribe a **10-20%** skill penalty for different dialects, especially to those that are more than 500 miles (804 km) from where the character grew up.

**Language: Australian English:** There is also *Australian English*. When most people say they speak "Australian" or "Outbacker," it refers to the unique slang, accent and dialect of the Aussies who live outside the cities — sometimes referred to as "Outback English" or simply as "speaking Outbacker." Since the Coming of the Rifts and the segregation of the Cities, the slang and dialect of those living outside the cities has become rather dramatic. While city dwellers and wilderness folk can communicate with minimal difficulty, there is a strong difference. City Dwellers generally speak refined English using proper grammar and little, if any, slang. Meanwhile, Outback English is typically crude, uses poor grammar, and is heavy with slang, and often mixed with a healthy dose of humor and/or swear words. Outback slang involves abbreviations, and the shortening of words and sentences (lots of ain'ts 'n such). English speaking people from Melbourne, Perth or other parts of the world might have to think twice about what was just said to them. An American communicating with an Australian might have a tedious conversation **indeed**, at least until the two get used to each others dialect, accents and slang (-1D4x10% to understand each, especially when talking quickly or when drunk). **Base Skill (for D-Bees and such):** 50% +5% per level of experience. **Note:** All white Australian characters are assumed to speak their own English language at a minimum of 80% proficiency, except city dwellers often speak very good and clear to perfect English at 90-98%. Other languages will have to be purchased with skills.

**Language: Mokoloi:** The Mokoloi are aliens from another world displaced by magic to Rifts Australia. Their language is **guttural** and different from English or Aboriginal. **Fortunately**, most Mokoloi speak Australian English. **Base Skill:** 40% +5% per level of experience. Most southern people do not speak Mokoloi, or even know they exist.

**Law (general):** The study of law allows the character to know many legal precedents, procedures and punishments *common* throughout the Australian wilderness. It includes the laws and customs of most major towns, gangs and tribes, as well as the rudiments of City law. This can be an invaluable skill when trying to bargain for one's life in a courtroom. **Base Skill:** 25%+5% per level.

**Lore: Aborigines:** Characters with this skill can recognize the different tribes, warriors, shamans, totems, fetishes and warnings of the Aboriginal people. They can identify the people by their housing, clothing, wall paintings, skin **painting/decorations**, and weapons. This skill also gives the character a fundamental understanding about the Aborigine society, beliefs, customs and laws — at least the most notable ones. Also see Lore: **Dreamtime** Culture for a more in depth understanding about Aboriginal gods, Dreamtime, spirits, and magic. **Base Skill:** 25%+5% per level.

**Lore: Cattle/Animals:** This is a general knowledge about cattle, horses, livestock, and other, notable animals of the **Outback**. This knowledge includes what they eat, where they live in the wild, means of defense, the value of their meat, fur, hides and horns, and their natural predators, as well as the most notable tales about supernatural animals, spirits, gods and magic attributed to or involving animals (including some Aboriginal spirit and totem lore). **Base Skill:** 30% +5% per level of experience.

**Lore: The Cities:** To most outsiders, what goes on inside the fortress cities is an enigma. Hence, characters with the City Lore skill have gathered useful snippets of basic information regarding common laws, operating procedures, customs, politics, and even fashions/dress/appearance of city dwellers, particularly their military and police. As a result, the character knows what constitutes illegal trade and activities, is able to recognize City soldiers, police officers, and aircraft, estimate the location and probable number of sentries, predict guard movements and responses, understand standard procedure, and so on. **Base Skill:** 20% +5% per level of experience. Aboriginal characters can never take this skill.

**Lore: Dreamtime Culture:** There is a very powerful mythology surrounding Aboriginal culture. Many tribes consider the Coming of the Rifts to be a second Dreamtime (the Dreamtime being their creation myth, when the world was formed). Now that the spirits have *returned* and the “**Songlines**” have risen to new heights of power, Dreamtime Culture is pervasive among the native people. This is a very intricate skill to those not born and bred in the Aboriginal culture.

The **philosophy/religion/world** view of the Australian Aborigines is a strange blend of animism with the more bizarre aspects of modern physics. In other words, Dreamtime is another version of reality. Here are some of the features of Dreamtime.

- All time, from the remote past to the far future, is together, as if it were all one piece. This helps to give the Aborigines infinite patience, knowing that if a thing is meant to be, it will happen.
- Animals, insects, and plants all have voices in Dreamtime. They do not speak as individuals, but as a collective. In other words, one could be talking to an Emu, but not just any Emu, but the primal Emu, sort of a super-Emu who represents all Emus.
- One must dream of lives to come (unborn children) or they will not come. And one must dream of lives that have left. All the land, the plants, insects and animals must be dreamed of too, or they will cease to exist or not come into existence.

*To non-Aboriginals*, the skill translates into a “lore” skill that gives the character a very loose understanding of Dreamtime myth, spirits, rituals and beliefs, as well as knowing a hundred stories about the Dreamtime. Such characters are also able to identify and know something about the gods, spirits and monsters associated with the Dreamtime, and the danger they may represent.

*To Aboriginal people*, the skill is about ancestry, identification of omens and spirits, performing dances and rituals, Aboriginal history, being at peace with the world, and general theory on how the spirits and magic interact to form the universe in the current time. It also provides the Aborigines with a basic instinct that translates into the ability to *Sense Supernatural Evil*, roughly equal to that of a Dog Boy or **Psi-Stalker**.

**Base Skill:** 20% +5% per level of experience (all Aborigines get a skill bonus of +20%; shamans and select others may be higher). Yes, this is the **Rifts**® version of the skill Dreamtime Lore from **Mutants Down Under**™ and written by **Erick Wujcik**.



## Wilderness Skills

**Blend:** This skill is a variation on the skill Prowl, except a little different in application. It is the natural ability to simply fade into the underbrush and remain unseen in the bushlands. With a successful roll, a motionless character can remain hidden and undetected, even when somebody is standing mere inches away. The Blending character is so motionless, and so in tune with his surroundings, that he is practically invisible to the naked eye. Of course, electronic sensors and optics will defeat this ability, as will magical or psionic perception. Furthermore, the character must have appropriate clothing or natural concealment; i.e. he must be partially camouflaged. It is quite extraordinary how complex the Australian bush can be to look at.

It is possible to vanish from view the moment a pursuer or antagonist looks away. This means the opponent must be distracted for a few seconds. This ability cannot be used during combat, but it can be used (especially) for an ambush. A favorite tactic of Aboriginal warriors is to run from an opponent and fool him into chasing. He will then wait for an opportune moment (such as running around a rock) to Blend, so that he may burst out behind the foolish aggressor and slice him to bits (never battle such an opponent on his home ground - many Bushmen will tell of the healthy respect they have for their fighting capacity). **Basic Skill:** 14% +4% per level of experience; +4% if the character also has the ability to prowl, and +4% if at night. Note that all Aboriginal characters automatically get a +10% bonus which is in addition to any probable O.C.C. bonus. **Note:** If the hidden character is being actively sought after, he suffers a skill penalty of -10% to remain concealed.



**Dowsing:** This is the ability to locate fresh water whether it be with a divining rod or by more scientific and logical means. For some (like Aborigines) it is a mystical **ability**, while for others (like the Bushman), it is done through deductive analysis and knowledge of nature. The percentage number indicates the success ratio of locating fresh water. A person can roll once every melee to sense water, but must roll *two consecutive* successful rolls to locate the water. **Base Skill:** 20% +5% per level of experience.

**Outback Survival:** Just like the skill Wilderness Survival, except adjusted to suit the varied terrains of the Australian wilderness. This is a particularly useful skill for those that intend to travel the Outback without the benefit of radio navigation, computers, radar, sensors and electronics (few people in the Outback have equipment like this). This is the way the Aborigines have been "reading the Outback" for centuries without technological aid.

A successful skill roll means the character can tell which direction is North (day and night) and estimate his current or desired direction, determine the approximate time of day, as well as when the sun will rise and set, keep an accurate calendar (month and day of the year), accurately estimate distances and not be confused by the similarity of terrain, as well as understand the advantages and pitfalls of the seasons, and feels at home in the bush and deserts. Most importantly, it includes living off the land, finding food and water, and similar. The plants, animals, and availability of water in the Outback are unique in the world, and therefore, finding "tucker" (as food is sometimes referred to) is quite a different process. With this skill, the character can locate edible berries, honey, bark, leaves and nutritious bulbs, find water holes and so forth. The character will also be skilled in gathering water through various means such as stretching a plastic sheet between two branches and collecting the condensation or rainfall, and even finding edible bugs and small animals (though the thought may be disgusting, there are some ants and grubs that are delicacies to both the Aborigines *and* white **survivalists**). At higher levels, the character will be perfectly happy to live on bush "tucker," but at lower levels, meats and prepared foods will still be a welcome sight. **Base Skill:** 58% +2% per level of experience. **Note:** Some bush foods can be highly dangerous. The humble eucalyptus, for instance, is poisonous. Characters from other parts of the world, who have the Wilderness Survival skill are **-15%** to survive in the Australian Outback.

**Roadwise:** The Outback is still crossed with roads. Some are ancient, **pre-Rifts** concrete creations that have not been maintained since before the Apocalypse, others are patched and rebuilt roads, while others are new stone or concrete creations, trails and dirt paths. To the untrained traveler, they are no more than tracks in the dirt, barely suitable for travel — half-disintegrated highways that are little more than ruts cutting through the hostile landscape. But to the **Outbackers**, gangs, warriors and adventurers that roam them, they still have the capacity to speed travel and smooth out rides that would be difficult and slow without four-wheel-drive vehicles. The roads also serve as signs and paths to the struggling wilderness communities scattered across the land. Follow a **road**, and sooner or later (usually later), one is likely to come across a nearby town, shabby settlement, farm or outpost.

Characters with this skill can identify roads by name, use roads to help pinpoint their location, map out routes across the country, determine the safety of a road or region, find a shortcut and even predict who or what is likely to be found along particularly notorious roadways and regions. The skill is not just limited to the old roads either, it also applies to the new routes that have been forged by continuous travel or built by regional communities. Note that the skill is most effective on the character's home turf — the 200 mile (321 km) radius where he grew up (+20% for roads in that region). **Base Skill:** 26% +4% per level of experience. Note: City dwellers, even Military Troops, other than specialized "Military Scouts," are **-14%** on this skill, if they bother to take the skill at all.

**Spelunking:** The art of exploring and climbing underground cave systems. Australia, more so than most other countries, has a wealth of magnificent caves which continue to draw curiosity even in the world of *Rifts*®. This skill enables the character to navigate a cave or underground cave network, retain a sense of direction (including up **and** down), have a sense of the cave's depth, know how to make subtle markings and note formations to find his way out and to better navigate the cave(s) at a later date, as well as rock climbing. The **Spelunker** can answer questions about a cave system, such as what it is called (if it is a named landmark), where it *may* lead, how deep it continues, what type of rock it leads through and so on. This skill also lends familiarity with the correct equipment needed to go spelunking, and how to apply it. Characters *without* this skill have about as much chance surviving underground as they would climbing a mountain without information or equipment. **Base Skill:** 35% +5% per level experience. Add +5% if the character also has the climbing skill.

---

**Use Songlines:** Ley Lines are called "Songlines" by the Aboriginal people, and are said to lead to what have been recently called the "Demon Gates," but what used to be thought of as sacred points in the land (Nexus Points). However, the Aborigines have a very deep understanding of the Songlines, to the point where they can use and "read" them in a similar way to a Ley Line Walker. The Aboriginal will literally *sing* over the landscape, using a very complicated code of notes and words combined with a ritual dance called the *Corroboree*. The Ley Lines pick up the songs and store them as resonant vibrations, so that anyone with the Songlines skill can tune into the magical energy and use them for the following effects:

**1. Land Navigation.** The character can see, in his mind, the terrain on and surrounding the line, up to one mile (1.6 km) on either side of the line per level of experience. This knowledge includes any towns or settlements, and the presence of caves, forests, water, notable landmarks and similar things necessary for land navigation.

**2. Stories.** Information about past events that occurred on or near the line can be picked up by the song line reader. These stories are typically limited to major or significant events (in the scope of **Dreamtime**) such as whether there was once a great battle or evil done on or near (within one mile/1.6 km) the line, past geology or weather (a pond or water hole once existed, a great storm once swept away a village, an underground stream is located in the general area of ... and so on), as well as events in-

volving "the people" (Aborigines) and whether supernatural demons or monsters have passed through the area recently, or linger along the line, or whether there is a Demon Gate (ley line nexus) along its length, and where it is. These stories will also warn of impending Ley Line Storms, natural storms or an opening of a Demon Gate, provided such an event will occur within the next 24 hours (cannot see beyond 24 hours into the future). Events and stories involving the Aborigines, the land, wildlife and Dreamtime spirits are considered major events.

3. Find Caches. The user of a Songline can hide caches of food, supplies or weapons within one mile (1.6 km) anywhere along the Songline/ley line. He can find these locations at a later date without fail and without needing to search for them or leaving any sort of tell-tale marker. Furthermore, the moment he reaches a songline, he can sense whether or not the cache has been disturbed and looted by others. Note that listening to Songline stories *may* reveal the general location of large caches left by others (small caches and those with food are considered insignificant), however, finding somebody else's cache will require performing the Corroboree for 1D4 hours while listening to stories and then another 1D4 hours of searching to find the exact location of the cache.

4. Find Hidden Sources of Water. Like **divining**, if water exists along the line, the songline will describe it, and provide the general direction and general location.

5. Determine Distances. The precise length of the line and the exact distance of settlements and major landmarks on or near the line can be determined, provided the character knows about them.

6. Telling & Transmitting Stories. This skill can be used to tell a story to an individual or group audience (from a handful to thousands), anywhere on the songline, even if they are many miles away. This is a one-way transmission from the Corroboree dancer and singer to that particular group.

Base Skill: There are two levels to the Songline skill. First is the correct execution of the Corroboree at a base skill of 30% +4% per level of experience, and the second is for the translation and interpreting of the impressions/stories/information transmitted by the Songline at 20% +2% per level of experience. Note: All Aborigines are +20% to the understanding of the songs and stories they receive. City folk can *not* learn this skill.

---

## Weapon Proficiencies

A note about Weapon Proficiencies (**W.P.**): Each W.P. provides combat training with a particular type of weapon. The result is hand to hand combat bonuses to strike and parry whenever that particular weapon is used. All bonuses are cumulative. Each W.P. counts as one skill. The character may select several W.P.s or a few. Note: Characters without a W.P. *can* use any weapon, but without benefit of the W.P. bonuses.

W.P. Boomerang. (First presented by Erick Wujcik in **Mutants Down Under™**). An aerodynamic curved throwing "stick" that is the Aboriginal technological equivalent of the bow and arrow. Some can be no larger than a foot (0.3 m) long, others can be almost man-sized and require two hands to launch, but most range between 1-3 feet (0.3 to 0.9 m) long. There are many variations, some designed to return to the thrower if the shot misses, others designed purely as throwing sticks intended to inflict damage and which fall flat if they miss.

**Bonuses to strike:** +1 at first level, with an additional +1 at levels 3, 5, 7, 10 and 15.

**Bonuses to Damage:** +1 to damage at 2, 5, 9, 11 and 15.

Combat Notes: The boomerang is a hunting weapon. Nonetheless, this is an **RPG**, and boomerangs make pretty cool weapons (see the equipment section for more), and players are likely to try all sorts of tricks.

1. In all cases, opponents are at *-2 to parry and dodge* boomerang attacks, as they are highly unpredictable missile weapons difficult to avoid and defend against (trust me, I know from experience). Add this penalty to other penalties that may apply from special attacks.

The boomerang can be employed in several different ways:

2. Thrown with a slight curve so that it returns if it misses. In such a case, the range is 150 feet (45.7 m). To make a boomerang return, a character *must* have this W.P. Such trained individuals can throw those designed to return to come back to them when they miss. The process of returning uses up one melee action worth of time, during which the character can perform something else (aside from moving).

3. Straight Shot. Thrown with full force, the range is an incredible 600 feet (183 m). The boomerang will not return. +2 to damage from the velocity of a fast moving, full force boomerang. If the victim is within 100 feet (30.5 m), he is -4 to parry or dodge the attack.

4. The Back Shot is a particularly tricky method of attack. The boomerang is thrown with full force, but curves to return toward its thrower and strike a target on its return, from the opposite side. The maximum range is 250 feet (76.2 m), and the target is -8 to parry and dodge due to the element of surprise. This can even catch someone hiding behind cover if the thrower is aware of the hiding target and can accurately estimate where to strike. The difficulty of this attack means the throw is made without benefit of *any* bonuses and is -3 to hit the hidden target.

5. Bounce Shot. Thrown at a down angle, the boomerang appears to fall short then rises before hitting the ground and strikes the victim from below. The attack has the element of surprise and can be disorientating, so the intended target is -4 to parry and dodge. If the roll to strike is 16 or higher, an opponent will be knocked off his feet by the attack (as well as suffering damage) and loses two melee actions. A successful "roll" vs punch, fall or impact will prevent the knockdown, but uses up another melee action.

6. Ricochet Shot. The W.P. also enables the character to use any type of boomerang to ricochet off one object or person and hit a second! This ricochet or bounce-off attack is done without benefit of any bonuses other than those from this W.P. Damage is inflicted to both targets struck. The second target struck is -4 to parry or dodge.

7. Trying to Catch a Boomerang thrown by somebody else. Wily opponents may *attempt to catch* a boomerang thrown at them, with a successful parry roll that scores 18 or higher, but the character must make the "call" that he intends to try to catch it, must drop or holster anything in his hand, and the "catch" uses up two melee attacks/actions. Do not discourage this tactic, but catching a full velocity boomerang is NOT recommended. A successful catch uses up two melee actions and a failed catch means the character is struck and takes normal damage. This hurts.

**W.P. Flamethrower:** A modern weapon proficiency (obviously), employed sparingly by many Outbackers and City-goers. Due to fuel shortages and the dry countryside (thus, the risk of *bushfires*) *it is not a weapon used very often. However, in the barren deserts the road gangs have embraced them with vigor. They can mow down the opposition, and be used to deny an area with flames. Scorchers, as they're often referred to, are sometimes found turret-mounted on trucks and larger vehicles to deter highway raiders on motorcycles (or in cars - flames don't discriminate). In the blistering heat of the desert, a flamethrower is a good fear weapon. Nobody wants to get burnt when they're burning in the sun already. As such, a flamethrower in the hands of a character with this skill has an effective Horror Factor of 10. Note that the city governments sometimes also employ this weapon as a fear tactic - they can threaten Outbacker communities with flamethrowers, as a single bushfire can wipe out hundreds of square miles of country. Bonuses to strike* are as per modern weapon proficiencies, but aimed shots are impossible. **Special Rule:** Flamethrowers inflict damage regardless of body armor, unless the armor is fully environmental and sealed. Otherwise the flames lick exposed flesh and body armor alike, inflicting half damage to the wearer and half to the armor.

**W.P. Grappling Hook:** Trained use of a grappling hook for climbing, scaling walls (adds +5% to that skill), boarding vessels, tripping an opponent (by hooking the foot, ankle or leg. Does no damage, but knocks victim to the ground and he loses initiative and one melee attack) and impaling (does 1D6 damage). +1 to strike or entangle at levels 3, 6, 9, and 12. This weapon *cannot* be used to parry!

**W.P. Net:** Primarily a gladiator or slaver's skill, the net is used to trip an opponent (same as grappling hook), parry or snare/entangle. **Bonuses:** +1 to strike or entangle at levels 2, 5, 8, 11, and 15. +1 to parry at levels 2, 4, 6, 9, and 12.

In addition to the regular *entangle attack*, there are two other types of attacks possible with a net:

*Snaring an opponent's weapon:* The weapon becomes entangled and is pulled out of the opponent's hand. A natural, unmodified (no bonus) roll of 18, 19, or 20 will disarm an opponent in this way, unless he can roll an equally, unmodified high parry (no bonuses).

*Snare one's opponent by throwing the net over him:* The intended victim must *dodge* or be netted — only characters with a spear, pole-arm or staff can *parry* a thrown net attack. If caught in the net, the victim is -8 to strike, -10 to parry and dodge, and running is impossible. It will require 1D4+1 melee rounds to cut **free of the net**.

If the character dodges or the net thrower misses, it is the net wielder who will suddenly find himself weaponless. Even if the net has a drawstring attached to it, the thrower will need one melee **action/attack** to pull it back to him or to grab a different weapon; the throwing of a net to capture an opponent requires the use of two hands. However, if the net is being used to **parry**, entangle or whip an opponent, it can be used with one hand, while the other wields a sword or other weapon; parry the same as usual. Using the net as a whipping weapon does 1D4 damage.

**W.P. Spear:** Spears are perhaps the most important weapon of all to the Aborigines. They are also a very common weapon in many other cultures. **Bonuses to strike** are +1 at 1st, with an

additional +1 at 2nd, 4th, 6th, 8th, 10th, 12th and 14th levels. Maximum throwing range is 150 feet (45.7 m), unless a woomera is employed. A *Woomera* is a unique tool which **Aboriginal characters may use if they have skill with a spear. It is a hand-held length of wood with a channel cut into its length, which is then used to fling the spear with a catapult motion. Difficult to use. -1 to strike, but range is doubled.**

**W.P. Whip:** Skill at "whipping" or snapping with long, flexible weapons typically made of leather, rawhide, reeds or M.D.C. cords.

**Damage:** Single cord whip: 1D6 S.D.C., Bull Whip: 2D6 S.D.C., Cat-0-Nine Tails: 2D6 S.D.C.

**Bonuses:** +1 to strike, disarm, or entangle at levels 2, 4, 7, 10, and 13. +1 to damage (special) at levels 2, 4, 8, and 12. This weapon *cannot* be used to parry! An M.D.C. whip still inflicts S.D.C. damage, but is more resistant to damage.

**W.P. Note:** Vehicle Mounted Weapons are considered Heavy Weapons.

---

## Monsters and a few Animals

---

A Note to G.M.S. More than any other **Rifts**® setting, Australia is possibly the one most poised on oblivion. Willpower alone is keeping human society above water. The lack of high-powered weaponry and minimal magic makes demons and other supernatural beings very, *very* dangerous, indeed. Magic spells, magical weapons and advanced weaponry are required to kill such awesome creatures, so go easy on the players if they're not up to it. There are some S.D.C. monsters listed here as well. Don't write them off as weaklings — some of them are quite capable of threatening even the hardiest of adventurers.

### Notable Monsters

Desert Worm

Giant Cockroach

Giant 'Dwombat

Giant Kang

Razorback

Sand Fiend

Also see Demons & Spirits.

## Desert Worm

Unwary travelers that stray too far from the roads or hard rock into the softer sandy deserts may fall victim to Desert Worms. These monsters are probably creatures from another dimension that have found a home in the warm and salty deserts of the Australian Outback. They are very large, upwards of 300 feet (91.5 m) in **length**, and covered in scales. They are faceless except for a huge gaping mouth that opens to swallow victims from the surface. The desert worms are **carnivorous**, but they can digest anything, including the car which held their lunch! Some may compare them to the Blow Worms (a *Worm of Taut* found on the Palladium World), but they are in fact a completely different species.

They tunnel through the sands about 100 feet (30.5 m) below the surface, and avoid getting too close to hard earth and rock. Their scaly armored bodies are covered with tiny hair follicles

that allow them to sense vibrations on the surface, even down to a man walking softly. Once movement is detected, the monster burrows upward to surprise the victim from below. Fortunately, unless the target is large (the size of an ox or automobile), the Sand Worm is likely to miss by a foot or two, giving its intended prey a chance to **dodge**, flee or fight back. It is the last thing many a traveler expects, but most Roadgangers and desert people have learned how to avoid and deceive them using vibration devices as distractions and jury-rigged seismic scanners as detectors. Such devices are quite commonplace in the sandier regions, and a vibration maker and seismic scanner will cost about \$800 to trade for or \$300 to build from a kit.

These worms surface only to feed. If they get involved in a battle, they will usually **breakoff**, go underground and wait 1D6 minutes before trying to surprise their feisty, potential meal once more. If prey is too combative, the giant worm will abandon its quarry and go underground and move on or wait for easier prey; Desert Worms rarely fight to the death. The horrid monsters generally avoid packed earth and stone, but can sometimes be seen laying on rocks or on top of the sand to sun themselves. They cannot be eaten by humans (make them sick) and their light M.D.C. skin does not cure well and becomes a brittle, impractical S.D.C. hide.

### Desert Worms

Also known as the Dragon Worm and Scaly Worm.

**Inspired by Ideas in Mutants Down Under by Erick Wujcik.**

Alignment: Non-aligned; essentially anarchist.

Disposition: This is a single-minded creature whose only interest is food and survival. While many eccentric nomads have compared the Desert Worm to the gentle whales of the distant ocean, most see them as predators to fear and avoid.

Attributes: **I.Q.** 1D4 (very low animal intelligence), **M.A.** 1D4, **M.E.** 1D6, **P.S.** 2D6+50, **P.P.** 1D6+6, **Spd** on the surface **1D6+12**, but burrowing underground is twice that speed.

Horror Factor: 15. This is due to their intimidating size and surprise attack method.

Size: 100 to 200 feet (30.5-61 m) long; there are rumors of some reaching as big as 300 feet (91.5 m) long.

Weight: 5 +2D4 tons.

P.P.E.: 3D6.

Hit Points and S.D.C.: None, an M.D.C. creature.

M.D.C.: Equal to the creature's length in feet (.3 m) plus **1D6x10**. So a 200 foot (61 m) worm would have 200 plus **1D6x10**M.D.C.

I.S.P.: None

Magic: None

Psionics: None

Natural Abilities: Sense vibrations up to 200 feet (61 m) away with 80% chance of zeroing in on the source, track by blood scent 60% (through tiny olfactory openings beneath the hairs). Underground, can prowl with 60% proficiency! Regenerates 1D6 M.D.C. per hour and can completely regenerate a missing tail or hunk out of its body within a few months.

Special Attack and Vulnerability: Swallow whole. On a surprise attack, or during combat, a natural roll of 19 or 20 means the giant Desert Worm swallows its victim whole, so long as the target is no wider than 10 feet (3 m) or taller than 15 (4.6 m). When swallowed whole, a completely unpro-

tected character will digest within 1D4 melee rounds, so powerful are the worm's digestive acids! However, if the character is protected by armor, he has 1D4+3 minutes before the acid eats through his armor (loses 15% of its M.D.C. per minute). This means he may attack the worm's innards and literally blast, cut or punch his way from the inside out. Damage done while inside the worm is multiplied by two, and a hole large enough for a man to crawl out of takes only 30 M.D.C.! However, the Desert Worm will coil and writhe in pain, knocking the character inside off his feet and taking twice as long to climb out. The Worm has no safeguards from attacks inside its gullet and can be, comparatively easy to kill using this tactic.

Attacks per Melee: Two (2)

Damage:

Bite — **1D4x10** M.D.

Head Butt — **3D6** M.D.

Body Ram — **1D6x10**M.D.

Ground Thump (with tail or by emerging through the sand and into the air, then crashing down again) — **1D6x10** M.D. crushing damage to anything underneath the area of attack. Also, everyone within 50 feet (15.2 m) of the creature will have to roll with the impact or be knocked down, losing initiative and one **attack/action**.

Bonuses: +2 on initiative, +1 to strike, +2 to dodge, no parry is possible, +7 to save vs poisons, +3 to save vs psionics, and is immune to Horror Factor. All bonuses are in addition to attribute bonuses.

Known Habitat: Sandy deserts. Lone hunters, although they frequently gather in loose packs of 3D4. When one draws blood, the others are alerted and may join the hunt.

Value: None.

Enemies: Large predators, pack hunters, monsters, and humanoids.

Allies: Not applicable; impossible to domesticate and control.

## Giant Cockroaches

It has long been stated that if anything living will survive a global holocaust, it will be the cockroach — a grotesque, soft-shelled beetle-like insect that scavenges for waste and remains. It thrives in hot and humid climates, and is therefore, very well suited to flourish in the Australian environment. In Rifts Australia, the one variety of cockroach takes on a new menace in the form of a mutant, giant cockroach species. Actually, the term "giant" is a bit misleading, because while some can get as big as 10 or 12 feet (3-3.6 m) long, the majority measure 2-5 feet (0.3 to 0.9 m) long and weigh 3-10 pounds/0.9 to 4.5 kg), only about 25% ever reach or exceed man-size. The **bushland** roaches **can** be anywhere from 3 to 8 feet (0.9 to 2.4 m) long, while the ones found in the polluted outskirts of the cities are larger, averaging 5-10 feet (1.5 to 3 m) in length. Unsubstantiated reports and "**tales**" of truly giant wilderness roaches as big as 20-25 feet (6 to 7.6 m and with a extra **1D6x100**S.D.C., and 200 pounds/90 kg in addition to the usual amount) that roam the desert sands, caves, or rain forests of the least inhabited wilderness regions continue to persist, although its unknown if they are true. It is said these creatures feed on human and animal corpses and attack living creatures that are incapacitated, injured or ill, as well as babies. These stories have circulated for **centu-**



ries, but most people consider them folk-tales and myths (**Note:** Whether these critters make an appearance is left entirely up to the G.M.).

The Giant (mutant?) Cockroach has the same basic appearance, behavior and diet as the common household insect, but on an enormous scale. Giant Cockroaches are nocturnal and cowardly, fleeing from any danger that may threaten them. In the case of larger giant roaches, however, it can take a lot of noise or physical attacks to scare them away from a meal. And while nocturnal, they can come out in artificial light or day time. Vision, day and night, is poor, so the insect relies on an acute sense of smell. They have a low intelligence and live to feed, breed, and multiply. The greatest danger they represent is eating or spoiling (with their own waste) human food supplies and crops, particularly grains, nuts, fruits and vegetables. They can also get in the way, frighten (and distract) people as they scurry by, as well as clogging machinery and make annoying noise as they scrape, dig and fumble for food — they are a common sight in and around Outback towns, especially at garbage dumps. They also sometimes dig up graves to eat the recently deceased.

As large, disgusting insects, many people actively destroy them on sight. Some **scavengers**, nomads and people living around the cities and in the Outback eat them as a source of protein and claim they tastes reasonably good — Aborigines only eat the Giant Cockroach occasionally. These insects will usually be encountered at night while they are foraging for food.

Exposure to bright light can leave night-feeders dazed for a few moments (1D4 melee rounds), hence their preference to ab-

solute darkness. During the day, the majority tend to remain inactive, but some do come out in daylight. The secret to avoiding these big bugs is not leave waste (animal carcass, garbage, food, etc.) out in the open and to keep an area as clean as possible; cockroaches of all sizes are attracted to waste and decaying food.

Although comparatively light M.D.C. creatures, Giant Cockroaches are difficult to kill. Unless they are totally destroyed, their bodies regenerate slowly until they are fully restored. Missing legs and wings, mangled bodies and other injuries mean little to these resilient insects.

Giant Cockroaches roam all parts of the country, though they are particularly prevalent in the bushlands and large Outback communities (O! Sydney Town is plagued with them and locals amuse themselves with "roach hunts"). They tend to stick close to human settlements where they can sort through and feed on waste, garbage and leftovers, including human and animal remains. The dumps, sewers and alleys of the Outback towns and outpost are often a breeding ground for these distasteful creatures. Surprisingly, the modern cities are fairly free of cockroaches, because their aggressive control programs see that these pests are exterminated whenever and wherever they are found. However, the polluted wastelands and squalid shanty towns and villages around the cities, are infested with the creatures and harbor some of the largest Giant Cockroaches one will ever encounter. Tribal communities are fairly free of cockroach problems, because most of these communities are reasonably clean, dispose of waste properly, have no large scale buildings

to invite hiding places for such **creatures**, and their nomadic ways, moving from place to place, also serves as a deterrent to cockroach infestation.

## Giant Cockroach

**Alignment:** Non-aligned; essentially Anarchist.

**Attributes:** I.Q. (very low insect intelligence), M.A. 1D4, M.E. 1D6, P.S. 1D6+3 per foot in length, P.P. 1D6+10, P.E. 1D6+24, Spd: Running 2D6+18 or flying (short distances under a mile/1.6 km), 2D6+30. P.S. and P.E. considered to be supernatural.

**Hit Points:** 2D6 +20 per foot (0.3 m) in length. A cockroach is truly only dead when its Hit Points have been reduced to -30.

Otherwise they have a chance to use their super-regenerative ability. See natural abilities below.

S.D.C.: 3D4x10; +80 points if between 7-10 feet (2.1-3 m) long, +200 if larger. **Note:** Roughly equal to an M.D.C. of 2-8.

**Natural Armor Rating:** 12 for a tough, leathery exoskeleton.

**Horror Factor:** 12. This is more a revulsion than a fear, as these creatures are pretty gross, but, as a rule, not very threatening.

**Average Size:** 2-10 feet (0.6-3 m) long, and one fifth of this in height, but some reach 20+ feet (6+ m). Roaches vary in coloration from a light brown to a matte black.

**Average Weight:** 80-300 pounds (36-135 kg), with the largest weight two or three times that weight.

P.P.E.: 1D4, or 1D6+1 in the larger monsters.

I.S.P.: None

**Magic:** None

**Psionics:** None

**Natural Abilities:** **Nightvision** to 400 feet (122 m), track by scent 82%, swim 50%, and climb 98/95%. About a third of the cockroaches have wings and may fly; their exoskeletons open up to sprout a double layer of wings like a ladybug (only not *nearly* as attractive), allowing the giant insects to fly in short bursts for up to one mile. Super Regeneration: the Giant Cockroach regenerates all lost Hit Points within 2D10 minutes of being reduced to zero or less. Also, lost S.D.C. is recovered at the rate of 2D6 per minute. Remember that the creature is not dead until it falls to -20 Hit Points.

**Vulnerabilities:** Light: when in darkness and exposed to bright light, the Giant Roach is penalized by -6 to the Spd and -2 to dodge. Bright lights include flares, naked sunlight and spotlights.

**Attacks per Melee:** Three

**Damage:**

Nip with Mouth — 2D4 S.D.C.

Bite — 1D6 M.D.

Claw Strike — 1D6 M.D. +supernatural P.S.

Body Block/Tackle — 5D6 S.D.C., plus P.S. bonus if any.

Flying Body Block (only winged roaches) — 1D6x10 S.D.C., plus P.S. bonus.

**Bonuses:** +2 on initiative, +1 to strike, +2 to dodge, no parry, +10 to save vs poisons and disease, +4 to save vs psionics, and +1 to save vs magic. All bonuses are in addition to attribute bonuses.

**Value:** None per se. This is a single minded creature whose only interest is food and survival. They are sometimes kept by Outbackers as pets, raced (several different types of races,

including one where a rider stands on a pair of small, cat-sized roaches, one for each foot) and used for amusement (hunts, chases, tricks to scare people, etc.) and as a walking garbage disposal.

**Enemies:** Large predators, pack hunters, monsters, and humanoids.

**Allies:** Not applicable; impossible to domesticate, but can be prodded, herded and reasonably controlled.

## Giant 'Dwombat

This creature is an enigma to most scholars, and a brute to be feared by all. The *common* wombat has often been disregarded as a cute little furry creature, a burrowing animal with a gruff demeanor. However, for some reason, some (approximately 10-15%) have grown into giant mutants bigger than an elephant! The **Jackaroos** have nicknamed them the "bulldozers of the bush," because the largest can grow to be over 40 feet (12.2 meters) long and 10 to 15 feet (3 to 4.6 m) tall and they have a nasty habit of running through things! They are solid and muscular, weighing 10-25 tons depending on their age and size. Most are **black**, but sometimes a very dark brown. They are covered in a dense fur which ripples with their power. In all respects they are giant wombats, but like the Rhino-Buffalo of North America, they are Mega-Damage creatures — dense muscle alone makes them veritable juggernauts.

It's not just their size that makes them dangerous, they have a temper when they need one, and will charge and head butt strangers whenever they are startled, frightened or angered, and sometimes for no particular reason at all. However, the greatest danger they represent is that they are incredibly destructive. There have been stories told of entire communities that were devastated when only a handful of 'Dwombats ran *through their* village like runaway bulldozers, leaving a path of destruction in their wake has devastating as a tornado. 'Dwombats tend to thunder through the Outback in never-ending stampedes that leave very obvious swathes in the wilderness: trampled (or eaten) grass, broken (or eaten) tree branches, toppled trees, chipped and battered rocks and upturned earth are their calling cards. When disturbed while feeding, they will simply charge the nearest annoyance and head butt, bite, or trample it or just chase it away before going back to feed. They are very simple, instinctive creatures who are not so much a predator threat as 15+ tons of stampeding and devouring nuisance.

'Dwombats are herbivores. They eat trees, grass and crops (grains, vegetables and garbage being *their* favorites). This can be a huge problem for Outback farmers who can lose an entire crop to a single 'Dwombat "eating machine" in a matter of a week or two. As pests they devour crops, raid grain and produce storage houses (may even try to gnaw through or dig under M.D. structures to get into a storage bay), damage property, and nest in and around the garbage dumps of Outback towns. Being Mega-Damage creatures and so big, they don't feel threatened by man and often ignore puny, little humans trying to shoo them away or shooting at them with S.D.C. weapons that have no affect on them. Fortunately, they only attack **humanoids** when they are attacked first, injured, cornered or feel threatened. Equally fortunate, is that 'Dwombats are usually encountered as lone individuals or in small groups of 2-6.



'Dwombats are generally slain whenever possible in an attempt to reduce their population and prevent crop damage. They are also hunted for **their** meat, fur and bones. Their meat is reasonably tasty and a single adult animal can feed a town for a week. The hides can be prepared and used as **superdurable** fabric that literally wears like iron (a cape, cloak, poncho or set or clothing has the equivalent of 200 S.D.C. or two M.D.). The bones and teeth are harder and stronger than any wood and are excellent for making tools and components for weapons and tools. A few ambitious ranchers have tried to tame the Giant 'Dwombat using them as riding animals (Horsemanship: Exotic Animals) **and/or** using them as **livestock**, slaughtering them at a young age and small size (about the size of a cow). **However**, the Giant 'Dwombat make a poor riding animal (and eats too much to keep till full maturity) and difficult to keep as **livestock**, because they chew through or dig under most pens.

So what is the Giant 'Dwombat — also known as the Bulldozer of the Bush and 'Dozer Wombat? Nobody knows for sure, but according to Aborigines, the return of magic and the reblossoming of the Dreamtime has created many new **animals**, recreated many old monsters and changed some **that** we thought we knew. Since animals are believed to be bom from the thoughts of **men**, the Aborigines have speculated that the nightmares, emotions and fears of the white fellas have given birth to many of the strange creatures that now populate Rifts Australia — some of them horrendous, others quite curious, like the 'Dwombat and **Kang**. They also believe that some of the demons are attracted by the thoughts, fears and foul emotions of whites and D-Bees.

A more scientific view point is that radiation from ruptured power plants or alien radiation that leaked through dimensional portals **and/or** the magic energy that pulses through the continent is responsible for the mutant Giant Wombats and many other mutations, including human mutants. This mutating influence has turned the robust little badger or ground hog like creature into a living tank. Some City-evolutionists claim the wombat grew in size to survive the Apocalypse and to withstand the supernatural predators that have since emerged. But evolution usually doesn't happen that quickly unless it is helped, so mutation is the more likely answer.

When players character encounter a 'Dwombat, and anybody wandering the Outback *will*, sooner or later, the event is likely to be preceded by a slight trembling in the ground which grows with intensity until the sound of crashing trees is added. Suddenly the rumble becomes a roar, and in a shower of wood and earth the enormous creature will rumble past (or through). If the players come across a feeding (or sleeping?) 'Dwombat, they would do best to tip toe quietly around it.

### Giant 'Dwombat

**Also known as** Giant Wombat, 'Dozer 'Dwombat and Bulldozer of the Bush.

**Alignment:** Animal, generally considered Anarchist.

**Disposition:** Stubborn to oblivious. They are single-minded creatures who simply charge about the landscape with seemingly nothing on their mind. When not on the run, they are eating, sleeping or playing. As noted before, adults don't even consider humans to be a threat until they blast them

with M.D. weapons or magic, but they are spooked by large vehicles and explosions.

**Attributes:** I.Q. 1D4+1 (low animal intelligence), M.A. 1D6, M.E. 1D6+2, P.S. 2D6 +32, P.P. 1D6+8, P.E. 2D6+22, P.B. 1D6+6, Spd **2D6+18** can run double that rate of speed in spurts lasting **1D6+6** minutes when panicked or on the run.  
M.D.C.: Baby: 6D6, Young: 3D6x10, Adult (30 **ft/9 m** or longer): **1D4x100+180!**

**Horror Factor:** 8 for an individual, 12 for a group of three or more. People tend to freeze up with a mix of fear and simple disbelief at the sight of this creature, sometimes more in fear of the destruction they may cause than the animal itself. Those who keep their wits about them when facing a stampeded can usually dive to the side and avoid getting bumped or trampled by the **creature(s)**; needs a dodge roll of 12 or higher.

**Average Size:** 10-15 feet (3 to 4.6 m) tall, 30 to 42 feet (9-13 m) long. Young are roughly half that size.

**Average Weight:** 12-25 tons.

**Life Span:** Approx. **1D6+10** years; reaches full maturity in two years. Babies start out the size of a hog weighing **100 lbs** (45 kg). Born in litters of **1D6**, with three being the average.

P.P.E.: 6D6

I.S.P.: None

**Magic:** None

**Psionics:** None

**Natural Abilities:** Run, dig, **nightvision** to 200 feet (61 m), swim 50%, track by scent 55%, and heal at a rate of about 2D6 M.D.C. per 24 hours.

**Attacks per Melee:** Three

**M.D. Damage:** Note that young do roughly half the damage listed.

Front Paw Strike — **1D4x10** S.D.C.

Light "Tap" with Nose or Paw — 4D6 S.D.C.

Bite — **1D4** M.D.

Claw Strike — **2D6** M.D.

Rear Leg Kick — 4D6 M.D.

Head Butt — **4D6** M.D.

Charging Head Butt — **1D6x10** M.D. plus anything weighing less than six tons is knocked off its feet and sent flying **2D6x10 yard/meters**, take an additional 1D4 M.D. from fall impact and loses initiative and 1D4+1 melee attacks/action! To charge, the giant needs at least 50 yards/meters for a running start. Counts as two melee attacks.

Trample — 2D6 M.D., squashed by its feet and low slung belly as it runs over whatever comes in its way. At the G.M.'s option, the victim of this can roll with the trample and take only 6D6 S.D.C. This represents curling up for protection, or (humorously) being pressed into a soft patch of ground by the creature's passage.

**Bonuses:** +1 on initiative, +3 to strike, +1 to dodge, no parry, +2 to save vs poisons and toxins, and +2 to save vs Horror Factor. All bonuses are in addition to attribute bonuses.

**Value:** Varies with the needs of the wilderness community. For some, the animal is a godsend good for eating, clothes and making tools, perhaps even to be raised at livestock or as a riding animal or for labor (pulling a plow, digging, demolition, etc.). For such communities the animal, when under control, may be worth as much as \$2,000-6000. Meanwhile, for others, the creature is worthless vermin that is shot and discarded.

**Enemies:** Large predators, pack hunters like Giant **Kang**, monsters, and **humanoids**.

**Allies:** Not applicable; is difficult to domesticate and control.

**Known Habitat:** Can be found anywhere throughout Australia but typically where food is plentiful, like the Rim and around Outback communities where crops and garbage is available.

## Giant Kang

By Kevin Siembieda

Although many people assume this animal is a giant mutation of the native Australian kangaroo, it actually a similar looking animal from another dimension. However, like the kangaroo, it has adapted to Rifts Australia and thrives. Unlike the kangaroo, the Giant Kang is a predator that hunts in packs. Most agree that the Giant Kang, almost single-handedly, keeps the Giant 'Dwombat and Giant Cockroach populations in check. Those two animals are the **Kang's** favorite prey, with the soft, vulnerable humanoids and livestock next on their list.

However, the Giant Kang have learned that humans have a bite all their own and quickly break off attacks on humanoids who exhibit **firepower** or magic. In fact, they often avoid enclosed vehicles and aircraft entirely, especially if there are two or more, and keep away from Songlines (i.e. ley lines). However, being very aggressive predators, some Giant Kang will test the mettle of humans even when in groups or in caravans of vehicles, backing down only when their potential prey exhibits weapons or magic. The boldest ones (typically in groups of 2-6) will even prowl the streets of a town or city under the cover of night, preying on **cattle**, horses, livestock or feeding on garbage. They have also been known to snare and run off with the occasional pet animal and town drunk.

The Giant Kang are very smart and instinctively use group tactics to bring down their prey. They attack in teams and waves, separate one or two from the **herd**, lay in ambush, prowl and strike by surprise, etc. Their society is very similar to wolves, with one dominate male being the lead animal, his mate second in command and a pecking order based on raw strength and boldness for the rest. A typical "pack" will have **10-20 animals**, although there are smaller groups (3-8) and the occasional larger group (30-50), but the latter is very rare. Their numbers seem to be kept in check by availability of prey. The less prey, the fewer and smaller the packs, the more plentiful the prey, the larger and more numerous they are, bolder too.

At a quick glance, the Giant Kang appear to be giant tiger-striped kangaroo, however, closer inspection show they have striped fur, sharp teeth and large saber-tooth fangs used for cutting and slicing up fallen prey. They have good hearing and an excellent sense of smell, both of which they use in hunting. Their fingers and toes are clawed and used for slicing and ripping at prey, and their bite is savage.

**Surprisingly**, the frightful animal domesticates well and has been adopted by Roadgangers and some Outbackers as riding and guard animals. Domesticated Giant Kangs show surprising loyalty to their masters and will attack anybody who hurts them while in their presence. As a riding animal, they are much smoother than one may think and are similar to that of a galloping horse rather than a hopping rabbit or kangaroo. They have





excellent speed for an animal (a bit faster than most horses) and leap a good height and long distances. The main things a rider has to get used to is the sudden turns, changes of direction, and stops the Giant Kangs can make in a heartbeat. They also have a natural tendency to make full speed leaps over obstacles.

### Giant Kang

**Also known as** Monster Kang and Roadganger Kang.

**Alignment:** Animal predator, generally considered Anarchist or Miscreant.

**Disposition:** Aggressive and excitable. They are pack hunters who work well in groups and can be reasonably well trained as guard or attack animals and especially as riding animals that work as a **pack/gang**.

**Attributes:** I.Q. 1D4+3 (medium animal intelligence), M.A. 1D6+6, M.E. 1D6+6, P.S. 2D6+20, P.P. 1D6+18, P.E. 2D6+18, P.B. 1D6+10, Spd 2D6+54 (roughly 40-45 mph/64-72 km) and can run double that rate of speed in spurts lasting 1D6 minutes, typically when pursuing prey (can run in a super-charged spurt 1D4+1 times per hour). P.S. and P.E. are considered to be supernatural.

M.D.C.: Young: P.E. attribute number +1D6x10; Adult: P.E. attribute number +2D6x10.

**Horror Factor:** 8 for an individual, 15 for a group of four or more. **Average Size:** 6-8 feet (1.8 to 2.4 m) tall and 6-8 feet (1.8 to 2.4 m) long from head to rump. Add another 5-7 feet (1.5 to 2.1 m) for the tail, giving the average Giant Kang an overall length of 11-15 feet (3.6 to 4.6 m). Young are roughly half that size. Note that about 15% grow 30% to 40% larger

and are capable of carrying two or even three human-sized riders.

**Average Weight:** 1000-2000 pounds (450 to 900 kg).

**Life Span:** Approx. 2D4+16 years; reaches full maturity in about a year and a half. Babies start out the size of a piglet weighing 10 lbs (4.5 kg); typically born in pairs (15% are singles, 20% are triplets).

P.P.E.: 5D6

I.S.P.: None

**Magic:** None

**Psionics:** None

**Natural Abilities:** Run at good speed for 1D4+2 hours without needing rest, can leap 10 feet (3 m) high and 15 feet (4.6 m) across (double with a running start), **nightvision** to 200 feet (61 m), swim 45% (but dislikes swimming in water), track by scent 60% (+15% to follow a blood scent), and heal at a rate of about 2D6 M.D.C. per 24 hours.

**Attacks per Melee:** Five

**M.D. Damage:** Note that young do roughly half the damage listed.

Slashing **Bite/Nip** — 1D6 M.D.

Stabbing and Tearing Bite — 3D6 M.D.

Claw Strike — 1D4 M.D. + damage equal to punch from supernatural P.S.

Head Butt — 2D6 M.D.

Tail Swat — half the M.D. done by a **punch/claw** strike.

Leg Kick — 6D6 M.D.

Leap Kick — 6D6 M.D. plus anything weighing less than two tons is knocked off its feet and either sent flying 2D4x10

**yard/meters**, or is stomped into the ground! In either case, the victim takes an additional 1D4 M.D. from fall or impact and loses initiative and two melee attacks/action. The leap kick requires a running leap (needs at least 20 **yards/meters**) and counts as two melee attacks.

Bonuses: +3 on initiative, +3 to strike, +2 to parry, +4 to dodge while running, +2 to pull punch or bite, +3 to roll with punch, fall or impact, +1 to save vs poisons and disease, and +4 to save vs Horror Factor. All bonuses are in addition to attribute bonuses.

Value: Varies with the needs of the wilderness community. Many fear and avoid the Giant **Kang**, but others have successfully domesticated the animal and use them as pets, watchdogs, attack animals and riding animals. **Roadgangers**, especially certain gangs and clans, love to use the Giant Kang as a riding animal and many have a vehicle and a Giant Kang for transportation — the animal is ideal in rugged country and when fuel is not readily available. However, the Roadgangers aren't the only ones to use the Giant Kang (and sometimes the Giant 'Dwombat and Cockroach) as an exotic riding animal, the Runabout, Jackaroo and Bushranger are also known to occasionally ride the Giant Kang (some preferring them over a horse). Likewise, other Outback folk sometime ride the kangaroo-like creatures. The animal is also fairly good eating, although the meat tends to be a bit tough and chewy, best prepared in a stew. Its fur and hide make a very durable, long wearing leather ideal for boots, gloves, whips and heavy ponchos; weighs three times more than normal leather, but wears 10 times longer (a poncho will have 110 S.D.C. or one M.D.C.). The teeth, especially the sabered ones, are worn as jewelry, carved into art and used as ornaments on vehicles and body armor.

For those who use the Giant Kang as a guard or riding animal, a tamed animal is worth \$500-\$1000, if just for meat and fur, \$100-\$200.

Enemies: Large predators, other pack hunters, demons, and humanoids.

**Allies:** Not applicable; can be domesticated as noted previously.  
Known Habitat: Found primarily in the Australian plains and deserts, but can be found in small packs almost anywhere on the continent.

## Razorback

The Razorback is a hideous monster from another world, although Aborigines insist it is a mutation of a natural pig that has since been warped by radiation and magical energy produced by the Coming of the Rifts.

When **pre-Rifts** Australia was discovered centuries before the Apocalypse, wild pigs were released onto her soil as a food source. This, along with the release of other animals and the planting of coconut trees, was a quite common tactic to ensure a steady food source for shipwrecked sailors or passing ships with low supplies. The concept was sound, but was ecologically disastrous. From a direct point of view, unbalanced food supplies and demand made the foreign animals released into the wild pests and a danger to the ecosystem. Even before the Coming of the Rifts, there was a persistent Outback myth of the "Razorback": A *wild boar* with a fiery temperament and stubborn disposition, that was able to shrug off bullets and arrows, and could

charge its attackers with tusks and tenacious, muscular power in what can only be described as rage for having been attacked! Is it little wonder then, that the story (and fear) of the Razorback may have given rise to the monster that Bushmen and Aborigines alike fear in the wilds of Rifts Australia today?

As far as the Aborigines are concerned, the Razorback monster exists because it is in pain. They not only fear, but pity the abomination. As all creatures are part of the spirit, the Rainbow Serpent and the **Dreamtime**, they are at peace. Even the 'Dwombat. Even the other alien and mutant animals are at peace with the **world**, but the Razorback is not. It is a false (introduced) creature, and as such, has no spirit, no connection to the land. According to the Aborigines, when the magic returned to the world, and the Dreamtime was strengthened, the wild pig agonized because it had nothing to reawaken to, so it became a hideous monster. An animal with a killer instinct and a taste for blood, capable of destruction and bloodletting wherever it goes.

The **Razorbacks** of Rifts Australia are fearsome creatures indeed. Standing five feet (1.5 m) tall at the shoulder, four feet (1.2 m) wide and sometimes more than nine feet (2.7 m) in length, they are solid, muscular beasts that radiate an overall presence of menace and power. The head is set deep into their enormous shoulders on a short, stout neck. The eyes are said to be like two smoldering black coals, red at the center. They reflect the beast's fiery aggression and burn with an unbridled bloodlust and rage. The long, snarling mouth is filled with sharp teeth, dominated by two oversized, curved, yellowed tusks that protrude from the lower jaw. Razorbacks are given a reason for **their** name in the world of Rifts, because from the top of their shoulders, along their spines to their tail is a line of razor-sharp fins. When not in an aggressive or defensive state, the blade-like fins lie flush along the creatures' flanks. However, when angered, threatened or perturbed in any way, these protrusions rise up and point forward. A favored tactic of these cunning and **frighteningly** intelligent creatures (high animal I.Q.) is to charge its prey or to run, brushing its body against its foe and literally slice him to pieces without ever biting or goring with its tusks. Animals or **humanoids** who try to pounce upon or grab and hold the monster are stabbed or sliced by the blade-like fins — making it impossible to hold onto the slaving beast that is likely to be jabbing and tearing with its tusks as well as biting or clawing.

Razorbacks are never placid and will often attack without provocation or warning. Many will attack regardless of being outnumbered, typically targeting one or two specific individuals in a group or herd, before running off or moving on to the next victim. These monster boars are also known to stalk a specific group or individual and engage in cat and mouse games, vandalism, and acts of retribution or vengeance such as slaughtering horses or **livestock**, destroying food or water containers, and so on, all part of its vicious "games." Razorbacks also use hit and run tactics against formidable foes and large groups, traits that make them seem more intelligent and human-like than they really are. In fact, many will swear that the animal enjoys terrorizing his enemies and victims before he strikes, and some have been positive that the animal was "out to get them."

Razorbacks are nocturnal animals, but need very little sleep (about 4 hours a day). They are incredibly alert even when resting or sleeping, and always quick to take action. When startled, their first instinct is to charge and kill. Anybody who catches



their attention or who strays too near is subject to attack. Unlike most predators who hunt for food and kill in self-defense, Razorbacks kill for pleasure. Unprovoked attacks on **humanoids** are without justification and most (80%) do not eat **humanoid** meat. However, those that become "man-eaters" rarely choose to hunt or eat anything else, and are dangerous in the extreme.

Whenever an adventurer finds himself at a deserted farm or ranch (especially if there are the remains of slaughtered livestock), or an area of country devoid of wildlife — few birds singing, no tree kangaroos loping away or snakes rustling in the bushes, he should presume to have wandered near the lair or hunting grounds of an especially aggressive pack of **Razorbacks**. Most animals have learned to give these monsters as much room as possible and stay away from the lair.

Despite their wild and murderous nature, Razorbacks rarely attack vehicles and large robots, and seem to have an innate sense about supernatural creatures and creatures of magic, thus open **conflict** with demons and dragons, and often avoiding practitioners of magic as well. Instead, they favor easier prey and target children, women, unsuspecting travelers, horses, livestock and most other non-predatory animals. However, they are not cowards and will usually accept a challenge from any animal or humanoid who dares to offer it. Popular Outback stories tell of cars being ripped open to expose the driver and passengers who are slaughtered before they can exit. There are also accounts of full conversion cyborgs and armor clad adventurers being attacked, their suits of **M.D.C.** armor torn open like **paper-mache** to get at the person inside. However, many of these

accounts are rare occurrences or scary stories told over a crackling **campfire**. Most cyborgs and power armored individuals can handle one to a half dozen Razorbacks, and, as noted previously, these creatures rarely attack large, enclosed vehicles; one and two man **hovercycles**, motorcycles and open top vehicles are the only ones vulnerable to attack.

In addition to hunting and killing for sport and pleasure, the **Razorback** also has a voracious appetite and will eat half its weight in food every day or two. They will eat anything they kill, but will also eat carrion, steal the kill of other predators and rummage through garbage or crops to eat fruits, vegetables, grains, lunch meats, scraps and just about anything that is remotely edible. Being carnivorous, anything it kills is a potential food source, but the monster may not eat what it kills, depending on its appetite and disposition.

Razorbacks are fairly widespread. They appear in many places, both inland and along the coast, in the wilderness and scavenging among the garbage dumps and littered alleys of ramshackle towns and fledgling cities. They are never found in the deepest deserts, and infrequently found in marshlands or the densest parts of rainforests, preferring instead to dwell in grasslands, scrub, **bushlands** and light forest. The monsters' appearance varies slightly with the terrain it inhabits. The fur is typically a tan or light brown, but some, especially forest dwellers' fur, tends to be grey or dark brown in coloration.

Razorbacks tend to be solitary creatures that either hunt alone or as a mated pair or gather in small packs of 3-6. For reasons **unknown**, mated pairs are seldom seen, probably because the

male does not stay with the female after he has "done his duty." A female will give birth to **1D4+1** piglets and will fight to the death to protect them. A young Razorback reaches maturity in **16** months.

This predator is very stubborn, aggressive and tough, but this also makes them uncaring for their own safety. When provoked, many will fight to their death. In combat, they rush in headfirst, literally. They get in close and overwhelm their opponents with their size, weight, and ferocity, tackling them and goring them to death with their tusks, all the time biting and kicking and trampling with **their** hooves. Attempts to tussle with this creature most often result in the loss of **limbs**, if not **one's** life. The blade-like fins protect everything except its belly and lower flanks and give the horrid beast yet another weapon. Many a Razorback will roll around on the ground in an **attempt** to slash, cleave and impale its opponent. An encounter with a Razorback is always a bloody affair. And there really is no such thing as a contest against a Razorback, it is always a desperate life and death struggle to escape alive.

## Razorback

Also known as the Demon Boar.

Alignment: Generally considered to be Diabolic evil.

Attributes: I.Q. 1D4+4 (high predatory animal), M.A. 1D4, M.E. 2D6, P.S. 1D6+28, P.P. 1D6+14, P.E. 1D6+20, P.B. 1D4+2, Spd 1D6+30. P.S. and P.E. are considered supernatural. M.D.C.: P.E. attribute number +2D4x10 and an additional 4D6 M.D.C. per year of age.

Life Span: Approx. 1D6+12 years; reaches full maturity in 16 months. Born in litters of **1D4+1**.

Horror Factor: 13 against an individual, **16** when facing a pack of 3 or more.

Average Size: 4-5 feet (1.2 to 1.5 m) tall at the shoulders, 7 to 10 feet (2.1 to 3 m) long. The raised blade-fins add another foot or two (0.3 to 0.6 m) to the overall height.

Average Weight: 800 to 1000 pounds (360 to 450 kg).

P.P.E.: 3D6

Magic: None

Psionics: None

Natural Abilities: **Nightvision** to 60 feet (18.3 m), prowl 50%, swim 55%, track by smell 60% (+25% to follow a blood trail), land navigation 90%. Heals at a rate of about 1D6 **M.D.C. per 24 hours**.

**Attacks per Melee: Five**

### Damage:

Head Butt — equal to punch damage from supernatural P.S.

Bite or Swipe with Tusk — 1D6 M.D.

Stab and Rip with Tusks — 3D6 M.D.

**Stomp/Kick** with front legs — equal to punch damage from supernatural P.S.

Rear Leg Kick — equal to punch damage from supernatural P.S. +1D6.

Blade Swipe — 1D6 M.D.

Blade **Charge/Ram** — 5D6 M.D., but counts as three melee attacks and may only be performed once per melee round.

**Berserker Attack** — 1D6x10M.D. but uses up all melee attacks, and not only inflicts damage but either pins the opponent (loses one attack) or knocks him down, causing the victim to lose initiative and two melee attacks/actions. This is a frenzied attack in which the Razorback grunts and squeals and becomes focused

on killing its opponent. The only way to avoid this is to dodge or parry and knock the fiend away with a shield or spear.

Bonuses: +4 on initiative, +2 to strike, +1 to parry (using tusks **and/or** blade-fins), +2 to dodge, +3 to save vs poisons, +2 to save vs magic, +1 to save vs psionics, immune to Horror Factor, mind control and possession. All bonuses are in addition to attribute bonuses.

Value: Little. The meat is tough and unpleasant, but edible.

Tusks and blade-fins are used to make or enhance homespun body armor, as well as to make M.D. axes (2D4 M.D.) and knives or spear tips (1D4 M.D.), or to decorate a vehicle. Maximum value is \$100 to \$200. Can not be domesticated or tamed.

Enemies: Humans and anybody or anything that gets in its way.

Allies: None, other than members of its own kind.

Known Habitat: Mostly **scrub, bushlands**, light forests, and ancient ruins, sometimes found around a town dump or demon's lair.

## Sand Fiend

Sand fiends are other-dimensional aliens disgorged from a dimensional Rift and have since set up homes in the hot sands of the Australian deserts. They are predators with animal instincts that lurk below the sand and consume anything that passes over them — from lizards to **humanoids**. They are not related to the Desert Worms in any respect, as they do not move or shift about in the sands. In fact, there really isn't an Earth equivalent animal that comes to mind.

The average Sand Fiend is close to 30 feet (9.1 m) in diameter and roughly circular. The entire upper part of the creature is a giant mouth with literally thousands of rows of teeth. When something living passes **overhead**, it opens and convulses in a gulping action to drop the prey inward and down into its funnel-shaped body that extends another 30 feet (9.1 m) underground. The massive tooth-filled maw can devour a truck or Giant 'Dwombat, although the victim is typically swallowed whole and ground up if he tries to climb out, otherwise it is digested in the gullet. Sand Fiends can move, but they rarely do. It is assumed that they are migratory, and shift their positions with the seasons, but no one has ever paid close enough attention to find out such detailed information.

An encounter with a Sand Fiend will almost always be a surprise attack, although they do sometimes rest with their mouths open to allow small animals such as birds, snakes, lizards, rodents, etc., to come into their maw only to be gulped up. Even when closed, an observant traveler should notice that the ground in front of him is suddenly changed and has an unusual texture. More often than **not**, it is those traveling at night, or who are running, or driving a vehicle through the desert who suddenly find themselves being swallowed up.

The Fiends never grow, no matter how much they consume, which leads people to believe they may be some sort of supernatural being or creature of magic. Some have even suggested they are immortal, although the truth of the matter is that they probably live 300-600 years. As unbelievable as it may seem for a complex being, Sand Fiends are asexual and believed to reproduce spontaneously by dividing into two separate, full grown creatures, once every two decades or so. The only way to stop



their overtaking of the deserts is by hunting them down and destroying them, which is not easy.

Once engaged in combat, there is very little the Sand Fiend can do. It will huff and puff, and blow sand, causing grit to get into the eyes of those without goggles or environmental suits, as well as rumble and shake the sand around it. Its most deadly and frightening attack is to lunge out of its burrow and snap at one or more of its enemies. The Sand Fiend can lunge approximately 10 feet (3 m) without leaving the safety of its hole, but is slow and ponderous, with only three attacks per melee round and a pathetic speed. To run away, it must crawl out of the borrow it has dug (which takes 1D4 melee rounds) and slither across the land at about five miles per hour. The thing is smart enough to know that climbing out only makes it more vulnerable so it is more likely to simply close its gigantic maw and hunch down in its hole, hoping that its attackers will eventually assume it is dead or get tired and leave. The rows of teeth serve as a M.D.C. barrier (like trying to shoot through six airlocks sealed one after the other) and the deep sand all around its body protects it against most energy blasts from pistols and lasers (takes dozens and dozens of blasts to punch through tons of sand in order to get to the creature). The most efficient modes of attack are aircraft that can fire from the sky, out of the reach of the Sand Fiend and the use of missiles and explosives (they do double damage if dropped into the maw and detonate inside the beast).

## Sand Fiend

**Also known as** "Chompers" by Outbackers.

**Alignment:** Generally considered Anarchist or evil, but is really a quiet and docile predator from another world.

**Horror Factor:** 16 from a surprise attack; observers from a safe distance only suffer a Horror Factor of 10.

**Attributes:** I.Q. 1D6 (low animal intelligence), M.A. 1D4, M.E. 1D6, P.S. 3D6+25, P.P. 1D6+12, P.E. 1D6+20, P.B. 1D4, Spd. 1D6+5 crawling across the sand, or 1D6 underground through the sand.

### M.D.C. by Location:

Individual Tooth (approx 3D4x100+800) — 1D6 each

Closed Mouth with teeth barrier — approx 1800

Main Body — 1D4x100+44

**Size:** 20-30 feet (6 to 9 m) in diameter at the mouth, tapering in as one goes down to the tail, with an overall length of 25-35 feet (7.6 to 10.7 m).

**Weight:** 3-6 tons

**Average Life Span:** Unknown, at least several hundred years.

P.P.E.: 2D6x10

I.S.P.: M.E. number x8; typically around 24-30 points.

**Magic:** None

**Psionics:** Limited. Presence Sense, Sense Magic, Sense Time, Mind Block, and Empathic Transmission (a limited defense because of the low amount of I.S.P.).

**Natural Abilities:** Sense vibrations up to 100 feet (30.5 m) away with 77% proficiency, blending to sand 90%, and bio-regenerate 1D4x10 M.D.C. per 24 hours, and regrows teeth as needed within a week. Also see Psionics.

**Attacks per Melee:** Three

**Damage:**

Nip — 6D6 M.D.

Bite — 1D6x10 M.D.

Chew/Grind — 2D6x10 M.D.

**Bonuses:** +3 on initiative, no dodge or parry possible, +10 to save vs poisons, impervious to toxins, needs a 12 or higher to save vs psionic attack, and is immune to Horror Factor, mind control and possession.

All bonuses are in addition to attribute bonuses.

**Value:** Virtually none. The meat is putrid and poisonous to humans, and only the teeth have any value for making simple, dagger-like M.D. weapons (1D6 M.D.), or to decorate armor or a vehicle. Maximum value is \$1-\$2 per tooth (large quantities of teeth can bring the value down to pennies apiece). Can not be domesticated or tamed.

**Enemies:** Humans and anybody or anything that gets in its way.

**Allies:** None.

**Known Habitat:** Only sandy deserts.

---

# Demons & Spirits

---

By Ben Lucas & Kevin Siembieda

## Demons

### Bunyip

Devil Dingo

Mopaditis (undead)

Vampire: Classic

Vampire: **Garkain**

Vampire: **Yara Mayha Sho**

**Wandjinas**

Yowie

## Gods/Spirits

**Bunyil**

Rainbow Serpent

**Tikilik**, the Frog Demon

## Bunyip

The Bunyip (pronounced bun yip) is a **Dreamtime** demon that is as much a part of Australian lore and mythology as cave paintings and Songlines. The Bunyip is the quintessential fear-monger that elders tell children about to scare them at night. Where European myth has trolls living under bridges, Aborigines have the Bunyip lurking in water holes, ready to lure people to **their** death.

The habitat of the Bunyip is water. While it is perfectly capable of surviving on land, it prefers to lurk in billabongs, swamps and rivers, slightly below the surface, where it can leap forward to surprise and drag away its prey. This is the basic horror that surrounds the Bunyip. Tales from survivors of encounters with the fiend report a hulking monstrosity, who at first, seems to be nothing more than a strange reflection vaguely visible under the water's surface. Often as one peers into the watery depths, the creature looms forward, water draining from its body, its fangs protruding from a horrid smile as it reaches for its next meal.

The appearance of the Bunyip can vary greatly. Being a very arcane and deadly creature, there are few reports that coordinate to give it a single form. By piecing together stories and accounts, it can be determined that the Bunyip has several distinguishing features. Firstly, it is very large, upwards of 20 feet (6.1 m) tall and long. Secondly, it is vaguely **humanoid** in that it has arms, a head above its shoulders and walks on two legs. The similarity ends there, because the Bunyip has a long, thick tail like a fish or a lobster, huge claws on its hands, webbed toes and



fingers, and an enormous, dog-like maw with eight-inch fangs. It also has ears like a kangaroo, and glowing yellow eyes that stare intently at their victim. The **Bunyip**, therefore, has a very horrific and mismatched appearance. The demon also has a very distinctive cry — a tremendous roar that can be heard over great distances and during and after rain storms. It has a loud yet shrill undertone, sending shivers of fear down those who hear it, even from miles away. For reasons unknown, the demon howls and wails during rain and ley line storms, especially the most violent ones.

The Bunyip demon has a definite feeding cycle. Its preferred food is Aboriginals, preying on the weak and defenseless, like women and children. It can handle warriors, but the demon is lazy and would rather target easy prey, plus it knows that slaying women and children causes more grief than slaying a warrior. It is also known to attack and eat white settlers and D-Bees, having an appetite for all mortal **humanoids** and striking whenever opportunity arises, but Aboriginals are singled out more than others. A twisted and cruel monster, the Bunyip will sometimes leave a cadaver half-eaten where others can find it, either as a warning or to cause sorrow. Other times it drags the rest of the meal away to rot slightly in a still pool of water so it can finish it later. It also lines its lair with the bones of its victims.

This demon's presence can jeopardize an entire **community's** precious supply of water, because it will attack those who come near it, and pollute the **billabong** with rotting corpses of those it kills. Thankfully, **Bunyips** rarely venture far from their watery domain, knowing prey has to come to them. When water starts

to dry up in the summer seasons, the Bunyip will hibernate. It will spend the last few months of winter and the first few weeks of spring stocking up its fat supplies, eating and storing food. When it has eaten all it can, the Bunyip then buries itself in the mud under a **waterbed** and sleeps until the water becomes plentiful again. This unusual pattern leaves a superstition with most Aboriginal tribes about crossing dry mud flats, on the chance that a Bunyip may be sleeping under the surface. While they are hard to wake, they *will* wake when disturbed, and the demon will be very angry about having its hibernation interrupted.

Little else is known about the Bunyip, other than that they have always existed, being a demon that has hunted mankind since the ancient times long before the Coming of the Rifts. Aboriginals often explain that low levels of magic and the irrigation and unnatural water management systems of the past had nearly caused the extinction of the Bunyip before the Apocalypse. But the return of magic, the crumbling of civilization and the return of the wild meant the monster was free to hunt again, and so its numbers have grown. Nobody knows how their numbers grow, as Bunyips are solitary creatures **and**, as demons, are assumed to be immortal. The Bunyip also shows no gender. The superstitious hold that the Bunyips are born of the evil intent of mankind, and dig their way from deep under the earth, attracted by the stench of evil and chaos. In truth, while they *maybe* attracted to the Earth by such emotions, they emerge from Songlines from the Australian spirit **world**, through the nexus points. Such is the way of most demons.

A typical encounter with a **Bunyip** can happen a few ways. The most common is for it to wait patiently underwater and drag any individual who comes to collect water to his death. When particularly hungry, the Bunyip will stalk an entire group by sliding along the bottom of a river, following the travelers or hunters until they stray close to the **shore**, or even stalking them on dry land. Although the demon dislikes venturing more than a few miles from its watery haven, they can be found up to 50 miles (80 km) from water. The Bunyip has the power to make itself two-dimensional on the bed of a body of water, and uses this to hide or to stalk its prey by sliding along the bottom, even when in only a foot or two (less than a meter) of water! The Bunyip rarely confronts a powerful foe or directly assaults a well armed opponent unless provoked or seeking revenge. It is a hunter and a predator, that enjoys killing.

## Bunyip Demon and NPC Villain

Race: Lesser **Dreamtime** Demon

Alignment Diabolic. This demon is a deadly predator who cares only about its next meal. It has no plans and lacks the intelligence to formulate ideas beyond how to lay an ambush and how to trick prey into inaction. The Bunyip is cunning, but only as much as a smart dog or a carnivorous dinosaur. It is not possible to reason or talk to the Bunyip. It cannot communicate, other than through its horrendous roar.

Attributes: **I.Q.** 7 (roughly equal to a cunning animal predator), **M.E.** 1D6+7, **M.A.** 1D4, **P.S.** 1D6+27, **P.P.** 1D6+17, **P.E.** 1D6+21, **P.B.** 1D4, **Spd** 1D6+27; double when swimming. **P.S.** and **P.E.** are supernatural.

**M.D.C.:** 2D6x10+150 (on **S.D.C.** worlds the demon has **1D6x10**+90 Hit Points and **1D6x10**+50 **S.D.C.**, and an **A.R.** of 11; increase to 13 when in or under water).

**Horror Factor:** 15. The sound of the creature's roar also has a Horror Factor of 15 the first time it is heard.

**Size:** 10 to 15 feet (3 to 4.6 m) tall, and 20-30 feet (6 to 9 m) from the head to the tip of the tail.

**Average Life Span:** Uncertain, 2000+ years; may be immortal.

**P.P.E.:** Base of 2D4x10+12.

**Natural Abilities:** **Nightvision** 1000 feet (305 m), infrared vision to see in murky water and **darkness**, good day vision, and can look out of water to the surface without distortion. Swim at **98%**, prowl at 45% (+30% underwater), climb at 70%/60%, leap 15 feet (4.6 m) high and 20 feet (6 m) across, land navigation at 94%, impervious to disease and cold, and bio-regenerates 6D6 **M.D.C.** per minute. Can breathe underwater and in the air, can survive depths of up to one mile (1.6 km) and can dive up to 600 feet (183 m) deep. The Bunyip is not very knowledgeable and is not literate, and cannot even speak any understandable language beyond growling, grunts, mumbling and roaring.

Become **Two-Dimensional** (special). This ability is fundamentally the same as the Temporal Spell of *D-Shift Two Dimensions*, except the Bunyip can perform it at will without spending its **P.P.E.**, and maintain its 2-D form for an indefinite period of time.

This is a dimension altering magic that turns the demon (self only) into a flat, two dimensional image, like a piece of paper or a painting on a wall! As a two-dimensional being, the character cannot be detected by **thermo-optics**, heat, motion and most other sensors. The two-dimensional image of

the demon is also difficult to see or recognize (hide 85%). Furthermore, the character is one sixteenth his normal weight and mass and can effectively stick himself on the floor or to the sides of caves, rocks, walls, doors, etc, or, as is a common tactic of the Bunyip, to the floor of a shallow body of water, often near a beach or shore where it can watch for prey and surprise it by transforming into a giant three-dimensional monster in the blink of an eye (transformation counts as one melee **attack/action**). The water demon can also slide along the bottom of a lake or other body of water to look for, follow and stalk prey.

The two-dimensional monster is still vulnerable to most forms of physical attack and environmental conditions, including fire, heat, cold, wind, energy blasts, magic and psionics. The character is especially vulnerable to wind and can be blown great distances like a piece of paper caught in the wind. Physical blows from weapons, punches, and explosions inflict half damage when the character is **stuck/braced** against a wall, floor or other mass. Gases and fumes also inflict half damage and drugs that must be ingested or injected have no effect.

As a two-dimensional being the demon can *not* move, speak, eat, **drink**, or cast magic, but the Bunyip can float and via telekinesis, move along the lake bed. One's perspective of the world is also distorted making the judgement of distances impossible, limiting vision to one narrow direction (no peripheral vision) and time seems to move very slowly.

**R.C.C. Skills:** **None**, other than those noted under natural abilities.

**Magic:** The Bunyip has some natural magic powers, but can not learn new spells or intentionally draw **P.P.E.** from other sources. Often it will unintentionally draw energy from freshly killed victims, but this is not a conscious decision so much as a happy coincidence. All spells are cast as if by a 7th level sorcerer:

**Thunderclap**, Heavy Breathing, Impervious to Fire, Chameleon, Death Trance, Invisibility (superior), Fear and Repel Animals (all found in the *Rifts*® RPG).

**Psionics:** Considered to be a minor psychic (needs 12 or higher to save) and is limited to Telekinesis, Empathy, Sense Time, Sense Magic, and Mind Block.

**I.S.P.:** **M.E.** x3.

**Vulnerabilities:** **M.D.** fire, plasma and magic fire does double damage (none if magically made *impervious to fire*, a tactic that startles many overconfident assailants).

**R.C.C. Combat: Attacks per Melee: Five**

**Damage:** Punch and Tail Swats are equal to Supernatural **P.S.**; bite does 4D6 **M.D.**

**Bonuses:** +5 to strike, +3 to dodge/parry, +4 to roll, +3 to initiative, immune to all toxins, +8 to save vs. all forms of magic, +3 to save vs. psionics, immune to Horror Factor.

**Allies:** None, although can sometimes be forced into service by greater demons, gods and Shifters.

**Enemies:** Non per se. Humans and other humanoids are regarded as dinner, not enemies.

**Value:** None; the carcass of a slain Bunyip turns into a pool of foul smelling, black muck within 2D6 seconds after it is slain.

**Habitat:** The Inland Sea (near the coastline), lakes, rivers, ponds, swamps, or any body of water that has more than a



few hundred gallons of water. The demon can also be encountered at wet dump sites, damp caves, and subterranean networks (sewers, catacombs, and underground rivers throughout Rifts Australia).

## Devil Dingo

A creature of Australian bush legend, the Devil Dingo is a sinister fiend. According to legend, Devil Dingo was originally made by the animals as a form of protection, but something went wrong, and now he haunts all men and terrifies the living. His mission on earth is to terrorize the animal spirits and spook them into inaction — to run and hide — as well as breed fear and paranoia among all lesser beings. Hunters curse the Devil Dingo for frightening away prey, and Elder Aboriginals and **Kwarla** preach awareness of this evil and cunning demon who takes pleasure in giving birth to fear and spreading like a plague to sweep the land.

People who have seen the Devil Dingo will babble uncontrollably about his form, but will never manage to give a clear description. By most reports, the demon's favorite appearance seems to be that of a giant, fur covered humanoid who stands 8-12 feet (2.4 to 3.6 m) tall, and has the head, coloring and features of dingo. The eyes are horrible human eyes (red) that pierce and freeze the soul with a malicious, sinister and gleefully evil intent. When angry or casting spells, they crackle with light blue magical energy. Some also claim he can haunt them in their dreams.

While legend says the Devil Dingo's goal is to frighten animals, humans and other intelligent beings, the monster's favorite targets, animals, are victimized either for malicious fun or to manipulate them, like scaring herd animals to cause a stampede, commotion, trouble or panic. The Devil Dingo is something of a psychic vampire who soaks in the terror he finds in animals and people. This is why he likes to breed fear in lesser beings, and often lets his victims go free (to flee in terror after wetting themselves). Not only is the level of fear strong and delectable, but the demon enjoys the game. He likes people to fear him and do bad things out of fear for their life, panic or stupidity — and fear breeds all these things, and more. The Devil Dingo delights when people are afraid to leave their home or **campfire**. He is thrilled by their running away in terror or pleading for their lives. But using fear to make people betray, hurt and kill others ... ah, that is an art that the Devil Dingo prides himself in as "master."

A true master of fear and suspense, the fiend likes to build tension that brings his victims to the brink of pure terror, and, if lucky, madness. The Devil Dingo does this through a number of ways, including rumor, innuendo, threats, warnings, frightening glimpses, making shadows and noise, leaving a corpse, blood or dismembered body part for chilling effect, causing people or things to disappear (hit and run tactics leading to the questions: "Where is **he**?! Why does he do it? Why won't he leave us alone?" etc.) and other tactics that frighten and build terror or crush the human spirit. He also knows how to determine and exploit a person's fears, playing them against him.

When out for blood, the Devil Dingo likes to divide and conquer, separating members of a family or **group**, and picking



them off one by one. Best of all is when the demon can create dissension among the group, so they may actually start fighting amongst themselves and miss opportunities to escape or strike back. Devil Dingos are playful in the most sadistic and malicious sense. When **provoked**, they are merciless, bloodthirsty killing machines who leave a trail of dead bodies in their wake. The lifeless, mauled bodies drained of their life's energy to feed the demons' psychic hunger and lust for revenge. In fact, it is the Devil Dingo's rage that is his greatest weakness, for when provoked to physical combat, the creature often forgets to use his magic powers and lashes out at his opponent with tooth and claw. Great legends have been told of warriors who have defeated the Devil Dingo through bravery, not showing their fear (showing a Devil Dingo no fear drives the demon wild) and causing his own enraged folly.

But fear is not all the Devil Dingo thrives on. He is a deceitful, double-dealing, cunning and scheming wrongdoer who likes to manipulate, mislead and use others for the purposes of evil, fear and chaos. To this end, the demon likes to manipulate others to do his bidding while he lurks in the shadows as the real culprit or mastermind. This also means the Devil Demon likes to command and use lesser demons, monsters, practitioners of magic and any fool willing to work for him or take his advice. As a master of fear, the brute will often coerce those too terrified to defy him to do as he demands, often holding a loved one hostage or threatening to kill them, or worse. There is a story of a **Mabarn** who summoned a Devil Dingo so that the demon would teach some white men a lesson for swindling the tribal people out of some land. The Dingo taught the men not to **deceive**, then killed them, feeding on their fear first. Then, resenting being forced to do the dirty work of a mere human, the Dingo returned and killed the Mabarn, whose spirit haunted the surrounding lands for years to come. Such is the workings of this diabolic mind.

### Devil Dingo Demon & NPC Villain

**Note:** The Devil Dingo makes an excellent long-term villain. He is a wonderful tool for the **G.M.** to use to lead the player group into danger and adventure, terrorize the group, and come back time and time again — or send assassins, pawns and minions — in an attempt to get revenge upon them, or to destroy them completely.

Even if the encounter is incidental to the overall **plot**, he makes an excellent background character that may, at any moment, reach out and bite the players - literally! Or instigate trouble (and adventure) that ultimately involves our heroes in some way.

**Alignment:** Miscreant or Diabolic.

**Disposition:** Devil Dingo is cunning and vile. He likes to taunt and plan his victims' demise. Sometimes he can be fooled by wily negotiators, but more often than not, he is merely pretending and either manipulating them or setting them up for a fall. If somebody does not fear him, he will usually be angered, but, at first, will try to do things to frighten them. If that fails, the monster is likely to become so frustrated or angry that he lashes out at them, forgetting subtlety and cunning. If attacked, however, whether provoked or not, he usually runs away to fight another day (or to extract vengeance from afar or in the shadows), as most Devil Dingos value their own lives above all else.

**Race:** A Greater Dreamtime Demon.

**Attributes:** **I.Q.** 1D6+12, **M.E.** 1D6+12, **M.A.** 1D6+20, **P.S.** 2D6+30, **P.P.** 2D6+12, **P.E.** 2D6+12, **P.B.** 1D6+12, **Spd** 1D6+48 (approximately 35 **mph/56 km**). **P.S.** and **P.E.** are supernatural.

**M.D.C.:** **4D4x10+113** (on S.D.C. worlds the demon has 3D4x10+33 Hit Points and **1D6x10+30 S.D.C.**, and an **A.R.** of 10).

**Horror Factor:** 15

**Size:** Varies with the form he assumes. Usually about 8 to 12 feet (2.4 to 3.6 m) tall or long.

**Weight:** One ton.

**Average Life Span:** Uncertain, **1000+** years; probably immortal.

**P.P.E.:** Base of **2D4x10+50**, but it drops by five points per day unless the Devil Dingo feeds on P.P.E. from a living source. He needs to feed before it reaches zero or he will cease to exist on this plane. P.P.E. is acquired from the victims he kills and drains of P.P.E. or frightens and draws upon. The fiend gets one P.P.E. per person, per 24 hours by creating fear in them.

**I.S.P.:** 2D4x10+70

**Natural Abilities:** **Nightvision** 2000 feet (610 m), track by smell 60% (+25% to follow a blood scent), leap 15 feet (4.6 m) high and 20 feet (6 m) across, impervious to disease and cold, and bio-regenerate **1D6 M.D.** per melee round.

Knows all Languages: Magically understands and speaks all languages 90%, but cannot read.

Limited Metamorphosis (special): The Devil Dingo can turn into the giant, monstrous, **humanoid** dingo described earlier (his favorite form), or as a malformed human with ears like a Dingo, long fingernails, long wild hair, and canine teeth, or the head of a dingo (usually assumed to be a **Phreaker** or some kind of mutant), or a giant, demonic dingo, four feet (**12 m**) tall at the shoulders, with a slavering mouth, and glowing red eyes.

In all cases, the demon can maintain his "false" appearance indefinitely — hours, days, weeks, or months. However, they are likely to maintain such a charade only as long it is fun for **them**, i.e. they can continue to cause trouble, fear, etc.

Become Ethereal (special): The Devil Dingo can also become ethereal at will, appearing as a ghostly mist in its **humanoid-dingo** form. While in the manifestation, the demon can not use any of its magical or physical attacks but can use many of its psionic powers, except for Mentally Possess Others and Hypnotic Suggestion. Likewise, the demon is only vulnerable to psionic attack, mind affecting magic, and magic weapons. Speed as a mist is half normal, and cannot float more than 10 feet (3 m) into the air. This power is typically used to "spook" people, issue warnings and make good an escape (wispung under doors, through cracks, etc.).

**Reoccurring Horror Factor 15 (special):** At the beginning of a new combat round, the Devil Dingo bares its fangs and growls. This blood-curdling snarl plays on the fear inherent in the demon's opponent and all who see the snarl must roll to save vs Horror Factor. This attack can be repeated at the beginning of every melee round, but costs the Devil Dingo one melee action/attack.

**R.C.C. Skills:** Horsemanship (exotic animals), Basic Math at 94%, Surveillance Systems (tailing only), Blend, Land Navi-

gation, Track **Humanoids**, Wilderness Survival, Swim, Dance, Prowl, Anthropology, and Seduction, all at 75%. Plus select three skills from each of the skill categories: Rogue and Technical (lore and law skills only); all get a +15% skill bonus. Also see Natural Abilities, above.

**R.C.C. Combat: Attacks per Melee:** Six by hand or psionics, or two by magic.

**Damage:** By supernatural P.S., although a claw strike adds 2D6 M.D., and a bite does 3D6 M.D.

**Bonuses:** +5 on initiative, +2 to strike, +1 to parry and dodge, +6 to pull punch, +2 to roll with punch, fall or impact, immune to disease and toxins, +1 to save vs all forms of magic, +6 to save vs possession, and +7 to save vs Horror Factor. R.C.C. bonuses are all in addition to any possible attribute bonuses.

**Magic:** All Devil Dingoes can cast the following spells at 6th level proficiency: Chameleon, Mask of Deceit, Fool's Gold, Death Trance, Escape, **Teleport** (Lesser & Superior), Calling, and a total of 1D4+2 spells of choice selected from common wizard spells. Selections can be made from Spell levels 1-6.

**Psionics:** A Master Psionic (needs a 10 or higher to save). Has the powers of Induce Sleep, Astral Projection, Clairvoyance, Object Read, See Aura, Sense Magic, Telepathy, Empathic Transmission, Hypnotic Suggestion, Mentally Possess Others, Radiate Horror Factor, and Mind Block Auto-Defense. Plus the *Mind Bleeder* powers of Bleed Memory, Brain Bleed, Day Dream (except it is NOT pleasant) and Mind Trip; these are favorites.

**Enemies:** All mortals, particularly humans, are regarded as pawns and playthings. Those who defy or challenge them are their enemies. Greatly dislike non-Australian demons even if they are subservient.

**Allies:** Others of its kind, other demons, powerful practitioners of magic, and other powerful beings with agendas that involve terrorizing, manipulation, torture and mayhem.

**Value:** None

**Habitat:** Can be found almost anywhere, but tends to favor the **bushlands** of the Outback. Although mainly found in Australia, the Devil Dingo is one of the few Dreamtime Demons to have found its way to the surrounding islands, **Tasmania**, New Zealand, Jakarta and Indonesia.

## Mopaditis, Undead Spirit

According to ancient Aboriginal myth, when an Aborigine wanders into the wild and dies, never to be discovered or buried in the correct manner, his corpse rots away and his spirit resurrects itself to become a wandering ghost. The story behind the "Mopaditis" (pronounced mope **uh** die **tis**) is actually quite tragic, because their only wish and purpose in the world is to make a friend to accompany them into the afterlife where they might find peace. However, to do so they must take the spirit of a living being as their companion, which ultimately kills the victim.

However, the so-called Mopaditis of Rifts Australia is more than this — it is a terrible monster of anger and venom. Thankfully, they are comparatively uncommon, but feared by all. It is

believed that Aborigines with incredibly strong wills or those obsessed with a particular goal can actually resist death! Their strength of will combined with their link to nature and therefore the mystic energy of the Songlines, enables to the dying individual to make contact with an "essence" (presumably some sort of alien intelligence) that can help them "slip the bonds of death" and grant them a pseudo-life as *Australian Undead*. However, unlike the traditional vampire, the Mopaditis is an ethereal wraith. A ghostly specter that glows with an eerie, pale white light, stares out with dead eyes and walks the earth on legs made of ectoplasmic vapor.

The transformation from the living to the undead causes the **Mopaditis'** memory to fade, so all it can remember of its past life is its own death, the most traumatic and vivid of memories (including nice ones), a handful of skills (the most often used) and the faces of those they knew well in life. As a result, family, friends, rivals and enemies are the first to be visited by these undead. Likewise, those who remind them of these people will also suffer the monster's wrath. This demonic creature is particularly feared and loathed because it might be a missing friend or loved one.

Only anarchist and evil Aborigines and those who possess psychic abilities **and/or** practice magic (i.e. a Shaman, Mystic or other practitioner of magic) can become Mopaditis; 80% are Aborigines.

As the undead, these evil spirits wander the land looking for humans to torment and kill. They like to spread misery, pain, suffering and death. Unlike most undead, the Mopaditis is not nocturnal, but waits until the midday sun is burning strongly, then makes its appearance in the light of day. They vanish at **dusk**, except for nights where a full or nearly full moon lights up the sky. These undead specters may stalk their intended victims for days and even months before finally attacking. Other times, they strike without warning, waiting or any apparent reason. A wary individual can always tell when a Mopaditis is near, because the birds fall silent, the insects stop buzzing and the bush is silent and calm. Psychic sensitives, including dogs, cats, and horses, will become uneasy and whine mournfully, knowing that a creature of death walks the Earth.

When a Mopaditis appears, it can not use its formidable psychic powers or fight to kill, but only make frightful gestures, threaten, scream, growl, lunge, push (not too hard), and similar. It can only use its psionic powers, teeth and claws to attack when it has been attacked first (often at its provocation) or when an opponent asks to be killed. In the latter case, a Mopaditis or its evil associates may torment, torture or haunt the individual to the point that he or she would prefer death than to continue to suffer. This also applies to those who are sad, depressed and have given up hope. In fact, a Mopaditis may be seen floating among the **sick**, injured, hopeless and dying, asking, sometimes begging, them to let it put them out of their misery — Mopaditis love to kill. It is important to note, that once an opponent has asked for death or has taken the initiative to attack the undead specter (out of fear, anger, reflex, etc.), the monster can haunt, stalk and attack him at any point there after. That one moment of violence can make a demonic enemy for life. Resisting the **Mopaditis'** taunts, threats and menacing gestures (including pushing and slapping, neither of which do any damage, but may look scary and sting a bit), will infuriate the beast, but all the



ghost can do is scream and wring its hands. If it is not attacked, it cannot reciprocate in kind, and will eventually **leave**, at least for the moment.

When attacked, the **undead** creature becomes bestial, biting with its fangs and slashing with its clawed hands. Despite its ethereal nature (most physical attacks do no damage to it), it can tear horrid wounds with these weapons. Exactly how, is unknown, but the Aborigines claim it is because anger, hate and blood give it power to extract revenge. However, it cannot pick up a weapon and use it, nor can it cast magic. The Mopaditis can also strike with its psionic powers, which it uses instinctively and with devastating effect.

The only way to defeat a Mopaditis is by magic, exorcism, and psionic attacks that can affect spirits, the mind or emotions. Magic weapons will hurt the ghostly being, but only inflict one quarter their normal damage, and close combat with this ghost is not recommended. A Turn Dead spell will only give the monster pause (loses two melee attacks/actions), and holy symbols, silver, and garlic have no adverse effect on the damned creature. A Mopaditis dies when its M.D.C. is knocked below zero by 30%; otherwise being reduced to zero or below (but not enough to kill it) will only cause it to vanish, but reappear again the next mid-day afternoon.

The Mopaditis can also turn another person into an undead ghost-thing like itself. For this to be possible, the victim must be of an anarchist or evil alignment and want to be transformed into an undead of his own free will. When this happens, the Mopaditis reaches out its grisly, translucent hands and touches the face of the victim to draw out **their** spirit. The victim of a

Mopaditis is always pale and drawn, and the spirit or life essence that remains either floats away (01-30% chance; in effect, dies without becoming an undead) or stays to become another Mopaditis (31-00% likelihood). The released spirit forgets his old life quickly after being released, and usually wanders off alone to do evil as an undead, leaving the original Mopaditis still without a companion.

### **Mopaditis Demon & NPC Villain**

**Alignment:** Miscreant or Diabolic.

**Race:** A minor **Dreamtime** Demon.

**Attributes:** All attributes are equal to those the ghost had before death, modified as follows: I.Q. reduce by 20%, M.A. reduce by 50%, M.E. +3, P.S. +6, P.P. +3, P.E. no longer applicable, P.B. reduce by 30%, Spd +12; hovers and flies rather than walks, but maximum altitude is only 50 feet (15.2 **m**). Supernatural P.S.

**M.D.C.:** The Hit Points the character had in life become M.D.C. +1D6x10 (on an S.D.C. world the demon has 1D4x10 Hit Points plus those he had in life; S.D.C. None. Is impervious to normal weapons).

**Horror Factor:** 15. If the ghost is a former friend or family member, the Horror Factor is 17!

**Size:** Human

**Weight:** Negligible, an ethereal spirit.

**Average Life Span:** Uncertain, thousands of years or until destroyed.

**P.P.E.:** 6D6+20

**I.S.P.:** M.E. x7

**Natural Abilities:** Hover, float, fly, **nightvision** 2000 feet (610 **m**), prowl 65%, blend in with surroundings 50%. Regener-

ates all lost M.D.C. (or Hit Points) at a rate of 2D6 per minute. If reduced to zero or slightly below, the monster vanishes, but regenerates to full strength by the next afternoon.

Knows all Languages: Magically understands and speaks all languages **90%**, but cannot read.

**Limited Invulnerability:** Impervious to cold, heat, fire, disease and most forms of physical damage, including explosions and M.D. attacks. Magic weapons inflict one quarter their usual damage, while spell attacks do half damage, and psionic attacks that affect the mind and emotions do full damage (physical psionic attacks do no damage). Note, the Weapon Singing Ritual of the Dream Warrior (described in the companion book, **Rifts® Mystic Australia**) and a few other special attacks and magic, has full effect.

**R.C.C. Skills:** The undead can remember **1D4+3** skills from its past life, frozen at the level of proficiency at the moment of death, and that's it.

**R.C.C. Combat: Attacks per Melee:** Four, by tooth and claw or psionics.

**Damage:** By supernatural P.S., although a claw strike adds 1D6 M.D., and a bite does 2D6 M.D. regardless of P.S.

**Bonuses:** +3 on initiative, +4 to strike, +1 to parry and dodge, +8 to pull punch, +1 to save vs all forms of magic, impervious to possession, and +6 to save vs Horror Factor. R.C.C. bonuses are all in addition to any possible attribute bonuses.

**Magic:** None

**Psionics:** Considered a Master Psionic (needs a 10 or higher to save) equal to a 5th level psychic. Powers include Bio-Manipulation, Empathic Transmission, **Electrokinesis**, Mind Bolt, Telekinesis (minor physical power), Telekinetic Push, Telekinetic Lift, See the Invisible, Sense Evil, Sense Magic, Empathy, Telepathy, Radiate Horror Factor, and **Mind Block**. I.S.P.: M.E. x7

**Enemies:** All mortals, particularly humans and Aborigines and any who dare to challenge or defy them.

**Allies:** Oddly enough, rarely associates with others of its own kind (one never encounters more than two or three Mopaditis at one time), but will associate with other demons, evil practitioners of magic, and other black-hearted powerful beings.

**Value:** None

**Habitat:** Can be found almost anywhere throughout Australia and occasionally on the surrounding islands, Tasmania, New Zealand, Jakarta and Indonesia.

## True (Classic) Vampire

Even Australia is not safe from the vampire menace. Though relatively weak compared to the vampires in North America and parts of Europe, there is at least one Vampire Intelligence at work in the heartland of Western Australia. More so than at any other location in the world, Vampires in Australia are more independent and tend to stray from the will of their Master, the Vampire Intelligence that spawned them. The reason for this is clear. The Dreamtime is a very powerful magic and is the ultimate balance, the supreme force of nature. Every day, thousands, maybe millions, of Aboriginal people celebrate this through the **Corroboree**. This immense energy and spirit is then sent rippling through the Songlines (hence their name), further enhancing the magic of the Dreamtime. As such, vampires and

other demonic forces have trouble gaining a stranglehold on the land around them. In the case of vampires, the energy gives them a greater free will and independent spirit. And while supernatural predators and demons continue to flood through the dimensional Rifts to prey on humankind, they are fewer in number, and Alien Intelligences find themselves rejected by the ecosystem, like a healthy body rejects a virus. Thus, the Vampire Intelligences find it difficult to maintain control over and contact with their minions. They are almost oppressed by the Dreamtime. Many of their creations become insane, or self-serving, and Wild Vampires, who are too far removed from **their** original, true master, lose contact and become wandering scavengers — feral vampires who hunt and kill in **small** packs and as lone individuals. **Note:** Aboriginal people cannot be made into vampires. An attempt to use the Slow Bite on them will simply kill them. The Rainbow Serpent will not allow its children to succumb to undeath, and so instead allows them to die. This is very frustrating to the vampires, for while they can feed from the tribes, they cannot bend them to the wishes of the Alien Intelligence.

**When a Secondary Vampire creates another vampire,** there is a much greater chance it will be secondary as opposed to wild. When rolling percentiles after the slow bite has been made by a Secondary Vampire, there is a 1-65% chance of creating another Secondary Vampire (as opposed to the normal 40% chance), and a 66-00% chance of creating a Wild one.

A full description of classic or True Vampires, their powers and motivations can be found in **Rifts® World Book One: Vampire Kingdoms™**.

## Garkain (Vampire)

**Note:** This creature originally appeared in **Beyond the Supernatural**. It is reproduced here as it occurs in Rifts Australia. There is also a little bit more to the beast..

The Garkain is a huge, hideous bat-thing known in Aborigine legend as a flesh eating demon. It is possible that the **Garkain's** appearances elsewhere in the world have been confused with the Classic Vampire.

The Garkain, known as the "dumb spirit," because it is a mindless animal predator, resembles a monstrous human with massive, leathery wings. Its head is human-like with deep-set red eyes and a gaping mouth full of pointed teeth and fangs. Its humanish hands and feet lend to the illusion that the creature is half man, half bat.

A voracious carnivore, the Garkain will swoop down on its victim, wrap him in its powerful wings to embrace or smother him, or tear out the throat with its teeth (again, similar to the vampire). The beast then tears his victim limb from limb and devours him. The creature is dumb in that it knows no fear and will fight against a vastly greater number of opponents. It will suffer massive damage before it will fly away to rest and heal. It is also known to snatch small children in mid-flight, carrying them to its lair to be devoured.

It is not created like a vampire, nor does it have any of the powers or weaknesses of a Classic Vampire. Rather, it is a Dreamtime Demon that is believed to be born from anger and a lust for bloodletting. It is a monster whose only goal is to **hunt**, kill and devour mortal men. They regard other undead, **includ-**



ing True Vampires and Mopaditis, as kindred spirits and never attack them. **Garkain** are even willing to follow and obey True Vampires, who use them as shock troops and scouts to "test the waters" of an area before the vampires move in themselves. Master and Secondary Vampires are also known to keep Garkain as pets and bodyguards. The creature will perch nearby like a gargoyle, growling softly to itself, waiting for the signal from its master that it can fly forth and feed.

The Garkain is a nocturnal predator and rarely ventures forth during the day. The creature will fight to the death if cornered. Its bizarre construction and physiological instability means that when it is destroyed it will dissolve into a protoplasmic goo within minutes, bones and all.

### **Garkain Dreamtime Demon & NPC Villain**

Alignment: Miscreant

**Race:** A lesser Dreamtime Demon — one of the undead.

**Attributes:** I.Q. 1D6, M.E. 2D6+15, M.A. 1D6, P.S. 2D6+21, P.P. 1D6+18, P.E. 1D6+21, P.B. 1D4, Spd on the ground is 2D6+6, but can also fly. Note that P.S. and P.E. are Supernatural and Speed while flying is 40 mph (64 km).

M.D.C.: P.E. attribute number +4D4x10 (on S.D.C. worlds the demon has 2D4x10+P.E. number in Hit Points and 1D6x10+12 S.D.C.; A.R. is 10).

**Horror Factor:** 14

**Size:** Stands man-sized at about 6 feet (1.8 m), with a wingspan of 10 feet (3 m).

**Weight:** Around 300 lbs (135 kg).

**Average Life Span:** Uncertain, 1000+ years; probably immortal.

**P.P.E.:** 2D6

**Natural Abilities:** Fly, superior night and day vision, like an owl. Can see a one foot (.3 m) tall target two miles (3.2 km) away and up to 2000 feet (610 m) in the dark. Also has superb hearing and can track by smell alone at 70% (+20% to track blood scent). Impervious to poisons, toxins, drugs, gases and disease. Bio-regenerates at a rate of 2D6 M.D.C. per hour.

Knows all Languages: Magically understands and speaks all languages 90%, but cannot read.

**Limited Metamorphosis (special):** Can turn completely into a giant bat — no human features, face, arms or hands. Increase flying speed to 50 mph (80 km).

**R.C.C. Skills:** Surveillance (tailing only), Blend, Land Navigation, Acrobatics and Wilderness Survival, all at 80%, plus Swim 50%, and Prowl 45%. Also see Natural Abilities, above.

**R.C.C. Combat: Attacks per Melee:** Five

**Damage:** By supernatural P.S., although a claw strike adds 2D6 M.D., and a bite does 3D6 M.D.

**Bonuses:** +5 on initiative, +1 to strike, +3 to dodge while in flight, +2 to roll with punch, fall or impact, +4 to save vs mind control and possession, +10 vs Horror Factor. These are in addition to attribute bonuses.

**Magic:** None

**Psionics:** None

**Enemies:** All mortals, particularly humans who are its favorite prey.

**Allies:** Others of its kind, other vampires, demons, powerful practitioners of magic, and other powerful, evil beings.

**Value:** None

**Habitat:** Can be found almost anywhere in Australia, but tends to favor caves, mountains, hills, ruins of ancient skyscrapers and the bushlands of the Outback. Although mainly found in Australia, the **Garkain** is also found on the surrounding islands, Tasmania, New Zealand, Jakarta and parts of Indonesia.



## Yara Mayha Sho (Vampire)

Yara Mayha Sho are the rough equivalent of Wild Vampires. They become vampires from the Slow Bite of a Secondary Classic Vampire (01-50% chance of turning into a Yara Mayha Sho, instead of the Classic Wild Vampire), but are not answerable to their creator or his Vampire Intelligence — effectively a *mutant Wild Vampire*. Madmen desiring to become a Yara Mayha Sho can do so by killing one, smearing his body with the monster's blood, and eating its entire liver. The character then suffers from convulsions and dies. However, he awakens the next night as the **undead**. Obviously this doesn't happen often, and when it

does it is usually out of some deranged desire for revenge or immortality.

When a person becomes a Yara Mayha Sho, he undergoes quite a transformation from his/her original form. The individual forgets about his past life and remembers only a few of his most striking memories and old **friends**. Skills and knowledge are replaced by predatory instincts, cunning and cruelty. He stops looking human, to begin with. The Yara Mayha Sho becomes somewhat hunched over, the mouth fills with fangs and pointed teeth, their eyes turn yellow, they become incapable of speech except for growls, sniggers and grunts, their hair turns white and becomes tough and stringy (looks like dreadlocks), and they develop long yellow fingernails.

The main difference from True Vampires is in their feeding method — the Yara Mayha Sho have suckers on their hands and fingers, which they slap against their victims' faces and through which all their blood is drawn out. The victim of a Yara Mayha Sho is recognizable by the circular scars on his pale, agonized face.

This undead fiend is a nocturnal predator and dislikes daylight, but they can walk around in sunlight without suffering any more than slight discomfort. They need only four hours of sleep, but usually don't come out until after dusk. They feel safer and at home in darkness.

Yara Mayha Sho are independent and solitary hunters who answer to no master. As predators, they are largely occupied with hunting human prey, but will engage in acts of brutality, torture, torment and murder for pleasure. Many like to kidnap one or two women **and/or** children whom they use and abuse as pets and playthings. Such "pets" may be kept for a few weeks to several years. They are also attracted to evil beings who are more intelligent than they, and enjoy serving as their minions, especially when they feel they are part of something big, even if they don't exactly understand what that "big" thing is. When left on their own, they often wander off by themselves, becoming little more than savage predators lurking in the bushlands or ruins of **pre-Rifts** cities. They can also be found skulking around caves, subterranean catacombs and sewers. When hunting, a common tactic is to hide in a tall tree, lurking in the branches before pouncing on unsuspecting prey and sucking away all their blood. The victim rarely ever knows what happened and is dead when the creature slides back into the bushes to wait for its next meal.

### Yara Mayha Sho Demon & NPC Villain

**Alignment:** Miscreant

**Race:** A lesser **Dreamtime** Demon — and one of the undead.

Was a human (no other races are allowed) before he became the undead.

**Attributes:** I.Q. 1D6, M.E. 2D6+2, M.A. 1D6, P.S. 2D6+16, P.P. 1D6+16, P.E. 1D6+16, P.B. 1D4, Spd. 2D6+20 (roughly 15 **mph/24** km). Note that P.S. and P.E. are Supernatural; cannot fly or turn into a bat.

M.D.C.: P.E. attribute number +2D6x10 (on S.D.C. worlds the demon has 1D6x10+P.E. number in Hit Points and 1D4x10+12 S.D.C.; A.R. is 10).

**Horror Factor:** 13

**Size:** Man-sized, the same as in life.

**Weight:** Varies, typically around 200 **lbs** (90 kg)

**Average Life Span:** Uncertain; until slain, effectively immortal.

**P.P.E.:** 4D6

**Natural Abilities:** **Nightvision** 2000 feet (610 m), can see the invisible, can track by smell alone at 60% (+30% to track blood scent), climb **90%/85%**, and can leap 12 feet (3.6 m) high and 16 feet (5 m) across. Bio-regenerates at a rate of 2D6 M.D.C. per melee round and completely **regrows** severed limbs overnight.

Knows all Languages: Magically understands and speaks all languages **90%**, but cannot read.

Limited **Invulnerability** (special): The **Yara Mayha Sho** is impervious to poison, drugs, acid, pollution, cold, heat, fire, disease, and even magic potions, magical illness and curses. Normal S.D.C. weapons do no damage unless made of silver or wood, in which case the weapon inflicts the equivalent S.D.C. damage as M.D. (i.e. a wooden staff or silver-plated sword that normally inflicts 2D6 S.D.C. inflicts 2D6 M.D. against this undead).

Mega-Damage weapons, explosives, and blasts inflict only **10%** of their normal damage and magic cold and heat based energy attacks do half damage. However, most other magic spells have full effect and **inflict full** damage. Likewise, the demon is vulnerable to psionics.

Limited Immortality (special): The only way a Yara Mayha Sho can die, is for it to be killed. There are only a few ways to kill it. One, is to drown it. Yara Mayha Sho hate and fear water. While the touch of water or holy water has no ill effect, the monster cannot hold its breath for more than 2D6x10 seconds and is easily drowned (takes three minutes to be sure). Once drowned, the corpse must be chopped up and thrown into the ocean or sea for sharks to eat. If more than 50% of the body washes up on shore, the fiend will regenerate within three nights and walk the earth once more.

Another way is the classic stake in the heart to immobilize, then chop off the head and burn both the head and body in separate bon fires. Once staked and decapitated, the body is vulnerable to normal fire.

Any other apparent death (killed by silver or wood, slain by magic, etc.) is a temporary matter, and the undead will regenerate completely within 72 hours.

**R.C.C. Skills:** Prowl, Blend, Land Navigation, Roadwise, and Outback Survival, all at 80%, plus 1D4+2 skills remembered from its old human life. Also see Natural Abilities, above.

**R.C.C. Combat: Attacks per Melee:** Five

**Damage:** By supernatural P.S., although a claw strike adds 1D6 M.D., and a bite does 2D6 M.D.

**Bonuses:** +3 on initiative, +2 to strike, +1 to parry, +2 to dodge, +2 to roll with punch, fall or impact, +4 to save vs mind control, +10 to save vs possession, +7 vs Horror Factor. These are in addition to attribute bonuses.

**Magic:** None

**Psionics:** None

**Enemies:** All mortals, particularly humans who are its favorite prey.

**Allies:** Others of its kind, other vampires, demons, practitioners of magic, and other powerful, evil beings.

**Value:** None

**Habitat:** Can be found almost anywhere in **Australia**, but since they fear water, they usually inhabit the desert and dry regions, including lurking around the alleys of Outback towns, ruins and bushland. They are not found outside of Australia.

## Wandjinas

Giant, alien beings known as the Wandjinas are found in the northern areas of Australia. They are considered to be enigmatic, elemental weather *demons*, but truth be told, they may be powerful creatures of magic or strange D-Bee practitioners of magic. Whatever they are, it would seem they have visited Australia in the past, for they are depicted on ancient (and modern) Aboriginal rock paintings, and have been compared to astronauts in the way the Aboriginal artists represented them. They are large **humanoids**, about three times the height of a man, with large, bald heads and thin, but flabby bodies. Their bulbous heads are disproportionately large, with small eyes and flat features. They have pale, yellow-brown skin and no hair. Their shoulders are narrow and the body tapers from there. They can not **speak**, or if they can, nobody has ever heard them. The only noise the Wandjinas make is a deep moaning or humming sound, usually when angry or casting their magic. What passes for a mouth is a long thin line that is virtually invisible until they open it wide to eat or release weather magic. They remain hidden most of the time, living in small clans of 3D4, venturing forth only to hunt, feed and occasionally, it would seem, to punish mankind with their powerful weather magic.

Wandjinas have the ability to control the climate and weather in ways that suggest they are indeed some sort of elemental supernatural beings. They can cause a terrible drought, summon a violent thunderstorm, drop the temperature in a matter of minutes and control the wind. When particularly angry and along a Songline, they can even summon terrible Millennium Storms.

The motives of the Wandjinas are beyond comprehension by humans. Even the Aboriginals are at a loss to explain them, saying only that these beings are "demons from another world who bend the balance of nature to their will." It would seem that some of the sudden and violent weather caused by these demons is intended to kill human prey. After deadly weather, the Wandjinas will come down from their mountain lairs to roam the countryside looking for food — humanoids. They eat those who have died or been mortally injured as a result of their weather manipulation — i.e. those who have died of thirst, hunger, disease or exposure in the hot desert, drowned in a flood, struck by lightning, or crushed in a rock or mud slide, and so on. A horrible sight is that of 3-12 Wandjinas (sometimes joined by 1D6 other clans when a catastrophe has produced a plentiful bounty of the dead) picking over corpses and pulling up the sick or injured who hover near death, and dropping them into their massive maw. Adding to the macabre scene, they hover in the air in complete silence, almost like specters of death. **Note:** Wandjinas only feed upon the dead and those at death's door (i.e. those in a coma or very likely to die in the next 18 hours). This might suggest that they are some sort of ghoul, but they will not feed on a corpse that is more than six days old and have never been seen raiding graveyards. Furthermore, they only feed upon mortal humanoids, and reject creatures of magic like the **Kwarla** and dragons, as well as supernatural beings.

The Wandjinas can also be seen manipulating weather without any intention of feeding, and for no apparent reason. One might argue they do so for play or sport, except there is no sign of enjoyment that any human can see. Other times the weather



simply changes around the creature, suggesting to some observers, that the elements respond to the **demon's** mood and emotions. People who live in the same region and fear the **Wandjinas**, sometimes make offerings to them hoping to win their favor or satisfy their hunger. Victims are either people who die of natural causes or accident, or human **sacrifices**, sometimes volunteers but mostly vanquished enemies. Regrettably, such sacrifice of humanoid life is based entirely on fear and speculation, because the Wandjinas rarely communicate with mortals and these sacrifices rarely appease them.

Aboriginal stories say that the demons hold all the weather inside them, and that if they had a mouth, they would release it all at once by mistake (the Aboriginals regard them as having no mouth, and say that the **demons'** "face opens" to release magic). There may be some truth to this legend, because when they feed, anyone brave enough to sneak close enough to see clearly, will observe crackling electricity and dark storm clouds swirling around inside their mouths. Close proximity to the supernatural being will also reveal that their skin is constantly rippling with some sort of restrained power, and that a deep rumbling like distant thunder comes from their bellies. When a Wandjinas is killed, it literally explodes in a flash of lightning, and a terrible storm will always follow within an hour of its death!

Very little truth is known about these mysterious elemental beings. What is known is that they are very short tempered, impatient, and unpredictable. They are seldom encountered alone, usually travelling **in** groups of three. They are easily annoyed and provoked, and often respond to being threatened, pestered or even observed by humanoids, with strong magic and deadly violence. But exactly how the Wandjinas might respond is never a certainty. Sometimes the demon(s) will slay an individual for quietly watching them from a distance. Other times the demon will walk straight past or hover above a group of people, but completely ignore them, or may send a wind or rain to annoy or chase them away. When the Wandjinas enter into combat, they usually do so in groups, back to back. With **slow**, deliberate movements they destroy their opposition with blasts of wind and weather from **their** "mouths," or powerful magic. The most angry and aggressive may actually **kick**, punch or try to crush an opponent under his feet. However, the entire battle will have an eerie, surreal quality due to the swirling clouds and striking silence of the demon assailants — except for the occasional hum or moan when a spell is cast, and the rush of wind, they make no sound. They are silent death.

Wandjinas are enigmatic creatures. They do not **speak**, and so **their** personalities are hard to determine. They are unpredictable and sometimes unnecessarily cruel. They never perform acts of kindness - the closest they come to this is to *not* kill someone who gets in their way. They never seek vengeance, or kill people for any specific goal, they simply wander their land and sometimes change the weather to suit them. Even **so**, there seems to be a certain glee in their evil eyes when they cause destruction.

### **Wandjinas Demon & NPC Villain**

**Race:** A greater elemental demon (perhaps even a lesser god or godling) of unknown origin and immense power.

**Alignment:** Aberrant; they seem to have their own twisted code of ethics and honor, although their behavior is generally a mystery to humans.

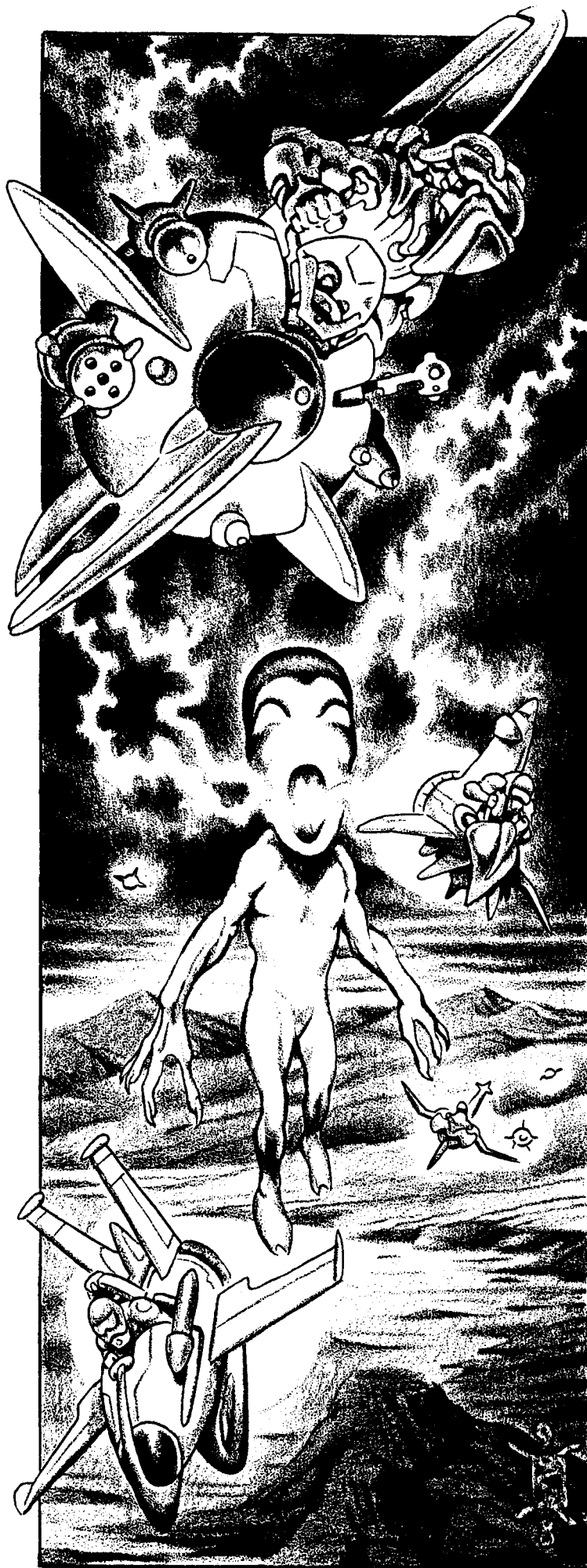

**Attributes:** I.Q. 9+1D6, M.E. 2D6+15, M.A. 1D6, P.S. 3D6+15, P.P. 2D6+15, P.E. 2D6+15, P.B. 1D4+3, **Spd.** on the ground 1D6+10, but their natural state is floating in the air and riding the winds. Can effectively float through the air at a speed of 58 (40 mph/64 km); faster if riding a storm. P.S. and P.E. are supernatural.

M.D.C.: 3D4x10+150 (on an S.D.C. world the demon has 1D4x10+100 Hit Points and 2D4x10 S.D.C.; A.R.: 10).

**Horror Factor:** 14. The distant howl of this demon has a Horror Factor of 12.

**Size:** 18 to 22 feet (5.5 to 6.7 m) tall.

**Weight:** 300-500 pounds (135 to 225 kg).

**Average Life Span:** Unknown. Believed to be immortal.

**Average Level of Experience (NPC):** 5th level (or 1D4+3).

Most of these demons range from 3-6th level, with most being 5th. **Wandjinas** who are level 7-9 or 1-2 are extremely uncommon; higher is virtually unheard of.

P.P.E.: Base of 4D6x10+350, plus another 50 P.P.E. per level of experience.

I.S.P.: 1D6x10+M.E. attribute number.

**Natural Abilities:** **Nightvision** one mile (1.6 km), superb hawk-like vision enabling them to see a child sleeping under a tree two miles (3.2 km) away, can see the invisible and can see all **spectrums** of light (infrared, etc.), which means they can see through smoke without penalty. Prowl 85% — these demons are amazingly silent, despite their giant size, largely because they float silently in the air and never speak. Bio-regenerates at a rate of 4D6 per melee round.

Knows all Languages: Magically understands and speaks all languages 90%, but cannot read.

**Limited Invulnerability** (special): The Wandjinas are impervious to normal S.D.C. weapons unless they are made entirely of wood or pure iron, in which case the weapon inflicts the equivalent S.D.C. damage as M.D. (i.e. a wooden staff that inflicts 2D6 S.D.C. would inflict 2D6 M.D. against the demon), and wood from a Millennium Tree does double damage. They are also impervious to disease, poison, radiation, pollution, cold, heat, heat, **electricity/lightning** and storms (including hail, winds, etc.).

Man-made Mega-Damage weapons inflict half their normal **damage**, M.D. fire does half its normal damage, but magic weapons, spells and psionics do full damage. Millennium Tree weapons do double damage.

**Natural State is Floating in Air:** This elemental demon hovers and glides through the air like a fish in water. Most are calm and float along at a leisurely rate of about 5-15 mph (8 to 24 km), but can attain a speed of 40 mph (64 km) when desired. Their flying speed, whatever it may be, can be maintained indefinitely. To go faster, they must ride a storm. **Wandjinas'** feet rarely (if ever) touch the ground; they prefer to hover and glide in the air above mere mortals and the filthy earth below them. Maximum altitude is 20,000 feet (6096 m); roughly four miles.

**Ride Storms** (special): The Wandjinas can ride the wind of a storm, including tornados, hurricanes, and ley line storms, without injury. During a storm the demon can effectively fly and is able to dive, swoop, and hover, but only so long as it is moving in the same direction as the storm winds, and stays just ahead of the heart of the storm. Under these conditions, the creature can attain a speed of 60 to 150 mph

(96 to 240 km; exact speed is up to the demon) during a normal storm, and as fast at 200 mph (321.8 km) during a *ley line storm*. In the latter case, the creatures must stay ahead of the storm and stay on the ley line.

**Special Weather Attacks:** One of the most incredible sights anyone can see is a group of Wandjinas standing high in the air, usually above a mountain peak, overlooking the plains, then, slowly opening their mouths to unleash huge streams of swirling clouds, crackling energy, lightning and wind — all pouring up into the sky in a dazzling display that changes the weather conditions within moments. All this is accompanied by a low, bone chilling moan or strange hum. This is how they work their magic.

1. **Weather Transformation:** The demon can open its long slit of a mouth to release dark, swirling clouds laced with energy. This energy immediately transforms the atmospheric conditions within a one mile (1.6 km) radius around him — the focal point being the Wandjinas, the weather will move with him. Victims of this "bad weather" are likely to find themselves momentarily buffeted by winds and end up soaking wet, for within one melee round (15 seconds) the air around the demon will have completely changed.

The Wandjinas can increase or decrease *each* of the following aspects by 40% as he desires. Depending on the situation, the demon might only change one or two elements, on other occasions, all of them. Furthermore, the Wandjinas can adjust each and every one exactly as he desires.

- Air temperature
- Wind speed
- The amount and density of cloud cover (turning a clear day partly cloudy, a cloudy day clear or extremely overcast, etc.).
- Amount of air moisture **and/or** the level of humidity (causing mist, fog, dew, frost, or, if the weather already looked like rain, causing the rain to start by increasing the moisture or making it hot and dry by decreasing it).
- Lightning
- The ferocity and speed of a storm (make it rain harder or **lighter**, **and/or** make the storm move through an area faster, or slow it down to punish a particular region).

**Range:** One mile (1.6 km) per level of the demon.

**Duration:** As long as the mouth is held open and the Wandjinas keeps humming or moaning (they do so for one hour per level of experience), and ends 3D4 minutes after the demon shuts its mouth.

**Damage:** As per weather and the accumulating effects from it (drought and dust storms, flooding and mud slides, lightning storms, reduced visibility **and/or** damaging winds that make travel, combat and especially flying, difficult, etc.).

Try to factor in all the logical results of the weather. For example, *hard rain* will reduce visibility and impair other senses, i.e. the pounding rain drowns out voice and other noises and may hamper radio transmissions and radar, as well as wash away smells, scent trails and footprints. So will a sand or dust storm. While a hailstorm will inflict minor S.D.C. damage and force travellers to take cover, lightning storms will interfere with **electronics**, radio transmissions and radar, and increase the risk of getting struck by lightning.

**P.P.E. Cost:** A mere 20 points!

Note: The **Wandjinas** power is limited to atmospheric conditions, so while they can make it rain, or not their influence is only over the atmosphere, and not the earth, water or fire. That having been said, the intelligent fiend knows dry conditions may cause or spread a **brushfire**, and may use wind to spread the fire in a particular direction or a particular speed, etc. Likewise, a heavy storm can cause **flooding** and mud slides. Since Wandjinas usually travel in groups of 3 or more, the others may spread out and join in with their own magic to expand the area of effect, or to pick up where the first one left off, or stand guard to defend him from attack.

**2. Directed Weather Blasts (Special):** In addition to the weather transformation noted above, the air elemental demon can fire a concentrated *blast* at one specific target. Range for each is 600 feet (183 m) +200 (61 m) per level of experience. Each blast counts as one melee attack. P.P.E. Cost is 5 points per blast.

A variety of attacks are available as follows; the demon need only think of one and open his mouth:

- **Hail Blast:** A concentrated blast of baseball-sized hail hammers the opponent. Damage is like being hit by a low powered rail gun — 1D6 M.D. per blast, plus has a 01-60% likelihood of knocking an opponent off his feet and back **2D4x10 yards/meters**; victim loses initiative and one melee attack.
- **Lightning Blast:** A bolt of lightning that does 4D6 M.D. +1D6 per level of experience.
- **Rain Blast:** A torrent of rain blasts the opponent, drenching him from head to toe and doing 1D4 S.D.C. damage (**1D6x10** to True Vampires and other beings vulnerable to water damage).
- **Wind Blast:** Same as the Wind Rush spell, only with longer range, as noted above.

**3. Explosive Death:** This is not an action a Wandjinas takes of his own volition, but is the end result when one of them is destroyed. When reduced to zero M.D.C., it loses control over the power contained inside its body and explodes in a spectacular display of lightning, wind and dark vapors. Everyone within 100 feet (30.5 m) of an exploding Wandjinas suffers **1D6x10** M.D. and the sky turns nasty, with a storm brewing within an hour after death and with effect of a full strength Weather Transformation that lasts **1D4x10** minutes per the demon's level of experience.

Also see magic.

**R.C.C. Skills:** Unknown. They certainly include Land Navigation, Wilderness Survival, Detect Ambush, Detect Concealment, Navigation (air), Astronomy, and Basic Math at 88% +1% per level of experience.

**R.C.C. Combat: Attacks per Melee:** Four by hand to hand or Weather **Blasts**, or two by magic/weather. Also see Natural Abilities, above.

**Damage:** By supernatural P.S. or magic/weather.

**Bonuses:** +2 on initiative, +1 to strike, +3 to dodge while in the air, +2 to roll with punch, fall or impact, +3 to save vs magic, +6 to save vs possession, +9 to save vs Horror Factor. These are in addition to attribute bonuses.

**Magic:** In addition to their natural weather magic, all Wandjinas can cast the following spells, provided the demon has suffi-

cient P.P.E.: All "air" wizard spells, plus Blinding Flash, **Levitation**, Escape, Magic Pigeon, Calling, Purification, Mystic Portal, Summon Storm, Summon Rain, Summon Fog, Teleport: Lesser, **Teleport:** Superior, and, from *Rifts® Federation of Magic*: Cleanse, Cloak of Darkness, Orb of Cold, Ice, Create Water, Chromatic Protection, Sonic **Blast/Boom**, Electric Arc, Lightning Arc, Frequency Jamming, Wall of Wind, Heavy Air, Mystic Fulcrum, Distant Voice, Sheltering Force and Forcebonds. All spells are equal to the level of the NPC villain.

**Psionics:** Special. Communicates **telepathically** with their own kind with no I.S.P. cost. Range is two miles (3.2 km). Cannot communicate telepathically with other races. They also communicate to one another musically with hums, whistles, moans and such, most of which are outside the frequency range of human hearing and have a range of about eight miles (24 km).

**Enemies:** Mortals, particularly humans, are regarded as dangerous animals and prey to be hunted and eaten. They have recently exhibited some interest (growing concern) toward the human bases that the Tech-Cities represent in the south.

**Allies:** Others of its kind. If these antisocial beings consider any other being an ally or master, it's unknown to humans.

**Value:** None

**Habitat:** Unknown. Appear to only inhabit the northern mountain ranges of Australia, and always favor mountainous regions. However, they can be encountered, especially when hunting or exploring, anywhere in Australia. Whether they exist anywhere else in the world remains a mystery (if they do, the mountains of India are a likely candidate).

## Yowie

The Yowie is a demon from Aboriginal lore. It is a giant monstrosity that looks like a combination of lizard and insect, with a long, scale covered body, six **insectoid** legs, a long tail like a snake and a **huge**, horned, dragon-like head. It is feared as a vicious killer and brutal tyrant. The Yowie eats anything living, but especially likes to eat humans. A few Yowies even have such selective tastes that they have a preference for either sex, or for a certain age group. Whatever the case, they are evil beings that delight in preying on those weaker than themselves.

Yowies usually live in caves, catacombs, or in rocky areas that are both dark and damp, including the ruins of **pre-Rifts** cities, particularly those underground. It will sometimes venture into drier, open areas, and even go into the desert, but only if it needs to travel, and never for extended periods. The demon is territorial and will claim a certain area for its own by "marking it" with the bones and half-eaten remains of its victims. Finding piles of bone littering an area is a sign a Yowie may be nearby.

The horrid creature is known for its raw **power**, bullying ways and incredible resilience. They are nearly as powerful as an adult dragon and can be twice as dangerous. They are open to bargains, trades and deals, but are treacherous and mean, so they may not live up to their end of an agreement, or may kill **their** partner, or cheat him in some way. The Yowie loves to twist words and win at everything it does, however, it is not as clever or resourceful as many other beings, and even a sharp human can get the best of one. This is only something to feel proud of



until the monster realizes it has been **tricked**, then all hell breaks loose — the vengeance of a Yowie is swift and terrible, and will probably lead to the suffering of scores of innocent people. To compensate for its lack in guile and cunning, the demon will kill and eat anyone who frustrates it, and is prone to making completely unreasonable and sometimes ridiculous demands (its idea of clever one-upmanship). Anyone who openly defies or challenges the beast will quickly find himself in a pitched battle against a wicked and devouring monster.

The Yowie is equally renowned for its malicious nature and cruelty. It often plans its strategies days or even weeks ahead, before venturing forth on a reign of terror **and/or** bloodletting before curling up again. Like an evil dragon, they are known to kidnap important people and hold them for ransom, ransack a town for fun, or threaten to burn down a forest, town or crops unless the locals give in to their demands, can be just about anything. Sometimes they are for practical things, like food, water, wine, or assistance, other times cruel and designed to torment, or may be prankish things that befuddle and frustrate the local folk, causing fear and chaos as they try to appease the beast, and whose activities the monster finds entertaining. Demands may also involve acts of revenge ("Give up my enemies or be **destroyed!**"), or as a power play ("Accept me as your king, or suffer my **wrath.**"), and similar. The Yowie loves to lord over, command, bully and abuse lesser beings more than anything else. It makes the demon feel important and powerful. This means the Yowie is also likely to have a band of underlings that are likely to range from human thugs and **Roadgangers** to evil sorcerers, D-Bees, creatures of magic, monsters and lesser demons. Surprisingly, most Yowies have little interest in collecting treasure; their main interest is eating and having fun at other people's expense. Some say the demon is attracted to suffering and ill **fortune**, but the truth is that these are the things the monster brings with it. It delights in the pain of others and snarls with pleasure when it manages to capture prey under its claws, to be slowly killed and then **eaten**, or maybe even eaten alive.

### **Yowie Demon & NPC Villain**

**Race:** Greater Dreamtime Demon

**Alignment:** Diabolic

**Attributes:** I.Q. 1D6+9, M.E. 1D6+16, M.A. 1D6+9, P.S. 2D6+30, P.P. 1D6+9, P.E. 1D6+16, P.B. 1D4, Spd. 44 (30 mph/48 km) running on the ground but double that (60 mph/96 km) swimming. Has supernatural P.S. and P.E.

**M.D.C.:** 2D6x100+230 (on S.D.C. worlds the Yowie has 1D6x100 Hit Points and 2D6x10+33 S.D.C.; A.R. 14).

**Horror Factor:** 16

**Size:** 20-35 feet (6.1 to 10.7 m) from the head to the tip of the tail. Typically stands about 10 feet (3 m) tall, with the rest of him trailing behind.

**Average Life Span:** Uncertain, 2000+ years; probably immortal.

**Average Level of Experience:** 1D4+4.

**P.P.E.:** 6D6+140

**Natural Abilities:** Fair speed and can run or fight without pause or suffering from exhaustion for six hours. However, the demon can swim (98%) at a maximum speed of 60 mph (96 km) and maintain top speed for up to 12 hours before needing to rest. It can climb 98%/95% and scale walls and ceilings like an insect. The Yowie does not breathe air, can

survive depths of up to three miles (4.8 km) deep, dive up to 1000 feet (305 m), prowl 70%, track **humanoids** at 60% (+20% when following a blood **trail**), track animals 55%, see the invisible, **nightvision** is one mile (1.6 km), dimensional **teleport** 55% (+15% at a ley line nexus) and bio-regenerates 1D4x10 M.D. per melee round.

Knows all Languages: Magically understands and speaks all languages 88%, but cannot read.

**Limited Metamorphosis (special):** The Yowie can turn into a man-sized version of itself (same appearance, just smaller size) or into a large, four foot (1.2 m) long centipede. The transformation can be maintained indefinitely.

**Vulnerabilities:** The Yowie is impervious to S.D.C. weapons, cold, heat, poison and disease, but magic weapons, spells, psionics and M.D. weapons all inflict full damage. Although a bully, the Yowie is usually smart enough to give up a fight when his M.D.C. is reduced to 25% of normal. Better to run today and extract sweet vengeance tomorrow than die bravely.

**R.C.C. Skills:** Dance 80%, Basic Math 85%, Land Navigation 80%, Blend 70%, Wilderness Survival 75%, Intelligence 70%, Streetwise 50%, plus select three skills from the Category of Rogue or Technical (+10% each). Also see Natural Abilities, above.

**R.C.C. Combat: Attacks per Melee:** Seven by hand to hand combat, or three when spell casting.

**Damage:** By supernatural P.S. (including tail slash and horn butt/gore) or magic; bite does 1D4x10 M.D.

**R.C.C. Bonuses:** +4 on initiative, +2 to **strike**, +6 to parry, +1 to dodge, +4 to pull punch, +2 to roll with impact or fall, and +13 to save vs Horror Factor. R.C.C. bonuses are all in addition to any possible attribute bonuses.

**Magic:** All Yowies have the following spells: Fool's Gold, Multiple Image, Charismatic Aura, Seal, Calling, Magic Pigeon, Float in Air, Fear, Energy Disruption, Call Lightning, Dispel Magic Barrier, Purification (water only), Spoil (water only), Water to Wine, and, from *Rifts® Federation of Magic*: Aura of Power, Cleanse, Distant Voice, Featherlight, Illusory Wall, Illusion Booster, and Circle of Travel. In addition, the character will know 1D6+3 additional spells selected from common wizard spells, levels 1-6.

**Psionics:** None

**Enemies:** Mortals, particularly humans, are regarded as lesser beings, pawns, playthings and food. Dragons are frequently regarded as rivals, and Yowies dislike and distrust others of their kinds.

**Allies:** Anybody who is willing to follow and obey them. May also associate with other demons, monsters, and evil beings of all kind.

**Value:** None

**Habitat:** Found throughout Australia, but mostly around swamps and other bodies of water.

---

# Gods of the Dreamtime

---

## Bunyil

**Bunyil** (not to be confused with Bunyip, which is a demon) is actually the closest thing the Aboriginals have to a creator god. The great Bunyil, or **Bunjil**, came and made order out of chaos. He made men and women to accompany the animals in their playground. At first, there was turmoil and no lands or rivers, just the Dreamtime and the animal spirits. When the Bunyil made the land and placed mankind on it, the animals were also given body and form. Their jealousy of mankind still shows today when they snarl and bite.

The Aboriginal people still admire and remember Bunyil and what he did, but he is not worshiped like most other gods. Bunyil is a force of the Dreaming, not a deity in the traditional sense of the word. He was, essentially, the first man, and all people have been born to resemble him. Different tribes tell different stories about how he actually performed the feat of creating man and the land. The most popular is that he planted a man and a woman in the soil like trees, and let them grow. However, they looked too much like trees themselves, and so as not to make the trees jealous he made them reproduce like the animals do. The animals, still flexing their new **bodies**, became jealous of this, because it was their gift, and so they made a decision never to speak to men again. Even now they never utter a word.

Bunyil is sung of in the **Corroborees** with reverence and respect. He has never been represented on rock paintings or described in detail. There is no need. It is enough that he remains the Great Bunyil, he who ended the first Dreamtime and made the world as it is in the current Dreaming.

**Note:** It is impossible to give statistics for this being, as he is more a "force" than a definable deity.

## Rainbow Serpent

The actual Rainbow Serpent is long gone. He left the world when his task was finished, but one can still see his scales after it rains. His many colors shine in a great arc across the moist sky when the sun returns and the rain is gone.

His **task**, when Bunyil made the world, was to slither across the new landscape and create the rivers, channels and streams. He summoned the rain and made these channels flow with water. Then he slithered away into the Dreaming beyond and disappeared, leaving all the water to flow out into the oceans. He is now a long way away, probably several dimensions away, into the cosmos, but he is so powerful that his colors still shine throughout the sky.

The Aboriginal hold a special place for the Rainbow Serpent in their lives. They respect him like many cultures worship a god, but they still do not worship him. He can be seen in many rock paintings and there are several dances (**corroborees**) in



which a dancer will don paints and act out the Serpent's creation of the rivers. He is seen as the creator of water and therefore is associated with life and **birth**, fertility and even prosperity.

The Rainbow Serpent has been known to send a fragment of his essence to Earth in order to remove the taint of evil. When his scales shine in the rainbow after a storm, great legends have been written about the rainbow slowly slithering out of the sky to come to the land in the form of an enormous and magnificent glowing serpent, shining with thousands of brilliant colors. The essence fragment appears first as a rainbow in the sky. Slowly, as the visitation occurs, the rainbow begins to take on snake-like qualities until it eventually slithers down out of the sky and comes to earth. The giant serpent is a mile (1.6 km) long, and glistens with all the colors of the rainbow. Because of its size it moves with very slow and deliberate movements, flowing like water around hills and over the landscape. The Great Serpent rarely touches the ground directly, and prefers to glide through the air just under 100 feet (30.5 m) above the surface. The snake is almost translucent, as it is indeed made of beams of light, and touching it directly is almost impossible. This event is incredibly rare, and when it happens, the essence fragment is always sent for a very short amount of time — just long enough to devour the worst evil and give men hope before he too vanishes. The light stops shining and the Great God-Spirit simply disappears, leaving an enormous impression like a river bed where it lay before passing from the world of men.

Each time this is done, the actual Rainbow Serpent bums up some of his own vital energy. He does this because he loves his children of the Earth, and seeks to remove anything that would threaten their existence. "Small" things such as demons and wars concern him, but he does not interfere because he is so far away and the effort is too costly. The best he can do is send his soldiers, which he creates from himself and sends through the skies and down onto Earth.

An occasion that would warrant the intervention of the Serpent would be a severe imbalance in the forces of the world, such as the appearance of an overly powerful alien intelligence, or a sudden increase in the strength of the Black Strip threatening the Great Reef. Since the Coming of the Apocalypse and the Second Dreaming, the intervention and visitation of the Rainbow Serpent has happened only three times — once to prevent the absolute destruction of **Australia**, a second to close a dimensional Rift that threatened the continent, and a third to battle **Tikilik** and restore hope. **Notes:** The visitation of this creature is incredibly rare. It only happens when truly monumental events put the world at risk or threaten the existence of mankind. The being will never interfere directly with human affairs and visitations are reserved strictly for dealing with supernatural menaces of titanic magnitude.

### **Rainbow Serpent Avatar & NPC Hero God**

**Race:** An essence **fragment/avatar** of the Greater **Dreamtime** God.

**Alignment:** Scrupulous

**Attributes:** I.Q. 20, M.E. 26, M.A. 26, P.S. 60, P.P. 22, P.E. 30, P.B. 28, Spd. 44 on the ground, or flying, its natural state, at 126 (approximately 85 **mph**/136 km). Strength and endurance are supernatural.

**M.D.C. of the Avatar:** 12,000

**Horror/Awe Factor:** 18. This is awe more than horror, but evil creatures will always be horrified.

**Size:** Enormous — nearly one mile (1.6 km) long and one hundred **yards/meters** in diameter.

**Life Span:** Immortal.

**P.P.E.:** 4000

**I.S.P.:** 400

**Natural Abilities:** Regenerative powers enable the being to restore **2D6x100** M.D.C. per minute! **Nightvision** with a range equal to normal vision, which is exceptional, allowing the Serpent to see clearly up to 20 miles (32 km) away, as well as see the invisible and all **spectrums** of light. The Serpent can fly at any height in the sky and even enter into outer space.

Knows all Languages: Magically understands and speaks all languages 98%, but cannot read.

**Limited Invulnerability:** It is impervious to drugs, poisons, disease, heat, cold, lightning, storms, and all things air borne. The Rainbow Serpent is immune to attacks from any weapon made of Millennium wood or coral because it is a creature of good, and therefore is the ultimate friend of the Trees of Life and the Great Reef. Because its body is essentially light, normal physical attacks and explosives do **NO DAMAGE**, regardless of what form they take (S.D.C. or M.D.C.). Energy blasts to one tenth their normal damage.

Magical attacks, psionics, magical weapons, spells and other similar attacks inflict their normal damage. Rune weapons, however, are foreign to the Rainbow Serpent, and do *double damage*.

### **Powers of Water and Light:**

**1. Ley Line Drifting, Phasing and Transmission.** The same as the Ley Line Walker abilities of the same name described in the **Rifts®** main rule book. The Serpent is the equivalent of a 15th level mage.

**2. At home in the Sea.** The Rainbow Serpent Avatar does not breathe air, can also swim as fast as it can fly and survive any depth.

**3. Impervious to Lasers and Illusions.** As a creature of light and water, the Serpent Avatar is not only impervious to laser blasts and radiation, but any laser light that strikes him passes right through and is turned into a harmless beam of colored light. The Serpent can also see through any illusion (they have no effect on him) and dispels them with a lash of his tongue.

**4. Eye Beams.** The Serpent can fire laser beams from its eyes doing as little as **1D6x10** M.D. (a warning shot) to as much as **1D6x100**. Range is 10 miles (16 km). Each blast counts as one melee attack.

**5. Control Weather.** The Serpent can create rain, only once, when it visits, and often does so if it visits a drought stricken area. The rain it summons will last for about 24 hours and covers several hundred square miles (as many as 600 square **miles**/1554 square km). Although the rain is heavy, it is nurturing and there are no floods or mud slides.

**6. Resurrection.** Once per visitation, the essence fragment of the Rainbow Serpent can restore to life 2D6 beings that have been slain while battling evil. Their deaths must have occurred within the last 72 hours, and if a hero died of natural causes, he can not be restored to life. The deceased must have been considered a companion of light **and/or** an ally of the Rainbow Serpent to be restored.

**7. Swallow.** As a special attack, the Serpent can swallow the evil that he has been sent to battle. It simply makes a strike roll against the creature or object it wishes to swallow. Its maw can expand to accommodate anything up to 500 feet (152 m) in diameter! This is his final and most powerful ability, and it is always the last thing it does, for once something has been swallowed, the Rainbow essence fragment dies and fades away into nothing, taking the swallowed evil with it. If something is successfully swallowed, it is either destroyed forever, or sent to a distant dimension — far from the Dreaming — and will require at least 3D6x1,000 years to escape. And once it has escaped, is unlikely to return to Earth.

**R.C.C. Skills of Note:** Holistic Medicine, Basic & Advanced Math, Corroboree, all Navigation Skills, all Wilderness skills, and all Lore skills at 98%.

**R.C.C. Combat: Attacks Per Melee:** Ten by lasers or physical attacks, or psionics, or three by magic.

**Damage:** By supernatural P.S. or magic; bite does 1D6x100 M.D. and a slashing tail does 3D6x10 M.D., but counts as two attacks.

**Bonuses:** +6 on initiative, +4 to strike, can not parry, +3 to dodge, +10 to pull punch, +6 to roll with impact and pull punch, critical strike on a 17-20, +2 to save vs psionic attack, +6 to save vs magic (all), and is immune to the effects of Horror Factor and impervious to possession, illusions and all forms of mind control. All bonuses are in addition to Attribute Bonuses.

**Magic Powers:** All air and water magic and may use all Crystal Magic powers and spells. 4000 P.P.E., spells cast equal to a 10th level spell caster.

**Psionic Powers:** All Sensitive powers, plus the Super-Psionic powers of Empathic Transmission, Mind bolt, Mind Bond and P.P.E. Shield. 400 I.S.P., equal to a 15th level Mind Melter and is considered a Master Psionic (needs a 10 or higher to save vs psionic attack).

**Cybernetics:** None; they would not work on this creature of light.

**Money:** Doesn't need or want any.

**Alliances and Allies:** All Aborigines, all good creatures, all animals and goodly spirits are automatically allies of the Serpent Fragment. Also, Millennium creatures are allies. Demons, supernatural evil and indeed evil of all kinds are enemies of this rare being.

**Enemies:** The darkest and most powerful forces of evil and chaos.

**Habitat:** The endless Megaverse.



## Tikilik

The Tikilik is the closest thing the Aborigines have to a devil. Like many of their gods, his power is centered around water and the power it has over the world and the Dreaming. The Tikilik is a giant frog, so huge and bloated that it is said he can drink all the water in the world and hold it in his belly. When he does this, a drought comes and the land starts to dry up. The only way to bring the water back again is to make him spew it back out to refresh the land and the plants. There have been stories told of heroes powerful enough to defeat the Tikilik and bring the water back, but generally it is taken for granted that the giant frog is responsible for the droughts and dry spells that are very common in the Australian Outback.

In recent years the Tikilik has become more powerful. Even though Australia now has an inland sea, this has, in fact, made the continent even drier by raising the salt tables. The Tikilik has used this increased scarcity of water to increase his hold over the land. If it wasn't for the Rainbow Serpent sending rain and appearing in the sky, the great devil himself would step into the world and "drink" all the water. Many stories are told about this myth, and it is one of the few fears that shadows the Aboriginal existence.

It is a little known secret that the Tikilik has managed to establish a physical link to Australia. While some sensitive **Kwarla** and Aboriginal seers have felt the presence, they are unable to identify it, knowing only that it is an ancient evil. The Frog God is slowly giving birth to an avatar born of his intelligence and essence. This undeveloped creature is a gigantic and slow moving tadpole located at the deepest center of the inland sea. Within a century or two, it will grow to become a frog several miles long and capable of finally drinking all the water in and around Australia, drying up the continent and killing all its people. And in so doing, it hopes to cripple and defeat the Rainbow Serpent as it moves on to destroy all who stand in its way and conquer the rest of the world — sending forth millions of its Frog Demons and draining other great seas whenever necessary. It will take a cadre of mighty heroes to discover the danger and engage the growing avatar in a celestial war of continent shaking proportions to prevent this grim occurrence. Already the legends are being written about a gathering of heroes who, sometime in the future, inspired (perhaps led) by the Rainbow Serpent, will locate and destroy the Tikilik intelligence before it can reach full maturity, save Australia and restore hope to that corner of the world. This is a fantasy that is told more as a story of inspiration than an accurate prediction, but, unknown to the storytellers, the threat is real.

Perhaps the greatest threat the Tikilik can offer in the meantime comes from his demons. Hideous frog-creatures that roam the land and cause magical droughts by drinking P.P.E. away from the Songlines and heroic sorcerers. These demons are destroyed as often as possible. Active hunting parties are often established to bring an end to these creatures, but for every year that the Tikilik Avatar rests hidden at the bottom of the sea, two Demon Frogs take the place of every one slain!

It is also a fact that the Demon Frogs loathe Millennium Beings, particularly the Trees of Life, and seek them out around the world. They attack the Millennium Trees with teeth, clawing hands and magic, eating the very leaves, bark and branches like



demonic locusts. As of yet, no Tree has been destroyed — they are still too powerful, and the Demon Frogs too few, but as the vile Tikilik Avatar grows in size and power, more of its hideous frog minions appear like a pestilence sweeping the land, and targeting Millennium Beings and all things good.

While the Aborigines and learned mages realize the Demon Frogs are sent by Tikilik, they are at a loss as to how he can dispatch so many, with their numbers increasing with each passing year. Seers that have predicted a menace so terrible it will be capable of destroying the Great Reef have been dismissed as eccentric. And even far away in North America, seers with the gift of prophecy are beginning to sense a distant evil with the face of a frog. An evil that is one of the *Seven Dangers ...* but they know not what it is or where its evil roots are planted.

### **Demon Frog, The Minion of Tikilik & NPC Monsters**

Also **known** as Frog Demon and Tikilik's Children.

**Description:** The Demon Frog appears as a huge and incredibly ugly frog. It is bloated and the colors of its skin do not match, typically a dull, sickly green with blotches and swirls of yellow, red and white. The eyes are a pale red with a dark purple center. It has a broad mouth filled with flat, yellow plates. Unlike a normal frog, the legs have small, sharp claws that are used to tear and slash with in combat. The demon moves by loping along. It can crawl without hopping, but rarely slows down to this pace.

Note: Most of the time, the Frog Demons are encountered as lone individuals or in pairs or small groups of 1D4+3.

Sometimes, however, they will gather in a swarm, usually when close to a powerful force of good or a Millennium Tree. At such times there can be dozens, even hundreds of these monsters attacking in waves for days or weeks until destroyed or driven away.

**Race:** Greater Dreamtime Demon and the minion of the evil Tikilik.

**Alignment:** Diabolic.

**Attributes:** I.Q. 1D4+5, M.E. 1D6+14, M.A. 1D4, P.S. 1D6+34, P.P. 1D4+10, P.E. 1D6+20, P.B. 1D4, Spd on dry land is 24 (roughly 15 mph/24 km), but swims at three times that speed (45 mph/72 km). P.S. and P.E. are supernatural.

**M.D.C.:** 2D6x10+150 (on S.D.C. worlds, the demon has 2D6x10 Hit Points and 100 S.D.C.; A.R. 9).

**Horror Factor:** 15

**Size:** 8 to 10 feet (2.4 to 3 m) high, and 20-25 feet (6 to 7.6 m) long.

**Weight:** 6-12 tons.

**P.P.E.:** 1D4x100

**I.S.P.:** M.E.x10

**Natural Abilities:** **Nightvision** 400 feet (122 m), see the invisible and see in murky water. Swims at 98%, breathes in air and underwater, can dive 500 feet (152 m), swim at speeds of 45 mph (72 km), survive depths of two miles (3.2 km), and leap 30 feet (9 m) high and 80 feet (24 m) across. Bio-regenerates 2D6 M.D.C. per melee round.

The Frog Demon is not particularly intelligent or knowledgeable and is driven by instinct to find sorcerers and creatures of magic of good alignment and destroy them along



with the hated Millennium Tree. Speaking is done in a deep, guttural voice and typically limited to phrases and short sentences mixed with grunts, groans, roaring and belching.

### Special Magical Abilities:

**1. Trace Songlines & Hunt Creatures of Magic:** Demon Frogs can smell and track P.P.E. ley line sources up to 20 miles (32 km) away, and a nexus junction up to 100 miles (160 km). They can also tell when a dimensional portal is open along the line, as well as sense the ebbs and flows of its energy. When the Demon Frog does find a ley line, it has a 01-25% chance of successfully identifying the correct direction to travel to find a Millennium Tree and can draw upon the ley line to open a dimensional portal to **teleport** it to within 50 miles (80 km) of the Tree. Once near a Millennium Tree, the Demon Frog will either attack the tree, attack its allies or wait for others to join it in order to launch a full-scale attack.

In the alternative, Demon Frogs may simply wait along the ley line until a practitioner or creature of magic comes along, and attack it. When no ley line is available, or the demon is in the mood for a fight or meal, it roams the land in search of good sorcerers or creatures of magic to fight, kill and devour.

**2. Eat Millennium Wood:** The Demon Frogs' most amazing and horrifying power is the ability to *eat* the leaves and wood of a Millennium Tree! The demon is impervious to the energy expulsion effect that occurs when a Millennium Tree is damaged, as well as to its magic and the magic of its many weapons (wands, staves, etc., have no effect on these demons). Thus, these monsters can inflict grievous harm upon a Tree of Life, leaving only its Earthly allies, friends and protectors to defend it. **Damage:** Demon Frogs can chew up and swallow a single giant leaf in one melee round (15 seconds) and each bite does 1D4x10 M.D. to the Tree, enabling them to bite off small branches, gnaw through large branches in a matter of a minute or two (6-10 bites), strip its bark and take hunks out of its trunk! These creatures of destruction can destroy a Millennium Tree by literally eating it alive! They can destroy Millennium weapons in a similar fashion in 2-4 bites.

**3. Drink P.P.E.:** The main purpose and power of the Demon Frogs is to cause a drought of P.P.E. energy. When on a ley **line**, that line will dim and some of its power will be drained away by the demon. The creature acts like a resistor on an electrical cable. Wizards and psionics attempting to harness the power of the ley line corrupted by the Frog Demon will gain only half the usual benefit or ambient P.P.E. they normally can. Someone using the Songlines skill can make a roll to detect the presence of the demon, but all rolls made on that ley line will be at -25% due to its reduction in power, and the demon will know it has been identified, and exactly where that person is along the ley line.

When the Frog Demon finds a source of P.P.E. that is not a ley line, it drains away the energy directly. The demon does not gain any of this energy, it simply "drinks" it away, burning it up completely. Furthermore, anything magical within a *half mile radius* (800 m) of the Frog Demon that has a P.P.E. pool greater than 50 points (this includes magical items, creatures of magic, men of magic and other demons), will have their current P.P.E. amount reduced by 4D6 points per hour until the demon moves out of range or is slain. P.P.E. will not recover while the demon is within this proximity, but will recover normally once it is gone, killed, or the individual travels out of range.

**R.C.C. Skills:** Land Navigation 90%, Water Navigation 90%, Blend **50%**, Climb **70%/60%**, and Wilderness survival 90%. Also see Natural Abilities, above.

**R.C.C. Combat: Attacks Per Melee:** Five by physical attacks or psionics.

**Damage:** By supernatural P.S.; bite does 1D4x10M.D.

**Bonuses:** +2 on initiative, +3 to strike, +4 to dodge, +4 to roll with punch, fall or impact, +2 to save vs all forms of magic, +8 to save vs Horror Factor. Impervious to drugs, poisons, gases, cold and S.D.C. weapons.

**Vulnerabilities:** M.D. weapons, magic and psionics inflict full damage. M.D. fire attacks do double damage!

**Magic:** None, other than the special powers noted previously.

**Psionics:** Considered a Major Psionic with the powers of Sense Evil, Sense Magic, Sense Dimensional Anomaly, Read Dimensional Portal, Sense Time, Commune with Spirits and Mind Block.

**Enemies:** Mortals in general, champions of light and goodness and Millennium Beings in particular.

**Allies:** Others of its kind and any who serve Tikilik.

**Value:** None

**Habitat:** Can be found wherever good sorcerers and creatures of magic are located, but are most common along ley lines, and in and around rainforests, swamps, lakes and the Inland Sea.

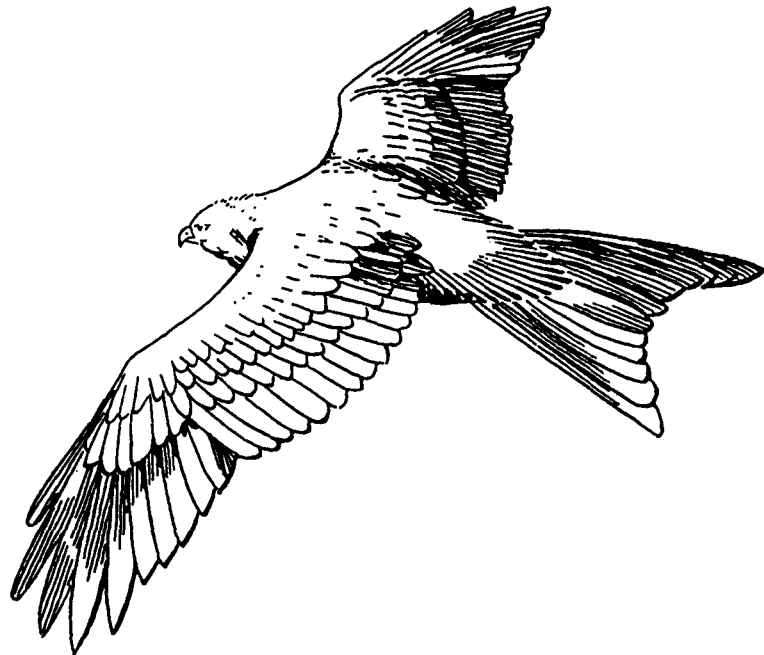

## Other Spirits & Animal Totems

Animals, Animal Totems and other Dreamtime beings will be presented in **Rifts® Australia Two: Mystic Australia™**. There will also be data about Australian Millennium Beings, Crystal Magic, Aboriginal characters, Aboriginal magic and more. Coming Summer 1999.



# Weapons & Equipment

Australia has been very removed from the rest of the world in its developments during the past couple centuries. Of course it **suffered** from the Great Cataclysm that signaled the Coming of the Rifts, saw civilization (or most of it) collapse, and, with the exception of Perth and Melbourne, went through a Dark Age of chaos and change. Even the two Tech-Cities went through decades of **nongrowth** as they struggled to stay alive and safe. Building their **walls**, defenses and governments took a century in and of itself. However good or evil, the cities are anomalies. Their weapons and equipment is listed because they are each a continental power and represent the last bastions of advanced technology, but they are not the norm.

## Outback Technology

Being a continent in and of itself, Australia is surrounded by oceans and has had to become totally self-sufficient. Being at the bottom of the world has further helped to keep it separated and isolated from the rest of the world. Even **today**, the Land Down Under has little contact with the outside world. This isolation has retarded its recovery and seen the development of a

unique view of the world. Due to the circumstances of the Apocalypse, few developments have been made in technology, and what remains is an aging treasure **trove** of ancient relics. The secrets of high technology are hoarded by the last two standing Tech-Cities (more like city-states or independent kingdoms), Perth and Melbourne. Whatever technology exists elsewhere is scattered over the country in the form of piecemeal and homespun devices and knowledge, combined with jury-rigged machines built from ancient scrap and stolen goods from the two aforementioned centers of technology. In the Outback and other wilderness regions, tech-levels are low and even simple S.D.C. guns, vehicles, and equipment are cherished remnants of the old world and an important means of survival.

As a result, there are a lot more S.D.C. weapons and vehicles in Rifts Australia than other parts of the world. This is why the cities have such a monopoly over the rest of the country. So long as they can hold onto superior armors and armaments, they will dominate any force on the continent. This domination of technology makes the two city-states even more powerful and tyrannical than the Coalition States, for they control all aspects of knowledge and technology, creating a huge chasm between the "Haves" and "Have Nots."

In the Outback communities, someone with M.D.C. armor and a Mega-Damage weapon (like the player characters) is a powerful warrior and often a hero/champion or the pride of a community. In the wilderness, a few M.D. weapons can make a small gang the rulers of the roads for miles, and kings of their own — albeit tiny and insignificant — domains. Thus, high-tech vehicles and especially M.D. weapons and M.D.C. armor represent great power and elicit a certain amount of respect and fear, for they are the great "equalizers" against demons, monsters and magic.

In general, it is safe to assume that the player characters are among the elite to own M.D. weapons, M.D.C. armor and maybe even some knowledge about technology, making them powers to be reckoned with, if not heroes. In fact, many of **their** adventures may involve getting, fixing, fighting for, and maintaining tech equipment, as well as battling agents from the Tech-Cities who don't want wilderness savages to possess such weapons, and inhuman forces from other worlds. Regional bandits and warlords are likely to see the adventurers as dangerous rivals and potential challenges to their power and authority who therefore, need to be eliminated. Likewise, the adventurers will be targeted by warlords, bandits and gangs for their weapons, or seen as potential allies or mercenaries. Player characters, especially groups, who develop reputations as "heroes," will quickly become legendary, and become a magnet for trouble. Wilderness folk will turn to them and plead for their intervention against every manner of evil, human and inhuman. Even the high-tech superpowers at Perth and Melbourne are likely to regard them as **rabble-rousers**, **thieves** and threats to their supremacy — rugged **Outbackers** with dangerous ideals and a presence that can only serve to inflame the spirit of the impoverished people they seek to dominate, and thus are best to be eliminated, or at least controlled.

Welcome to the savagery of Rifts Australia.

## A note about Currency

Extended isolation has meant that no established trade outside the continent has reached Australia, meaning the Universal Credit has never been fully introduced to this market. In other words, the good old *Australian dollar* is still around. In the late 21st century, Australia developed a plastic note to replace its currency, making it not only safe from fraud but nearly indestructible.

In the Outback a loose economy is still maintained using dollars. However, "dollar" is a term used more as a measure of value than it is an actual unit of currency. *Trade* and bartering are infinitely more common methods of commerce, and in many Outback communities, or among tribes and gangs, plastic money is useless — they *only* trade goods and services for other goods and services. However, they know what a dollar is and understand its value. So if they ask for "twenty dollars," it means they want \$20 worth of wares. The two city-powers mint and circulate "dollars" as their official form of currency, but even they will trade goods and services with the "primitives" from the Back of Beyond.

As a happy coincidence, and for ease of play, dollars and credits are roughly the same monetary unit. However, in the **Outback**, even common goods may cost two or three times what they do at the Tech-Cities and other parts of the world, and high-tech weapons, armor, and vehicles, especially powerful and rare ones, can cost **10-50** times more.

## Miscellaneous Outback Equipment

**Firestarter:** Starting fires in the Outback can be quite dangerous. Matches, magnification of the sun's rays, a common lighter and other naked flames or even cigarette butts can send a spark that will change a whole area of dry forest into a raging inferno. Apart from the rainforests, bushlands are *very* flammable. A "**firestarter**" is a catch phrase for almost any "safe" device; like a cube of petroleum jelly you light and place at the bottom of a fireplace, a lighter that has a heat element instead of a naked flame, or a spark gun with a covered nozzle, and so on. Such devices usually have about **1D4x10** +10 uses, and are good for, you guessed it, lighting fires (providing the substance is dry and flammable enough). Cost varies from \$40 to \$80.

**Snakebite Kit:** There are millions of things that have a poisonous bite in the Australian Outback (and that's not including the supernatural creatures). Most notable are the spiders and the snakes. Most of them make you very sick, but a substantial number can also kill you. Some spiders are lethal enough to kill an adult human in 20 minutes, and some snakes have venom that is almost instantaneous (one melee round to administer the antivenom). People who are used to living in the bush perform daily rituals that become second nature - like shaking a boot for bugs before putting it on, stomping your feet when walking through bushes to scare away snakes, etc. Nonetheless, bites happen. The typical snakebite kit consists of a small pouch that zippers up, and contains a syringe, two small vials of drugs, a bandage, a fold-out chart and some cotton buds with cleaning fluid. With the kit, wounds can be cleaned and poison can be slowed - but a victim will need a medical facility for full treatment. The chart is a sheet of diagrams of poisonous spiders and snakes so the correct antivenom can be selected by a doctor (if the victim got a good look at the creature and can identify it).

The syringe is for antivenom - one dose. Strictly speaking, an antivenom in the twentieth century only works against ONE type of creature, but in the far future we can assume synthetic drugs will protect against any foreign agent. So in this kit, one vial contains antivenom for any snake bite, and the other for any spider bite. These little kits and drugs are treasured and getting rarer as time goes by, so the first rule is *don't get bitten*. Cost is \$480 for a new kit, \$350 to refresh the drugs, or **\$110** to refresh the bandages and antiseptic.

**Silt Goggles:** Simply, these are goggles that don't have lenses. Instead, they have a mesh, or filter across the eye pieces that can be seen through perfectly when the eye is close up (such as when they're on your face) but look blank from a distance. The goggles protect from dust and sand in the air in a high wind, and also cut down glare, without sealing in the eyes; which is what conventional goggles do. Thus the face can breathe and the goggles can be worn indefinitely. They give the wearer a very unique look, and cost about \$60 for a good pair.

**Billy:** A simple device. About the size of a large can or tin (and mostly made out of one, such as a processed food tin or a 2 liter/half gallon paint can) with a small carry handle over it. This is about the most useful thing you can imagine. It can carry water, boil water, or cook stews. It can boil tea, it can be nestled in a fire like a stove or suspended above like a kettle. You can also eat out of it, and when packed into the bottom of a backpack it can be used to stow away delicate objects. No Outbacker is without one. They are very common, and cost around \$12.

**Seeds, Medicine, Blueprints and Books, etc.:** All these things aid in survival and continuation. When a character profile begins with a certain dollar value in saleable items (see O.C.C. starting money), it indicates things of worth to the community. As a rule, anything that grows food, tells about the past, tells how to construct a useful machine, treats disease, tells about plants, people, geography or animals, or that wards off magic is of value, and counts as a cache of worthy goods the character may have in his possession. Of course, he/she can sell such things for raw money, but goods are more substantial than cash in hand, and prices vary enormously in a free trade, bartering society.

**IMPORTANT NOTE:** **Basic Equipment** items from the back of the **Rifts**® main rule book are, of course, available, but they are at *double to quadruple the cost* if they contain electronics, perhaps more (G.M.'s discretion). As mentioned before, technology is rare outside the cities.

Nearly anything from other **Rifts**® supplements can be found within the Tech-Cities, from personal electronics and computers, to surveillance gear, to common household goods and medical supplies. Also see **Rifts**® **Underseas**™ or **Coalition Navy**™ **Sourcebook** for details on a large array of boats and **waterborne** equipment. However, there are strict laws on the ownership of property within the city walls. Prices are as listed in credits, but use dollars as a term of currency just the same.

**Techno-Wizard** equipment does not exist, except among the monstrous Mokoloi who hate humans.

**Trade Note:** When trading with the Gap, any equipment from within the City walls is considered of high value to the Outback communities. The Tech-Cities are reluctant to trade M.D. weapons and **E-Clips**, and especially large M.D.C. vehicles (motorcycles and hovercycles are traded on occasion), for

fear that the "wilderness barbarians" may turn their own weapons against them. Consequently, the prices for such items in the Outback should be at least doubled, probably tripled or quadrupled. It's all about survival and supply and demand.

### Field Equipment and Clothing

The costs for these items are comparatively cheap, even though in the Outback, they are often handmade. Use current modern day equivalents in Australian dollars. See **Heroes Unlimited™** for a good range of things.

## Weapons for the Outback

To avoid repetition and to save space, we have not reprinted or even listed most weapons. A modest list of S.D.C. firearms can be found in the **Rifts® RPG, Heroes Unlimited™ 2nd Edition**, and **Ninjas and Superspies™**, among others.

The absolute *best* and most *comprehensive* reference is **The Compendium of Contemporary Weapons™** with over 400 different weapons from around the world, plus special rounds, grenades, body armor, EOD equipment, and a couple dozen tanks and other military vehicles. Virtually any of these S.D.C. handguns, rifles, **machineguns**, explosives, etc. (or their equivalent), can be found throughout the Australian wastelands and wilderness. They are found in the hands of everyone from adventurers, bandits and rogues to collectors, farmers and homesteaders. Costs are generally 50% to 100% higher than the prices listed in US dollars (or credits) in the various books.

### Ammunition for S.D.C. Firearms

On average, a single bullet will cost 20-50 cents, with special rounds costing 2-5 times more. An **E-clip** will cost at least 6,000 dollars/credits and usually two or three times that.

To keep things brief and simple, the following caliber of rounds inflict the corresponding, general amount of Hit Point/S.D.C. damage. Revolvers can typically fire one round-size up or down than what it was designed for. **Again**, see **The Compendium of Contemporary Weapons** (a truly comprehensive **sourcebook**) for expansive details about ammunition and special rounds.

#### Pistols, Revolvers & Sub-machineguns:

Average effective range is 100 feet (30.5 m).

.22 caliber — 2D4 S.D.C.

.32 caliber — 2D6 S.D.C.

.38 caliber or 9 mm — 3D6 S.D.C.

.45 caliber or 10 mm — 4D6 S.D.C.

.41 Magnum — 4D6 S.D.C.

.44 Magnum — 5D6 S.D.C.

#### Rifles:

Average effective range is 1400 feet (427 m).

7.62 mm — 4D6 S.D.C.

7.5 mm or 7.92 mm — 5D6 S.D.C.

12.7 mm — 1D4x10 S.D.C.; burst at one target will do 1D4 M.D.

.50 caliber — 1D4x10 S.D.C.; burst at one target will do 1D4 M.D.

14.5 mm — 1D6x10 S.D.C. (**machinegun**); a burst at one target will do 1D6 M.D.

Shotgun — 4D6 to 6D6 S.D.C. (200 ft/61 m range)

---

## Modifying Weapons

Because weapons are status symbol and necessity of survival amongst most of those who own them, they have been modified, copied and manufactured (often built by hand) in various make-shift workshops across the country. As such, players may apply the following modifiers to their weapons with their characters' starting money.

### Options Available:

- **Extended Barrel** (pistols and SMGs only): \$80. Adds 50 feet (15.2 m) to the effective range.
- **Speed Loader (revolvers only):** \$5. Not a modification, but an accessory. Bullets are held in a dummy barrel that speeds reload time to 1 melee action, as opposed to the time that revolvers would otherwise take to reload (one full melee round or four actions, which ever comes first).
- **Customized Grip (available for all guns):** \$140. Adds +1 to strike, but only for one individual, -1 to strike for others who use the gun. If the character buys a weapon that has had its grip modified for someone else in the past, then he can usually *subtract* \$80 from its price.
- **Sawed Off (shotguns only):** No price. Cut the range in half. If using **buckshot**, subtract 1D6 from **damage**, but add +2 to strike. The G.M. may also allow the user to strike multiple targets with one shot (with buckshot), if they're close together.
- **Extended Magazines** (guns with magazines only, i.e. no revolvers, shotguns or weapons with cylinders or internal magazines): \$60. Increase the ammo payload by 50%. So a gun that originally held 12, would hold **18** bullets, for example.
- **Full-Auto Capacity** (automatic pistols only): \$50. By cutting firing pins and reconfiguring venting, a pistol can be modified to fire in full-auto mode (i.e. fires half its payload with every press of the trigger). This is not a common modification, as ammo is too precious.
- **Full-Auto Trimming** (any weapon capable of bursts and sprays): \$60. Most wise Outbackers will usually have this done to their weapons. The modification changes the weapon into single shot or volley capacity only, therefore reducing the chance of wasting bullets.
- **Flash Suppressor (any rifle):** \$90. A muzzle that reduces the flash and flare caused by a round being fired. Really only visible at night, muzzle flash can easily give away a sniper's position. The key word here is flash *suppression*. It's still there, simply the angles from which the flare can be seen are reduced.
- **Silencer (sub-machineguns and automatic pistols only): \$120.** These reduce the noise a round makes when fired. Not very popular; people who own guns in the Outback want to announce the fact. Only City Raiders, thieves and spies tend to disagree.
- **Improved Balance (any automatic firearm):** \$120. Through better venting, better balance and so forth, a gun is made to be more accurate. +1 to strike, even when fired Wild.

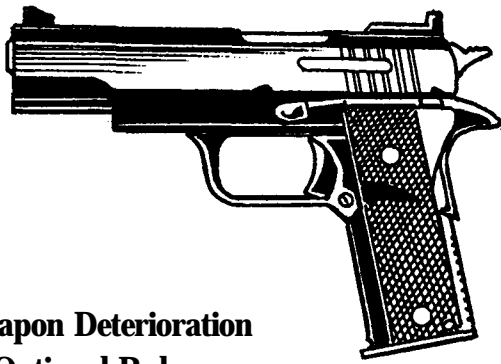

## Weapon Deterioration — Optional Rules

Some thoughts about weapon reliability. Old guns get distorted, suffer from rust and dirt build up in the barrel and so on. Without proper care, guns become less reliable. Australia's harsh environment, and the extended use that a gun is likely to see in the violent Outback region, places severe wear and stress on old technology. Any gun the players come across during play, apart from the ones they originally start with, will be of varying condition based on the following table — roll *once* when a new weapon from the outback is encountered. If the G.M. likes these rules can be used to include M.D. weapons as well. A successful roll on the Recognize Weapon Quality skill will reveal any of these faults without having to find out the hard way (i.e. trying to use it).

### Weapon Condition — Roll Percentile Dice.

- 01-02 **Excellent!** Like new. +1 to strike and gets top dollar in trade.
- 03-10 **Excellent condition**, although it shows signs of use, the weapon has been well maintained, and gets good dollars in trade.
- 11-50 **Used and worn** but a **fine** weapon. No penalties.
- 51-60 **Mild Corrosion**. Looks poor and the trigger is stiff (-1 to strike); gets mid- to low-range value in trade. When shooting it, if a 1-4 is rolled to strike, the weapon jams and must be stripped and parts shaken to unjam. The problem will never go away until thoroughly cleaned.
- 61-70 **Heavy with corrosion**. Looks terrible and the trigger is stiff (-3 to strike, -2 on initiative/quick draw); gets bottom dollar in trade, maybe less! When shooting it, a roll of 1-10 to strike means the weapon jams and must be stripped and parts shaken to unjam. The problem will never go away until thoroughly cleaned and the trigger filed and adjusted.
- 71-80 **Heavy with corrosion and/or damaged**. Looks terrible and the trigger is incredibly stiff and tends to stick (-4 to strike and -3 on initiative/quick draw); gets bottom dollar in trade, maybe less! When shooting it, a roll of 1-5 means the trigger sticks and keeps shooting whether the gunman wants it to or not! It will fire until its payload is completely expended. To get it to stop, the weapon must be struck violently against the ground, a rock, etc. (striking the gun counts as one melee action). A roll to strike that is a 6-12 means the weapon jams and must be stripped and parts shaken to unjam. The jamming problem can be fixed with a thorough cleaning, but the sticking requires a complete trigger replacement and adjustment.
- 81-90 **Severely corroded and damaged**. The weapon just won't work and gets half the lowest trade amount one might get for a weapon. It requires some new parts, and machining equipment to clear and repair it for firing again. Once **fixed**, cleaned and polished, it is as good as new.

**91-95 Severely corroded and damaged, but can fire.** However, using the weapon is dangerous. Looks like crap, is -4 to strike and -3 on initiative/quick draw, and gets half the bottom dollar amount. When shooting it, a roll of 1-5 means the gun jams and explodes! The shooter takes half damage from the round that he would have fired. The gun can be repaired, but at -30% to the repair skill roll and costs 20% the value of a good, working gun.

**96-00 A complete loss**, even if the weapon looks fairly good at a quick glance, most are mangled pieces of scrap or corroded into one solid piece and beyond repair. In fact, just handling it may cause pieces to break and fall off.

## Flame Thrower

Flame throwers come in many varieties. The following statistics will do for any number of stock model or homespun flame throwers, and are divided into three categories: small, medium and heavy.

**Damage:** 4D6 S.D.C. for small, 6D6 S.D.C. for medium and 2D6 M.D. for heavy.

**Range:** A cone of flame 60 feet (18.3 m) long and 5 feet (1.5 m) wide spreads from the nozzle of the flame thrower for the medium and heavy models. In small flame throwers, the cone is only 30 feet long (9 m). This may be sprayed -see modern weapon proficiencies, page 34, in the Rifts® RPG, for **burst/spray** rules.

**Payload:** Small: 20 shots in a weapon mounted canister. Medium: 30 shots in a weapon mounted canister. Heavy: 24 shots in a backpack canister of thermite plasma.

If the fuel source is struck and damaged by a firearm, there is a percentage chance equal to the damage done that it will explode and do standard damage for one shot to the user, and everything in a radius of 2 feet (0.6 m) per shot remaining in the payload. Most canisters are quite sturdy, and can take 5 M.D.C. before this rule applies.

**Cost:** \$400 for small, \$900 for medium, and \$7000 for heavy. New ammo canisters cost \$40, \$90 and \$500 respectively.

## S.D.C. Melee Weapons

The following are some notable *conventional weapons* found in Aboriginal and Outback communities alike.

### Boomerangs

Boomerangs come in a variety of shapes and sizes. The range and rules for using them are found under the **W.P. Boomerang** description. Here are some samples:

**Light:** 1D8 or 2D4 S.D.C. Damage; can be thrown to return. Weight is less than one pound (0.45 kg), and the length is under one foot (0.3 m). Cost is around \$15, but is usually made by hand or traded.

**Average Boomerang:** 2D4+2 or 1D10 damage. May or may not be thrown to return, depending on manufactured style. Weight is one pound (0.45 kg), and the length is one and a half feet (0.46 m). Costs \$28, or \$35 if the boomerang is the returning type. Usually made by hand or traded.

**Hunting Boomerang:** 2D6+2 damage. Does not return when thrown. About two feet (0.61 m) in length and weighs two pounds (0.91 kg). Costs about \$48; is usually made by hand or traded.

VARIOUS AUSTRALIAN  
BOOMERANGS

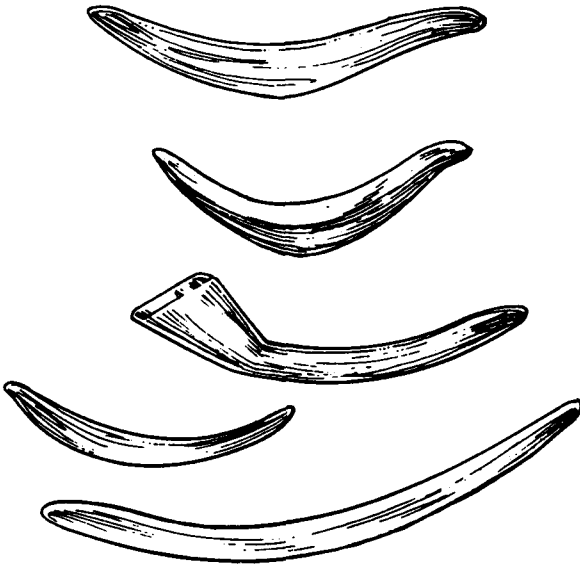

**War Boomerang:** 3D6 damage. Will not return no matter how hard you try. Weight is about 4-5 pounds (1.8 to 2.3 kg), and length is 4-5 feet (1.2 to 1.5 m)! These suckers are about the size of a hefty long bow. Cost is \$65 or based on trade.

**Metal Boomerang:** 3D6 damage. May be thrown to return. Weighs close to 2 pounds (0.91 kg). These are a modern innovation, and are deadly despite the fact that they are no larger than your average boomerang. Costs \$250. Aborigines will not use these items.

**Sporting Boomerang:** 1D4 damage. Designed mainly to return for fun. These are plastic or ceramic sporting reproductions that are fairly ineffective as weapon, but make good fun for throwing and catching. They usually cost from \$10 to \$15.

Note: The G.M. may wish to treat the Boomerang as a bullet for the sake of the pain it causes (for any saves or effects he employs). They have a rotating force that strikes with bone jarring impact, making them very effective. It is deceptive just how dangerous they can be.

## Spears

Spears are the backbone weapon of any Aboriginal community. The typical spear does 1D6 +P.S. damage bonus (if any) with a jab/thrust or blunt (clubbing) attack, or 2D6 S.D.C. when thrown. Add 1D6 damage for a trident or other large spears. Throwing range, bonuses, and details are found under the **W.P. Spear** skill description. All spears are available, even a type of trident is an Aboriginal weapon - usually made with splayed wooden forks and employed when fishing. A spear will cost \$50-\$100, 30% more if the spearhead is silver plated; a woomera costs \$12.

## Air-Powered Crossbow

The air-powered crossbow uses a pneumatic pack to expel its bolt ammunition with incredible force. The weapon looks more like a rifle than a crossbow, with a tube to fit the bolts into and an air canister in the shoulder brace. They may be vehicle mounted or hand carried, and come in a variety of forms. Air-powered crossbows are very popular with outback road gangs due to the cheap ammo they require; bolts are far easier to

make than bullets. Quite often a bolt will have greater armor piercing capacity than a bullet, as well. **Note:** Aborigines will not use these weapons.

**Single-Barrel.** The single-barreled variety has a range of 350 feet (107 m) and inflicts 3D6 points of S.D.C. Weighs 5 lb. (2.3 kg), and costs \$300.

**Double-Barreled.** Each barrel does 2D6+1 S.D.C., or both can be fired at once to inflict 4D6+1 to a single target. The range is 300 feet (91 m). Weighs 8 lb. (3.6 kg), and costs \$480.

**Quad-Barrel.** This monster is at -2 to strike if man-portable. As such, they are usually only found in vehicle turrets. Each tube inflicts 2D6+1 S.D.C., and they can be fired either one at a time or all at once. The simultaneous blast from all four does 1D6x10 S.D.C. Effective range is 300 feet (91 m). Weighs 12 lb. (5.4 kg) and costs \$1000.

**Note:** Reloading the tubes takes one action per barrel. For an extra \$100 per barrel, the crossbow can have a magazine holding three bolts for each tube, reducing the frequency of reloading. The air canister required to power the weapon holds enough gas for 50 total shots before it needs to be refilled with an air compressor, and costs \$120 to replace.

---

# High-Tech Weaponry

---

## Equipment from the Tech-Cities

Most M.D. weapons, explosives (of all kinds), and M.D.C. armor are banned within city limits and their use limited to Police, Military and Level 5 Administrators. S.D.C. weapons are also restricted, but available to Sportsmen and Level 4-5 personnel, as well as Police and Military.

**Note:** Both Tech-Cities have fundamentally the same pre-Rifts technology and weapons, and in most cases, even use the same pre-Rifts names and styling.

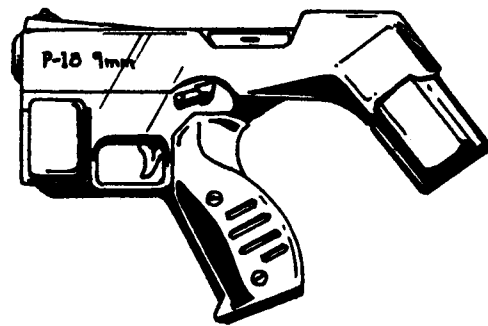

## NeraTech 9 mm P-18, Conventional Sidearm

This weapon is the standard gun you will find at the side of bodyguards and police personnel in low risk positions. It is mainly a deterrent and not a serious combat weapon. Civilian gun owners are likely to have this weapon.

**Weight:** 1.8 lbs. (0.81 kg).

**Damage:** 2D6+2 S.D.C.

**Rate of Fire:** Standard.

**Range:** 200 feet (61 m).

**Payload:** 18 bullets to a clip.

**Bonuses:** +1 to strike when aimed.

**Cost:** \$1600; \$15 for a new clip, only \$2.00 for 18bullets.

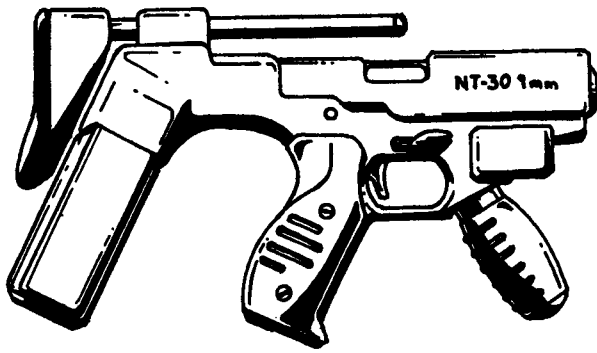

**NeraTech 9 mm SMG-30;  
Conventional Sub-Machinegun**

Another **sidearm** issued to all military and police personnel as one of their standard weapons. It is easy to **maintain**, and therefore reliable, holds a good clip and has enough stopping power to shatter brick.

Weight: 3.5 lb. (1.6 kg).

Damage: 4D6+2S.D.C.

Rate of Fire: Standard.

Cost: \$3200; \$30 for a new clip, only \$5.00 for 30 bullets.

Range: 250 feet (76 m).

Payload: 30 bullets to a clip.

Bonuses: None.

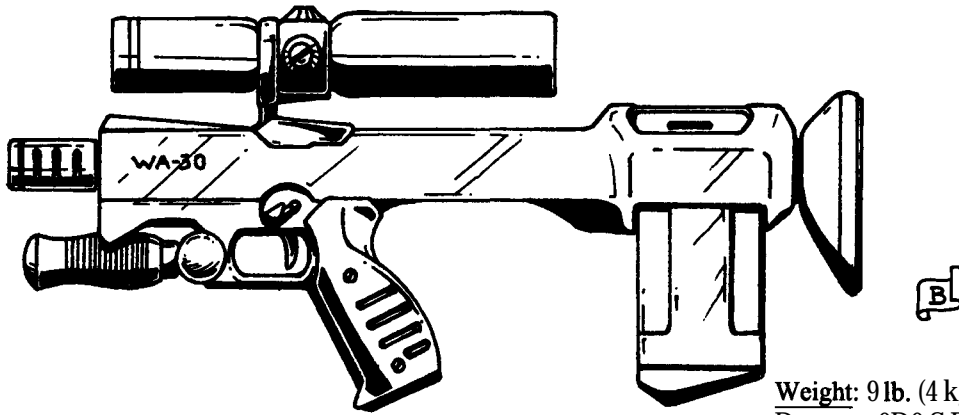

**NeraTech WA-30, Conventional Assault Rifle**

When in higher risk situations or raiding Outback communities, this is the operational weapon of choice. It has a high rate of fire, is well cooled and in all ways is a superior class of weapon, as conventional "hard ammo" weapons go.

Weight: 9 lb. (4 kg).

Damage: 6D6 S.D.C.

Rate of Fire: Standard.

Range: 1450 feet (442 m).

Payload: 30 bullets to a clip.

Bonuses: +1 to strike when aimed, and in burst mode.

Cost: \$6800; \$65 for a new clip, only \$10.00 for 30 bullets.

**NeraTech LO-20, Conventional Hunting Rifle**

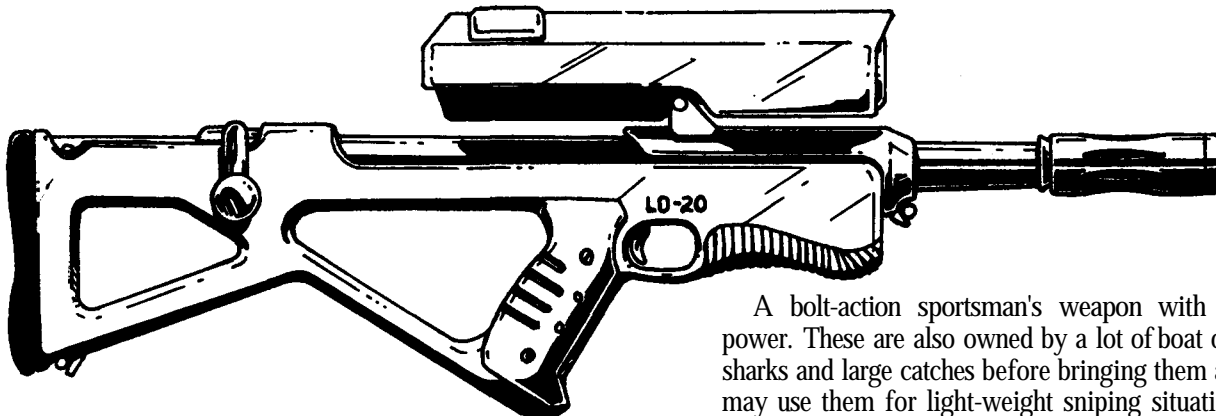

A bolt-action sportsman's weapon with a high stopping power. These are also owned by a lot of boat owners for killing sharks and large catches before bringing them aboard. The TRG may use them for light-weight sniping situations, especially in the City against S.D.C. enemies.



Weight: 8 lb. (3.6 kg).

Damage: 1D4x10 S.D.C.

Rate of Fire: Single shot only; each shot counts as one melee attack.

Range: 1800 feet (550 m).

Payload: 8 bullets to a clip.

Bonuses: +1 to strike when aimed.

Cost: \$8400; \$40 for a new clip, only \$30.00 for 32 bullets.

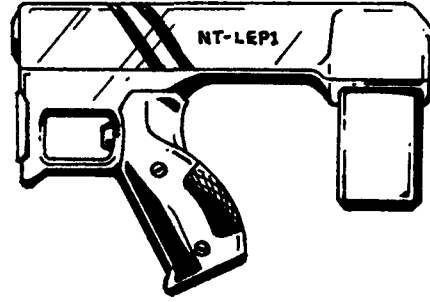

---

## Mega-Damage Weapons

---

### EIPP Technology

One of the developments made by Advanced Technologies Australia is something they call EIPP, nicknamed “Eep!”. The nickname has stuck because of the reaction many had to the field testing of this relatively new firearm innovation. Because energy weapons tend to be very destructive, their use was severely limited and even banned for non-military personnel. So the rules were bent to produce a weapon that could fire with the power of an energy weapon, but use a hard slug.

EIPP stands for Electro-Induced Plasma **Propellant**. Simply, a liquid within the handle of the weapon is heated by an **E-clip** to the point of becoming explosive plasma. This resultant plasma bolt is then used to propel a slug with awesome velocity. A trend you will see is *ATA weapons* using this system over and over again. The Administration is trying hard to ban the **weaponry**, or at least limit it to military sales, but its popularity with the people has made passing such a law very difficult.

### NeraTech Light Energy Pistol

This is the first in a line of M.D. laser weapons. It is very well balanced and is standard military issue. Civilians will have a hard time getting a permit to own such a weapon.

Weight: 1 lb. (0.45 kg).

Damage: 1D6 or 1D6+2 M.D.; two settings.

Rate of Fire: Standard.

Range: 1000 feet (305 m).

Payload: 18 shots per E-clip.

Bonuses: +2 to strike when aimed.

Cost: \$21,500; \$5500 for a new E-clip; \$2600 to recharge.

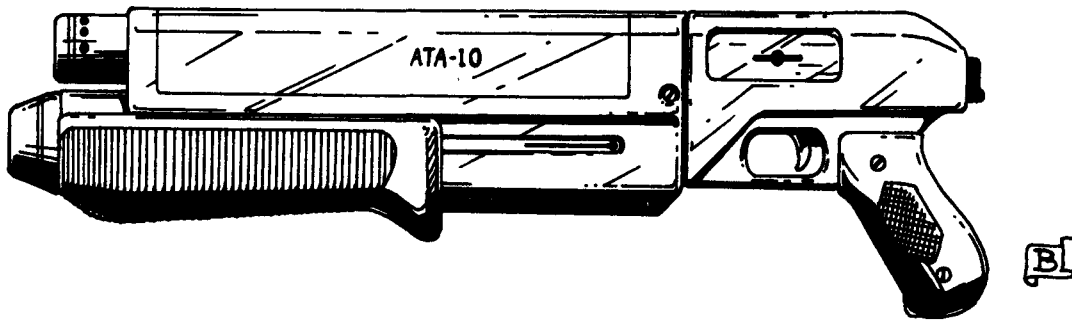

### ATA "Super 10" Shotgun

Also known as the “**Doorbuster**,” a potent firearm, and a favorite of bodyguards and Police. It fires a tight shot cluster that maximizes damage while **minimizing** the spread of the shell. It stops an **unarmored** opponent dead, and is likely to knock an armored person flat. It also has a high intimidation factor. Can use S.D.C. load or M.D.

Weight: 8 lb. (3.6 kg).

Damage: 6D6 S.D.C. or 5D6 M.D.; 01-50% chance of knocking an opponent weighing up to 300 **lbs** (135 kg) off his feet (lose initiative and one melee attack) with either round.

Rate of Fire: Each blast counts as one melee action.

Range: 60 feet (18.3 m) at its most effective, but good for up to 100 feet (30.5 m).

Payload: 8 shells in an internal magazine, but must use one type of ammo or the other. An S.D.C. and M.D. *mix* is not possible.

Bonuses: +1 to strike when within 60 feet (18.3 m) or less.

Cost: \$19,950; \$1.00 each for S.D.C. shells, \$200.00 for eight shot M.D. EIPP cartridge.

## NeraTech M-01, Military and Police Sidearm

A slightly higher-powered version of the Light Laser Pistol above, this is issued to heavy-duty TRG teams and to higher military personnel for use in dangerous situations.

Weight: 2.5 lb. (1.1 kg).

Damage: 1D6+2 M.D. or 2D6+3 M.D.; two settings.

Rate of Fire: Standard.

Range: 1000 feet (305 m).

Payload: Fifteen 2D6+3 shots to a clip.

Bonuses: +1 to strike when aimed.

Cost: \$25,000; \$5500 for a new E-clip; \$2600 to recharge.

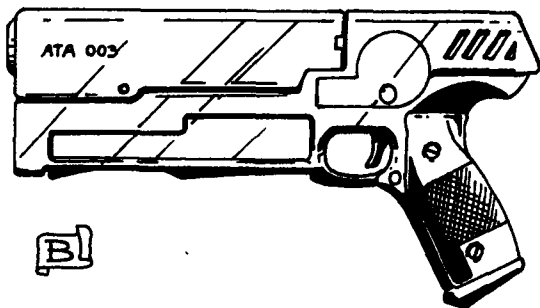
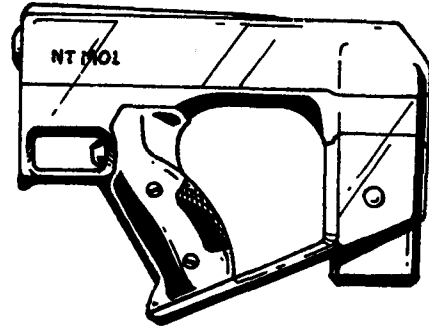

## ATA 003, "Boom-Boom" Hard Ammo Sidearm

The wonderful thing about this little construction is that it's civilian legal. Through careful manipulation of the Administrators' rules and regulations, the guys at Advanced Technology Australia have given the people the Boom-Boom. It uses an E-clip with the EIPP plasma system. It's a loud, loud gun, and needs to be reloaded by a breach action of the barrel. And yes, it is a handgun and can be used with one hand. However, a P.S. of 15 is required without using the other arm to brace.

Weight: 4.5 lb. (2 kg).

Damage: 4D6 M.D.

Rate of Fire: One shot per action, and one action to reload each slug.

Range: 300 feet (91 m).

Payload: 5 slugs when fully loaded; 30 charges in the E-clip.

Cost: \$32,000; \$4500 for a new E-clip, and \$25 for each EIPP slug (\$125 for five).

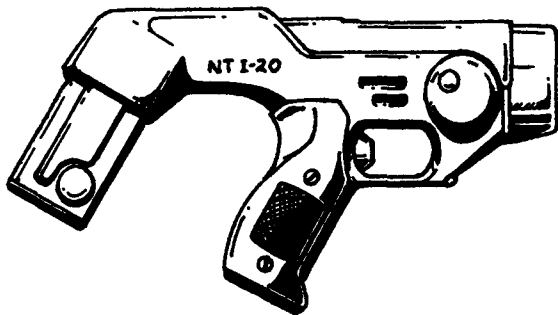

## NeraTech I-20, "Mankiller" Ion Pistol

When S.D.C. firepower is futile against hard armored opponents such as those wearing homespun or environmental M.D. body armor, or hiding in an M.D. automobile, and innocent, unprotected (Hit Point/S.D.C.) people might get caught in the line of fire, or the use of M.D. weapons would destroy property, the City Police and Military pull out this little sucker. The "Mankiller" is a very low-powered energy pistol that, in theory, virtually ignores hard armor, passing right through most hard objects, but sears flesh. It is used by the City Police, Military and special Outback City Agents to bypass a criminal or raider's body armor and inflict damage direct to the S.D.C. and Hit Points of the person underneath!

In the alternative, it can be used on any S.D.C., flesh and blood opponent without damage to clothing or the exterior of windows or non-military vehicles. It can ignore up to an inch of

M.D. armor plating (i.e. most body armor, but not Power Armor) and plays havoc with electrical systems, to the point of shutting them down or frying computer processors.

The disadvantage to the weapon is that it has a very low rate of fire. There are very stringent laws against this gun, as destruction of technology is a capital offense, and a stray shot could be very harmful to the city. Restricted to Police and Military use, with special exceptions made for bodyguards of important officials and select Level 5 citizens. **Note:** This weapon has become the most coveted of all by Outback raiders, criminals and thieves who can use it to kill an opponent without seriously damaging M.D. body armor, vehicles, clothing, etc. Many will pay (or more likely trade) up to \$130,000 for one!

Weight: 3.5 lb. (1.6 kg).

Damage: 4D6 H.P./S.D.C. to living targets. The beam will ignore up to 90 M.D.C. of armor before the special effect is blocked. If the M.D.C. of heavy body armor is battered and worn down by damage from other weapons, then this weapon may penetrate to damage the wearer and/or fry electronics housed within or behind that armor. To score such a hit, the shooter simply aims and shoots as normal. To target electronics, the player must announce *called shot* and roll a 15 or higher on the strike roll. Failing the called shot, but successfully striking the target, results in no electrical damage, but S.D.C./H.P. damage to the character inside. If the called shot succeeds, electrical systems begin to malfunction as they are disrupted. This results in -1 to combat rolls and -10% to any skill checks involving

electronic devices (radar, communications, special helmet optics, HUDS, etc.), until it is replaced or repaired. Multiple blasts to electronics **have** an accumulative effect. **Note:** Cannot punch through or interfere with environmental Power Armor, robots or cyborg armor even when that armor is beat to hell — it is thicker and more resistant to outside attacks and disruption.

Rate of Fire: Each blast counts as one melee attack.

Range: 500 feet (152 m).

Rate of Fire: Single shot; each blast counts as one melee attack.

Payload: 30 shots to an E-clip.

Cost: \$52,500; \$5500 for a new E-clip, \$2600 to recharge.

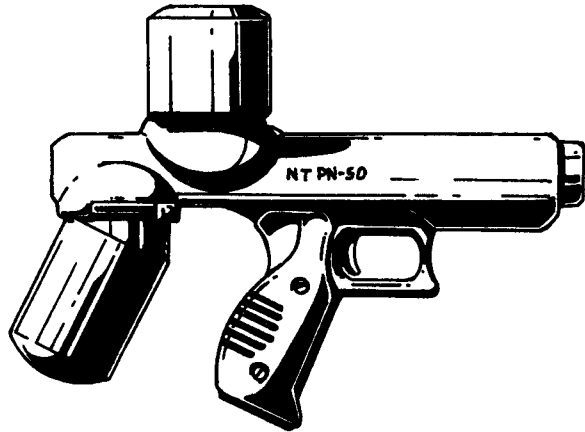

### NeraTech Pn-50, "SplatterGun"

A paint-ball gun that uses pneumatic pressure to pump out its payload. Not very accurate or far reaching, but very effective. It can release modules containing nerve gas, bio-toxins, sleep agents, molecular acid or even paint, just for fun. And the best part? Very little environmental damage is done — and we wouldn't want to damage our fair city now, would we?

Weight: 1.8lb. (.8 kg).

Damage: Varies as follows.

Acid: 4D6 S.D.C. or 2D6 M.D., depending on what type of target it hits, in a one yard/meter splatter radius.

Sleep Agent: Opponents not wearing environmental body armor must roll to save vs non-lethal poison (16 or higher) or fall asleep within 1D4 melee rounds. The area affected has a radius of one yard/meter per pellet fired. Victims sleep for 1D4+2 minutes per pellet of exposure.

Toxin or Nerve Gas: Victims not wearing environmental body armor must *save vs lethal poisons* (12 or higher). If the save fails, the target is racked by convulsions (incapable of fighting or running), suffers 1D6x10 damage direct to Hit Points (1D4x10 M.D. if a Mega-Damage creature), and will lapse into unconsciousness for 2D4+4 minutes. Even if the save is successful, the target takes 1D6+1 direct to Hit Points (or M.D.C.). The gas cloud has a one yard/meter radius per pellet fired. Demons, characters in body armor or under some other suitable shielding are immune to this nasty effect. injecting oneself with an anti-nerve agent will reduce damage of the gas or toxin by half and the victim will not lose consciousness or suffer from convulsions, and can continue to fight.

Rate of Fire: Standard, including bursts!

Range: 60 feet (18.3 m).

Payload: 18 pellets to a clip.

Cost: \$2500; \$40 for a new clip of paint, \$1200 for sleep agent, \$20,500 for toxin or nerve gas, \$2700 for acid. Also, \$50 for a

new compressed air module, or the old one can be refilled for \$10. Anti-nerve agent serum costs \$1200+ per single injection.

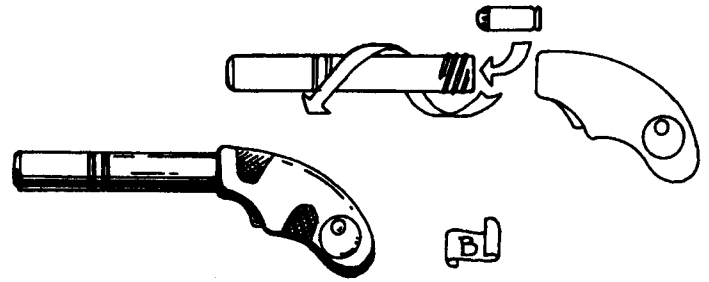

### ATA P-2/10 "Popper" High-Powered Derringer

Another M.D. weapon that has snuck into civilian legality, but this time because of its small size and influence from Level 4 & 5 citizenry. It's pretty ineffective against armor, but it chews through soft (S.D.C.) targets. Again, ATA have used their EIPP plasma propellant, so a small battery is required. The weapon is only the size of a pen flashlight and can fit in the palm of the hand or up a sleeve.

Weight: 0.5 lbs. (0.23 kg).

Damage: 1D4 M.D.

Rate of Fire: Once before reloading.

Range: Accurate to 20 feet (6.1 m), but the bullet may travel up to 100 feet (30.5 m), and is -3 to strike when a target is beyond 20 feet (6 m) and only does one M.D. or 100 S.D.C.

Payload: 1 bullet; 20 shots per battery.

Bonuses: +1 to strike when within 20 feet (6.1 m), -3 when outside that range.

Cost: \$6,600; \$600 for a new battery, and \$10 for a new slug.

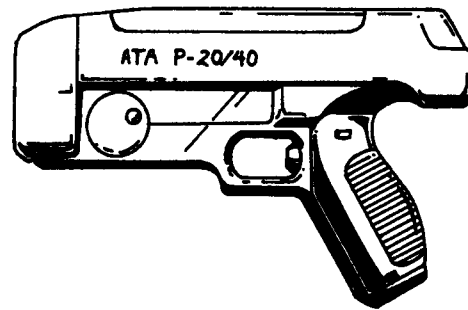

### ATA P-20/20, Plasma Sidearm

The heaviest of all the handguns produced by ATA, this is a serious piece of hardware that is restricted to Police and Military use outside city limits. Like most plasma weapons, it's heavy and not terribly accurate, but packs quite a punch.

Weight: 4.8 lb. (2.2 kg).

Damage: 4D6 M.D.

Rate of Fire: Standard.

Range: 1000 feet (305 m).

Payload: 12 shots to a clip.

Cost: \$27,000; \$5500 for a new E-clip, or \$2600 to recharge.

### ATA "Pinpoint" Needler Handgun

An elegant weapon, this uses an EIPP system to expel a very fine needle with varying results. The weapon has two settings: high and low power. At high power, against soft targets, the needle is so fine it will pass through with minimal trauma. But

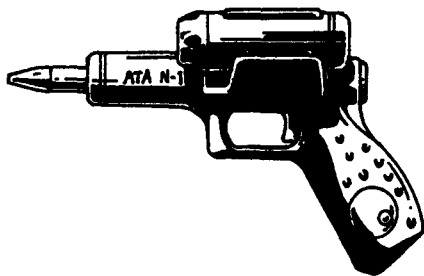

at low power it will stick, causing damage, plus the needle can be drugged. A high velocity needle will, however, penetrate M.D. armor with little difficulty and deliver its cargo once lodged in the target beneath. Cunning, also, is the design of the needle, which has an internal case that dissolves and releases the drugs. Clips of dry needles are available, mainly for practice.

Weight: 2 lb. (.9 kg).

Damage: Low Power: Needle will stick into S.D.C. targets and do 1D4 damage. At this setting it can be used to deliver drugs. Drugged needles do 4D6 S.D.C. damage if a save vs harmful drugs fails, or 1D6 if the save succeeds. Or it can deliver a sleeping agent with a similar effect as the "sleep agent" of the **SplatterGun**. Neither drug will affect M.D.C. creatures.

High Power: The Needle does 1D4 M.D. against M.D.C. targets, and can deliver a drug or toxin to M.D. creatures (usually with minimal effect due to their superhuman and alien metabolisms).

Rate of Fire: Standard.

Range: 250 feet (76.2 m).

Payload: 30 needles to a clip, and 100 shots to a battery.

Bonuses: +1 to strike when aimed.

Cost: \$19,500; \$400 for a new clip, \$1200 if drugged. A new battery costs \$900.

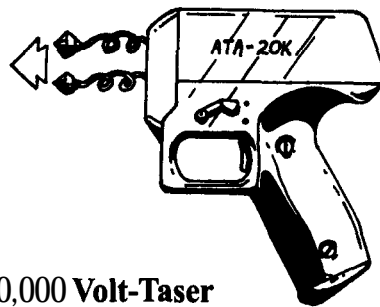

### ATA "20K" 20,000 Volt-Taser

Personal security at its best. This **taser** uses two trailing wires to send a high voltage current into the victim, rendering him unconscious. The amperage can be adjusted, so the taser can even be lethal if used correctly. The civilian versions *cannot* be adjusted, and are moderately mild compared to what the police and military are allowed.

Weight: 1 lb. (.45 kg).

Damage: 1D4 S.D.C. damage and the victim must save vs pain (14 or higher) or be stunned for 2D4 minutes. A successful save means the victim loses 1D4 melee actions (that melee round and may spill into the next) and combat bonuses are halved, but he remains conscious and angry.

The higher grade Police and Military version does 2D6 damage to Hit Points/S.D.C. regardless of save, in addition to the usual effects, and requires a 16 or higher to save.

Rate of Fire: Standard, but the wires take one melee action to reel back in if they miss.

Range: 10 feet (3 m). Direct contact versions are available, and are considered melee weapons.

Payload: 30 charges to an E-clip.

Cost: \$7000; \$5500 for a new E-clip/battery.

Note: Not effective against opponents in environmental body armor (but is good against homespun armor) or M.D. creatures.

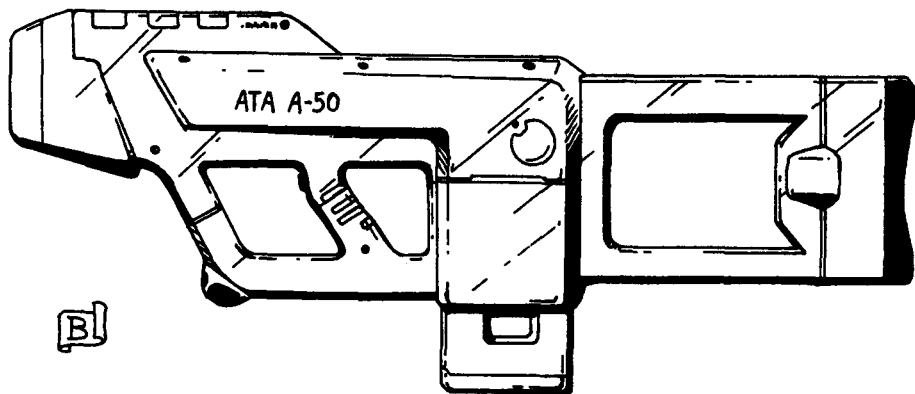

### ATAA-50, "Icer" Energy-Arc Thrower

Always innovative, Advanced Technologies Australia (ATA) have come across the first true variation of the laser rifle since ion weaponry. The A-50 uses a low-powered laser, but this is not the method of attack. The *laser simply ionizes the air in a straight line which then* allows a high voltage charge to be conducted along this pathway to the target. The result is a high energy drain on the E-clip, but a very destructive "lightning bolt" effect. The weapon is very obvious when fired, quite loud and not very accurate, but is well loved for its high intimidation factor and "spray" capacity.

Weight: 11 lb. (5kg).

Damage: 3D6 M.D.

Rate of Fire: Standard.

Range: 600 feet (183 m).

Payload: 10 shots from a single E-clip, and 20 with a long clip.

Bonuses: +2 to strike when within 100 feet (30.5 m), -2 when outside that range.

Cost: \$32,500; \$5500 for an E-clip, and \$12,000 for a long E-clip.

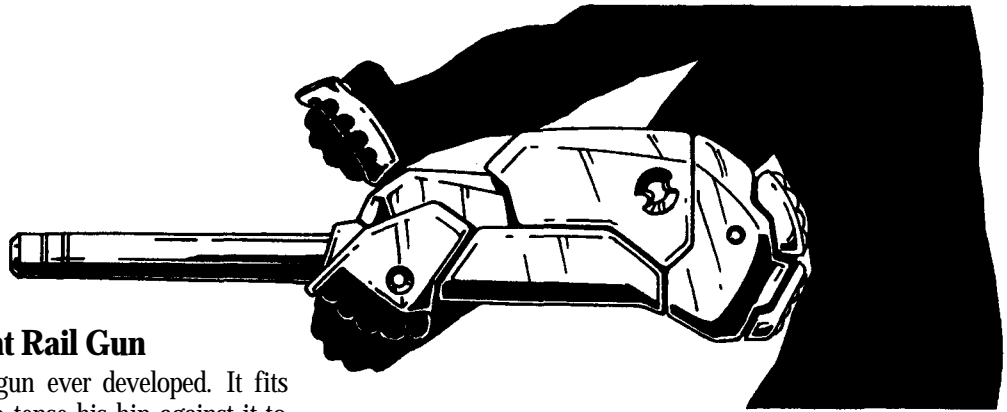

### NeraTech "Fletcher 12" Light Rail Gun

Quite possibly the smallest rail gun ever developed. It fits against the torso, and the user has to tense his hip against it to withstand the recoil. It fires single slugs, and makes half the noise of your typical rail gun. TRG groups like it because it's highly destructive but easy to control and damage is localized. It can also be ground-mounted and used as an ambush sniping weapon (despite the noise) or mounted on a vehicle. A P.S. of 15 is needed to fire the weapon, otherwise the character takes 1D4 S.D.C. himself every time the gun is fired, regardless of armor.

Weight: 12 lbs. (5.4 kg).  
Damage: 3D6 M.D. per single round.  
Rate of Fire: Standard.  
Range: 2000 feet (610 m).  
Payload: 20 shots per ammo-clip or 100 per drum (weighs 10 lbs/4.5 kg).  
Cost: \$54,000; \$6500 for a new ammo drum.

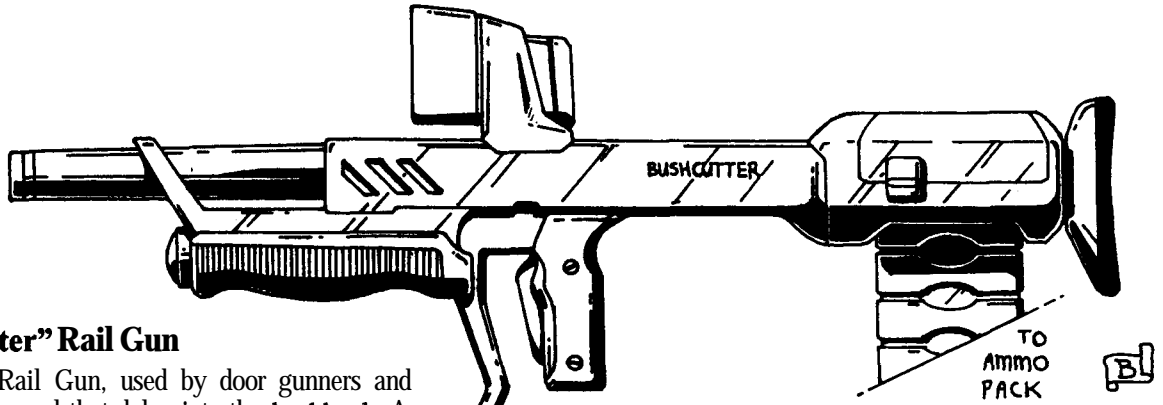

### NeraTech "Bushcutter" Rail Gun

This is your typical Rail Gun, used by door gunners and other hardier military personnel that delve into the bushlands. A P.S. of 22 is required, or it can be used with a bipod mount.  
Weight: 24 lbs (10.8 kg) plus ammo (15-40 lbs/6.8 to 18 kg).  
Damage: 4D6 M.D. per burst of 12 rounds.  
Rate of Fire: Only fires bursts of 12 rounds. Each burst counts as one melee attack.

Range: 3,000 feet (914 m)  
Payload: 120 round mini-clip (10 bursts), 360 round belt (30 bursts) or full 1440 drum (120 bursts).  
Cost: \$110,000, \$2,000 for a mini-clip, \$8000 for a new belt, \$24,000 for a drum.

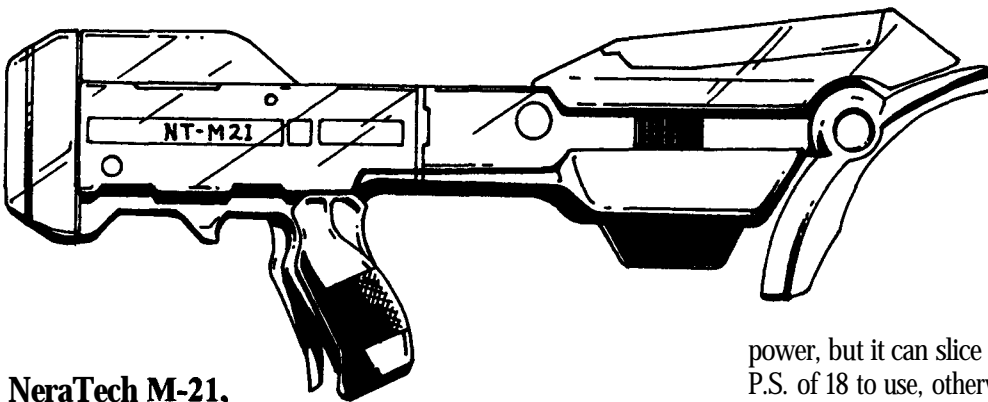

### NeraTech M-21, Heavy Particle Beam Cannon

This is the heaviest Military personnel weapon available. It is hefty, shoulder mounted, and requires a backpack to supply its

power, but it can slice armor like it was tissue paper. Requires a P.S. of 18 to use, otherwise -2 to strike even when aimed.  
Weight: 35 lb. (29.3 kg).  
Damage: When rolling to hit, if the strike roll is 17 or less but still hits, the damage is 1D6x10 M.D. If the strike roll hits and is 18 or more, the damage is a blistering 2D4x10 M.D.!

Rate of Fire: Twice per melee round; each shot counting as one melee attack.

Range: 2000 feet (610 m).

Payload: 30 shots to a backpack unit; cannot use E-clips.

Cost: \$295,000; \$48,000 for a new E-pack, \$12,500 to recharge it.

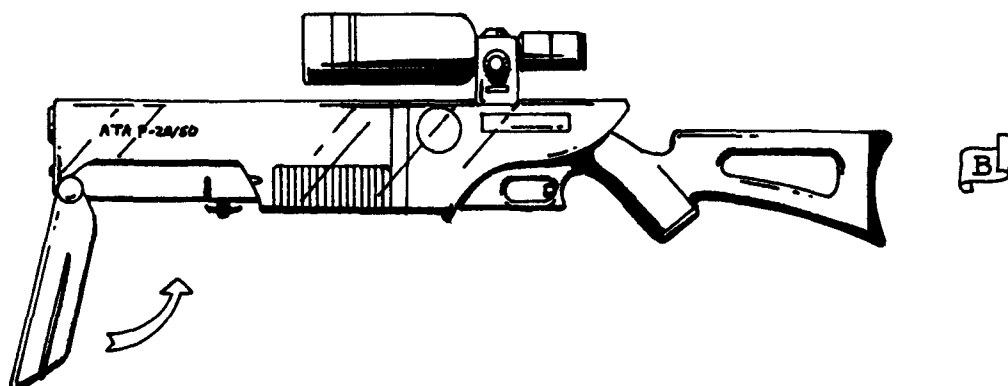

### ATA P-20/50 Variable Frequency Sniper Rifle

The highest-grade rifle available, it is limited to use by TRG and special operation "wet-works" military teams. It can be collapsed down — doing so takes about one melee round by a skilled character (1D4+2 if not) — and fitted into a case. It also has a fold-down bi-pod, excellent scopes and recoil compensation, as well as a form-fitting "squeeze" trigger and the variable laser settings common to the Juicer Rifles of North America. That is, after one full melee round, it can be adjusted to do full damage against laser resistant armors by finding the right frequency to fire at. What makes this weapon unique is that a passive targeting laser can be used to "paint" the target and determine the frequency first, without firing the gun! If a sniper spends a round doing so, his next shot against an armored opponent will do full damage.

Weight: 9 lb. (4.05 kg).

Damage: Three settings: 4D6 M.D., 3D6 M.D., or 1D6x10 S.D.C.

Rate of Fire: Each shot counts as one melee attack; ideal for sniping.

Range: 3000 feet (914.4 m).

Payload: 12 shots per standard E-Clip, 24 shots with a long E-clip.

Bonuses: +1 to strike when aimed.

Cost: \$57,000; \$5,500 for a standard E-clip; \$10,000 for a long one.

### ATA "Mega-20" Shotgun

Again, ATA has broken all the rules and produced the master of all shotguns. This is an impressive weapon indeed, but has a recoil that requires a P.S. of 15 to brace against (otherwise 1D4 S.D.C. damage to the user, due to recoil). Again, they have employed their patented EIPP system to produce a weapon of frightening destructive power. Thankfully, it can be set to fire like a standard shotgun by disengaging the battery, doing S.D.C. damage instead. This is a rare weapon, and is unlikely to be found easily. The military has them, but sees little use in them, and the civilian population can't touch them.

Weight: 11 lb. (5 kg).

Damage: 1D4x10 M.D. or 1D6x10 S.D.C., depending on firing mode.

Rate of Fire: Two shots per melee round maximum.

Range: 80 feet (24.4 m).

Payload: 10 slugs to an internal magazine, and 50 shots out of the battery.

Bonuses: None.

Cost: \$43,000; \$25 for a slug, and \$3000 for a new battery.

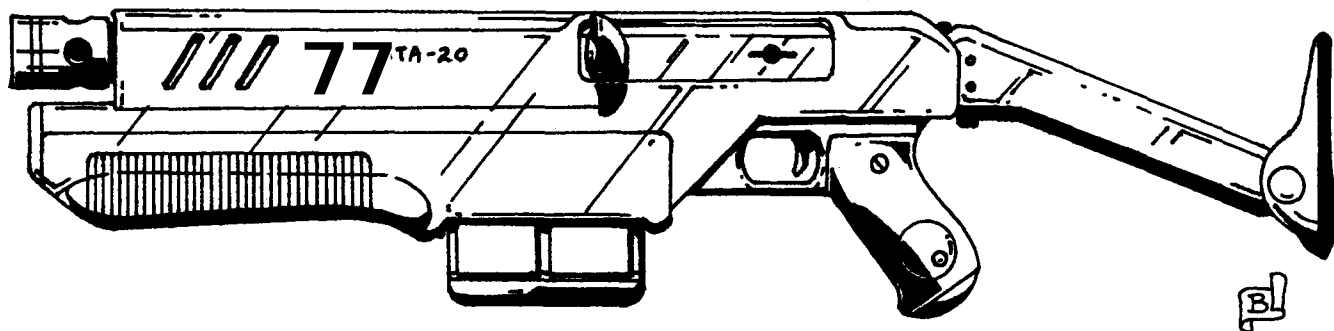



## Outback Armor

Also known as “Homespun” armor, “homemade” armor, “patchwork” armor.

In the Outback, armor is usually homemade, constructed from spare parts, salvaged pieces of S.D.C. & M.D.C. armor, metal, ceramic, leather jackets, bald car tires, flattened or opened out tin cans, bamboo, strips of wood sewn onto cloth, quilted canvas, car body parts (S.D.C. & M.D.C.), animal hides (S.D.C. & M.D.C.), and other pieces of scrap. Obviously, M.D.C. materials are the most valuable and coveted, but even homespun armor that is entirely made of M.D.C. materials is rarely an environmental suit (less than one percent). If a character wants to make his own armor, he will have to gather the appropriate materials and possess the Armorer or Mechanical Engineering skill. **Note:** Once the materials and tools are acquired, building the armor by oneself costs only time. It takes approximately one **day's** work per 2D4 points of M.D.C. in the armored suit (80 maximum).

Otherwise, one must find somebody who can do the work for him. Many outback towns (and some bands of Roadgangers) have one or more craftsmen or shops capable of building body armor. Some Trade Merchants and City Traders also sell homespun armor (occasionally stolen, captured or used City environmental armor). Many also have connections that enable them to get armor custom-made for a client; 50-60% of the money paid up **front**, the balance upon delivery. While one may find Traders or shops with ready built armor (tailored to the purchaser as necessary), many will custom build suits within 1-3 weeks. The price is roughly 50-60% less if the client provides the materials. Furthermore, such professional armorers are often willing to trade their services to make a suit in exchange for spare materi-

als suitable for making one or two additional suits of armor that they can sell or trade later for a profit.

Apart from the dealing, trading and searching involved to get body armor or the materials to get a suit made, the cost is approximately as follows (price will vary from place to place and depend on demand):

### S.D.C. Body Armor

\$10 per point of S.D.C. (200 S.D.C. maximum; roughly the equivalent of two M.D.C.).

**\$100** per point of A.R. above 7 (maximum is A.R. 17).

### M.D.C. Body Armor

\$500 to **\$1,000** per point of M.D.C. (80 M.D.C. maximum). A typical suit is around 40-60 M.D.C. and has a movement penalty of **-15%** to prowl, swim, climb, gymnastics, acrobatics, and similar skills. Homespun armor with 35 or less M.D.C. typically has a movement penalty of **-7% to -10%**.

Most have a helmet and afford good to excellent protection but are not environmental. This means they are not airtight nor have an air circulation system, so the wearer is vulnerable to **rain/water**, heat, gases, disease, pollution, radiation and other environmental hazards.

\$50,000-75,000 to make a suit of homespun armor full-environmental (the components are rare and may not be available even if the character has the money or trade goods; G.M.'s discretion).

Once all the materials and components are gathered, the character needs to assemble them into a workable suit of armor. If the character possesses any engineering or field armorer skills, he can build the armor himself (takes time to build), otherwise he'll need to find somebody who can build it for him. The cost of building the armor is typically equal to or as much as 50% greater than the cost of the components.

### **Some Common Types of Homespun Armor**

Note: Modern materials make the A.R. and S.D.C. a bit different than traditional ancient types of armor.

#### **Basic S.D.C. Armors**

**Quilted Cloth:** A.R. 7, S.D.C. 10-15, \$100-\$200

**Quilted Leather:** A.R. 10, S.D.C. 20-25, \$200-\$300

**Quilted Cloth with Wood:** A.R. 11, S.D.C. 25-30, \$275-\$400

**Quilted Cloth or Leather with Metal:** A.R. 12, S.D.C. 30-35, \$400-\$500

**Leather with Rubber (tires):** A.R. 12, S.D.C. 35-40, \$550-\$700

**Leather with Metal, Chain Mail or Ceramic Inserts or Studs:** A.R. 13, S.D.C. 40-50, \$650-\$800

**Metal, Traditional Chain Mail:** A.R. 14, S.D.C. 40-50, \$700-\$900

**Metal or Chain Mail with Leather and Rubber:** A.R. 15, S.D.C. 60-100, \$600-\$900

**Metal Scale or Splint Mail:** A.R. 16, S.D.C. 80-130, \$800-\$1000

**Metal: Full Suit:** A.R. 17, S.D.C. 80-200, \$900-\$1500

**Metal Shield:** S.D.C. 30-50, \$200-\$400

**Wooden/Leather Shield:** S.D.C. 30, \$385

#### **Basic M.D.C. Armors**

**Note:** Although Armor Ratings (A.R.) are given for each type of armor, Kevin and I suggest you dispatch with A.R.

whenever M.D.C. combat occurs (i.e. a roll above A.R. normally means the attack penetrates the armor and hits the character inside. If an M.D. attack, most characters would be instantly killed even by one M.D. point). Instead, only use the A.R. when the combatants are both using S.D.C. weapons. When M.D. combat occurs, assume that the M.D.C. of the body armor protects the character until it is reduced to zero, but remember that the wearer of homespun M.D. armor is vulnerable to gases, heat, etc.

**Heavy-Duty Ballistic Cloth:** A.R. 14, M.D.C. 10-12, \$5000+

**Pre-Rifts Bullet-Proof Vest:** A.R. 15, M.D.C. 25, \$10,000+

**Pre-Rifts Light Body Armor:** A.R. 16, M.D.C. 30-35, \$15,000+

**M.D. Body Armor (salvage) combined with additional M.D.C. Rubber or other M.D.C. Materials:** A.R. 16, M.D.C. 35-60, \$20,000+

**M.D.C. Metal or Chain Mail combined with Leather and M.D.C. Rubber:** A.R. 16, S.D.C. 50-80, \$30,000 to 50,000+

**M.D.C. Metal and/or M.D.C. Chain Mail or Ceramic:** A.R. 18, M.D.C. 60-90, \$40,000 to 55,000+

**M.D.C. Metal Alloy Armor:** A piecemeal hodgepodge of salvaged high-tech body armor with other advanced alloys from M.D.C. vehicles, and the occasional other M.D.C. material (bone, teeth, ceramics, etc.). A.R. 17, M.D.C. 60-100, \$50,000 to \$100,000!

**M.D.C. Composite Animal Armor:** Commonly nicknamed "All Natural," this armor is made from the hide, bones and plates of wild Mega-Damage creatures. The tusks, bones and particularly the plate-like spine **fins** of the Razorback are frequently used to make armor. To a lesser degree, the tough hide of the Giant **Kang** (equal to one M.D.C. point) and the tusks, teeth and bones of the Kang, Sand Fiend and other M.D.C. creatures are frequently used in homespun armor, often combined with M.D.C. wire, tires, chain mail and metal fragments. This "composite" armor is among the most common in the land and has A.R. 13+1D4, M.D.C. 45-80, cost: \$30,000/460,000.

**M.D.C. Alloy Shield:** M.D.C. 25-40, \$10,000+

**Note — Mobility Penalties:** Most types of homespun body armor have a -10% to -15% penalty to climb, and a -15% to -20% penalty to prowl, swim, perform acrobatics, gymnastics and similar physical skills.

Also see High-Tech Armor from the Tech-Cities.

## High-Tech M.D.C. Body Armor

High-Tech Armor is manufactured by the two Tech-Cities, Perth and Melbourne. Such M.D.C. and environmental armor is typically only available to the Police, Military, Level Five Citizens, and Special Operators and agents, like the City Traders. City armor sometimes finds its way into the Outback as a result of limited trade between City-Agents and **Outbackers**, but is more likely to have been smuggled out of a Tech-City, stolen from a military outpost or patrol, or peeled from the corpse of its original owner (those holes in the chest from laser fire can be patched, helmets can be replaced and scorching can be covered by paint). City-Armor damaged in combat is frequently scav-

enged and salvaged for parts and used to make homespun armor (add a piece of tire here, some spikes and paint there, etc.). Pre-Rifts body armor is also uncovered from ancient ruins, and other types of M.D. armor can be scrounged from D-Bees, outsiders and invaders, but these are all fairly uncommon turns of events. The bottom line is that outside the Tech-Cities, modern, Mega-Damage, environmental body armor is a rarity in Australia. Furthermore, the two Tech-Cities recognize the superiority and power their advanced technology and manufacturing provides them, and are careful to limit the *official* availability of Mega-Damage armor, weapons, vehicles and other advanced technology to the "barbarians" beyond the defensive walls and ivory towers of their powerful cities.

## Base-4 Armored Clothing

By Ben Lucas & Kevin Siembieda

Base-4 is a revolutionary, "miracle" Mega-Damage fiber developed a few years before the Great Cataclysm. Hundreds of corporations around the world had been trying to develop a super-lightweight fabric with the tensile strength of Mega-Damage steel. A company with facilities in both Perth and Melbourne (among others) developed the Base-4 miracle fabric, a technological advancement that threatened to revolutionize space exploration, fire-fighting and combat. The material is about twice as heavy as normal fabric, and with the padding and strategic placement of (comparatively) lightweight M.D.C. ceramics, which is common in light M.D.C. "cloth" armor, it is roughly the equivalent of wearing a long leather coat or heavy trench coat.

As an M.D.C. material, the Base-4 "fabric" could be used to make *ordinary looking jump suits*, business suits, fatigues, jackets, coats and ponchos that afford the wearer significant M.D.C. protection, especially if combined with additional concealed plating. Even as a simple fabric, Base-4 gives the wearer significant protection, particularly against energy weapons. Most energy blasts have little, if any, physical impact, so the "fabric" can easily protect against it, blocking the brunt of the blast. The addition of extra padding and strategic plating makes it very effective against light M.D. weapons such as handguns and light rifles.

The weakness of the Base-4 material is that it is less effective against explosives, mini-missiles and projectile weapons (i.e. rail guns). This is the main reason such weapons are very uncommon at Perth and Melbourne, and limited only to military applications (and even then, typically restricted to operations *outside* the Cities' walls). Consequently, Mega-Damage explosive and projectile weapons, while stopped by the armor, will also inflict S.D.C. damage to the wearer and knock him off his feet (losing initiative and one melee **attack/action**). Every 12 points of M.D. damage inflicted will do 1D4 S.D.C./HitPoint damage. So an explosion that does 37 M.D.C. will do 3D4 points of S.D.C. damage.

**Note:** Base-4 is lost to the rest of the world, although there are a few other fabrics and armor that are vaguely similar.

### Police Jump Suits, Military Flight Suits,

### Undercover Clothing & Similar

**Appearance:** Ordinary looking business suit, dress, jacket, coat, poncho, fatigues, jump suit, and similar article of clothing



that covers all or most of the body (often comes with a pull-over hood or helmet). See page 106 for an illustration.

**Weight:** Roughly three times the weight of the equivalent article of clothing — approximately 10-12 pounds (4.5 to 5.4 kg) for the entire M.D.C. ensemble.

**Mobility Penalty:** Typically -2% to climb, and -5% to prowl, swim, perform acrobatics and similar physical **skills/performance**.

M.D.C.: 8-12 — nonenvironmental.

**Market Price:** \$10,000 per set of clothes in the Tech-Cities, two to three times that in the Outback.

## M.D.C. Armored Trench Coat

An ordinary looking coat made of Base-4, but with padding and M.D.C. plates along the shoulders, chest, stomach and other strategic locations for additional protection. This armor is very popular among City Traders and adventurers. Base-4 clothing may be worn underneath it. See page 67 for an illustration.

**Appearance:** Looks like an ordinary, heavy, trench or long coat (women's styles and Outback undercover work include a cloak) that goes down to just below the knees or as low as the ankles, and has a flip-up collar and either a detachable or pull-out hood (kept in a zipper pocket under the back collar). A helmet (30-50 M.D.C.) comes standard.

**Weight:** Approximately 17-20 pounds (7.65 to 9 kg) for the entire M.D.C. ensemble.

**Mobility Penalties:** -10% for civilians (i.e. Level 5 Administrators), -5% for Police, Military, City Traders and other combat or wilderness trained personnel. Typically none to climb, prowl, swim, perform acrobatics, gymnastics and similar physical skills.

M.D.C.: 25 — nonenvironmental.

**Market Price:** \$15,000 in the Tech-Cities, two to three times that in the Outback.

## M.D.C. Light Anti-Assassin Vest

This is used by Police, Military and TRG undercover agents as well as some Level 4 & 5 citizens who fear for their lives. It is a simple padded vest with some additional armor to protect the chest and belly. It is low profile and usually **unnoticeable**, even at close range; detectable only upon close inspection and "patting the wearer down."

**Appearance:** Looks like an undergarment or extra shirt to keep warm. It is easily concealed beneath an ordinary **shirt**, suit coat, etc.

**Weight:** Approximately 5 pounds (2.25 kg).

**Mobility Penalties:** None.

M.D.C.: 15 — nonenvironmental and protects upper torso only.

**Market Price:** \$6,000 in the Tech-Cities, two times that in the Outback.

## M.D.C. Flak Vest

Standard for all Helicopter Gunners and Patrol Boat Crewmen (with **flotation** device built into it), as well as used by police officers, special agents and the occasional Level 5 Administrator. A Flak Vest is a protective vest made of **Base-4** materials with alloy **and/or** ceramic plate and padding inserted. It is designed to cover and protect only the chest, stomach and groin areas, allowing for unencumbered movement of the arms and legs, but it also leaves them unprotected. Comes standard

with a helmet (30 to 50 M.D.C.) and **Base-4** clothing may be worn underneath it. Has the Equivalent of an A.R. 12, meaning a roll to strike of 13 or higher will hit an exposed limb.

**Appearance:** Looks like a heavy, obviously padded or plated vest, although it can be concealed beneath a bulky jacket, coat, cloak or poncho.

**Weight:** Approximately 15 pounds (6.75 kg).

**Mobility Penalties:** -5% for civilians to climb, prowl, swim, perform acrobatics, gymnastics and similar physical skills. None for Police, Military, City Traders and other combat or wilderness trained personnel.

M.D.C.: 30 — nonenvironmental and protects the torso only.

**Market Price:** \$15,000 in the Tech-Cities, two times that in the Outback.

## Police M.D.C. Armored Jump Suit

The City Police of both Melbourne and Perth wear a padded jump suit and boots made of **Base-4** material with additional M.D.C. metal alloy or ceramic plates located in the chest, along the shoulders, arms, hips, knees, calves and head. The standard light helmet comes with a built-in radio communications system and gas mask and air filter, plus the helmet (50 M.D.C.) easily fits over the standard communications rigging and head protection. See page 110 for a complete illustration.

**Appearance:** Jump suit style uniform; standard.

**Weight:** Approximately 15 pounds (6.75 kg).

**Mobility Penalties:** -5% to climb, prowl, swim, perform acrobatics, gymnastics and similar physical skills.

**M.D.C. by Location:**

Head with light protection — 28; nonenvironmental.

Head with full protective helmet — 50; environmental.

Arms — 22 each

Legs — 28 each

Main Body — 35

**Note:** The addition of a full protective helmet seals the suit and makes it an environmental body armor system.

**Market Price:** \$25,000 in the Tech-Cities, two to three times that in the Outback.

## Police & TRG M.D.C. Riot Armor

The City Police and Anti-Terrorist Response Teams (i.e. the TRG) of both Melbourne and Perth are issued medium combat armor, sometimes referred to as SWAT or Riot Gear. This suit is basically the police armored uniform combined with a heavy flak vest and additional armor and padding. The chest, stomach, groin, hips and shoulders are especially protected. The standard helmet comes with a multi-optic system.

**Appearance:** Medium Environmental Body Armor.

**Weight:** Approximately 20 pounds (9 kg).

**Mobility Penalties:** -5% to climb, and -10% to prowl, swim, perform acrobatics, gymnastics and similar physical skills.

**M.D.C. by Location:**

Head/Helmet — 50

Arms — 22 each

Legs — 32 each

Main Body — 55

**Note:** Riot shield (40 M.D.C.; costs \$10,000) is optional and does 1D6 S.D.C. damage when used as a blunt weapon to butt, push and strike.



**Market Price:** \$28,000 in the Tech-Cities, two to three times that in the Outback.

## Special Ops Heavy Combat Armor

Restricted to Military use only. Full plate armor using light M.D.C. metal alloys, ceramics, and Base-4 materials. Like the police, it comes standard with both a light, padded headgear with an open face and built-in communications system and a full environmental helmet that fits over the light headgear. See page 124 for illustration.

**Appearance:** Heavy Environmental Body Armor.

**Weight:** Approximately 28 pounds (12.6 kg).

**Mobility Penalties:** -10% to climb, and -25% to prowl, swim, perform acrobatics, gymnastics and similar physical skills.

**M.D.C. by Location:**

Head/Helmet (light) — 30; non-environmental.

Head/Helmet (heavy) — 70; environmental.

Arms — 60 each

Legs — 75 each

Main Body — 115

**Market Price:** Not available to the public; Military use only! \$125,000-180,000+ in the Outback; highly prized.

## "Trencher" Body Armor

This suit is a fully sealed environmental armor used by the Military Forces and Tactical Response Groups (TRG) of both Perth and Melbourne. It comes equipped with a cooling system, one hour independent oxygen supply and various other features common to full-environmental suits of armor worldwide. A matte camouflage pattern is used for military operations when the troops "go bush" — i.e. into the **bush/wilderness**. It does not reflect the sun and is hard to spot in the wild. It gets the nickname, "Trencher" because it is a sturdy, reliable suit of armor

used by all facets of the Army and the soldiers "in the trenches." Troops suit up in Trencher armor when on Wall guard duty, any patrols outside the walls and into the wilderness, and when engaging hostile forces in or out of the Tech-City. The Navy has a similar body armor with a different paint job and slightly different styling. For Outbackers and enemies of the Tech-Cities, the Trencher body armor has come to symbolize the power and menace of Melbourne and Perth. They are instantly recognized as City-Troops to be feared and avoided, which is why any Outbacker who may come to possess Trencher armor, immediately repaints it and makes customized changes (different helmet, color, spikes and such) to avoid being attacked as a hated and despised City-Soldier.

The standard helmet has goggle-eyes and air filters protruding from the chin of the helmet. There are slight variations in helmet design, armor color and **insignias** to distinguish between the various divisions (see page 113 for the TRG variant at Melbourne).



**Appearance:** Medium Environmental Body Armor.

**Weight:** Approximately 23 pounds (10.35 kg).

**Mobility Penalties:** -5% to climb, and -10% to prowl, swim, perform acrobatics, gymnastics and similar physical skills.

**M.D.C. by Location:**

Head/Helmet (light) — 30; nonenvironmental.

Head/Helmet (heavy) — 60; environmental.

Arms — 40 each

Legs — 60 each

Main Body — 70

**Market Price:** Not available to the public; Military use only! \$75,000-130,000+ in the Outback; highly prized.

# Power Armor

Power armor in the Outback is extremely rare and greatly coveted. Those suits that do exist are kept in remarkable condition and often passed on from generation to generation. No new power armor suits have been produced in the Outback for centuries. The armors encountered in the wilderness have either been procured from one of the two Tech-Cities (usually illegally) or are **pre-Rifts** or foreign suits that have been acquired and maintained or stripped down, rebuilt, modified, repaired and jury-rigged for decades; in some cases, for centuries. Most have been modified and repaired many times with patches or extra armor plates welded into place, or augmented with spikes, studs, weapons, and M.D.C. animal horns, teeth or spines. The occasional relics among pre-Rifts ruins or buried under tons of earth are still found to this day, but such lucky occurrences are rare and the armor's power supply is usually dead — long expired. Getting a new nuclear-based power supply is usually impossible, unless stolen from the Tech-Cities or one of their Military Outposts or Squads — stripping and cannibalizing parts, especially power packs, batteries and such, are commonplace in the Outback. Typically the only way to get high-tech systems is to steal or raid and capture them from City-Operatives.

It is worth noting that the Governments and Militaries of both Melbourne and Perth offer a huge reward to wilderness people who turn in high-tech body armor, power armor and vehicles, even if such items are clearly damaged (but salvageable) or without power. The reason is to keep technology, particularly heavy combat items like power armor, out of the hands of savage **Roadgangers**, bandits, mercenaries and adventurers. The reward is generous and surprisingly fair: generally trade goods worth at least 1-1.5 million Australian dollars (a good negotiator can usually get 2 million), and including such rare and coveted items as high-tech M.D.C. body armor (even Police and Military types), M.D.C. building materials, M.D. weapons, tools, electronics, computers, vehicles (no Military or combat types, nor aircraft), as well as modern clothes, processed food, medicine, and so on — and at City (not Outback) prices. Technical manuals, blueprints, schematics and similar types of information are *not* available. Even the occasional Bushbasher or Rusty Power Armor suit *may* be made available if the trade item(s) is worth it and the trader is a tough negotiator, or he's a wilderness ally or agent of the Tech-City. Unless an agent working for the City, such power armor trades are typically stripped down, basic versions with only one or two weapon systems. **Note:** A handful of Glitter Boys salvaged from pre-Rifts military bases either allied with or supported by the Old American Empire can occasionally be found in the wilderness and settlements of Australia, New Zealand, and periodically, throughout the Pacific. Likewise, occasional old (and new) Japanese, Hong Kong and Korean power armor, robots, vehicles and weapons are unearthed, but a rarity. The Tech-Cities do not make or use Glitter Boys or foreign power armor, bots or vehicles.

## Rusty — Power Armor

This suit of light power armor is known as "Rusty," as well as Rust Buckets, Tin Men, Iron Imps, and Scrap Walkers. The name is an Outback joke inspired by legends of the old Glitter Boys and the clean, shiny power armored troops of the Tech-Cities — the joke being that power armor in the Outback

have lost **their** sparkle and shine. "Rusty" (designated *APAA/Assault Power Armor Alpha* by the Tech-Cities) is a modular suit that is easily customized and modified. It is the most (comparatively) common power armor in the Outback. It was used by the authorities of Pre-Rifts Australia and New Zealand as an all-purpose system suitable for military and civilian applications (the latter included deep sea operations and construction), and was sold to many surrounding nations, as well as having been **knocked-off** in Indonesia and parts of Asia. They are incredibly popular in the Outback because the armor's modular design makes them easy to repair, modify and jury-rig with homemade replacement parts, patches and weapons. Very representative of the "whatever works" attitude of Outbackers.

**Note:** Rusty and the Bushbasher are frequently made available to "City Agents," including City Traders, undercover agents (Military, Special Operations, TRG, etc.) and Outbackers who serve as **snitches/informants**, mercenaries, spies and others who work on the Cities' **behalf** — generally low-life opportunists, criminals, and traitors willing to sell out their fellow Outbackers for a profit **and/or** power. This can include Merchant Traders and Outback settlements who either need the resources available from an "arrangement" (and even Military support) with one of the Cities or which has been "leveraged" (i.e. threatened, bullied or bought) by one of the Cities to serve them in some fashion.

There are also some rumors regarding Rusty and Bushbasher power armor:

1. That a secret Outback community possesses the knowledge and facilities to manufacture both types of power armor and secretly sells them. Some related rumors suggest they support the unification of Australia and will leave the occasional suit or two of power armor for heroes and strong local settlements to secretly support them, but this seems very unlikely.

2. One of the reasons the Tech-Cities are willing to sell the Bushbasher and Rusty power armor on a limited basis is that the armor is "bugged" so that the Cities' Military can track the wearer whenever they want to and that the internal electronics of the armor will secretly activate silent alarms and security forces at the City if it is used to raid or sneak into the city or any Military Outpost (this one is definitely true, although most people don't believe it; **-45%** for an Engineer or Cyber-Specter to identify, locate and successfully deactivate — roll for each).

## Modular Powered Armor

**Official Designation:** Assault Power Armor Alpha (APAA)

**Common Name:** Rusty

**Crew:** One

**Purpose:** Multi-Purpose/General Purpose

**Average M.D.C. by Location:**

Arms (2) — 65 each

Hands (2) — 20 each

Legs (2) — 95 each

\* Head — 60

\*\* Main Body — 200

\* Destroying the head of the power armor will eliminate all forms of optical enhancement and sensory systems. No power armor bonuses to parry, strike or dodge! The head is small and difficult to hit (due to the hunched shoulders of the suit). Thus it can only be hit when a called shot is made, and even then the strike roll is made with a -3 penalty.

\*\* Depleting the M.D.C. of the Main Body will shut the armor down completely, making it useless.

### Speed

Running: 55 mph (88 km) maximum. The act of running does tire out the operator, but at 30% of the usual fatigue rate due to the robot exoskeleton. This speed may be modified and souped up to 70 mph (112 km) for an additional 30,000 **dollars/credits**.

Leaping: The powerful robot legs can leap up to 15 feet (4.6 m) high or 20 feet (6.1 m) across.

Underwater Capabilities: Rusty is an environmental suit capable of sustaining pressure up to a depth of 1200 feet (366 m). Small maneuvering **thrusters** in the belly and back give the armor stability and enhanced movement in and under water — can swim at a speed of 5 mph (4.3 knots/8 km) for an hour at a time. An underwater jet pack can be attached to the **back**, giving the armor a speed of 20 mph (17.2 knots/32 km) for an indefinite period.

Flying: Not possible without a jet pack attached to the back. The standard jet pack has a maximum altitude of 2000 feet (610 m) and a speed of 120 mph (192 km).

### Statistical Data

Height: 8 feet (2.4 m) tall.

Width: From 3 feet (0.9 m).

Length: 3 feet (0.9 m); varies slightly with the different backpacks and attachments.

Weight: 520 pounds (235 kg).

Physical Strength: Equal to a P.S. of 28.

Cargo: A reasonably large, snap-on, hard case backpack (can be substituted for conventional backpacks), plus a small compartment in the torso large enough to hold a handgun, four extra ammo-clips, knife, hand-held radio and other small odds and ends, as well as a holster and belt with six pouches.

Power System: Nuclear with an average life of 20 years.

Market Cost: 1.7 to 2 million in the Outback. Each Weapon System is an extra cost.

### Features and Weapon Systems

**1. Additional Armor.** Extra armor may be added to the body, which further enhances the “**patched-up**” and battered appearance of most suits. The M.D.C. of the main body can be increased by 50% (100 M.D.C.), the other body parts by 20%. Cost: \$800 per point of M.D.C. **Note:** The Military Forces of the Tech-Cities typically have armor with the maximum or near maximum amount of protection; 260-300 M.D.C. for the main body. Basic systems sold or traded to Outbackers and even wilderness agents typically start with 200 M.D.C. for the main body and basic systems. Extra armor and weapons must be acquired elsewhere than the Tech-City.

**2. Varied Attachments:** As noted earlier, a jet pack or underwater propulsion pack can be attached to the back. Other

items include a hook and winch to pull cargo, flame thrower (with an extra fuel tank), sensor packs, long-range radio and/or radar, and similar. Such items typically cost \$15,000-\$30,000 each.

**3. Forearm Weapons:** Forearm Blasters can be built into or attached to the power armor. They are fundamentally the same as the Cyborg weapons described on page 241 of the **Rifts® RPG**. Retractable Blades (also described on page 241 of the RPG) and Chemical Spray, Climb Cord, and Arm Computer (all described on page 240) are also available.

**4. Concealed Vibro-Blades (2):** On the underside of the forearms, opposite the lasers, slots in the lower wrists can contain a pair of 3 foot long, slender Vibro-Blades.

Primary Purpose: Anti-Foliage

Secondary Purpose: Anti-Personnel

Mega-Damage: 2D6

Cost: \$35,000

**5. Shoulder Mounted Heavy Weapon (1):** A larger, heavier weapon can be mounted over the right or left shoulder. It **typ-**

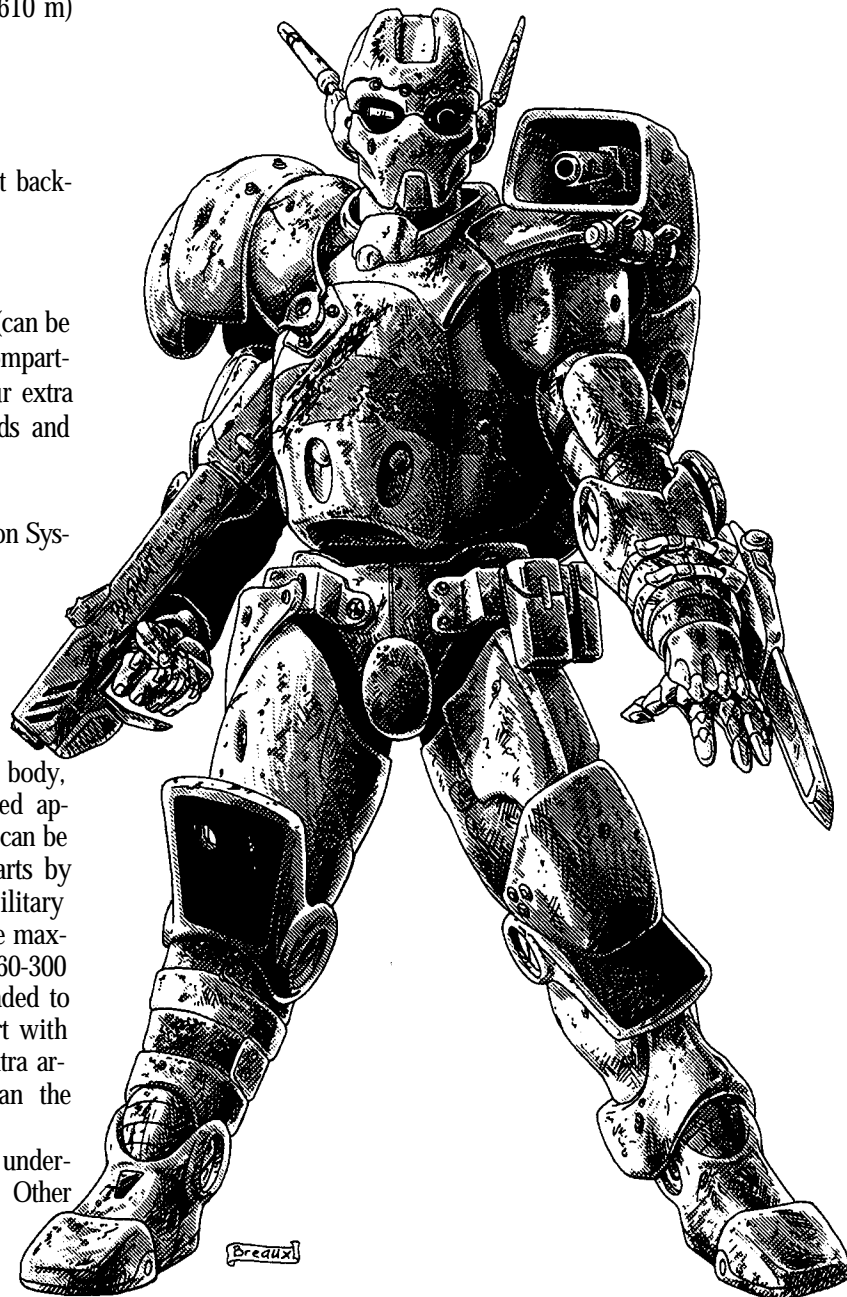

ically has an additional, rechargeable power pack **and/or** ammo-drum attached to the back, but most weapon systems still leave room for other back attachments such as a jet pack. All weapons point forward but can move up, down and side to side in a 30 degree arc of fire. The weapon is positioned via voice command **and/or** a tiny touch pad concealed in the standard chest compartment (see Cargo for details). **Note:** The listed cost is what the City charges; in the Outback such features may cost two or three times more.

The following weapon systems are available:

- High-Powered Long-Range Laser: 3D6 M.D., Range: 3000 feet (915 m), Bonus (very accurate and suitable for sniping): +1 to strike on an aimed shot; Cost: \$28,000.
- Dual Laser Blaster (twin barrel and fires simultaneously; more **firepower**, shorter range): 6D6 M.D., Range: 2000 feet (610 m), Cost: \$65,000.
- Heavy Standard Ion Blaster: 4D6 M.D., Range: 1200 feet (366 m), Cost: \$46,000.
- Particle Beam Gun: 6D6+6 M.D., Range: 1200 feet (366 m), Cost: \$100,000.
- ATA Gun: Fires the ATA projectiles with **EIPP** plasma propellant. 6D6 M.D. per round (each shot counts as one attack), Range: 1000 feet (305 m). Payload: 400 for a mini-drum, 1440 for a large drum. Cost: \$38,000 for the weapon, \$25 per each ATA slug.
- Medium Rail Gun: 4D6 M.D. per burst of 12 rounds (only fires bursts), Range: 2200 feet (670 m), Payload: 1440 drum (120 bursts), Cost: \$62,000 for the weapon and one dollar per round.
- S.D.C. Projectile Weapons: Fires rifle rounds. 5D6 S.D.C. per round (each shot counts as one attack) or in bursts of four rounds doing 1D6x10 S.D.C., Range: 2000 feet (610 m). Payload: 400 for a mini-drum (100 bursts), 1440 for a large drum (360 bursts). Cost: \$8,000 for the weapon and \$5 per 10 rounds (50 cents each).

**6. Hand to Hand Combat.** The power armor is also capable of hand to hand, Mega-Damage combat; see bonuses in the **Rifts® RPG**, page 45, for Basic and Elite Power Armor Combat Training (must be selected as a skill). In addition, Rusty gets the following bonuses.

+1 to dodge

+1 on initiative.

**Damage (standard for P.A.s):**

Restrained Punch — 2D6 + 10 S.D.C.

Full Strength Punch — 1D4 M.D.

Kick — 1D6 M.D.

Leap Kick — 3D6 M.D.; counts as two attacks.

Body Flip/Throw or Tackle — 1D6 M.D.

**7. Sensors of Note:** The basic armor has full optical systems, telescopic vision, passive **nightvision**, **thermo-imaging** and infrared. Plus all features common to power armor.

## “Bushbasher”

The "Bushbasher" environmental power armor was designed for Military operations in the bush and has since become standard gear for strike teams, combat squads and infantry units assigned outside the walled Cities. The Bushbasher has been an

important part of Melbourne's and Perth's Military for nearly 40 years, and its appearance is synonymous with these two technological powers. It has seen action in everything from extended scouting missions and air drops, to heavy combat duty, Outback pacification and frontline combat. Its small size and heavy armor make it ideal for surgical strikes, covert operations and "securing" areas from less well equipped opponents. Its size also makes it easy to transport and Bushbasher clad troops have seen action at almost every location in and around Australia.

The standard weapon assortment is also well rounded, as well as efficient in its configuration. Each arm conceals a laser weapon of a medium-grade which is designed for troop dispersal, but is less effective against vehicles or other suits of powered armor. Under the forearms are long, retractable **Vibro-Blades** that are used for cutting through heavy foliage, parrying and close combat. To confront armored opponents and M.D.C. creatures, a shoulder mounted mini-missile launcher is deployed, plus most fully equipped Bushbasher armor has a fold-down laser or particle beam rifle mounted on the opposite shoulder. This gun is stored facing upwards, adding slightly to the suit's height. It slides forward on the shoulder with a simple code command and fires via voice activation or can be removed

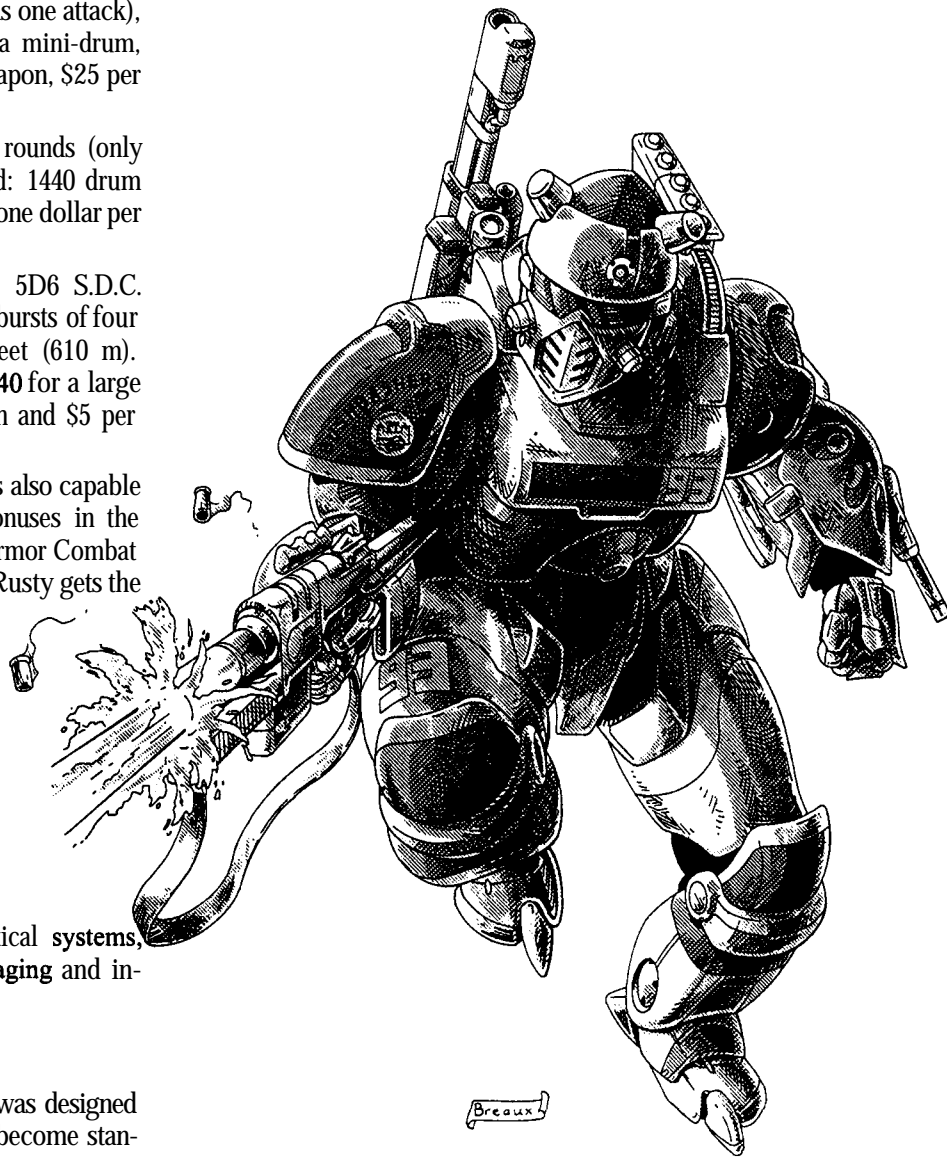

from the shoulder mount and used like an ordinary energy rifle (a cable keeps it hooked to the nuclear power supply). The belly of the power armor has a light flame thrower. In **addition**, most field troops are given four smoke grenades and six fragmentation grenades contained either in a side pouch attached to the hip or on a bandoleer slung across the chest. Jet packs and underwater propulsion systems can hook easily and quickly on the back.

Note: Bushbasher power armor that is occasionally traded to Outbackers or given to special **Outbacker** agents typically have only one weapon system (usually the pair of **Vibro-Blades**) and 20% less M.D.C.

## X50 "Bushbasher" Power Armor

**Official Designation:** Assault Power Armor Beta (APAB)

**Common Name:** Bushbasher

**Crew:** One

**Primary Purpose:** Infantry Assault and Espionage

**M.D.C. by Location:**

Arms (2) — 100 each

Legs (2) — 140 each

\* Shoulder Gun (1) — 50

\* Shoulder Missile Launcher (1) — 60

\* Concealed Forearm Lasers (1 per arm) — 12 each

Vibro-Blades (retractable; 2) - 15 each

\* Head — 80

\*\* Detachable Front Plate — 60

\*\*\* Main Body — 240

\* A single asterisk is a small **and/or** difficult target to hit and requires a Called Shot at -3 to strike.

Destroying the helmet of the power armor will eliminate all forms of optical enhancement and sensory systems. The pilot must now rely on his own human vision and senses, no power armor bonuses to **parry**, strike or dodge apply and the human head underneath is exposed! The head is small and difficult to hit and can only be hit when a called shot is made at a -3 to strike.

\*\* The front of the suit is more heavily armored than the rest of it. Any attack made from directly in front of the armor that strikes the main body must first subtract its damage from this front plate, and then from the main body once this is depleted. Once depleted of M.D.C., what scraps remain are easily removed and discarded.

\*\*\* Depleting the M.D.C. of the Main Body will shut the armor down completely, making it useless.

**Speed**

**Running:** 35 mph (56 km) maximum. The act of running does tire out the operator, but at 20% of the usual fatigue rate thanks to the robot exoskeleton.

**Leaping:** The robot enhanced legs can leap up to 5 feet (1.5 m) high or 10 feet (3 m) across.

**Flying:** Not possible without a jet **pack**.

**Underwater Capabilities:** As an environmental suit, the Bushbasher is capable of sustaining pressure up to a depth of 1200 feet (366 m). Small maneuvering **thrusters** in the back and lower legs give the armor stability and enhanced movement in and under water — can swim at a speed of 5 mph (4.3 **knots**/8 km) for an hour at a time. An underwater jet pack can be attached to the back, giving the armor a speed of 20 mph (17.2 knots/32 km) for an indefinite period.

## Statistical Data

**Height:** 7 feet (2.1 m); 8 feet (2.4 m) with part of the shoulder gun protruding when stored on the shoulder pointing up.

**Width:** 3 feet (.9 m)

**Length:** 3 feet (.9 m); may vary with backpack attachments.

**Weight:** 700 pounds (315 kg)

**Physical Strength:** Equal to a P.S. of 30.

**Power System:** Nuclear with an average life of 20 years.

**Black Market Cost:** City cost is 2.8 million for a new suit of power armor fully loaded with weapon systems. Highly coveted in the Outback where rare, stripped-down versions (no weapons other than Vibro-Blades and 20% less armor) sell for three times that amount and fully loaded versions (illegal) sell for 10 times the base price.

## Weapon Systems

**1. Shoulder Mounted Gun (1):** Can be any type of combat rifle or light rail gun. Most City-Units use a laser rifle for range and accuracy or particle beam or rail gun for heavy damage capacity. The only difference between this gun and the normal weapon is that it has been modified and cabled to the armor so it can be powered by the nuclear power supply.

**Maximum Effective Range:** Varies per rifle type, typically 1200-4000 feet (366 to 1219 m).

**Payload:** Energy weapons are effectively unlimited.

**2. Concealed Forearm Lasers (2):** The tops of the forearms slide open and laser weapons fold out on sturdy pintle mounts. They may fire 30 degrees to either side of the way the arm itself is pointing, and can even angle up and down 20 degrees.

**Primary Purpose:** Defense

**Secondary Purpose:** Anti-Personnel

**Mega-Damage:** 3D6 M.D. for a single, accurate blast, or both may be fired simultaneously (counts as one attack) at the same target for a combined damage of 6D6 M.D. However, to use the simultaneous **attack**, the shooter must be standing motionless, the target must be larger than man-sized and the attack is still -2 to strike. To fire both while running means the character is shooting wild at -4 to strike.

**Rate of Fire:** Equal to the combined hand to hand attacks of the pilot (usually 4-6).

**Maximum Effective Range:** 2000 feet (610 m).

**Bonuses:** +1 to strike.

**Payload:** Effectively unlimited. The weapon feeds from the internal power of the armor.

**3. Concealed Vibro-Blades (2):** On the underside of the forearms, opposite the lasers, slots in the lower wrists can extrude a **pair** of 3 foot long, slender Vibro-Blades.

**Primary Purpose:** Close Combat.

**Mega-Damage:** 2D6 M.D.

**4. Belly Flame Thrower (1):** A nozzle in the belly can fire a searing hot jet of napalm or plasma flame, that can scorch through all but the toughest metals. It is most often used as a room sweeper, or to clear cut foliage.

**Primary Purpose:** Anti-Personnel.

**Mega-Damage:** 1D6 M.D. per blast. The **surfaces/targets** struck continue to burn for an additional 1D6melee rounds and take an additional 1D4 M.D. per melee round on fire. There is also a

01-65% likelihood that surrounding combustibles will catch fire, burn and spread. However, such an extended, normal fire does S.D.C. damage.

**Rate of Fire:** Each blast counts as one melee attack.

**Maximum Effective Range:** 100 feet (30.5 m).

**Payload:** 12 blasts; the flame thrower feeds from canisters in the lower back. This weapon is used with extreme caution.

**5. Shoulder Mounted Mini-Missile Launcher (1):** The missile launcher is a heavy hitter, but limited in ammo supply.

**Primary Purpose:** Anti-Armor and Assault.

**Mega-Damage:** Varies with missile type, usually Armor Piercing (1D4x10 M.D.).

**Rate of Fire:** One or two at a time.

**Effective Range:** One mile (1.6 km).

**Payload:** Five.

**6. Hand to Hand Combat.** The power armor is also capable of engaging in hand to hand, Mega-Damage combat; see bonuses in the **Rifts® RPG**, page 45, for Basic and Elite Power Armor Combat Training (must be selected as a skill). In addition, the Bushbasher gets the following bonuses.

+1 to strike. +1 on initiative.

+1 to dodge. +1 to roll with punch, fall or impact.

**Damage (standard for P.A.s):**

Restrained Punch — 2D6 +10 S.D.C.

Full Strength Punch — 1D4 M.D.

**Kick — 1D6 M.D.**

Leap Kick — 3D6 M.D.; counts as two attacks.

Body Flip/Throw or Tackle — 1D6 M.D.

**7. Sensors of Note:** The basic armor has full optical systems, telescopic vision, passive **nightvision**, **thermo-imaging** and infrared. Plus all features common to power armor.

## Other Power Armor

There are a few heavier, larger types of power armor, including the Platypus and Security Commando, as well as other vehicles, but space limitations prevent us from presenting them here. See **Rifts® Australia Two: Mystic Australia** for their descriptions and more world information, along with magic and Aboriginals.

Note: The use of cybernetics is extremely limited and rare in Rifts Australia. Only implants and partial reconstruction are possible in the Outback — when one can find that rare Cyber-Doc and chop-shop. The Tech-Cities avoid full cyborg conversion and hesitate using even partial bionic reconstruction except for limited combat use and for medical purposes (**prosthetics**, etc.).

## Notable Vehicles

**A note about Australian Vehicles:** The following are only a small handful of vehicles common to Rifts Australia, particularly in the Outback. See the Rifts® RPG and various other World Books for a variety of general (as well as specific) types of ground and **air** vehicles; both M.D.C. and S.D.C. **Rifts® Underseas and Coalition Navy™** can provide a variety of sea vessels.

The following are all M.D.C. creations manufactured and used primarily by Perth and Melbourne.

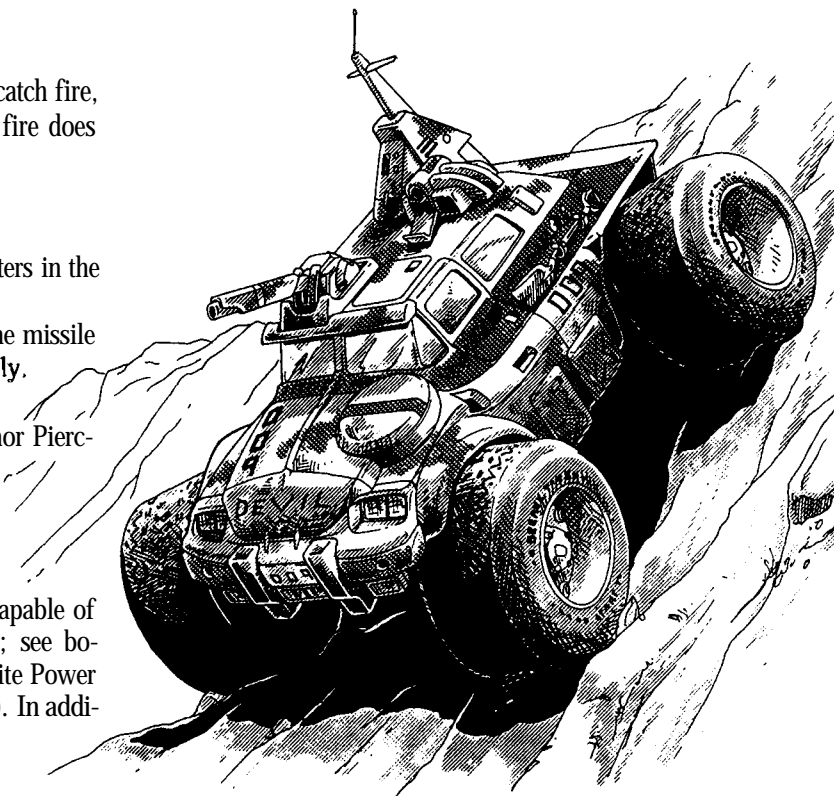

### "Devil" 4x4

#### NT-1200 Multi-Purpose Vehicle

This four-wheel-drive vehicle is designed to be oversized to allow for better balance and traction in rough terrain. It is primarily used outside the Tech-Cities and is one of the few (expensive) high-tech items manufactured in the Tech-Cities and regularly sold and traded to Outbackers (mainly to towns and settlements rather than individuals). It is also used by the Cities' Militaries and their outside agents, only occasionally by the citizens — excellent mass transit systems serve most City-Goers, with only 7% of the citizens owning a vehicle of any kind. Owning the Devil as a private car is an ultimate statement of wealth and position in the Tech-Cities.

The Devil 4x4 is an outstanding all-terrain vehicle with independent suspension, four wheel drive, large M.D.C. construction, large tires and a variety of engines and power supplies from gasoline and solar energy to nuclear (the latter being the rarest and most expensive, and typically reserved for military operations). The vehicle can be used for personal transportation, small squad transport, cargo hauling, message delivery, rapid troop deployment, combat, exploration and reconnaissance.

In its military capacity, the vehicle is used mainly in the capacity of a jeep and commonly deployed for light assaults, reconnaissance, patrols, raids, and general transportation. It is lightly armored, fast, durable and is complemented by a suite of sensory and communications equipment. Standard weapons include a pop-up grenade launcher, and a light rail gun or laser mount on the passenger side. Two additional weapon systems can be added for under \$200,000. Most military models also have a self-destruct feature to prevent the vehicle from falling into the hands of the enemy (with very limited effectiveness). The civilian model has 30% less M.D.C. and no weapon systems, but both versions are popular with Outbackers and coveted by **Roadgangers** and adventurers.

#### Devil 4x4 Vehicle

**Crew:** Three: a driver, gunner, and communications officer.

**Passengers:** An additional five people can be seated comfortably on the bench seats; seven under cramped conditions. Plus six others can ride on the exterior (there are many hand-holds) in case of an emergency, but speed must be held under 35 mph (56 km) or those clinging to the outside will fall off.

**Purpose:** All-terrain small squad troop transport, light combat and general all-purpose vehicle.

**M.D.C. by Location (military version):**

Wheels (4) — 30 each

Windshield (front and rear) — 15 each

Side Windows (4) — 10 each

\* Doors (2; sides) — 90 each

Sensor Cluster/Communications Array (1; top, rear) — 50

\* **Winch (1; rear)** — 15

\* Headlights (6) — 5 each

\* Rail Gun (1) — 50

\* Pop-Up Grenade Launcher (retractable; 1) - 45

\*\* **Main Body** — 225

\* A single asterisk means the target is small and difficult to strike, and requires that the attacker make a called shot at a -4 penalty.

\*\* Depleting the M.D.C. of the Main Body will destroy the vehicle completely, making it useless.

**Speed**

**Cruising:** 45 mph (72 km)

**Maximum Speed:** 140 mph (224 km)

**Maximum Off-Road Speed:** 110 mph (176 km)

**Statistical Data**

**Height:** 6 feet (1.8 m), plus the sensor cluster adds another three feet (0.9 m) for an overall height of 9 feet (2.7 m).

**Width:** 7 feet (2.1 m) for vehicle body alone, 11 feet (3.3 m) overall.

**Length:** 18 feet (5.5 m)

**Weight:** 8.5 tons

**Range & Power System:** 300 miles (480 km) with a fuel based combustion engine; unlimited for nuclear. Approximately 36% have a solar collector power system and electric battery that can supplement a conventional fuel system and add 120 miles (192 km) before needing to be recharged.

**Cargo:** A compartment in the rear measures 6 feet (1.8 m) wide, 3 feet (0.9 m) long and 4 feet (1.2 m) deep. With the rear seats folded **down**, this is extended to 6 feet (1.8 m) long. Additional cargo can be lashed to the top of the vehicle plus it can pull cargo behind it. The Devil 4x4 can *carry* up to five tons and pull up to 12 tons, but reduce the vehicle's speed by 30% when hauling more than six tons.

**Cost:** \$180,000 for a new, undamaged civilian vehicle (30% less armor and no weapons). Military units, with standard weaponry and sensors cost \$490,000. Price may vary by 10-30% up or down; usually up.

**Features and Weapon Systems**

**1. Pop-Up Grenade Launcher (1):** On the military vehicles only, the rear of the Devil holds a compartment that folds open to face forward over the roof. It launches any type of grenade, but fragmentation and plasma are the most common.

**Purpose:** Assault

**Mega-Damage:** Depends on the grenade type; typically 2D6 (frag.) or 5D6 M.D. (plasma).

**Range:** 500 feet (152 m)

**Payload:** 42 grenades. Can be fired one at a time or in volleys of two or four.

**Cost:** \$42,000

**2. Mounted Rail Gun (1):** Military versions have a light rail gun or laser gun (3D6 M.D.; 2000 ft/610 m range) mounted on the bonnet on the passenger side. The weapon is operated via a direct link from the dashboard inside the vehicle, and can fire in a 90 degree arc up and down or 25 degrees side to side. The rail gun is always belt fed from an ammo hopper under the bonnet.

**Purpose:** Anti-personnel and light assault.

**Damage:** 4D6 M.D. per burst of 12 rounds.

**Rate of Fire:** Only fires bursts of 12 rounds. Each burst counts as one melee attack.

**Range:** 3,000 feet (914 m)

**Payload:** 1440 drum (120 bursts).

**Cost:** \$130,000

**3. Communications Suite:** The military models come standard with a full communications suite with a wide-band radio and laser transmission equipment. It is quite bulky, as there are no satellite **up-links** to support the signals. Overall, the equipment is effective to a range of 200 miles (320 km). **Cost:** \$30,000

**4. Sensors:** The military models are also equipped with a 20 mile (32 km) range radar, HUD display system, **thermographic** camera, image enhancement over the front windshield, targeting computer (+1 to strike with onboard weapons), proximity warnings, directional microphone, external loudspeaker, spotlights and atmospheric sensors (temperature, etc.). **Cost:** \$120,000

**5. Other Onboard Systems:** All Devil 4x4s come equipped with air conditioning, a four hour independent oxygen supply, a small refrigerator, 3 gallons of drinking water in an easy to use dispenser, first-aid kit, audio/visual display, one inch CD player and crash control air bags (half damage to passengers in a crash). **Cost:** \$60,000

**6. Additional Weapons:** Non-Military models can have the standard or other weapons added to them. Military models of the 4x4 can get two additional weapon systems. **Cost:** Varies.

## "Crawler" APC

### NT-6000 All-Terrain Half-Track

The Crawler was originally designed to be a work and cargo transport vehicle for use around construction sites and military outposts. However, the vehicles are used primarily by the City Militaries as a sturdy and reliable troop and supply transport. The Crawler is an essential part of both Cities' militaries and is used extensively outside the walled cities. As military vehicles, they are equipped with a mini-missile launcher and heavy gun (the latter being either a rail gun, particle beam cannon or heavy laser). The front two wheels are solid rubber while the rear of the vehicle is supported on tank tracks, making it very stable and reliable while off-road. A ramp slides out of the cargo bay for ease of loading and unloading.



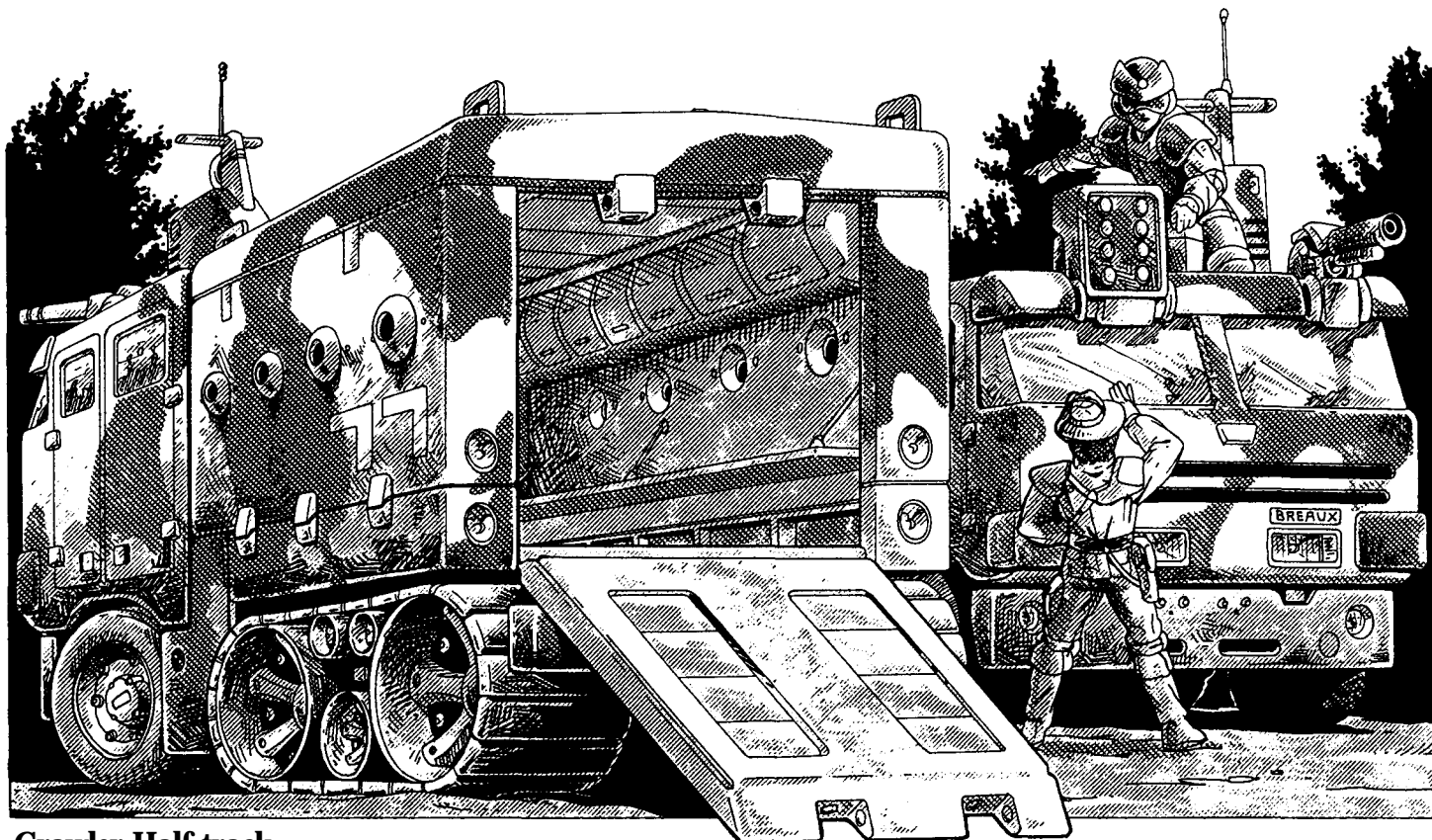

## Crawler Half-track

**Crew:** Four: A driver, communications engineer/navigator, gunner and soldier escort/defender.

**Passengers:** Up to four additional personnel can ride in the four-door front cab, and the rear can hold a platoon of 40 troops in body armor, or 26 in power armor

**Purpose:** Armored Personnel Carrier and Cargo Hauler.

### M.D.C. by Location:

- \* Front Tires (2) — 50 each
- \* Side Tracks (2) — 110 each
- Windshield (front) — 25
- Side Windows (4) — 15 each
- Cargo Bay Portals (8; sides) — 10 each
- \* Main Gun (1; cab) — 50
- \* Mini-Missile Launcher (1; cab) — 75
- Sensor Cluster/Communications Array (1) — 60
- Bay Door/Ramp (1; large) — 130
- Headlights (4) — 8 each
- \*\* Main Body — 440

\* A single asterisk means the target is small and difficult to strike, and requires that the attacker make a called shot at a -4 penalty.

\*\* Depleting the M.D.C. of the Main Body will destroy the vehicle completely, making it useless.

### Speed

Cruising: 35-50 mph (56 to 80 km)

Maximum Speed: 100 mph (160 km)

Maximum Off-Road Speed: 80 mph (128 km)

### Statistical Data

Height: 8 feet, 8 inches (2.65 m) for the main body, but weapon systems and the sensor/communications cluster adds another four feet (1.2 m) for an overall height of 12 feet, 8 inches (roughly 3.9 m).

Width: 9 feet, 4 inches (2.8 m).

Length: 28 feet (8.5 m)

Weight: 18 tons

Range & Power Supply: Approximately half are nuclear powered (effectively unlimited range with a 20 year life) and half use a combustion engine (500 mile/804 km range) and solar power system and electric engine and battery that can supplement the conventional fuel system and add 120 miles (192 km) before needing to be recharged.

Cargo: The large trailer section can carry up to 100 tons and can pull an additional 200 tons, but speed is reduced by 30%.

Cost: \$940,000 for a standard Military vehicle. Occasionally sold or traded to an Outback community minus all weaponry and sensors, less 40% of the M.D.C., and using a fuel-solar system (never nuclear) at a cost of \$514,000. May sell for twice that on the secondary market.

## Features and Weapon Systems

**1. Pop-Up Mini-Missile Launcher (1):** On the military vehicles only, the cabin roof of the Crawler holds a compartment that folds open to face forward over the bonnet. It launches small, **unguided** rockets in large volleys, and is designed as a hard hitting defensive weapon if the vehicle ever ends up in front-line action.

Purpose: Defense

Mega-Damage: Depends on the rocket type, usually fragmentation (5D6 to a 20 foot/6.1 m radius) or plasma (1D6x10 to a 15 foot/4.6 m radius).

Range: One mile (1.6 km)

Payload: 24 rockets. Can be fired in volleys of 2, 4 or 8. Can be reloaded by hand in two minutes.

Cost: \$140,000 plus \$5000 per missile.

**2. Main Gun (1):** The exact type may vary. A particle beam cannon roughly equivalent to the *NeraTech M-21* (1D6x10 M.D.; 2000 ft/610 m range; see weapon section for complete

stats) is typically used for heavy **firepower** and a double-barrelled laser cannon (6D6 M.D.; 3000 ft/914 m range) or rail gun (4D6 M.D. per burst, 200 burst payload and 4000 ft/1228 m range) for superior range. The weapon turret can rotate 180 degrees and has a 90 degree arc of fire, up and down.

**Statistics:** Varies as noted above.

**Cost:** Approx. \$160,000

- 3. Communications Suite:** The military models come standard with a full communications suite with a wide-band radio and laser transmission equipment. Overall, the equipment is effective to a range of 200 miles (320 km). Cost: \$30,000
- 4. Sensors:** The military models are also equipped with a 20 mile (32 km) range radar, HUD display system, **thermographic** camera, image enhancement over the front windscreen, targeting computer (+1 to strike with onboard weapons), proximity warnings, directional microphone, external loudspeaker, spotlights and atmospheric sensors (temperature, etc.). Cost: \$120,000
- 5. Other Onboard Systems:** All Crawlers come equipped with air conditioning, a four hour independent oxygen supply, a small refrigerator, 3 gallons of drinking water in an easy to use dispenser, first-aid kit, audio/visual display, one inch CD player and crash control air bags (half damage to passengers in a crash). Cost: \$60,000
- 6. Additional Weapons:** Non-Military models can have the standard or other weapons added to them. Military models can get two additional weapon systems. Cost: Averages around \$150,000 each.

## “Slicer” Patrol Boat

A standard Tech-City patrol boat and light transport vessel. The Slicer can be found running shoreline patrols, defending shorelines, making coastal insertions and extractions, reconnaissance, battling sea **monsters**, and warding off pirates and foreign vessels at sea and on rivers. While the vessel is not large enough for long-range or prolonged ocean travel, the Melbourne forces often use the patrol boat to cross to Tasmania and make runs along the coast and up to 100 miles (160 km) out to sea.

The vessel is very sturdy and very fast. It is equipped with a battery of weapons, including torpedoes, mini-missiles and a pair of weapon turrets (either rail guns or high-powered lasers). Furthermore, 2-4 Trencher Power Armor troops are a standard **part** of the crew.

### Slicer Patrol Boat

**Crew:** 9-13: Captain/pilot, helmsman/co-pilot, navigator/communications officer, two gunners, 2-4 sailors/Marines/combat troops and 2-4 Power Armor troops.

**Passengers:** 6-10 additional personnel can ride in the bridge, and the belly can hold as many as 10 additional fully armed Marines.

**Purpose:** Fast Response Patrol Boat

#### M.D.C. by Location:

Weapon Turrets (2) — 90 each

\* Pop-Up Missile Launchers (2) — 80 each

Mini-Torpedo Launcher (1; rear)

\* Window Slits (6) — 15 each

\* Searchlight (1; top, large) — 15

\* Sensor Mast/Cluster — 70

\*\* Bridge Section — 150

\*\*\* Main Cabin — 220

\*\*\*\* Main Hull — 500

\* A single asterisk means the target is small and difficult to strike, and requires that the attacker make a called shot at a -3 penalty.

The sensor mast contains all essential long-range communications and radar systems. When destroyed, such **instruments** are useless, and all other sensor systems are used with a -40%. However, the mast is a thin and difficult target to hit, and a player must make a *called shot* with a -4 penalty to strike.

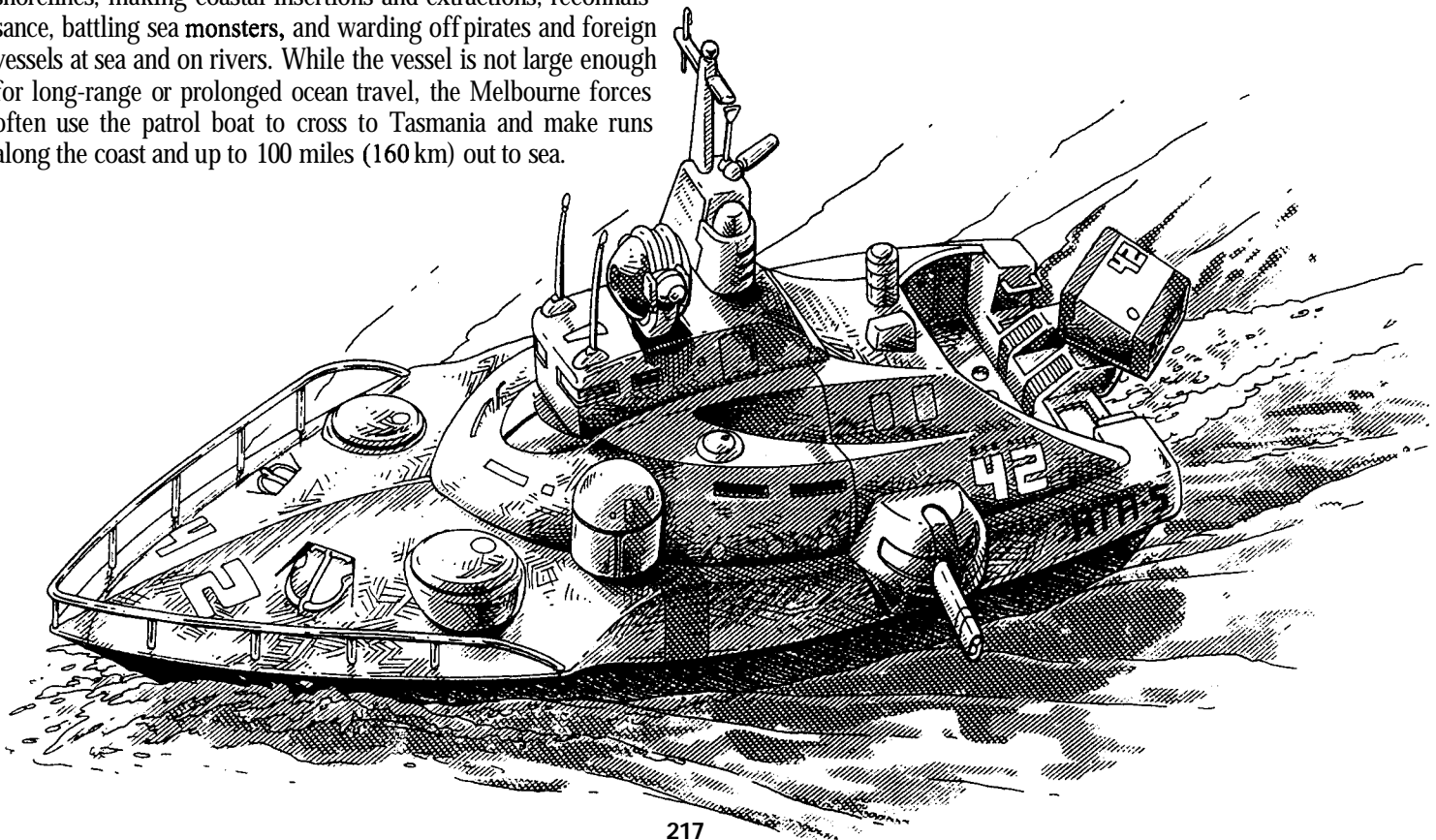

\*\* Depleting the M.D.C. of the bridge destroys the top bridge controls, and will likely kill anyone standing there at the time. Another, safer bridge is located in the bow of the vessel, which may be used at no penalty (and indeed is usually employed when in battle). The main advantage of the open bridge (also called the flying bridge) is that the pilot has a 360 degree view with his naked eye, while below decks he must rely on the comprehensive sensors (-20% to chances of detecting opponents sneaking up on the vessel or being ambushed).

\*\*\* Destroying the main cabin will also disable the flying bridge, and will expose the otherwise sealed cabin inside. The vessel's speed will be reduced by 20% due to increased wind drag, poorer vessel balance and failing electrical systems.

\*\*\*\* Depleting the M.D.C. of the Main Body will destroy the vessel completely, and it will break up and sink within mere moments.

### Speed

Cruising: 40 mph (64 km/34 knots)

Maximum Speed: 140 mph (224 km/123 knots)

Bonuses: +2 to dodge

### Statistical Data

Height: 6 feet (1.8 m) from the water level to the top of the cabin, but a total of 12 feet (3.7 m) tall including the sensor mast. The vessel draws another 4 feet and 4 inches (1.3 m) draft below the water level.

Width: 11 feet (3.4 m)

Length: 44 feet (13.4 m)

Weight: 12.5 tons

Range & Power System: Approximately one third require fuel to feed a combustion engine (600 miles/960 km range), two thirds are nuclear powered with unlimited range (20 year life). There are enough supplies aboard to feed the skeleton crew of 4 for 3 months; one month if a soldier unit is included as part of the crew.

Cargo: The hold of the Slicer can carry six tons and pull 40 tons, but reduce speed by 60% when hauling more than 10 tons.

Cost: 1.6 million for a nuclear powered vessel with all weaponry and sensors. Not available on the open market except via the black market; very rare.

### Features and Weapon Systems

**1. Main Weapon Turrets (2):** Located on either side of the mid-section is a weapon turret. The weapon is typically either a **high-powered**, double-barreled laser or rail gun. The rail gun has greater distance but usually a finite amount of ammunition. Laser turrets tap into the nuclear power supply, effectively giving them an unlimited payload.

Purpose: Assault & Defense.

Damage: Rail Gun: 1D4x10M.D.

Laser: 6D6 M.D.

Rate of Fire: Standard

Range: Rail Gun: 4000 feet (1218 m)

Laser: 3000 feet (914 m)

Payload: Each rail gun burst fired is 15 rounds, and the belt-fed Rail Gun holds 6000 rounds (400 bursts each). There is not enough space on board the Slicer to carry spare ammo-drums

for these weapons, unless there are no extra troops in the hold.

Laser is unlimited if tied to a nuclear power system.

**2. Mini-Torpedo Launcher Rack (1):** On the stern of the boat is mounted a mini-torpedo launcher.

Purpose: Anti-sub/ship

Mega-Damage: 1D6x10 (High Explosive)

Range: 3 miles (4.8 km)

Rate of Fire: May be fired as a single torpedo or in a volley of two or four.

Payload: A total of 12 torpedoes are held in the launcher with another dozen stored in the hull of the vessel. It takes approximately 3 minutes to reload the launcher with six torpedoes and five minutes for a complete reload.

Bonus: +5 to strike because they are guided smart-torpedoes.

This assumes that a gunner is devoted to the activity, otherwise the torpedoes are fired "dry," with no bonus.

**3. Pop-Up Mini-Missile Launchers (2):** The two hatches in the bow of the boat open and a pair of Mini-Missile Launchers rise up to engage enemy aircraft, flying assailants and other surface vessels.

Purpose: Anti-Aircraft and Anti-Ship.

Mega-Damage: Varies with missile type, but typically Armor Piercing (1D4x10 M.D.).

Rate of Fire: 1, 2 or 4 missiles in a volley.

Maximum Effective Range: One mile (1.6 km).

Payload: Eight per each launcher, with automatic reloading for a total of 32 per launcher (64 in all).

**4. Communications/Sensor Suite:** The Slicer has a full communications suite with a wide-band antenna and laser transmitter - range 500 miles (800 km). There is also a long (30 mile/48 km) and short range (2 mile/3.2 km) radar that can track as many as 36 targets at once, and a passive sonar with a 1 mile (1.6 km) range. Of course, the Slicer is also equipped with all the usual **thermographic** optics, proximity alarms, terrain following radar, external cameras, HUD, loudspeaker, spotlight and atmospheric sensors.

**5. Other Onboard Systems:** The Slicer comes equipped with air conditioning (and a six hour independent oxygen supply) for the internal cabin, basic medical equipment, audio/visual display and one inch CD player/recorder, and four inflatable emergency rafts that have enough room for six men each, and enough supplies to feed them for three days. Each emergency raft folds down to the size of a large backpack, and inflates automatically when a string is pulled. They have an A.R. of 8, and can sustain 50 S.D.C. before deflating and sinking.

## "Viper"

### NT-V40 Multi-Purpose Attack Chopper

The infamous V40 is the vehicle synonymous with the Tech-Cities and a symbol of their technological supremacy (and to a slightly lesser degree, their tyranny over the Outbacker communities). The familiar whine of the turbines and the whirl of **their** blades are warning sounds that send Outback dwellers scurrying for cover. Sleek (black in Melbourne, grey in Perth) and intimidating, they are sinister looking aircraft bristling with **firepower**. The **'choppers** are used for city defense, patrols, spying, pursuits, rescue, reconnaissance, raids, assaults, and open

warfare. The V40 and the tiny Stinger Remote 'Choppers are constantly seen and heard buzzing around the two Tech-Cities and used by both the Police and Military. The vehicles are both efficient and cost effective. Both Perth and Melbourne have several hundred in operation, with many more under construction.

The Viper is armed with missiles, a **Gatling-style** rail gun and lasers. It is piloted by a two-man crew, plus one or two door gunners using a mounted rail gun or laser. Door gunners can also serve as snipers with the correct weapons, and are infamous for their ability to pick off and whittle down opponents and enemy troops with ruthless efficiency.

The Viper even has limited stealth capability, and can rig for silent running, at a reduction in overall speed. Certain surprises are packed into the V40 as well, including reserve rotors!

### NT-V40 Attack Chopper

**Crew:** Two minimum, typically four: Pilot, co-pilot/communications, and two door gunners.

**Passengers:** Four can ride comfortably in the rear compartment with the door gunners; six cramped.

**Primary Purpose:** Air Assault, Rescue and Troop Support.

**Secondary Purpose:** Reconnaissance, Insertion and Extraction.

#### M.D.C. by Location:

\* Nose Gun — 20

\* Medium-Missile Launchers (2) — 100 each

\* Circular Mini-Missile Launchers (2) — 35 each

Door Gunner Weapon Mount (1 or 2) — 25 each

Gunner's Side Doors (2; when closed) — 70 each

\* Searchlight (1; underside of nose section) — 10

\*\* Main Rotor Blades — 45

Tail — 75

Wings (2) — 50 each

Cockpit — 150

\*\*\* Main Body — 210

\* A single asterisk, like the nose gun, is a small and/or difficult target to strike. A character must make a *called shot*, and even then it is made with a -3 to strike.

\*\* The rotors are a difficult target to shoot. To hit them, a character must make a *called shot* at a -4 penalty, all other attacks miss altogether (pass through harmlessly). Destroying the rotors will cause the backup rotors to slide into place within a few seconds, but the chopper will lose 200 feet (61 m) of altitude before the backups engage. Destroying the backups will cause the chopper to plummet to the earth and crash. There is a 01-29% chance that there will be salvageable parts, including door gunner weapons.

\*\*\* Depleting the M.D.C. of the main body destroys the helicopter.

#### Speed

Ground: Not possible unless hauled by another vehicle.

Maximum Air Speed: The V40 can hover stationary, or achieve a maximum speed of 480 mph (768 km). Its maximum altitude is 5000 feet (1524 m).

#### Statistical Data

Height: 8 feet (2.4 m) for body, 14 feet (4.3 m) including rotor blades.

Width: 10 feet (3 m) from wing tip to wing tip, when the rotors are folded for storage, or 35 feet (10.7 m) when the rotors are deployed.

Length: 38 feet (11.6 m)

Weight: 6.5 tons

Range & Power Systems: 500 miles (800 km) with a combustion engine; unlimited for nuclear (20 year life).

Cargo: Can carry up to one ton fully loaded.

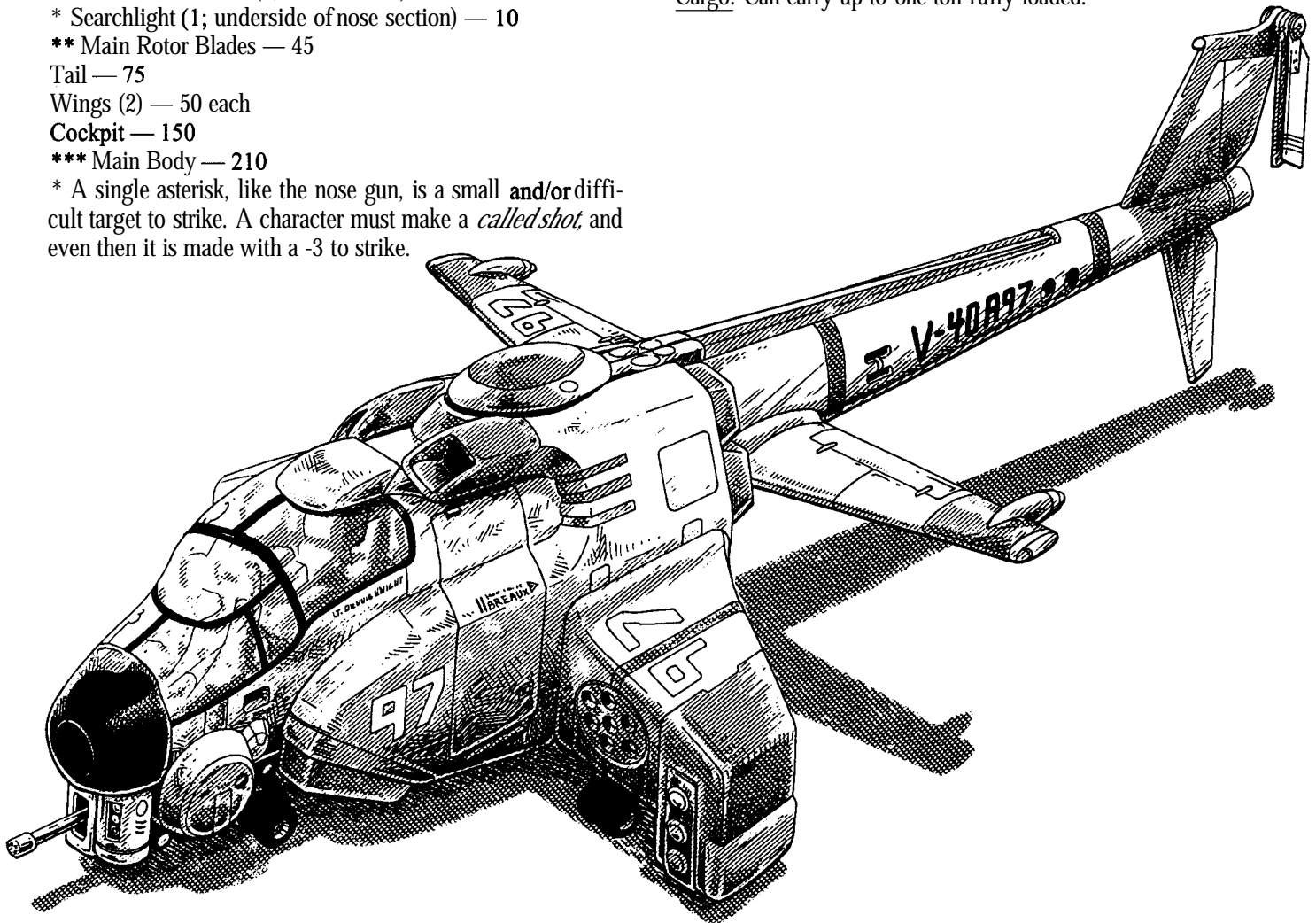

Cost: 3.9 million for a nuclear powered Viper (70%), or 1.8 for a fuel powered 'chopper. Super-rare outside the Tech-Cities.

## Features and Weapon Systems

1. **Nose Gun (1):** Slung underneath the nose of the cockpit is a large, belt-fed, **Gatling-style** rail gun. This is the primary weapon of the V40 for troop dispersal and area denial.

Purpose: Anti-Personnel & Assault.

Mega-Damage: A single burst fires 20 rounds and inflicts 1D4x10 M.D.

Range: 4000 feet (1219 m)

Rate of Fire: Each burst counts as one melee attack.

Payload: The belt contains 4000 rounds (200 bursts).

2. **Mini-Missile Launchers (2):** Each of the weapon appendages contains a circular mini-missile launcher.

Purpose: Anti-Aircraft and Anti-Armor.

Mega-Damage: Varies with missile type, but typically Armor Piercing (1D4x10 M.D.).

Rate of Fire: 1, 2 or 4 missiles in a volley.

Maximum Effective Range: One mile (1.6 km).

Payload: 24 per each launcher, with automatic reloading, for a total of 48 in all.

3. **Medium-Range Missile Launchers (2):** Each of the weapon appendages ends with a medium-range missile launcher.

Purpose: Anti-Aircraft and Heavy Assault.

Mega-Damage: Varies with missile type, but typically Armor Piercing or High Explosive (3D6x10 M.D.); **Napalm/Plasma** are only used at sea to avoid starting dangerous fires in the city or in the bush.

Rate of Fire: 1, 2 or 3 missiles in a volley.

Maximum Effective Range: Approx. 50 miles (80 km).

Payload: Three per each launcher, for a total of six in all.

4. **Door Gunner's Turrets (2):** There is a door on either side of the 'chopper where a special gunner's harness and folding weapon's mount are located. The mount can accommodate virtually any type of rifle or rail gun, which the gunner uses to pick off enemy ground troops and/or to defend the helicopter and crew. During "hot" insertions and extractions, the Door Gunner typically lays down suppressing gunfire and tries to cover friendly troops.

Note: -4 to strike when the helicopter is moving, -1 when hovering stationary. The Gunners may wear a simple Flak Vest to medium or heavy body armor, or even Bushbasher or Trencher power armor, but the latter is uncommon.

5. **Crew & Troops:** The Viper often carries combat troops and may have 1-4 power armor troopers with jet packs to give it even greater air support and firepower.

6. **Reserve Rotor System:** A unique system aboard the V40 Viper is the folding rotor system. When the chopper powers down, the rotors retract back and fold together to drop into a long compartment that runs from the tail to the nose of the aircraft. The rotors fold back and together, and are telescoping to shorten the room they need when stored. This whole system enables the V40 to be stored within a smaller area, and also protects the rotors from harm when the aircraft is grounded. In addition to folding the rotors, the compartment holds a reserve pair of blades that extend and power up the instant the initial rotors are destroyed. This process is very quick, taking only a few seconds (one melee action) to ini-

ate, although the aircraft will lose 200 feet (61 m) of altitude if the transition takes place in mid-air. The old rotors are ejected when the new ones move into place.

7. **Ejector Seats:** The pilot and co-pilot seats eject upon command from the pilot and parachutes deploy to drop them safely to earth. The **gunner(s)** and other crew or passengers must rely upon an ordinary parachute to leave the vehicle, or pure luck that they may survive the crash (unlikely).

8. **Sensors and other features:** The Viper has an impressive array of sensors. **Thermographic**, low light **nightvision**, HUD, targeting scope, laser targeting, radar (20 mile/32 km radius range), external loudspeaker, infrared optics, directional spy microphone, external camera, 300 mile (480 km) range communications and onboard computer. The air inside the cockpit is also sealed and filtered, protecting the pilots from gases and smoke. Passengers and gunners in the cargo bay are not so fortunate.

Bonuses: +1 to strike with all ranged weaponry, +1 to dodge and +2 on initiative.

## VR-500X "Stinger"

### Remote Mini-Helicopter

As discussed earlier in the section discussing the Perimeter Wall and City Defenses, starting on page 96, The Stinger is a miniature *robot* helicopter that can be controlled remotely or programmed to respond to set parameters. In virtually all cases, the response is deadly.

Designed for use as a patrol drone, spotter/spy and defense mechanism, the VA-500X scours the land, sea and sky for trouble in and around the two Tech-Cities. The robot 'coptersaves lives not just as a defense system, but because it is unmanned, taking soldiers out of the field of combat. The Stinger at Perth (depicted here) looks very much like a miniature helicopter armed with a light rail gun. The one at Melbourne is a bit sleeker and high-tech looking (see illustration on page 97); both are equally reliable and deadly. Each Tech-City deploys thousands of Stingers, making life hard for raiders, spies and refugees.

The Stinger is very small and minimal in its armor and arms. They are considered disposable units that can be sacrificed by the military to get the job done. Consequently, most run on fuel or electricity rather than expensive nuclear systems. As one might **suspect**, they are relatively inexpensive to manufacture, though the Virtual Reality (VR) interface increases their cost somewhat.

Although the onboard computer automatically engages and responds to motion, noise, alarms, etc., while the Stinger responds as an unmanned drone, the VR system automatically engages and a human "controller" is alerted. The Virtual Reality interface allows a human operator to take control of 1-4 Stingers while he is nestled safely in a control tower within the city walls or in the field inside an armored vehicle. Under Virtual Reality Control, the operator controls the drone through a pair of VR goggles, gloves, and joy stick. When 2-4 are controlled by a single VR operator, all four respond as one, each mimicking the action of the lead stinger and attacking like a swarm of hornets. The operator "sees" via three different cameras that are constantly transmitting pictures and sound to the operator's station

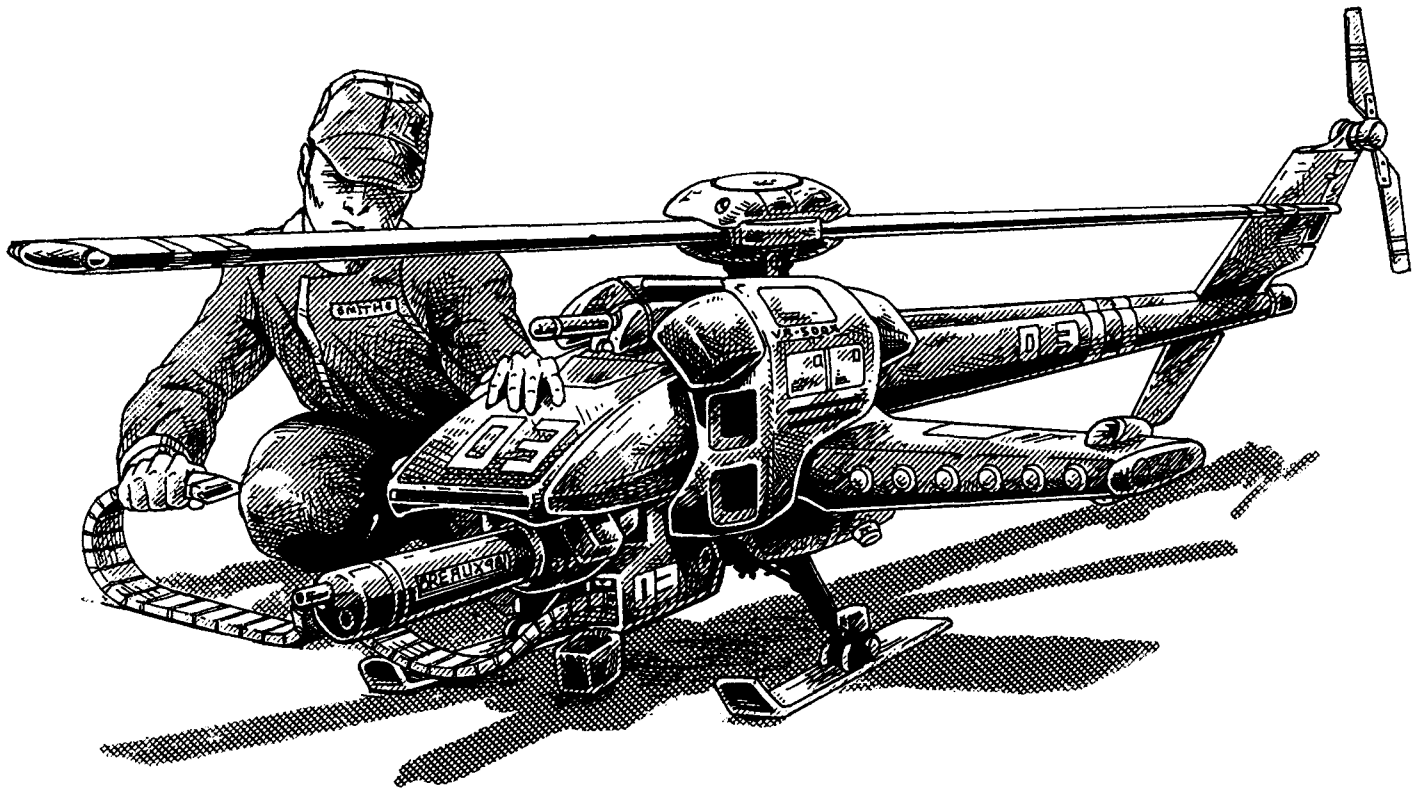

(where it is often recorded for review and reference). The Perth model has a camera and sensor under the gun mount that can swivel up and down 90 degrees and rotate 360 degrees. It also has a pair of camera and sensor units under the rotors. Built into each weapon wing are six mini-missiles (12 total). The Melbourne model launches them from a concealed housing in the underbelly. **Note:** The Stinger performs well as a robot drone without a VR operator, but its movements and responses (usually to attack and destroy intruders) become predictable (reduce all bonuses by half; round down).

### VR-500X Stinger Robot

**Crew:** Unmanned Drone. If controlled by VR interface there is one human operator who can be up to 50 miles (80 km) away (double that distance when in flat desert or grasslands without mountains or trees to interfere with transmissions).

**Purpose:** Defense and Patrol/Reconnaissance

#### M.D.C. by Location:

\* Rotors — 15

Rail Gun — 25

Tail — 25

Sensor Wings (2 Perth; VTOL Jets Melbourne) — 20 each

Landing Gear — 20

\*\* Main Body — 60

\* The rotors are a difficult target to shoot. To hit them, a character must make a *called shot* at a -5 penalty, all others miss altogether (pass through). Destroying the rotors will cause the 'chopper to plummet to earth and crash.

\*\* Depleting the M.D.C. of the main body destroys the robot helicopter, although there is a 01-12% chance of the gun being salvageable.

Speed

Ground: Not possible, must be hauled by another vehicle.

**Maximum Air Speed:** The Stinger may hover in place or achieve a maximum speed of 460 mph (736 km). Maximum altitude is 1800 feet (167.6 m).

#### Statistical Data

**Height:** 3 feet (0.9 m)

**Width:** 3 feet (0.9 m) from wing tip to wing tip, 12 feet (3.7 m) total when the rotors are running.

**Length:** 14 feet (4.3 m)

**Weight:** 1000 pounds (450 kg).

**Range:** Approx. 400 miles (640 km).

**Cargo:** None

**Power System:** Combustion or electric with approximately one hour **flight/fuel** time.

**Cost:** 760,000 for a new, undamaged Stinger with full arms and VR interface. Excluding the VR drops the price to 550,000.

### Features and Weapon Systems

**1. Nose Mounted Rail Gun (1):** Slung underneath the nose is a small, belt-fed, **Gatling-style** rail gun. This is the primary weapon of the Stinger.

**Purpose:** Assault

**Mega-Damage:** A 40 round burst inflicts **1D4x10** Mega-Damage.

**Range:** 4000 feet (1219 m)

**Rate of Fire:** Can fire six bursts per melee round and has a total of seven melee actions under robot mode, otherwise attacks are equal to those of the VR controller +2.

**Payload:** 2000 rounds, for a total of 50 bursts.

**2. Mini-Missiles:** Each weapon wing **fires** mini-missiles.

**Purpose:** Assault

**Mega-Damage:** Varies; usually high explosive (5D6 to a 5 ft/1.5 m radius) or armor piercing (1D4x10 to a 3 ft/.9m radius).

Rate of Fire: May be fired individually or in volleys of 2 or 4.

Range: One mile (1.6 km).

Payload: A total of 24 rockets altogether! Each launcher has 6, forward facing tubes, and each tube contains 2 rockets.

**3. Sensors and other systems:** Thermographic, low light, HUD, targeting scope, laser targeting, terrain following radar, external loudspeaker (for the VR pilot), infrared optics, directional microphone, external camera and sensor system and 100 mile (160 km) range communications.

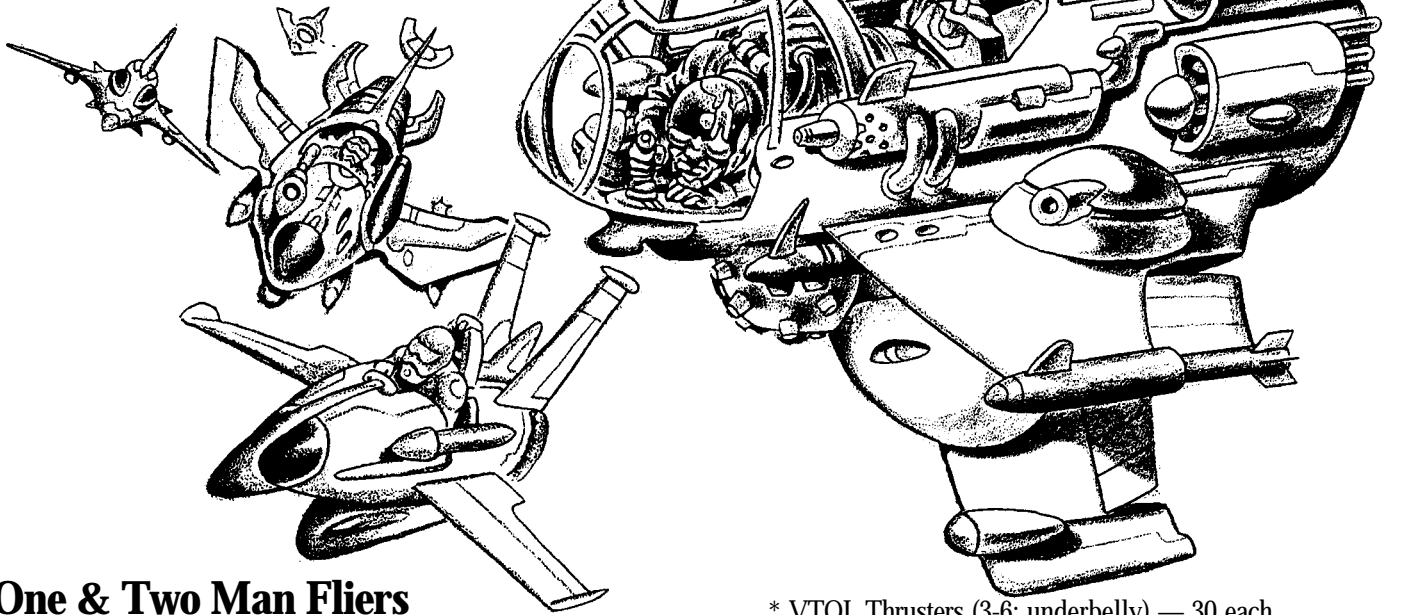

## One & Two Man Fliers

Both Perth and Melbourne have a variety of small, one and two man VTOL aircraft used exclusively by the military. Most are no larger than an automobile, jeep or van with wings. Most have the same basic features only varying in speed (10-30%) and exact type or combinations of weapons. Most have a main gun, typically a turret built in or under the nose or cockpit, a pair of light secondary weapons, and medium-range **and/or** mini-missiles mounted on the main pair of wings. These vehicles are not any faster than the assault helicopter and are designed for quick response, Vertical Take-Off and Landing, hovering, slow speed fight and flying low to the ground. As such, they can easily navigate above the city streets, around buildings, maintain tree top level or hug the ground (five feet/1.5 m above the ground). They are used to police and defend the Tech-Cities, make border patrols, and perform reconnaissance, pursuits, raids, troop support and surgical strikes into the Outback. **Note:** See pages 40, 88, 93, 172 and 184 for depictions of these aircraft.

### One & Two Man Fliers

**Crew:** 1-2; typically a pilot or pilot and co-pilot/gunner.

**Passengers:** None.

**Primary Purpose:** Air Assault and Troop Support.

**M.D.C. by Location:**

- \* Nose Gun/Main Gun — 50
- \* Secondary Guns — 30 each
- \* Searchlight (1; underbelly) — 10
- \* Jet Thrusters (2-4; rear) — 70 each

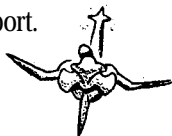

\* VTOL Thrusters (3-6; underbelly) — 30 each

Tail Section — 135

Wings (2-4) — 100 each

Reinforced Pilot's Compartment — 50

\*\* Main Body — 200 to 300 depending on size and body styling.

\* A single asterisk indicates a small **and/or** difficult target to strike. A character must make a *called shot*, and even then it is made with a -3 to strike.

\*\* Depleting the M.D.C. of the main body destroys the vehicle.

### Speed

Ground: Not possible unless hauled by another vehicle.

Maximum Air Speed: Fliers can hover stationary, or achieve a maximum speed of 480 mph (768 km). Maximum altitude is typically 5000 feet (1524 m).

### Statistical Data

Height: Varies from 8-12 feet (2.4 to 3.6 m).

Width: Varies from 10-20 feet (3 to 6 m) depending on the wingspan.

Length: Varies from 12 to 22 feet (3.6 to 6.7 m)

Weight: Varies from 5-12 tons

Range & Power Systems: 500 miles (800 km) with a combustion engine; unlimited for nuclear (20 year life).

Cargo: None, other than payload and crew.

Cost: 2.8 to 6.2 million; reduce by half if not nuclear powered (approximately half are nuclear powered).

## Features and Weapon Systems

1. **Nose Gun (1):** Slung underneath the nose of the cockpit is a weapon turret, the primary weapon of the aircraft. Typically a double-barrelled laser for range and accuracy.

Purpose: Anti-Personnel & Assault.

Mega-Damage: A single beam does 3D6+2 M.D., a simultaneous dual blast does 1D4x10M.D.

Range: 3000 feet (914 m)

Rate of Fire: Each single or dual blast counts as one melee attack. The total number of attacks is equal to the pilot's attacks per melee round +1.

Payload: Effectively unlimited.

2. **Secondary Guns (2):** A light laser or other energy weapon is typically located on each side of the aircraft, typically on the fuselage or at the base of the wing. These are operated by the gunner. Typically a single-barrelled laser for range and accuracy, but can be substituted for other energy weapons. Rail guns are generally not used due to the extra weight and bulk of the gun and its ammo-drum, and the **vibrations/kick** when fired.

Purpose: Anti-Personnel & Assault.

Mega-Damage: A single beam does 2D6 M.D., a simultaneous dual blast does 4D6 M.D. Other energy weapons, like particle beams or ion guns, may do more damage but have shorter range.

Range: 3000 feet (914 m); all others 1600 feet (183 m).

Rate of Fire: Each single or dual blast counts as one melee attack. The total number of attacks is equal to the gunner's attacks per melee round +1.

Payload: Effectively unlimited.

3. **Missiles:** Typically, two medium-range missiles or four mini-missiles are mounted on each wing (2-4 wings; most have two). If **necessary**, short-range missiles can be used in place of medium-range ones, and two mini-missiles can replace one medium or short-range missile. Typically launched by the gunner.

Purpose: **Anti-Aircraft** and Heavy Assault.

Mega-Damage: Varies with missile type. Medium-Range Missiles are typically Armor Piercing or High Explosive (3D6x10 M.D.).

Mini-Missiles are typically Armor Piercing (1D4x10M.D.).

**Napalm/Plasma** types are only used at sea to avoid starting dangerous fires.

Rate of Fire: 1, 2 or 4 missiles in a volley.

Maximum Effective Range: Medium-Range: Approx. 50 miles (80 km). Mini-Missiles: One mile (1.6 km).

Payload: Varies. A minimum of two medium-range per wing or four minis.

4. **Additional Weapons:** Most **two-man** Flyers can accommodate two additional light weapon systems or one heavy (i.e. mini-missile launcher, rail gun, double-barreled weapon turret, and similar). However, only 40% have an extra weapon or two.

5. **Ejector Seats, Sensors and Other Features:** Same as the Viper Helicopter.

**Bonuses:** +1 to strike with all ranged weaponry, +2 to dodge and +1 on initiative.

## Experience Tables



### Kwarla Mystic/Elder

#### Sham-Man/

#### False Sorcerer

1	0,000-2,240
2	2,241-4,480
3	4,481-8,960
4	8,961-17,920
5	17,921-25,920
6	25,921-35,920
7	35,921-50,920
8	50,921-70,920
9	70,921-95,920
10	95,921-135,920
11	135,921-185,920
12	185,921-225,920
13	225,921-275,920
14	275,921-335,920
15	335,921-395,920

### Kwarla Demon Hunter

1	0,000-2,200
2	2,201-4,400
3	4,401-8,800
4	8,801-17,600
5	17,601-27,800
6	27,801-37,900
7	37,901-55,100
8	55,101-75,200
9	75,201-100,300
10	100,301-145,500
11	145,501-190,600
12	190,601-245,700
13	245,701-295,800
14	295,801-345,900
15	345,901-415,100

### Mokoloi Warriors

1	0,000-2,120
2	2,121-4,240
3	4,241-8,480
4	8,481-16,960
5	16,961-24,100
6	24,101-34,200
7	34,201-49,300
8	49,301-70,400
9	70,401-96,500
10	96,501-132,600
11	132,601-190,700
12	190,701-240,800
13	240,801-290,900
14	290,901-350,100
15	350,101-400,200

### Shadow People

1	0,000-2,500
2	2,501-5,000
3	5,001-10,000
4	10,001-20,500
5	20,501-32,000
6	32,001-47,000
7	47,001-62,000
8	62,001-82,000
9	82,001-112,000
10	112,001-160,000
11	160,001-220,000
12	220,001-300,000
13	300,001-380,000
14	380,001-460,000
15	460,001-540,000



# Experience Tables

Note: Experience tables for R.C.C.S and the Sham-Man are on page 223.

<b><u>Average Outbacker &amp; Merchant Trader</u></b>	<b><u>Jackaroo, Roadganger, &amp; Sportsman</u></b>	<b><u>Raider, Technologist, Guide/Scout/Hunter &amp; Bushman</u></b>	<b><u>Mutants, Road Sentinel, &amp; Special Ops Soldier</u></b>
1 0,000-1,875	1 0,000-1,970	1 0,000-2,050	1 0,000-2,150
2 1,876-3,750	2 1,971-3,940	2 2,051-4,100	2 2,151-4,300
3 3,751-7,250	3 3,941-7,880	3 4,101-8,250	3 4,301-8,600
47,251-14,100	4 7,881-14,880	4 8,251-16,500	4 8,601-18,600
5 14,101-21,200	5 14,881-21,880	5 16,501-24,600	5 18,601-26,600
621,201-31,200	6 21,881-31,880	6 24,601-34,700	6 26,601-36,600
7 31,201-41,200	7 31,881-41,220	7 34,701-49,800	7 36,601-54,600
841,201-51,200	8 41,221-54,440	8 49,801-69,900	8 54,601-75,600
951,201-71,200	9 54,441-74,660	9 69,901-95,000	9 75,601-99,600
1071,201-101,500	10 74,661-104,880	10 95,001-130,000	10 99,601-135,600
11 101,501-136,500	11 104,881-139,220	11 130,001-180,200	11 135,601-185,600
12 136,501-186,500	12 139,221-189,440	12 180,201-230,000	12 185,601-240,600
13 186,501-236,500	13 189,441-239,660	13 230,001-280,400	13 240,601-290,600
14236,501-286,500	14 239,661-290,880	14 280,401-340,500	14 290,601-343,600
15286,501-326,500	15 290,881-335,000	15 340,501-400,600	15 343,601-423,600
<b><u>Bushranger, Runabout, Infantry Grunt, &amp; City Police</u></b>	<b><u>Aero-Jock, City Trader, &amp; Naval Sailor</u></b>	<b><u>City Administrator, Cyber-Specter, Police TRG</u></b>	<b><u>Songjuicer</u></b>
1 0,000-1,925	1 0,000-2,000	1 0,000-2,140	1 0,000-2,000
2 1,926-3,850	2 2,001-4,000	2 2,141-4,280	2 2,001-4,000
3 3,851-7,450	3 4,001-8,200	3 4,281-8,560	3 4,001-8,200
4 7,451-15,000	4 8,201-16,400	4 8,561-17,520	4 8,201-16,400
5 15,001-21,500	5 16,401-24,500	5 17,521-25,520	5 16,401-24,500
6 21,501-31,500	6 24,501-34,600	6 25,521-35,520	6 24,501-34,600
7 31,501-41,500	7 34,601-49,700	7 35,521-50,520	7 34,601-45,700
8 41,501-54,000	8 49,701-69,800	8 50,521-71,000	8 45,701-55,800
9 54,001-75,000	9 69,801-94,900	9 71,001-96,100	9 55,801-63,700
10 75,001-105,000	10 94,901-129,000	10 96,101-131,200	10 63,701-69,600
11 105,001-140,000	11 129,001-179,100	11 131,201-181,300	11 69,601-74,500
12 140,001-190,000	12 179,101-229,200	12 181,301-231,400	12 74,501-78,400
13 190,001-240,000	13 229,201-279,300	13 231,401-281,500	13 78,401-81,300
14 240,001-300,000	14 279,301-329,400	14 281,501-341,600	1481,301-82,200
15 300,001-350,000	15 329,401-389,500	15 341,601-400,700	15 82,201-83,100

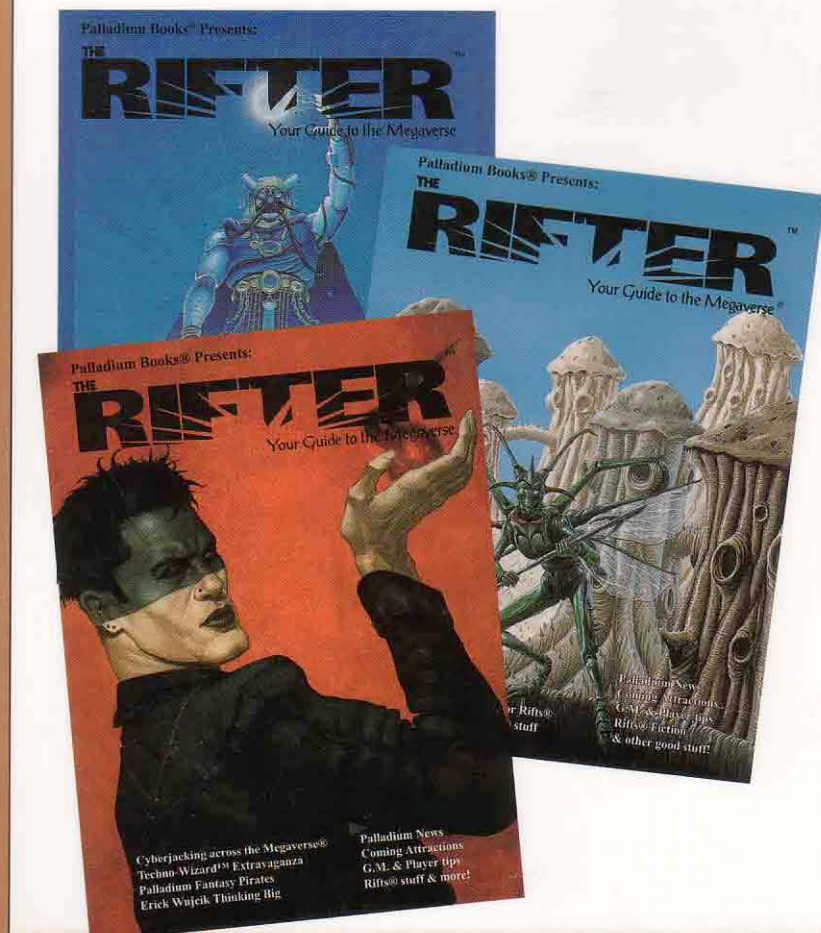

## The Rifter™

The Rifter™ Sourcebook Series provides the reader with ideas and source material for **Rifts®** and the entire Palladium Megaverse®, plus news, serialized stories, Knights of the Dinner Table® comic strip, Rifts® New West™ comic strip (by Ramon Perez, starting in #6), and more. *The Rifter* #6 will also include the Rifts Russia: Gods by Kevin Siembieda. Regular contributors include Siembieda, Wujcik, Breaux, Blackburn, Coffin and others.

112 pages for only \$7.95 — so if you haven't taken a look at **The Rifter** yet, isn't it time you did?

### Coming for Rifts in 1999

Rifts® Canada West

Rifts® Splynn Dimensional Market (Atlantis)

Rifts® Free Quebec

Rifts® Scotland

Rifts® Xiticix

Rifts® Australia Two: Mystic Australia™

Rifts® Australia Three: Dreamtime

Rifts® Three Galaxies™

The Rifter™ Sourcebook series continues and more ...

Available at stores everywhere

## Rifts® Australia (Book One)

Isolated from the rest of the world, the Land Down Under is a unique and wild land of survival, adventure, monsters and magic. Written by native Australian Ben Lucas (with additional material by Siembieda). One of the most requested **Rifts® World Books** is finally a reality!

- Melbourne & Perth, two high-tech powers who may become the Coalition States of Australia — hard, paranoid, & cruel.
- Rules for creating Outback communities.
- Over 20 O.C.C.s like the Bushman, Jackaroo and Road Sentinel.
- Mystic O.C.C.s include the Sham-Man and Songjuicer.
- Mutants and Monsters.
- Dreamtime gods and menaces.
- New weapons and technology.
- World information and adventure ideas.
- 224 pages.

Rifts, endless possibilities limited only by one's imagination!™

\$20.95

Cat. No. 834

I.S.B.N. 157457-018-8

ISBN 1-57457-018-8



9 781574 570182