

PALLADIUM BOOKS® PRESENTS:

RIFTS® WORLD BOOK 17:

WARLORDS OF RUSSIA™

BY KEVIN SIEMBIEDA

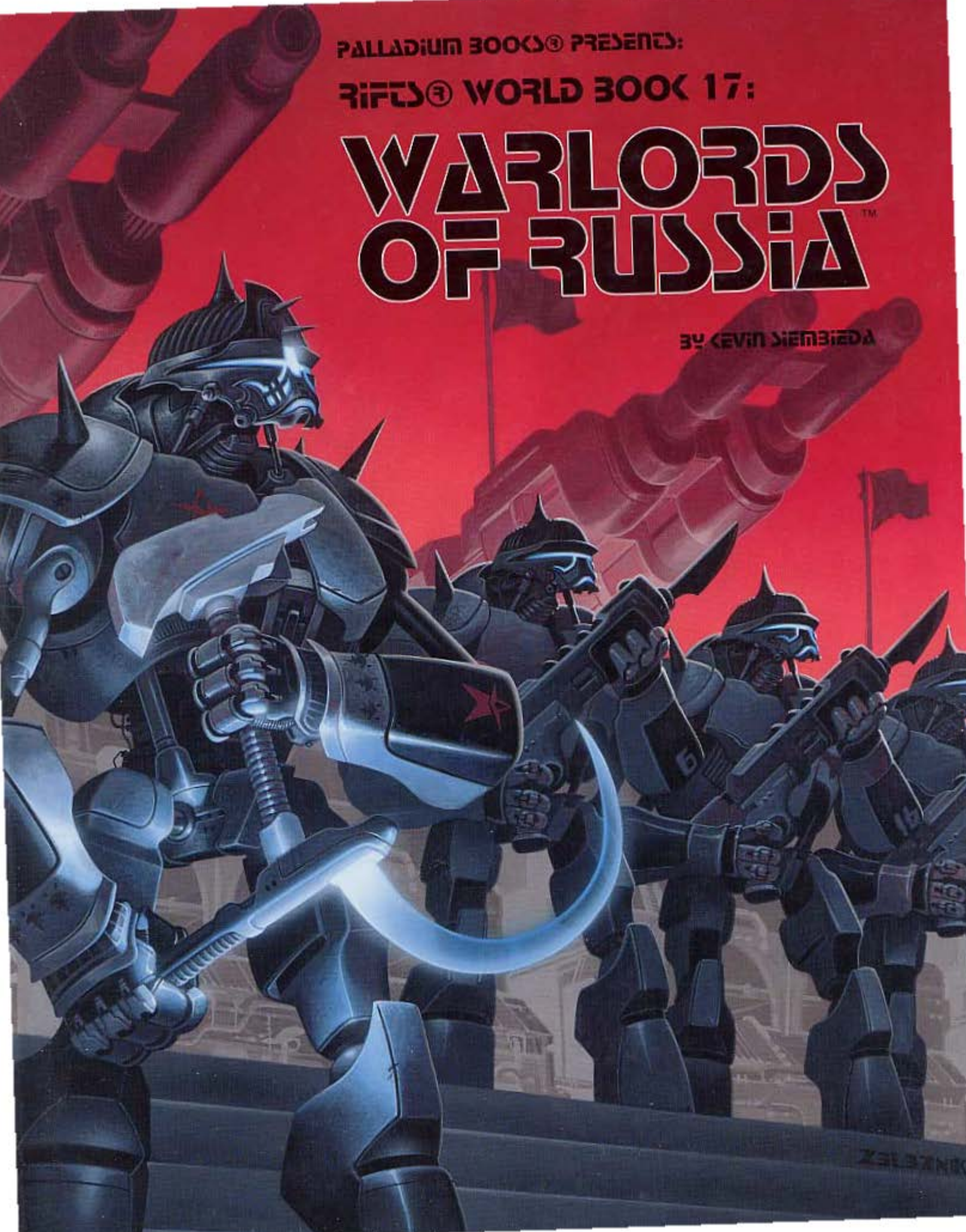

Warning!

Violence and the Supernatural

The fictional world of **Rifts**® is violent, deadly and filled with supernatural monsters. Other dimensional beings often referred to as "demons," torment, stalk and prey on humans. Other alien life forms, monsters, gods and demigods, as well as magic, insanity, and war are all elements in this book.

Some parents may find the violence, magic and supernatural elements of the game inappropriate for young readers/players. We suggest parental discretion.

Please note that none of us at Palladium Books® condone or encourage the occult, the practice of magic, the use of drugs, or violence.



An epic world book for the **Rifts**® series.
Compatible with the entire **Palladium Books**® **Megaverse**®!

Dedicated to the Palladium fans and role-players everywhere. May role-playing last forever, and your imaginations carry you to one grand adventure after another.

— *Kevin Siembieda, 1998*

Palladium On-Line: www.palladiumbooks.com

First Printing — August, 1998

Copyright © 1998 Palladium Books Inc. & Kevin Siembieda

All rights reserved, world wide, under the Universal Copyright Convention. No part of this book may be reproduced in part or whole, in any form or by any means, without permission from the publisher, except for brief quotes for use in reviews. All incidents, situations, institutions, governments and people are fictional and any similarity, without satiric intent, of characters or persons living or dead, is strictly coincidental.

Palladium Books®, Rifts®, RECON®, and Megaverse® are registered trademarks owned and licensed by Kevin Siembieda and Palladium Books Inc. Triax & The NGR, Mindwerks, New West, Lone Star, Psyscape, Coalition States, Erin Tarn, Emperor Prosek, Splugorth, Lords of Magic, Chi-Town, Skelebots, SAMAS, Dog Boys, Dog Pack, Techno-Wizard, Ley Line Walker, Shifter, Cyber-Knight, Psi-Stalker, Simvan, Brodkil, Juicer, Crazy, 'Borg,'Bot, D-Bee, Hero-Knight, War-Knight, Ectohunter, Smoke Soldier, Cyborg Shocktrooper, Light Machine, Heavy Machine, White Tiger, Avenging Angel, Demonfist, Mega-Steed, Megahorse, Wingrider and other names, titles and likenesses of characters are trademarks owned by Kevin Siembieda and Palladium Books Inc.

Rifts® World Book 17: Warlords of Russia™ is published by Palladium Books Inc., 12455 Universal Drive, Taylor, MI 48180. Printed in the USA.

PALLADIUM BOOKS® PRESENTS:

RIFTS® WORLD BOOK 17:

WARLORDS OF RUSSIA TM

BRANDT - 98

Written by: **Kevin Siembieda**

Additional Text & Concepts: **Kevin E. Krueger**

Editors: **Alex Marciniszyn**

Jim Osten

Wayne Smith

Proofreader: **Julius Rosenstein**

Cover Painting: **John Zeleznik**

Interior Artists: **Wayne Breaux Jr.**

Ramon Perez Jr.

Scott Johnson

Mark Dudley

Brandon C. Clark

Ka Xiong

Drunken Style Studio

Art Direction, Maps & Keylining: **Kevin Siembieda**

Typography: **Maryann Siembieda**

Based on the RPG rules, characters, concepts and Megaverse® created by **Kevin Siembieda**.

Palladium Books On-Line: www.palladiumbooks.com

Special Thanks to the guys at Drunken Style Studio (Mark, Ka and Brandon) for jumping in at the last minute and kicking out some great art. Also to Ramon and Scott for their excellent, as usual, artwork, and especially to Wayne Breaux whose art has seemed to reach a new level of quality and who had to power through the bulk of this book as well as other stuff. And to Maryann, Steve, Alex, Thom, Wayne, Jules and the rest of the Palladium Cossacks, your Warlord appreciates you.

— *Kevin Siembieda, 1998*

Contents

Experience Tables	6
Introduction	9
Hearsay about Russia from Erin Tarn • • •	10
Vladimir Kroslavsky's Telling of History	11
Rifts® Russia •	13
Russian History	13
Post Cataclysm History	13
The Eighty Years of Winter •	13
Technology	14
Magic •	14
Russian Hospitality	14
The New Russian Frontier •	15
Roads & Travel	15
Dangers on the Road •	15
Deep Forests •	15
The Danger of Ley Lines •	17
Travel Through the Forests •	17
Geographic Overview	18
The Russian Desert of the Southwest • • •	19
Western Mountain Region •	19
The Taiga — Northern Forests	20
The White Sea •	20
The Warm Barents Sea	20
Saint Peter's Spine (mountains)	21
The Volga River •	21
The Black Sea	21
The Boiling Sea	21
The Steppe •	22
Deadzones •	22
The Moskva Crater •	22
Other Lands •	22
The Former Ukraine	22
Poland •	23
New German Republic	23
The Role of the Warlords •	24
Russian Society on Rifts Earth	24
The Matter of D-Bees •	25
The Warlords •	25
Warlord Camps •	26
The Military Applications of War Camps • •	27
The Brotherhood of Heroes •	29
Conscription •	30
The Sphere of Influence •	30
Warlord Tribute •	33
Grievances •	33
Rivalry Between Camps •	33
The Warlords of Russia •	34
Warlord Alekseyevna •	35
Warlord Burgasov •	37
Warlord Kolodenko •	40
Warlord Orloff •	44
Warlord Romanov •	46
Warlord Seriyev •	51
Warlord Sokolov •	53
O.C.C. Descriptions •	57
O.C.C. Notes •	57
Bogatyr/Hero-Knight O.C.C. •	58
Code of the Bogatyr •	60
Ectohunter O.C.C. •	61
Ghost Killing •	63
Explorer O.C.C. •	64
The Huntsman/Trapper O.C.C. •	66
Special Skills & Bonuses •	67
Travelling Story Teller O.C.C. •	69
Russian Villager O.C.C. (optional) •	71
Warlord Troops & Men at Arms O.C.C.s •	72
The Military Hierarchy of the War Camps	72
Cossack O.C.C. •	73
Special Cossack Skills & Bonuses • • • •	74
Reaver O.C.C.s •	77
The Average Reaver Soldier O.C.C. • • • •	78
Reaver Mechanized Cavalry O.C.C. • • • •	79
Reaver Assassin O.C.C. •	82
Reaver Military Scout O.C.C. •	84
Reaver Bandit/Raider O.C.C. •	85
Soldati (Soldier) O.C.C. •	87
Soldati Dimiye/Smoke Soldier O.C.C. • • • •	89
War-Knight O.C.C. •	91
Typical War-Knight Power Armor • • • •	93
Warlord Cyber-Doc O.C.C. •	94
Wingrider RPA Pilot O.C.C. •	95
Special O.C.C. Bonuses •	96
O.C.C. Note •	98
Russian Bionics •	98
Control of Cyber-Technologies •	99
Russian Cybernetic Systems •	99
Cyber-Optics •	101
Cyber-Audio Systems •	102
Notable Sensors & Special Systems • • • •	102
Chassis/Body Options •	103
Cyborg Weapon Systems •	104
Cyborg O.C.C.s •	107
Light Machine •	107
Heavy Machine •	111
Cyborg Shocktroopers •	114
Tempest (Alekseyevna) •	116
The Butcher (Burgasov) •	119
The Ripper (Burgasov) •	121
White Tiger (Kolodenko) •	123
Holocaust (Orloff) •	126
Aftermath (Orloff) •	129
Avenging Angel (Romanov) •	131
Vibro-Scythe Polearm •	132
Assassin Cyborg (Seriyev) •	134
Mantis (Seriyev) •	136
Demonfist (Sokolov) •	138
Russian Vehicles & War Machines • « « « •	140
Old style, Pre-Cataclysm Vehicles •	140
Russian Combat Vehicles •	142
Adventuring & Combat Vehicles •	144
Novyet Arctic Hoverbike •	144
Novyet Snow-Jetsled •	145
Novyet Landcrawler-Sku •	146
Novyet Explorer-Sku •	147
Novyet Bear ATV •	148
Other Vehicles of Note •	149
Heavy M.D.C. Snowmobile •	149
Tek-12 YY110 Bushbike •	150
Tek-20 YY210 'Borgbike •	151
Landflier •	153
Warrior Assault Hoversled (AH) •	154
War Chariot •	156
War Wagon/Mechanized Ram •	157

Warthron	159
Wingrider Flying Wing	162
Wingrider Power Armor	164
Mega-Steeds	164
The TrueMegahorse	164
Horned Steed	165
Burkov Mastadon	167
Steppe Ostrich	168
Ursan Forest Steed	169
Bionic Horses	171
Horse Barding	172
Body Armor	173
Homemade M.D.C. Armor	173
Trapper Body Armor	173
Sovietski "Red Star" Armor	173
Bear Body Armor	174
Minsky Mekanikal MM-61 Explorer Exoframe	176
Russian Weapons	177
Exotic & Foreign Weapons	177
E-Clips	177
M.D.C. Shields	178
Servo-Harness Rig	178
Rail Guns	179
Razor Disk Cannon	180
Missile Launchers	181
Energy Weapons	182
G-295 "Steamer" Pulse Laser Rifle	184
G-21P Laser Pistol	185
Vibro-Blades	185
High-Tech Arrowheads	186
Miscellaneous Equipment	186
Field Equipment	187
Miscellaneous	188
Clothing o fNote	189
New Rifts Skills	190
Complete Skill List by Category	190
Skill Descriptions	191
Horsemanship	196
The Sovietski	201

Kolodenco: Black Panther Cyborg Shocktrooper	41
Ley Lines & the Supernatural	17
Long Winter: see Eighty Years of Winter	13
History, Kroslavsky's Telling of History	11
Historical Overview: Tarn & Kroslavsky	10
O.C.C.s for the Russian Setting	57
O.C.C.s from other Rifts® Books	57
Mystic Kuznya (see <i>Rifts® Mystic Russia</i>)	98
NPC: Russian Villager	71
Power Armor: Bear Exoskeleton	174
Power Armor: MM-61 Explorer Exoframe	176
Power Armor: Wingrider	164
Power Armor: War-Knight	93
Reavers: General Data	76
RMC (Reaver Mechanized Cavalry)	79
Steppe, T h e	22
Table: Forest Travel Table	17
Tarn on 80 Years of Winter	10
Tarn on Warlords	10
Travel, Roads & the Supernatural	15
Ukraine, The	22
Ukraine: Novyet Vehicles	144
Ukraine: Romanov	46
War Camps	26
War Camp: Females	30
War Camp: Laws of the Common People	31
War Camp: Military Hierarchy	72
War Camp: Outsiders/Reavers	30
War Camp: Rivalry Between Camps	33
War Camp: Sphere of Influence	30
War Camp: Typical Troop Breakdown	73
Warlords: Control of Cyber-Technologies	99
Warlords: Individual Descriptions Begin	34
Wingrider RPA Pilot O.C.C.	95
Wingrider O.C.C. Bonuses	96
Wingrider Flying Wing	162
Wingrider Power Armor	164

Quick Find Table

AH-Sled (Assault Hoversled)	154
Armor: Body Armor	173
Armor: Horse Armor/Barding	172
Armor: "Trapper" illustration (see Kolodenco)	42
Bionic Horses	171
Cossack: Kolodenco Alley	42
Cossack O.C.C.	73
Cossack: Mega-Steeds	164
Cossack: Skill: Breaking/Training Wild Horses	75
Cossack: Skill: Horsemanship	74
Cossack: Skill: Trick Riding	75
Cossack: Skill: Trick Shooting	75
Cossack: T h eSteppe	22
Cyber-link Vehicle Interface	100
Deep Forests & the Supernatural	15
Eighty Years of Winter	13
Experience Tables	6
Kolodenco (description)	40
Kolodenco: Cossack Allies	42

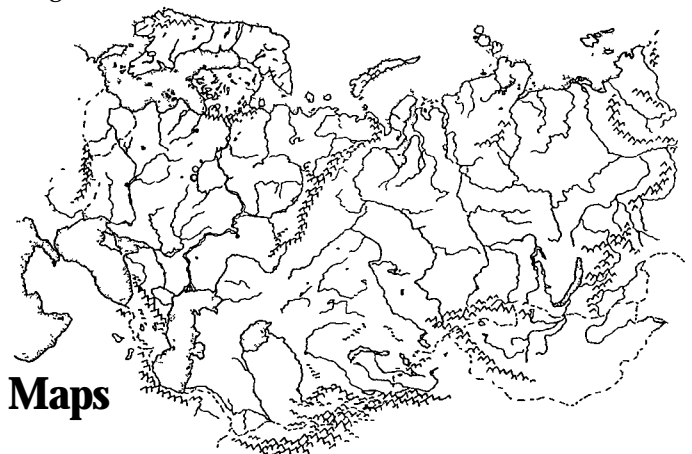

Maps

Arable Land (good for Agriculture)	22
Overview of Western & Central Russia	20
Russian Desert Region	19
Steppe, T h e	22
Warlord Alekseyevna's Sphere	36
Warlord Burgasov's Sphere	37
Warlord Kolodenco's Sphere	41
Warlord Orloff's Sphere	45
Warlord Romanov's Sphere	49
Warlord Seriyev's Sphere	52
Warlord Sokolov's Sphere	55

Experience Tables

Villager & Reaver Bandit

1	0,000-1,875
2	1,876-3,750
3	3,751-7,250
4	7,251-14,100
5	14,101-21,200
6	21,201-31,200
7	31,201-41,200
8	41,201-51,200
9	51,201-71,200
10	71,201-101,500
11	101,501-136,500
12	136,501-186,500
13	186,501-236,500
14	236,501-286,500
15	286,501-326,500

Explorer, Reaver Military Scout & Reaver Soldier

1	0,000-1,925
2	1,926-3,850
3	3,851-7,450
4	7,451-15,000
5	15,001-21,500
6	21,501-31,500
7	30,501-41,500
8	41,501-54,000
9	54,001-75,000
10	75,001-105,000
11	105,001-140,000
12	140,001-190,000
13	190,001-240,000
14	240,001-300,000
15	300,001-350,000

Sovietski Police & Soldati/Soldier

1	0,000-1,970
2	1,971-3,940
3	3,941-7,880
4	7,881-14,880
5	14,881-21,880
6	21,881-31,880
7	31,881-41,220
8	41,221-54,440
9	54,441-74,660
10	74,661-104,880
11	104,881-139,220
12	139,221-189,440
13	189,441-239,660
14	239,661-290,880
15	290,881-335,000

Ectohunter, Story Teller, Priest & Warlord Cyber-Doc

1	0,000-2,000
2	2,001-4,000
3	4,001-8,200
4	8,201-16,400
5	16,401-24,500
6	24,501-34,600
7	34,601-49,700
8	49,701-69,800
9	69,801-94,900
10	94,901-129,000
11	129,001-179,100
12	179,101-229,200
13	229,201-279,300
14	279,301-329,400
15	329,401-389,500

Hunter-Trapper & Mechanized Cavalry

1	0,000-2,050
2	2,051-4,100
3	4,101-8,250
4	8,251-16,500
5	18,501-24,600
6	24,601-34,700
7	34,701-49,800
8	49,801-69,900
9	69,901-95,000
10	95,001-130,000
11	130,001-180,200
12	180,201-230,000
13	230,001-280,400
14	280,401-340,500
15	340,501-400,600

Light Machine Cyborg

1	0,000-2,100
2	2,101-4,200
3	4,201-8,400
4	8,401-16,800
5	16,801-25,000
6	25,001-35,000
7	35,001-50,000
8	50,001-70,000
9	70,001-95,000
10	95,001-130,000
11	130,001-180,000
12	180,001-234,000
13	234,001-285,000
14	285,001-345,000
15	345,001-410,000

War-Knight & Bogatyr/Hero-Knight

1	0,000-2,140
2	2,141-4,280
3	4,281-8,560
4	8,561-17,520
5	17,521-25,520
6	25,521-35,520
7	35,521-52,520
8	52,521-74,000
9	74,001-100,000
10	100,001-135,200
11	135,201-190,300
12	190,301-240,400
13	240,401-290,500
14	290,501-350,600
15	350,601-420,700

Cossack, Wingrider & Heavy Machines

1	0,000-2,150
2	2,151-4,300
3	4,301-8,600
4	8,601-18,600
5	18,601-26,600
6	26,601-36,600
7	36,601-54,600
8	54,601-75,600
9	75,601-99,600
10	99,601-135,600
11	135,601-185,600
12	185,601-240,600
13	240,601-290,600
14	290,601-343,600
15	343,601-423,600

Smoke Soldier & Reaver Assassin

1	0,000-2,200
2	2,201-4,400
3	4,401-8,800
4	8,801-17,600
5	17,601-27,800
6	27,801-37,900
7	37,901-55,100
8	55,101-75,200
9	75,201-100,300
10	100,301-145,500
11	145,501-190,600
12	190,601-245,700
13	245,701-295,800
14	295,801-345,900
15	345,901-415,100

Cyborg Shocktroopers

1	0,000-2,500
2	2,601-5,000
3	5,001-10,000
4	10,001-20,000
5	20,001-30,000
6	30,001-40,000
7	40,001-55,000
8	55,001-80,000
9	80,001-105,000
10	105,001-150,000
11	150,001-200,000
12	200,001-250,000
13	250,001-310,000
14	310,001-380,000
15	380,001-450,000

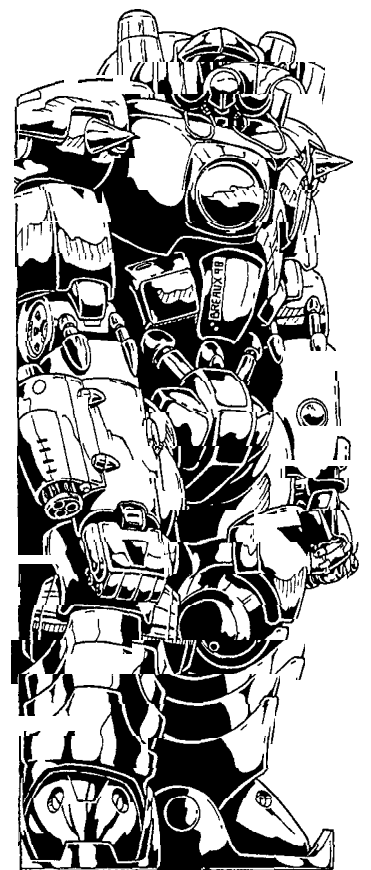

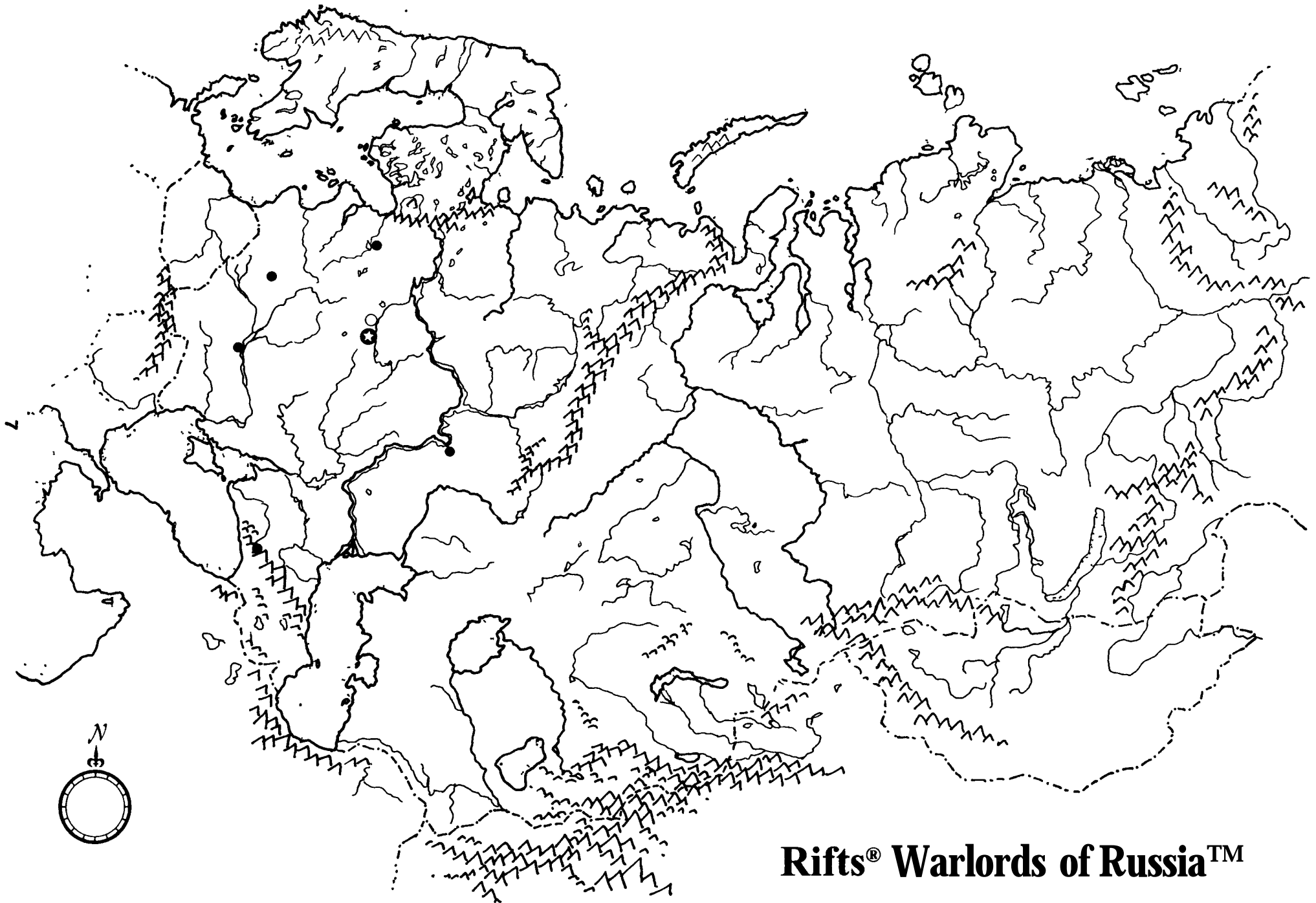

Rifts® Warlords of Russia™



A little bit about Rifts* Russia

When freelance writer Kevin Krueger first suggested the idea of a book on Rifts® Russia, I figured, sure, why not? I didn't have concrete plans for that part of the world, and thought it would be exotic enough to make a wonderful addition to the Rifts® Megaverse®. If done right, it would serve as a linchpin to the New German Republic and the rest of Europe, as well as the Orient.

I approved the project, commissioned a cover painting and started advertising its release. You'd think I'd know better by now ... advertising a book before seeing the finished manuscript. Krueger's manuscript was a mixed bag with a lot of cool ideas and names, but missed the mark and went in directions that seemed inappropriate, and didn't seem to have much of a Russian flavor. I suddenly found myself with two more books to write that I was never supposed to do in the first place!

Now maybe I should have shelved the books and gone forward with manuscripts requiring much less work, but I didn't. Using the Krueger manuscript as a detailed outline, I dived right in and got lost in research, concept development and the writing of **Warlords of Russia** and **Mystic Russia**. Reading Russian myth and history was fascinating and inspirational. The more I read and thought about it, the more ideas fell into place and two exciting books were starting to take root in my mind.

As long-time (and wonderfully patient) fans of Palladium know, I refuse to crank-out junk, and as I began writing these two books I realized they could be really **great** ... with just a little more time.

I don't know. Maybe the decision not to put the Russian project on the shelf was a bad idea. The decision to run with it ultimately knocked Palladium's entire 1998 schedule hopelessly out of whack and left another dozen freelance manuscripts to collect dust on the shelf. Furthermore, as other things interfered with my adjusted schedule, there was one delay after another. We all battled through fallen trees and loss of power from a storm that got our neck of the woods declared a "disaster area," left the neighborhood where we live without power for a week, and knocked Palladium further behind schedule. I juggled business and dealt with some unexpected problems and opportunities, and worked my butt off trying to get these books done as soon as possible without taking short-cuts.

The end result, **Rifts® Warlords of Russia™** may be five months late, and **Mystic Russia™** will be out a month or two after it, but man are they good!

Mystic Russia™ focuses on the magical, mystical, supernatural and inhuman people and practices of Rifts Russia. There's a bunch of new magic, supernatural beings, ancient gods and monsters inspired by Russian **myth**, along with more world information, hints about China and the inhuman antagonists that plague the Warlords and the people of Russia.

Warlords of Russia™ focuses on Western Russia (including the Ukraine, Lithuania, Estonia, and a few other places that are separate countries today) and the military forces that divide and rule that region. Although I didn't originally plan it this way, **Warlords of Russia** turned into an overview of Russia with a focus on the military and high-technology aspects of the region. There is loads of information about the Warlords, their warriors, cyborgs and war machines. I guess this makes perfect sense. I mean, the title of this book is "Warlords" of Russia, so the emphasis had to be on conflict, the military, weapons and gizmos. At the same time, I think Rifts Russia is unique to other parts of Rifts Earth. For one, it is a wild and unconquered land where anything goes. Just about any supernatural menace one can imagine is lurking around someplace in Russia, and the potential for action-packed adventures is tremendous. One of the unique aspects is that, overall, Russia is extremely low-tech. Oh sure, Vladimir the farmer may run out of his house with a half suit of homemade M.D.C. armor and a laser rifle instead of a shotgun, but he probably doesn't have electricity, indoor plumbing, or high-tech vehicles, unless you consider his plow horse high-tech. There are no giant robots or power armor, few armored vehicles, aircraft, or advanced alien people. The Warlords' Russia is very much a **throwback** to Medieval times, with the interesting juxtapositioning of limited, high-technology thrown in to gum up the works.

In fact, it is the survival and wild exploitation of bionics that has given the Warlords the edge and the power they needed to assert control over parts of Russia. It is that same, small segment of technology that has helped them to thrive and become something of a regional power. Their isolation from other advanced civilizations (Germany and Poland are the closest, and both have their own problems to deal with) has allowed Russia to develop its own, unique identity. And really, it is only beginning to develop that identity as it just begins to embark on a slow climb out of barbarism and savagery. And while the Warlords themselves may be only a few steps away from being true barbarians themselves, hordes of malignant creatures storm the gates and threaten to devour the civilization the Warlords are trying to rebuild.

— Kevin Siembieda, 1998

Hearsay about Russia from Erin Tarn

During my visit to the New German Republic, I heard many stories about the vast, desolate lands to the East. Lands which once belonged to the powerful Russian Empire. From what I learned in conversations and from video disk documentaries, Russia is an uncivilized and barbaric land much more lawless than the American West and even more monster-ridden than the Gargoyle and Brodtkil infested lands around Germany.

The Great Cataclysm ravaged the land and toppled much of civilization. Hundreds of millions died, and millions of others fell to the horrors that came afterward.

According to legend, after the eruption of the ley lines, Russia was plunged into a winter that lasted 80 years. It is said that fifty percent of the surviving population migrated from Russia to warmer climates to the west and south. Those who remained behind learned to survive in the "Land of Winter." Consequently, for the first hundred years after the Great Cataclysm, much of the old Russian Empire laid buried and forgotten under snow and ice. Although the seemingly endless winters came to an end about 80 years after the Great Cataclysm, the summers were short and much of the Russian countryside remained frozen and desolate for another 20 years. When Russia finally came back into bloom, it was a virgin wilderness of forest, tall grass and flowers. Most of the great old cities had been destroyed in the Great Cataclysm or fell into decay during the eighty years of winter. However, a few old cities and military installations survived, fairly well preserved, and even the toppled ruins offered treasure troves of ancient tools, weapons, books, building materials and resources. The snow, bitter cold and terrible winters had kept the ruins free from plunder by refugees and scavengers during that time. However, once word got out that the snows had finally receded and that the bones of the past lay open for the taking, people flocked to Russia in droves. Many were the descendants of Russian refugees glad to return "home." Others were human and D-bee peasants in search for a better life — a life where they could claim some land and build a home and little farm, or raise cattle and trap animals. Others were opportunists in search of artifacts, weapons, lost technology or raw materials to sell back west, particularly to the New German Republic and Poland. In fact, the NGR sent several exploratory and recovery teams into the reborn wilderness. Unfortunately, while opportunity awaited these hopeful people, so did danger.

To this day, the peasants, pilgrims, patriots and scroungers are met by demons, monsters and murderous D-bees who also claim the Russian Frontier as their own. Like the NGR and surrounding regions of eastern Europe, Russia has been beset by monsters and dangerous D-Bees for centuries. Many of these creatures have made the Russian Frontier their home. Hordes of demons are said to inhabit the region once known as Mongolia, and sweep north from the monster infested lands of China. According to most conservative estimates, the inhumans outnumber the humans by three to one — others suggest this number may be more accurately, ten to one, at least in regard to the eastern and southern portions of the old Russian Empire.

For the most part, these monsters are not an organized army or kingdom (although I am told there are kingdoms of monsters), but thronging multitudes of clans, small groups and lone hunters. A veritable hodgepodge of diverse life forms all converging on Russia as a land of opportunity. Many are said to have migrated from the demon-swollen plains of China, others from the West and Middle East, or abominations from the Rifts. In addition, humans, animals and even the Russian landscape have been ravaged and mutated by radiation unleashed from the stockpiles of nuclear warheads and atomic power plants shattered by the Great Cataclysm, as well as by alien radiation and magic energy that leached into the land from the Rifts and other dimensional anomalies. Witches, necromancers and foul sorcerers are also said to abound in the Russian Frontier. Evil madmen and tyrants who also beset the land with monsters add their own brand of terror.

Ironically, it would be the presence of these supernatural horrors, monsters and nonhumans which would ultimately give rise to the nefarious Warlords of Russia. Most of the warlords grew out of strong family clans and communities of people unwilling to give up their homeland without a fight. While the bloodletting was fierce, and most of such resistance groups were crushed, those who survived grew into powerful armed camps. Roving militiamen, or Cossacks, if you will, relentlessly battling monsters and servants of evil. The efforts of these Warlords and their brazen followers garnered the support of the people who saw them as their saviors and heroes of Mother Russia, especially at first. Many are the tales of these warriors riding into a village and/or through the countryside and systematically hunting down and destroying the monsters who enslaved and preyed upon the helpless farmers and peasants. I imagine the sense of relief and joy at seeing the Warlord hordes riding into town must be something akin to the arrival of the Cavalry in the Old American West. With the support of the people, the Warlords have become the reigning power in the New Russia. Nomadic warriors who ride across the land in small bands to vast swarms of horseback bionic warriors. However, these rough and bold warriors are not pure heroes.

It is my understanding that these Warlords and their legions are as much bandits and barbarians as they are heroes and protectors. The rule of the Warlords is self-serving and their justice comes at the sharp end of a **Vibro-Blade** or the barrel of a gun. They claim vast territories as their domain and hold sway over the land and people through military power, raw courage and audacity. With little other recourse, the people living in these regions become their subjects through default. They must obey and support their Warlord or suffer the dire consequences. While this arrangement undoubtedly works to some benefit for the people (the Warlords and their camps do offer protection and relentlessly battle the demon hordes), they are little more than serfs. The people have no control over the Warlords or their activities. If a Warlord's actions brings down the wrath of an enemy, the people must endure it. If the Warlord's troops plunder a town of its food and resources, the people must endure it. Worse, the Warlords and their legions can do pretty much as they please. They are, through military might, the law, but a corrupt law unto itself and which does as it pleases. This loose, chaotic structure also means that the level of compassion and corruption can vary dramatically among bands within the same

camp. Thus, one group of Cossacks may offer genuine concern for the welfare of the people and respect local laws and elders, while the next may ride into the village doing as they please and taking what they want, including women.

The lands claimed by the Warlords are often disputed, not just by the people already inhabiting them, or by the monsters, wizards and witches who also claim them as their own, but by other Warlords. This can lead to frequent clashes between the various Warlord camps, as well as, regular raids and rustling against rival camps. Sometimes these clashes between Warlords become nearly as common as their war against the monsters, demons, and witches that haunt the land, although they are seldom as bloody.

If what I am told is accurate, the Warlords of Russia are a strange reflection of our times: savage barbarians who use force and intimidation to maintain power, yet at the same time, possess advanced bionic augmentation and high-tech weaponry. An amalgam of the modern and the ancient. The primordial and the civilized. The heroic and the corrupt.

The following is a transcript I made from an audio recording courtesy of a Russian immigrant named Vladimir Kroslavsky. He is something of an amateur rogue scholar and adventurer whom I found to be honest and forthright. I thought presenting his summary of the Warlords and the Russian Frontier would provide additional insight to my own, modest report.

Erin Tarn — circa 103 PA.

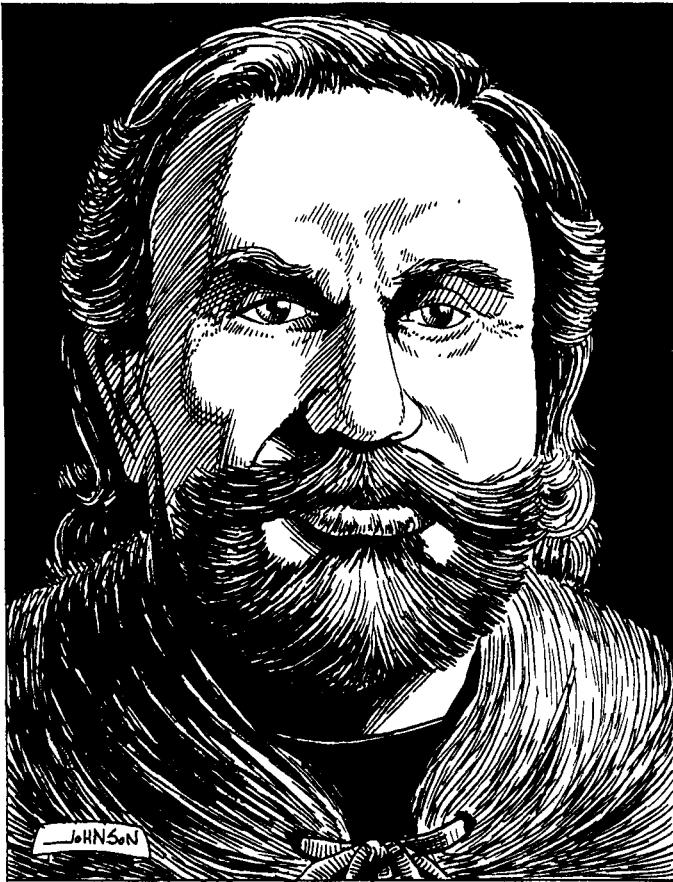

"Before the Coming of the Rifts, the former Russian **Empire** encompassed all of northern Eurasia, having regrown to claim most of it's former U.S.S.R. territories. It sprawled across more than ten time zones and encompassed many different climates,

peoples and cultures. The Russian Empire ran east, starting from the borders of former *Poland, Czechoslovakia, Ukraine* and *Romania*, west to the *Kamchatka Peninsula* and the *Pacific Ocean*. And from points above the *Arctic Circle* to the southern borders of former *Turkey, Iran* and *China*.

"The Russia of today is largely a dangerous and savage wilderness punctuated by the occasional village, farm and fortified city inhabited by humans. There are also clusters of D-Bees, but the rest of the land is inhabited by bands of ferocious alien creatures, mutants, ghosts and demons. Hell-spawned things who have come to make their homes in our woodlands, mountains and even the frozen tundra and wind-swept plains of *Siberia*.

"When the time of the Long Winter came, many of the Russian people — humans — could not endure the cold and hardships that came with it. My Great, Great Grandfather tried, so I know of what I speak. He talked about rich farmlands buried under 10 meters (33 feet) of snow and ice. Only hunters and scavengers had any prayer for survival, but even the wolf struggled and fled to the east. Only the ghosts, demons and monsters flourished. Since that day, such monsters have dominated the land.

"When the snow receded and the cycle of the seasons returned, men ... humans ... Russians ..., returned to the Motherland, but they were greeted by the ghosts and demons who had already settled in the land. Terrible monsters who delight in killing and feasting on the meat and bones of men.

"Despite the impossible odds, the people have reclaimed some of Mother Russia. Ironically, salvation comes from the hands of the cybernetic Warlords of Russia. Warriors who are half man, half machine, and as savage and merciless as the monsters they fight. Wild and barbaric horsemen in the tradition of the ancient, but remembered, Cossacks, who now ride through the forests, plains and tundra on the backs of beasts and robot steeds. Men and women who have taken up the gauntlet to reclaim the land of their forefathers and bellow with vengeance. The Warlords and their camps are little more than barbarian hordes who wear the trappings of technology and a thin veneer of civilization. They control stretches of land from the Polish border to beyond the Ural Mountains, and dare to take their battles into the northern wastelands of Siberia and make expeditions into Mongolia and northern China.

"Each Warlord Camp has its own unique type of cyborg, and favored bio-mechanical augmentation. It is said that each holds its own cybernetics factories in the east, reclaimed and rebuilt from the ruins of the old Soviet Union's military complex, but I know they also get supplies from outlaw industrialists in Poland and even the NGR.

"Big-wheeled, all-terrain vehicles, trucks and horses are used by these reavers, especially in the summer months, but most favor exotic, hairy monsters as their riding animals. Alien creatures not of this Earth, but wonderfully suited to frozen climes. They are not fragile like men or machines. As long as they have sufficient food, water and shelter, they can survive the hardest winters, and most can adapt to any terrain Russia throws at them. As for food? Food comes in the way of the defeated enemy. Aye, the Warlords and their men feed their riding beasts their fallen enemies ... when such enemies are edible, of course. The beasts are just better suited to the freezing temperatures than the machines which struggle against the cold and ice of

Russian winters, and freeze, jam and break. Likewise, big, heavy machines sink or become buried in the deep snows. The cyborgs too, sometimes, malfunction in the cold or become stiff and sluggish when caked in layers of ice or battered by the icy, north winds.

"Sadly, these Warlords are themselves savage, warring monsters and bring only violence rather than true peace. When not fighting the demons and monsters, they war against one another. Feuds, raids and vendettas are constant between these rival powers. There has been no era of peace among them, and they are always ready to add to their Spheres of Influence through the annexation of land won by violence, treachery or intimidation. "Each Warlord is an epic character with a mighty ego and a legacy of brutal conquest. Men, and occasionally women, who are both heroes and villains, saviors and tyrants. They claim to fight for the Russian people, but really seem to collect power, land and possessions only for themselves. Yet still there are those who serve and support them, and many others who embrace ... or at least, accept them as the lesser of two evils.

"The Russia of old is gone. Reduced to rubble by the Great Cataclysm or torn from the earth by the unholy creatures that came later. No trace of the once great city of Moscow is left ... vaporized. In its place is the *Moskva Supercrater*, kilometer after kilometer of earth blasted into hard, smooth stone. But just west is New Moscow and the heart of the sovereign nation known as the *New Soviet*, or *Sovietski*. These people are a stoic but decent folk who have revived ancient Communism as their government. The State takes care of its Comrades. Theoretically, everyone who is a full citizen is equal to everyone else ... but ... of course, there are always a few who prefer to be a bit more equal than others.

"Here one finds at least the skeletal foundation of true civilization. There is law and order, and a sense of community. The Sovietski is composed of a dozen small to medium-sized cities with farms and villages clustered around them. These cities do not have the fortifications of the Great Chi-Town and other modern marvels of the Americas, although there is the occasional fortified (M.D.C.) bunker and hidden, underground military installation.

"The Sovietski is poor and technology levels are mostly equal to the early to mid-20th Century. However, they do engage in some trade with the NGR and Poland, as well as the barbarian Warlords, so there is some percentage of modern weapons and high-tech vehicles and equipment. For example, the *Stalin Hospital* is easily as good as any in Germany, although most others are several steps below it. Likewise, the Sovietski's cybernetic factories and tech-level are equal to anything the Warlords possess and play a huge role in the Sovietski Military. As a matter of fact, the Sovietski grew from a faction of the Soviet military that survived the Great Cataclysm and endured the Eighty Years of Winter. An old, but well maintained and expanded underground military complex is the root of the Sovietski Government, and lies hidden beneath the streets of New Moscow. The old U.S.S.R. military installation was state of the art when the world fell into chaos. It was the survival of this facility, and the dedication of its soldiers, that helped to provide both the means and infrastructure for the people of this region to survive, and later rebuild the Soviet nation. The Sovietski maintained its sovereignty through the use of its two

greatest military resources: bionic reconstructions and the Thunderstorm cannons. The powerful cannons have kept the monsters at bay for over two hundred years and given even the most ambitious Warlord reason for pause. Thus, New Moscow and the Sovietski continues to grow as a free, sovereign nation, and has won the respect of the Warlords. As a matter of fact, most (not all) of the Warlords have nonaggression pacts with the Sovietski and frequently trade goods and services.

"Oh, but the Sovietski and the domains of the Warlords are but island refuges in a savage and monster-filled land. Just as Europe and the NGR have problems with Gargoyles and Brodkil, Mother Russia is plagued by them as well. Gargoyles and Brodkil spill in from Poland, Romania and the surrounding regions. The southern mountain ranges and Ural Mountains in the west — also plagued by Gargoyles and demons — serve as a natural barrier that help holds at bay the ghosts and demon-spawn from the west and south, but still the monsters and ghosts leach into the land. Old houses, cemeteries, churches and public buildings are often haunted — the lucky ones by the friendly *Knock Spirit*, the unlucky ones by angry *Domovoy*, haunting entities, or worse. *Russian Ghouls* — fierce creatures possessing supernatural strength and a searing hatred of humanity — stalk the roadways and lay in wait under bridges, tall trees, and along mountain passes. Witches, werewolves, demons and ancient gods also haunt our lands. Many of the lesser monsters are summoned by witches and evil gypsies. The ghostly beings have given birth to a new breed of adventurer, the *Ectohunter*, as well as the *gypsy*, both of whom make a living warning others about supernatural dangers, evil spirits, and destroying ghosts and demons for money. They are sometimes joined by the oriental *Demon Hunter*, psychics and others who claim to have some knowledge and power to fight the supernatural. It's dangerous but plentiful work, for the so-called ghosts of Eastern and Western Russia have been far more aggressive than other spirits and entities encountered elsewhere in the world — with the possible exception of China.

"The southern lands east of the Ural Mountains are among the most dangerous, and filled with all manner of other-dimensional visitors and slaving monsters. It is here in the west and southwestern Russia that our people fight the bloodiest battles but make the greatest progress in reclaiming Mother Russia. This is the domain of the Warlords.

"Beyond the Ural Mountains is the *Kirghiz Steppe* and the vast tundra of *Siberia*. Here too, the Warlords make their presence known, but even they make no claims to these forbidding lands. I am told that great teeth of stone rise up from the ground to bar a man's travel and that portals to other worlds open without warning to swallow up unwary adventurers. Great herds of otherworldly creatures, mutants, and demons roam wild and free. Brave and foolish D-Bee and human settlers venture into this unforgiving wilderness to settle the land and build new lives, but they are the minority.

"To the southeast lays Mongolia and China, both terrible places infested with all manner of beasts and demons not of our world. Beyond this, I know not."

Vladimir Kroslavsky — circa 103 P.A.

Rifts Russia

Russian History

The years 2027 to 2078 A.D. saw a new and improved Soviet Union (generally referred to as the "Russian Empire" by post-Cataclysmic people). The old Communist system had been revived and given a shot in the arm through the control and guidance of a succession of capable "Comrade Directors." Free elections, or at least the illusion of free elections, were held from Odessa on the Black Sea to frozen Leningrad, from Minsk to Chermkhovo in the Himalayas. The massive upper Eurasian continent was divided into twenty *Sovnarkhozy*, "Economic Councils," reminiscent of Nikita Khrushchev's Five Year Plans of the 1950's. The Councils were controlled from the "Nachalstvo" (Authority) in Moscow, and worked well by allowing the Economic Councils a sort of lax rule over their local citizenry. This enabled Moscow to loosen its hold over the scattered and diverse people of the reborn Soviet Union without sacrificing strong leadership and control, but with the appearance of greater social consciousness and freedom.

By 2055 A.D. the economy was equal to the boom of late-20th Century America. Russia became a true economic player in worldwide trade for the first time since the days of the Czars. Two of its greatest resources were the discovery of a rich oil field under the *Taymyr Peninsula* and the decision to focus development and manufacturing into the area of *bionics*. Russia was seen as a "Johnny-Come-Lately" who had missed the cybernetic technologies explosion of the period from 2015-2050. Germany, Japan, Canada and the United States had pretty much captured the market on bionics and advanced cybernetic systems. While the market still showed promise, its growth had slowed to a crawl. Unfettered by the concerns of outsiders, the Soviet Union decided to take a different approach to the cybernetics market. They knew they could not compete with the state of the art cybernetics of their competitors, so they turned their focus on heavy, basic systems for industrial and military applications at shockingly low prices. Within a decade, the Soviet Union was number three in the cybernetics market, behind Germany and the United States (Japan was equal to Germany/Triax in level of technology and cutting edge advancements, but just didn't have as large a presence in the global market). The Soviets still had their problems, and civil unrest existed in many of their Western holdings, but overall, the new Soviet nation was enjoying an era of economic growth and relative peace.

Post Cataclysm History

Eurasia was toppled by the Great Cataclysm. Even though the catalyst for the Cataclysm would be sparked in South America, Russia would suffer greatly. The storms of Armageddon raged and cities fell, blown away like autumn leaves. The sound of the warning sirens were quickly silenced and replaced by the wailing of mourners over their dead and the death rattle of the sick and dying. Survivors often existed at the whim and mercy

of diabolical creatures that seemed to come from the very pits of hell. Horrible demons, ghosts, and evil spirits swarmed over the shattered ruins of Russian civilization like a pestilence. Even ancient gods were said to have returned to reap their terrible vengeance upon Russian soil. Those who could, fled to the east, north or south, though few would find safe refuge. The entire world was in turmoil as cosmic forces reshaped the face of the planet into something new and alien. With rare exceptions, there was no place to go to find peace. No place to hide. Millions perished. An estimated 68% of the total population of Russia and the Ukraine was lost in the initial Cataclysm. Then came the Eighty Years of Winter, claiming an additional 16% of the population (more like 20% in the Ukraine, Belarus and Lithuania).

The face of the Russian land has changed as well. Mysterious events in the southwest created the *Boiling Sea*, and ground split and mountains rose from the rubble of *Leningrad/St. Petersburg* to the *White Sea*, forming *St. Peter's Spine*, a volcanic chain of mountains separating the Kola Peninsula and Scandinavia from the Russian Continent. Shards of stone, almost like the granite teeth or claws of some great monster, rising eight to eighteen feet (2.4 to 5.5 m) into the air, randomly appeared out of the ground. These *Devil's Claws*, as they are called, are particularly numerous in the southern portion of the *Central Siberian Plateau*, and said to be a warning to all god-fearing people not to travel any farther southward. Nobody is certain what happened to Moscow. A massive crater approximately ninety miles (145 km) in diameter and four hundred feet (122 m) deep, sits in its place. Meanwhile, Ley lines glow with their eerie, blue light to mark the path of magic and the junctions of dimensional gateways across Russia.

Much like the Americas and the majority of the world (the NGR and Poland are anomalies), civilization collapsed when the great cities and powerful governments were erased from the Earth. Modern technology and knowledge was lost to chaos. Most humans reverted to small clans of friends and family and were forced to live off the land. A pall hung over the continent.

The Eighty Years of Winter

For nearly a century after the Great Cataclysm, Russia remained a frozen, snow covered, no-man's land. The trigger that caused the eruption of the ley lines occurred around Christmas time, and winters are always harsh in Russia. When the first spring of the new ice age came, the snow continued to fall. Summer never came and autumn brought more snow. Many of the animals were among the first to flee or perish, so hunting was poor, and livestock were the first casualties of the winter blight. Without the ability to grow crops, and with no respite from the cold, people could not survive. Those who chose to wait for the return of the seasons either eventually fled or perished by the third year. Millions died before they realized that

winter would not end any time soon. Millions more perished en route to more hospitable climes in the south or west. Those who made it to Mongolia found unseasonably cold and harsh weather there too, although not as bad as Russia. Those who pressed on to China or Afghanistan would fall prey to hardships of travel or the clutches of monsters, for demons and supernatural horrors were already invading these lands. Half never made it out of Russia.

Nobody has ever been able to determine the cause for the decades of winters. Some blamed it on "nuclear winter," and the many craters and spent nuclear missile silos at Soviet Military bases would seem to support that theory. Others blamed it on magic, demons or strange dimensional energies. There are a number of theories, but nobody honestly knows.

For eighty years the snow fell and stayed. There was no change of seasons, only ice and snow. Only a handful of people managed to survive.

Finally, one day, the snow stopped falling and the natural cycle of seasons returned.

It would take another 20 years for Russia to completely thaw out and for people to begin to return in large numbers. Unfortunately, supernatural beings would arrive first and be waiting to greet the returning Russians.

Technology

As noted elsewhere, technology is limited and a strange mix of very high-tech, like bionics and energy weapons, and very low-tech, like drawing water from a well, plowing a field by hand, and riding a horse or bicycle as a mode of transportation. Most farms and villages, especially those in the steppe and east of the Ural Mountains, do not have indoor plumbing, electricity, gas heat or most of the modern conveniences we take for granted. They use oil lamps, fireplaces, pump wells (that's kinda high-tech for them) and outhouses (or a pot). They live, work and die by the sweat of their brow, but enjoy life.

Only the **Sovietski**, Kiev and a handful of other large cities and villages will have modern conveniences, high-technology and M.D.C. fortifications. Likewise, it is the Warlords and their troops who possess and control bionics and advanced weaponry, vehicles, and high-technology. It's an important part of their power base.

Magic

Magic will be covered in detail in, you guessed it, **Rifts® Mystic Russia**. It should be mentioned that ley lines tend to be found in clusters, with hundreds of miles between them (sometimes more). The most common types of magic users are *Ley Line Walkers*, *Mystics* and several practitioners of magic exclusive to the Russian region, such as the *Mystic Kuznya* (Mystic Smith), among others. Also among the most common, and most feared, are the *Shifter*, *Necromancer* and *Witch*. There are also mystical gypsies and others.

It is important to note that the *Techno-Wizard* is largely a North American phenomenon, and *are extremely rare in Russia*.

Russian Hospitality

Most Russians, human and D-Bee, are simple folk. Many are illiterate and superstitious, but most are brave, resourceful and generous with what little they have. They are quiet and often

gloomy, fate-haunted individuals who see life as a struggle with little reward other than that offered by good friends and good family. Of course, Russian people will vary in their outlook towards life and there are cheerful, optimistic Russians everywhere. They're just generally pragmatic.

Their reaction to adventurers (i.e. player characters) will depend heavily on how the characters conduct themselves and whether or not they bring cheer, prosperity or trouble to their community. The overwhelming majority just want to keep what little they have and get along, so adventurers who don't threaten or disrupt their lifestyle, or bring trouble with them, are treated well. Basically, one tends to get back what he gives, so if the characters are friendly, courteous and respectful, they are treated warmly, perhaps even like a long lost cousin (Russians and Poles can be extremely generous and gregarious). If the visitors are rude, bossy and condescending, then the Russians will treat them with cool indifference. This means the rude visitors will find themselves waiting long periods for everything, being ignored, getting the worst service and accommodations, and treated rudely in return. Unless there is a powerful village protector, militia, or lord of the village, they rarely resort to physical violence — it's not worth the trouble and inevitable damage. However, there is no mistaking their disdain and disapproval (hey, if that looks like spit in the porridge, you can bet that it is). They are slow to befriend a person, but their friendship actually *means* something. On the other hand, visiting Huntsmen, Mystic Kuznya and heroes might not be so pragmatic and tolerant, and may step in to teach these rude misanthropes a lesson, especially if they are foreigners.

Likewise, those who break the local laws, make fun of their customs and superstitions, or break with tradition will usually find a chilly response awaiting them from common folk. Still all and all, hospitality is extended whenever possible. Russians of all regional nationalities enjoy entertaining and making new friends and courteous and respectful visitors will find themselves being catered to by doting hosts. Dinners, picnics, dancing, singing, as well as **roughhousing**, are common social events. Actually, eating and drinking are social events too, and one learns to EAT in western Russia. Meals are large and portions generous. Russians (and Poles) can break into raucous song, dance, roughhousing (wrestling, brawling, etc.) and drinking at a moment's notice when the situation warrants it (like good company, good news, etc.).

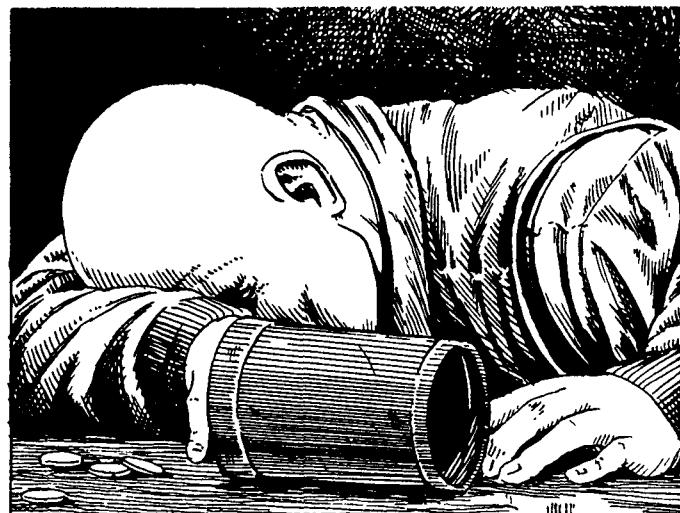

The New Russian Frontier

Western Russia (the focus of this book) alone covers well over 1.5 million square miles! Then there is the tundra region which is roughly another 1.5 million and the Steppe is close to an additional one million. That's a lot of land area.

Before the Coming of the Rifts, it was home to the New Soviet Nation, the government that took the place of the old U.S.S.R./Soviet Union a generation or two before the Great Cataclysm.

A lot of deforestation had occurred before the Great Cataclysm due to lumber mills, mining, and *kolkhoz* (vast collective farms), but over the ensuing 300 years after the Coming of the Rifts, the land has become completely regrown with lush forests, open plains, marshes and pastoral woodlands. Humans still cling to areas of it, but they must wage a constant struggle against inhuman creatures and supernatural forces that also lay claim to the land, and often the people on it. Almost laughably, Western Russia is the most densely populated by humans, with approximately 32.7 million humans scattered throughout the expansive region, compared to nearly a billion before the Great Cataclysm. Another 13.2 million people of Russian descent are believed to have made new lives in Poland, Czechoslovakia, Hungary and Romania — 3.6 million are found in the New German Republic. A mere 3-4 million Russian people are believed to inhabit the western three-quarters of the old Soviet Union, primarily Siberia, although those numbers are impossible to confirm and could be greater or lower by 40% or 50%.

The Ukraine is considered part of the new Russian Frontier, mainly because the Warlords have proclaimed it to be so. The Ukraine suffered the same devastation by the Great Cataclysm, and further hardships from the *Eighty Years of Winter* and the subsequent invasion by demons and monsters.

The bottom line is that even the comparatively heavily populated western quarter of Rifts Russia is predominantly forest and wilderness.

Roads & Travel

Most roads, as we modern people think of them, are non-existent. All that's out there are dirt and gravel roads, cart paths, foot paths and animal trails that cut a thin swath throughout parts of the wilderness. They are the foot-worn paths most commonly travelled by the local villagers or War Camps from one place to another. Roads of any kind are most common in and around villages, towns, cities and farms. Most are packed earth connecting one village to the next, or to someplace important, like a well, stream, favorite fishing spot, etc. Only the biggest cities have "paved" roads, but even the Sovietski only has about 40% of its roads paved or made of cobblestone or brick; most other cities have half as many. In fact, the majority of so-called Russian "roads" are little more than foot-worn dirt trails.

Locals sometimes mark stones or erect totem pole-like carvings made of wood to identify a road, nearby village or particular direction. However, in the winter, such markers may get buried or covered in snow, making them impossible to see.

Travelers must navigate by physical landmarks (large boulders, uniquely shaped trees, craters, rivers, streams, ley lines, etc.), the position of the sun, and common sense, or by instruments.

Some examples of common sense travel tips include: The wider and more worn the path, the more travelled it is and the closer one is to a community. Farmland usually indicates that a farmhouse and other farms are nearby (with 3-20 miles/4.8 to 32 km), and that a village is likely to be somewhere within a 20-50 mile (32 to 90 km) radius; usually along the path. Large groups of the Warlords' soldiers and knights also indicate a village or War Camp's base of operation is nearby — although large encampments (400 or more men) are seldom found on the roadside. Perhaps the most fundamental, common sense assumption about a trail, path or dirt road is that, sooner or later, it will usually lead to a farm, house or community of some kind.

Dangers on the Road

The great wilderness that is the Russian Frontier is as dangerous as any on Rifts Earth, and most would say more so. It is more dangerous than the American West, and is haunted by ghosts, inhabited by D-Bee nomads, gypsies, huntsmen and bandits, as well as plagued by demons and monsters. Remember that while the War Camps and Knights of the Realm "patrol" their Spheres of Influence and *zyto* rid the land of monsters, the forested wilderness (including the Ukraine and the northern forests) is about one and a half times the size of the United States, and that does not include the lowland steppe, arctic forests, and frozen tundra which are roughly comparable in size. We're talking about a truly immense area of land, roughly four times the size of the old American Empire!

Most of the pre-Rifts villages and cities have crumbled to nothing, and have been swallowed by the forces of nature or alien life forms. The land has reverted to a virgin wilderness, cut by the occasional, newly established house, hut, farm, village, or tribe. These places of human habitation are what the Warlords strive to protect, and consequently, the areas where groups of knights and War Camp factions are most likely to be encountered. Beyond that, in the genuinely desolate wilderness, most notably the northern forests, the Siberian tundra and the steppe, travelers are more likely to encounter the inhuman and the demonic than their fellow man. Even within the Warlords' Spheres of Influence, villages will be cut off by the deep snows and storms during the winter and may fall under siege by monstrous forces. Even cyborgs and patrols on hovercycles must make their way slowly through the vast woodlands, especially if they are on the lookout for trouble — it's easy for monsters, demons and bandits to hide in the woods. Thus, the circuit of the War Camp factions are much more than simply travelling from one village to the next, many will spend weeks at a time wandering the wilderness.

Deep Forests

The abode of supernatural evil

The dense, lush forests of the Ukraine and western and northern Russia have always been dangerous places. These vast tracts of wilderness have few roads or trails, and even during daylight hours, those unfamiliar with the wilderness are likely to get lost. At night, the forests take on a sinister appearance and travelers can get lost easily, or worse, fall into a ravine, swamp, or bog.



They are also home to the grey wolf, tiger, bear, and other predators (including human ones like bandits, cultists, necromancers and witches).

Since the Coming of the Rifts, the ancient woodland spirits and monsters like the shaggy, size-changing *Leshu*, the mischievous *Domovoy*, the mournful seductresses known as the *Rusalka*, *Vikhor*, *vampires*, *shapechangers*, *faeries*, *ghosts*, *gods* and *dragons*, have returned, along with a host of new creatures, demons, witches, D-Bees and alien beasts (most of which are described in **Rifts® Mystic Russia™**). Few common folk will enter the forests at night, and most avoid travelling too deep into the forest even during the day.

Many are the tales of ghosts, woodland spirits, monsters, demons and unearthly dangers as told by cowherders who take their animals to graze in woodland glens, and woodsmen, lumberjacks, Huntsmen, Reavers, War-Knights, Ecto-Hunters, Demon Slayers and travelers who lingered there till dusk. All people who travel too deep into the woods, where deep shadows cover the ground and the thick trees shield the darkness under their branches, even during the day. For it is in the shadows and the darkness that the monsters hide during the day and venture from during the night.

One of the contributing dangers is the very size of the forests. Most are vast, and seamlessly meld from one into another, so it is impossible to travel through them to a safe community before nightfall. Note: Villages and War Camps where the light of many fires and the love of God burns bright, keep the majority of monsters and malignant spirits away. Or seems to, at least most of the time.

For some reason, **trails and roads** also offer some measure of safety. During the day, they are seldom traveled by supernatural beings, although animal and humanoid predators remain a potential problem. Bandits and Warlord Reavers are especially keen at targeting crossroads because of the greater amount of traffic that passes through the junctions. Ironically, supernatural predators are usually lone hunters who avoid crossroads because of the increased traffic (too many people), preferring to strike at lone travelers and small groups away from others.

To avoid supernatural dangers at night, one should never leave the road or trail. Following a path, no matter how faint and overgrown it may be, will keep the traveler headed in the right direction — to leave the trail, especially at night, is to risk getting lost and flirts with danger of all kinds.

For reasons not entirely clear, most supernatural creatures tend to avoid roads and trails. Perhaps it is because such paths are more heavily travelled by other humanoids, including knights, adventurers, sorcerers and members of War Camps; all mortals who share a hatred for the demonic, and who are likely to come to the aid of their own kind. Or perhaps it is because the monster(s) must step into the open to attack or cause trouble. Supernatural menaces encountered along the roadside frequently stay toward its edge, and often try to lure their prey off the road and into the sheltering woods.

The noticeable light and smoke of **campfires** along the roadside (often in the middle of the road), are usually ignored by supernatural beings, especially if there are more than one. Again, the reasoning seems to be that a light will reveal their monstrous nature and show their presence before they can strike, which

gives their human prey a chance to prepare themselves and fight back. Furthermore, a **campfire** typically represents a group of **humanoids** clustered together for safety. Groups are more dangerous than an individual or trail of people, plus the light serves as a beacon for other humanoids, attracting them like moths.

Unfortunately, staying on or at the edge of the road is no guarantee of safety. Supernatural beings, especially demons, are monstrous predators who prey on humans and other mortal beings (i.e. D-Bees) for food and pleasure. Like most predatory animals, they tend to prefer easy prey, and often "hunt" as lone individuals or in small groups of 2-5, but some supernatural beings are not wary of **campfires** on the road, or are so mean or bloodthirsty that they don't care if their mortal opponents outnumber them or reek of power. Travelling along a road at night, even by torchlight or the glow of headlights, is extremely dangerous. The sounds of travel, the click-clack of a horse's hooves, the rumble of a wagon, the purr of an engine, the rustle of a backpack or cape, voices, and even the soft crunch of the earth underfoot, all alert supernatural beings and other monsters to the presence of humanoids. Travelers so brazen as to not fear the darkness and dare to travel in it, are attractive targets for the supernatural. Those who fool themselves into believing their movements will be obscured by nightfall **and/or** travelling at great speed will protect them, are misguided or arrogant fools.

Individual supernatural creatures tend to focus on one target, typically the last traveler in the group, or the smallest or seemingly most vulnerable. Demons, as both individual hunters and those gathered into a group, often set ambushes and traps, topple trees, damage bridges, or cause rock or snow slides that block the road, stop or slow travel, may require a detour (into the woods?), **and/or** divide a group of travelers to make them easier targets. Divide and conquer is a favorite tactic. Another is the ambush and using the element of surprise. Leaping out of the darkness or a hiding place from two or more sides, as well as hit and run tactics to wear down and slowly diminish one's opponents, is common practice. Many also enjoy cat and mouse games where they terrorize and hurt their prey, but don't necessarily kill them (let them go for fun some other day, **and/or** so the people can spread the word about their harrowing experience and frighten others. Some creatures may only kill one or two and let the others go, etc.). Other playful attacks by the supernatural may also involve robbery, destruction of property, the slaughter of livestock and hide-and-seek (the demon steals something or somebody, and the rest must come and find **it/them**). Such games and fright tactics are most common among demons, ghosts and other supernatural beings who claim a particular region as their own. Thus, any who pass through "their domain" are subject to torment, terrible frights, torture **and/or** attack. These territorial creatures rarely engage in kidnapping because it brings angry search parties and retribution, unless it is the demons' plan to frustrate, mock and anger more people **and/or** to lure them out for slaughter and more fun and games. Such maniacal torments and treachery are typically reserved by the intelligent greater demons, vampires, witches and evil practitioners of magic, although lesser minions may be involved.

Supernatural creatures, especially those who gather in groups or hold a vendetta, will strike at those they desire along roads and even raid villages and enter **cities**, for the wrath and lust of demonkind knows no fear or boundary. Likewise, *groups* of su-

pernatural beings tend to be bolder and more likely to attack roadside camps, large groups, warriors and villages.

The danger of Ley Lines

To people who don't know better, the light and wonder of the ley lines may seem alluring, but in Russia and the lands that border it, they represent the light of magic, nightmares and monsters. Entities, ghosts, and demons are attracted by the shimmering blue light, as are the necromancer, witch and other practitioners of dark magic and worshippers of evil. Ghosts, demons and monsters frequently meet and congregate at the ley lines, where they are said to be most numerous between the hours of midnight and one in the morning. However, some start to awaken and move on the prowl with the setting of the sun.

These creatures of the night gather at the lines of energy to plot their evil work, to draw on the energy provided by the blue light, to trade goods and information, or just for the company of their own kind. Wary travelers, careful to be quiet and not get too close, are likely to chance upon a group of hellish creatures laughing, squabbling, brawling, drinking (alcohol, human blood, or foul elixirs), trading goods (from human heads and bones to weapons, gems and magic), swapping stories, exchanging information, or engaging in torture **and/or** other depravity. Meanwhile, others simply hover about with seemingly dispassionate eyes and distant thoughts. These gatherings and meetings can involve as few as two to as many as fifty, although the range is typically 2-8. To find a gathering of evil that numbers more than fifty means the forces of darkness are plotting something most foul. With Brodakil, Gargoyles or other demon hordes, it can only mean an impending raid or bloody war (acts of wanton murder and destruction) will soon be launched.

Travel through the Forests

The forests are so dense and the landscape so rugged, that most motorcycles, hoverbikes and cyborgs must travel at half their best speed, and often slower. Rain, fog, mist and snow can force travelers to reduce their speed to a crawl, and in some cases, make any type of travel impossible. If one can not see where he is going, there is a constant danger of tripping over rocks and branches, banging into trees, falling into holes or ravines, sloshing through swamps, and stumbling blindly into dangerous animals, monsters and spirits. On top of that, such incidents make noise and attract the very creatures one hopes to avoid. Night travel is pitch black, except for the light of the stars and the moon. This alone necessitates traveling at speeds 50-60% below maximum. Add rugged terrain, dense trees, shrubs, fog, and other obstacles, and a practical speed means traveling at 75-80% below normal. This is true even of those travelling on foot. Running through a dense, unfamiliar forest is likely to mean any one or more of the following; roll for *each* bold category:

01-70% likelihood of getting lost.

01-60% likelihood of creating a noticeable disturbance (noise, startled animals scurrying away, birds taking to air, etc.) that will alert pursuers or make nearby creatures and travelers aware of one's presence and general location within 500 yards/meters.

01-50% chance of tripping and falling; no damage other than a bump or scrapes, but the character loses two melee actions, may drop something and makes noise in the crashing fall.



01-40% chance of running headlong into a tree, rock, tangle of vines, animal trap, or hole, and fall and hurt oneself. Roll percentile dice to determine damage.

01-20 Banged head and is stunned for 1D4 melee rounds. Until head clears, the character has only two melee actions per round, no initiative, no combat bonuses, is -6 on all combat moves/actions, and can barely sit up straight, let alone walk; -90% to speed and skill performance. Other than a headache, functions at 80% once he recovers.

21-40 Banged head and is knocked out for 2D4 minutes! Helpless, but is at least quiet and might be difficult to locate by pursuers.

41-60 Banged and bruised even if wearing M.D.C. armor; takes 3D6 S.D.C./HitPoint damage.

61-80 Twisted, sprained or pulled an ankle or leg muscle even if wearing M.D.C. armor; pain prevents maximum speed and movement. The injured character must reduce speed by 1D6x10%, is -3 on initiative, -3 to dodge or roll, and loses one melee action. A splint, rest and medical treatment will reduce the healing time by half, otherwise it will take 1D4+3 weeks to heal. All penalties apply for the first half of the healing period and drop to half for the last half of healing.

81-00 Takes 3D6 S.D.C./Hit Point damage even if wearing M.D.C. armor (plus, if appropriate, 2D6 M.D.), and gets stuck in a tangle of vine, a pit, ravine, a bog, swamp, animal trap, flash flood, or under a rock or mud slide, fallen tree, etc., for at least 1D4+2 minutes and may need help to get free (G.M.'s discretion).

01-10% chance of running headlong into an animal or monster (double the chance at night); battle ensues as the startled creature reacts to protect itself.

Plus, the character will have little hope (01-05%) of retracing his path or recognizing landmarks if he should need to do so.

Geographic Overview

Since the old Russian civilization was quite literally obliterated, Russia has returned to its natural state. The steppe again stretches from the Ukraine to the Orient, and the once great cities and expansive farmlands are covered by forest. The old cities are gone. Even the ruins of many famous cities have been reduced to rubble, overgrown with vegetation to the degree that one can stand right on top of it and not know that anything was ever there other than wilderness. In other cases, like Moscow, there is only an empty crater to mark its passing, and places like Leningrad/St. Petersburg have been buried by volcanic lava and ash.

For all intents and purposes, one can think of all of Western Russia, from the borders of Poland, Czechoslovakia, Hungary, Romania and the Barents Sea to the Ural Mountains, as heavy, mixed forests, turning into mostly coniferous forests (pine, fir trees, etc.) in the northern half, and mixed light forests, broken by grassy plains, and pastoral lands in the southern half. The southernmost part turns into steppe/grasslands, and steppe turns into mountains and deserts.

Amidst this mostly forested wilderness, sprinkle in scattered, low-tech villages, farms, and the rare city, plus the occasional

tribe of nomads, gang of bandits and War Camp, and you have an excellent picture of Western Russia. Oh, and this is the populated third of the country! East of the Ural Mountains is the Siberian wilderness with a population density of roughly one human per hundred square miles (259 square km).



The Russian Desert of the Southwest

To the far south are the *Caucasus Mountains*, *Caspian Depression*, and *Ustyurt Plateau*, and the *Kara-Kum* and *Kyzyl-Kum Deserts* divided by the *Caspian Sea*. The majority of the land is unwooded, semi-arid to arid lands that are part of the traditional *steppe zone* that runs from the Ural River in the Ukraine to Manchuria.

Around the Caspian Sea, Caucasus Mountains and other southern Mountains, are a mixture of light woodlands, steppe prairies, scrubland, grass covered foothills and flower filled alpine meadows. However, beyond these mountain oases, is nothing but desert.

In the northern desert region, the ground is a mix of parched earth, clay, and stone, with dry grass, scrub, and a surprising variety of drought-resistant desert plants, including giant fennel (a cactus-like plant), sagebrush, wormwood, calligonum, and broomrape plants.

This gives way to the shifting desert sands of **Kara-Kum**. To the east and north of Kara-Kum are the dry, stony canyons, low bluffs and plateaus of the **Kyzyl-Kum Desert** and **Ustyurt Plateau** which are reminiscent of Nevada and Utah in North America, only with low plateaus, wide canyon ravines and lots of flatness. Further east is **Tau-Kum**, a great sand desert with drifting dunes and fierce heat. Here temperatures can rise to 122 degrees Fahrenheit (50 degrees Celsius) and the sand heats up to as much as 176 degrees (80 degrees Celsius).

Notable desert animals include the Central Asian Cobra, the Desert Monitor Lizard (grows to be 5 feet/1.5 m long), scorpions,

the Blunt-nosed Viper and the Saw-scaled Viper, one of the most poisonous and aggressive snakes in Russia (vipers are found in stony deserts and the steppe).

Western Mountain Regions

The Caucasus Mountains occupy a total area of 170,000 square miles (440,000 km) between the Black Sea and Caspian Sea and down into Turkey and Iran. It offers some of the most lush and vibrant alpine forests and meadows in Western Russia. The northern slopes are gentler than the south and more wooded, but the entire length of the mountains is rich in flora and fauna. Forests of beech, fir, pine and other trees cover the lower slopes, along with orchids, lilies and other flowering plants and shrubs, including thickets of rhododendron that cover entire slopes (and which makes them impassable). Above the tree line are subalpine meadows, lush belts of tall, green grasses, herb plants, vines, bushes and flowers, including the yellow Caucasus lily, orchids, and carpets of rosette, among others. Starting around 10,000 feet (3048 m) are snow covered peaks reaching as high as 18,500 feet (5,642 m); the Caucasus Mountains have more than 2000 glaciers. Note: Silver, copper, lead, zinc, iron, alloy metals (nickel, manganese, cobalt, chrome, vanadium) and uranium can be found in this region.

The Altai Mountains are very similar to the Caucasus, only they are a bit shorter with snow and ice beginning to cover peaks starting at around 9,800 feet (2987 m) and the highest peak reaching nearly 15,000 feet (4572 m) tall. Note: Silver, copper, zinc, phosphates and uranium can be found in this region.

The Ural, Sayan and Carpathian Mountains are, by comparison, much less dramatic in appearance. They are lower, with the highest peaks ranging around 6200 feet (1890 m). They are not as lush and the forests are thin. The lowlands around the base of these mountains are steppe grasslands. As one climbs upward, prairie and scrub gives way to a belt of thin alpine forest composed of coniferous trees, mainly fir, spruce, and a variety of pines, as well as juniper-like shrubs, honeysuckle bushes, vines, herb plants, grass and moss. Just above the tree line is moss covered rock and scraggly patches of grass followed by a belt of stone and rock broken by the occasional meadow of tall grass. The highest regions are just rock with patches of lichen and other tundra plants; snow covers these mountaintops only in the winter.

The Ural mountain chain stretches from beyond the Arctic Circle to the far southern Kirghiz Steppe, over 1400 miles (2,240 kilometers). Its northern regions to Sverdlovsk average 50-80 miles (80-128 kilometers) wide, and the southern areas to the steppe around twice that. This great region is home to mountain sheep, brown bears, goats and smaller creatures like ferrets, marmots, snowshoe hares, silver foxes and a number of different species of birds. **Note:** Oil deposits are found scattered along the foothills on the western side of the Ural Mountains. Iron is found almost throughout the region, with copper, bauxite, and gold scattered throughout as well. In the northern quarter, coal, gold and diamonds have been mined for centuries. East of the Ural Mountains, just below and in the *Yamal* and *Gydan Peninsulas*, are deposits of natural gas. In the upper half of the West Siberian Plains are scattered deposits of coal, oil and natural gas.

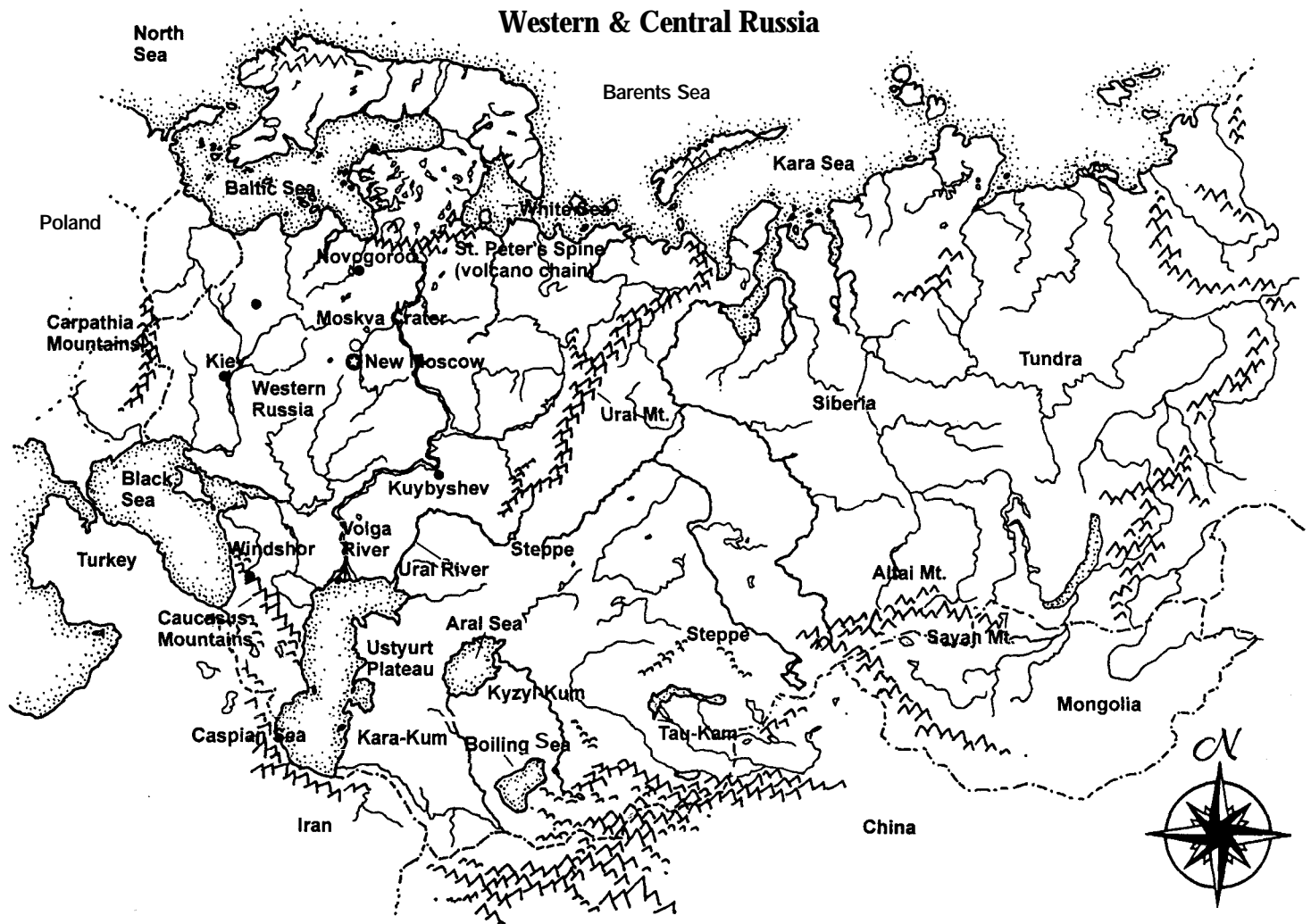

The Taiga — Northern Forests

Russia has always been famous for having the largest forests in the world. More than half of Russia is covered in lush forests.

In the northern half of Western Russia/Northern Europe, to just east of the Ural Mountains, the wood is excellent for lumber, including birch, oak, maple, elm, fir, spruce, larch and pine trees. This forest continues east from the vast forests and marshlands of northern Siberia to the Pacific Ocean — one long expanse of forest known as the "taiga." Here there are a dozen species of pines, including the Siberian Stone Pine (the Russians call it "the Cedar") as well as larch, spruce and fir trees. Growing on the ground along the northwestern rivers are carpets of *sphagnum moss*, which holds water like a sponge.

Herds of European Bison, Bukhara Deer/Red Deer, Saiga Antelope, Elk (moose), and Reindeer roam the northern woods of western and eastern Russia; mountain goats and sheep in the mountain regions. Foxes, grey wolves, timber wolves, brown and black bears, and east of the Ural Mountains, the Siberian Tiger, hunt for prey.

The northern tundra regions are covered under blankets of snow from mid-October to late-May and winter temperatures can range down into sub-zero (Fahrenheit) numbers for up to 60 days at a time in the dead of winter! The terrain is largely flat scrub, cut by areas of hills and the occasional grove or woodland area. The Tundra is said to be the harshest climate on Earth. The growing season is very short and driving snow-

storms, strong winds, bitter cold, ice and permafrost make this a hostile weather region.

In the Arctic regions and Siberian forests one can find Reindeer, Elk, Musk Oxen, wolves, the Arctic Fox, Siberian Tigers, Polar Bears, eagles, and along the sea coast, Steller Sea Lions, Walruses, Fur Seals, Auks, Puffins, and other seabirds can be found.

The White Sea

In some ways the White Sea is more like a glorified bay which empties into the much larger Barents Sea. Its depth averages around 500 feet (152 m). Major features are the Dvinskaya Guba (Dvinskaya Bay), the Onezhskaja Guba and the Kandalakshskiy Abyssal (sea floor) plain along the eastern coasts of former Lapland. The White Sea is fished from early May to late October, after which temperatures and ocean conditions make it impossible for all but the largest of trade ships to break through the thickening ice.

The Warm Barents Sea

The Barents Sea has really suffered since the Great Cataclysm. A large, volcanic, undersea mountain range warms the normally chilled waters of the Barents to sub-tropical temperatures. Experts claim this is impossible and that there must be another explanation. Magic, ley lines, and dimensional anomalies have all been attributed as causes possible.

The results of such a traumatic warming has proven chaotic to say the least. Cold-water fish either died immediately, or mi-

grated to cooler waters. The convection caused by the much colder waters of the Arctic Ocean and the northern Atlantic is incredible, manifesting itself as strong currents, whirlpools, sudden storms and increased iceberg activity.

Saint Peter's Spine

The new, northern Volcanic Chain

Sometime after the Great Cataclysm, a new range of volcanic mountains erupted at St. Petersburg (Leningrad), northeast to the White Sea. Again the exact cause is unknown and presumed to have something to do with magic, ley lines, and/or dimensional influences. Approximately 120 volcanos cover a 250 mile (400 km) strip of land, effectively barring easy access to the Kola Peninsula and Scandinavia. Of those 120 volcanoes, 16 are active, rumbling and spewing clouds of smoke, ash, and rock into the air and lava flowing down their slopes. This means the mountains are still forming and growing; average height is 8,000 feet (2438 m). During such minor eruptions, the skies blacken with ash for a 2D6 mile radius and gradually blown it away with the prevailing winds. This has played havoc with the eco-systems of Kola and Finland, and to a lesser degree, Sweden and the region west of the White Sea. Furthermore, the initial, explosive appearance of so many volcanoes is likely to have had something to do with the 80 Years of Winter and the harsh, unpredictable weather experienced throughout Europe for a century after the Great Cataclysm.

The first and largest of the volcanoes is said to have erupted in the heart of Saint Petersburg, with all the subsequent fissures and volcanoes appearing northeast to the White Sea in a fairly straight line. Thus the chain of new mountains was named after Saint Peter — St. Peter's Spine.

The region, as unstable and dangerous as it is, has become a haven for Gargoyles and their kin, as well as a variety of other winged and mountain creatures. An estimated 30,000 Gargoyles live in the mountains, with more in the Kola Peninsula. However, some Warlords and the New Soviet Government fear there may be ten times that number. Increased incidents involving gargoyles in that part of the country, as far south as the Sovietski, would seem to suggest this fear is legitimate.

Note: A massive ley line runs the entire length of the mountain chain, and two smaller lines intersect where St. Petersburg (Leningrad) once stood.

The Volga River

This mighty river has grown since the Great Cataclysm, flooding its banks and rising more than 20 feet (6 m) in some places. It begins in the Valdai Hills of the former Kalinin District and winds through western Russia for 2,300 miles (3,680 km) before emptying into the Caspian Sea. Its arteries connect the Caspian with the Sea of Asov far north to the White Sea, and several lakes and rivers along the way. It can be navigated all the way to about 100 miles (160 kilometers) north of the Caspian where it branches into scores of shallow river deltas. Only small, light river craft can travel the last stretch through the deltas into the Caspian Sea.

This has given rise for opportunity in river travel and trade on a fairly large scale, and many villages and farms are located not far from the river. This also means that the length of the river is (relatively) frequently patrolled by one War Camp or another.

There is something strange about the Volga. Along a two hundred mile (320 km) length, between the still standing city of **Volgograd** and the ruins of a city once known as **Saratov**, travelers report "lost time." Nothing bad or injurious happens to them, but time is distorted. In most cases, time is lost. That is to say, a trip that should have taken three hours takes six, usually without any obvious sensation. One of the strange aspects of this is that one minute, the sun may be hanging high in the afternoon sky, and what seems a short time later, it's dusk and the sun is setting. Travel may have occurred during this transition, but inevitably, 2D4 hours will have been lost (add them to the time it normally takes to get from point A to point B. Occasionally, people also report making excellent time and arriving someplace 1D4 hours impossibly early. However, this is a much less common phenomenon, most people lose time.

Arriving ships will often "flash in," a spectacular sight which can be viewed at any point along this section of the river. Suddenly there is an eerie flash of blue light which halos around the incoming vessel for 3D6 seconds, and the vessel is just *there*. This is especially strange considering there are no ley lines along the entire length of the Volga where this phenomenon occurs.

Player's Note: A group of travelers should roll on the following table to determine what happens whenever they traverse this part of the river.

01-60 Nothing out of the ordinary; normal travel time.

61-80 Loses 2D4 hours, the time of day just suddenly changes.

81-90 Loses 2D4+4 hours.

91-00 Gains 1D4 hours, time passes quickly.

Individuals experiencing this time displacement will feel that they've taken the normal amount of time to get to wherever they're going, but to the rest of the world it will appear differently as it coincides with the real time of day. Think of time for this example as a number of rivers, some larger, some smaller, some deeper and so on. These rivers flow at different rates of speed and encompass differing realities. It is possible the Volga is somehow "sharing" another reality, or more likely, several different ones. When caught on a fast river, travelers arrive sooner, when caught in one of the slow rivers, time is lost.

The Black Sea

The Black Sea forms the border of southern Ukraine and northern Turkey. It is bordered to the east by the Caucasus Mountains. In the southern quarter of the Ukraine (the western steppe) are rich deposits of iron, zinc, alloy metals (nickel, manganese, cobalt, chrome, vanadium), lignite, coal, natural gas, and uranium.

The Boiling Sea

Sometime during the dark ages after the Great Cataclysm, a new sea appeared in the southern portion of the Kyzyl-Kum desert, in Central Asia. The seawater has a reddish tint to it and actually froths and bubbles as it is boiling. Water temperature is over 300 degrees Fahrenheit, and no manner of beast can live in it. Like so many other strange phenomena in Russia, there is no rational explanation for its appearance or boiling waters.

Superstitious people avoid the place and suggest that the Boiling Sea is actually part of the River Styx bubbled up from hell. This is not likely to be the case, and ironically, there is good that comes from the Boiling Sea. A hundred hot springs

scattered around the sea have healing properties. Relaxing in the comfortably warm waters calms nerves, reduces anxiety, soothes arthritis pain, and bathing in a spring for 1-2 hours a day for three days increases normal healing by three fold (heals 3x faster than normal and with minimal scarring or discomfort) and completely takes away arthritic pain for 3D6 days at a time. Furthermore, water from the hot springs or Boiling Sea acts like holy water when used against vampires and similar undead.

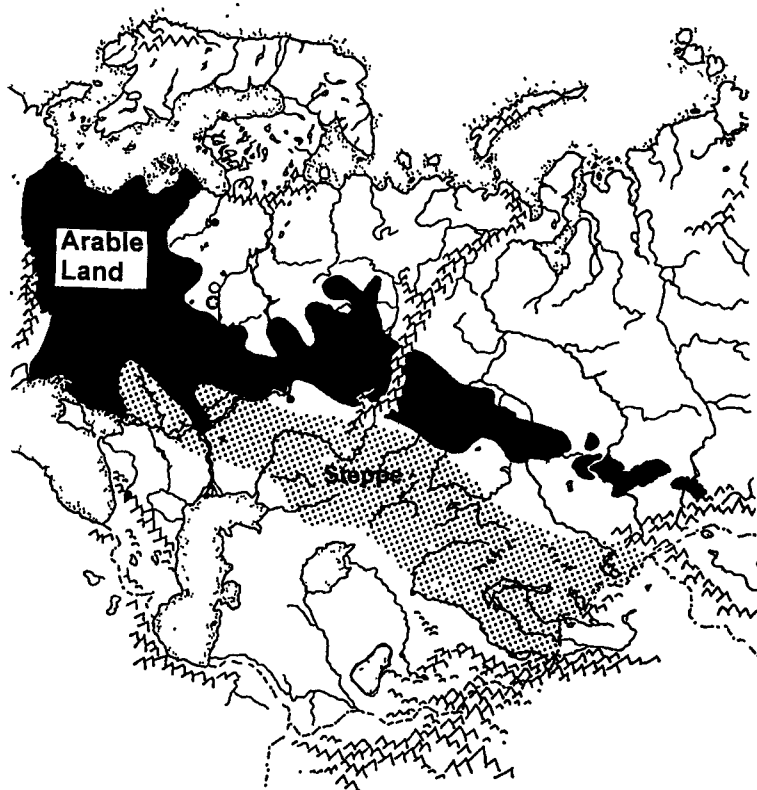

The Steppe

North of the deserts, broken by the southern quarter of the Ural Mountains, is the famous steppe, birthplace of the Cossacks. The traditional *steppe zone* covers one-sixth of the total land area of Russia. It is a grass-covered plain/prairie/savannah that gets little moisture — semi-arid grassland, but not all grasslands are steppe. Steppe vegetation is drought-resistant and close stands of grass that survive an annual rainfall of 12-20 inches (300-500 mm)

The damper, northern region of the steppe tends to be more lush (the wetter the weather, the taller the grass), with a greater variety of plants, herb plants, Koelera grass, meadows, scattered marsh areas and the occasional light forest, particularly near the Volga River and other waterways

The southern half tends to be much drier with the occasional tree or tiny patch of small trees, sagebrush, wormwood, and turf-forming grass, including feather grass and fescues. During the spring, crocuses, tulips, irises, hyacinth and an endless sea of green grass seem to appear like magic in answer to spring rains. By summer much of the green has turned to shades of gold and brown interspersed with green and flowering buds of many colors.

Among the notable animals of the Steppe are the Long-Legged Buzzard, the beautiful Demoiselle Crane, Orsini's Viper, European Whip Snake, a variety of poisonous Vipers, Saiga Antelope, Gotred Gazelle, Kulan (Asian Wild Ass who

runs at the first sign of trouble at an impressive speed of 40 mph/64 km), wild horses, Marbled Polecats (a small mammal in the weasel family), Marmots, Lemmings and hamsters (common to the steppe like prairie dogs in the American West) and many species of rodents, birds, grasshoppers, beetles, flies, and other insects. However, the most surprising animal to see are Cheetah. The Cheetah was successfully reintroduced to the Ustyurt Plateau in Kazakhstan and have thrived over the centuries since the Great Cataclysm. Cheetah (and the occasional tiger and bear) can be found throughout the steppe. Throughout history, the steppe has also been used as grazing lands for horses, cattle, sheep, goats and other livestock. The Cossacks of Riffs Earth are experienced horse and cattle raisers.

Of course a variety of alien life forms from beyond the Riffs have also settled in the woodlands, steppe, and deserts of Russia. The Megasteeds described elsewhere in this book are found throughout the steppe and forests of western and eastern Russia and up into the Siberian wilderness. Additional animals and D-Bees are found in the pages of Mystic Russia.

Other Lands

Deadzones

Scattered here and there, are places the Russians call Deadzones, because normal life forms don't grow there, only twisted and sickly mutations amidst low levels of deadly radiation. Deadzones are found only west of the Ural Mountains in Russia and Europe, and typically include sites of old nuclear reactors and military bases. Most are small areas only 1-4 miles (1.6 to 6.4 km) in diameter, with stunted and mishapened vegetation for about a half mile to a mile all around it (0.8 to 1.6 km). The mutated environment also serves as a warning sign to avoid the area. Most Western Russians know to avoid these places but children and outsiders may not be so fortunate. People who stay in the mutation zone to ground zero for more than 48 hours, or who visit for several hours every few days for months at a time, will suffer from skin rashes, nausea, and headaches. Pregnant women may suffer a miscarriage or the infant may be born with birth defects. People visiting more often or staying for more than five days will suffer from the above, plus open sores hair loss, and may get cancer and/or develop radiation sickness, which is fatal without proper magical or high-tech treatment.

The Moskva Crater

Where Moscow once stood, is the largest and most famous Deadzone. To this day, nothing grows inside the crater and for five miles (8 km) around it, the vegetation is deformed and living creatures suffer from a myriad number of diseases, birth defects and mutations. According to legend, the Crater is haunted by two million ghosts of the dead. Indeed, the place is a ghost and entity magnet, particularly for Haunting and Tectonic Entities. Ghouls, banshees, and a handful of other ghostly and demonic creatures are also reported in and around the crater.

The Former Ukraine

For many reasons — the fertile land, a more hospitable climate and terrain, a vast region of arable land, past conquests/ownership, etc. — the Warlords have claimed the Ukraine as part of "Mother Russia." This does not sit well with the native Ukrainians who are fiercely independent and patri-

otic. Unfortunately, the Ukraine has suffered terribly. First from the Great Cataclysm (destroying over 80% of their population, cities and modern resources), followed by the Eighty Years of Winter, and then by the invasion of supernatural demons and monsters who tormented and killed half of those survivors. In fact, it was a haven for demons, necromancers, witches and other human and D-Bee practitioners of Dark Magicks. It has only been in the last 60 years that The Russian Warlords have been able to rid the land of the most powerful and dangerous sorcerers and monsters, and restore some measure of freedom for all humans. However, the once-Ukraine remains one of the most embattled regions in Europe. Witches, necromancers, evil gypsies and countless demonic hordes still make their presence known in terrible and destructive ways. Furthermore, there are other lesser kings and kingdoms who challenge the Warlords' power and engage in bloody wars. Many in the NGR question whether even the insanely wild and devoted Russian Warlords and their knights can keep Russian-claimed Ukraine free from demonic or evil domination.

Sadly, there are so few surviving Ukrainians that it is impossible for them to reclaim their native country. Thus, most look at the Russian Warlords with a certain amount of pragmatism — it could be worse (it has been for hundreds of years). At least these conquerors are human, and allow them to pursue some level of self-expression and independence. Furthermore, because of the rich farmlands and resources of the Ukraine, most Ukrainians enjoy greater prosperity and freedom than most Russians, especially when compared to those in the northeast and the steppe.

Still there is a certain feeling of animosity between the Ukrainians and the Russians. They regard the Russian people as invaders, and resent the fact that the Ukraine has again lost its identity to be swallowed up as "part of Russia." Consequently, most Ukrainians tend not to trust Russians, dislike the Warlords (even though they know their lives would be worse without them) and gather in small communities and ghettos composed primarily of their own ethnic group. Many even talk about some day in the distant future when the Ukraine will be free again. Since most Ukrainians will not accept Russians as their masters and refuse to call themselves "Russians," the Warlords consider them "foreigners." Officially, this means they have no rights of citizenship in their own land, cannot own land, and cannot join the Warlords' Camps except as Reavers. However, while expected to follow the Warlords' laws and show them respect, most Warlords do not mistreat or abuse these people; for the most part, they are treated as Russians whether they like it or not! Of course, some don't like it one bit, despite their prosperity under Russian rule. Many of these dissidents associate with or are directly linked to gypsies, the Black Market/Mafia, forbidden magicks, spirits, and underworld activities. Such individuals are usually dealt with harshly and mercilessly by the Warlords.

Dnieper River: The northern reaches of this large river still wind from north of Smolensk in the Valdai Hills, south to Kiev. South of there it falls into a dozen different, eroded river valleys in the Ukrainian Basin. It is only navigable for about 350 miles (560 km) nowadays, from south of Smolensk to about 20 miles (32 km) north of Kiev.

Besarabia, Moldavia, Carpathian Mountain Region: Carpathia along the southeastern-most border of the Ukraine,

has become the home of some one million Brodki and thousands of other demons (little does the NGR know).

Poland

Poland is effectively an unstable, third world country itself, with a long history of conflict with Russia. Consequently, Poles tend to view that country as both a threat and a resource. The Warlords of Russia are a threat because they might, one day, try to invade and conquer Poland — Reavers already raid villages and farms along the border, although they haven't shown themselves to be bloodthirsty, usually killing only those who leave them no recourse (i.e. those protecting their property to the death). Otherwise, the Reavers and raiders usually only take what they need and leave. The Warlords also present a danger in that they provoke the monster races throughout the region, and many of the creatures that flee from the War Camps' assaults make their way to Poland and surrounding regions where they become a problem for the local people.

Ah, but as a resource, Russia has represented a boon to the Polish people, especially the industrialists of Poland. Everybody in Russia needs goods and services the Poles can provide. Everything from grain, processed food, Vodka, clothing and tools to electronics, computers, M.D.C. building materials, parts, vehicles of all kinds, body armor, weapons, E-Clips, and much, much more. Since there is no love lost between the Poles and the Russian people, the Polish manufacturers, industrialists, weapons dealers and merchants generally sell anything, including items forbidden by the Warlords and NGR. And they'll sell to just about anybody who can afford them: Mercs, the Black Market, bandits, smugglers, individuals, businesses, and D-Bees. However, they won't sell arms and other goods to supernatural beings or practitioners of the black arts. This has helped the Polish economy immensely, but has angered the Warlords and displeases the NGR.

Polish men and women also come to Russia looking to serve as Reavers or to explore, prospect for gold, silver and diamonds, or to make a name for themselves as mercenaries, heroes and adventurers. Polish arms dealers, smugglers, mercenaries and adventurers can be encountered throughout the country.

New German Republic (NGR)

The NGR doesn't like or recognize the Warlords of Russia as anything more than savage barbarians and a potential menace. The only Russian nation they acknowledge is the *Sovietski*. In fact, they have a limited trade agreement with the Sovietski, but consider the entire region to be a volatile hotbed of conflict. The jury is out as to whether the Russian people can stem the tide of supernatural monstrosities that plague their land, just as it is uncertain that the Warlords will ever rise out of barbarism to building any kind of stable government. They see the current rivalry between the Warlords increasing, and anticipate that at some point they will turn their aggression against their inhuman enemies towards each other, bringing wars that will spill the blood of tens of thousands. Furthermore, the Warlords as a group, have refused the NGR's offer to mediate peace and establish a joint government ruled by a Counsel of Warlords. Their vehement opposition to this idea, and apparent desire on the part of several to eventually be the supreme ruler of Russia, shattered any hope for an amicable relationship with the NGR. To make any agreement with only one or two of the Warlords would only

escalate the rivalry and impending wars, so the NGR has quietly backed away and severed all ties with all the Warlords.

In addition, the NGR has decreed the sale of state of the art technology, weapons, vehicles, bionics, electronic components, and M.D.C. materials to Russia, to be illegal. The NGR has tried to put a stop to the sale and trade of such goods to the Warlords by enforcing trade sanctions to that region. To engage in illegal trade is a serious crime and an individual can lose his business and face years of imprisonment. However, this has not stopped various criminal organizations, the Black Market or daring individuals from doing otherwise.

The worst offenders are the Poles who pay lip service to the strong "requests" of their German allies, but then do as they please. As noted previously, the Poles have established strong trade with virtually all of the Warlords, as well as limited trade with the Sovietski, and sell all types of weapons and contraband (Triax products) the NGR has designated as off-limits to the Warlords. This open trade and blatant noncompliance of the German embargo has infuriated most segments of the NGR government, and strains their relationship with various Polish kingdoms. One of the problems is that like Russia, there is no one ruler or government of Poland, but scores of small kingdoms and city-states. This makes it impossible to regulate every individual kingdom without using military force; something the NGR in its war against the Gargoyle Empire cannot afford. Restricting the sale of certain goods to the Polish kingdoms has helped, but not enough. So for now, the defiant and reckless Polish arms dealers and opportunists are looked upon as the considerably lesser of two evils and are mostly ignored. The NGR just hopes they aren't throwing too much fuel on the fires of Russia and contributing to what may eventually turn into a bloody civil war in that region.

As one might suspect, the NGR's position has outraged the most aggressive of the Warlords, who have taken their actions as a slap in the face, and marks the NGR as an enemy. Retribution may be long in coming, but the seeds are already planted.

The Role of the Warlords

Russian Society on Rifts Earth

Before one can understand how the Warlords maintain order and impose their wills over the people of Russia, one must have some knowledge of Post-Cataclysmic Russian civilization. Unlike Germany and Poland, Russia was devastated by the Great Cataclysm, the eruption of ley lines, the appearance of magic and demons, and the Eighty Years of Winter. Although some high levels of technology survived or have been rediscovered and restored, the vast majority of Russian people are low-tech. In many ways, their lifestyle has reverted to the pastoral and agriculture-based simplicity of the old "Kievan Rus" of the 9th through 13th Centuries. The majority are farmers who till the soil or raise grazing animals, others hunt and trap, or engage in logging and woodworking, while those along trade routes or in the big cities may be merchants, traders, laborers and other occupations appropriate to that environment. Thus, while a farmer may carry a laser rifle or Vibro-sword for protection, he is still a humble man working the land through his (and his family's) physical toil, sweat, and heartfelt efforts.

Most communities are rural, small and spread apart. Farms, cattle ranchers, and lumber camps are usually managed by a single family or family clans.

Tens of thousands of **small farms** managed by the mother, father and 4-10 children, and possibly 1-6 other family members, dot the countryside, especially in Western Russia and the fertile plains of what was once the Ukraine. Small farms can also be found on the grassy plains of the Steppes, but are much fewer, spread farther apart, and the growing of crops usually takes a back seat to raising cattle and other livestock.

Large farms, camps and tiny villages are typically operated by family clans, several generations of family members, brothers, sisters, uncles, cousins, etc. Such communities are typically led by one particular segment of the family or one or more family elders. With cousins and such included, these farms and camps can number from 20-100 individuals.

Villages are typically composed of several different, unrelated family units and engage in two or more industries that support the community. Farming and raising cattle combined with a handful of basic jobs and services (baker, butcher, carpenter, blacksmith, priest/church, doctor, etc.). Farming or raising cattle can be substituted with logging/lumber, or trapping and the fur trade, or mining, and similar industries. Those along trade routes, ports or large cities will have a larger range of industry and service markets and engage in trade, sales and banking.

Most clans, villages and cities function as independent communities with their own set of leaders, commerce, laws, rules, ethics and practices. This means the laws and practices of each village can be very different from one another, however, most share similar ethics, morals and laws. This independence and diversity doesn't affect the Warlords or their warriors, because they are above regional law and can do as they please — common folk must obey them, not the other way around. Ultimately, the Warlords don't care how a community conducts itself provided it pays tribute, supports their efforts, and shows them and their Camp the respect they demand. The only universal law the Warlords enforce is the absolute abolishment of the demonic, meaning one cannot practice demonology, witchcraft, and necromancy, nor associate with demons and other evil supernatural forces. Although demons and monsters are sometimes kept as slaves by Warlords and their chief lieutenants, common folk are not allowed to keep demons, sub-demons (like Gargoyles), ghouls and other supernatural beings as slaves, clients or associates. The punishment for willfully associating with the demonic is death!

Affiliation with dragons, faerie folk and other creatures of magic, and spirits is considered dangerous and discouraged, but is not illegal.

Although there are a vast number of tiny to small, self-sufficient communities, there is no central government, kingdom or ruling body. That's where the Warlords come in. They are actually a military aristocracy that helps maintain the status quo, as well as keep their Sphere of Influence safe. Not only do the Warlords' legions of warriors hunt and destroy dragons, demons and monsters that threaten the region, they also help to keep the peace among the many tiny human communities. The Warlords' Camps help settle disputes, investigate mur-

der and serious or strange crimes, administer punishment and extract justice (at least, as they see it). As one might expect, this is done through intimidation, extortion and military force.

For example, two rival communities engaging in disruptive or embarrassing economic or military "war" against each other is not tolerated, and they will be warned to settle their differences, or the Warlord will settle it for them. Skirmishes, pranks, and vandalism where no life or property is lost between the two are generally ignored until they get out of hand. Likewise, hard feelings, pettiness, slander, and robbery directed at one another are also ignored. When their squabbling becomes a nuisance or an embarrassment to the Warlord, or prevents one or both from paying their full tribute, or results in bloodletting, the Warlord alerts his Camp to intervene.

Intervention can be swift and terrible. Armed forces enter both villages and a mandate, fair or not, is issued. There is no room for debate or negotiation — either comply or die! Any argument, resistance or insult will result in the war camp attacking the offending village. As punishment, it will be looted (forced tribute as payment for the trouble and expense they have caused), parts burned or blasted to ruin (a show of the Warlord's force and displeasure), and all instigators and leaders (either because they were party to the insurrection or too incompetent to prevent it) are executed! If either community continues to cause trouble or badmouth the Warlord or his Camp, it will be targeted for additional retribution. Typically, only one of the communities involved is stupid enough invoke the Warlord's wrath.

The Matter of D-Bees

Fraternization with **D-Bees** is discouraged, but stemming the tide of inhuman (but not quite demonic) immigrants into Russia, especially in the Steppes, seems impossible. D-Bees are generally treated as nomadic foreigners with no place and no rights in Russia. One way the Warlords and common folk have decided to "control" the D-Bee population is to enslave them. In this way, they are not citizens or Russians, but lowly slaves forced to serve Mother Russia and **Her people**. However, tiny communities of D-Bees (mostly farms to small villages of a few hundred) often take root. Depending on their current mood, most Warlord Camps and humans ignore these places, as if pretending they didn't exist makes a real difference. Some members of the Warlords' Camps may even fight to protect the village of inhumans from supernatural evil. However, they are just as likely to let the village suffer, or slaughter the people and raze the village along with the demonic menace that plagues it.

To most Russian people, these D-Bee communities are inhabited by monstrous, alien squatters who have no rights. They are frequently raided, raped, and abused by Warlord Camps and common folk alike. The knights and warriors can enter the town and take or do anything they please. Any D-Bee who stands in their way or raises a hand in self-defense or protest is beaten or killed. The worst of the Warlord's Camp will loot, rape, torture and kill these people with wanton abandon, free of any crime or punishment in the eyes of the Warlord or most members of the human population.

If a D-Bee community is suspected of "harboring supernatural evil," "spreading wickedness," or practicing "witchcraft," the place is likely to be razed to the ground and its inhabitants enslaved or slaughtered — the lucky ones chased away after their

village is destroyed. When a D-Bee community begins to compete with the humans in the area it will be regularly targeted for slander, crime, robbery, raids and vandalism, usually by the local humans. If it becomes too strong, prosperous, and/or influential, the people (humans) will bring it to the attention of the Warlord of that region. He will then dispatch troops to investigate, extract tribute (50 times anything a human village must pay), and rectify any inequities. This rectification process typically involves the Warlord's troops seizing all easily transportable valuables, weapons and supplies for their Camp and Master, and either enslaving or driving away all or most of the D-Bees. If possible, the Warlord's raiders will try to leave the village intact. Once the D-Bee invaders/squatters are scattered (typically 20-50% enslaved or killed), the humans in the area are allowed to do with the village as they will. Two-thirds of the time, humans simply move into the village and take it over as their own. Other times it is pillaged and destroyed.

The Warlords

The Warlords stride Rifts Earth like legendary heroes from epic myth. All are larger than life figures enshrouded by scores of stories about their wisdom, strength, cunning and accomplishments. As one must expect when it comes to "living legends," the validity of such tales may lie in question. Some are true, others are legendary backgrounds fabricated to unify and inspire the clans that compose the Warlords' legions. Most of the tales spun by the Warlords themselves are wild extrapolations and exaggerations based on real events and heritage, or carefully contrived stories to validate or support a Warlord's rule, rights or motives. Others are complete works of fiction that blossom from the fertile imaginations of peasants and nomads and are born from respect, awe, rumor, innuendo, hearsay and fear.

The outside world typically sees each Warlord as nothing more than a brutal barbarian who lives by the age-old system of conquest and tribute — a bloodthirsty and ignorant savage who engages in a rampage of death and mindless destruction for his own personal gain and satisfaction. The facts dispute this. Each Warlord *is* a strong and capable leader to which others gravitate, and who is accepted as an ultimate leader. Among the Warlords, some are wise and reasonably benevolent, others are military and/or political geniuses, while still others are ruthless brutes who maintain power through fear and violence, but none are ignorant savages. All command a fairly complex military society, have successfully driven demons and hordes of monsters from the lands they dominate, and maintain order and control over the warriors of their Camps and the people subjugated to them.

To some degree, each of the Warlords is motivated by a lust for power, greed, heroic glory, and (perhaps misguided) patriotism. As patriots, all Warlords sincerely wish to see Russia restored to human hands where it can achieve new greatness. It is true that the Warlords and their Camps can be brutal, bigoted, and murderous, especially toward nonhumans. It is also true D-Bees are often seen as monstrous invaders, and the Warlords and their Camps have been known to slaughter entire clans, tribes and villages (taking what spoils of war they can) in the name of liberty and patriotism. Yet, whether one regards the Warlords and their War Camps as heroes or murderous barbarians, none can deny that the Warlords are dedicated to the relent-

less battle to rid Mother Russia of supernatural evil and terrible monsters. More importantly, they have instilled this way of life into the warrior clans of their War Camps.

Destroying demons, dragons, ghosts, and all monsters, as well as maintaining (relative) peace and prosperity for the Russian people is the mandate that the War Camps live by. The Warlords dispatch the members of their War Camps into smaller groups — raiding bands, squads, platoons, companies, and battalions — to patrol the land, defend the people, collect tribute/taxes, and root out demons and dangerous supernatural forces and drive them out or destroy them utterly. While each Warlord and his War Camp have the greatest presence and dominion over their respective *Sphere of Influence*, they often travel as small bands into the Spheres of other Warlords. Despite the rivalry between each of the Warlords and their respective camps of loyal followers, these knights and warriors will stop to defend any Russian (human) from the supernatural, regardless of his loyalties. Furthermore, the Warlords have been known to join forces to battle grave dangers from a common enemy, such as demonic invading hordes. They are warriors born. The new knights of the Realm — no, the saviors of Mother Russia!

If there is a downside to the Warlords and their mobs of warriors, it is that they and their legions also fight for their own personal bid for power and glory. This means they often abuse, use and loot the very people they have sworn to protect; in some cases, making the Warlords the (considerably) lesser of two evils.

Warlord Camps

A Warlord's "Camp" is his army. It is composed of the fighting-men who have pledged allegiance to that one particular Warlord. Some are noble and honest knights and warriors, others ragamuffin adventurers, fighters and patriots in search of adventure, fame, or revenge. The worst are bullies and bandits no better than the inhuman vermin they battle, but they are in the minority (about 20%).

The Camp leaders are either clan elders or the most courageous, capable, experienced or ruthless warriors to have clawed their way to positions of power. Most (but not all) leaders are generally regarded as the Warlord's most trusted officers. Of course, it is from within these elite ranks of leaders that the authority and rule of a Warlord and his heirs may be challenged. However, most of these sub-leaders respect and obey their Warlord Master, and keep the lower ranks in line and loyal. Most lead by example and can be found at the front or center of any battle.

Other than the *Reavers*, the warriors of the Camp are considered heroic knights and patriots. Morale is astonishingly high and cowardice, betrayal and dissension within the ranks are rarities. This is due in large part to their strong motivation, direction (destroying monsters and saving Russia), and the level of power and respect commanded by even the lowest of the low within a Warlord's Camp. These fighters are more than common soldiers or bandits, they are the warrior elite and Russian patriots. As such, they command respect, fear and power that is unprecedented in the current Russian society. It is a noble, honorable and high place in society that will not be easily abandoned out of fear, dissatisfaction, or pettiness.



Once accepted into a Warlord's Camp, the warrior instantly becomes a "Knight of the Realm." Even the *Reavers* (steppe nomads, barbarians, adventurers, mercenaries, bandits, foreigners and some D-Bees) are held in high regard — and fear — by ordinary folk. Furthermore, with the mantle of knighthood under the Warlords' command, comes genuine glory and authority. While the life of a Warlord's knights is governed by military structure and they must endure tremendous hardship and face death in battle, these warriors truly hold a grand place among the Russian people. As a member of this elite brigade, the warriors attain a social strata higher than most other occupations in the Warlord dominated Russian society. Only the Warlord and his officers have higher social standing. Thus, the lowliest Warlord's grunt has a higher, nobler place in society than the greatest scholar, priest, healer, elder, mage, political leader or independent hero. And the people give these warriors their due by showing them the respect their position affords them. This is done out of genuine respect and gratitude for the Warlord and the men who risk their lives to keep Russia safe from alien monsters, or out of practicality and/or fear.

The vast majority of people, both highbrow and low, have accepted the Warlords' rule because they really do offer the organized military protection the people need to survive against demonic and monstrous forces. Furthermore, except for the occasional serious abuse of power (1-4 times a year, someplace in each Sphere of Influence), their lives are better, safer and happier under the Warlords. This rapport transcends cultural barriers and helps to cement and perpetuate mostly positive relations in the Warlords' bid for power and control.

Even when downtrodden by abusive members of the Warlord's Camp, most Russians, especially peasants, see these warriors as patriots and saviors. On the more pragmatic end of the spectrum, they also accept the hard reality that the Warlords and their Camps possess the power to hurt and destroy them at will, thus it is best to appease them. Appeasement is typically shown to even the worst scoundrels, bullies and roughnecks in the Camp. This means a lot of, "yes, sir," "no, sir," "how can I help," "right away, sir." Most warriors receive treatment one would expect to be offered diplomatic dignitaries and heroes of renown. The noble and kind members of these War Camps don't abuse the people or make them run around helter-skelter, but the most arrogant, pompous and cruel will demand that everybody is at their beck and call, and treat them shabbily. The worst will threaten, bully, beat, extort, rape and belittle the "peasants," as well as ignore or supersede local village authorities, elders, traditions and laws. Whichever the case may be, ultimately, the rule of the Warlords is no **crueler** or destructive than any empire-builders throughout history. In fact, they are probably more just, patriotic, dedicated and humane than many.

The Warlords originate from nomadic, warlike family clans, several coming from the Steppes. The old clans functioned as a microcosmic entity serving all functions of society. They lived, worked and fought as a unit led by one or more clan elders. With time, the clans grew larger and began to incorporate other, often loosely or entirely unrelated groups into their clan. When one clan defeated another, the victor usually praised the courage and strengths of the fallen and offered him the opportunity to join the clan that had just bested him as an equal. The alternative was to resist and be slain, or flee as a vanquished refugee or become enslaved. To help cement the relationship, these early

Warlord clans would *invent* a family, historical, or divine link between them and the vanquished group, thus making them related in some way, and their union some act of divine intervention or fate.

Today, even with the average Warlord's Camp numbering into the tens of thousands (often approaching 100,000 warriors), there is an incredible sense of unity and family. Loyalty to one's "Camp" is intense and often a part of one's heritage; a birth-right. Membership to these elite Camps of military aristocracy can extend for ten generations, with some assuming (unlikely) ties that go back hundreds of years before the Great Cataclysm. Yet whether one is a long-time member of the Warlord elite, or recently embraced, loyalty is met with unfettered acceptance and camaraderie. The new knight is welcomed with open arms by his fraternal, warrior brothers. All members of the Camp will stand at the other's side against a common enemy, bleed and die for each other (and for their Warlord and Mother Russia) without hesitation. Consequently, those who dismiss the Warlords and their Camps as barbaric savages do these warriors a great disservice. They are, perhaps, *gangsters* complete with "gang colors," heartfelt oaths of allegiance, bonding rituals, a sense of intense allegiance and brotherhood, as well as being men of violent action, but they are organized, committed and united. Its members watch out for one another, share each other's joys and sorrows, triumphs and failures, lives and deaths. Together, they fight hellish monsters, live, struggle and die. Together they fight to save humankind and restore Mother Russia.

Like a gang, each Camp has its own unique identity denoted with "gang" regalia, symbols, icons, and characteristic armor (i.e. "gang colors"), right down to specific types of weapons, body armor and bionic features. Such identifying marks, symbols and traits serve as a badge of honor as well as a warning or challenge to rivals and enemies. Wearing these group "colors" brings honor and privilege that are not taken lightly. To forsake or rebuke them is an act of treason or cowardice, and mocking or despoiling them is an insult that is a challenge to do battle.

Note: The word "Camp" is also used to describe or encapsulate attitudes and opinions, *"That's the Romanov's for you. You know what that Camp is like!"*

The Military

Applications of War Camps

A Warlord's "Camp" includes all the military **troops** and units (groups) under his leadership and command. However, the overall "Camp" or army is usually divided into many smaller subgroups that function as separate units (i.e. company, battalion, brigade, division, etc.). Each serves its Warlord and operates in his name. In fact, the warriors of the Camp are considered to be extensions of the Warlord's will and his might.

The Camp and its many subgroups function as a mobile army, composed of warriors and supporters who have pledged allegiance to one particular Warlord. A Camp can be as small as 20,000 warriors, but most range between 30,000 to 70,000 individuals, usually divided into a dozen or more smaller groups of 1,000 to 8,000. In turn, these subgroups may divide themselves into squads, platoons and other small units used for patrolling borders, **scouting/reconnaissance**, intelligence, escort, seek and destroy missions, spying, raids and other tactical applications.

All of these troops roam the Warlord's *Sphere of Influence*, engage the enemy, defend borders, and protect the holdings of their Warlord and the people within that Sphere. Their primary enemy is the supernatural, including Gargoyles, Gurgoyles, **Brodkil**, vampires, ghouls and ghosts. However, they are also vigilant for war parties, raiders, and invaders from other parts of Russia, **Europe**, and Asia, as well as bands representing rival Warlords, bandits, and powerful and dangerous travelers, mercenaries, foreigners, D-Bees and creatures of magic (particularly dragons, psychics, gypsies and practitioners of magic).

Although there is military structure, rank, and order of command, most of the Camps would seem to operate under loose rules and regulations compared to modern armies (like the CS and NGR). There is typically no special uniform, dress code, or strict code of conduct. The men know their leaders and the chain of command, the Warlord's laws and what's expected of them. They are to show respect to their leaders and obey their commands quickly and faithfully (unless there are unusual mitigating circumstances). They are expected to fight and most do so without hesitation. However, in the quiet times in between battles, these rough and tumble nomads are a rowdy, rambunctious lot given to practical jokes, drinking, loud laughter, **storytelling**, singing, dancing, sports, and good-natured brawling. As long as they get the job done, regularly destroy monsters, and do so in a way that honors or enhances the reputation (and holdings) of their **Warlord**, they are given a fairly free hand.

One of the unwritten codes of the Camp is for each warrior to be responsible for himself and then his brother. This means using care, caution and common sense. For example: Each warrior is expected to take care of his own tent and possessions. If he loses his allotted food (especially through foolishness), he goes hungry (most won't even ask for a handout). If the loss of his food leads the enemy to the Camp, or allows the enemy to escape, the warrior responsible is beaten or bullied and chastised by everybody in a hope that humiliation will "improve his memory." If the loss of food was due to carelessness or foolishness and leads to tragedy, the punishment is likely to be more severe. Complete incompetence, willful **slothfulness** or disregard for others will lead to permanent banishment (for many, a fate worse than death, because it dishonors the entire family and their name — some will change their name), or death. The justice of the Warlords and their Camps is harsh, but fair and memorable.

Most Camps use guerilla tactics, the element of surprise and hit-and-run combat techniques. One of their favorite tactics is to break into separate but coordinated groups and make the enemy believe they are a smaller force than they really are. Then, at the right moment, more forces seemingly appear out of nowhere **and/or** in greater numbers than expected to swarm over their opponents. They are excellent at arranging ambushes and leading their opponents into traps. A common saying about these warriors is that where one sees a pair, a dozen lurk nearby. They



also engage in theft, pranks, vandalism, sabotage and acts that undermine the enemy in ways that annoy, taunt, belittle and demoralize. Many of the smaller raiding groups are also masters of intimidation, subterfuge, feints, fakes and trickery. Others are skilled thieves, smugglers, and bandits.



The Brotherhood of Heroes

To become a member of a Warlord's Camp, one must either be invited or born into it. Invitations are usually given only to heroes and adventurers who have caught the eye of the Warlord himself, or one of his most highly placed and trusted leaders. If the character invited later proves to be dishonorable or traitorous, both he and the person who sponsored his invitation into the Camp are punished. For incidents not too dishonorable or damaging, the sponsor is responsible for bringing the individual to justice (typically finding and killing him) and must bring about some sort of closure or recompense for that **villain's** deed. If the crime was extremely dishonorable, treasonous **and/or** damaging, the perpetrator is slain and his sponsor is either banished forever or put to death. The sponsor knows the risk and will relent to whatever punishment is handed out to him, even death. This tactic successfully keeps **outsiders**, spies, assassins, louts and troublemakers from being brought into the elite War Camp.

Once one has served in a Warlord's Camp as a Knight of Russia, it is a birthright passed on from generation to generation. This means the children, male and female, must swear allegiance to the Warlord and accept the rugged life of a warrior and protector of Russia. This is an oath that is not taken lightly.

As noted earlier, to serve under a Warlord of Russia as one of his elite warriors is to become the equivalent of a knight (War-knights and Cossacks being recognized as true, full-fledged knights) and earns the warrior a high place in society. Thus, those born into the Camp enjoy the privileges of their fathers and forefathers. By the age of six, these youngsters are taught the ways of military structure and procedure, riding, combat and fighting tactics. Depending on each individual's abilities and natural aptitude, he (or she) can ride with other warriors by age thirteen. A feat of courage in real life and death combat can take place as early as age fifteen, although most come of age as a warrior at age seventeen or eighteen.

The male warriors dedicate themselves to the protection of the Russian people and the annihilation of the demonic, supernatural, alien, and monstrous. They spend most of their time (70%) riding, scouting, hunting and fighting supernatural creatures and other enemies of Mother Russia. The rest of their time is spent performing other services to their master (like collecting tribute for the Warlord), spending time with their friends and families (usually active members and part of the Camp) and drinking and dancing. Most of these warriors seize the opportunity to live life to the fullest whenever they can.

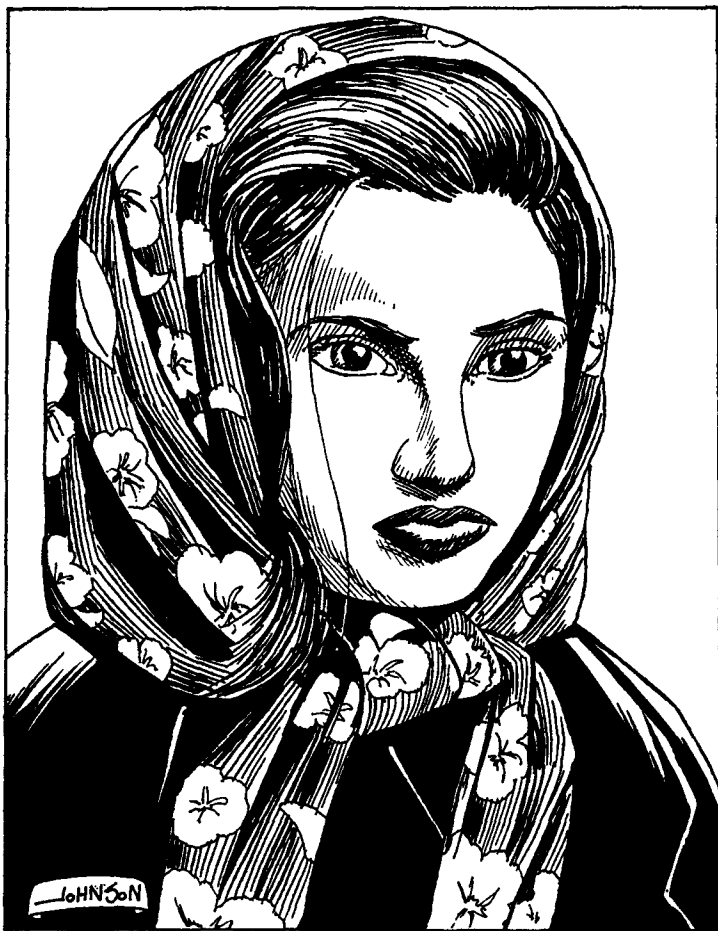

The role of the female. The Warlords and their warriors are predominantly a *male* dominated society. Thus, females tend to serve as (often crucial) support personnel of the Camp. As "support" personnel, they take on the roles of **organizers**, accountants, cooks, teachers, nurses, doctors, Cyber-Docs, Operators and Engineers of all kinds, builders, carpenters, communications specialists, and overseers of the Camp and most of its internal operations. In fact, many westerners are surprised to see women mechanics climbing into or under the bellies of Mega-Damage war machines and rebuilding engines or attaching and repairing bionics as Cyber-Docs. All are important roles critical to the success of the Camp and its many sub-groups. Without the women filling these roles, the men would not have the true freedom to serve unfettered as warriors, protectors and ghost hunters.

Women can also achieve warrior and knight status if they really have what it takes. About 16% of the warriors in most Camps are female. Women warriors are not given preferential treatment and must be able to perform the same duties as a man in order to be accepted as a warrior. Once they have proven themselves, they are treated like one of the men — a warrior brother whom the men see as a true equal. However, from a young age, women are generally pointed in the direction of support.

The role of **outsiders** — Reavers. Foreigners (non-Russians), human-looking D-Bees (occasionally monstrous ones), steppe nomads, barbarians, adventurers, mercenaries, bandits, and mutants can *not* become true Knights of the Realm nor true Russian patriots. Instead, they are relegated to "Reaver" status.

Reavers are warriors, sorcerers, psychics, disenfranchised knights and soldiers, criminals and other occupations who are accepted by a Warlord's Camp as (reasonably) trustworthy *rogues*. They must swear allegiance to and support a particular Warlord and have a desire to fight for his causes. Most are uneducated, high-spirited bandits, brawlers, cocky young adventurers, refugees, and disreputable ruffians. In some ways, Reavers can be considered thieving mercenaries or barbarian hordes used by the Russian warriors as front line combatants, spies, thieves, assassins, scouts, enforcers, labor, and, sometimes, fodder. All seek martial adventure or revenge and most like to fight and cause trouble. Although generally held in high regard and feared by ordinary folk, they are the lowest of the low among the Warlords' Camps. As foreigners, D-Bees, outcasts and bandits, they actually have no rights under Russian law, although they are expected to obey the law, and will suffer the Warlords' brand of justice.

Conscription

The warriors who serve under a Warlord are part of a Camp and can only join a Camp through birth or invitation (provided they are Russian, otherwise they join as Reavers). However, in times of war, a Warlord and his Camp may call upon the ordinary subjects under his rule (all who live or, sometimes, those who enter his Sphere of Influence) to raise arms and join his knights in combat. This is an uncommon event and usually indicates a serious danger to that region. That being the case, most subjects (60%) comply and serve willingly, while others do so under duress — to defy the Warlord's call to arms is punishable by beating, brutality and death.

The age of conscription will also vary according to the danger. Typically only men of a particular age group will be called, usually leaving the very young, husbands/fathers and the elderly at home. However, there are times when men of all ages above 15 years of age are called, and sometimes women unhampered by children as well.

Under such a circumstance, the conscripted people are allowed to go home as soon as the war is won; 99% usually do, and very few stay on as Reavers or seek to join the Warlord's Camp.

The Sphere of Influence

The Warlords and their Camps (warriors/minions/followers) are "The Law" in their respective "Spheres of Influence," and pretty much do as they please. Just how badly they may abuse the people, especially the lower class, depends on the personalities and whims of each respective Warlord, and the lieutenants who serve under them.

It may at first appear that the Warlords of Western Russia control vast areas of land and all their resources, but this is misleading. There is no denying they are a major influence in the region, and they do control major trade routes, villages, other important border locations, and resources. They maintain strong lines of communication and enforce their wills through intimidation and military force. However, take a look at the vast land area they "dominate," and it becomes clear that there is no way most of this land can be patrolled, policed or contained by them or anybody.

A Sphere of Influence (the territory a Warlord claims as his domain) might be better equated to the territory held by a predatory animal. In this case, the wolf pack may be the most apt analogy, because the Camps and other minions of the Warlords are like the lesser wolves in the pack. The animals see a particular territory or region of land as their own and take from it what they need to survive. The wolfish predator defends his territory from invading predators and outsiders. The leader (Warlord) will fight all who dare to challenge his rule and kill any who threaten his way of life, his pack and his territory. The pack (or Camp, as the case may be) chases away or slays trespassers and invaders. Likewise, they prey on the cattle-like herd animals (the indigenous peasants) and any who succumb to weakness; food for their slaving jaws.

Like the wolf pack, the various Camps and clans who serve as the military and enforcers of the Warlord, prey upon those weaker than they. However, they seldom kill wantonly or take more than they need, for without the herds (indigenous peasants) to feed upon, the wolves suffer and starve. Also like the wolf pack, the Camps travel their "territory" in small groups on a regular circuit. Thus, they are seldom at any one place for more than a month, and are constantly traveling in order to survey their entire domain. This means the pack (or some portion of it) is away from any one particular area for long periods of time. Even if there is only a month between visits (and most places only receive a visit once every 2-6 months), there is no way for the Camp to truly know everything that's happening in their "Sphere of Influence." They certainly can't know where everything is at once, and have very little idea of what may be happening at locations out of sight and out of reach only a few miles away. Still the splintering of the War Camp into a dozen or more smaller sub-groups and traversing the region of Influence is reasonably effective and efficient, particularly since most villages are small, quiet agricultural communities and most are low tech. Remember, Russia is largely a wilderness with tiny, scattered pockets of human habitation. Still, in case of trouble, few villages are more than 1-6 days ride from some sizeable force of the Warlord's, and 3-8 fragments of any given Warlord's Camp can rendezvous and join forces within 48-72 hours.

A matter of Intimidation, Control & Loyalty. The leaders of the War Camps (if not most of the warriors) know that the villagers and inhabitants of their Master's Sphere of Influence bow and scrape in their presence, but do (or at least consider) otherwise when they are not around to keep an eye on them. Since the members of a Warlord's Camp cannot afford to keep a garrison at every little village, farm or lodge, they tend to ignore minor infractions and **offenses**— things like talking badly about a Warlord, hiding grain or valuables in order to keep a little extra for themselves, or trading with harmless D-Bees. Likewise, unless in a foul mood, most Camps tend to ignore whispered complaints about them or their Masters. As long as the subjects of and visitors to their Sphere of Influence pay their fair share of tribute, show them respect (at least to their faces), **don't** complain openly, don't defy or challenge their authority, or cheat too much, the members of the War Camp couldn't care less. They know that the moment they ride out of town that some villagers will grumble complaints and even spit and curse their names. They accept that many petty and unimportant things go on behind the Warlord's back when they are away. They also

accept that it is human nature to complain and try to cheat a little bit, and ignore it. Some even find it amusing.

However, there are clear lines that should never be crossed. To do otherwise is to invite severe retribution and court death. The following are some of the most notable crimes that will bring down the wrath of a Warlord's Camp. All such acts are considered crimes directly against the Warlord **and/or** acts of treason.

- Lying to members of the Warlord's Camp about matters of importance (namely demons, monsters, black magic, incursions by the enemy and acts against the Warlord) is a serious **offense**.
- Robbing or cheating members of the Warlord's Camp is like robbing or cheating the Warlord. Retribution shall follow.
- Killing a member of the Warlord's Camp is like striking the Warlord. Those responsible shall be brought to justice (typically executed unless there are powerful mitigating circumstances).
- The practice of witchcraft, necromancy, **demonology**, **Shifting/Summoning** or similar dark **magicks** is forbidden. All such practitioners shall be hunted down and **slain!**
- Any willing association or trading with witches, necromancers, **Shifters/Summoners**, and any person believed to associate with demons and demonic forces is forbidden, and shall invoke the wrath of the Warlord (i.e. severe retribution by his Camp).
- Any willing association or trade with any evil supernatural being or any person believed to associate with demons and demonic forces is forbidden, and shall invoke the wrath of the Warlord. Working with or serving a demon to undermine or harm the Warlord, humans or Mother Russia is punishable by a quick death.
Even the association with so-called good spirits, angels, faerie folk, gypsies and dragons is frowned upon. "AH" dragons are not regarded as enemies of humankind, Mother Russia or the **Warlords**, but are seen as dangerous and duplicitous creatures of magic not to be trusted and best to be avoided. The War Camps have been responsible for the deaths of many dragons.
- Association or trade with any known enemy or rival of humankind or the Warlord, particularly the offering of precious resources (which can include food), weapons and strategic information is an act of treason punishable by death.
- Gypsies are dangerous and duplicitous people not to be trusted and best to be avoided. Many are believed to cavort with demons and thieves, and play with dangerous magicks.
- Hiding food, resources and valuables to avoid paying fair tribute to the Warlord shall invoke his ire and bring retribution.
- Defying or showing no respect to the Warlord or his agents shall invoke his ire and bring retribution.

The practice of the black arts, such as witchcraft, necromancy and Shifting, as well as the association with demons and evil (or even questionable) supernatural beings are the two most heinous crimes one can commit, and are punishable by a quick death. Quickness is not out of mercy, but for the protection of the Warlord's knights and innocent people. Kill or be killed is



the general sentiment. There is no trial or investigation, the leaders and experienced members of the Warlord's Camp are expected to be able to recognize genuine demons and witches and dispatch them posthaste using their best discretion. As patriots and **heroes**, most members of a Warlord's Camp are very fair and judicious with this great responsibility and do not falsely accuse innocent people of this terrible **offense**.

The exact punishments for the other crimes vary dramatically from situation to situation and from enforcer to enforcer. Some leaders of the Warlords' troops try to be tolerant and fair, others are uneven (sometimes strict and brutal, other times surprisingly gentle or permissive), others are firm but fair, while still others are always brutal **and/or** extreme. Thus, depending on the circumstances, the offender, and the authority figure enforcing the "law," an offense might get a stern warning **and/or** a **threat**, a beating or ransacking of his home or business, or the killing of the ringleader, to all the perpetrators behind it being tortured **and/or** killed, to the ring leaders and any who raise their hand against the Camp being slain and the entire village ransacked or burnt to the ground! Some of these extreme actions contribute to the stories about the Warlords being barbarians.

All this having been said, the vast majority (over 90%) of the villages and subjects under the Sphere of Influence of a Warlord have learned to live with these laws, and a majority (roughly 60%) completely agree with them and gladly follow them.

Intimidation and retribution is the double-edged sword the War Camps use to keep the Warlords' "subjects" (peasants and citizenry) in line and submissive. Like a child playing away from the home, it is the fear that the parent (or in this case, the Warlord and his Camp) will find out if they did something bad, wrong or illegal that gives them pause to reconsider their actions and stay on the straight and narrow. Since retribution can be terrible, it is another deterrent to defying or willfully harming the Warlord and his Camp. The fear of unpredictable and potentially savage reprisal (combined with feelings of genuine respect and gratitude) makes most people very cooperative and honest when dealing with members of the Warlord's Camp. To insure and maintain this sentiment, the Camp likes to *set examples*. The idea being, if one village or group is punished harshly as an example of the Warlord's intolerance to some infraction, it will send a clear message to all the other subjects within their Sphere of Influence. The Warlords and their Camps are big on setting examples.

In addition, most villages and communities, from the largest to single family households, are God-fearing (derivative of old Russian Orthodox Catholicism, with some areas in the steppes and southeastern regions being a mixture of Catholics, Moslems, Taoists **and/or** **Buddists**) and have their own moral standards, traditions and laws which they practice and uphold to begin with. Since an angry Warlord or group of his warriors might make the entire village suffer for the crimes of a **few**, the people and any local authorities (whether elders or actual martial authority/police) often actively work to keep the Warlord's laws. This means they try to stop, bring to justice, banish **and/or** inform the Warlord (through proxy via his knights and warriors) of demon worshipers, criminals and discontents in or around their village. Such cooperation is genuinely appreciated and usually spares innocent people from being harassed and punished for the sins of a few.

Warlord Tribute

Every individual of working age is accountable for a tithe, 10% of one's annual income. Tithing is an ancient system used by both religious and political figures of the past as a "bottom line" way of skimming wealth off the population. Those who own businesses must attempt to keep some form of record to show the Warlord's Tribute Collector when he comes. While a tithe is traditionally one tenth of one's earnings, *Warlord Romanov* imposes a 15% tithe on households and a 20% Business Tax (merchants, traders, builders), while *Warlord Orloff* imposes a stressful 25% tithe on his subjects and 40% on businesses. In most cases, those who earn "wages" are taxed by a simple system, 10% of whatever they make. This tax or tithing is automatically deducted by employers and kept in a safe place for the tax gatherer when he comes. In rural areas, this 10% translates into 10% of the households or farm's crops and livestock. Those having a prosperous year can voluntarily offer more than 10%; an act that should get them the attention and good graces of the Warlord or at least some faction of the Warlord's Camp.

In addition, the Warlords typically take 20% to 33% of a community's (village, town, etc) grain, food stores, alcohol, riding animals, livestock, products, and raw materials and resources like bolts of material, furs, lumber, petroleum, pitch, etc. Furthermore, a community is expected to supply, feed and house members of the Warlord's Camp to the best of their ability (even sacrificing one's own bed when necessary) whenever they come to town. This is easy when the group of warriors is small, 4-60 men, but can be difficult when there are hundreds or thousands of men. The Knights of the Realm know not to abuse their authority or privilege, and are *never* to completely plunder a loyal village's resources. It is drummed into them to always leave enough for the villagers to continue to live without hardship and suffering.

The official Tribute Gatherer is usually a 6-9th level full conversion cyborg, psychic or sorcerer, who goes dressed in long black robes. He is usually accompanied by a squad of 8-16 cyborgs or War-Knights (occasionally lower ranking warriors, but never Cossacks or Reavers). If the tribute is known to be in the form of goods (grain, furs, etc.) an entourage of porters, workmen and truckers will accompany him. The Tribute Gatherer's appearance is calculated to both distinguish his position and create an imposing image which brooks no argument! His word is law in gathering tribute. The Tribute Gatherer is perfectly within his rights to take silver, gold, diamonds, jewelry, works of art, grain, furs, trade goods, personal property (like automobiles, furniture, clothing, booze, etc.), and even livestock, horses, dogs and other animals to satisfy his Warlord. It is their right and they firmly believe they are doing what is just and fair.

Outright refusal to pay one's tribute will always result in violent retribution and may call for a village being made an "example" of. However, most of the communities receive the Tribute Collector with a smile and willingly contribute their allotted portion of Tribute. After all, the term, "tribute" means a gift, payment or other acknowledgement of gratitude, respect or admiration — and the Russian people do respect the Warlords and their Camps, and are grateful for their protection and the reclamation of Mother Russia for the Russian people.

Grievances

On the whole, the people know where they stand, and accept (if not always welcome) the protection and rule offered by the Warlords and their Camps. Under Warlord domination, most live satisfying and relatively prosperous lives. The Warlords aren't so bad, kill monsters and help to preserve their way of life. Consequently, it is only fair that the Warlords extract some sort of payment or reward. Most peasants see paying tribute, supplying support (emotional, verbal and material), and tolerating the roughhousing and indiscretions of the warrior Camps as part of their fair payment.

When the warriors get too carried away, the villagers can petition their Warlord and complain. If their grievance is legitimate and fair, most Warlords will take action to rectify the situation and to make certain it does not happen again. Seventy percent of the time such action is successful and the problem rectified without any act of retribution taken against the complainers. However, 22% of the time nothing changes and the people must continue to endure the hardships imposed upon them by their Warlord's troops (typically one particularly crude and rough faction). Eight percent of the time, the complainers are subjected to retribution from the party with whom they have a complaint. Angry (unauthorized) retribution can take the form of increased harassment, acts of brutality and vandalism, to torture, murder and wholesale destruction. Thankfully, the latter is very uncommon, as the Warlords and their warriors rely on the support of the people under their influence and seek to keep morale high and support strong. Additionally, factions of the War Camp who get too wild and out of control face the wrath of their Lord, who doesn't abide the brutalizing of his people.

Rivalry between Camps

The Warlords' nomadic legions, with their superior mobility, can freely come and go within their Master's Sphere of Influence as they please, although most follow some sort of regular circuit.

Travel beyond their Sphere of Influence is frequent, especially for small units (10-60 men). These bands may simply be passing through, in search of adventure or looking for trouble. As is their combative lifestyle, they are constantly in search of supernatural creatures to raid, hunt and kill, however, they are not foolish enough to challenge overwhelmingly powerful beings nor engage an enemy who greatly outnumbers them. Most wayward warriors will carefully pick their battles, unless ordered to do otherwise.

They may also venture outside their Warlord's Sphere of Influence and into the Sphere of other Warlords. This can be done to spy upon him and his Camp, to raid border villages or small factions of this rival Camp, to cause mischief, in search of adventure, or in hot pursuit of a demonic monster. Raiding and stealing from rival Camps is a common practice and sometimes conducted when foraging for supplies, but more often than not it is a macho game between rivals. Only when in the pursuit of a supernatural foe (their mutual enemy), or when "given passage" — diplomatic immunity by the Realm's Warlord, usually for political reasons or the trade of goods or services — are any members from rival Camps tolerated. However, even during spy missions and raids, most Camps try to inflict minimal serious damage to their rivals. Most Camps are satisfied with running

off troublemakers, spies and raiders rather than putting them to the sword. Of course, it's even more satisfying to defeat and capture a rival band, take some or all of their belongings, and/or belittle them before sending them home with their tails between their legs.

Outside their own Warlord's Sphere of Influence, these knights and warriors have no special privileges or rank, although the most notorious may elicit the respect of the people and tolerance from rival Warlord Camps, provided they stay out of trouble. However, the warriors of rival Warlords are generally regarded as potentially dangerous spies, bandits, raiders, assassins, and troublemakers by the members of the rival Camps. As such, they are usually chased away or attempts are made to capture and interrogate them. Captives who aren't valuable enough to be ransomed back to their Warlord's Camp (typically in exchange for one or more prisoners held by their Warlord, or for food, supplies or weapons), will usually be imprisoned or enslaved, but some are occasionally executed (depending on their crimes) and some are simply let free, minus their best weapons, valuables and means of transportation ("walk home you mangy dog").

The grudging respect and cruel mercy shown toward one another has led some peasants to refer to rival Warlord Camps as "friendly enemies." The various Warlords' Camps show restraint, respect and mercy to their rivals in deference to their mutual social status as fellow knights and heroes of Mother Russia, and because they battle a common, hellspawned enemy. However, such tolerance and polite games are quickly forgotten if the transgression is too great (like slaughtering and/or burning down an entire village or killing a band of warriors). Serious incursions and acts of violence can lead to bloody skirmishes, murderous vendettas and full-scale war. Likewise, when a Warlord decides to expand the borders of his Sphere of Influence, large armies are amassed and the disputed lands taken or held in brutal battle.

Most ordinary folk immediately report to their Warlord or his minions the presence and activities of warriors known to be from other Camps, as well as armed strangers, powerful mages, D-Bees, dragons and supernatural beings. Most people are fairly loyal to the Warlord who dominates them, or, fearing reprisals and raids from the outsiders, quickly seek protection from their Warlord's Camp. **Note:** This is another reason the recognizable designs of armor and *insignias* of each Warlord and his Camp become very important. Spies will cover such distinguishing marks and traits, or travel in disguise.

For the time being, each Warlord faction tolerates the other. However, each sees himself as Russia's savior, and ultimately becoming the Czar (emperor) of Russia. The various Warlord Camps frequently clash and raid one another, although few altercations are very bloody; after all they are fellow Russian patriots fighting the monster hordes. However, the day that the monster hordes subside or flee Russia entirely, is the day that the Warlords will begin to battle each other in earnest until only one remains standing. Of course that day is a long way off and it seems unlikely that there will ever be one Czar.

The W of R

All members of a Warlord's Camp and the people living (and even passing through) the Warlord's *Sphere of Influence* are ultimately answerable to the Warlord. However, most Warlords rule through the power of their reputation and the leadership of their most trusted Camp Commanders. Many subject people have never seen their Lord and Protector, and even the warriors of a Warlord's Camp rarely see their great leader — only during the most momentous occasions.

There are several reasons for this aloof behavior. One is that most Warlords are *aging* heroes who find it advantageous to rule from afar. Their aloofness and inaccessibility adds to their air of grandeur, mystery, importance and nobility (i.e. "the gods only come to visit mere mortals when they deem to do so"). Another reason is most of the Warlords believe the old adage that familiarity breeds contempt, and in their case, the possibility that ambitious members of their Camps might see weakness and rise to challenge them.

Furthermore, being inaccessible and remote removes the Warlord from the trouble, hardship and routine of day to day life and the frustration and dissatisfaction of his men. It is not the Warlord's fault for the Camp's troubles. No, it is the bad management or leadership of the men he has placed in charge. In this way, the Warlord can escape blame for almost everything, even the results of events that unfold when his high command follows "his" orders to the letter. Often a Warlord will issue a statement or make an appearance after a terrible defeat or calamity and speak of events as if he had nothing to do with them. For example, a Warlord might give a speech after his Camp's defeat in a titanic battle (that he ordered) to diffuse blame, support his leadership and to rekindle the spirit of his men. That speech, in part, might go something like this:

"The actions of — fill in the blank with the names of the notable leaders — resulted in tragedy. Not even I could not have foreseen what lay before you that day, and we weep. We weep for the loss of our brothers, our heroes, our blood. We weep for being forced to relent and run in retreat. But know that our day will come! Know that we lost this battle not because we were weak, or foolish, but because it was the decree of God (*fate*)! Because we were not ready! But we shall change that. We will rebuild or forces and prepare like we have never prepared before. And when the time comes, we will rise up like the vengeful hand of God Almighty and smite our enemies before us. And the world will know the name of — fill in the blank — (the name of the Warlord and his camp, i.e. "The Romanov Camp"), and tremble.

warlords russia

When a Warlord makes an appearance, it is often to punctuate the importance or seriousness of a situation: Also to raise morale and inflame the passion of his followers (as shown above) as well as to show his approval (or disapproval). It is a tremendous honor for the Warlord to participate in festivities, let alone address or walk among his men for any reason, and to receive his *praise* is a blessing.

Each Warlord is regarded as the equivalent of a heroic king and some are practically deified. The Warlords represent the closest thing to royalty and divine leadership — effectively a warrior king with the holy cause of liberating Mother Russia. Thus, those who raise their swords and fists in his service are loyal knights of the realm and twice blessed. This idealistic, heroic image of themselves and their Warlord, combined with the fanatical, god-like respect (and sometimes worship) of the Warlords themselves, actually helps to bind the members of the Camp together, keeps them loyal and keeps morale high, even under the most difficult circumstances. It also means most of his followers, his Camp, will follow their Warlord to hell and back without question or hesitation, especially if he rides among them.

When a Warlord does make an appearance, his presence is often heralded by parades, great fanfare and moments of fixed reverence. The Warlord is always guarded by trusted advisors and loyal knights willing to sacrifice their lives to protect his. Any man or monster who dares to attack a Warlord is dealt with quickly. The lucky ones are slain on the spot, the less fortunate are captured, beaten, interrogated and tortured; an excruciating process that can last for days, months and sometimes years. Those who would dare to openly question or defy the Warlord's words or commands, call him a liar or challenge him to combat, must face one of the Warlord's champions, often in a life and death trial. While such a trial can be mortal combat, it may also involve a test or feat of (often insane) courage. This can involve anything from battling monsters or demons, a holy quest, to riding a normal horse and making him leap over a gorge until one rider relents or the animal stumbles (usually into the gorge). In all cases, the man who dared to challenge the Warlord and the Warlord's champion (these can be groups of challengers and champions), must both accept the same test. The one who succeeds wins. In this case, winning means their words are held as being true (which may require further explanation **and/or** investigation) and the opposing side must honor their position. In case of a tie (a rarity), the parties are given the opportunity to

consider their original statement or challenge and accept each other, without blame, as brothers, or to accept a new challenge. If anyone refuses to participate after having issued a challenge, their refusal is an admission of guilt, lies, or treachery and they are either run out of town/camp in disgrace (often beaten and stripped naked, with the Camp keeping all of their possessions), or attacked and killed. The severity of the attack is up to the Warlord. **Note:** If the Warlord's champion loses (it's rare but it does happen), the Warlord will either admit he was wrong, or face the challenger himself! When a Warlord answers a challenge personally, the contest is usually vicious, mortal combat. More than once, this has resulted in a new Warlord.

The Seven Warlords

Alekseyevna Camp
Burgasov Camp
Kolodenco Camp
Orloff Camp
Romanov Camp
Seriyevev Camp
Sokolov Camp

Warlord Alekseyevna

Yuri Garald Alekseyevna is the last of the first great Warlords. He is currently 101 years old, preserved by full bionic conversion into a Heavy Machine. Yuri is of sound mind and has a human face that appears to be a man in his forties, and a long mane of white (artificial) hair worn in a pony tail. He likes to wear silk robes and gowns with fur collars because he thinks they make him look regal.

In his youth, Warlord Alekseyevna was ruthless. Everyone who stood in his way he had eliminated. He was able to secure the vast region of land he has held for nearly a century through cunning, guile and treachery. This involved a carefully orchestrated plot 69 years ago, when he manipulated two rival Warlords (there used to be ten). He convinced Warlord Serovka that he supported his efforts against mutually the hated Warlord Tobolsk, and made a secret pact with Serovka, secretly dispatched his army and caught the Tobolsk War Camp between the two of them and crushed them. Of course, Serovka had to declare war first and lure the Tobolsk Army into his Sphere of Influence so it would look like Alekseyevna was coming to his neighbor's aid, rather than inciting a war. Meanwhile, Warlord Alekseyevna made a secret **nonaggression** pack with Tobolsk,



while simultaneously egging him on to do something about the Serovka Camp. Thus, when Serovka declared war, Tobolsk was quick to respond. When the Tobolsk Army invaded, Warlord Serovka attacked with the knowledge that Warlord Alekseyevna's War Camp was waiting on his borders. Only Yuri didn't send his Camp in to help. Instead, he let the two rivals battle it out and destroy each other. When the Tobolsk Camp stood victorious over Serovka, Yuri dispatched his War Camp to destroy them, which they did in short order. Both War Camps crushed and both Warlords slain, Warlord Alekseyevna's troops swarmed throughout their holdings to announce that he had avenged Serovka's death at the hands of Tobolsk, by slaying Tobolsk and crushing his army. Warlord Alekseyevna then graciously offered to accept these defenseless, Warlordless regions and their people as his own, pledging to protect them from evil as long as he lived. Without any other choice, and fearing to become the target for acquisition by other Warlords, or worse, demons, they accepted. The Alekseyevna Camp has dominated the region ever since.

The Warlord has softened over the years and grown a bit bored with military combat and conquests. He has experimented with politics, but found it to be a lot of ridiculous games for which he did not have the patience to play. He has lived off his reputation for the last 40 years, and over the last 20 years, he has left most of the operations of his Camp to his commanders and War-Knights. He now spends his time in an extensive complex of greenhouses where he patters with the growing and crossbreeding of numerous flowers and plant species.

The Throne of the Empire

Warlord Alekseyevna's main base of operation is the **City of Alekseyevna**. A community in the foothills of the northern Ural Mountains, named after himself. It is located near the site of a place once known as Likhta and is heavily involved in the mining and processing of minerals and ores, including iron, gold

and diamonds (the latter fetching excellent prices in the NGR through smugglers and criminal go-betweens). Other mining operations in the arctic circle include coal, oil and natural gas, as well as other mineral resources.

City Population: Approximately 132,000. Overall population of his Sphere of Influence (including the main city): 214,500.

War Camp: 54,000 troops.

Colors: Green and white

Symbol: A flying dragon.

Cyborg Shocktrooper: The Tempest

Conduct: Like their Warlord, they tend to be suspicious of outsiders and will often detain and question adventurers and mercenaries for extended periods of time. Alekseyevna is one of the Warlords who actually takes prisoners in battle, so the prisoners within his territory are often put to work as slaves in the mines and as general laborers.

Living Conditions/Lifestyle: Good in the west, poor in the east. Many of those living under Alekseyevna's rule are fatalistic and rather moody, but they are generally good people. Their Warlord takes care of them and protects them. He makes sure there are food surpluses in the fall to withstand the long and bitter winters of the Russian tundra.

Level of technology: The city is mid-20th century with smatterings of advanced technology, including a small bionics factory complex. The City of Alekseyevna has nearly as many smoke-belching factories as the Sovietski, in and clustered around it. Thus, a massive cloud of sooty grey and black smoke constantly hangs over the city marking its location from up to 100 miles (160 km) away.

Three small, industrial towns (approx. 1,200-3,000 people each) and five dozen farms are found clustered within a 100 mile (160 km) radius of the city. Beyond this last bastion of civilization in the northeast are tiny villages and hamlets with 100-400 people, scattered private farms (family run operations) and the occasional logging mill, mining camp, and trappers' outpost, all at a tech-level equal to the 17th Century.

Alliances: Trades on a regular basis with the Sovietski, Warlord Bargasov, and secretly with the NGR, through criminal contacts. He also trades with the other Warlords as the need (his need) arises.

The Old Man has always hated Warlord Bargasov and he considers Boris Orloff a barbarian and a madman. He thinks of Sonya Romanov's dreams of a "unified Russian Empire" as the foolish fantasies of a woman, and couldn't care less about the rest. For the most part, Warlord Alekseyevna is a loner who feels superior to all the other Warlords, and ignores the happenings in the rest of Russia. He is content with the kingdom he has built and doesn't care to look beyond it. He is also a man behind the times and without direction.

He works his subjects hard, and provides them with little in the way of luxury or shared wealth, but is fastidious in destroying supernatural beings and evil practitioners of magic, as well as inhuman looking D-bees and gypsies (he can't stand 'em). Thus, those under his Sphere of Influence are protected, but don't share in his vast wealth (most have no idea how wealthy he is).

Warlord Yuri Garald Alekseyevna

Race: Human, full conversion, heavy cyborg.

Alignment: Miscreant

Hit Points & S.D.C.: Not applicable.

M.D.C.: Standard Heavy Machine: 270 Main Body plus another 280 from heavy body armor (either wears his heavy armor or no armor).

Height: 9 feet tall (2.7 m) **Weight:** 900 lbs. (405 kg).

Age: 101 — thanks to being a full conversion 'Borg. The way he's going, he's got another 50-100 years ahead of him.

P.P.E.: 4

Attributes: I.Q. 17, M.E. 15, M.A. 13, P.S. 28 (robotic; does M.D.), P.P. 24 (bionic), P.E. n/a, P.B. 12 (bionic with handsome human features of his original face), Spd 90 mph (144 km; bionic).

Disposition: Quiet and reserved. He's more like someone's grandfather, that is, until there's business to be taken care of. Alekseyevna has green-lighted all manner of massacres and atrocities when he's thought they were justified. He is an evil and small man in many ways.

Yuri thinks of himself as a great military mind and one of the most powerful of the Warlords. Truth be told, he is a bit out of step with the times and tends to underestimate the other Warlords, particularly Orloff, Seriyev and Romanov. One of the main reasons he has kept the vast domain of his Sphere of Influence is that nobody else wants it. Warlord Burgasov has considered challenging "the Old Fool," as he calls Yuri, just to get his hands on the valuable mineral resources. However, Burgasov realizes the mostly tundra wilderness region is too vast, desolate and hostile an environment to manage effectively (Warlord Alekseyevna does a poor job of it himself, putting most of his effort in his holdings west of the Urals, and leaving his tundra holdings in disarray. Except for a handful of important mining camps, the rest of the eastern region is constantly troubled by super-natural and D-Bee menaces).

Experience Level: 12th level Dimiye Soldati with assassin skills.

Skills of Note: Radio: basic 98%, intelligence 95%, interrogation 95%, sniper (+1 on aimed shot), literacy (Russian and Euro) 90%, botany 80%, computer operation 98%, pilot: boat: motor and hydrofoils 98%, pilot **hovercycle** 98%, pilot jet pack 80%.

Combat Skills: Hand to Hand: Assassin, W.P. energy pistols and W.P. energy rifles, all at 12th level, and W.P. knife at 8th level.

Attacks per Melee: Seven

Bonuses: +4 on initiative, +10 to strike, +7 to parry and dodge, +6 to pull punch, +3 to roll with punch, fall or impact; Death Blow on a natural 20.

Magic Knowledge: None

Psionic Powers: None

Cybernetics: Full conversion Heavy Machine with a realistic, human looking face. He has all basic features and weapons of the typical Heavy Machine cyborg.

Personal Resources: Roughly 50 million in universal credits, 10 billion credits in diamonds, gold, and jewelry, 500 million in other personal wealth plus the resources of his city, manufacturing, bionics, land holdings, and the War Camp under his Sphere of Influence. Mineral rights are worth untold tril-

ions all by themselves (of course, the trick is finding and getting to them).



Warlord Burgasov

The current Warlord Burgasov began life as Pyotr Karol Ivonavich, an aggressive, military ruler cut from the same mold as Ivan the Terrible. He came from humble beginnings to rise through the Warlord's chain of command one step at a time. At a young age, his ferocity in battle earned him the nickname of "Pyotr the Bear." Nothing seemed able to stop or even slow him down. By age 21, he was an honored War-Knight, by 34 he was Commander of the War Camp and his Warlord's Second in Command.

At age 41, Pyotr became Warlord by decree when the man he loved and served, *Warlord Mikal Burgasov*, chose to grant him the title of Warlord over his own sons. The deathbed announcement was made before all his War-Knights and twenty thousand of his best troops. The dying Burgasov proclaimed that he had always thought of Pyotr as a son, and that he could think of no man better suited to lead the War Camp as their new Warlord. To cement the bond, the Warlord gave Pyotr the Burgasov name and the hand of his youngest daughter, Marianna, whom Pyotr the Bear had been sweet on for years. With his last dying breath, the old Warlord closed by saying, "This not just my will ... but the will of God. Let no man oppose it. If my sons should protest, they are stripped of my name and are to be hunted down like traitorous dogs and killed." With that, he slipped into a coma and died six hours later.

The three sons did protest and joined forces to try to usurp the region once known as *Estonia*. After a three month battle,

Estonia fell to Warlord Burgasov, now nicknamed "The Bear of Moskva." The eldest son fell in battle to Burgasov's Second in Command, a 9th level War-Knight. The other two fled and,

with the sanction of his wife (their sister), were hunted down like dogs and killed by his own hands. To do otherwise, **Marianna** is reported to have said, "is to dishonor the **Burgasov** name and my noble father."

Two years after becoming Warlord, he waged war on a long-time rival, and the man he held responsible for the old Warlord's death, *Warlord Kahzmyr of Arkhangel*. When The Bear of Moskva declared war on Kahzmyr, he publicly announced that he would fight until one of them was dead, and he didn't care who might get caught in the middle and hurt. He then offered to accept into his War Camp any soldier from the Kahzmyr Camp willing to swear allegiance to him. If the oath was true, that man would be accepted as a brother and all past transgressions forgotten. If the oath proved false, that man would be slain where he stood, his village raided and his family killed. As brutal and uncompromising as this may sound, a full third of the Kahzmyr Camp defected! There were four main reasons for the defection. One, "The Bear of Moskva" was legendary as a man of honor, so if he gave his word that all would be forgiven, forgotten and they could serve him **with** honor and prestige, they knew it was true. Second, most believed that unless he was killed early on, Warlord Burgasov would fight like a demon, destroying everything in his path until he had the head of Kahzmyr on a pike. Third, The Bear of Moskva had also declared that those who did not take this offer now, and chose to stand against him, would see no mercy from him later, and would be slaughtered like cattle. Fourth, most thought Burgasov would ultimately win.

The war between these two rival Camps lasted five years, but when it was over, Warlord Burgasov stood triumphant (minus an arm, but triumphant nonetheless). It was the warriors of the Kahzmyr Camp and the people under his Sphere of Influence who suffered terribly in this conflict. Virtually every last Kahzmyr Cyborg **Shocktrooper** and War-Knight was hunted down, tortured and executed; often torn to pieces and their bionic components reused. Towns and villages loyal to Warlord Kahzmyr were raided of everything of value, their people beaten and raped, and then the villages razed to the ground. Those who so much as raised an angry eye were executed where they stood. What they did and where they went after the carnage was of no concern to the Warlord and his troops. In fact, most people were scolded and told to be thankful of Warlord Burgasov's mercy, because most other conquerors would have killed them in their beds.

Once the bloodletting began, Warlord Burgasov would accept no surrender. "They had their chance and turned it down. I have no mercy for them now," are his famous words in response to one of his lieutenants who had just questioned an order to slaughter 8,000 Kahzmyr Reavers who had laid down their weapons and surrendered. To his credit, the young War-Knight who questioned the order was not punished, an example of Burgasov's sense of honor and loyalty, hand in hand with his inhumanity and cold-hearted resolve. To Burgasov's way of thinking, it would have been a slap in the face of those who defected to his side if mercy were now shown to those who had fought against them. To him this was not an act of cruelty or savage **retribution**, but keeping his promise. He had warned that those who would stand against him would be shown no mercy and slaughtered like cattle. He was only keeping his solemn word. Such is his twisted code of honor.



Today, "The Bear of Moskva" is 54 years old and the loving father of three daughters and two fine sons. He is a giant of a man, towering six feet, eight inches (2 m) even before bionic augmentation. Warlord Burgasov is a partial cyborg with two modular bionic legs, and a bionic arm as a result of war injuries. When at home with his beloved wife, he has his mechanical bionic limbs replaced with lightweight, artificial limbs that look and feel like real flesh and blood. But when on the field of battle (which is more often than his wife and children would like), he substitutes them for the heavier, more powerful bionic limbs and makes no effort to conceal their nature. Warlord Burgasov also has a reinforced spine, skull and hip, bionic heart and lungs, and a handful of concealed cybernetic implants. He wears heavy body armor (not cyborg armor) into battle, and is constantly surrounded by four Cyborg **Shocktroopers**, four Heavy Machines and six War-Knights (and secretly, a pair of Smoke Soldiers) who guard his back and watch his every move. All 16 (mostly aberrant alignments) will give their lives to protect his, as will many of his elite legions of warriors.

He is known for the strict enforcement of the letter of the law and harsh punishments for those who break the law or defy him. "The Bear of Moskva" is a tough, hard-line, military man who brooks no nonsense and demands fear as well as respect. He has earned both among his troops, because he leads by example and is in the center of most major battles, side by side with his men. This is very much the style of the man who ruled before him, and taught "The Bear of Moskva" much of what he knows. His larger than life presence, fierce loyalty to his troops, glorious accomplishments, and strict discipline have made him the leader of the largest, arguably most powerful, and certainly the most ruthless, army in Russia. His troops are composed of gung-ho warmongers who feed on the excitement, power and glory promised by their lord. Together, the Warlord and his troops have waged some of the most brutal and bloody campaigns to rid Mother Russia of supernatural forces.

To his troops and many people in his northern Sphere of Influence, Warlord Burgasov is a hero. To the people of the **Sovietski** and most of the other Warlords, he is a man to be feared. They recognize that the Bear of Moskva is ambitious, aggressive, and a man who knows no boundaries. This makes him dangerous in the extreme.

The Throne of the Empire

Warlord **Burgasov's** main base of operation is **Novgorod**, a city of 147,000 with several medium-sized villages (300-1000 inhabitants) and farmland around it. It, along with Pskov, Tartu, and **Navhetsk**, are all industrial towns (with populations of 32,000, 11,000 and 17,000 respectively) within 100-200 miles (160-320 km) of each other. These are the manufacturing centers for Warlord Burgasov's Cyborg Shocktroopers, bionics and weapons. Between them are tiny and small villages, and farms interspersed among woodlands. Estonia also has several cattle ranches and numerous farms.

City Population: Approximately 176,000 in Novgorod.

The overall population of his Sphere of Influence (including the main city) is probably close to three quarters of a million; a quarter million living in the small northwestern region of Estonia alone. This is one of the most (and we use the term loosely) civilized parts of Russia, with large areas of cultivated land for farms, cattle and livestock, coastal fishing and a region where

Warlord Burgasov has destroyed or chased away the demon hordes and marauding monsters; a true rarity in Russia and very attractive to settlers.

Farther east, toward *St. Peter's Spine*, the region becomes more of a dangerous region where gargoyles and other supernatural creatures roam in greater numbers. About a hundred miles (160 km) south of the volcano that was once St. Petersburg (Leningrad) is *Novgorod*. This close proximity to the volcano chain puts the city in some danger from them but it is more centrally located in Burgasov's Sphere of Influence. It has also made him painfully aware of the gargoyle occupation of the volcano region. Only he seems to appreciate the growing danger from the gargoyles at St. Peter's Spine. Never one to procrastinate, he and his War Counsel have developed several plans of defense against a Gargoyle **invasion**, have increased patrols in the region, as well as reconnaissance and seek and destroy missions, and are currently conducting a feasibility study for a campaign of extermination into St. Peter's Spine and the Kola Peninsula (probably the next land to conquer and make his). However, he first needs to have a clear picture of the situation and make sure his War Camp is prepared for the task. He fears (and rightly so) that his Camp may be outnumbered, although not outgunned.

War Camp: 98,000 troops; the largest in Russia. Furthermore, he could easily rally another 10,000 in a matter of days. More than that would be difficult.

Colors: Silver, Red and Brown

Symbol: The Bear Claw

Cyborg Shocktroopers: The Butcher and Ripper.

Customs: Ritual Tattooing: Reavers of Warlord Burgasov's Camp often (75%) have bear claws tattooed on their chests and shaven skulls.

Conduct: Well disciplined, cold and efficient, sometimes brutal, letter of the law soldiers. Most of Warlord Burgasov's troops conduct themselves with enthusiasm, dedication and military professionalism — they are crack troops.

Living **Conditions/Lifestyle:** For the most part, pretty good. Burgasov's military bases are well-stocked with everything but entertainment materials (he believes that such things make a person weak-willed, and are to be suspected).

Level of technology: Early to late 20th Century in most cities and large towns, although paved streets are a rarity and modern conveniences rapidly disappear as one moves away from the cities (those are about 17th Century equivalents).

Alliances: None, although the Burgasov Camp does some trade with the Sovietski, Poles, and Warlords **Seriyev**, Romanov and Old Man **Alekseyevna**. Warlord Burgasov considers **Alekseyevna** to be a complacent, arrogant, tired, old fool well past his prime but too stubborn to die. He's considered invading the Old Man's Sphere of Influence, but knows he could not manage or hold onto it all, not that the Old Man is doing well with it himself. The Burgasov Camp frequently disregards border boundaries and both Camps raid each other for sport and to rattle each other's cages.

Burgasov sincerely likes Warlord Seriyev, but doesn't trust him for a minute. He sees a noble warrior in Warlord Romanov, but believes her idealism and desire to become "civilized" is her weakness, clouds her judgement and will hold her back from achieving the greatness that could be hers if she only gave in to

her warrior's heart. "The Bear of Moskva" has no doubt that one day, his Camp and the **Orloff** Camp will come to war. He recognizes Warlord Orloff as a power-hungry lunatic who will destroy himself. The question is, how many will he take down with him when he falls? Whenever the Orloff Camp raids his territorial holdings, "The Bear of Moskva" is quick to retaliate, striking hard and without mercy, for if Orloff senses weakness, it will encourage more raids and provoke thoughts of invasion.

Note: The scars from the invasion of *Warlord Kahzmyr's Sphere* are only a decade old, and still sting with hate, anger and thoughts of mutiny. This means some degree of **dissension**, disloyalty and rebellion on the part of the people in the northeastern part of his Sphere of Influence. Warriors from the **Kahzmyr** Camp who escaped the purge years earlier, have joined mercenary outfits and bandit gangs, or now work for the Black Market or rival Warlords. They take great pleasure in targeting the **Burgasov** Camp, villages and cities for raids, sabotage, vandalism and mischief. Others have formed small bands of rebels, mountain guerillas who extract what retribution they can. Some will even go so far as to consider an alliance with supernatural evil to make Burgasov pay. That's how well liked Warlord Kahzmyr was and how hated Warlord Burgasov is. Literally thousands from across Russia and neighboring regions in Europe and the Orient, lost **friends**, family and loved ones in what they call, "The Bear's Feast of Blood." An act that is likely to haunt and hound Warlord Burgasov till the day he dies.

Pyotr Karol Burgasov

Also Known as "The Bear of Moskva" and "Peter the Bear."

Race: Human, partial conversion cyborg.

Alignment: Aberrant

Attributes: I.Q. 14, M.E. 17, **M.A. 22**, P.S. 22 (real right arm)/24 (bionic left arm), P.P. 18, P.E. 21, P.B. 9, Spd. 65 (bionic: 44 mph, 70 km).

Hit Points: 73, **S.D.C.:** 42

M.D.C.: Bionic legs: 80 each, Bionic arm: 40, main body (reinforced skeleton and such): 27 M.D.C.

When going into battle, Warlord Burgasov will either wear heavy, environmental armor (100 M.D.C.), or Light Cyborg Armor (140 M.D.C.), and is protected by his elite guard of four Cyborg **Shocktroopers**, four Heavy Machines and six War-Knights all ranging from 6-10th level (and **secretly**, a pair of 7th level Smoke Soldiers).

Weight: 350 pounds (159 kg)

Height: 7 feet (2.1 m)

Age: 54

P.P.E.: 2

Disposition: Warlord Burgasov is a warrior-knight whose mind is always on the next military campaign (in this case, the battle for St. **Peter's** Spine and the invasion of the Kola Peninsula). At the same time, he knows he must not spread himself too thin or he will only encourage the insane Warlord Orloff to launch an attack or entice supernatural foes to renew their campaign against him.

"The Bear of Moskva" is only really happy on the field of battle, solving military problems or developing new strategies. He has an analytical mind, is an excellent tactician and strategist, and a strong, charismatic leader. His troops are loyal to him and many worship him like a god. Unfortunately, they also follow his example of savagery, brutality,

and **cold-heartedness** against the enemy. "Better safe than sorry," translates for these soldiers into "crush the enemy completely. And be careful, because mercy can get you killed." There is absolutely no mercy for demons, supernatural beings, monsters and those who worship them. As a mobile **army**, Burgasov and his War Camp may be the best and most seasoned "monster slayers" in Russia.

Experience Level: 10th level War-Knight.

Skills of Note: Basic math 98%, literacy: Russian 80%, radio: basic 98%, radio: scramblers 98%, military etiquette 98%, detect ambush 98%, intelligence 98%, find **contraband**, weapons and cybernetics 90%, boxing, climbing 98%, **cardsharp** 55%, computer operation 60%, horsemanship: knight 98%, pilot: motorcycle 80%, pilot: jet pack 98%.

Combat Skills: Hand to Hand: Martial Arts, W.P. axe, W.P. energy rifles, W.P. energy pistols, W.P. heavy energy weapons, W.P. knife, W.P. **spear/polearm**, paired weapons, jump kick (critical), critical strike on an unmodified 18, 19 or 20, death blow on a natural 20.

Attacks per Melee: Seven (includes all bonuses).

Bonuses: +6 on initiative, +4 to strike, +5 to parry and dodge, +4 to roll with impact, +4 to disarm, +8 to pull punch, +2 to save vs possession, and +6 to save vs Horror Factor.

Magic Knowledge: Lore only.

Psionic Powers: A major psychic with 59 I.S.P. and the powers of total recall, see the invisible, sixth sense, summon inner strength, impervious to poison, and mind block.

Cybernetics: Partial conversion Light Machine (70%) with a real human face (his unmodified original), a real right arm, upper torso, and lower abdomen. He has all basic features and weapons of the typical Light Machine cyborg, plus **cyberlink**, **fingerjack**, headjack, type AA-cyber disguise, wire **garrote**, palm laser torch, and interchangeable parts (legs and left arm).

Personal Resources: Roughly 100 million in universal credits, 2.1 billion credits in personal wealth and liquid assets, plus the vast resources of his Sphere of Influence, cities, manufacturing, bionics, land holdings, and War Camp.

Warlord Burgasov likes to wear modernized Tsarist-Period clothing; trousers worn loosely over boots, a plain wool or cotton shut and an embroidered wool tunic. Add to that a fur hat, fur cape and coat in cold weather, or a well-worn jacket in warm weather.

Warlord Kolodenko

Stephan Ilyavitch Kolodenko is the Mountain King. He is the third Kolodenko to hold the position of Warlord, and may be the best since his grandfather. The Kolodenko Sphere of Influence lays claim to the Caucasus Mountains and surrounding lowlands that lay between the Black Sea and Caspian Sea, and borders the countries once known as eastern Turkey and northern Iran. The Kolodenko Sphere also lays claim to southeastern lands including the Caspian Depression, Ustyurt Plateau and **Kara-Kum** desert.

Warlord Kolodenko is something of an anomaly among the Warlords. Although he has an excellent head for strategy, tactics and long-term planning, he is not a dedicated military man. He is more of a king — a bureaucrat skilled at organization and **mo-**

tivating and leading people. This makes him the only genuine statesman and politician in the batch (Romanov is ultimately a warrior, and Seriyev is a combination politician and assassin who has no qualms about going to war if left with no other, less costly alternative). This is not to say that the Warlord is a coward, or can't handle himself in combat, quite the contrary, but he is more cultured, civilized and always willing to consider alternatives to bloodshed.

He was educated in the New German Republic, and is a trained engineer specializing in cybernetics. This also gives him special legal and underworld connections to the NGR and cybernetics manufacturers. There is a small, heavily guarded bionic plant in the southeastern foothills, but it has been rumored for years, that the Warlord has two secret manufacturing facilities in Turkey and/or Romania, as well as several plants in Poland and smugglers along the Russian Border to do out-sourcing and additional manufacturing. Kolodenko also has full design and bionic installation facilities at his two favorite mountain fortresses/palaces. He was pivotal in the designs of the Lynx Body Armor, the White Tiger Cyborg and the Wingrider flying wing. He has held back his latest creation as a secret weapon to use against Sokolov when the time comes. It has been secretly field tested against Sokolov for the last six months. It is a Heavy Machine cyborg that closely resembles the Lynx Body Armor, only bigger and bulkier, designed for quick-strike combat, stealth and underwater capabilities (so they can travel underwater in the Black and Caspian Seas to make surprise strikes). Their colors are grey and black, and they are designated as the "Black Panthers."

Basic Stats for the Black Panther: All standard features of the Heavy Machine and stands 9 feet/2.7 m; 230 M.D.C., plus medium body armor, tri-blade Vibro-Claws on the tops of the hands, a forearm particle beam weapon/knocked-off from Triax, the other arm has a forearm weapon of choice, a six shot mini-missile launcher is mounted high on the back so a detachable jet pack can fit underneath it, a grappling hook and line is built into one arm, retractable magnetic clamp and cord (contained in hip) for hitching rides on sea vessels, and a jet pack or underwater propulsion attachment, plus full audio augmentation. Underwater capabilities: Max. depth: 1000 feet (305 m), underwater propulsion: 40 mph (64 km), +4 on initiative, +2 to strike, +3 parry and dodge or +4 to dodge underwater, +4 to disarm, +2 to pull punch, +10% to climb/scale walls.

It does bother Warlord Kolodenko that his designs are often stolen and used by other Warlords and manufacturers (case in point, the Lynx armor and Wingrider flying wing), while the designs of the other War Camps are never touched. Of course, this is largely due to the fact that he rules one of the smallest Spheres of Influence and is generally considered civilized, humane and less vindictive than the others; a blessing and a curse. He tries to tell himself that imitation is the sincerest form of flattery, but it still annoys him to no end, and he hates it when his Knights of the Realm have to battle his own designs. Speaking of which, the Kolodenko Camp has the most skilled and experienced Wingrider Pilots in Russia, and the largest fleet of Wingrider Flying Wings, which gives him superior air power, while his Cossacks and mechanized cavalry give him one of the best ground forces. He has kept hold of his little empire for a reason.

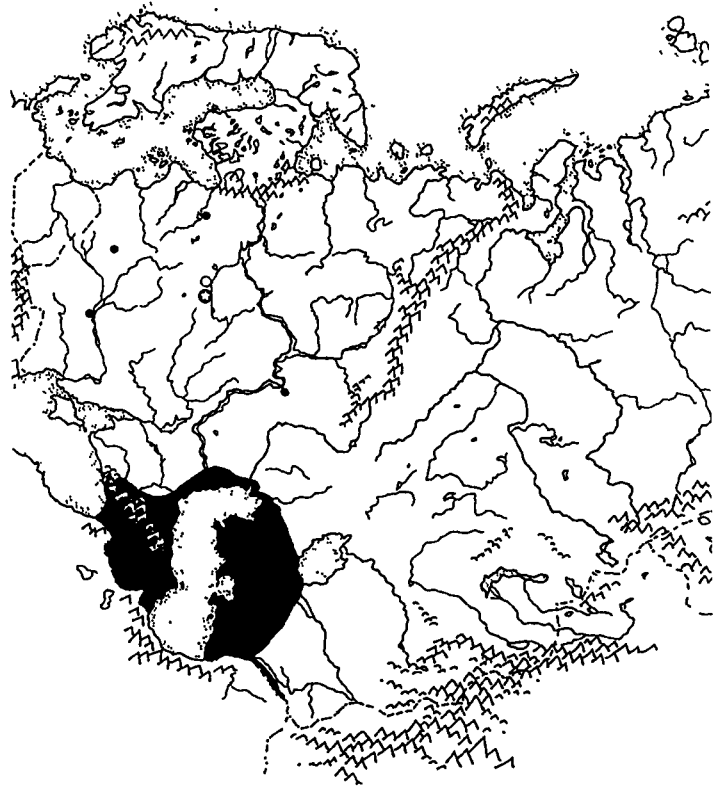

The Throne of the Empire

Warlord Kolodenko rules over his Mountain Kingdom from a series of three large, modern fortresses. The Caucasus Mountains cradle hundreds of small villages, towns and castle-like keeps in lush mountain meadows and forested valleys. Farming is excellent in the foothills, and even places up in the mountains, but among the peaks, sheepherding is the predominate occupation of the villagers. Mining and lumber camps also contribute to the overall economy. He has also quietly established a few mining and oil drilling operations in the desert with startling results. If not for the fact that there is no direct trade route to the NGR, other than through monster infested lands and the Gargoyle Empire, he could establish political and trade relations with the NGR and Poland.

The typical village is small, with 100 to 200 people; a medium to large village will have 400-1000. The main occupations in the mountains and foothills in the north and south are farming, raising livestock (mostly sheep and goats, but some cattle in the lowlands and meadows), the wool trade, hunting, trapping/fur trade, mining, lumber and crafts. To the northwest and southeast where the mountains give way to seas, there is also fishing and boat making.

City Population: The largest of the mountain fortress strongholds is *Windshorn*, his second favorite and most heavily fortified and defended stronghold in the northwestern mountain peaks. The population is approximately 56,000, with numerous villages around it for another 4,100 people. The next largest stronghold is *Stone Haven*, with 27,000 residents and then *Meadowspire* (his favorite), with 13,000 residents located in a lush mountain meadow and near three others; surrounded by farms and sheepherders.

Overall population of his Sphere of Influence (including the forts): 129,800.

War Camp: 26,000 troops, the smallest in Russia, but among some of the best trained. An estimated 40,000-50,000 Cossacks would come to his aid within 48 hours, and another 40,000 within a week (**Kolodenko** isn't aware of this himself; he'd guess 20,000 total). Furthermore, depending on the circumstances, he *might* get some aid from Warlord Romanov.

The Kolodenko Camp: The makeup of this Warlord's Camp is so different from the norm that it's worth showing the troop breakdown.

- 0.3% Soldati Dimiye/Smoke Soldiers
- 10.7% Wingriders
- 12% Cossacks
- 4% War-Knights
- 15% Soldati/Soldiers
- 20% Cyborg: Shock Troopers
- 10% Cyborg: Heavy Machines
- 11% Cyborg: Light Machines
- 10% Reaver Mechanized Cavalry
- 6% Other Reavers
- 1% others (mostly practitioners of magic)

Colors: White, Silver, and Black.

Symbol: A Leaping Tiger

Cyborg **Shocktroopers:** The White Tiger (and held in secret reserve, the Black Panther).

Customs: Daring mechanized cavalry, insanely daring Wingriders (the elite of the elite in the Kolodenko Camp) and wearing of the Lynx body armor as a standard uniform of the Soldati and Reavers (except they have a different color scheme).

Conduct: Extremely well organized and well armed, with strong supply-lines and communications even with the farthest mountain or desert outpost. The men are fairly well disciplined, extremely loyal to their Warlord, but outwardly gregarious, self-confident (and confident in Kolodenko), wild, exuberant and insanely daring. Like their Warlord, they love challenges and enjoy life. The Wingriders and Mechanized Cavalry are the best in the world.

Living Conditions/Lifestyle: Very good, well-stocked with everything they need, plus recreation and entertainment.

Level of technology: The War Camp has state of the art weapons, vehicles, bionics and equipment. The three mountain fortresses are equal to late 21st Century, right down to the hydroelectric power plants! Most villages are roughly 17th to 19th Century.

Alliances: Of all the Warlords, Kolodenko has a strong friendship with the (mostly) **unallied** and independent steppe people, the Cossacks. They share a strong mutual respect for one another, engage in ongoing trade, exchange information and have come to each other's aid on numerous occasions. In fact, Warlord Kolodenko is personally friends with the leaders of almost every major Cossack tribal clan. This is unusual because the Cossacks are leery of all non-Cossacks, and because Stephan Kolodenko is every bit an educated and aristocratic noble. Like his father before him, he shows not the slightest disdain for the Cossacks or their way of life, makes no effort to change them, and warmly embraces them just as they are. Furthermore, he has openly opposed Warlord Sokolov's and Warlord **Orloff's** plans to annex more of the *Steppe Free Lands* as part of their Spheres of Influence. This has earned him the undying gratitude of most



Cossacks (many of whom consider him and his Camp brothers) and the animosity of two of the most vile, vindictive and aggressive Warlords in Russia. However, should these two ever invade the Kolodenko Sphere, they will find themselves also facing the wrath of the Cossack people, and perhaps treachery from within their own Cossack ranks.

Kolodenko and Alekseyevna could care less about each other.

Warlord Burgasov considers **Kolodenko** to be **insignificant**, while Kolodenko considers him to be at least a reasonable war-monger, at least compared to Sokolov and **Orloff**.

Kolodenko also has friendly relations with the Romanov Camp and, to a lesser degree, the **Seriyev** Camp as well. In fact, he finds Romanov extremely attractive, but has yet to voice his affections. The civilized gentleman that he is, Warlord Kolodenko supports Romanov's desire to build a united coalition government controlled by a Counsel of Warlords.

To reach the Spheres of his two allies, Kolodenko and his Camp must travel by sea and air (or land once in the Romanov Sphere) via the Black Sea because he and his War Camp are not allowed passage through the Spheres of Warlords Sokolov or Orloff.

Kolodenko sees Orloff not as a great warrior or powerful military leader, but as a cruel, craven monster who likes to fight, kill and enslave. He has no respect for the monster, but never one to underestimate an opponent, fears his military strength and bestial savagery. He is especially concerned for Warlord Romanov who shares a border with the madman and who possesses rich farmland and high-tech factories that could only benefit Orloff's plans for expansion. Orloff regards Kolodenko as a soft coward taking refuge in his mountains and laying claim to a desert wasteland nobody else wants. To Orloff, Kolodenko is not a Warlord but a boy who'd rather tinker with toys and talk about peace than take what he wants.

Kolodenko's relationship with his northern neighbor, Sokolov, is one of contempt, hatred and extreme tension.

The ongoing war between Kolodenko and Sokolov. The current "peace" between these two War Camps might be better described as an uneasy cease-fire. Frequent raids between the two Camps keep nerves on edge and tensions high. Sokolov is the worse for the wear. His troops are at a disadvantage when raiding Kolodenko's mountain retreats and fortresses and cannot come close to matching Kolodenko's mountain guerillas, stealthy White Tiger Cyborg **Shocktroopers** and Cossacks. They take out their frustration by raiding and sometimes torching villages of farmers and shepherders that dominate the foothills, but there is little satisfaction in it.

Meanwhile, the Sokolov camp suffers from acts of sabotage and guerilla strikes that appear to be the handiwork of bandits and foreigners, but which Warlord Sokolov (correctly) knows is the work of the Mountain King, Kolodenko. Ironically, Warlord Kolodenko (frequently aided and abetted by neighboring Cossacks in the *Steppe Free Lands*, and adventurers who he can subtly direct to cause trouble for Sokolov without even knowing it) is so clever and cunning about his guerilla attacks and strategic strikes, that even Sokolov's own War Chiefs and War-Knights question their **Warlord's** insistence that it is all the work of Kolodenko. Many of these strikes inflict little to no serious damage to Sokolov's War Camp, holdings, or reputation, but are designed to confuse, annoy and pester the War Camp, and as psychological warfare against Warlord Sokolov. Kolodenko is succeeding in both areas, exceptionally well. Sokolov's advisors and War Chiefs are losing confidence in their Warlord because he is becoming increasingly irrational, paranoid and obsessed with Kolodenko; who he blames for every attack and misfortune to befall the War Camp. Things have gotten so bad that the Warlord sees Kolodenko's hand in every-

thing, including things everybody knows he had no (or couldn't possibly have any) involvement in. Sokolov also suspects secret plots and conspiracies even among his own Camp. Depending on his mood, he will accuse and threaten his own men of being in collusion with his hated enemy. One poor RMC pilot who commented on the ingenuity of Kolodenko's designs for the **Wingrider** was imprisoned and subjected to 36 hours of torture by Sokolov's own hand, because he decided the man was a spy (Why else say anything favorable about **Kolodenko**?). This has gotten the knights and warriors of the War Camp into the habit of spitting and cursing the name of Kolodenko whenever it is mentioned, and they never, ever say anything even remotely positive or objective about Kolodenko and his Camp — "**they** are all worthless curs! ... spit ... curse ... spit. Warlord Kolodenko is a coward and fool! ... **spit ...spit.**"

Stephan Ilyavitch Kolodenko

Also Known as "The Mountain King"

Race: Human, and completely human!

Alignment: Unprincipled

Attributes: I.Q. 20, M.E. 15, M.A. 21, P.S. 18, **P.P.** 19, P.E. 14, **P.B.** 12, Spd. 17.

Hit Points: 73, **S.D.C.:** 42

M.D.C.: None

Weight: 180 pounds (81 kg).

Height: Five feet, 10 inches (1.78 m)

Age: 35

P.P.E.: 9

Disposition: Alert, sharp, quick-thinking and attentive, all wrapped around a warm and charming personality. Warlord Kolodenko is intelligent and educated without being showy or arrogant. He genuinely cares about his people and the fate of Russia. Although educated and "civilized," he is decisive and willing to make hard decisions. He loves science and mechanics and enjoys challenges and solving problems.

Experience Level: Effectively a 9th level **Operator/Mechanic** specializing in cybernetics, and a Warlord.

Skills of Note: Basic and advanced math 98%, literacy: Russian and Euro 90%, computer operation 98%, computer programming 90%, radio: basic 98%, radio: scramblers 98%, electrical engineer 98%, mechanical engineer 98%, robot mechanics 85%, aircraft mechanics 65%, military etiquette 98%, climbing 98%, body building, pilot: hover vehicles 98%, and pilot: jet pack 98%.

Combat Skills: Hand to Hand: Martial Arts, W.P. knife, W.P. energy rifles, W.P. energy pistols, paired weapons, entangle, jump kick (critical), critical strike on an unmodified 18-20.

Attacks per Melee: Six (includes all bonuses).

Bonuses: +2 on initiative, +4 to strike, +5 to parry and dodge, +3 to roll with impact, +3 to pull punch, and +2 to save vs Horror Factor.

Magic Knowledge: None.

Psionic Powers: None.

Cybernetics: Gyro-compass, clock calendar, universal headjack and ear implant with amplified hearing (bonuses not included above; +3 on initiative, +1 to parry, +2 to dodge).

Personal Resources: Roughly 100 million in universal credits, 2.1 billion credits in personal wealth and liquid assets, plus the vast resources of his Sphere of Influence, cities, manufacturing, bionics, land holdings, and War Camp.

Warlord **Kolodenko** likes to wear modernized Tsarist-Period clothing; trousers worn loosely over boots, silk shirts, embroidered wool tunics, fur hats, long wool capes and cloaks, wool scarves and stylish leather gloves and jackets. When appearing out in public, but feeling at home and safe, he often wears the light M.D.C. Trapper's armor as shown in the illustration.



Warlord Orloff

Boris **Anatoli** Orloff is without question, the crudest, most sadistic and bloodthirsty of the Warlords. Most consider him a lunatic whose answer to most every problem is to destroy the cause of that problem. His bloodthirsty and murderous ways have earned him the nickname, "The **Snowdemon**," and the fear and animosity of every Warlord. Orloff is the stereotypical, no-holds-barred, barbarian raider with delusions of grandeur and a quest to conquer all of Russia. He is only 29 years of age and hungry for confrontations with anyone and everyone. His past victories against demon hordes and campaign against the Sovietski have already become legendary.

Warlord Orloff is driven by an insatiable lust for conquest. He lives to fight, conquer and subjugate others. Those whom he doesn't crush under his heel, he delights in tormenting and making certain they know he is their master. Orloff is one of those wicked people who only feels powerful and important when he is bullying and hurting others. He has thrown down the shackles of morality and delights in the torture of hostages and spies, and molests and mistreats his subjects. When he speaks of "his people," he honestly thinks of his subjects as his property, and as

such, he does with them as he pleases. Sadly, that includes letting them know that he holds their lives in his hands by cruel, abusive treatment and extreme measures of justice. Warlord Orloff has said many times, "The peasants must know that I am their master in all things, and they must obey me, or suffer to the point that they may beg for death. Ah, but that's when I let them live, squirming obediently under my boot." A credo he lives by.

Boris Orloff came to power eleven years ago with the untimely death of his father: a tragic hunting accident. Most people suspect that the young Orloff orchestrated the "accident," but none dare to accuse him. The young Warlord confuses fear with respect and believes himself to be the most powerful and respected Warlord in Russia. He aggressively defends his borders from supernatural forces and fellow Warlords, and has been testing the "strength and courage" of his neighbors with frequent raids. He has also been expanding his Sphere of Influence by sending troops (half or more Cyborg **Shocktroopers** and Heavy Machines) into a region, declaring it his and daring them to do something about.

Orloff has stolen 18% of the Sokolov Sphere this way, and has threatened others. His greatest triumph was usurping 25% of what was once the Sovietski territory in a bloody three year campaign. He would have taken more, except the Soviets were finally able to stop him and got the other Warlords to intercede on their behalf. The Soviets agreed to let him keep a sizable portion of the mostly wilderness area he had seized, provided he would sign a **nonaggression** pact (not that it's worth the paper it's written on) and move his army at least 100 miles (160 km) from the new borderline. He agreed only under the combined weight of Warlords **Burgasov**, **Seriyev** and **Romanov** threatening that they would send their War Camps to join in the defense of the Sovietski, unless he stopped, immediately! Orloff made a mental note that his enemies had clearly revealed themselves and that they would pay. On his exit from his conquered lands (and he believed he could have conquered the Sovietski), Warlord Orloff razed to the ground every village in the path of his exit. Thankfully, he allowed the villagers to flee. That was five years ago and it's been driving him crazy ever since, like an itch he can't scratch.

He craves justice and retribution on the Warlords who stood against him and has been testing their mettle with devastating border attacks and increasingly bloody raids into their interiors. Warlord Burgasov has just about had his fill of this "deranged punk," but holds himself from declaring all-out war because such a battle of titans would decimate both regions and leave the winner weak and vulnerable to the "other vultures." And as much as he likes Warlord Seriyev, he knows Seriyev would be the first vulture to feast on their bones. There is one more thing that gives Burgasov pause, he's not sure his War Camp would win. Warlord Orloff may be insane, but he is powerful, driven and utterly ruthless. Worse, it is always difficult to predict what a crazy man will do, which makes him more dangerous than most other opponents.

Warlord Orloff is currently obsessed with taking shots at Warlord Romanov (and still troubles the southern holdings of the Sovietski). Romanov has earned Orloff's animosity more than the arrogant Burgasov, because she not only stood against him with the Soviets, but spurned his offer of an alliance (with hints of marriage) — and no "woman" says no to the great Warlord Orloff.

The Throne of the Empire

Warlord Orloff's main bases of operations are **Donetsk** in the south and **Kurybyshev** in the north (once part of the Sokolov Sphere).

Parts of *Donetsk* look like something out of a science fiction or fantasy movie. Beautiful towers that resemble the Russian onion bulb churches and towers, only elongated to be tall and narrow, rising from the heart of the city. This expansive area is enclosed by sleek M.D.C. walls 30 feet (9 m) tall. A monorail system links many of the towers and there are wide streets for ground transportation. Unfortunately, the streets are cracked and filled with potholes from years of neglect, and the buildings show signs of abuse and poor maintenance. Mounted awkwardly on the top of the wall are gun turrets and bunkers of inferior design and workmanship — clearly additions to the original design. All around the gleaming city are crude M.D.C. and S.D.C. buildings that expand from the sleek center. Around this crude but expansive addition are shanty towns that run for miles, as well as slaughter-houses, and slums. Beyond that are a half dozen squalid towns of 5,000-8,000 people, and scores of small villages (200 to 600 people). There is also a large area of farmland worked by slaves and patrolled by the Orloff War Camp. Nicer, smaller rural villages and farms are scattered throughout the western half of the Orloff Sphere, especially in what was once the Ukraine.

The original city of Donetsk was destroyed by the Great Cataclysm and the elder Orloff (Boris' father) was a second-rate Warlord who had inherited a failing dynasty. As fate would have it, Orloff's people were joined by an alien race of humanoids who possessed high-technology and some resources of their own. They were able to excavate materials from Donetsk and surrounding ruins to rebuild a section of the shabby community into a superior, modern city. Using parts of their shattered spacecraft, they built a power plant and began, from the center of town, to rebuild.

After experiencing firsthand the terror represented by demonic supernatural beings, the senior Orloff easily convinced them to augment human volunteers with bionics. Against their better judgement, they helped create a cyborg army, and shared the secrets of bionics with their human allies. The senior Orloff and his heir apparent, young Boris, then 16, arranged the slaughter of the well intentioned aliens as they slept — 7,214 were slain. Not a soul was spared. The aliens had served their purpose and were no longer needed. Their intervention gave the Orloff family a new lease on life and an army of advanced cyborgs second to none. The father and son were careful to help direct the design of the Cyborg **Shocktroopers** to reflect their needs and twisted minds. Two years later, young Boris found his father had become just as obsolete as the aliens and killed him so he could become the Warlord. The **rest**, as they say, is history. **Note:** Population: 185,000 in the city proper, another 100,000 in the surrounding shanty towns, and about 11,000 in the outlying regions. Another 34,000 live and work there as slaves (40% D-Bees, 22% captured soldiers from rival War Camps and 38% foreigners).

Kurybyshev looks very much like a medieval fortress city, with large keep-like buildings made of huge stone blocks and thick walls. Even the buildings and factories made of M.D.C. materials somehow appear crude and dirty. The entire place is

dark and ominous looking. About 73,000 people live in Kuybyshev, with an additional 14,000 slaves (50% D-Bees, 18% captured soldiers from rival War Camps and 32% foreigners). One third of the city is a rebuilt section of the **pre-Rifts** city that survived the Great Cataclysm. It was abandoned during the Long Winter and was eventually claimed by Warlord Sokolov. The rest of this northeastern region is dotted with tiny villages, farms, **shepherders** and cattle ranches, and the occasional mining and oil drilling operation.

Overall population is estimated to be around one million, with the majority in the southwestern half.

War Camp: 87,400 troops; the second largest in Russia, with the largest number of Cyborg Shocktroopers; 25-35% of his War Camp are stationed at Donetsk at all times. The city is a fortified camp in and of itself. The troop breakdown is given, because it is a bit unusual; 60% are full conversion cyborgs.

- 0.5% Soldati Dimiye/Smoke Soldiers
- 0% Wingriders
- 3% Cossacks
- 3% War-Knights
- 15% Soldati/Soldiers
- 30% Cyborg: Shock Troopers
- 18% Cyborg: Heavy Machines
- 12% Cyborg: Light Machines
- 17% Reavers
- 1.5% others Practitioners of magic, meres, and others.

Colors: Black on white

Symbol: Stylized fanged serpent.

Cyborg Shocktroopers: The Holocaust and Aftermath.

Conduct: An undisciplined group of brigands, thieves and cutthroats motivated by war and glory. Cold, efficient and ruthless in combat, just like their Warlord. They frequently engage in all types of deplorable conduct during raids and against the enemy, from torture and murder, to raping and pillaging. They



are savage barbarians with little regard for life other than their own. They take what they want, when they want it, even from the subjects in their own Sphere of Influence.

Living Conditions/Lifestyle: In a word, deplorable. **Orloff's** War Camp is fairly well supplied and always has top priority after the city of **Donetsk**, but the rest of the people and communities in his Sphere suffer. There is nothing the people can do, save to pray for some kind of relief with little hope.

Level of technology: When it comes to bionics and the bionic factories (and general facilities) in the heart of Donetsk, Orloff has state-of-the-art technology equal to **Triax**. Outside of Donetsk, technology plummets to 19th Century levels. This is true even of the shanty towns around Donetsk. The villages and farms, like the rest of Russia, function at about 17th-19th Century levels. Most communities are poverty stricken and their people live in fear, not only of monsters, but of their lord and protector, Boris Orloff.

Alliances: This is a short list. Warlord Orloff has a strained and shaky relationship with Warlord Sokolov, despite the fact that he has stolen 18% of Sokolov's Sphere of Influence. Both men are deranged and dangerous, so the old saying about "birds of a feather" is true in this case.

Orloff hates everybody else, pretty much in the following order: Warlord Romanov, Warlord **Burgasov**, Warlord **Seriyev**, the **Sovietski**, the Cossacks, Warlord Kolodenko, and Warlord **Alekseyevna**. He sees Burgasov as his only real threat.

Even the people under his rule fear and dislike Warlord Orloff. However, while they would be glad to see him go, they are too terrified to raise their hand or even a voice against him. This means they will not help his enemies and will immediately report the sighting of enemies, strangers and adventurers in the Orloff Sphere, lest they face The Snowdemon's brutal retribution.

Boris Anatolii Orloff

Also Known as "The Snowdemon," "Orloff the Mad" and "The Butcher."

Race: Human, full conversion Heavy Machine.

Alignment: Diabolic

Attributes: I.Q. 16, M.E. 8 (and crumbling), M.A. 13, P.S. 40 (robotic), P.P. 25 (bionic), P.E. N/A, P.B. 15, Spd 88 (60 mph, 96 kph)

Hit Points & S.D.C.: Not applicable.

M.D.C.: Standard Heavy Machine: 270 Main Body plus another 280 from heavy body armor; Orloff *always* wears heavy armor into battle, often even when relaxing in one of his sanctuaries.

Weight: 1,100 pounds (495 kg)

Height: 11 feet (3.3 m)

Age: 29

P.P.E.: 3

Disposition: Aggressive, wild-eyed, cruel, vindictive, and casually sadistic. He is a cold and heartless fiend who cares only about himself and conquering the world (he won't stop with Russia). Orloff can become incredibly passionate on a number of topics, all of which include craven desires regarding power, conquest, revenge and torture. There is a boyish glee in his voice and a frightening look in his eyes when he speaks about the glorious warriors and heroes of the past and his place among them.

When angered, Orloff becomes a ferocious, wild predator, like a caged animal ready to snap. No one or anything matters when he is angry and he'll lash out at those near him in a frenzy that has left people dead or maimed. He is ruthless and without honor, preferring to make an easy kill through treachery, betrayal or ambush, than fight man-to-man (and is just as proud of his deceitful and cowardly accomplishments as he is of true feats of combat). He is convinced they'd do the same if their fortunes were reversed.

Orloff is insane and has become increasingly sadistic, maniacal and obsessed with destroying his enemies and taking his rightful place as Czar of Russia. It is only a matter of time before he wages war against one or more of the other Warlords, probably with Sokolov at his side.

Experience Level: 8th level Heavy 'Borg and Warlord (with special training as a Warlord and assassin skills).

Skills of Note: Radio: basic 98%, intelligence 95%, interrogation 95%, sniper (+1 on aimed shot), literacy (Russian and Euro) 90%, computer operation 98%, pilot: hovercycle 98%, pilot: jet pack 80%, boxing, horsemanship 88%, intelligence 98%, interrogation 90%, tracking 98%, escape artist 80%, camouflage 85% and military etiquette 98%.

Combat Skills: Hand to Hand: Assassin, and W.P. heavy energy weapons, W.P. energy rifles, W.P. knife, W.P. sword and paired weapons.

Attacks per Melee: Seven

Bonuses: +5 on initiative, +9 to strike, +5 to **pull/roll with punch/fall**, +4 damage, +8 to parry or dodge, +1 to body/flip throw.

Magic Knowledge: None

Psionic Powers: None

Cybernetics: Full conversion Heavy Machine with his real, human face. He has a feral look to him and is ruggedly handsome. His long mane of jet black hair is real too, but the rest of him is cold machine. His eyes are cybernetic implants designed to look exactly like a pair of golden cat's eyes and come with a multi-optic package. He wears his heavy cyborg armor 75% of the time and is always armed with heavy weapons and explosives. He constantly gives off the impression that he's going to attack and lash out at any moment.

Has all basic features and weapons of the typical Heavy Machine cyborg and then some — constantly changing forearm and hand weapons at whim.

Personal Resources: Roughly 150 million in universal credits, 4.6 billion credits in diamonds, gold, and other resources, plus the resources of his cities, alien bionics and manufacturing plants at Donetsk, land holdings, and War Camp under his Sphere of Influence. His mineral rights are worth untold millions all by themselves.

Warlord Romanov

Sonya Tatyana Romanov, also known as "Sonya the Great,"

claims to be the direct descendant of the ancient Romanov Tsarist family line. This is extremely unlikely, but stranger claims have been made. Likewise, nobody knows much about her past. According to rumor, Romanov comes from humble beginnings, an orphan raised by a kind, orthodox priest and the women of his parish in a small village. When she was young (and Romanov confirms this part of the story), she contracted a

fever and nearly died. During her feverish coma, she dreamt of a great Russian palace, like the ones she had seen pictures of in an ancient book. There she met and was embraced by generations of the Romanov family who spoke to her about the past, royal heritage, responsibility, leadership and nobility. They told her she was destined to help lead Russia out of the new dark ages and that she would be a great champion of the people. Finally, they all kissed her softly on the cheek and told her that she was not ready to join them, and that she was to go into the world to make her destiny.

When she awoke, the dream remained vivid and she discovered she possessed psychic abilities (major psionics, most of which she lost when converted into a Heavy Machine). This frightened her adoptive parishioners, who feared she had been possessed while lost in fever. Rather than put them through worry and pain, young Sonya left home to "make her destiny." As a 15 year old, she joined the War Camp of Warlord Kyzanyarsk as a cook and helper to the other women. A Tom-Boy, Sonya (who now called herself Sonya **Tatyana** Romanov) proved to be as strong, fast and tough as most of "the

boys," and was allowed to become a Soldati. However, a War-Knight by the name of Tanya **Kralovsky** recognized her potential, including her sharp mind, resourcefulness and leadership abilities, and took the child under her wing to groom her as a War-Knight. Sonya Romanov made a name for herself as a War-Knight and later endured massive bionic reconstruction and ultimately, full conversion into a Heavy Machine when most of her body was vaporized during a battle with a band of Brodkil and other demons. She had already undergone partial reconstruction and augmentation, so her mentor authorized (demanded) that the heroic Knight be saved. Sonya was grateful and learned to adapt to her new mechanized body.

As she grew into womanhood and rose in prominence among the Kyzanyarsk War Camp, she became a respected leader of the troops and was given tremendous respect by men and women alike. Romanov had also earned a reputation for being honest, dedicated, caring and noble. Consequently, when she accused Warlord Kyzanyarsk of conspiring with necromancers and demon lords, it sent a shockwave throughout the War Camp and among the people. Others had heard the rumors, or sus-



pected the truth, but only Sonya, already known as "the Great," had the courage to step forward.

Warlord **Kyzanyarsk** demanded a retraction. Sonya refused. Traditionally, this means a battle to the death with one of the Warlord's champions, but instead (giving credence to the charges) he ordered her to be executed. However, before his henchmen could make their move, the War-Knights and Shocktroopers stepped in and insisted on the traditional settlement of battle with the Lord's champion. The Warlord recognized that to do otherwise meant open revolt, and agreed. During this Battle for Truth, Sonya the Great faltered, but recovered her wits and slew the champion. This meant facing Warlord Kyzanyarsk on the field of battle.

As is his right, the Warlord denied to give Sonya any time to recover, and insisted that she face him then and there. Battered, bionic weaponry smashed or spent, one **bionic** limb hanging by wires from the socket and whitish-red and green fluid dripping from it, Sonya stood wobbling, but ready.

The War Camp exploded in protest, but Sonya raised her one good arm to silence them.

Barely able to stand, she took her position, dropped her gun and slumped to one knee. The crowd gasped. The Warlord smiled. Sonya fumbled for a new weapon in the pack on her waist belt. Thinking he had a helpless lamb waiting for the slaughter, and in an attempt to look magnanimous, the Warlord laid down his heavy weapons and extended the **Vibro-blade** of his one bionic arm. As he made his approach he addressed the crowd, saying Sonya was no hero but a traitor.

Standing before her his smile grew larger. He raised his blade, slowly and dramatically to cut off her head. The crowd held their collective breath, but Sonya smiled too. Before the Warlord knew what hit him, she had plunged a silver and blue dagger through a chink in his M.D. armor. The blade hung there quivering as she let go and rolled away. The wound was not a death blow to an ordinary man, but the weapon was Sonya's *demon slaying rune dagger*; her most prized possession. And Warlord Kyzanyarsk was no longer an ordinary man. He had indeed made a pact with a demon lord and had become something inhuman and unspeakably evil. The spectators could see this now, as he screamed and writhed in agony. As she passed out, she saw the Warlord (unable to touch her blade without suffering greater damage) lunge at her with murder in his eyes.

It is said that the blast of five hundred energy weapons were fired as one, and vaporized him in mid-leap. When Sonya awakened from the Cyber-Doc's good work, the crowd was chanting her name. When she stepped before them, the applause and cheers sounded like thunder and wouldn't die down enough for her to speak for forty minutes. It is the right of the winner of such a battle to assume the position of Warlord. Any opposed to the ascension in power must face the winner or her champion in combat. Before Sonya the Great could even think about such things, the crowd chanted unanimously in one voice ...

"All hail, Sonya the Great. All swear allegiance to Warlord Romanov."

Life under the rule of Warlord Romanov has improved tremendously. She is a strong, charismatic and compassionate leader, who is very decisive and doesn't let her sense of compassion blind her judgement. She has a powerful sense of **honor**,

justice, and what's right and wrong. Her strong support among the War-Knights, Shocktroopers and other Knights of the Realm keeps her Sphere of Influence one of the most orderly, law-abiding and happy regions in the country. She shares the wealth with her subjects and strives to bring peace and prosperity to everybody under her rule. This and Warlord Romanov's selfless heroism have won her the love and loyalty of most of her subjects, and the disdain of her rivals. Male chauvinists criticize her for being weak and idealistic, but there is no denying she runs a smooth operation, and has successfully rebuked everybody who has tried to invade.

She admits she is an idealist who dreams of a united Russia under the firm, even-handed rule of a Counsel of Warlords. She has tried to launch such an undertaking, but can't even arrange a meeting. Only her friendly neighbor **Seriyeve** and her distant supporter, Warlord **Kolodenko**, take her suggestions seriously. The Sovietski is also supportive, but wishes to remain a (reasonably) neutral, independent party. Unfortunately, as long as there are power-hungry **warhorses** like Burgasov and **Alekseyevna**, and lunatics like **Orloff** and Sokolov, her dream has no hope of becoming reality.

Warlord Romanov's goal is to free the Russian people from the tyranny and horror of the demonic invaders and nightmarish monsters that plague all of Mother Russia. This goes hand in hand with bringing Russia into the "modern age," educating its people, and restoring Russia to its former greatness. She is also avid about preserving as much of history as she can, and learning from her forefathers' past mistakes. Of course, these are long-term plans, and Romanov knows it will be generations before they will even begin to realize any of her dreams (if ever). Her more immediate and realistic goal is to simply build a solid power base and rid her own monster invested lands of supernatural evil.

She is a reasonably educated woman, and resourceful and intuitive enough to realize the power of economic supremacy. To this end, she has initiated an economy far outstripping her predecessor and anything any of the other Warlords have in place. The fact that her Sphere of Influence has always been a manufacturing center and equipped with machinery, factories and resources, has only helped her move that much more quickly to complete economic independence. One independent business (under her patronage and guidance) is the quickly growing and infamous **Novyet Industries**. This company sells its vehicles and wares to the other Warlords, (and has a massive contract with the Sovietski (who is more and more coming to regard the Romanov Sphere as a trustworthy ally), as well as selling to mercenaries, adventurers and other "independents." But most impressive is the fact that the Sovietski invited Novyet Industries to build two, independent, Romanov sanctioned factory complexes in New Moscow itself, which prompted Krakow to do likewise. Sales and trade to foreign countries, particularly Poland, have skyrocketed. And the quality designs and reliable products have even captured the notice of **Triax** and the **NGR**. Of course, a sizeable percentage (25%) of all sales and profits (33%) goes to the Romanov Sphere.

This powerful kingdom also has a strong agricultural foundation with enough cultivated lands and livestock to sell and trade to others, most notably the Sovietski, Seriyev Sphere, and Poland.

Warlord Romanov is a striking woman. As a Heavy Machine, she is like an Amazon warrior, towering ten feet (3 m) high, with a noble and regal air about her, while radiating confidence and power. She has long, jet black hair and sea green eyes (both are multi-optic system eyes but look real).



The Throne of the Empire

The base of the Romanov Sphere's power, economy and culture is **Kiev**, arguably the most progressive, powerful manufacturing and cultural center in Russia. On its current course, it will quickly surpass the Bargasov Sphere and is already the equal of the Sovietski in law and order. It is a boom town that is growing in fame, power and population exponentially. The open-mindedness and **freedom** allowed by Romanov is unparalleled by any of her contemporaries, with the possible exception of **Kolodenko**. The inner part of Kiev (and the most modern and industrialized) is fortified, but the city is growing too fast to keep up with, so towns and villages that seem like just another branch of the sprawling Kiev metropolis merge and meld into one another all around the original center. An estimated 261,000 people inhabit Kiev (although these numbers may be short by 10-20%), with another 30,000 living in farming communities and small to medium-sized villages within the surrounding 60 mile radius. For Rifts Russia, that is practically unheard of.

The tech-level at **Novyet**, bionics facilities, medicine and the center of industry at Kiev are only a decade or so below the CS and a generation behind Triax and the NGR. However, things drop to about **mid-20th** Century and then to **19th** Century levels when talking about the rest of the Kiev region and other big towns and cities in the Sphere. Even at Kiev, only 36% of the homes and 63% of the businesses have indoor plumbing and electricity, and only 12% of the roads are paved. About 25%, mostly business people and leaders, are literate.

However, Warlord Romanov makes her home in the comparatively quiet, small city of **Kharkov** (population 28,000; tech

level, 18th to early 20th Century). Here she has built her "Winter Palace." The place looks as though it were yanked right from the era of *Catherine the Great*, and set down in a different time and place. The inside is filled with precious artwork (most of it, sadly, post-Rifts, but brilliant nonetheless), statues, tapestries and intricately carved furniture. Sonya's love of religious Icons has led her to create a special room just for them. Outside are grand, neatly manicured gardens, and fountains. The Warlord spends as much time as she can in the palace, but unfortunately, it is not as much as she'd like, as duty calls her away all too often. **Note:** Always thinking about the welfare of others, she built the palace some 200+ miles (320+ km) away from **Kiev**, so as to not make that growing haven of civilization too tempting a target to pass up by her enemies.

While there are a few other small cities (12,000-28,000 people) and towns (1,000-5,000), the majority of the Romanov sphere is wilderness, with tiny **villages**, farms and families scattered throughout. The average level of technology in these places ranges **from the medieval to 19th** Century.

The overall population of the Romanov Sphere of Influence is estimated to be under two million, probably around 1.6 to 1.8 million, with the majority in the southwestern portion.

War Camp: 75,800 troops

Colors: Gold and Purple

Symbol: Two crossed swords with a dove floating above them.

Cyborg **Shocktroopers:** Avenging Angel

Customs: Romanov's soldiers have a number of customs covering various situations.

- **First Battle:** Providing the individual(s) lives through it, a small ceremony is given in the tent of his commanding officer, followed by a night of unrestrained and besotted merriment and dancing.
- **Blood Vengeance:** When wronged by another soldier or Reaver, the offended individual may demand Blood Vengeance. This pits the two against one another in a fight to draw first blood (not to the death). A number of Blood Vengeance fights have ended in fatalities, but it's not a common occurrence.

Conduct: Extremely good. Most Knights of the Realm under Warlord Romanov are well disciplined, courteous and respectful of others. They are highly skilled and extremely professional soldiers, even the Reavers. Thus, they are a welcomed sight in the villages they patrol. Commoners feel they can approach their protectors and go to them with information and sometimes small gifts of candy, food or drink.

Living Conditions/Lifestyle: The War Camp is organized, well maintained and well stocked.

Living conditions for all people are great in The Romanov Sphere. Housing has been improved, important roads have been cleared and packed, and some have even been paved. Clothing, equipment, food, and factory supplies are all imported from throughout the region. As noted previously, Warlord Romanov spreads the wealth to all members of her realm. Furthermore, many people feel safe and content, and are grateful for that. People are working hard to create their own culture, for they feel they've been blessed with Romanov's rule.

Allies & Enemies: Many are jealous of Warlord Romanov's success. **Orloff** most of all. Thus, she has many enemies and those who would like to see her fall.

As mentioned previously, Warlord Romanov has excellent relations with the Sovietski and Warlords **Seriyev** and **Kolodenko**. She can tell that **Kolodenko** has feelings for her, and she likes him. She **finds** him charming, intelligent and worldly, plus he makes her laugh and he can remind her about the beautiful things in life when her responsibilities and conflicts weigh her down. **However**, she hasn't allowed herself to think about **Kolodenko** in any romantic way. If they weren't separated by such distance, with **Orloff** and **Sokolov** between them, a romance might blossom. As it is ... it's probably not likely.

She sees Warlord **Burgasov** for what he is, old school military, with no room from sentiment, compassion or women. He is a potentially dangerous power, but has never made any serious transgressions against her or her Camp. She respects him, which is more than can be said of **Burgasov's** regard for her.

If Sonya the Great has a weakness or blind spot, it is for the conniving **Seriyev**. She considers him a true **friend** and ally and trusts him far too much. Ironically, while **Seriyev** originally planned on just using **Romanov** for his own ends, he has come to genuinely like her and respects her greatly. In many ways, she epitomizes the things he wishes he could be, but knows he is not. **Romanov** is as close as he has ever had to considering somebody a real friend. Thus, he is an honest and loyal friend to a point, but when push comes to shove, he will (with greater sorrow and regret than he has ever known) turn on her to advance his own welfare — **Sonya** will be shocked by this (for her) unexpected betrayal.

Warlord **Romanov** regards **Sokolov** as a petty, spiteful tyrant, and the stupid lap dog of Warlord **Orloff** who keeps coming back after being kicked for the hundredth time. In and of himself, **Sokolov** is only dangerous to a point. **However**, his strange, masochistic, **off-again**, on-again alliance with Warlord **Orloff** makes him a dog with big teeth who belongs to a mean-spirited master.

She sees Warlord **Orloff** as a demented monster who should be put to an end. She wouldn't mind doing it herself, but knows she isn't likely to win such a campaign. **Orloff's** forces are too many and too powerful. Her Avenging Angels are no match for **Orloff's** legion of Holocaust and Aftermath **Shocktroopers**. Besides, she could never match his savagery and she doesn't want to subject her people to the horrors of war that would be unleashed by this sadistic lunatic. To compound her trouble with Warlord **Orloff**, immigrant families from his Sphere of Influence have been pouring into **Sonya's**. Others come from **Sokolov's** Sphere, as well as unclaimed wilderness regions, and foreign lands. Rather than turn these immigrants away, Warlord **Romanov** has welcomed them into her Sphere. They are told they must follow her laws, live productive lives, try to live in harmony with others, and contribute their fair share of tribute, or they shall be banished, imprisoned, or worse. Those are the only requisites to living in her domain. So far, this has worked well, for there is a lot of good land available and opportunities in the factories, business and trade groups.

Sonya Tatyana Romanov

Also Known as "Sonya the Great"

Race: Human, full conversion Heavy Machine (female).

Alignment: Scrupulous

Attributes: I.Q. 17, M.E. 13, **M.A.** 24, P.S. 35 (robotic), P.P. 24 (bionic), P.E. N/A, P.B. 19, Bionic Speed: 100 mph (160 km).

Hit Points & S.D.C.: Not applicable.

M.D.C.: Standard Heavy Machine: 270 Main Body plus another 280 from heavy body armor; **Romanov** usually wears medium or heavy cyborg armor into battle. When relaxing at her Winter Palace, she will wear silken gowns and robes, imported from the Orient.

Weight: 850 pounds (382.5 kg)

Height: 10 feet (3 m)

Age: 36

P.P.E.: 12

Disposition: She is everything a knight is supposed to be valiant, noble, honest, trustworthy, compassionate, yet at the same time, she is confident, bold, resourceful, clever and quick thinking. She knows her strengths and weaknesses and tries to stay within her limits. She is not intimidated by any man and rarely underestimates her opponents, male or female.

Strict but fair, Warlord **Romanov** is always willing to listen to both sides of an argument, especially if presented in an organized and cohesive fashion. Her experience has taught her that all points of view, no matter how alien to her own, have merit. In quiet times she may be heard to comment on her hope of restoring Russia to its former glory and bringing peace and prosperity to all of Russia. She firmly believes that the soul of Mother Russia still burns in the hearts of her peoples.

Experience Level: 9th level Heavy Borg and Warlord; ex-War-Knight.

Skills of Note: Radio: basic 98%, intelligence 95%, interrogation 95%, sniper (+1 on aimed shot), literacy (Russian and Euro) 90%, computer operation 98%, pilot: hovercycle 98%, pilot: jet pack 80%, boxing, horsemanship: knight 90%, intelligence 98%, escape artist 70%, Lore: Demons & Monsters 90%, Lore: Religion 90%, Radio: Basic 95%, climbing 95%/85%, Russian history 60%, streetwise 61%, and military etiquette 98%.

Combat Skills: Hand to Hand: Martial Arts, Boxing, and W.P. heavy energy weapons, W.P. energy rifles, W.P. knife, W.P. sword, paired weapons, jump **kick**, entangle, critical strike on an unmodified **18, 19** or **20**, leap attack, body throw/flip does 1D6 damage.

Attacks per Melee: Seven

Bonuses: +3 on initiative, +7 to strike, +8 to parry and dodge, +2 disarm, +5 to pull/roll with **punch/fall**, +1 to body/flip throw critical, and +5 to save vs Horror Factor.

Magic Knowledge: None

Psionic Powers: Was once a major psionic, but conversion to cyborg has obliterated all but the following abilities: Total recall and empathy; **66 I.S.P.**

Cybernetics: Full conversion Heavy Machine with her real, human face and natural emerald green eyes, and long brown hair so dark that it looks black.

She has all the basic features and weapons typical of Heavy Machine cyborgs and then some — changes forearm

and hand weapons to best suit the situation. She likes heavy and long-range weapons for serious combat, but prefers the elegance and intimacy of the sword.

Personal Resources: Roughly 500 million in universal credits, 100 million in Rubles (she's trying to reinstate the old currency along with **Seriyeu**), 12.4 billion credits in bionics and industrial trade goods and resources, plus the immense (and growing) resources of her cities, **Novyet** manufacturing plants, land holdings, and the War Camp under her Sphere of Influence. Not to mention the undying love and support of her War Camp and her subjects.

Note: She still has her demon slaying rune dagger; a greatest rune weapon that in addition to its healing and spell casting abilities, can "devour" evil — basically a soul drinker that can devour the life force of lesser vampires, lesser and greater demons, and the fragmented life essences of Alien Intelligences as often as once every 48 hours. Does 1D6x10 to supernatural evil, including witches.



Warlord Seriyev

On the surface, Seriyev appears to be a smooth, suave and sophisticated gentleman. He speaks five languages fluently, collects art and oddities, has amassed a great deal of knowledge concerning western Russia, and appears civil and cultured. He speaks evenly, choosing his words carefully, and never shows much emotion, save perhaps a bored smile or a narrowing of the eyes in anger. Seriyev might be considered an irascible but likeable rogue if he weren't a **backstabbing**, cold-blooded killer. He cannot be trusted one bit, because all he truly cares about is him-

self. He'll do whatever it takes to win or escape, and cheats at everything from cards to love to war. If it serves his purpose he'll frame innocent people, shift blame and betray a confidence or a friend without skipping a beat. Friends and allies are just pawns in his schemes, and as pawns, they are there to be sacrificed to win the game.

He looks at most of his escapades as deadly, high-stakes games. If people get hurt, it's their fault for not seeing it coming, and he cannot bring himself to shed a tear over somebody too dumb or distracted to know when to get out of the game.

Seriyeu is a master of this game of wits, double-dealing and betrayal, but while he loves to win, sometimes the challenge alone is worth the risk. He is a cunning opportunist and confidence artist skilled at using and manipulating others to get what he wants. He is so slick and smooth that no dirt seems to stick on him. Although he is responsible for the deaths of thousands, few can point an accusing finger at him directly. He always seems to have some plausible excuse, explanation, alibi or scapegoat to deflect the blame. A masterful actor, he can make himself seem genuinely surprised, dismayed or saddened by tragic turns of events secretly orchestrated by him.

Perhaps the cleverest of the Warlords in terms of treacherous strategy and subterfuge, **Igor Seriyev** has stolen the land and power he holds by intrigue and skullduggery. He employs more Smoke Soldiers (5%), assassins (6%), and thieves than any other Warlord, and has strong ties to the underworld and the Black Market. His philosophy is: "Life is hard, so let the other guy carry the burden. When he hollers too loud, kill him and find some other fool to carry the load. And there is always one waiting in the wings."

He has sanitized his image these past 10 years by becoming friends and an (apparent) ally with the one Warlord who borders on sainthood and is the most trusted leader in Russia, Warlord Romanov. This sham has lasted for nearly a decade and has been so convincing that some people actually wonder if they had Seriyev pegged wrong from the beginning. Others wonder if the virtues of Sonya the Great haven't touched the assassin's heart to make him change his ways. Seriyev finds this all very amusing and plays his role as the reformed scoundrel to the hilt.

To prove he really is a good guy, he has sided with Romanov on several controversial issues, including supporting her and the **Sovietski** against Warlord **Orloff's** onslaught a few years back. Of course, closer scrutiny of his "noble efforts" will show to the suspicious mind that he has typically backed positions that either helped him (the fall of the Sovietski would have put the insane Orloff on **Seriyeu's** doorstep) or had no real chance of happening, but made him look good. Furthermore, looking into his past (but not too closely lest you join the others in their silent graves) shows that Seriyev's enemies have a nasty habit of mysteriously disappearing or dying **unexceptionally**, often by a mysterious accident or violence.

Unbeknownst to some, Seriyev's secret stock in trade is death and extortion. He has his agents, spies, smugglers, and assassins operating in nearly every corner of Western Russia.

Seriyeu's middlemen and liaisons use cover identities and false trails to cover their connection with the Warlord to sell death as a service. This is done, supposedly, through mercenaries, ex-Smoke Soldiers and independent assassins **unaffiliated** with any of the Warlords — a secret organization of criminals

specializing in blackmail, extortion, kidnapping, framing, robbery and murder. **Seriye**v's killers for hire have been unwittingly employed by Warlords **Alekseyevna**, **Burgasov**, **Sokolov** and **Orloff**, without them ever suspecting they were supporting **Seriye**v by doing so. These secret minions of **Seriye**v also gather inside information that serves their master, and sometimes steal valuables and information, and then blame the person they were hired to eliminate for the crimes — too bad those items were never recovered.

Seriye

v, through his secret network of agents and brokers, also buys and sells sensitive information and trade secrets. In fact, if any of the other Warlords had any idea of how often Seriye

v had his hands in their affairs, he would have been eliminated years ago. That would be a difficult proposition these days, as Warlord Seriye

v has spies, informants and assassins placed in every War Camp except **Kolodenko's**. He also has agents and informers in the Black Market, the Sovietski, **NGR**, Krakow, and select bands of independent bandits and underworld organizations.

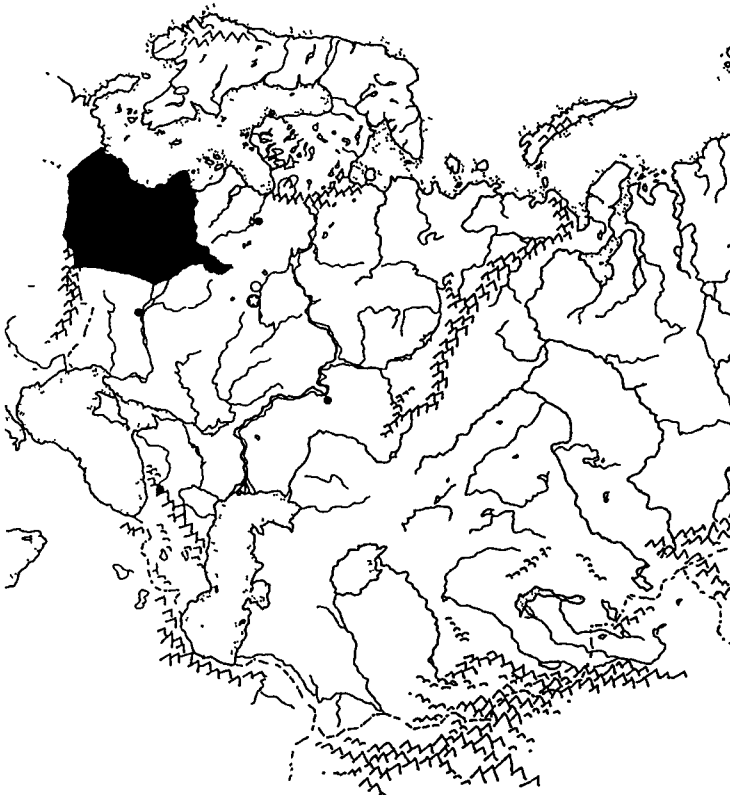

The Throne of the Empire

Warlord Seriye

v rules over his Sphere of Influence and shadow empire from the bustling city of Minsk. It is a pleasant metropolis of 159,000 **people**, with dirt roads, a village-like atmosphere and seemingly low-technology, however, it is fairly modern, with the equivalent of early 20th Century technology with some smattering of **NGR** level technology. Although Minsk has a fairly modern hospital, the only other obvious edifices of advanced civilization are three, sprawling bionics factories. Seriye

v lives a lavish lifestyle in a medieval-looking castle with all the modern amenities one can imagine (including M.D.C. walls, secret passages, and a high-tech sub-basement that looks like something out of a James Bond movie. This is the nerve center for his criminal operations as well as a place to harbor some of his most deadly agents, weapons and equipment).

The typical village is medium to large with **400-1,600** inhabitants. Hundreds of small villages, towns, farms and castle-like keeps are scattered throughout the region. Beyond the forested wilderness, farmland is the dominant feature of the land. Mining outposts, lumber camps and trappers can also be seen. Along the coast (the next largest population center) are farms, livestock and fishing communities.

Overall population of his Sphere of Influence (including Minsk): **600,000**.

War Camp: Officially 36,000 troops and includes two companies of **Wingriders** (about 300), two companies of **Smoke Soldiers**, as well as 8,000 **Mantis** and 2,000 **Assassin Cyborg Shocktroopers**, but this does not include his secret network of **Assassin Cyborgs** (about 5,500), **Light Machines** (8,000), spies, smugglers, thieves and criminals, which adds up to another 30,000 agents. Additionally, depending on the circumstances, he *might* get support from Warlord Romanov and the Sovietski.

Colors: Yellow and blue.

Symbol: A dagger and a rose.

Cyborg Shocktroopers: The four-armed **Assassin Cyborg** and the **Mantis**.

Customs: None to speak of.

Conduct: Extremely well organized and well armed, with strong supplylines and communications even with the farthest outpost (and agent). The men are fairly loyal to Seriye

v, especially while money and good times flow, but may be less supportive if things get rough.

Living Conditions/Lifestyle: Very good, well-stocked with everything they need, plus recreation and entertainment. This is true of his War Camp and subjects.

Level of technology: The War Camp has state-of-the-art weapons, vehicles, bionics and equipment. The Minsk Castle and factory complex are equal to late **21st Century**, right down to a **hydrothermal** power station! Most villages are roughly 17th to **19th Century**.

Allies & Enemies: Warlord Seriye

v's initial intention in winning Warlord Romanov's trust was to use her as both a shield and a pawn to get at his enemies. He has successfully won her trust and ingratiated himself with her. She considers Seriye

v to be a loyal and trusted friend, and has shared with him her hopes and dreams. To his surprise, he has found Sonya the Great to be disarming and enchanting. He honestly likes and respects Romanov and values her company. He has defended her good name (three times in duels to the death) and, in his own underhanded way, has chosen to secretly eliminate some obstacles in her path. While part of **his** support for her has been a self-serving ploy, part of it has been out of a twisted sense of friendship. Publicly, he is a staunch supporter of Warlord Romanov, privately he marvels at her resolve and strength of **character**, and wishes he could be more like her.

Unfortunately, a leopard cannot change its spots, and when forced to take a real stand, he'll do what's best for him. This will probably mean leaving his "friend" hanging in the wind. That's the name of the game. Pity too, because Sonya the Great is usually a better judge of character than this, and can sniff out a fake or cutthroat before he can get close enough to do any serious damage. When that time comes, Seriye

v secretly hopes she may see his true colors before it's too late, and at least roll with

the punch and come up fighting. Funny, when it comes to Romanov, his beloved game isn't fun or worth playing. Too bad he can't make himself throw the game. Winning, after all, is everything.

Warlord **Seriyev's** friendly political relationship with the Sovietski is also to his advantage, so he nurtures it with the greatest of care. However, if they knew he was behind their current crime wave and an active participant in the Russian Mafia, they'd want his head rather than allegiance.

Seriyev has had several business dealings and friendly encounters with the great, "Bear of Moskva" and finds more to the Bear than most people give him credit for. He recognizes Warlord Burgasov to be a very cagey and savvy character who hasn't fallen for the Seriyev charm. The two men like each other very much, and enjoy playing games of cards, but each has sized the other up and has no misconceptions about him. Both avoid conflict and close contact with each other. As long as one stays out of the other's way, they should be fine. The day the fox and the bear cross paths will be a day of carnage.

Seriyev hasn't quite figured out **Kolodenko**. He treats the Mountain King as a friend only because it helps his relationship with Romanov, and because it never hurts to have connections in high places. However, he gets the feeling Kolodenko may be on to him. Warlord Kolodenko is currently investigating disturbing rumors that Seriyev is the head of a criminal cartel with tentacles throughout Russia.

Seriyev has no interest in **Alekseyevna**, except for his diamonds.

There is no love lost between Seriyev and Warlords **Orloff** and **Sokolov**. He knows that both dislike him, but that they fear and respect him, at least a little. Both have hired his assassins and agents on numerous occasions and know just how dangerous Seriyev can be. Neither takes him lightly.

Generally speaking, Seriyev respects those who can beat him at his own game, or at least avoid being taken by him. Such rare individuals are treated with mercy and generosity. Kolodenko may soon be counted among such luminaries.

Igor Seriyev

Also Known as "The Black Knight" and "The Rat of Minsk."

Race: Human. He looks completely human but is a partial 'Borg with one bionic arm, two bionic legs, one bionic eye, an artificial but human-looking face, and a number of implants.

Alignment: Unprincipled

Attributes: I.Q. 20, M.E. 20, M.A. 23, P.S. 18 (human)/22 (bionic), P.P. 19 (human)/22 (bionic), P.E. 14, P.B. 15, Spd. 60 mph (96 km; bionic)

Hit Points: 49, **S.D.C.:** 32

M.D.C.: Bionic legs: 80 each, Bionic arm: 40, Head: 60 and Main Body (reinforced skeleton and such) 22 M.D.C.

When going into battle, Warlord Seriyev will either wear medium to heavy, environmental armor (50-100 M.D.C.), or Light Cyborg Armor (140 M.D.C.). He is usually accompanied by two Assassin 'Borgs and two Mantis.

Weight: 300 pounds (136 kg).

Height: Six feet, five inches (1.98 m)

Age: 34

P.P.E.: 6

Disposition: Cool, calm and collected, even under fire. Resourceful, cunning, and a master of lies and deception.

Skills of Note: Languages: Russian, Chinese, Euro, Dragonese/Elven, and American, all at 98%. Other skills include computer operation, computer programming, computer hacking 71%, palming 86%, streetwise 76%, forgery 91%, disguise 96%, cryptography 98%, radio: scramblers 98%, surveillance systems 98%, tracking 98%, boxing, horsemanship 95%, climbing 98%/88%, wilderness survival 81%, pilot: hovercycle 98%, W.P. knife, W.P. energy pistols, W.P. energy rifle.

Experience Level: Effectively a 10th level Assassin and Warlord.

Combat Skills: Hand to Hand: Martial Arts, W.P. knife, W.P. energy rifles, W.P. energy pistols, paired weapons, entangle, jump kick (critical), critical strike on an unmodified 18-20.

Attacks per Melee: Six (includes all bonuses).

Bonuses: +3 on initiative, +7 to strike, +9 to parry and dodge, +3 to roll with impact, +3 to pull punch, and +6 to save vs Horror Factor.

Magic Knowledge: None.

Psionic Powers: None.

Cybernetics: Gyro-compass, wrist garrote, forearm weapon, retractable **Vibro-Blade**, laser finger (1D4 M.D.), Type AA cyber-disguise (face), clock calendar, universal headjack and ear implant with amplified hearing (bonuses not included above; +3 on initiative, +1 to parry, +2 to dodge).

Personal Resources: Roughly 600 million in universal credits, 5.2 billion credits in personal wealth and liquid assets, plus the vast resources of his Sphere of Influence, cities, manufacturing, bionics, land holdings, War Camp and criminal organization.

Warlord Sokolov

Grigori Levka Sokolov is the proverbial beast at the door. A savage brute who has only known pain and violence his entire life. It's all he understands. Sokolov is a product of his environment (which is not an excuse or justification for the things he does). He was bom into an environment where life had no worth, one had to think on his feet to stay alive, and the odds of living past age 19 were twenty to one. As a result, Sokolov has become a killing machine. He lives by the credo: "If your enemies are dead, they can not hurt you. If somebody gets in the way, you shove him aside. If he complains or raises a fist, you kill him." It's as simple as that.

In a sick and sad way, he gets a thrill from this violence. The only gratification he has ever known is seeing the fear in a man's eyes and the feeling of power when that person submits to his will, or is slain by his hands. To this day, fighting and killing excites him. It's a rush like no other. It doesn't matter if the kill was easy or difficult, it's the thrill that comes with taking that life. Plus the liberating power to know that he has the will, desire and power to do it.

Warlord Sokolov rules over his War Camp and Sphere of Influence in the same manner, and gets the same adrenaline rush when he enforces his will on his subjects. He likes that people think he's crazy and fall over themselves to get out of his path. And he is a crazy man. Those who defy, challenge or fail him

through sloth or incompetence are beaten and killed. Anger him and you put your fate in his blood-soaked hands. Likewise, he actually finds pleasure when people grovel at his feet or beg for mercy, not that he gives any.

He inspires the same brutality, savagery and villainy in the members of his War Camp, attracting the most bloodthirsty and vile warriors in Russia. They enjoy serving under Warlord Sokolov because they are a lot like him and understand and accept his ways, just as he understands and embraces what they are. Do as he says, stay out of his way, and he is happy. When assigned to raids, manhunts, acts of retribution and war, he applauds his troops for their lack of restraint and rewards them for cruelty and wanton destruction. And, so they happily serve him.

Warlord Sokolov knows the other Warlords think of him as an animal, but it makes him laugh, because he is an animal, and because he knows they fear him. He has many enemies who want him dead, and many have tried to put an end to him, but none can seem to get the job done. But then, Sokolov has always been lucky.

Part of Sokolov's luck comes in the way of animal cunning and predatory instincts. He reacts swiftly and without indecision. He also reacts with insane, murderous savagery which often unnerves his assailants. All the while, Sokolov keeps a calm head. Violence, treachery, murder and cruelty is all he's known. He expects it. Waits for it. Thus, he is not surprised when it comes, and knows exactly how to deal with it. All one has to be is faster and more ruthless than other men. Act quickly, kill, and live. That having been said, this monster does seem to have lived something of a charmed life. It is said that **Grigori Sokolov** is "warier than a three-legged fox, and luckier than any man alive." This famous luck was with him when he challenged the former Warlord Constantinus to a duel 35 years ago and won himself the position of Warlord. Nobody thought the brutish psychopath would last more than a few winters, but he has. Nobody thought he could stand up to the **Orloff** clan, but he did, and in so doing, earned some measure of respect and made a strange bedfellow. His bizarre friendship with the equally insane and driven young Warlord Orloff is another example of his uncanny luck, for it is this unlikely alliance that has stopped many from challenging either of these Warlords — while they might be able to defeat one, they could never match their combined power.

Sokolov has come to loathe and fear Warlord Kolodenko, since he has become convinced that Kolodenko is impervious to his luck, and is the one man who can kill him. There is no real logic behind this belief other than the fact that Kolodenko is not so afraid of Sokolov that he won't stand up to him, and that he has bested the madman's War Camp at every turn. The latter has been made possible only because Sokolov is not used to mountain fighting or guerilla warfare. He can't get to Kolodenko in his mountains, and his men, while competent warriors and savage to be sure, are not up to handling Kolodenko's clever and often elaborate strategies and tactics. Basically, it is a situation where a brute is trying to defeat a master of chess by beating his hands on the board and screaming "you can't do that to me" and the Chess Master smiles and says, "but I can, because you're playing my game."

The brilliant and savvy Kolodenko recognizes the psychological impact his War Camp's successes have had on the savage

Sokolov, and has decided to play a dangerous psychological game with the monster. He incessantly taunts Warlord Sokolov by dispatching his best spies, saboteurs, and raiders into Sokolov's Sphere of Influence where they engage in acts of vandalism, sabotage, and banditry, then flee into the night to avoid capture. To Sokolov, it sends the following message:

1. Kolodenko does not fear him, which is unheard of (and not entirely true).
2. Kolodenko has it out for him (true).
3. Kolodenko has turned everybody against him and is sending assassins and conspirators to try to destroy him (not true).
4. Kolodenko is playing with him and can get to him whenever he wants (the first part is true, but the second is not).

These new feelings of helplessness, vulnerability and fear (yes, fear), are driving the unstable Sokolov over the brink of insanity. He sees Kolodenko's hand in every misfortune, and conspiracies, plots and assassins everywhere.

Sokolov was always one of those Warlords who was aloof and avoided frequent contact with his subjects (which is just fine with them). He is even aloof and evasive with his own War Camp, but in recent months he has become somewhat reclusive. His advisors and War Chiefs often find him pacing madly, muttering to himself, or stewed in alcohol and melancholy (another new emotion). Warlord Kolodenko is the subject of half his conversations whether they are rants about imaginary plots and conspiracies, or how much he hates the man and wishes he could get to the coward and wring his neck.

This anxiety and stress has made the Warlord more unreasonable, malicious and intolerant than ever before, resulting in the brutalizing of his subjects, dispatching murderous raiding par-



ties and all sorts of acts of vengeance and violence. Particularly hard hit is the Sovietski and the **Romanov, Kolodenko** and Alekseyevna Spheres, as well as transgressions deep into the Ural mountains and the steppe (Sokolov hates the damn Cossacks) and beyond as far as Mongolia and China — the man is a demon possessed! Sokolov's War Camp has also waged some of the most devastating, genocidal attacks in recent memory. His targets: D-Bees and monsters throughout the region, slaughtering them in droves. Foreigners (suspected as spies) may also suffer Sokolov's vengeance. And all of this blood-spilling is the result of his frustration and temper tantrums because he cannot get to Kolodenko.

A few of the things that are beginning to worry some of the Warlords is that Sokolov's mad, undirected assaults have been extremely effective, putting a hurt on them and his enemies without suffering many casualties himself, and there is no end in sight. More distressing is the fact that Sokolov and his Camp seem to be ignoring established boundaries and truces to do as they will, wherever and whenever *he* chooses. Even some of his most ardent supporters and War-Chiefs are beginning to question the Warlord's ability to lead and fear his unpredictable wrath. Meanwhile, the maniacal Warlord **Orloff** applauds his actions, encourages the mad rampages, and has given Warlord Sokolov and his War Camp free rein throughout his territory. This is also a signal to the other Warlords that Sokolov has Orloff's "unofficial" support. Warlord Orloff has also pronounced that while he doesn't condone his "friend's" actions, they can deal with his ravaging War Bands invading their territory in any way they see fit (as is the way among Warlords). However, they better not set one foot within the Orloff **Sphere**, or there will be hell to pay. Most correctly read this as Orloff using the insane Sokolov to strike at his (Orloff's) enemies without directly involving the Orloff Camp and resources, or Warlord Orloff breaking any treaties, like the one he has with the Sovietski. It is also Orloff's way of daring the other Warlords to raise an army against him, so he has a justification for waging war and invading their lands.

The Throne of the Empire

Warlord Sokolov has no one place he calls home. He is usually away with the major part of his War Camp. He likes to be with his army and takes command whenever he desires. However, when not directly involved with combat, he is secluded from his troops in his private (and heavily guarded) tent or atop his flying throne.

There are, of course, strategic places, such as his cyborg factory, that are protected, and he is extremely territorial about his entire Sphere, even of people and places he doesn't like.

War Camp: 77,500 troops, with 3% being practitioners of magic.

Colors: Blue/Silver

Symbol: Stylized Eagle Claw

Cyborg Shocktroopers: The **Demonfist** and Heavy 'Borgs in general.

Customs: None in particular unless one includes drunkenness and debauchery.

Conduct: An undisciplined group of brigands, thieves and cutthroats motivated by war, robbery and savage release. Sokolov's troops tend to be wild savages on a rampage, but are

surprisingly capable and unrelenting. They frequently engage in raping and pillaging. Savage barbarians with little regard for life other than their own, they take what they want and do as they please, knowing that their Warlord will applaud their efforts.

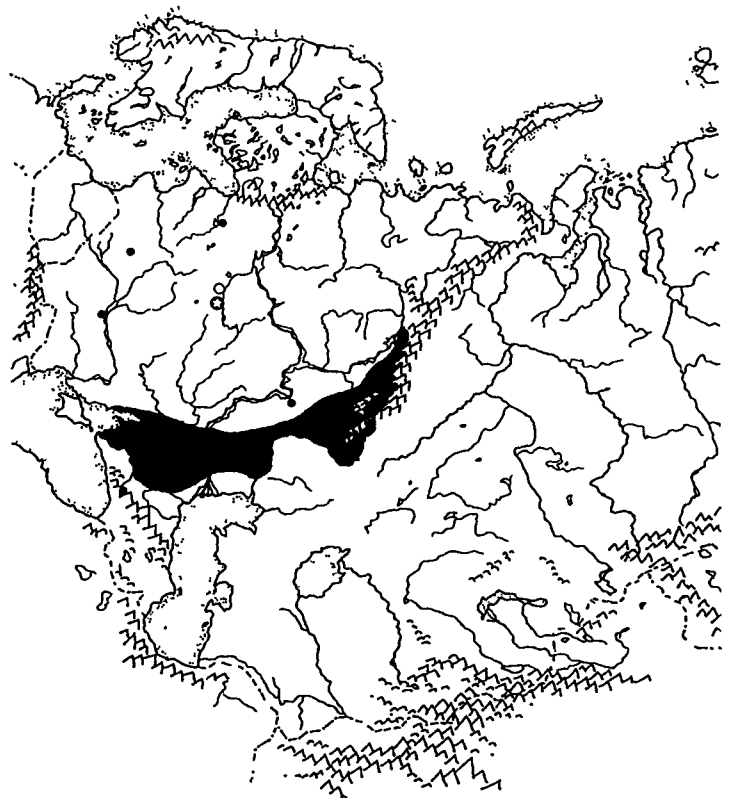

Living Conditions/Lifestyle: Sokolov knows the importance of having well equipped and prepared troops, so he makes a point of taking care of his army. Several of his War-Chiefs are skilled organizers who take care of this for the Warlord.

As for the people living in his Sphere, he could care less about them. He rarely thinks about them and leaves them to struggle through the best they can. The only times they come to mind is when he needs their tribute to finance one of his campaigns. They also come to mind when he needs to vent his anger and needs sheep to frighten and shear.

Level of technology: Sokolov is behind the times. He's used the same Cyborg Shocktroopers for decades without upgrading them and has little concern or need for the trappings of "civilization." He's got everything he needs. Consequently, his Sphere of Influence is the poorest and most backwater; medieval.

Allies & Enemies: Warlord Orloff is the only friend (if you can call him that) Sokolov has ever had. He sees him as his one true ally and is willing to join Orloff in a campaign against the other Warlords even it means sending the members of his War Camp to their graves. For whatever demented reasons, Sokolov is completely loyal to Orloff, even though they squabble and Sokolov occasionally threatens war and conducts raids in the Orloff Sphere. Orloff is the only man Sokolov trusts completely. Warlord Orloff recognizes this and uses it to his advantage.

Warlord Sokolov hates the **Sovietski**, Cossacks, Poles, Ukrainians, and all Warlords, except Orloff. He looks forward to the opportunity to step on their bones. Kolodenko is at the top of his hate list, and is also the only man he has ever feared.

D-Bees and all **nonhumans**, especially supernatural beings, are vermin to be destroyed.

Grigori Levka Sokolov

Also Known as "The Demonfist"

Race: Human, full conversion Heavy Machine.

Alignment: Diabolic

Attributes: I.Q. 9, M.E. 8, M.A. 11, P.S. 50 (robotic), P.P. 24 (bionic), P.E. N/A, P.B. 11, Spd 65 (44 mph, 70 kph)

M.D.C.: A hulking Heavy Machine: 270 Main Body plus another 280 from heavy body armor, with a demonic face plate.

Weight: 1,200 pounds (540 kg)

Height: 12 feet (3.6 m)

Age: 58, but looks to be 40ish; his face is artificial and made to look like he did in his prime.

P.P.E.: 4

Disposition: Mean, vindictive, violent, corrupt, decadent and bloodthirsty; loves war and conflict. A beefy 'Borg, he uses his imposing 12 foot (3.6 m) stature and mean disposition to carry his arguments. Talking to him like an adult is futile because he is incapable of recognizing anyone else as being worthy of his respect. He is loud and arrogant, brash and talkative. Sokolov never keeps his feelings hidden for any reason. When it comes to polite conversation, he is easily bored and actually quite slow on the uptake. He'll speak up even if he doesn't have a clue as to what's going on, often changing the subject in mid-sentence to something else that interests him more.

The bottom-line is this: Sokolov is a predatory monster born as a man and clad in an M.D.C. body built for destruction. He kills without conscience or regret because life has no value to him, even his own means very little. It's all about power, fighting and winning. To be the biggest and best, and to make all others kneel down before him and call him master. Sokolov has always been a murdering psychopath, but is becoming increasingly paranoid, irrational and obsessed with Warlord Kolodenko. His paranoia is a trait which colors his every action. Since he can trust so few, he is constantly vigilant for plots, conspiracies and assassination attempts.

Experience Level: 11th level Heavy 'Borg and Warlord.

Skills of Note: Intelligence 98%, tracking 90%, interrogation 90%, find contraband 80%, speaks Russian and German 98% (illiterate), horsemanship: exotic animals 90%, pilot: jet pack 86%, pilot: hover vehicles, pilot: tank, climbing 95%/85%, cardsharp 68%, streetwise 64%, dancing 85%, pilot: hovercycle 82% and military etiquette 98%.

Combat Skills: Hand to Hand: Martial Arts, wrestling, and boxing. Karate-style kick does 2D6 damage, jump kick (critical strike), entangle, critical strike on an unmodified roll of 18, 19 or 20, paired weapons, leap attack, body flip/throw. W.P. energy rifle, W.P. energy pistol, W.P. heavy energy, W.P. heavy, W.P. sword, W.P. knife, W.P. axe.

Attacks per Melee: Seven

Bonuses: +3 on initiative, +7 to strike, +10 to parry and dodge, +4 to pull punch, +3 to roll with punch, fall or impact, karate punch, jump kick, entangle, paired weapons and is impervious to Horror Factor (special; except from Kolodenko).

Magic Knowledge: None

Psionic Powers: None

Cybernetics: Full conversion Heavy Machine with a realistic, human looking, but artificial face covered by a demonic face plate in combat. He has all the basic weapons and features of the typical Heavy Machine cyborg, and then some. He loves

heavy weapons and has a number of concealed weapons built into him. He also loves magic and has a small arsenal of magic weapons and items.

Personal Resources: Roughly 90 million in universal credits, one billion in diamonds, gold and other resources, plus the resources of his Sphere of Influence, manufacturing plants, land holdings, and War Camp.



O.C.C. Descriptions

Russian Adventurer O.C.C.s

Bogatyr/Hero-Knight
Ectohunter
Explorer
Huntsman-Trapper
Travelling Story Teller
Russian Villager

Warlord Troops

& Men at Arms O.C.C.s

Cossack Reaver
Reaver Soldier/Grunt
Reaver Mechanized Cavalryman (RCM)
Reaver Assassin
Reaver Military Scout
Reaver **Bandit/Raider**
Soldati — Infantry Soldier
Soldati Dimiye or "Smoke Soldier"
War-Knight
Warlord Cyber-Doc
Wingrider RPA Pilot

Cyborg O.C.C.s

Light Machine Cyborgs
Heavy Machine Cyborgs
Cyborg Shock-Troopers
Assassin Cyborg (Seriyeve)
Aftermath (Orloff)
Avenging angel (Romanov)
Butcher Cyborg (Burgasov)
Demonfist (Sokolov)
Holocaust (Orloff)
Mantis (Seriyeve)
Ripper (Burgasov)
Tempest (**Alekseyevna**)
White Tiger (**Kolodenko**)



* CS or NGR RPA Elite (*Rifts® RPG* or *Triax™ & The NGR*)

* Glitter Boy Pilot (only if Japan or *NGR* soldier or merc)

Cyber-Doc (*Rifts® RPG*)

Ecto-Traveler (*Sourcebook 3: Mindwerks™*)

Forger (*Rifts® Mercenaries*)

Gypsies (*Triax™ & The NGR*)

Ley Line Walker (*Rifts® RPG*)

Mind Bleeder (*Psyscape™* or *Africa*)

Mind Melter (*Psyscape™* or *Rifts® RPG*)

Mindwerks Cyborgs (*Sourcebook 3: Mindwerks™*)

Mining Borg (*New West™*)

Mystic (*Rifts® RPG*)

Operator (*Rifts® RPG*)

Psynetic Crazy (*Sourcebook 3: Mindwerks™*)

Rogue Scholar (*Rifts® RPG*)

Rogue Scientist (*Rifts® RPG*)

Saloon **Bum/Stoolie** (*New West™*)

Shifter (*Rifts® RPG*)

Smuggler (*Rifts® Mercenaries*)

Spy: Freelance (*Rifts® Mercenaries*)

Thief: Professional (*Rifts® Mercenaries*)

Vagabond (*Rifts® RPG*)

Wilderness Scout (*Rifts® RPG*)

* O.C.C.s typically found only at the **Sovietski** and the handful of large cities, or as meres and adventurers from the NGR, Japan or North America.

Crazies, Juicers, Cyber-Knights, Dog Boys, Psi-Stalkers, Techno-Wizards, Cowboys, Indians, and most O.C.C.s and people (R.C.C.S) from **Rifts® New West™** and **Spirit West™**, as well as **Rifts® Canada** and **Federation of Magic**, are indigenous to North America and are *not* found in Russia, Europe or Asia. The same holds true of natives of **Rifts® Africa** (with the exception of the Phoenix **Empire**), **Rifts® Australia**, the two **Rifts® South America** books and other distant places; these characters are rarely found beyond their own geographic regions.

O.C.C. Notes

The following O.C.C.s or their equivalents from the **Rifts® RPG** and other **Rifts®** World and **Sourcebooks** are common to Russia.

Assassin (*Rifts® Mercenaries*)

Bandit: Peasant Thug (*New West™*); very common to Russia.

Bandit: Highwayman (*New West™*); very common to Russia.

* Body Fixer (*Rifts® RPG*)

Bounty Hunter (*New West™*); very common.

* City Rat (*Rifts® RPG*); found only in cities.

* CS or NGR Commando (*Coalition War Campaign™* or *Triax™*)

* CS or NGR Grunt (*Rifts® RPG* or *Triax™ & The NGR*);

* CS or NGR Military Specialist (*Rifts® RPG*, or *Triax & NGR*)

* CS or NGR Technical Officer (*Rifts® RPG* or *Triax™ & NGR*)

Other O.C.C.s and R.C.C.S from other *Rifts®* titles may also be suitable

For example, traders, adventurers, mercenaries and monsters from the New German Republic (**World Book 5: Triax™ & The NGR**) and Poland (**Rifts® Sourcebook Three: Mindwerks™**) are likely to be found in Russia — **Mindwerks** offers an array of new critters and D-Bee R.C.C.s, including the *Srrynn Cannibal*, *C'ro Demon Mage*, *Eurotorpid*, *Seeker* and the horrid *Lycanmorph*, among several others. Likewise, characters from the British Isles (**World Book 3: England** and the upcoming **Rifts® Scotland**), and to a lesser degree, The Phoenix Empire (**World Book 4: Africa**) and True Atlantians and the denizen of the **Splugorths' Atlantis (World Book 2: Atlantis)**, and Japan (**World Book 8: Japan**) may also find their way to the expansive Russian Frontier, as well as China, the Middle East and Europe.

Adventurers from **North America** are among the least common people in Russia and Asia (only people from South America, Australia and New Zealand are rarer), but even these characters can be logically introduced to this part of the world. Those with connections to *Triax* and the *New German Republic* (i.e. agents, diplomats, merchants, military advisors, and spies from the Coalition States or Free Quebec) already have a link to Europe and an economic or political reason for visiting. Likewise, characters who live and work in or around the CS or Free Quebec will know about the NGR and will hear about opportunities for courageous adventurers, mages, mechanics and mercenaries in the NGR, Poland, Russia and surrounding regions. Getting there is the biggest problem, but those working for, or who have connections with the CS, Free Quebec, The NGR or Triax will have an easy time of it. Otherwise, dangerous passage across the ocean from freelance sailors (a nice way to work in aspects of **World Book 7: Rifts® Underseas**) or via dimensional Rifts are the characters' only recourse.

Adventuring

“Bogatyr” O.C.C. The Hero-Knights of Russia

Throughout Russian history, there have been *knights* and *heroes* who have fought on behalf of the people and taken a stand against foul gods, demons, dragons, monsters, tyrants and invaders. The Russia of Rifts Earth is no different. Riding out from the anarchy and destruction of the Great Cataclysm are the **Bogatyr**s (or knights) of this new era. They are wandering heroes who dare to defy evil and tyranny wherever it appears, and are always ready to lend a sword and hand to those in need. The Bogatyr may appear atop a mighty steed, a monstrous riding animal from some other world, a motorcycle, hovercycle, or on foot. They may be clad in the armor of a classic knight, or in modern body armor, power armor, or in ragged, make-shift armor that belies their noble occupation. The point is, **some** appear as one might expect a knight to look, while others look pretty ordinary and could be anybody, from a Warlord Reaver or mercenary to a vagabond or peasant traveler. Many wear cloaks and capes that conceal their armor and weapons. Most shrink from fanfare and avoid publicizing who or what they are, preferring to identify themselves only as a "a concerned friend" or a "curious traveler." The fact that the traveler may be a Hero-Knight becomes evident by his or her actions and strong morality and sense of justice.

There is no formal school, camp, order or nobility from which the Bogatyr is molded. The Russian Hero-Knights come from every walk of life, with foreigners and D-Bees counted among their ranks. It is said that one cannot be made into a Bogatyr, but that Bogatyr's are born with the souls of heroes. That having been said, most do spend some amount of time as an apprentice Bogatyr with an established and known Hero-Knight. A master Bogatyr may take on as many as a dozen students at any given time, and some have a continuous troop of knights in training. However, most only accept 1-4, and a few

never teach more than that number in their entire lifetime. This training period typically lasts for 2-8 years before the young knights embark on their own. It is during this period of apprenticeship that the young knight becomes focused and learns, by means of example, **introspection/prayer** and philosophical discussion, the true meaning of compassion, mercy, and nobility. Indeed, the vast majority of Bogatyr's seem to be the living embodiment of these virtues.

Exactly how the Bogatyr's of Rifts Earth came into being is a mystery. According to legend, a boy identified only as Alesha by some, and **Alik** by others (the youngest of 10 children), was raised by God-loving parents who worked the land of a humble farm near the ruins of Kiev. The lad was taught about the Catholic God and weaned on ancient tales about the heroes *Il'ya of Murom*, *Prince Vladimir*; and other knights and heroes of the Christian Age (tales from 800-1700 A.D.). When he became a man, he stood against an evil wizard, and overcame overwhelming odds to defeat the mage and bring about a better life for his family and other people in the region. His acts of selfless kindness and heroism continued and soon, word of his exploits spread across the land. People from faraway regions in the north and east pleaded for his help, and so **Alesha/Alik** grew to become a Holy Knight of Mother Russia. It was not a title he had created, but one he earned through deed and gentle heart. It was a title given to him by the people he served. It is said that all who saw him had little doubt that he was a hero born to greatness. In fact, some claim he was the embodiment of Il'ya himself sent to show mankind the way to salvation. A burning light in the earliest days of the dark ages.

Although probably nothing more than a children's faerie-tale, the story of **Alesha/Alik** has served to inspire some Russians to strive to become knights themselves. In so doing, they strive to live by the high moral standards of **Alesha/Alik** and the other heroes who came before him. In keeping with the traditions supposedly established by **Alesha/Alik**, most Hero-Knights are of Russian heritage (62%) and very religious. All believe in the sanctity of life and follow some religion of one kind or another. About 50% of the Bogatyr's are devout Russian Orthodox Catholics, and the greatest heroes among them are regarded as blessed and holy — to become a "Holy Knight" is the ultimate achievement.

A surprising number of Bogatyr's do not consider themselves to be knights. The most modest will insist they are merely caring travelers who don't do anything that any good person wouldn't do in their place. Of course, this isn't true, for the Bogatyr's are indeed genuine heroes, skilled in the arts of combat, and who travel the land with the intention of smiting evil and lending a helping hand to those in need. They also have a strong sense of justice and fair play, which has earned them the nickname of “**Justicers**,” because they bring peace and justice where their was once turmoil and injustice. Driven to attain legendary nobility, compassion and mercy makes most of these knights truly honorable and well intentioned people. The majority are gentle, caring, selfless, brave and honest.

Unlike the War-Knights or the other soldiers and warriors proclaimed to be "Knights of the Realm" by the Warlords they serve, the *Bogatyr's* are independent heroes who answer only to their own conscience, sense of justice and god. They rarely work for money, Warlord, King or nation. Instead, they fight for

Breaux



what they know is right, and champion the Russian people. The Hero-Knights answer to the greater cause of humanity and Holy Russia, and are concerned only about the welfare of her people. They cannot be tempted with political power, bought, bribed, or blackmailed to go against their beliefs or abandon a cause or people they believe in. This makes them something of a wild card that is a serious problem for demonic influences, ambitious conquerors, enslaving dragons, black-hearted practitioners of magic, evildoers and the **power-mongering** Warlords. Consequently, these forces, the Warlords among them, regard the **Bogatyr**s as troublemakers and dangerous fanatics. However, some Warlords and War-Knights have earned the respect, if not open friendship, of some Bogatyr>s. However, such friendship will not keep a Hero-Knight from standing down when he believes his friend is wrong.

The Code of the Bogatyr

- A man or woman must stand for something greater than himself.
- There is such an intangible thing as goodness. And there are things that must be said and done simply because they are the right and good thing to do.
- The good man may stand alone but others shall follow.
- There can be no greater truth than to be true to that which is right and good.
- He who is true only to himself is only half a man.
- Truth and trust are good.
- Love and compassion are good.
- Mercy is good.
- Forget not these things, for from them springs the clarity of truth, the strength to be merciful and kind, and the courage to do what needs to be done.
- Trust thy heart and let the hand of God guide thee.

The Russian Hero-Knight O.C.C.

Also known as Bogatyr and Holy Knight.

Alignment: Any, but most are Principled (35%), Scrupulous (40%), or Aberrant (10%).

Racial Restrictions: None, although the majority (80%) are human (62% are Russian, 6% Ukrainian, 4% Polish, 4% mixed heritage, 4% other), the rest are D-Bees.

Attribute Requirements: M.E. and P.E. 13 or higher. A high I.Q., M.A. and P.S. or P.P. are helpful but not a requirement.

Psionics: Psionic abilities are not a requirement.

O.C.C. Skills:

- Basic Math (+10%)
- Speaks Russian at 98%
- Speaks two other languages of choice (+20%).
- Lore: Demons & Monsters (+10%)
- Lore: Religion
- Radio: Basic (+5%)
- Piloting: Two of choice, including Horsemanship: Knight.
- Detect Ambush (+10%)
- Land Navigation (+10%)
- Wilderness Survival (+10%)
- Recognize Weapon Quality (+10%)
- Paramedic (+10%)
- Swim (+10%)
- Climb (+10%)

Boxing

W.P. two ancient of choice.

W.P. two modern of choice.

Hand to Hand: Expert

Hand to Hand: Expert can be changed to Martial Arts for the cost of one O.C.C. Related Skill.

O.C.C. Related Skills: Choose **five** other skills at level one and two additional at levels 3, 7 and 12.

Communications: Any

Domestic: Any (+5%)

Electrical: None

Espionage: Any

Mechanical: Basic Mechanics and Automotive only.

Medical: None

Military: Any (+5%)

Physical: Any

Pilot Skills: Any, except robots, power armor, military vehicles, ships and aircraft.

Pilot Related Skills: Any

Rogue Skills: Streetwise only.

Science: Any

Technical: Any (+10%; +15% to art and language skills).

W.P.: Any

Wilderness: Any

Secondary Skills: The character also gets to select two Secondary Skills from the previous list at level one and one additional at levels 2, 4, 6, 8, 12 and 14. These are additional areas of knowledge that do not get the advantage of the bonus listed in parentheses. All secondary skills start at the base skill level. Also, skills are limited as previously indicated.

Standard Equipment: The suit of M.D.C. body armor can be a hodgepodge of homemade armor (30-60 M.D.C.), any modern armor (30-100 M.D.C.), or modern armor made to look like plate or plate and scale armor (60-100 M.D.C. and can be environmental).

Weapons include a Vibro-Sword (2D6 M.D.), and one weapon for each W.P. plus 1D4+2 extra ammo-clips for each. Other items include a survival knife, a silver dagger, silver cross, pocket mirror, gas mask and filter, tinted goggles, hatchet for chopping wood, first-aid kit with extra bandages and antiseptic, flashlight, language translator, lighter, a medium-sized sack, saddlebags, backpack, bedroll, tent, two canteens or water skins, belt, boots, travelling clothes, cloak or cape, notepad, 1D4 markers, 30 feet (9 m) of cord (600 lb./270 kg test strength), and a handful of personal items.

Additional weapons, special items and magic items may be acquired over time (and through role-playing). Friendly *Mystic Kuznya* frequently give or trade worthy Bogatyr>s magical horseshoes, hammers and other items to help them in their work.

Vehicle: Starts with a used and battered looking hovercycle or motorcycle or suitable riding animal. A vehicle will be missing 1D4x10 of its M.D.C. from the main body and look a bit battered, but is in otherwise excellent condition. A Megasteed (monstrous, alien riding animals) or a super-rare Megahorses may be acquired in the future, provided the knight has the required skills to ride them.

Secret Resources: None per se, although with time and travel, they will make friends and acquaintances all over the world. Hero-Knights are highly regarded by Huntsmen, Travelling

Story Tellers, Mystic Kuznya, Mega-Horses and peasants. This will mean influence with the common people and Gypsies, as well as the occasional practitioner of magic and adventurer.

Note: Reavers and soldiers of the War Camps hold a general dislike (and more than a bit of envy and fear) for the independent and beloved Hero-Knights. The fact that most **Bogatyr**s refuse to serve a Warlord, associate with D-Bees and foreigners, and follow their own code of ethics, gives the Warlords and their Camps reason to regard them as dissidents and troublemakers. Members of War Camps who consider themselves to be Knights of the Realm have a bad habit of challenging Hero-Knights to contests, fisticuffs and duels, but don't go out of their way to bully or harass them.

Money: Starts with **1D4x100** credits and **1D4x100** worth of **tradeable** goods. Wealth is of little concern to most Bogatyr, except to use it to help others. Most villages, farmers and wilderness people who recognize the character to be a Hero-Knight will offer him (and often his travelling companions) food and a warm, safe place to sleep. Much to the chagrin of the knight's companions, the hero will usually turn down the best accommodations in favor of modest facilities.

Cybernetics: None to start and avoid them as unnatural. The only cybernetics that the knight may consider are prosthetics and organs to replace severely injured ones.

Ectohunter O.C.C.

The Ectohunter is a ghost hunter and something of a demon slayer. The name is said to originate from **21st Century Psychics** nicknamed Ectohunters, and who warned humankind of the presence of magic and supernatural dangers. The most famous were those who worked for the *Lazlo Agency*, but there were other agencies and investigators as well.

The Eurasian Ectohunters are usually men and women who have had a traumatic encounter with the supernatural. An event, or series of events, that has made them devoted enemies of the supernatural. Some are grim, no-nonsense individuals who take their jobs seriously and think of little else. Others are scholarly and scientific, studying supernatural forces to "better understand the enemy." Some are "**live-on-the-edge**" sorts, while others are self-styled hotshots who like to joke about their opponents and make light of the danger. Still others are the nervous, jittery types, always jumping at the smallest sound and suspicious of everybody. Thankfully, only a minority are obsessed with vengeance and as bloodthirsty, cold and frightening as the creatures they stalk.

Ectohunters are independent operatives who range across Eurasia. While many are natives of Russia, many come from outside Russia and can be encountered almost anywhere in Europe and Asia; particularly, east of the Ural Mountains. Roughly **18%** are Russian, **10%** Polish, **4%** NGR, **5%** Hungarian, **7%** Romanian, **5%** Gypsy, **6%** **Mongolian**, and **20%** Chinese, among others, including **4-6%** D-Bees. They are most common in and around Russia, Mongolia and China, because of the vast number of supernatural monsters, entities and spirits that abound there, coupled with the fact that the Warlords and others will gladly pay for their services.



One might consider Ectohunters to be mercenaries, bounty hunters **and/or** exterminators who specialize in the eradication of ghosts, entities, spirits, demons and supernatural evil. As a supernatural bounty hunter, their service comes with a price. A community, business, individual, knight or Warlord must pay to get an Ectohunter to rid them of supernatural trouble. Rarely will any Ectohunter consider working for "charity," although some will take a job gratis when revenge is involved, as repayment for a favor, in trade or if it will bring him the publicity/fame he seeks. Otherwise, they are paid professionals who risk their lives and expect appropriate recompense.

Payment typically includes credits, Rubles, **and/or** trade in valuables (gold, silver, diamonds, jewelry, magic items, weapons, **E-Clips**, vehicles, Black Market items, furs, livestock, etc.), or trade for a special service. Most also expect to be treated like royalty and get free room and board while on the job; basic expenses if you will. There is no set pricing structure, so the cost will vary from Ectohunter to Ectohunter. The most experienced and arrogant (some would say heartless) tend to charge the highest, while those just starting out, or in desperate straits themselves, tend to be considerably less expensive and jaded. The price also varies with the level of the danger. If the supernatural menace is a minor entity, ghost or goblin, the Ectohunter may charge as little as **100** credits and a couple nights of food, rest and hospitality. On the other hand, if the menace is great, it might cost tens of thousands of credits to a king's ransom to get the Ectohunter involved. If there is a bright side to this expense, it's that the Ectohunter usually demands a **nonrefundable** 10% retainer, plus expenses (room and board) to take a job, but does not collect the balance **unless** he is successful.

Now given the nature of the business, proof of a successful extermination (i.e. a dead body) is seldom possible, which means one must take the Ectohunter at his word (those with reputations are extremely reliable) or keep him in town (at the community's expense) for days or weeks to see if the "thing" is really gone or not. Most Ectohunters don't mind this minor inconvenience provided their accommodations are nice (the nicer the better) and their employer doesn't insult them in any way. This aura of doubt comes with the job.

The high number of ghostly spirits, entities and supernatural beings that plague Russia place the services of Ectohunters in great demand. Thus, they can be found clearing out old **ruins**, purifying churches, raiding crypts, investigating strange occurrences, and setting up bases of operations at villages and farms throughout the region. Ghost hunting is their specialty, which means they are best at ridding a community of entities, spirits, ghosts and other spectral beings, including demonic possession. Most are also willing to tackle problems involving individual or small groups of Faerie Folk and lesser demons such as ghouls and banshees. Most are well versed in demon and monster lore, and know something of magic, particularly the signs that indicate necromancy, witchcraft and demon worship. They also know how to identify vampires, werebeast, shapechangers and greater demons. For a small fee (sometimes as an act of kindness), the Ectohunters are willing to identify a problem involving much greater demons and dangerous beings, but most are not willing to engage them. At least half the Ectohunters will not even consider facing such terrors and the half that do, usually charge outrageous fees.

The **Ectohunters'** close association with the supernatural, "spirits" in particular, has given them the power to tap into ley line energy and draw upon magic in both conscious and unconscious ways. Their mystical powers are minor compared to other mages, but are enough to give them the edge they need when combating the supernatural. Members of this O.C.C. can sense magic and are capable of casting spells by reading scrolls as well as using magic weapons and items. When combined with their training in the use of special "ghost killing" weapons, it makes them competent opponents. Among their most amazing unconscious abilities is their almost total immunity to Horror Factor and possession. Beings that would send a normal man running or be able to seize his mind (if not body), cannot harm the Ectohunters in such a fashion.

Special Ectohunter O.C.C. Abilities

1. Sense and See the Ghostly: Ectohunters are uniquely attuned to ethereal energy beings and spirit-like life essences, including Astral beings, Russian ghosts, all entities (including possessing entities), ethereal spirits, ethereal demons like the Banshee, and the splintered life essences of alien intelligences, gods and demon lords. In the case of splintered or shared life essences, the Ectohunter can sense true witches and mortal servants who have spiritually "joined" with a supernatural life force/a shared life essence.

This ability enables the Ectohunter to sense the presence of such creatures within 100 feet (30.5 m) per level of experience, and see them whenever they are within his line of sight. In the case of possessing spirits and splintered life essences, the Ectohunter can actually see the aura of the possessing entity/essence and will have a strong "sense" of what it is. This means the ghost killer will have a good idea of how powerful it is, and know what particular *type of* demon, possessing entity, or alien essence it may be, but not exactly who. As helpful as this may sound, the possessing entity/essence *knows* it can be seen and the Ectohunter will know it knows. Furthermore, the being can, if it so desires, identify exactly who or what it is (usually to intimidate the Ectohunter). **Note:** This is an innate ability and does not require the expenditure of P.P.E. or concentration.

2. Recognized by the Ghostly: Just as the Ectohunter can see and hear ghostly beings, they **can** recognize him. Like two long-time enemies who spot each other in a crowd, ghost and ghost hunter instantly see each other for what they are and respond accordingly. Such a response may be conversation, threats, flight, or combat, depending on the situation and the characters involved. While this recognition may get ghostly beings to flee or try to negotiate an amicable resolve with the Ectohunter, it also makes sneaking up on them difficult and instantly marks the Ectohunter as an enemy.

3. Communication with the Ghostly: All Ectohunters possess this ability whether they have psionic powers or not (about 30-40% do). Both the ghost (entity, essence, astral being, etc.) and the Ectohunter can speak and understand each other on some metaphysical, mental level. The actual process is probably similar to telepathy and enables the Ectohunter to communicate directly with the ghost-like being with his mind. This means he can have a mental conversation or argument with the entity/essence without anybody realizing it. To spectators, this invisible conversation may seem as if the Ectohunter is day-dreaming or has lapsed into a trance, or that he's gone crazy, as he moves

and gestures as if he's talking to somebody only he can see (and usually without verbally speaking other than a word here and there).

Ghosts/entities/essences often speak to the Ectohunter the moment they realize he is present (they know and recognize the distinctive aura and energy that radiates from them). Unfortunately, this discourse typically involves the entity/essence issuing threats, taunts and foul remarks rather than a **meaningful** discussion, but conversation can happen, sometimes. In fact, this is how Ectohunters get most of their information concerning whether the being is hostile, stubborn, playful, sad, dangerous, etc.

4. Ghost Killing! The Ectohunter can mentally focus and summon magical energy to deliver damaging blows to ghosts, spirits, entities, astral beings and even the energy form of alien intelligences. Such a blow can be delivered from an ordinary punch (1D6 M.D. to such beings) or through ancient, S.D.C. weapons held by the Ectohunter (i.e. daggers, swords, spears, arrows, etc.). These temporarily, magically charged weapons inflict Mega-Damage equal to the weapon's usual S.D.C. +1D6 M.D. — this means if a sword normally did 2D6 S.D.C., in the hand of the Ectohunter against ghostly beings and spirits, the weapon inflicts 3D6 M.D. (2D6 +1D6)! Against vampires, the weapon will do its normal S.D.C. damage +1D6 S.D.C. additional.

Duration: As long as the character can concentrate and focus; typically Four melee rounds per level of experience, but longer if motivated. Using any skill other than combat and W.P. related ones cancels the effect. Ectohunters under 5th level must concentrate for one full melee round (15 seconds) before the power manifests. Experienced Ectohunters (5th level and higher) can instantly draw upon this power.

P.P.E. Cost: Two points per use.

Range: Self and hand-held weapons, from a sword to a cudgel or chair.

Note: The ghost-killing ability works only against ethereal energy beings and spirit-like life essences, and not solid, M.D.C. flesh and blood demons and monsters, hence part of the **Ectohunter's** reluctance to challenge such creatures.

5. Sense supernatural evil: Like psychic sensitives, the Ectohunter can physically feel the presence of supernatural evil, although not quite as developed. The Ectohunter can tell whether the source of evil is represented by one, a **few**, or many beings, and the general level of power: low, medium, powerful, incredibly powerful, and whether it is demonic in nature or something else (ancient god, spirit, elemental, alien intelligence, witch, necromancy, etc.). Likewise, the Ectohunter can tell if the supernatural evil is caused by vampires. Unlike **Psi-Stalkers** and **Dog Boys**, the sensation cannot be tracked to its source. **Note:** The ability is constant and automatic, just like our own sense of hearing, and does not require the expenditure of P.P.E.

Range: 200 feet (61 m) per level of experience; double the range if the source of supernatural evil is an alien intelligence, a group of vampires or a gathering of witches or demons (20 or more).

6. P.P.E.: An Ectohunter starts with 4D6 P.P.E. plus the P.E. attribute number. The character rolls **1D4** and adds the result to the base P.P.E. with each level of experience.

7. Resistance to Horror Factor: When it comes to supernatural monsters and horrors, the Ectohunter is +1 to save at levels 1, 2, 3, 4, 5, 6, 7, 8, 9, 10, 12 and 14. However, the sight of blood, brutality and other things may still be disturbing and horrific.

8. Resistance to Possession: The Ectohunter is +10 to save vs possession and +1 to save at levels 2, 4, 6, 8, 10, 12 and 14.

9. Magic Abilities: Ectohunters can use magic items and read scrolls.

10. O.C.C. Bonuses:

+2 on initiative against ghostly beings only.

+1 to pull punch.

+1 to save vs illusions.

11. Vulnerability: Insanity. The ability to see the spirit world has its price, and slowly wears the Ectohunter hunter down. Their experiences with the supernatural can cause terrible emotional upheaval, anxiety, and trauma which in turn can lead to insanity.

Every other level of experience, there is a 01-50% chance that the character permanently loses one M.E. point.

Every third level of experience (starting with level three), there is a 01-66% likelihood of developing an insanity. If the percentile roll is 1-66, roll on the Random Insanity Table on page 19 of the **Rifts® RPG**. A roll of 67-00 means no insanity.

Ectohunter O.C.C.

Also known as Ghost Hunters and spiritualists.

Alignment: Any, but most are selfish.

Racial Restrictions: None, although the majority (70%) are human. **Psionics:** Psionic abilities are not a requirement, but approximately one third possess minor or major psionics.

Attribute Requirements: I.Q. 9, M.E. 14 or higher. A high M.A., P.S. and P.E. are also helpful but not required.

O.C.C. Skills:

Basic Math (+10%)

Speaks Russian at 98%

Speaks Euro and two other languages of choice (+20%).

Literacy: Russian (+10%)

Lore: Demons & Monsters.

Lore: One of choice.

Radio: Basic (+10%)

Surveillance Systems (+10%)

Read Sensory Equipment (+10%)

Intelligence (+10%)

Pilot: One of choice (+5%).

Land Navigation (+10%)

Wilderness Survival (+5%)

W.P. Ancient, one of choice (any).

W.P. Energy Weapon of choice (any).

Hand to Hand: Basic to start, but can be changed to Expert for the cost of one O.C.C. Related Skill or two skills for Martial Arts (or Assassin if evil).

O.C.C. Related Skills: Choose eight other skills at level one and two additional at levels 3, 6, 9 and 12.

Communications: Any (+10%)

Domestic: Any

Electrical: Any (+5%)

Espionage: None

Mechanical: Basic and Automotive only.

Medical: First Aid only.
Military: None
Physical: Any, except Gymnastics and Acrobatics.
Pilot Skills: Any, except robots, power armor, military vehicles, ships and aircraft.
Pilot Related Skills: Any (+10%)
Rogue Skills: None, other than Streetwise.
Science: Any (+5%)
Technical: Any (+10%; +15% to language or computer skills).
W.P.: Any
Wilderness: Any

Secondary Skills: The character also gets to select four Secondary Skills from the previous list at level one and one additional at levels 2, 4, 6, 9 and 12. These are additional areas of knowledge that do not get the advantage of the bonus listed in parentheses. All secondary skills start at the base skill level. Also, skills are limited as previously indicated.

Standard Equipment: Light suit of M.D.C. body armor, a **Vibro-Knife** (1D6 M.D.), one M.D. weapon of choice, a pair of silver knives, small silver cross, wooden cross, mallet and six wooden **stakes**, a box of **100** large, resealable plastic bags (for specimens), two medium sacks, clothing, backpack, bedroll, canteen or water skin, belt, boots, flashlight, language translator, note pad, 2D4 markers, **10 feet (3 m)** of thin nylon cord (600 lb./270 kg test strength), and a handful of personal items.

Additional weapons, special items and magic items may be acquired over time (and through role-playing).

Vehicle: Starts with a used and battered looking hovercycle or other basic means of transportation. The vehicle will be missing **1D4x10** of its M.D.C. from the main body, but looks to be in fairly good condition (and is).

Secret Resources: None per se, and most people dislike these arrogant, sanctimonious, money-grubbing, spectral bounty hunters (at least that's how many people think of them). They are especially disliked by **Bogatyr**s and other humanitarians, and they are something of a joke to Huntsmen who see Ectohunters as foppish sissies.

Money: Starts with **1D6x1000** credits, and **1D6x100** in tradeable goods. Wealth, along with fame and glory, is of the utmost importance to most Ectohunters. Many build strong reputations and some amass sizable fortunes.

Cybernetics: None to start; varies with the individual. Some avoid them while others like them. Most avoid bionics as they are harmful to psionics and magic abilities.

Explorer O.C.C.

Like other traditional professions, the Explorer on Rifts Earth is no academic, sitting behind a desk and typing thesis after thesis. He is instead, a wandering adventurer who goes to the ends of not only the Earth, but the Megaverse! These men and women, humans and D-Bees, have an insatiable desire to travel, explore and learn about people, places and secrets everywhere. They are fascinated by alien races and cultures and tantalized by new discoveries. Their quests and wanderlust may take them to mountain temples or the depths of the ocean, burning deserts, nexus points and beyond, perhaps even into other dimensions.



With this in mind, the explorer is always ready for a new expedition to another land and carries most everything he needs on his back — the experiences and knowledge he carries in his heart and mind.

This all-around adventurer has grown in number in Europe and Russia for the last couple of generations. About 40% come from the New German Republic, but they can originate from almost anywhere, as being an explorer is more a state of mind than an exact profession. Russia and Asia are prime areas for exploration mainly because they are such exotic, unknown wildernesses. Africa and India are also becoming increasingly attractive to explorers, not to mention far off places like Australia and Southeast Asia. The O.C.C. combines informal training with bits of formal education and life experience.

Regardless of their reasons, these individuals live for the exotic, exciting, new, and unexpected. They love mysteries and find answers. They are most often brave (although some would say "crazy"), and willing to take risks to achieve their goals. These goals often set them against others who have opposing views or dislike the explorers' openness to alien peoples and customs. Searching for lost cities, ancient temples, legendary monsters, and so on, may sound interesting, but such searches are fraught with danger. In some cases the very people, creature or thing that they search for may be hostile, dangerous **and/or** not want to be found.

The exact appearance, attitude and background of an explorer can take on many forms. Surprisingly, two thirds originate from

civilized and comparatively modern, even advanced cultures, including the New German Republic, Poland, the Coalition States, Lazo, Atlantis and others; which also means 50% are foreigners and about 30-40% are D-Bees from other worlds entirely! Some are very physical and combat oriented (difficult to tell from mercenaries), others are more brainy and scholarly or scientific, and others are little more than vagabonds. Explorers make natural adventurers, and adventurers are often explorers, but "true," dedicated explorers are driven by wanderlust, a thirst for knowledge, excitement, and their latest quest for the fabled person, place or thingamajig. They are by nature, seekers of mysteries, searchers of answers and above all else, restless travelers always wondering what's around the next corner, and anxious to see it.

The Explorer O.C.C.

Alignment: Any.

Racial Restrictions: None; at least 30-40% are nonhuman.

Attribute Requirements: I.Q. 9, M.A. 9, and P.E. 9 or higher.

High M.E., P.S. and Spd are helpful but not required.

Psionics: Psionic abilities are not a requirement, although about 15% have minor or major psionics.

O.C.C. Bonuses:

+1 to dodge

+2 to roll with punch, fall or impact.

+1 to save vs poison and disease.

+2 to save vs Horror Factor

O.C.C. Skills:

Basic Math (+15%)

Speaks native language at 98% and three other languages of choice (+15%)

Anthropology (+20%)

Archaeology (+10%)

Lore: Two of Choice (+15%).

Pilot: Two of choice (+10%).

Radio: Basic (+5%)

First Aid (+10%)

Swim (+10%)

Climb (+5%)

Land Navigation (+15%)

Wilderness Survival (+10%)

Prospecting (+10%)

W.P. two of choice.

Hand to Hand: Basic

Hand to Hand: Basic can be raised to Hand to Hand: Expert for the cost of one O.C.C. Related Skill, or Martial Arts for the cost of two skill selections.

O.C.C. Related Skills: Choose seven other skills at level one and two additional at levels 4, 8 and 12. **Note:** Many have video, photography, writing or art skills to document their explorations.

Communications: Any (+5%)

Domestic: Any (+5%)

Electrical: Basic only.

Espionage: Intelligence and Escape Artist only (+5%).

Mechanical: Basic and Automotive only.

Medical: Brewing and Holistic Medicine only.

Military: None

Physical: Any, except Boxing, Gymnastics and Acrobatics.

Pilot Skills: Any (+5%), except robots, power armor, military vehicles, ships and military aircraft.

Pilot Related Skills: Any (+10%)

Rogue Skills: **Cardsharp**, Computer Hacking, and Streetwise only (+5%).

Science: Any (+5%)

Technical: Any (+10%; +15% to art and language skills).

W.P.: Any

Wilderness: Any (+5%)

Secondary Skills: The character also gets to select three Secondary Skills from the previous list at level one and one additional at levels 2, 4, 6, 8 and 12. These are additional areas of knowledge that do not get the advantage of the bonus listed in parentheses. All secondary skills start at the base skill level. Also, skills are limited as previously indicated.

Standard Equipment: Light suit of M.D.C. body armor, and one weapon for each W.P. plus 1D4+2 extra ammo-clips for each. Other items include a survival knife, pocket knife, folding shovel, hand axe, pen flashlight, large flashlight, lighter, box of matches, portable language translator, 1D6 small sacks, six medium-sized sacks, two large sacks, a box of 100 sealable plastic sandwich bags, a box of 100 large sealable plastic bags, backpack, bed roll, two canteens or water skins, belt, travelling clothes, note or sketch pad, 1D4 markers, mechanical pencil with extra lead, 50 feet (15.2 m) of cord (600 lb./270 kg test strength), air filter, sunglasses, and a handful of personal items.

Additional weapons, special items and magic items may be acquired over time (and through role-playing). They are especially attracted to magical and alien weapons and artifacts because of their exotic nature.

Vehicle: Starts with a used and battered looking hovercycle, motorcycle or similar small vehicle suitable for exploration. It is missing 1D4x10 of its M.D.C. from the main body and looks shabby, but is in otherwise good condition.

Secret Resources: None per se, although with time and travel, they will make friends and acquaintances all over the world.

Note: Reavers and soldiers of the War Camps consider most explorers to be lazy wanderers, shiftless gypsies, or vagabonds (i.e. hold them in low regard). Explorers in general and foreigners and D-Bees in particular will be regarded with suspicion and may be accused of being spies, thieves, assassins, and rabble-rousers and subjected to searches, interrogations, threats and harassment. If believed to be a spy, the explorer may be beaten, tortured, imprisoned or executed!

Money: Starts with 2D4x100 credits and 2D4x100 in tradeable goods, including artifacts.

Cybernetics: Depends on the individual's personality. Some explorers love 'em and others disdain them. The explorer O.C.C. starts with no cybernetics, but they may acquire implants and the occasional bionic limb when they can afford them.

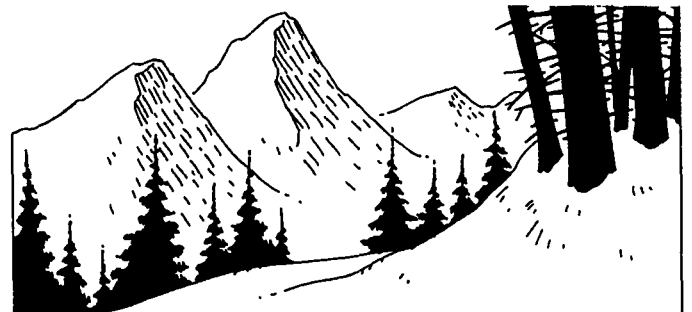



The Huntsman-Trapper O.C.C.

Most Westerners think of the hunter as a sportsman who uses stealth and guns to get his prey, and the trapper as something of a wilderness scout or mountain man who lives in isolation and uses traps and snares to catch and kill his prey, usually for their pelts. The Russian Huntsman-Trapper is a little bit of both, and a lot more. Most are strong, burly men (occasionally women — or husband and wife, or father and daughter teams, but usually men) who seek adventure and share a fondness for the forest.

The Huntsman likes the challenges and elements of the unknown that the haunted forests of Russia have to offer. They enjoy relying on their wits and natural attributes to survive in places where most men (even the War-Knights) fear to tread. They revel in the adventure of it all and thrive on the freedom the wilderness has to offer. In the wilderness they answer to no man, Warlord, king or sorcerous mage. They make a living by their own laws and do as they please within their own personal code of wilderness ethics. They are not restrained by cultural mores, behavior or etiquette and take a staggering amount of pleasure in burping, farting, bellowing, cursing, laughing loudly

and speaking their mind, especially, it seems, when around "refined" people. Furthermore, they find it hilarious that "civilized" folk often find them to be abhorrent barbarians, just because they don't act "refined" or "citedified."

Indeed, many villagers and especially city-folk and adventurers from other lands, regard these crude, outspoken, flatulent fellows with disgust, revulsion and a little bit of fear. Many consider them to be barbarians and misanthropes best left in the woods with the other dim-witted "animals." This unflattering perception actually helps the Huntsmen because most people think of them as uneducated, unimaginative, stupid louts incapable of cunning or guile. And nothing could be further from the truth. To live in the deep forests and survive, one must be incredibly alert, inventive, resourceful, and cunning. Most Huntsmen, if one can look past their loud, crude veneer, are intelligent, very knowledgeable (particularly about the land, travel, animals and monsters), and many can be quite charming. Most are pretty genuine too — what you see is usually what you get, although when trickery and deception are required, most can step up to the challenge. True Huntsmen (not hunters, hobbyists and exploitive trappers, scouts and Reavers) are generally cheerfully pragmatic. They live hard, but enjoy life, have a great respect for life and nature, and are accepting of whatever comes their way. Most also exhibit a keen understanding of human na-

ture and aren't easily fooled by fast-talk, pretenses, politics or lies. According to myth, a real Huntsman "can size a man up in a glance, and tell him more about himself than his own mother."

Farmers and peasants hold them in high regard and turn to Huntsmen-Trappers for advice about the forest, cultivating land, travel, animal husbandry, and in ridding them of dangerous beasts. They fear the Huntsmen only because they cannot imagine the life they lead, and fear what a man who can face down a ghost or battle a demon might do to an ordinary human if angered.

In Rifts Russia, being a Huntsman also means hunting, killing and battling alien predators and monstrosities, as well as dragons, demons and other supernatural horrors. The Huntsman is frequently hired to rid a village, farm or region of particularly troublesome or elusive monsters and animals, man-killers, and beasts that slaughter livestock or ruin crops. Their aid may also be enlisted in the search for people lost in the woods or stolen by gypsies or fearsome woodland beings. Huntsmen can find their way around any Russian forest, know many of its secrets and are experts in avoiding predators, ghosts, demons and monsters (see *Deep Forests — The abode of supernatural Evil*, for some insight about demons, travel and roads). They are also able to negotiate with Faerie Folk, werebeasts, and some woodland spirits and gods because they have earned their respect and won favor as fellow woodland creatures.

The Huntsman-Trapper's skill at exterminating demons and monsters is not as flamboyant and mystical as the Demon Slayer or Ectohunter, but they are very good at it, and often accept a job for comparatively low pay (typically food, booze, some basic supplies, etc.) and the challenge of the hunt, or satisfaction of helping those in need. If the task is particularly difficult and/or he's not particularly interested or dislikes the people looking to hire him, the hunter may insist on a horse or vehicle, weapons, magic items, money, a fine bed, and special treatment or services. On the other hand, if a child or other innocent person is in immediate danger or a manhunt is already underway, the average Huntsman will volunteer to join the effort without hesitation or consideration of payment.

One of the most interesting aspects about the Huntsman's approach to resolving a problem with a dangerous animal or monster, is that he does *not* simply go out and kill it. He takes 1-4 days to study the situation, the creature/opponent, and the community, before he develops a plan of action. This plan may involve capturing and relocating animals that aren't man-eaters, and talking to, negotiating with, or tricking Faerie Folk, woodland spirits, ghosts, D-Bees, Gypsies, werebeasts, and sometimes even demons, to get rid of them. Unlike the Warlords' soldiers and professional Demon Hunters, most Huntsmen seek a solution to a problem that may not involve killing (killing without examining the bigger picture can be unnecessary or have serious repercussions — like an angry **mate**, a vengeful loved one, family or tribe, etc.). And since many woodland beings recognize the Huntsman as a kindred spirit, many will allow him to approach, talk and make deals. Such amicable resolutions may involve a trade of goods or services with the human community or with the Huntsman, avoiding a sacred area, and so on. For example, he might offer to rid them of some problem or help in some other way. This tactic is especially good in situations where children or women are kidnapped, or

livestock or valuables are stolen. Huntsmen are canny negotiators and deal-makers.

Likewise, when dealing with dumb animals — "critters who don't know no better" — the Huntsman will try to resolve the problem without killing the creature. This might involve something as simple as building a fence, penning animals, or avoiding a particular area that the animal considers its lair, and so on. If ridding a community of a problem animal doesn't require killing it (like a bear or animal predator who has wandered into town, or is injured, or frightened and protecting young, etc.), he'll make an attempt to capture and relocate it, not unlike modern **conservationists** before the Great Cataclysm. The only exceptions to this rule are man-eaters (they must be slain or they will continue to hunt human prey) and truly evil supernatural beasts, including vampires, greater demons, Gargoyles and Brodkil. Huntsmen have no love for demon worshippers, witches and necromancers either. Each is seen as a pestilence who has no regard for life or God's creatures.

Huntsmen wear Mega-Damage body armor and use Mega-Damage weapons; you must when dealing with the supernatural and the denizens of the Russian wilderness. However, only 15% have partial bionics, and most completely avoid bionic augmentation. They prefer to feel the wind on their skin and the grass under their feet. To that end, most wear only partial armor, using the hides, bones, and scales of M.D.C. animals combined with pieces of modern armor to fashion themselves comfortable, lightweight body armor (typically 30-60 M.D.C., but rarely provide environmental protection). They are also partial to furs and leather goods, which helps to contribute to their low-tech, rag-tag, barbarian image.

As for weapons, the Huntsman loves **Vibro-Blades**, magic items, and heavy energy weapons, as well as S.D.C. weapons for hunting ordinary animals.

Special Skills & O.C.C. Abilities

1. Track & Trap Animals, Otherworldly Creatures & Demons: This is a somewhat expanded and specialized version of the more common and fundamental Wilderness Skill, Track Animals, with a focus on trapping animals and hunting alien and demonic creatures. It enables the character to identify an animal (including animals from the Rifts, and demonic creatures, particularly animalistic ones) by its tracks, scent, spore, and habits. The individual can also follow the creature's tracks and other tell-tale signs of passage. This means he can also estimate how fresh the tracks are, what direction they are heading, whether the creature is hurt or sick, guess at its age, and knows the basic habits and habitats of most Russian woodland creatures, including Faerie Folk, Russian ghosts, lesser demons, vampires, werebeasts and woodland spirits. The first percentile number indicates the character's tracking abilities and the above knowledge.

The second percentile number indicates the character's ability at **trapping** animals by using, setting, and disarming snares, clamp traps (like the iron bear trap), pits, nets and similar traps. **Base Skill:** 20%/30% +5% per level of experience. Tracking humans with this skill is also possible, but is done with a penalty of -20%. Disarming any traps meant for use against humans is done at half the **character's** normal skill ability.

2. Recognize Supernatural Shapechangers particularly werebeasts, vampires, Faerie Folk and those who inhabit the Russian forests. Part of this ability draws on the character's expansive knowledge and understanding of animals and their behavior, which enables him to recognize when an animal is acting out of character and is probably a shapechanger. His knowledge of the forest, animals, Faerie Folk, monsters and demons also helps him to identify the likely racial nature/true identity of the shapechanger. For reasons not understood even by the Huntsman, he has an innate sense about werebeasts and can recognize them in both human and animal form. As a kindred woodland spirit, the werebeast does not automatically regard the Huntsman as an enemy, and will often speak frankly and honestly to him. **Base Skill:** 30%+5% per level of experience.

3. Forest-wise: Basically the streetwise skill except it applies to denizens, places and secrets of the forest rather than the streets. Thus, the Huntsman can recognize bands, gangs and tribes of humans, D-Bees, Faerie Folk, werebeasts, and lesser demons who inhabit, hunt or hide out in the forests, as well as their philosophies, practices, rituals, haunts, hangouts, and dangerous places — this also applies to predatory animals. **Base Skill:** 20% +4% per level of experience.

4. Unusually high P.P.E. for nonpractitioner of magic: 4D6 +P.E. attribute number and +1D4 P.P.E. per level of experience. This may account for their acceptance by Faerie Folk and werebeasts, as well as some of their bonuses. It also enables the Huntsman to use magic items and draw upon Ley Lines to heal!

5. Ley Line Healing/Rejuvenation: The Huntsman can absorb or channel ley line energy to double the rate of natural healing. This is done by resting at a ley line for several days of recovery. Once every 48 hours, the character can also do an instant healing. This is accomplished by meditating while sitting on a ley line. After 15+1D6 minutes, 2D6 Hit Points and 2D6 S.D.C. are restored.

6. Special O.C.C. Bonuses:

- +2 on initiative.
- +3 to pull punch.
- +1 to save vs magic.
- +3 to save vs possession.
- +2 to save vs poison and disease.
- +1 to save vs Horror Factor at levels 1, 3, 4, 5, 7, 8, 10, 12, and 14.

The Code of the Huntsman-Trapper

- Mercy is a virtue.
- Compassion will be rewarded.
- Children are the future of man, be kind and help them.
- Do not squander God's gifts: Use as much of the meat, fur, bones, teeth and horn of the animal one kills as is possible. Understand and appreciate God's creatures.
- Killing the infernal demon is a blessing to man and Mother Russia, for they are hell-spawned abominations (this includes Gargoyles, Brodkil, vampires, witches and necromancers, but not werebeasts or dragons).
- Life is a wonder, drink deeply in her splendor.

The Russian Huntsman-Trapper O.C.C.

Also known as Woodsman and Trapper.

Alignment: Any, but most are good or selfish.

Racial Restrictions: None, although the majority (63%) are human.

Attribute Requirements: I.Q. 9, and P.E. 12 or higher. A high M.E. and P.S. are helpful but not a requirement.

Psionics: Psionic abilities are not a requirement.

O.C.C. Skills:

- Basic Math (+10%)
- Speaks Russian at 98%
- Speaks Faerie and two other languages of choice (+10%)
- Lore: Demons & Monsters (+20%)
- Lore: Faeries (+20%)
- Lore: **Geomancy & Ley Lines** (+10%)
- Dowsing (+20%)
- Identify Plants & Fruits (+10%)
- Animal Husbandry (+20%)
- Cook (+10%)
- Swim (+20%)
- Climb (+10%)
- Camouflage (+20%)
- Detect Ambush (+10%)
- Land Navigation (+20%)
- Wilderness Survival (+30%)
- Trap Construction (+20%)
- Trap/Mine Detection** (+10%)
- W.P. Two Ancient of choice (any).
- W.P. Two Modern S.D.C. weapons of choice (typically, a rifle is one).
- W.P. One M.D. energy weapon of choice.
- Hand to Hand: Expert (no others are available).

O.C.C. Related Skills: Choose five other skills at level one and two additional at levels 4, 8 and 12.

- Communications: Any
- Domestic: Any (+5%)
- Electrical: None
- Espionage: None, except Detect Concealment, Intelligence and Tracking (all are +5%).
- Mechanical: None
- Medical: First Aid, Holistic Medicine and Brewing only.
- Military: None
- Physical: Any, except acrobatics.
- Pilot Skills: Any, except robots, power armor, military vehicles, ships and aircraft.
- Pilot Related Skills: Any, but usually none.
- Rogue Skills: None, other than **Cardsharp** and Prowl (+10%).
- Science: Astronomy, Botany and Advanced Math only (+5%).
- Technical: Any (+10%; Whittling and Falconry are +15%).
- W.P.: Any
- Wilderness: Any (+10%)

Secondary Skills: The character also gets to select two Secondary Skills from the previous list at level one and one additional at levels 2, 4, 6, 8 and 12. These are additional areas of knowledge that do not get the advantage of the bonus listed in parentheses. All secondary skills start at the base skill level. Also, skills are limited as previously indicated.

Standard Equipment: Light suit of M.D.C. body armor (usually a hodgepodge of homemade armor), a **Vibro-Knife** (1D6

M.D.), and one weapon for each W.P. plus **1D4+2** extra ammo-clips for each. Other items include a survival knife, skinning knives, pocket knife, hand axe, flashlight, language translator, lighter, flint and tinder box, cooking utensils, frying pan, **1D6** small sacks, six medium-sized sacks, two large sacks, a box of 100 plastic **sealable** sandwich bags, a box of **100** large **sealable** bags, **1D4** airtight (resealable) plastic containers, backpack, bedroll, duffle bag, two canteens or water skins, belt, boots, travelling clothes, fur cloak or long coat, note pad, **1D4** markers, 10 feet (3 m) of thin nylon cord, 50 feet (15.2 m) of additional cord (600 lb./270 kg test strength), 20 feet (6 m) of wire, animal snares, and a handful of personal items.

Additional weapons, special items and magic items may be acquired over time (and through role-playing).

Vehicle: None to start; most Huntsmen prefer to walk, but may know how to ride a horse or hovercycle in a pinch.

Secret Resources: None per se, although most Huntsmen are highly regarded by Gypsies, Travelling Story Tellers, Mystic **Kuznya**, Mega-Horses and peasants. This will mean influence with the common people and Gypsies, as well as the occasional practitioner of magic and adventurer.

Note: Reavers and soldiers of the War Camps hold a general dislike (and a bit of envy and fear) for the independent and self-assured Huntsman-Trapper. They don't like the fact

that these woodsmen don't feel it necessary to ally themselves to a Warlord, ignore paying tribute (not that they own much), and associate with people they consider to be dangerous, most notably Gypsies, D-Bees and Faerie Folk. Furthermore, some question how these "ordinary" humans can survive in the deep forests without making pacts with demons. As a result, they often bully, threaten and harass the Huntsman. Ironically, they will also turn to them when they have need of their woodland expertise.

On the other hand, the **Bogatyr/Hero-Knights** usually find the Huntsman to be an admirable character and a potential friend and ally. Demon Hunters also tend to like and get along with Huntsmen, but Ectohunters typically regard them as crude loudmouths and rivals who give their profession a black-eye.

Money: Starts with **4D4x100** credits worth of furs, horns, bone, nuggets of silver or gold and other **tradeable** goods (herbs, spices, birds, small animals, etc.). Wealth is of little concern to most Huntsmen-Trappers because they live off the land and don't have much need for possessions and don't own any land.

Cybernetics: None to start and avoid them as unnatural. The only cybernetics that they might consider are bio-systems prosthetics and organs to replace severely injured ones.

Travelling Story Teller O.C.C.

These men and women might be considered vagabond scholars and wise men, for while they are particularly skilled in spinning stories, their tales are often historical, instructive, and moralistic. In addition, the Story Tellers are well versed in *all* lores, as well as Russian history, medicine, and practical skills. The Story Tellers like to teach, advise and help others. This includes lending a hand in physical labor as well as spinning yarns. As travelers, they also bring with them news, information and rumors that can be of great service to the hardworking people secluded on their farms or in their villages.

The *Muzhiks* (the Russian name for Story Tellers) are especially respected and welcomed by wilderness people for whom the wise men's knowledge, expertise and willingness to help others can be of tremendous value. However, in these low-tech, superstitious communities, they are often called upon to help rid them of **ghosts**, demons and troublesome faerie folk. Travelling Story Tellers are also solicited to act as mediators, arbitrators and to speak on a community or group's behalf. This mediation can be with monsters, bandits, rival communities, factions within a War Camp, or with a Warlord directly — most Warlords will *consider* speaking with well known and respected Muzhiks, or at least offer the ear of one of their High Command

The Travelling Story Tellers love adventure as much as a juicy story, and while they are not particularly adept at combat, most can account for themselves and revel in the excitement. Their vast range of knowledge (particularly lore, medicine and wilderness) makes them valuable companions to knights, mercenaries, and other adventurers. They are often seen advising and helping warriors of all kinds and are among the few occupations allowed to travel from one Warlord's Sphere of Influence to another

without being suspected of spying or being harassed. Furthermore, because most Travelling Story Tellers respect all local governments, authorities, laws and practices and don't usually defy or threaten them, nor make alliances with their enemies, they are considered peaceful or neutral wise men who help and serve all Russian people. As such, Muzhiks are not charged fees, fines or tribute unless the situation is desperate or they have openly broken their neutrality (i.e. are clearly working for one Warlord against another, are the pawns of supernatural evil, etc.).

One of the things that the Warlords and other powers find unnerving about the Travelling Story Tellers is their tolerance and acceptance of all people, including D-Bees and creatures of magic, such as dragons and Faerie Folk. While the Story Tellers do not openly preach against human supremacy, slavery or the abuse and persecution of D-Bees, they lead by example when they treat D-Bees like equals and show them kindness and compassion.

The Russian Story Teller O.C.C.

Alignment: Any, but most are good or selfish.

Racial Restrictions: None, although the majority (80%) are human

Attribute Requirements: I.Q. 8, M.A. 10, and P.E. 10 or higher.

Psionics: Psionic abilities are not a requirement.

Special O.C.C. Bonuses:

+1 to save vs possession.

+1 to save vs poison and disease.

+2 to save vs Horror Factor.



O.C.C. Skills:

- Basic Math (+15%)
- Speaks Russian at 98%
- Speaks Euro and two other languages of choice (+20%).
- Literacy: Russian (+20%) and one of choice (+10%).
- Lore: *All* those applicable to Europe and Asia, including history, animal, demon, monster, magic, and faerie lore (+20%).
- Radio: Basic (+10%)
- Pilot: One of choice (+5%).
- Paramedic (+10%)
- Holistic Medicine (+10%)
- Identify Plants & Fruits (+15%)
- Animal Husbandry (+10%)
- Brewing (+15%)
- Cook (+15%)
- Sing (+20%)
- Land Navigation (+10%)
- Wilderness Survival (+10%)
- W.P. One of choice (any).
- Hand to Hand: Basic (no others are available).

O.C.C. Related Skills: Choose four other skills at level one and two additional at levels 3, 6, 9 and 12.

- Communications: Any (+5%)
- Domestic: Any (+10%)
- Electrical: None
- Espionage: None
- Mechanical: None
- Medical: None, other than those above.
- Military: None

- Physical: Any, except Boxing, Gymnastics and Acrobatics.
- Pilot Skills: Any, except robots, power armor, military vehicles, ships and aircraft.
- Pilot Related Skills: Any
- Rogue Skills: None, other than Streetwise.
- Science: Any (+10%)
- Technical: Any (+10%; +15% to language skills).
- W.P.: Any
- Wilderness: Any (+5%)

Secondary Skills: The character also gets to select five Secondary Skills from the previous list at level one and two additional at levels 2, 4, 6, 9 and 12. These are additional areas of knowledge that do not get the advantage of the bonus listed in parentheses. All secondary skills start at the base skill level. Also, skills are limited as previously indicated.

Standard Equipment: Light suit of M.D.C. body armor, a **Vibro-Knife** (1D6 M.D.), one M.D. weapon of choice, pocket knife, butcher's knife, meat cleaver, cooking utensils, frying pan, small pot, small kettle, bowl and grinder, a box of 100 large resealable plastic bags, three small sacks, one set of dress clothing, one set of travelling clothing, cloak or long coat, backpack, bedroll, two canteens or water skins, belt, boots, flashlight, language translator, note pad, 2D4 markers and a dozen pencils, a winter survival kit, 10 feet (3 m) of thin nylon cord (600 lb./270 kg test strength), and a handful of personal items.

Additional weapons, special items and magic items may be acquired over time (and through role-playing).

Vehicle: None to start; most story tellers like to walk, but eventually acquire a horse or small vehicle.

Secret Resources: None per se, although most Travelling Story Tellers are highly regarded, especially by peasants and D-Bees. They are also regarded favorably by the *Mystic Kuznya*, *Mega-Horses* and good practitioners of magic. This will mean influence with the common people, Mystic Kuznya and (through role-playing) the favor, friendship and contact with a variety of different people in all walks of life (but especially the poor). Most Huntsmen and *Bogatyr*s regard them with respect.

Money: Starts with 3D4x20 credits. Wealth is of little concern to most Story Tellers; most tell stories, offer advice and a helping hand for clean clothes, a meal, and warm, safe place to sleep. As explorers, adventurers, and world travelers, many acquire a handful of magic items, potions and rare artifacts (but start with none). Some even build a modest fortune, but their nomadic lifestyle means leaving most possessions behind and taking only the most important and portable items with them.

Cybernetics: None to start and usually avoid them. Story Tellers might consider one or two minor implants, and will use cybernetics as prosthetics and organ replacements if they should need them.

Russian Villager O.C.C.

The following are the basic stats for the average villager, farmer and low-tech citizen. This data can be used as a guide for creating Non-Player Characters or as an optional player character.

Typical Villager/Farmer/Worker O.C.C. & NPC

Also Known as peasants, citizens, and the Russian People.

Alignment: Any

Racial Restrictions: None, although the majority (70%) are human.

Attribute Requirements: None, although high physical attributes are ideal for those who labor in the fields or factories and high mental attributes for business people, advisors and elders.

O.C.C. Skills:

Speaks Native Language at 90%

Speaks two other languages of choice (+10%).

Lore: One of choice (+15%).

Piloting: Two of choice (+5%); no bonus for Horsemanship.

Animal Husbandry (+5%; +10% if a farmer or raises livestock)

Masonry (+10%)

Sing or Dance (pick one; +15%).

Cook (+15%)

Preserve Food (+10%)

Rope Works (+10%)

Swim (+10%)

Climb (+10%)

General Athletics

W.P. two Ancient Weapons of choice; blunt is very common.

W.P. one Modern Energy Weapon of choice.

Hand to Hand: Basic, but Hand to Hand: Basic can be changed to Expert for the cost of two O.C.C. Related Skill or



to Martial Arts (or Assassin, if anarchist or evil) for the cost of three skills.

O.C.C. Related Skills: Choose six other skills at level one and two additional at levels 4, 8 and 12.

Communications: Any

Domestic: Any (+10%)

Electrical: Basic electronics only.

Espionage: Wilderness Survival only (+5%).

Mechanical: Basic Mechanics and Automotive only.

Medical: Brewing, First Aid & Holistic Medicine only (+5%).

Military: None

Physical: Any, except Acrobatics, Gymnastics and Boxing.

Pilot Skills: Any; conventional types of vehicles and horsemanship, no robots, ships, aircraft or military vehicles.

Pilot Related Skills: Any

Rogue Skills: Ventriloquism only.

Science: Astronomy and Math only (+5%).

Technical: Any (+5%; +10% to any animal related skills).

W.P.: Any

Wilderness: Any (+5%)

Secondary Skills: The character also gets to select four Secondary Skills from the previous list at level one and one additional at levels 3, 6, 9, 12 and 15. These are additional areas of knowledge that do not get the advantage of the bonus listed in parentheses. All Secondary Skills start at the base skill level. Also, skills are limited as previously indicated.

Standard Equipment: A suit of hodgepodge, homemade M.D.C. armor (30-60 M.D.C.). One M.D. weapon with two extra ammo-clips, two ancient weapons, knife, hatchet for cutting **wood**, a wooden cross, **1D6** wooden stakes and a mallet, pitchfork or blunt weapon, walking **stick/staff** or sword, shovel, pocket mirror, gas mask and filter, tinted goggles, flashlight, cigarette lighter, **1D4** large sacks, two small sacks, backpack, bedroll, a water skin, belt, boots, travelling clothes, and a handful of personal items.

Additional weapons, supplies and magic items may be acquired over time, and through role-playing.

Vehicle: Starts with a bicycle or donkey.

Money: Starts with **1D6x10** credits and **2D4x10** worth of tradeable goods.

Cybernetics: None to start, and tends to avoid them.

Warlord Troops & Men at Arms

The Military Hierarchy of War Camps

The Warlord: The supreme power over his Sphere of Influence and commander of a legion of **knights**, warriors and misanthropes known as his War Camp. A Warlord typically commands a Camp of 30,000 to 100,000 warriors and assorted support personnel, as well as garnering the loyalty and support of the civilian populace under his protectorship (i.e. those living within the Warlord's specific Sphere of Influence). Some people see their mighty Warlords as near-gods, others as terrible demons, but the common people *respect* their Warlord and his minions.

Special Advisors: These men and women answer directly to their Warlord, and can be considered his "high counsel" or "court." They typically include practitioners of magic, scholars, scientists and War-Knights; occasionally a cyborg (any), Gypsy, or other member of the Camp who has proven himself loyal to the Warlord and valuable as an advisor. Ironically, this high position is one of the few where a non-Russian and even a nonhuman (D-bees, **dragons**, and others) can find a place in the War Camp.

Smoke Soldiers: The Warlords' most trusted espionage agents and master spies. While they don't usually assume a position of leadership (so they don't issue commands), they answer only to the Warlord and usually function separately from the War-Knights and the rest of the warriors and knights of the War Camp. They are feared, rather than respected. Smoke Soldiers represent less than one tenth of a percent of the War Camps troops. All are exclusively humans of Russian heritage.

War-Knights: These are the greatest and most respected Knights of the Realm, the elite heroes of the War Camps and champions of the people. The majority are officers who organize and lead the War Camps. The War-Knights follow a military chain of command with the Warlord as their Supreme Commander. However, even the lowliest War-Knight is regarded with the greatest respect. All War-Knights are exclusively humans of Russian heritage. They represent usually approximately 4-5% of a Camp's total forces.

Cyborg Shock Troopers: The elite among the cyborg warriors. The center of power within the Warlords' Camps, representing 15-20% of the combat forces. Exclusively humans of Russian heritage.

Heavy Machine Cyborgs: Cyborg warriors representing 10-15% of the Warlords' troops; exclusively humans of Russian heritage.

Light Machine Cyborgs: Cyborg warriors representing 20-25% of the Warlords' troops; exclusively humans of Russian heritage.

Wingriders: An elite division among several (but not all) Warlords' Camps; they typically represent less than 1% of the troops.

Soldati/Knights of the Realm/Infantry Soldiers: These are the respected grunts who serve the warlord and fight for Mother Russia. Most other military occupations, including Cyber-Doc, Operator, Communications officer, and others fall under Knights of the Realm. Exclusively humans of Russian heritage. Represents approximately 20-25% of the War Camp's troops. Note: 25-35% will have bionic implants **and/or** 1-3 bionic limbs.

Cossack: An elite cavalry of horsemen who specialize in riding bionic and real horses, as well as exotic, monstrous riding creatures. They are feared more than respected, and often have a mixed (and questionable) heritage that can be Russian, or a mixture of Russian and Ukrainian, Polish and Mongolian. Out in the Steppe where they originate, tribes and clans not affiliated with the Warlords may also come to accept foreigners and D-Bees as members of their clan, provided they are willing to live by Cossack law, and fight, live and die in honor of their adoptive clan. They represent 3-5% of the War Camp's troops.

Reavers: Regardless of their area of specialty (assassin, scout, raider, etc.), all Reavers are considered barbarians and foreigners who are presumably loyal and obedient to their Warlord and his Knights of the Realm. While Reavers are given some measure of respect and honor as soldiers of the Warlord, they are also viewed with a certain amount of suspicion and contempt. A common saying among Knights of the Realm and common folk alike sums it up well, "Yes, Reavers fight like mad dogs, but can one ever be certain that a mad dog won't someday attack its master?"

Reaver forces represent approximately 25-35% of most Warlords' forces. Counted among them are the poor, the disenfranchised/refugees, foreigners (mostly Eastern Europeans, but can include Mongolians, Chinese and others) and even D-Bees (usually fairly human-looking ones, but not always); about 1-3% are D-Bees. Many (20-40%) see the War Camps as a means to support themselves **and/or** they just like a life of raiding, stealing and fighting. 20-33% will have a few implants or 1-2 bionic limbs.

A typical Camp's personnel breakdown.

- 0.01-0.03% Soldati Dimiye/Smoke Soldiers
- 0-1% Wingriders
- 3-5% Cossacks
- 4-5% War-Knights
- 20-25% Soldati/Soldiers
- 45-60% Cyborgs
- 15-20% Cyborg: Shock Troopers
- 10-15% Cyborg: Heavy Machines
- 20-25% Cyborg: Light Machines
- 25-35% Reavers
- 2-4% others mercenaries

Cossack O.C.C.

The Russian Cossack of Rifts Earth is a high-tech version of the Cossack of old. High-tech in that they wield M.D. rifles, Vibro-Swords and wear M.D.C. armor along with the traditional sword and fur cap. Like the Cossack of old, they are horsemen

of astonishing ability. According to myth, "a Cossack child learns to ride before he can walk and has killed his first demon by age 10." Of course this is a glamorous exaggeration, but Cossack children are around horses, alien riding animals and their warrior clansmen from the moment of their birth. Most five year olds know how to ride and handle a knife, while most ten year olds are accomplished riders, and familiar with the sword and rifle. However, a Cossack is not considered a man and allowed to ride on hunts or with war-parties until the age of 16 (occasionally age 15).

Most Cossacks are of mixed heritage of 2-4 different peoples, typically Russian, Polish, Mongolian **and/or** Chinese. While they consider Russia their homeland, the southern Steppe in particular, most consider themselves "Cossack" rather than Russian per se (the cry, "We are Cossack," and, "The Cossack this and the Cossack that," are common turns of phrase. In fact, "We are Cossack," is a frequent answer to the question, "why did you do that?" As if that explains everything). It is a distinction most foreigners don't understand, while Russians tend to regard them as their uncivilized, mongrel cousins. The Cossacks originate from the southern Steppe. Their lifestyle is a bit like the American Indians of the old (and New) West, in that they gather in family clans and tribes, tend to be nomadic, and are a combination of horsemen, warriors, farmers and cattlemen. While at first glance they may appear to be crude and barbaric, closer inspection reveals strong Cossack law, morals, order, unity and incredibly high self-esteem. They live hard, play hard (with fighting and physical contests considered fun "play"), and die with honor — honor to their family, tribe and the Cossack reputation. Honor and loyalty to one's people (i.e. the Cossacks) is of the highest importance. Strength and courage are the next most important, but both also include wisdom, and a sense of compassion and mercy. Of course, Cossack mercy is often a swift death, and truth, honor and sincerity can be proven through life and death trials. While such a trial can be mortal combat, it may also involve a test or feat of insane courage. This can involve anything from battling demons, dragons, or monsters, to a quest, a bloody fight that continues until one stands triumphant or one recants, or riding a normal horse and making him leap over a gorge until one rider relents or the animal and rider falls.

The Warlords of Russia (some with Cossack or similar roots) have adopted the Cossacks' code of honor, justice and punishment. This has made it appealing for some Cossack bands to join the War Camps as champions of Russia and fight under a particular Warlord's banner. They also see the Warlord's mandate to free Russia by destroying demons, dragons, ghosts, and all monsters, and bring peace and prosperity to the Russian people, as something they can believe in and fight for.

The Cossacks have a long history of allying themselves to other powers when they believe in the cause, believe it to be mutually beneficial, to make ends meet (**money/land/livestock**), or to win glory. In the case of the Warlords, the Cossacks believe they are getting all four. However, even though the Warlords' Cossacks have sworn an oath of allegiance and they will fight opposing Cossack clans, these brave horsemen are once and forever "Cossack." This means most members of the War Camp stay together in a tight-knit cavalry **troop**, watch each other's back, and stand together. This unity and strong identity within the War Camp is taken to such a length that those who commit a crime or defy their Warlord are punished, without **favoritism**, by their Cossack chieftain rather than a War Knight or the Warlord himself. The Cossacks function as a group within a group which means they are regarded by the Warlords and most of the other members of the Camp, Reavers included, as outsiders and a temperamental and potentially unpredictable, even unreliable faction. Unreliable in that there are circumstances where the Cossacks might refuse a command or sever their alliance and leave the War Camp, or even fight against the Warlords. Such circumstances would only occur when the Cossacks felt

strongly that an order was so odious, dishonorable and wrong that they could not comply. Such things include supporting a sworn enemy or demonic forces ("Cossacks don't make deals with the devil"), slaughtering innocent women and children with no reason or justification ("Cossack don't kill women and babies. Not even ones as hideous as these" — the latter referring to **D-Bees**), or unconscionable acts of betrayal, or invading Cossack held territories (namely the southern steppe) — all a matter of Cossack justice, truth, honor and courage. Other than this, Cossacks are 100% trustworthy and willing to fight to the death if that is what they have agreed to do. It is also important to understand that they don't have a problem with fighting and killing other bands of Cossacks ("a Cossack's only real challenge is fighting another Cossack"), provided it is a fair fight, and both parties engage in battle of their own free will.

Generally speaking, Cossacks are bawdy, lively, outspoken, rough and tumble nomads given to noisy gatherings, wrestling, **roughhousing**, practical jokes, loud laughter, story telling, singing, dancing, sports, and good-natured brawling and teasing. Although they respect strength, power, and courage, they do not serve it unquestionably nor worship it. Cossacks make clear distinctions between strength of character and standing up for what one believes in (true strength and courage) as opposed to raw strength and power used to brutalize, enslave and crush the human spirit, and reckless courage that jeopardizes lives. Physical power, prowess and skill are appreciated and shown respect, but they are just weapons, like the sword and rifle; a man's true worth lays in how he uses his weapons.

Cossacks also value freedom. Freedom of personal expression, freedom from oppression, and freedom to live like a Cossack. As for death, the Cossacks have this to say, "Death is inevitable. We will all die someday. How a man lives is what's important."

Special Cossack O.C.C. Skills & Bonuses

1. **Horsemanship:** Cossack — Base Skill: 55%/45% +5% per level of experience and includes riding bareback (-10%). It is said that a Cossack can ride anything with four legs, however, while most will ride an exotic Mega-Damage animal into combat, they love horses and prefer to raise and ride them above all others. The horse-like M.D.C. Horned Steed (aka Devil Horse) comes a close second. Robot horses are never ridden although partial bionic horses are acceptable.

Combat: All bonuses are in addition to other combat skills, weapon proficiencies, or attribute bonuses. They apply to the rider, not the horse. The rider gains a combat advantage from the height and speed of being mounted.

- +1 on initiative when on horseback at levels 1, 4, 8, 12 & 15.
- +2 to roll with fall or impact when knocked from a horse.
- +2 to parry or dodge while on horseback.
- Inflicts +6 S.D.C. damage or +1D4 M.D. depending on the weapon (M.D. weapons like **Vibro-Blades** get the M.D. bonus; not applicable to ranged weapons like rifles and blasters), when the weapon is used on horseback.
- Charge attack (running horse) with a lance, pole-arm or spear: +2D6 S.D.C. damage or +1D4 M.D. if a **Vibro-Blade** or other M.D. weapon. The attacker must roll under the second percentile number to avoid being dismounted. Charge attacks count as two melee actions/attacks.



- **Horse attack:** This indicates that the rider is skilled enough to remain saddled while he attacks and has his horse rearing or kicking in simultaneous attack (roll under the second percentile number). Damage from the kick of a horse will vary with the size and breed of the animal; generally 2D6 from the front legs and 4D6 from the rear legs. **Note:** See the Horsemanship Skill descriptions for additional details about horses and care.

2. Breaking/Taming a Wild Horse: To "break" a horse or horse-like M.D.C. creature, first the trainer must get the animal used to being around people, then used to having a saddle on its back (this takes 3D4 days), then used to having a bit in its mouth, and reins. Finally, the trainer must get the animal used to having a rider on its back. Depending on the riding animal, this can take only a week or two (making an attempt every day) or several weeks with moderate success. It takes a lot of skill to stay on a wild horse or exotic animal when he wants you off. Some riding animals are never completely tame, and some will allow only certain people to ride them, while bucking and throwing other riders. During this initial training period the rider must hang on for dear life while the animal does everything in its power to throw him. This battle of wills can last hours and take up to 12 weeks. **Base Skill (Cossack):** 40% +5% per level of experience.

Also includes riding wild bulls (cannot be broken), wild broncos, and other wild and exotic animals as well as *bull wrestling*, but all at -15%. Note that this is fundamentally the same as the Cowboy skill.

3. Herding Cattle: The techniques and methods of leading, directing and controlling cattle in a contained and orderly herd. Also includes keeping animals calm, basic care and feeding, how to tend to cattle, recognizing disease and illness, giving birth to young, how to survive and regain control of a stampede, gathering strays, how best to pen and corral livestock, mending fences, etc. **Base Skill:** 30% +5% per level of experience. Note that this is fundamentally the same as the Cowboy skill.

4. Trick Riding: Riding **bareback**, standing on the animal's back, hanging from the side, or under its belly (usually for rodeo tricks or to hide from enemies), side saddle, as well as quick mounts and dismounts, mounting a horse by leaping down from above or with a running start, leaping from the back of a horse on to another horse or wagon, and similar. **Base Skill (Special):** The trick riding character can attempt all tricks and stunts without penalty; roll on the **first/greater** of the horsemanship skill percentages for success. **Note:** Characters without this skill can *try* any of these tricks, but must roll on the second percentage number of their horsemanship skill after reducing it by half. Roll for each attempt. Likewise, these stunts can be tried while riding mounts other than a horse, which Cossacks often do. This is fundamentally the same as the Cowboy skill.

5. Bonuses: The following bonuses apply only to those born and raised as Cossacks, and reflect years of horsemanship, physical development and combat training starting from childhood. All are in addition to skill bonuses.

- +1D4 to M.A.
- +1D6 to P.S.
- +1D4 to P.P. +1D6 to Spd
- +1D4 to P.E. +3D6 to physical S.D.C.

6. Trick Shooting: The Cossack, like the *Gunfighter*, *Sheriff* and *Gunslinger O.C.C.s* of the New West, gets ALL six abilities!

1. Can fire a traditional two-handed weapon, like a rifle, one handed without penalty (normally the shooter loses all strike bonuses).

2. Can shoot over his shoulder by holding up a mirror and using the reflection to aim without skill penalty to strike.

3. Accurately shoot while riding a horse or a moving vehicle (normally a wild shot), but strike bonuses are half and a "called" shot is impossible even for a Cossack.

4. Shoot accurately while standing on head or hanging upside down; all bonuses applicable at full.

5. Dodge, roll or somersault and come up shooting (normally a wild shot), no bonuses or penalties to strike; straight roll of the dice.

6. Ricochet shot! The shooter can bounce bullets, arrows, and other fired *projectiles* (depending on the specific W.P.) off of one surface and angle the shot in such a way that the projectile **ricochets/bounces** off and hits a **different/second** target! Inflicts only one point of damage to the first surface and full damage to the second. Reduce bonuses to strike by half.

This can also be done with laser weapons but the ricocheting surface must be mirrored or highly polished. Glitter Boys are excellent reflective surfaces for performing a ricochet laser shot. Particle beams, ion blasters, rail guns, mini-missiles and other types of weapons *cannot* be used in this fashion.

The Russian Cossack O.C.C. & NPC Villain

Also known as The Steppe Horseman.

Alignment: Any, but most tend to be good, Unprincipled or Aberrant.

Racial Restrictions: None, although the majority (80%) are humans of mixed Russian heritage, and (sometimes questionable) links to the Cossacks of old. However, the Cossacks are willing to accept anybody who is willing to accept the Cossack life and people as his own. This means living by Cossack law and tradition, and becoming "Cossack" in every way. Even D-Bees (ideally fairly human-looking ones) can be accepted as "Cossack." To help cement the relationship, the Cossack Elders and War Chief (the people who lead the clans and tribes) often *invent* a family, historical, or divine link between them and the newcomers (often vanquished people), thus making them related in some way, and their union some act of divine intervention or fate (another element borrowed from the steppe nomads by the Warlords).

Note: A typical clan numbers **1D6x10** members (mostly family; **uncles**, brothers, cousins, etc.). However, most clans are members of a larger, loose-knit tribe or band that can number into the thousands (typically **1D6x1000**, but sometimes includes as many as **18,000**).

Attribute Requirements: P.P. 12 or higher. High attribute bonuses are **ideal**, but it is said that being "Cossack" is a state of being, either one **is**, or is not.

O.C.C. Skills: In addition to the special skills above ...

- Speaks Russian at 98%
- Speaks Chinese and Euro (+15%).
- Lore: Demons & Monsters (+10%)

Horsemanship: Exotic Animals (+20%)

Land Navigation (+20%)

Wilderness Survival (+10%)

Recognize Weapon Quality (+15%)

Dance (+20%)

Sing (+10%)

Swim (+10%)

Climb (+10%)

Boxing

Wrestling

Running

W.P. Sword plus two ancient of choice.

W.P. Energy Rifle plus one modern weapon of choice.

Hand to Hand: Expert

Hand to Hand: Expert can be changed to Martial Arts for the cost of one O.C.C. Related Skill.

O.C.C. Related Skills: Choose five other skills at level one and one additional at levels 3, 6, 9 and 12.

Communications: Any

Domestic: Any (+5%)

Electrical: None

Espionage: Intelligence and Escape Artist only.

Mechanical: None

Medical: First Aid only.

Military: Any (+5%)

Physical: Any

Pilot Skills: Sailing, Hovercycle, Motorcycle, Snow Mobile/Jet, Jet Pack and similar small, fast vehicles only! Riding horses and other riding animals is part of the Cossack tradition, but the above are acceptable as secondary abilities.

Pilot Related Skills: Any

Rogue Skills: Any (+5%), except Computer Hacking.

Science: Math and Astronomy only (+5%).

Technical: Any (+10%)

W.P.: Any

Wilderness: Any (+5%)

Secondary Skills: The character also gets to select two Secondary Skills from the previous list at level one and one additional at levels 4, 8, 12 and 14. These are additional areas of knowledge that do not get the advantage of the bonus listed in parentheses. All secondary skills start at the base skill level. **Also**, skills are limited as previously indicated.

Standard Equipment: A suit of M.D.C. body armor that is often a hodgepodge of homemade armor (35-65 M.D.C.), or can be any type of modern armor (30-100 M.D.C.) — Warlord Cossacks tend to wear medium, modern armor (50-80 M.D.C. and is usually environmental.

Weapons include a Vibro-Sword (2D6 M.D.), and one weapon for each W.P. plus two extra ammo-clips for each. Other items include a survival knife, a silver knife or sword, silver cross, pocket mirror, gas mask and filter, tinted goggles, hatchet for chopping wood, flashlight, lighter, a medium-sized sack, saddlebags, backpack, bedroll, two canteens or water skins, belt, boots, travelling clothes, cloak or cape (often fur), 30 feet (9 m) of cord (600 lb./270 kg test strength), and some personal items.

Additional weapons, special items and magic items may be acquired over time (and through role-playing). The speed enhancing magical horseshoes and other items of *Mystic Kuznya* are highly prized and coveted.

Vehicle: Starts with a good quality riding horse *and* one un-earthly riding animal; probably a Horned Steed, a favorite. The rare **Megahorse** is highly prized, but exotic riding animals must be acquired over time and through role-playing; getting a Megahorse is a dream most Cossacks never realize (only about 5% ever get one).

Note: Reavers get along great with Cossacks, although there is some rivalry and a feeling that the Cossacks are a bit arrogant and definitely cocky. The soldiers, cyborgs, War-Knights and other members of the Camp tend to regard the Cossacks warily as an independent faction within the Camp. Many also find them to be too cocky, crude and wild for their taste and avoid them. Others share a strong dislike for them or professional jealousy of them. **Unaffiliated**, independent clans of Cossacks are viewed as potentially dangerous threats, raiders, warriors/mercenaries, and adventurers to be regarded with the utmost seriousness and care.

Money: Starts with **2D4x100** credits and **1D4x1000** worth of **tradeable** goods (very likely 1-2 riding animals he doesn't want). Wealth is of little concern to most unmarried Cossacks, among whom fighting and glory are more important. Money and settling down becomes important to those with a wife, children and responsibilities. These older Cossacks will usually try to save money and acquire goods to send back home — home typically being a simple hut or house, 4-10 acres of land, a small farm *and/or* some livestock or small horse/riding animal ranch. Many Cossacks make a living raising, training and selling riding animals to the Warlords, villages, farmers and adventurers in need of fine animals. Of course, the Cossack homeland is the steppe.

Cybernetics: None to start and avoid them as unnatural. The only cybernetics that the Cossack will consider are **prosthetics** and organs to replace those severely injured or lost in combat.

Reaver O.C.C.s

Reavers are the lowest troops in the Warlords' military chain of command and have little chance of ever becoming anything higher. The majority are foreigners (non-Russians), human-looking D-Bees (occasionally monstrous ones), steppe nomads, peasants, barbarians, adventurers, mercenaries, bandits, and mutants who can *not* become true Knights of the Realm nor true Russian patriots.

Within the "Reaver" category of troops are warriors, sorcerers, psychics, disenfranchised knights and soldiers, criminals and other occupations who are accepted by a Warlord's Camp as (reasonably) trustworthy *rogues*. Most are uneducated, and high-spirited. Some are peasants and refugees, others bandits, thieves, brawlers, cocky young adventurers, lowlifes and disreputable ruffians, but all must swear allegiance to a particular Warlord and serve him loyally or suffer the consequences; death is the usual consequence for desertion and treachery. Reavers are typically **frontline** troops who see much battle and get the worst jobs. As foreigners (non-Russians), outcasts, bandits, and D-Bees, they actually have no rights under the Warlords' law, although they are expected to obey it, and will suffer the Warlords' brutal brand of justice if they don't. The life of a Reaver is a hard and uncertain one.

So why become a Reaver?

There are many reasons. One common reason is to be part of something grand — something big — and in so doing, elevate one's own station and importance in life. While most Reavers remain part of a faceless infantry line or fearsome mob of raiders and enforcers, heroes do rise from their ranks to achieve fame and greatness, and sometimes even power and glory. Although not "Knights of the Realm," as members of the Warlords' Camps, the Russian citizens are obligated to show them respect. Thus, the lowly son of a dirt farmer becomes a patriot and (in his mind, if nowhere else) a hero who commands respect and fear. Another basic reason is simply to earn a living. The Warlords provide their Reaver legions with fair pay along with their basic needs (food and equipment), plus they are often allowed to keep some small portion of booty as a reward for a job well done.

Another is purpose. Members of a War Camp are given goals, direction and motivation, with a strong line of command and frequent orders that keep them on track. Hand in hand with this reasoning, is power. Belonging to this elite and powerful group gives even its lowliest members some measure of authority and power over life and death. This can be very alluring to those who have been oppressed or downtrodden themselves, as well as to bullies and those who crave power. Revenge, enjoying fighting, to be with friends or like-minded individuals, patriotism, to see the world, to find acceptance and camaraderie (especially true of D-Bees), to escape the law or wrath of other powers, and so on.

When one stops to think about it, there really is no mystery to why one becomes a Reaver, because the bottom line is very basic: It offers a means to improve one's life.

Note: People, particularly Reavers, are free to leave a War Camp without repercussions, provided they go through proper channels and gets approval from their commander. The Warlords don't need or want those who are disenchanting or rebellious. However, to just "pick up and leave," or run away in combat, are both acts of desertion punishable by death. If the deserter should ever again cross paths with his old War Camp, he will be captured, humiliated, beaten and executed, or attacked and killed on the spot. Likewise, to quit one War Camp to join another is an act of betrayal that will inflame emotions and scream for revenge. Other crimes punishable by death are selling secrets to the enemy, spying for the enemy, defecting to the enemy, openly defying the Warlord or his High Command, jeopardizing one's comrades for personal gain, and similar acts of betrayal.

Characters who possess magical or psionic powers, and all manner of other O.C.C.s known by foreigners (non-Russians), may fall into the Reaver category, but use the O.C.C. description, background and skills of that particular occupation.



The Average Reaver Soldier

The average Reaver is a grunt with minimal skills and education. If he is loyal, hard working, obedient and willing to fight, he's a Reaver to be proud of. Most are basically warrior-peasants and thieves, and can be good, selfish or evil. Exactly what their skills and leanings may be are left primarily to the player and dependent on skill selections. Those who lean toward banditry and criminal life will select primarily rogue and/or espionage skills, while well-intentioned soldiers will look toward combat, W.P., military, physical and technical skills. But all will be limited in scope.

Typical Reaver Grunt/Warrior O.C.C.

& NPC Villain

Also Known as Raiders and Peasant Warriors.

Alignment: Any, but many lean toward selfish and evil.

Racial Restrictions: None, although the majority (80-90%) are human.

Attribute Requirements: P.S. 9, P.E. 9 or higher, and a willingness to serve a Warlord and fight for Mother Russia (or power and glory). High physical attributes are always a big plus, but are not required.



RAMON PEREZ

1998

O.C.C. Skills:

Speaks Native Language at 90%
Speaks two other languages of choice (+10%)
Radio: Basic (+5%)
Piloting: Two of choice (+5%).
Military Etiquette (+5%)
Recognize Weapon Quality (+10%)
Swim (+10%)
Climb (+10%)
General Athletics
W.P. two ancient of choice.
W.P. two modern of choice.
Hand to Hand: Basic, but Hand to Hand: Basic can be changed to Expert for the cost of one O.C.C. Related Skill or to Martial Arts (or Assassin, if anarchist or evil) for the cost of two skills.

O.C.C. Related Skills: Choose six other skills at level one and two additional at levels 4, 8 and 12.

Communications: Any
Domestic: Any (+5%)
Electrical: Basic electronics only.
Espionage: Any (+5%)
Mechanical: Basic Mechanics and Automotive only.
Medical: First Aid only.
Military: Any (+5%)
Physical: Any, except acrobatics.
Pilot Skills: Any, except robots, ships and aircraft.
Pilot Related Skills: Any
Rogue Skills: Any (+5%)
Science: Math only.
Technical: Any (+5%)
W.P.: Any
Wilderness: Any

Secondary Skills: The character also gets to select three Secondary Skills from the previous list at level one and one additional at levels 3, 6, 9, 12 and 15. These are additional areas of knowledge that do not get the advantage of the bonus listed in parentheses. All secondary skills start at the base skill level. Also, skills are limited as previously indicated.

Standard Equipment: The suit of M.D.C. body armor can be a hodgepodge of homemade armor (30-60 M.D.C.) or any modern armor (30-100 M.D.C.) available to the region.

One weapon for each W.P. plus 1D4+1 extra ammo-clips for each, and 1D4 fragmentation grenades. Other items include a survival knife, a wooden cross, 1D6 wooden stakes and a mallet, folding shovel, pocket mirror, gas mask and filter, tinted goggles, flashlight, language translator, lighter, 1D4 large sacks, two small sacks, backpack, bedroll, tent, two canteens or water skins, belt, boots, travelling clothes, and a handful of personal items.

Additional weapons, explosives, special items and magic items may be acquired over time, and through role-playing.

Vehicle: Starts with none, although one may be assigned for special missions and raiding.

Equipment Available On Assignment: Depending on the character, the Warlord, and the assignment the Scout may have access to special weapons, explosives and equipment, vehicles and troops.

Note: Reavers are treated reasonably well by most of their fellow soldiers of the War Camps.

Money: Starts with 1D6x100 credits and 5D6x10 worth of tradeable goods. A Reaver's monthly salary is 500 credits plus food, basic clothing, basic equipment, a tiny cut of spoils from raids they are involved in, medical attention, and other basic needs.

Cybernetics: None to start, but additional cybernetics can be acquired as rewards for outstanding performance and heroics underfire, or purchased by the Reaver (with proper authorization, of course). Approximately half of the more experienced Reavers have at least one bionic prosthetic (arm or leg) and/or a handful of implants.

Reaver Mechanized Cavalry O.C.C.

The Reaver Mechanized Cavalries (RMC) are composed of daredevil maniacs on wheels and jets. Rather than ride animals or mechanical horses, they zoom into battle on combat motorcycles, jet packs and hovercycles. The *Tek-12 YY110 Bushbike*, *Tek-20 YY210 'Borgbike*, *Warrior AH-Hoversled*, *Landflier* and *jetpacks* are among their most favorite.

Hoversled pilots among the Warlords' Camps (Reaver Cavalrymen and **Wingrider** RPA pilots) are often devil-may-care lunatics who literally fly into the heart of battle — we're talking *Juicertype* stuff here. They zip in and out of forest tangle, snake along winding canyon systems, and skim spray from the surface of frozen lakes.

In combat they swoop in, raining death from all directions, weaving around other vehicles and fallen comrades, and dodging enemy fire, while engaging in wild attack runs at 200+ mph (320+ km)! They also make acrobatic maneuvers and use surprise attacks that scatter, confuse and hurt the enemy. Riding into battle isn't as easy as one might think, especially if one wants their troops to remain disciplined and above all, organized under heavy weapons fire, explosive reports, demonic hordes, **hellspawned** magic attacks and swirling melee combat! It requires skill, focus and courage, all commodities held by the Reaver Mechanized Cavalrymen.

Note: Some opponents make jokes about the "Mechanized" Calvary, because most RMC are "partial" cyborgs (43%), with about 12% being full conversion 'Borgs (Heavy and Light Machines). Less than one percent are D-Bees.

Special RMC O.C.C. Abilities & Bonuses

1. Special Combat Maneuver: Reaver Mechanized Cavalrymen (RMC) love to fly in overhead or make spectacular leaps with their vehicles to enable their (typically cyborg or Reaver Cavalryman) passenger to leap off the assault vehicle in mid-air, to land down on the battlefield, in the middle of enemy forces. In the case of cyborgs, their bionic bodies and armor protects them from the fall and inevitable gunfire, but even many of the human warriors and partial 'Borgs engage in this method of attack.

From a tactical point of view, most enemies are so startled and unnerved by this daring attack that those involved or nearby are momentarily stunned; equal to a Horror Factor of 16. Those who roll below a five actually run away and lose 1D4+2 melee attacks/actions other than to run and take cover. Most others (a

roll of 5-16) are momentarily dumbfounded and lose two melee **attacks/actions** even as the leaping attacker and his vehicle driving partner continue their attack! Furthermore, it places powerful cyborg or armored warriors in their midst while the assault vehicle's pilot zips around for continued strafing and brutal assaults. This maneuver is incredibly effective against small groups of 6-12 enemies, especially if a pair of **RMC** are making the **attack**, because it causes confusion, divides/scatters the group and inflicts damage. Using this tactic on larger groups is usually suicidal.

2. Trick Shooting: Like the Cossacks, the *RMC* have mastered some of the arts of Trick shooting, but in this **case**, are limited to only three.

- Can fire a traditional two-handed weapon, like a rifle, one-handed without penalty (normally the shooter loses all strike bonuses).
- Accurately shoot while riding a horse or a moving vehicle (normally a wild shot), but strike bonuses are half and a "called" shot is impossible.
- Dodge, roll or somersault and come up shooting (normally a wild shot), with no bonuses or penalties to strike; straight roll of the dice.

3. Special RMC Bonuses:

+2 on initiative.

+1 to roll with punch, fall or impact.

+1 to pull punch.

+1 to disarm.

+2D6 to physical S.D.C.

+2 to save vs Horror Factor at levels 1, 3, **6, 9, 10**, 12 and 15, and immune to the effect of their own special attack (and similar) as noted above.

RMC Piloting Modifiers: The normal penalties on all evasive, dog-fighting, and trick piloting maneuvers with a vehicle are **half for the RMC**.

Piloting on instinct when blinded or vision is obscured by smoke, fog, etc., means reducing piloting skill only by half (as opposed to **-90%**)!

+1 **action/attack** per melee round when using a vehicle (an extra turn, leap, shot with a vehicle's weapon, etc.).

+1 to dodge when piloting small, fast vehicles like jet packs, hovercycles, snow mobiles and motorcycles.

The Reaver Mechanized Cavalryman O.C.C. & NPC Villain

Also known as Road Warriors and Reaver Maniacs

Alignment: Any, but most are Unprincipled (25%), Anarchist (33%), and Miscreant (20%).

Racial Restrictions: Human; only about one percent are **nonhuman**.

Attribute Requirements: M.E. 12 (incredible nerve and daring), and P.P. 14 or higher. A high P.S. and reasonable I.Q. are **helpful** but not required.

O.C.C. Skills:

Radio: Basic (+10%)

Speaks Russian at 96%

Language: Speaks two additional languages of choice.

Pilot: Motorcycles (+20%)

Pilot: Snow Mobiles (+20%)

Pilot: Hovercycles (+20%)

Pilot: Jet Packs (+14%)

Pilot: Two of choice (+15%); any except robot vehicles, power armor and ships.

Read Sensory Equipment (+10%)

Weapon Systems (+10%)

Land Navigation (+20%)

Wilderness Survival (+10%)

Camouflage (+10%)

Gymnastics

General Athletics

W.P. Energy Rifle

W.P. Heavy Energy Weapon

W.P. One of choice.

W.P. Two Ancient Weapons of choice.

Hand to Hand: Expert

Hand to Hand: Expert may be changed to Martial Arts (or Assassin if evil) for the cost of one O.C.C. Related skill.

O.C.C. Related Skills: Select four other skills at level one and one skill of choice plus one piloting skill at levels 3, 6, 9 and 12.

Communications: Any (+5%)

Domestic: Any

Electrical: Basic Electronics only.

Espionage: Wilderness Survival only.

Mechanical: Basic and Automotive Mechanics only (+10%).

Medical: First Aid only.

Military: Any

Physical: Any, except acrobatics.

Pilot Skills: Any (+10%)

Pilot Related Skills: Any (+10%)

Rogue Skills: Any

Science: Astronomy and Math only (+5%)

Technical: Any (+5%)

W.P. Any

Wilderness: Any (+5%)

Secondary Skills: The character also gets to select four Secondary Skills at level one and one additional skill at levels 2, 5, 7, 10, and 14. These are additional areas of knowledge that do not get the advantage of the bonus listed in parentheses. All Secondary Skills start at the base skill level. Also, skills are limited (Any, Only, None) as previously indicated in the list.

Standard Equipment: A suit of M.D.C. body armor that is typically a hodgepodge of homemade armor (50-60 M.D.C.), but any modern armor (30-100 M.D.C.) can be used. Most RMC prefer medium and heavy armor.

The character starts with a large Vibro-Sword (2D6 M.D.) or **Vibro-Claws** (2D6 M.D.), and one weapon for each W.P. plus four extra ammo-clips for each. Other items include a survival knife, a silver knife or sword, silver cross, pocket mirror, gas mask and filter, tinted goggles, hatchet for chopping wood, flashlight, lighter, a medium-sized sack, saddlebags, backpack, bedroll, a canteen or water skin, belt, boots, travelling clothes, cloak or cape (often fur), 30 feet (9 m) of cord (600 lb./270 kg test strength), and some personal items.

Additional weapons, explosives, special items and magic items may be acquired over time (and through role-playing).

Vehicles: Starts with a jet pack and the choice of one of the following: *Tek-12 YY110 Bushbike*, *Tek-20 YY210 'Borgbike*, *Warrior AH-Hoversled*, *Landflier*, or any type of snow mobile/jet sled.

Note: Reavers in the Mechanized Cavalry are generally regarded as hot-shot heroes by their fellow Reavers and get along well with Cossacks who admire their skill and daring. The RMC are also befriended by, and allowed to hang out with, *Cyborg Shocktroopers* and other cyborg warriors who

often work with the RMC or coordinate attacks with them. This is a great honor, because most of the cyborg elite won't give Reavers the time of day.

Independent mercenaries and adventurers who are the equivalent of the RMC or who once served a Warlord as an RMC, are regarded with suspicion and disdain. Ex-members of War Camps may be called names, shoved and spit upon.



Money: Starts with 2D4x100 credits and 2D4x100 worth of tradeable goods. Wealth is not as important to the RMC as fame, glory, and an opportunity to kick some ..., well you get the idea. Their monthly salary is 750 credits plus food, basic clothing, basic equipment, a small cut of spoils from raids they are involved in, medical attention, and other basic needs.

Cybernetics: Starts with a clock-calendar and gyro-compass. Additional bionics can be acquire as a result of injury or as rewards from the Warlord (the Reaver can decline such a reward if he'd like). Approximately 8% are Light Machines, 4% are Heavy Machines and another 50% have 1-3 bionic prosthetics (arms or legs) and a handful of implants, plus weapons for a bionic limb. Retractable **Vibro-Blades** are extremely popular.

Reaver Assassin O.C.C.

The Reaver Assassin is a rough and ready individual who's always up for causing some hurt and property damage. These people are trained in remote locations of the Warlord's Sphere of Influence. They are subjected to intense testing of physical and mental abilities through a series of punishing obstacle courses, hand to hand fighting and, more importantly, to see if they have the killer instinct.

Of particular interest is the "rockshock" tests given to all these commando-like assassins. Tests designed to take these warriors by surprise, shake them up, and instill the knowledge that calm heads are far more likely to win both the big and the small battles. Assassins in training will be wakened under physical assault and war game conditions to simulate worst case scenarios, and there are a lot of them! This extreme (many would say sadistic) experience creates killers of exceptionally quick response and reflex action.

Like the Reaver Scout O.C.C., these warriors may be assigned to reconnaissance duty, but more often than not, they are sent on Search and Destroy missions and assignments involving assassination, sabotage, sneak attacks, surgical strikes, prison breaks and similar life and death combat situations. It is important to understand that the Reaver Assassin is *not* a spy or secret agent, but a "killing machine." They use stealth and guile only to get close enough to strike a deathblow against their designated target. As "killing machines," they are weapon and demolitions experts and skilled in how to use force, torture, intimidation and violence as a means to an end. They are among the most resourceful, dangerous, sadistic, and evil of the Warlords' minions. Evil because most truly enjoy hurting and killing others — they get a sense of power and accomplishment from it. Even the Smoke Soldiers feel uncomfortable around these torturers and killers, and try to avoid working with them. Unfortunately, one or two Reaver Assassins are often members of teams and squads assigned to covert operations.

When not part of a covert team, Reaver Assassins are allowed to operate as lone wolves or in pairs. Many have infiltrated groups of adventurers, mercenaries and bandits scattered throughout the Russian Frontier (including the Black Market) where they function as double agents. They keep an eye on the organization, pass along strategic information, and quietly undermine (in their case, by killing, blackmailing or discrediting/framing) agents and operations that could be a potential

threat to their respective Warlord. To this end they may also encourage actions that might help their respective Warlord (especially if it weakens a rival Warlord), and weaken the organization they have infiltrated (they play on rivalries, fears, jealousy, etc.). All the while, the Reaver Assassin makes a tidy profit for themselves from the very organization they are secretly undermining. Profit that is usually secreted away and not shared with their Warlord master (85% of these cutthroats do not give their Warlord his full 66% of tribute).

The sense of independence and power held by the Reaver Assassins also contributes to a number of them going completely "independent" or "lone wolf (i.e. leave the service of the Warlord to become a hit-man for hire) on a regular basis. It is also among the Reaver Assassins that the greatest incidents of betrayal to their War Camp and Warlord occurs. Ultimately, about one third will, someday, betray their comrades; that's roughly 10 times greater than any other faction within the War Camp.

Most Reaver Assassins enjoy their work and revel in their reputations as badasses. It is the minority (about 9%) who show some genuine measure of morals, compassion and mercy (typically unprincipled or aberrant alignments). These assassins tend to be more reserved and exhibit a quiet confidence and strength. Many are secretly humanists as a result of the disproportionate amount of death they've been witness to. They hate to see humans hurt or abused, for they realize how easy it is to do. This unusual sentiment can lead to uncharacteristic acts of mercy, quick and painless kills, and conflict within the War Camps, especially among other assassins and ruthless warriors.

Special Reaver Assassin O.C.C. Bonuses

Paired Weapons

Automatic Dodge; can dodge without losing a melee action, but still needs to roll 1D20 (plus the usual bonuses) to be successful.

+1 action/attack per melee round.

+1 on initiative at levels 1, 3, 6, 8, 10, 12 and 15.

+1 to strike with ranged weapons or in hand to hand combat.

+1 to disarm an opponent at levels 2, 4, 8 and 12.

+3 to pull punch.

+1 to save vs Horror Factor at levels 1, 3, 4, 5, 7, 8, 9, 11, 13 and 15.

Reaver Assassin O.C.C. & NPC Villain

Alignment: Technically any, but the majority tend to be Anarchist (33%), Miscreant (30%), Diabolic (24%), or Aberrant (7%).

Racial Restrictions: Predominantly human, although 40-50% are not of Russian heritage and 9% are D-bees.

Attribute Requirements: I.Q. of at least 8, M.E. 10, P.S. 12, P.E. 12 or higher. High physical attributes across the board are helpful, but not required and some may be augmented with bionics.

Psionics: Psionic abilities are not a requirement and only 5% possess Minor psionics, 2% Major abilities, and 1% Master.

O.C.C. Skills:

Basic Math (+5%)

Speaks Euro at 92%

Speaks two other languages of choice (+20%).

Radio: Basic (+10%)

Radio: Scramblers (+15%)

Pilot: Any two of choice (+10%).

Interrogation (+15%)

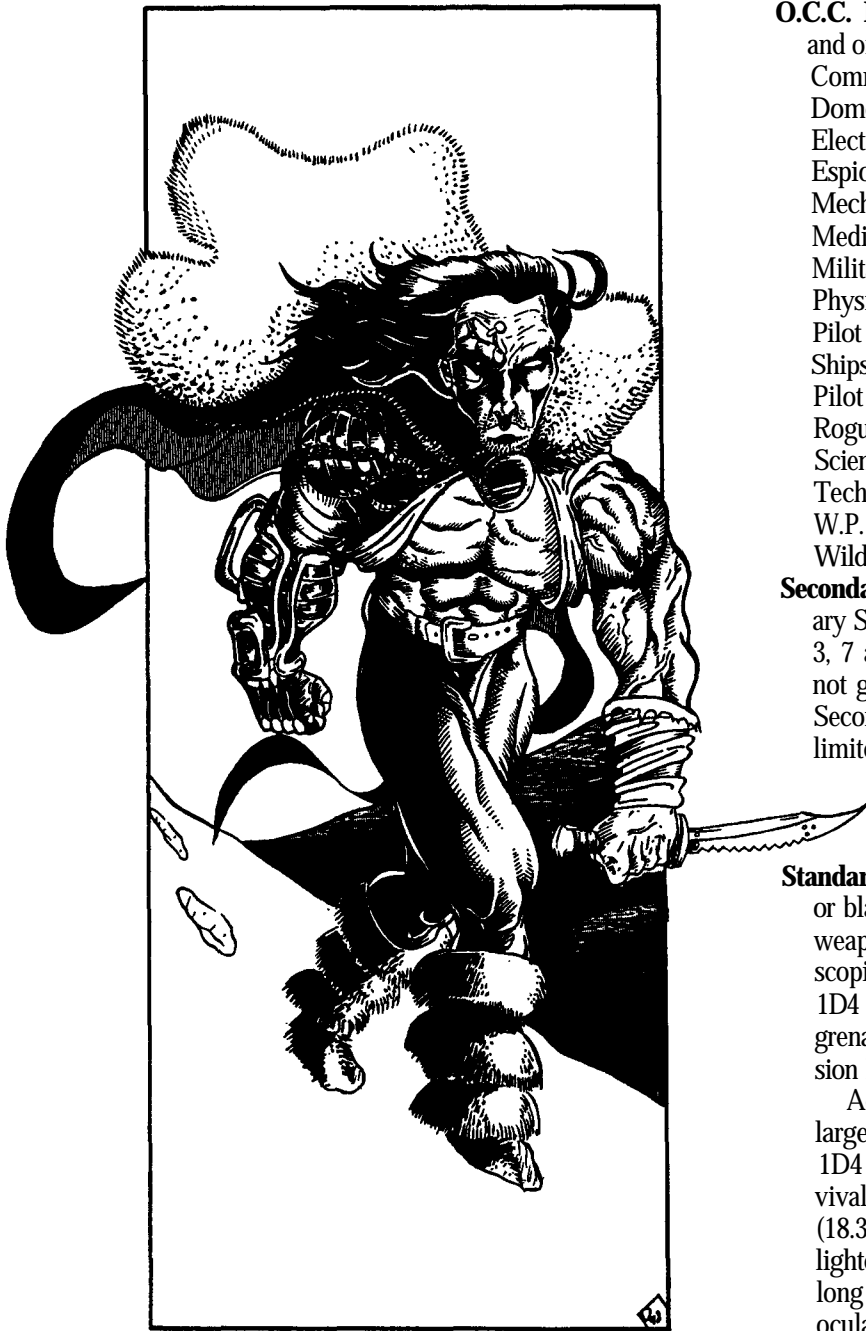

- Find Contraband (+20%)
- Tracking (+10%)
- Prowl (+10%)
- Swim (+10%)
- Demolitions (+20%)
- Demolitions Disposal (+20)
- Underwater Demolitions (+14%)
- W.P. Knife/Vibro-Knives
- W.P. Sword/Vibro-Blades
- W.P. Energy Pistols
- W.P. Energy Rifles
- W.P. Energy Heavy
- W.P. any three of choice.
- Boxing
- Hand to Hand: Assassin (no substitutes are possible).

O.C.C. Related Skills: Choose three other skills at level one and one additional at levels 3, 6, 9 and 12.

Communications: Any (+5%)

Domestic: Any

Electrical: Basic only.

Espionage: Any

Mechanical: Basic and Automotive Mechanics only.

Medical: First Aid only (+5%).

Military: Any (+10%)

Physical: Any

Pilot Skills: Any (+5%), except Power Armor, Robots and Ships.

Pilot Related Skills: Any

Rogue Skills: Any (+5%)

Science: Math only.

Technical: Any (+5%)

W.P.: Any

Wilderness: Any

Secondary Skills: The character also gets to select two Secondary Skills from the previous list at level one, and one at levels 3, 7 and 11. These are additional areas of knowledge that do not get the advantage of the bonus listed in parentheses. All Secondary Skills start at the base skill level. Also, skills are limited (Any, Only, None) as previously indicated in the list.

Standard Equipment: A suit of light body armor that is black or black and grey in color, a suit of heavy body armor, one weapon for each W.P. plus four extra ammo-clips and telescopic scopes with passive **nightvision** sights for each gun, 1D4 hand-held flares, 1D4 **stun/flash** grenades, 1D4 smoke grenades, 1D4+2 grenades of choice, and one type one Fusion Block.

Additional equipment usually includes a pen flashlight, a large flashlight, signal mirror, portable language translator, 1D4 markers, a mechanical pencil, pad of paper, winter survival kit, **compu-drug** dispenser, grappling hook, 60 feet (18.3 m) of thin nylon cord (600 lb./270 kg test strength), lighter, gas mask and filter, tinted goggles, set of clothing, a long winter coat or cloak, backpack, utility belt, canteen, binoculars, commando face paint, and other odds and ends.

Vehicles: Starts with a hovercycle or other basic vehicle. They may also have access to a variety of other vehicles through the Warlords, and "acquire" additional vehicles with the accumulation of experience and wealth.

Equipment Available On Assignment: Depending on the character, the Warlord, and the situation, the character may have access to any type of weapon (including **Triax** and other imports), all types of explosives (including limited access to rare Fusion Blocks), special equipment, vehicles, **costumes/clothing**, false identification papers, money, gold or gems to use as payment and bribes for delicate information, and more.

Secret Resources: Over time (and through role-playing), the Reaver Assassin may establish secret contacts similar to the Smoke Soldier. He starts with none, but one of his first will be an arms dealer **and/or** smuggler to get weapons and explosives without having to go through the Warlord and Officers of the War Camp.

Money: Starts with 1D4x1,000 credits and 1D4x1,000 credits worth of stolen booty, plus his large amount of bionics and weapons. Varies dramatically from character to character.

Most get a salary of about 800-1,000 credits a month, plus are usually allowed to keep 33% of any booty they might "acquire" while on the job, provided that their "acquisition" does not jeopardize their mission — many assassins are greedy and cocky, and take dangerous risks.

Cybernetics: Reaver Assassin Bionics & Special Hardware:

The exact amount and types of bionics and implants can vary with each individual and change over time; 22% are partial cyborgs, 12% are full conversion Light Machines (usually disguised to look human), and 4% are heavy, full conversion cyborgs of one kind or another. The rest have only implants, concealed internal bionics and bio-systems, so they look completely human.

The following is typical of the mostly human, lightly augmented, Reaver Assassins:

- One bionic hand and/or arm with a P.S. of 16-20 and these features:

Fingerjack

Laser Finger Blaster (1D4 M.D., 300 ft/91 m range)

One hand weapon or feature of choice.

Two arm weapons or features of choice (any).

- Bionic Jaw & Reinforced Skull (concealed; the character looks completely normal and has a flesh and blood face) with these features:

Built-in Radio Receiver & Transmitter

Built-in Language Translator

- Clock Calendar
- Cyber-Disguise Type AA-1
- Gyro-Compass
- Lung Implant: Oxygen Storage Cell
- Lung Implant: Toxic Filter

Reaver Military Scout O.C.C.

Reaver Military Scouts are effectively Wilderness Scouts with more of a military background. They use their scouting abilities for military applications such as locating areas suitable for concealment, ambush, manhunts (tracking) and hiding, as well as reconnaissance, patrol duty, escort, and exploration. Ironically, they are somewhat inferior as trackers of animals and hunting, when compared to the Wilderness Scouts or the Huntsman-Trappers, and don't feel as much at home in the woods as other wilderness folk.

One or two Military Scouts will be assigned to Reconnaissance, Seek & Destroy and covert operations teams, as well as leading patrols, trail-blazing, going on exploration missions and manhunts. They are also involved in picking campsites, building base camps, the use of camouflage and concealment, setting ambushes and similar operations.

The Reaver Military Scout O.C.C.

Also known as a Reaver Woodsman and Nature Boy.

Alignment: Any.

Racial Restrictions: None, although the majority (75%) are human

Attribute Requirements: I.Q. 9, and P.E. 12 or higher. A high M.E. and physical attributes are helpful but not a requirement.

O.C.C. Skills:

Basic Math (+10%)

Speaks Russian at 98%

Speaks Euro and two other languages of choice (+15%).

Pilot: Hovercycle (+5%)

Camouflage (+15%)

Detect Ambush (+15%)

Detect Concealment (+15%)

Intelligence (+20%)

Tracking (+15%)

Identify Plants & Fruits (+10%)

Land Navigation (+15%)

Wilderness Survival (+15%)

Swim (+20%)

Climb (+10%)

W.P. Two Ancient of choice (any).

W.P. Energy Rifle plus one energy weapon of choice.

Hand to Hand: Expert, but can be upgraded to Martial Arts (or Assassin if evil) for the cost of one O.C.C. Related Skill.

O.C.C. Related Skills: Choose six other skills at level one and two additional at levels 4, 8 and 12.

Communications: Any

Domestic: Any (+10%)

Electrical: None

Espionage: Any (+10%)

Mechanical: None

Medical: First Aid only.

Military: Any (+5%)

Physical: Any, except Acrobatics and Boxing.

Pilot Skills: Any, except robots, power armor, military vehicles, ships and aircraft.

Pilot Related Skills: Any, but usually none.

Rogue Skills: Any

Science: Astronomy, Botany and Advanced Math only (+5%).

Technical: Any (+5%)

W.P.: Any

Wilderness: Any (+10%)

Secondary Skills: The character also gets to select two Secondary Skills from the previous list at level one and one additional at levels 4, 7, 10 and 13. These are additional areas of knowledge that do not get the advantage of the bonus listed in parentheses. All Secondary Skills start at the base skill level. Also, skills are limited as previously indicated.

Standard Equipment: Light suit of M.D.C. body armor (usually a hodgepodge of homemade armor) painted in camouflage, a **Vibro-Knife** (1D6 M.D.), and one weapon for each W.P. plus three extra ammo-clips for each. Other items include a survival knife, a silver dagger, a wooden dagger (1D6 S.D.C.), hand axe, a hand-sized whisk broom, magnifying glass, infrared distancing binoculars, passive **nightvision** scope for the rifle, flashlight, signal mirror, wooden cross, language translator, lighter, flint and tinder box, two small



sacks, two large sacks, a box of 100 large **sealable** bags for samples, plastic containers, backpack, bedroll, duffle bag, two canteens or water skins, belt, boots, notepad, 1D4 markers, pocket disk recorder and a dozen recordable disks, 30 feet (9 m) of cord (600 lb./270 kg test strength), grappling hook, climbing spikes and small mallet, and a handful of personal items.

Additional weapons, special items and magic items may be acquired over time (and through role-playing).

Vehicle: Most Scouts have a quiet and **maneuverable** hovercycle assigned to them, although many expeditions require slow, careful travel on foot.

Equipment Available On Assignment: Depending on the character, the Warlord, and the assignment the Scout may have access to special weapons, explosives and equipment, vehicles and troops.

Note: Regarded as just another Reaver whose area of expertise is tracking and navigating woodlands.

Money: Starts with 1D6x100 credits and 6D6x10 worth of **tradeable** goods. A Reaver Scout's monthly salary is 600 credits plus food, basic clothing, basic equipment, a tiny cut of spoils from raids they are involved in, medical attention, and other basic needs.

Cybernetics: None to start, but approximately half have at least one bionic prosthetic (arm or leg) **and/or** a handful of implants.

Reaver Bandit/ Raider O.C.C.

Reaver Raiders are criminals and cutthroats with a knack for and criminal skills in stealing, robbery and armed raids. Most are competent horsemen or can drive motorcycles or hover vehicles.

The typical band of Raiders is a small group of 8-16 bandits to platoon size (roughly 40 Raiders) using Highwayman and guerilla tactics. However, large Raiding bands may be the size of an entire company (160 troops) and are sent against large villages or well fortified or heavily defended communities, armed camps and cities. Platoons of ordinary Reavers, soldati, RMC, and cyborgs may also join in on large scale raids and sieges.

The job of "Raiders" is two-fold: One is to raid the enemy, D-Bees, foreigners and rivals from other War Camps for supplies and valuables, and, two, to raid the enemy in an effort to weaken them by stealing their resources **and/or** dividing or picking off members of their troops (ideally, key personnel). Reaver Raiders constantly exploit the element of surprise, carelessness and complacency. They are skilled in recognizing and exploiting opportunities, and in assessing the strengths of opposing forces and the value of their cargo and supplies. Raiders are also used by Warlords and their commanders of the War Camps to punish communities and extract retribution.

Most raids involve a lot of hooting and hollering, along with a hail of (often undirected) gunfire, burning buildings, smoke (often caused by bales of hay or sticks pulled behind horses or vehicles), explosions and other things that are intentionally designed to panic, frighten and confuse the people being raided. The commotion also contributes to the illusion that they are

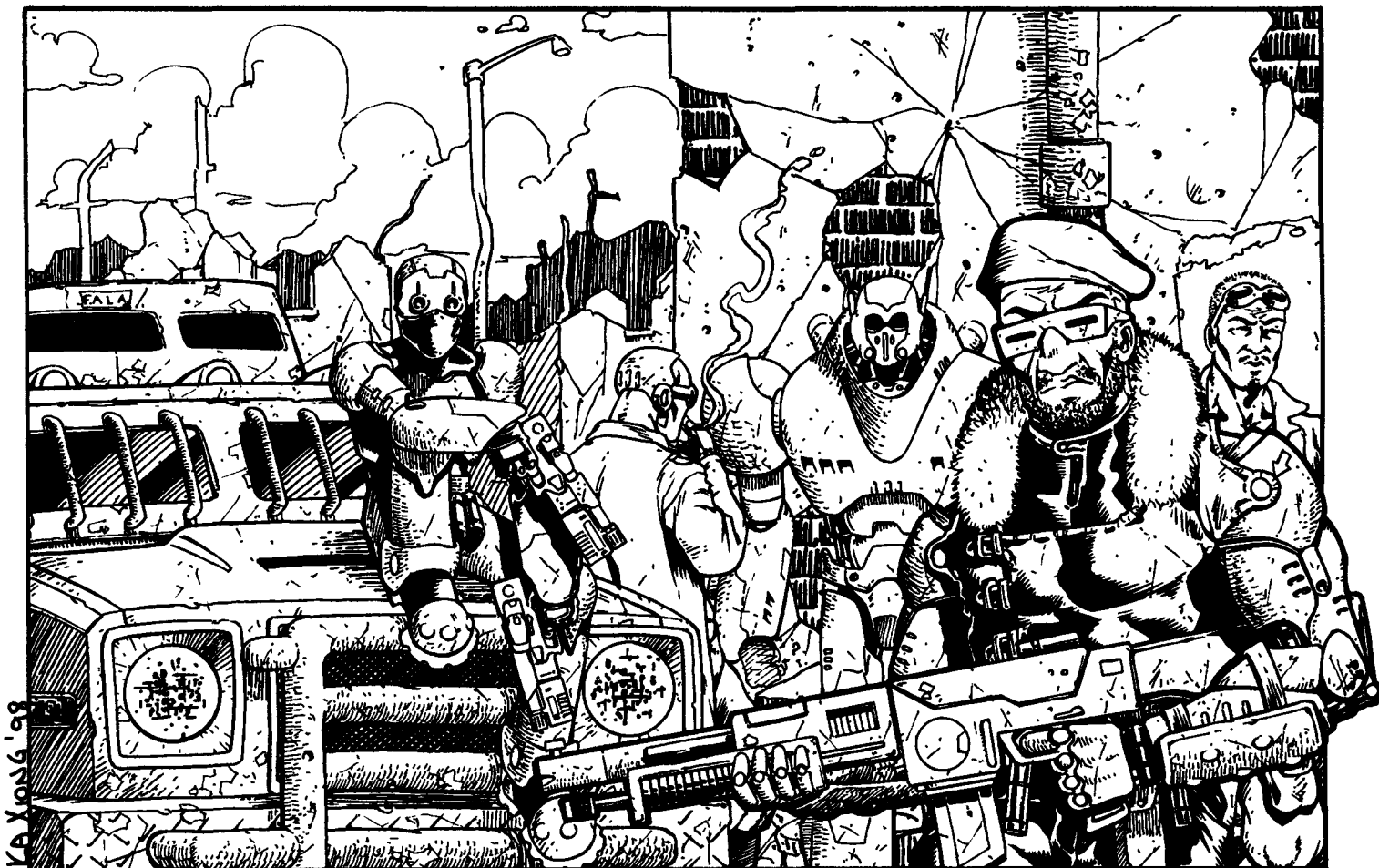

more in number than they really are, as well as creating a diversion. While everybody is responding to the threat in one area or direction, another faction of the Raiding Party is quietly targeting their main objective (horses, cattle, guns, supplies, the bank, the jail, money, other valuables, etc.). Surrounding an opponent or victim is another favorite tactic, as is having snipers in the trees or on rooftops to provide support and add to the illusion that there are more bandits than there really are. These bold attacks are especially effective against peasants, farmers, small villages and travelers caught unawares.

Special Raider O.C.C. Skill & Bonuses

Trick Shooting: Can pick any *one* of the six abilities available under this skill.

Bonuses:

- +2D6 S.D.C.
- +1 on initiative
- +2 to pull punch
- +1 to roll with punch, fall or impact.
- +1 to save vs Horror Factor at levels 2, 4, 6, 8, 10 & 12.

Reaver Bandit/Raider O.C.C. & NPC Villain

Also known as simply Raiders or the Warlord's Henchmen.

R.C.C. Requirements: None, although a high P.S. and P.P. are helpful, and those with a high I.Q. are often the leaders of the gang.

Player Character Note: These basic character stats and background can also be used for bandits, highwaymen and raiding bands not affiliated with the Warlords. Player characters who are bandits, especially those who have ridden with or are a

recognized member of a notorious gang or gang leader, are likely to be wanted criminals with a price on their heads. This means encounters with various War Camps, communities, Hero-Knights and other authority figures *may* result in combat and hot pursuit. Likewise, Huntsmen, bounty hunters, mercenaries, adventurers, and outlaws may want this character for the reward on his head or for justice or revenge. Most villagers hate bandits and will avoid having any dealings with them, except under duress.

Alignment: The typical bandit is anarchist or evil. Robin Hood types and those who exclusively victimize the Warlords, other bandits, or evil forces may be any alignment, including *good*.

O.C.C. Skills:

- Basic Math (+15%)
- Speaks Native Language at 90%
- Speaks two other languages of choice (+10%).
- Radio: Basic (+5%)
- Horsemanship: General
- Piloting: Two of choice (+5%).
- Land Navigation (+10%)
- Gemology (+15%)
- Recognize Weapon Quality (+10%)
- Rope Works (+10%)
- Swim (+10%)
- Climb (+10%)
- General Athletics
- Sniper
- W.P. Siege Weapons
- W.P. two Ancient of choice.

W.P. two Modern of choice (includes energy weapons).

Hand to Hand: Basic, but Hand to Hand: Basic can be changed to Expert for the cost of one O.C.C. Related Skill or to Martial Arts (or Assassin, if anarchist or evil) for the cost of two skills.

O.C.C. Related Skills: Choose two skills from the Rogue or Espionage Category and four other skills of choice at level one, and two additional at levels 4, 8 and 12.

Communications: Any

Domestic: Any

Electrical: Basic electronics only.

Espionage: Any

Mechanical: Basic Mechanics and Automotive only.

Medical: First Aid only.

Military: Any (+10%)

Physical: Any, except Acrobatics.

Pilot Skills: Any, except robots, ships and aircraft.

Pilot Related Skills: Any

Rogue Skills: Any (+5%)

Science: Math only.

Technical: Any (+10%)

W.P.: Any

Wilderness: Any

Secondary Skills: The character also gets to select four Secondary Skills from the previous list at level one and one additional at levels 3, 6, 9, 12 and 15. These are additional areas of knowledge that do not get the advantage of the bonus listed in parentheses. All Secondary Skills start at the base skill level. Also, skills are limited as previously indicated.

Standard Equipment: The suit of M.D.C. body armor can be a hodgepodge of homemade armor (30-60 M.D.C.) or any modern armor (30-100 M.D.C.) available to the region.

One weapon for each W.P. plus 1D4+1 extra ammo-clips for each, and 1D4 fragmentation grenades. Other items include a survival knife, a wooden cross, 1D6 wooden stakes and a mallet, folding shovel, pocket mirror, gas mask and filter, tinted goggles, flashlight, language translator, lighter, 1D4 large sacks, two small sacks, backpack, bedroll, tent, two canteens or water skins, belt, boots, travelling clothes, and a handful of personal items.

Additional weapons, explosives, special items and magic items may be acquired over time, and through role-playing.

Vehicle: Starts with a partial bionic horse with barding or a battered looking hovercycle, motorcycle or similar small vehicle suitable for high speed raids and escapes. It is missing 1D4x10 of its M.D.C. from the main body and looks shabby, but is in otherwise good condition.

Equipment Available On Assignment: Depending on the character, the Warlord, and the assignment, the Raider may have access to special weapons, explosives and equipment, vehicles and troops.

Secret Resources: None to start, but they are likely to develop ties with other criminals, particularly fences, smugglers and Gypsies. Some may even dare to make connections with the Black Market, despite the Warlords' disapproval.

Note: Raiders are the most hated of all the Reavers and considered to be nothing more than bullies, robbers and cut-throats given a license to steal by their Warlord masters. Most other factions within the War Camp avoid contact with this pack of thieves, scoundrels and murderers, and the Cosacks and War-Knights absolutely despise them.

Money: Starts with 1D6x100 credits and 1D6x100 worth of tradeable goods. A Reaver Raider's monthly salary is 500 credits plus food, basic clothing, basic equipment, medical attention, and other basic needs. They also get a 10% cut of the spoils from raids they are involved in, and sometimes get bonus items or an additional 5-10% if they do an especially good job or make a big score.

Cybernetics: None to start, but approximately half have at least one bionic prosthetic (arm or leg) and/or a handful of implants.

Soldati O.C.C.

These men and women are tough, combat experienced warriors, roughly equivalent to what North Americans would consider grunts or Regular Army — foot soldiers dedicated to their cause, country and Warlords. Their duties include patrol missions, Search and Destroy assignments, escort, guard duty, communications, labor and front-line combat. They are battle hardened, ground troops who have decided to cast their fate to the fortunes of war. Their reasons for becoming the Warlords' soldiers are as varied and simple as those of the Reavers. The one big difference is that a Warlord's soldiers are instantly elevated to an elite social position as Knights of the Realm — patriots, heroes of the people, defenders of Mother Russia.

They often operate in squads of 4-6 depending on which Warlord they serve and existing circumstance (see Warlords section for Deployment). These soldiers are hardened to battle and capable of incredible feats of endurance if necessary. Soldati have been known to suffer horribly in the field, surviving only by the slimmest of margins. Those who live to tell about it speak little of the experience.

The dispositions of these raw warriors range from friendly and well intentioned to aggressive or outright hostile, to gung-ho patriots and career soldiers. Most are Soldati for life and will bring their children (male and female) into the military service of their Warlord. The Warlords enforce harsh laws and a rugged way of life, and the soldier does see his share of brutality. What would be considered a savage, bone-breaking interrogation by Western standards is commonplace in the War Camps. D-Bee and monstrous war prisoners, especially Gargoyles and Brodkil, are almost always "softened up" a little before any questioning commences. Their fates are usually grim. Then, of course, there is the stress, fatigue, pain and horrors that come with war. While most Soldati have adapted very well (it is a warrior society that most have been indoctrinated into since childhood, often following family tradition that has been passed down for generations), it all contributes to the soldiers' mental, emotional and physical make-up. It doesn't necessarily make them all evil or **hardhearted**, but it does shape them in many ways. Many are inured to the suffering of others from too much exposure to it, while others are amazingly compassionate, while still others are stoic or sadistic.

An interesting custom among the Soldati is the ritual tattooing of available skin. The patterns vary from War Camp insignias and words to the exotic and frightening. Tattoos may mark certain achievements like "First Kill," bravery, suffering unduly at the hands of the **enemy**, killing many opponents in one battle, or specializing in killing monsters, and so on. In these cases, the

tattoos are worn like badges of honor and added on a case by case basis to give the soldier a sense of accomplishment as he or she advances in status and experience. Tattooing "societies," of no particular name or organization, exist throughout the Camps.

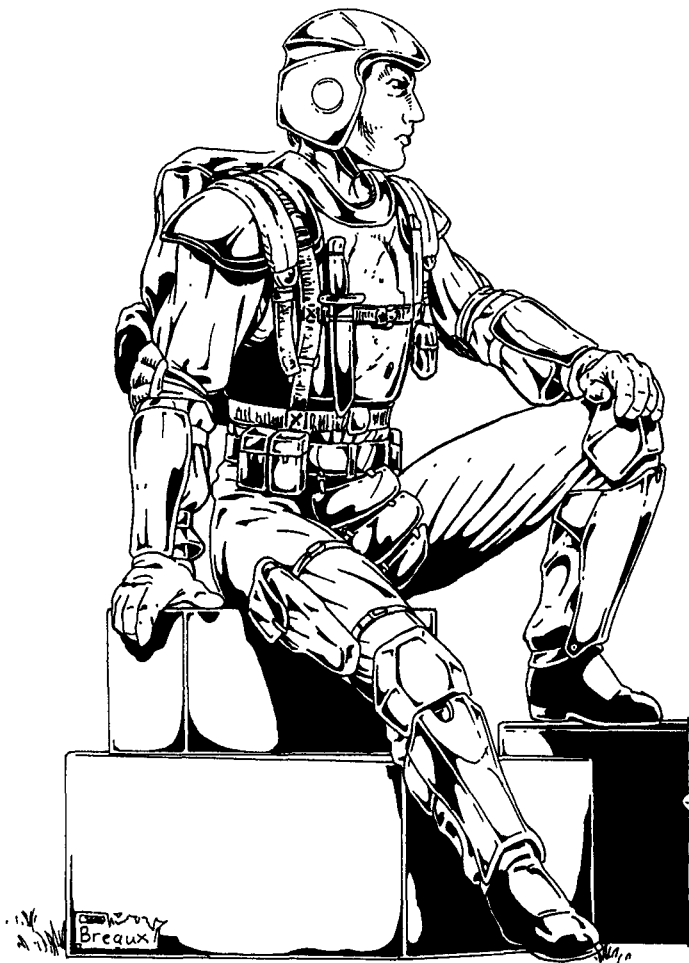

Warlord Soldati/Soldier O.C.C.

Alignment: Any.

Race Restrictions: Exclusively human; approx. 35% are female.

Attribute Requirements: A high I.Q., P.S. and P.E. are helpful but not a requirement. Any human with the spirit to fight and in good health can become a soldier.

O.C.C. Bonuses: +1 on initiative, +1 to pull punch, and +1 to save vs Horror Factor at levels 2, 4, 6, 8, 9, 10, 12, and 14.

O.C.C. Skills:

Math: Basic (+5%)

Speaks Native Language at 92%

Speaks two other languages of choice (+10%).

Radio: Basic (+5%)

Pilot Truck (+10%)

Piloting: Two of choice (+5%).

Military Etiquette (+10%)

Swim (+10%)

Climb (+10%)

General Athletics

W.P. Energy Rifle

W.P. two ancient of choice.

W.P. two modern of choice (including energy weapons).

Hand to Hand: Basic, but Hand to Hand: Basic can be changed to Expert for the cost of one O.C.C. Related Skill or

to Martial Arts (or Assassin, if anarchist or evil) for the cost of two skills.

O.C.C. Related Skills: Select three skills from one of the following skill categories as the character's area of Military Specialty (MOS); each gets a +10% bonus regardless of what may be noted below: *Communications, Mechanical, Medical, Piloting* or *W.P.*

Select four other skills from the list below at level one, plus select one additional skill at levels 3, 5, 7, 10 and 13. All new skills start at level one proficiency.

Communications: Any (+10%)

Domestic: Any

Electrical: Basic electronics only.

Espionage: Sniper and Wilderness Survival only.

Mechanical: Basic & Automotive Mechanics only (+5%)

Medical: First Aid only (+10%)

Military: Any (+15%)

Physical: Any

Pilot: Any (+10%)

Pilot Related: Any (+10%)

Rogue: Any

Science: Astronomy and Math only.

Technical: Any (+10%)

W.P.: Any

Wilderness: Any

Secondary Skills: The character also gets to select two secondary skills from the list, excluding those marked "None," at levels 1, 4, 6, 9 and 12. These are additional areas of knowledge that do not get the advantage of the bonus listed in parentheses. All secondary skills start at the base skill level.

Standard Military issue for Combat Soldiers: Medium or Heavy body armor (may include Triax armor), one weapon for each W.P. plus 1D4+1 extra ammo-clips for each, two smoke grenades, two fragmentation grenades (2D6 M.D.), survival knife, wooden cross, 1D6 wooden stakes and a mallet, folding shovel, pocket mirror, flashlight, distancing binoculars, canteen, utility belt, back-pack, bed roll, tent, additional air filter and gas mask, walkie-talkie (when not in armor), two standard uniforms and one dress uniform, and a handful of personal items.

Additional weapons, explosives, special items and magic items may be acquired over time, and through role-playing.

Vehicle: Starts with none, although one may be assigned for special missions and raiding.

Equipment Available On Assignment: Depending on the character, the Warlord, and the assignment, the Soldier may have access to special weapons, explosives and equipment, vehicles and troops.

Availability of equipment and resources may be dependent upon the local commander, supply stock, location, casualties and combat conditions. The combat soldier is typically at the bottom of priority lists.

Note: Soldati are well respected by the people and treated well by most of their fellow soldiers, including Light and Heavy Machines and War-Knights. Only some of the envious Reavers tend to treat them rudely.

Money: Starts with 2D4x100 credits and 6D6x10 worth of tradeable goods. A soldier's monthly salary is 800 credits plus food, basic clothing, basic equipment, a tiny cut of spoils from raids they are involved in, medical attention, and other basic needs.

Cybernetics: Gyro-Compass to start. Additional cybernetics can be acquired with rank and as rewards for outstanding performance and heroics under fire, or purchased with one's own money (with proper authorization, of course). Approximately half of the more experienced Soldati have at least one bionic prosthetic (arm or leg) and/or a handful of implants.

"Soldati Dimiye"/Smoke Soldiers — Warlord Agent O.C.C.

The Smoke Soldier is a combination Commando, Spy and Ninja! A secret agent/spy who specializes in disguise, espionage, smuggling, reconnaissance, and intelligence, and who is said to be "as elusive as smoke." The Smoke Soldiers are consummate spies and the elite of the elite. A Warlord may enlist many spies, thieves, assassins and cutthroats, but there are rarely more than 50-100 master spies to have earned the title *Soldati Dimiye*, "Smoke Soldiers." That's 50-100 out of as many as 80,000 troops, that's how truly unique, specialized and valuable these agents really are.

There really isn't a "typical" mission for these special agents, but if it involves subterfuge, deception and trickery, they are the men and women for the job. That "job" can be to gather intelligence within enemy territory and Camps, spy on just about anybody (rival Camps, the Black Market, groups of mercenaries and adventurers, the NGR, etc.), infiltrate the enemy, act as a secret courier, serve as a double agent, steal secrets and valuables, engage in rescue operations, sabotage, assassination, efforts to undermine or confuse the enemy (usually from within), kidnapping and extortion, terrorism and anti-terrorism.

One of their most important, yet sublime and underrated skills, is to be incredibly alert and observant without showing their interest or intention. It is said they notice everything and forget nothing. They are such masters of disguise that even their own mothers cannot recognize them when they don't want them to. Also according to legend, these agents are said to have eyes in the back of their heads and can hear a falling leaf hit the ground in their sleep. While this is largely exaggeration, some (about 30%) do possess minor or major psionic powers, including the psi-powers of *Total Recall*, *Sixth Sense* and *Presence Sense*, and all have developed keen memories and tricks of the trade to keep themselves alert and to alert them of danger. Some of these tricks include keeping crickets in a small wire cage (during Summer months), when they stop chirping it usually means somebody approaches; balancing a glass bottle or bell on a door knob/handle so that when it turns the object falls, making a large noise; never sleeping in a bed (usually a mat on the floor), and similar. In addition, a Smoke Soldier must possess the ability to adapt quickly to any situation and to stay cool and calm under fire.

The Smoke Soldier is very highly placed in the Warlord's command structure, often taking orders from and answering directly to the Warlord himself. Thus, the lowliest of these master spies is typically ranked slightly above the War-Knights in status, and answers only to the Warlord and/or his most trusted and

highest placed officers and advisors. This has created an aura of fear and distrust (and sometimes resentment) among the War-Knights and other troops in the War Camps, for none of these grunts know the purpose of the Smoke Soldiers or whether they might be the target of one of their investigations or ever vigilant eyes. Furthermore, one is not likely to know with certainty who all the Smoke Soldiers are — the identities of all but the most notorious are secret, thus your commander, friend or the impish Reaver, or anybody at all, could be a *Soldati Dimiye*. Anybody! The secret identities of these elite spies and the uneasy air surrounding them is intentionally perpetuated by the Warlords to keep the members of their Camps in line and wondering.

The name of the game for the Smoke Soldier is information, who is privy to it, and who is not. Information is bought and sold, traded and worried over just like valuable trade goods. It is their stock in trade, along with the ever-present search for special meaning behind the data. Everything in the spy game can "mean" something, and the Smoke Soldier is skilled at discerning that meaning from an inflection or troubled tone of voice to pretense to recognizing the fingerprints of fear, worry, dissension, love and hate. Why? Because the things that one's enemies love, hate, or fear can be used as weapons or tools against him. Likewise, hatred, dissension, low morale, worry and fear can be fueled and made to spread like wildfire, engulfing all in its path. They and other signs can also tell of, or lead to, a larger story. For example, the absence of a particular officer or person, especially a leader, can mean a great deal. Is he ill? Angry with a superior? Making a secret rendezvous? Drunk, showing a dereliction of duty that can be exploited? Is he with a mistress? Again showing a dereliction of duty and a weakness that can be exploited. Likewise, the presence of certain individuals at a party, meeting, or with known associates can tell a spy much about the person's personality and more importantly, his friends, enemies, and dealings (legal and illegal). All part and parcel of the spy trade, at least for the Smoke Soldiers.

The Smoke Soldier/Spy O.C.C.

Alignment: Technically the spy can be any, but the majority tend to be Anarchist (45%) and Aberrant (25%).

Racial Restrictions: Exclusively human. Over the last 60 years, the Smoke Soldier has become something of a family trade, with the spies teaching family members (male and female) who exhibit the proper aptitude (see Attribute Requirements) and hand picked proteges the secrets of the trade, often at a young age.

Attribute Requirements: I.Q. of at least 13, M.E. 10, and P.P. 12 or higher, along with incredible nerve. A high M.A. and/or P.B. are also helpful, but not required.

Psionics: Psionic abilities are not a requirement, but 19% possess Minor psionics, 10% Major abilities, and 1% Master.

Special O.C.C. Bonuses:

+1 action/attack per melee round.

+1 to disarm an opponent at levels 2, 6, 10 and 13.

+1 on initiative at levels 1, 3, 5, 8, 11, 13 and 15.

+1 to save vs Horror Factor at levels 1, 3, 5, 6, 7, 9, 12 and 15.

O.C.C. Skills:

Basic Math (+20%)

Speaks Russian at 98%

Two other languages of choice (+30%).
 Literacy in Russian (+20%)
 Radio: Basic (+15%)
 Radio: Scramblers (+10%)
TV/Video (+10%)
 Surveillance Systems (+15%)
 Art (draw and sculpt; +10%)
 Disguise (+25%)
 Imitate Voices and Impersonation (+20%)
 Escape Artist (+20%)
 Find Contraband (+15%)
 Palming (+10%)
 Pick Locks (+10%)
 Seduction (+10%)
 Streetwise (+10%)
 Martial Arts or Assassin (pick one).
 W.P. Energy Rifles
 W.P. Energy Pistols
 W.P. One Ancient Weapon of Choice.
 W.P. any of choice, ancient or modern.

O.C.C. Related Skills: Choose four other skills at level one and two additional at levels 3, 6, 9 and 12, but at least one must be from Espionage.

Communications: Any (+10%)
 Domestic: Any
 Electrical: Basic only.
 Espionage: Any (+10%)
 Mechanical: Basic and automotive only.
 Medical: First Aid only.
 Military: Any (+10%)
 Physical: Any
 Pilot Skills: Any (+10%), except Power Armor and Robot.
 Pilot Related Skills: Any
 Rogue Skills: Any (+5%)
 Science: Math only.
 Technical: Any (+10%)
W.P.: Any, although they tend to avoid Heavy categories.
 Wilderness: Wilderness Survival only.

Secondary Skills: The character also gets to select four Secondary Skills from the previous list plus one at levels 3, 6 and 9. These are additional areas of knowledge that do not get the advantage of the bonus listed in parentheses. All Secondary Skills start at the base skill level. Also, skills are limited (Any, Only, None) as previously indicated in the list.

Standard Equipment: A suit of light body armor, a suit of heavy body armor, one energy rifle of choice, two energy pistols of choice, one other weapon of choice (usually a **Vibro-Whip**, **Vibro-Blade** or something concealable), survival knife or other small ancient weapon like the garrotte, punch-daggers, silver throwing spikes or bagh **nakh** (tiger claws; 2D6 S.D.C.), silver dagger, silver cross and chain (worn as jewelry), small mallet, plus 1D4 hand-held flares, 1D4 **stun/flash** grenades, 1D4+2 smoke grenades, and one fragmentation grenade.

Additional equipment usually includes a pen flashlight, a large flashlight, portable language translator, hand-held computer, hand-held video camera, pocket disk recorder, sketchbook, 2D4 markers and pens, a mechanical pencil, first-aid kit, **compu-drug** dispenser, grappling hook, 60 feet (**18.3 m**) of thin nylon cord (600 lb./270 kg test **strength**), four pairs of

everyday clothing, two pairs of **dress/formal** clothing, a long winter coat or cloak, two pairs of disguise clothing (may be Sovietski or Warlord Camp, Orthodox priest or almost anything. All garments will be strictly accurate and current as of the beginning of play), plus a *disguise kit* with make-up, glue, 1D4+2 hair dyes, body paint, and basic appliances for eyebrows, hair, moustache, nose, scars, etc. **Note:** The character is likely to have several ready-to-use disguises, wigs, sets of clothes, gimmick clothing (i.e. reversible jacket with hidden pockets), costumes, and additional appliances — perhaps a complete make-up room and lab for designing and making facial and body appliances, false teeth, etc., all hidden away in one his sanctuaries (starts with one hide-out: a safe basement or room at a boarding house or a home in a village someplace, but player characters can establish others as they see fit. NPCs will have one or two for every level of experience). The more experienced the Smoke Soldier, the larger his or her wardrobe and collection of disguises.

Vehicles: All Smoke Soldiers will own a bicycle, motorcycle and hovercycle. They may also have access to a variety of other vehicles through the Warlords, and "acquire" additional vehicles with the accumulation of experience and wealth.

Equipment Available On Assignment: Depending on the spy, the Warlord, and the situation, the Smoke Soldier may have access or use of almost anything, furnished by his Warlord. This might include Fusion Blocks or other explosives, special weapons, equipment, vehicles, disguises, costumes/clothing, medals, false identification papers, money, gold or gems as payment and bribes delicate information, and more.

Secret Resources: Suppliers, Contacts & Informants. In each case, these are contacts the Smoke Soldier has developed and are not known to the Warlord or his Knights (it's best they don't know as many are likely to be members of the Black Market or other criminal gangs and organizations, D-Bees, sorcerers and others). Most Warlords are only concerned with results and don't bother themselves with the means required to accomplish the task.

Suppliers: These are people who secretly help the agent by *supplying* him or her with disguises, special glues and paints, clothing and special equipment from false teeth or a realistic looking rubber nose, to boots, belts and clothing with concealed compartments and pockets, to miniaturized smoke bombs, stink bombs, listening devices, modified weapons, and contraband.

Most do not know the Smoke Soldier's profession nor do they ask. Most are criminals **and/or** outcasts who provide special services **and/or** goods to the criminal underworld; the spy is only another client. Others will be legitimate craftsmen, artisans, smiths, tailors and Operators glad to get commissioned work, and who have no idea what their patron needs such unusual items for. All work for money or trade of goods or services.

The player character will start with four such contacts. Others should be established through role-playing.

Special Contacts: Smugglers, trusted couriers (pick up and drop off packages, messages, etc.), weapons dealers, fences, forgers, thieves, mercenaries, people who provide safe houses, doctors (specializing in the discrete treatment of injuries without asking questions), and similar, including D-Bees and practitioners of magic. These types of "contacts" are pro-

professionals who engage in adventuring and/or illegal activities. All work for money or trade of goods and services.

However, a contact (and sometimes *informants*) may be an old woman sitting in her cellar with a radio, or it may be a beautiful Hungarian gypsy dancer, or a boy of fourteen who serves coffee to local officials every Tuesday at their weekly meeting. Their reason for helping can be anything from a favor, revenge or patriotism to money.

Contacts come in many forms. None are ever completely trusted, especially those linked to disreputable occupations. They may be completely "straight" with an agent or have their own agenda or scheme.

The player character will start with two such contacts. Others should be established through role-playing and interaction with NPCs.

Snitches/Informants: Professional informants, stoolies, snitches, whatever you want to call them, are usually motivated by money, or such things as revenge, influence, business opportunities, to avoid exposure for past crimes (blackmail), or to protect loved ones (also blackmail), and so on. Whatever their reasons are, they will meet with agents at special places (usually places where the informant feels safe or has friends), or communicate through secret code.

It is safe to assume that professional "information merchants" are not entirely trustworthy (anarchist or evil alignments). Informants can usually be bought off for money and are susceptible to threats and blackmail — bad news if that individual is one of the Smoke Soldier's enemies. It happens all the time. Or they may try working their own deals, add conditions to or increase the cost of their original asking price for their information (especially if they can smell desperation or great importance regarding what they know), as well as sell the same information to anybody who can afford it (including known enemies of the Smoke Soldier). Prone to double-crosses and pay-offs, they are likely candidates to lure agents into ambushes and traps, and give them up to their enemies served up on a platter, provided the price or incentive is sufficient (most will do anything to save their own scrawny necks). They will also sell any information the spy might accidentally (or deliberately) reveal to them, including the fact that he paid the snitch a visit and the things he wanted to know.

Money: Starts with 1D6x1000 credits and has a large amount of equipment. Varies dramatically from character to character. Most get a salary of about 2000 credits a month, plus are usually allowed to keep any booty they might steal while on the job, provided that action does not jeopardize their mission — most Smoke Soldiers are too professional to let greed interfere with their mission.

Cybernetics: All are humans, 30% with limited psionic powers. Among the majority (70%) who don't possess some measure of psionics, approximately one third will have 2-8 implants or one bionic limb and 2-4 implants. The others avoid bionics, although they may have fake **prosthetics** and gauntlet-like coverings in order to disguise themselves as cyborgs.

War-Knight O.C.C.

These are the greatest and most respected Knights of the Realm, the elite heroes of the War Camps and champions of the people. Among the War Camps, 60% of the War-Knights serve as officers and elite troops; more than half of all *Field Marshalls* and *Commanders* are War-Knights with lesser War-Knights as their officers and seconds. They are assigned to head sub-bases and may lead Strike Teams, platoons, companies, and battalions, as well as head up special missions, important raids, covert operations and the collection of tribute. During times of war, a *War-Knight Field Marshall* commands an entire Army Division (5760 troops), however, during quieter times he typically leads a Battalion (640 troops) or Brigade (1920 troops).

The 40% not serving as officers of the War Camp are members of special Cavalry Companies composed entirely of War-Knights, or lead elite units (mixed men at arms O.C.C.s), or travel the land as lone knights, or in pairs or small groups, as notorious heroes and representatives of the Warlord. As representatives of their Lord, they function as a combination law officer, judge, enforcer and protector of the people. This means they help defend the people, battle evil, right wrongs and offer advice, judgements, settle disputes and collect tribute.

The War-Knights are the closest thing the Warlords have to genuine Knights of the Realm. They are the most seasoned, patriotic and (arguably) deadliest fighters of the War Camps. Few warriors are as honored and respected, and most lesser warriors strive to be like them. While the Cossacks, Heavy Machines and Cyborg **Shocktroopers** may be more feared, the War-Knight is considered the pinnacle of achievement in soldiering. Although some are savage and merciless, even **evil**, they are regarded as noble heroes and Mother Russia's most dedicated champions. Of all the Warlord's troops and of most independent heroes, warriors, mercenaries, adventurers and wise men, the people turn to the War-Knight with little or no hesitation. These elite knights are trusted and welcomed above most others; only the *Mystic Kuznya* (smith) and *Bogatyr/Hero-Knight* are more trusted and revered.

The Russian War-Knights seem to respond to the gratitude and trust of the people by rising to their expectations and behaving like the noble and honorable heroes they are acclaimed to be. War-Knights are known for their courage, common sense, and dedication to the destruction of monstrous evil and the defense of the Russian people from all oppressors, monstrous and **humanoid** alike. Thus, most are gracious, kind and tolerant toward Russian citizens, from the peasants to the village elders. Even most Reavers don't question their authority and trust in their leadership.

War-Knights are typically charismatic, armor clad warriors who appear as a strange mixture of the Teutonic Knights of old and power armored horsemen. The typical armor of the War-Knight has an ornate, classical appearance with obvious touches of advanced weaponry and technology. For example, while a suit of armor may, at first glance, resemble a knight of old, closer inspection will usually reveal one or more retractable **Vibro-Blades** in the forearm of at least one arm, and a forearm energy weapon built into the other (typically laser or ion blaster), which makes it a light power armor. A Vibro-Sword or Vibro-Axe, or magic weapon usually hangs on the belt as one of

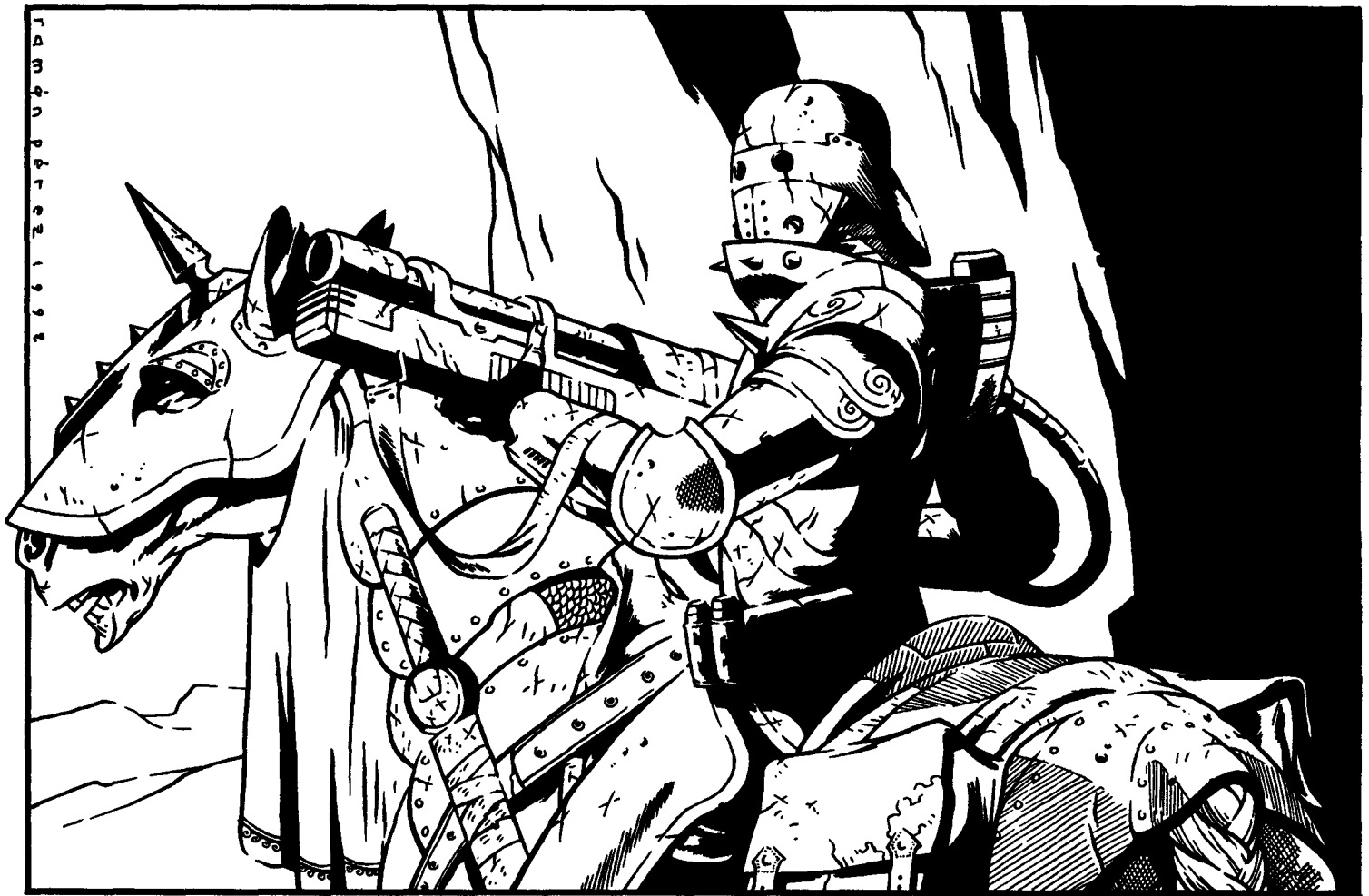

his sidearms, while a handful of other weapons are slung over the shoulder or tucked along the saddle. Note: Other than the Warlord and his most trusted Generals and Advisors, the War-Knight is the only member of his War Camp given permission to wield magic weapons and enchanted items.

Most ride partial or full bionic horses or massive, monstrous steeds often referred to as Mega-Steeds or **Megahorses** — one of the trademarks of the War-Knight. The term "**Megahorse**" originates with an intelligent, powerfully built alien creature that closely resembles an Earth War Horse, only bigger and more majestic (See the True Megahorse described elsewhere in this section, but depicted in the illustration). Approximately 14% ride "true" Megahorses, while 10% prefer hovercycles or other small, fast vehicles over a **mechanized** horse or massive Mega-Steed.

The War-Knight O.C.C.

Alignment: Any, but most are Scrupulous (25%), Unprincipled (20%), or Aberrant (17%).

Racial Restrictions: Exclusively human.

Attribute Requirements: I.Q. 9, P.S. 12, P.P. 12 or higher, along with a high sense of responsibility and dedication to serve and protect. A high M.A., M.E. and P.E. are also helpful, but not required.

Psionics: Psionic abilities are not a requirement, but 12% possess Minor psionics, 4% Major abilities, and 2% Master psionics (in the latter case, the character has all the psionic abilities of the Mind Melter, minus 10% of the usual I.S.P. and half the super-psionic abilities, but uses the O.C.C. skills

listed under the War-Knight O.C.C., and gets none of the O.C.C. Related Skills).

Special O.C.C. Bonuses:

- +1 on initiative at levels 1, 3, 5, 8, 11 and 14.
- +1 to roll with punch, fall or impact.
- +1 to pull a punch at levels 1, 3, 5, 7, 9 and 11.
- +1 to disarm an opponent at levels 2, 4, 6, 10 and 14.
- +1 to save vs Horror Factor at levels 1, 2, 4, 6, 8, 10, 12 and 14.
- +2 to save vs possession.

O.C.C. Skills:

- Basic Math (+15%)
- Speaks Russian at 98%
- Two other languages of choice (+20%).
- Lore: Demons and Monsters (+20%)
- Lore: One of choice
- Radio: Basic (+10%)
- Horsemanship: Knight
- Horsemanship: Exotic Animals (+15%)
- Tracking (+10%)
- Military Etiquette (+20%)
- Military Fortification (+10%)
- Recognize Weapon Quality (+20%)
- Wilderness Survival (+20%)
- Streetwise (+6%)
- Body Building
- Running
- Boxing

W.P. Sword (including Vibro-Swords)
W.P. Energy Rifles
W.P. Energy Heavy
W.P. Two W.P. of choice (any).
Hand to Hand: Martial Arts (or Assassin if evil).

O.C.C. Related Skills: Choose four other skills at level one and two additional at levels 3, 6, 9 and 12.

Communications: Any (+5%)

Domestic: Any

Electrical: Basic only.

Espionage: Any

Mechanical: None

Medical: First Aid only (+10%).

Military: Any (+10%)

Physical: Any

Pilot Skills: Any, except robots, ships and aircraft (+10% to all horsemanship/riding skills).

Pilot Related Skills: Any

Rogue Skills: None, other than Streetwise, above.

Science: Astronomy and Math only.

Technical: Any (+10%)

W.P.: Any

Wilderness: Any

Secondary Skills: The character also gets to select three Secondary Skills from the previous list at level one and one additional at levels 3, 5, 7, 10 and 13. These are additional areas of knowledge that do not get the advantage of the bonus listed in parentheses. All Secondary Skills start at the base skill level. Also, skills are limited as previously indicated.

Standard Equipment: Custom War-Knight Power Armor (see basic stats and features following the O.C.C. description), a large Vibro-Sword or Axe (both do 3D6 M.D.), a Vibro-Knife (1D6 M.D.), an energy rifle or heavy M.D. weapon of choice, one other weapon of choice, silver survival knife, hand-held wooden cross, and a small to medium-sized Mega-Damage shield (30 M.D.C., used for parrying and blocking attacks particularly when charging).

Additional equipment: One set of dress clothing, casual clothing, cape or cloak, pair of gloves, a suit of light body armor (for those quiet moments and relaxing among a large War Camp), backpack, two saddlebags, bedroll, tent, three canteens or water skins, three small sacks, two large sacks, belt and scabbard, other belts, flashlight, portable language translator, notepad, 2D4 markers and pens, winter survival kit, 50 feet (15.2 m) of thin nylon cord (600 lb./270 kg test strength), and a handful of personal items.

Additional weapons, special items and magic items may be acquired over time (and through role-playing).

Vehicle: A Mega-Steed; roll percentile to determine what kind:

01-15 A robot horse or other vehicle.

16-20 A partial bionic horse with M.D.C. **barding**.

21-45 A full bionic horse.

46-85 A Mega-Steed, i.e. a large, powerful, mega-damage riding animal from another world (described elsewhere).

86-95 A True Mega-horse!

96-00 Some other powerful alien or magical creature (Centaur, Pegasus, **Kilin**, Seeker, **Eurotorpid**, **Tri-Wolf**, etc.; *See Mindwerks™* for the last three creatures in this list). Descriptions of the **Megahorse** and other Mega-Steeds are located elsewhere.

Equipment Available On Assignment: The War-Knight may be given access to use of almost anything, furnished by his Warlord. This might include Fusion Blocks or other explosives, special weapons, equipment, vehicles, magic items and so on.

Secret Resources: None per se, although many will, with time (and through role-playing), win the favor of various people who can serve as friends, allies, and informants. Generally speaking, most common folk are very cooperative.

Money: Start with 1D4x1000 credits and they get a monthly salary of 2000 credits (Officers above lieutenant get double, and Field Marshalls get triple), plus all needs and military weapons, equipment, and steeds are provided for by the Warlord. Wealth is of little concern for most War-Knights. However, under the Warlords they are treated like heroes and princes who enjoy the best food, clothes, accommodations and privileges of rank. Magic weapons and special items are given as rewards for distinguished service, heroism and special needs/assignments.

When visiting most communities, War-Knights are given the finest accommodations, food, drink and service, plus are usually offered gifts in the way of armor, weapons, magic, healing, and information. Only the youngest (those under 4th level) and those War-Knights with a reputation for cruelty and treachery, are treated coolly **and/or** feared and avoided by common folk. The majority of War-Knights graciously refuse most of these gifts knowing that the villagers probably can't really afford to give them away. Only those items and services that are truly needed, rare, or greatly desired are accepted. It is also said that the noblest War-Knights never forget a kindness. Warlords allow these heroes to keep any "gifts" given to them by the people, as well as special weapons or magic items they might win in combat.

Cybernetics: Approximately 3% are full cyborgs, 6% are partial cyborgs, 21% have one bionic limb with two weapon features, plus 1D4 implants, and 20% 1D4+2 implants **and/or** internal organs but no artificial limbs or other form of bionics. Additional bionics *may* be acquired over time, but most War-Knights try to avoid becoming even partial 'Borgs.

Typical War-Knight Power Armor

The armor of most War-Knights is a full, environmental power armor with all the basic features of power armor, including strength and speed augmentation, but no flight capabilities. Some are used in conjunction with minor bionic augmentation and weapon prosthetics. The exact specification and features of the armor varies among the War-Knights, but the following is the usual range of M.D.C., abilities and features.

M.D.C. by Location:

* Retractable Vibro-Blade (1-2) — 80 each

* Forearm Weapon (1) — 50

* Head/Helmet — 60-80

* Arms (2) — 80-120 each

Legs (2) — 100-150 each

**Main Body — 2D6x10 +110

* A single asterisk means the area is small and difficult to target. Attackers must announce an "aimed shot" and are -3 to strike.

** Destroying the main body destroys the armor and its augmentation.

Augmentation, Bonuses & Features of Note: Applicable only when the power armor is worn.

- Full environmental capabilities.
 - P.S. is equal to a Robot P.S. of 26-30.
 - Running speed is the wearer's Spd attribute **x10**. Fatigue is reduced to **10%** the normal fatigue factor, and they can leap 10 feet (3 m) high and 15 feet (4.6 m) across; double with a running start.
 - +1 attack per melee round at levels 2, 6 and 12.
 - +1 on initiative.
 - +1 to strike and parry.
 - **Damage:**
 - Restrained Punch: 1D4 M.D.
 - Punch: 1D6 M.D.
 - Power Punch: 2D6 M.D. but counts as two attacks.
 - Kick: 2D4 M.D.
 - Leap Kick: 2D6 M.D.
 - Body Flip/Throw or Tackle: 1D4 M.D.
- Cost: Most are provided by the Warlord, but those sold on the Black Market go for 1.6 to 2.5 million credits.

Warlord Cyber-Doc O.C.C.

Warlords control the designing, building and production of bionics and cybernetics within their respective Sphere of Influence and throughout much of Russia. Only the Sovietski is legally allowed to produce bionics and cybernetic components for themselves and for sale and trade to the various Warlords and their Camps. In this regard, the Sovietski is something of a Free Trade Zone selling to virtually all competing Warlords, but agreeing not to sell bionics (at least not openly) to adventurers, mercenaries and unallied factions. Likewise, each of the Warlords can distribute bionics throughout their War Camps, but most do not sell to outsiders. The sale or distribution of bionics is otherwise illegal anywhere else in the Russian Frontier, and those caught are executed on the spot. However, this has not dissuaded the Black Market or countless Arms and Bionics dealers, Importers, and Body-Chop-Shops who have set up shop on the borders of neighboring countries. Poland is especially blatant about it.

The Warlord's control over their Spheres of Influence in Russia means they also control the majority of Cyber-Docs in the country. This helps them to control and monitor the use of bionics in their region and specifically, among their own troops. Unauthorized bionics are forbidden in the War Camps, but permission to get authorized augmentation is quick and easy. Bionic augmentation and usage for medical purposes is withheld or limited only from troops with a reputation for trouble or treachery.

The Warlord Cyber-Doc is essentially the same as most other Cyber-Docs around the world. However, because such a huge number of the War Camp's troops are partial to full conversion 'Borgs, bionics are quite prevalent in Russian society, and be-

cause the troops see such frequent military action, these Cyber-Docs are experienced, skilled surgeons and field doctors. Many labor under horrendous battle conditions all too frequently, forcing them to develop an abbreviated method of cybernetic surgery. A prognosis can typically be made in seconds, even for tricky problems not immediately evident to city doctors. These Cyber-Docs tear out and replace or repair bionics on the spot and slap them back in to make way for the next wounded man. Repair and bio-surgery is performed right on the battlefield whenever possible.

Some are assigned to Warlord Cybernetic Factories, where they install bionics at the factory and help supervise the development and applications of new designs. They also frequently make full conversions of new Cyborg Shocktroopers at such facilities. Others are assigned to elite and secretive units where these Cyber-Docs augment Smoke Soldiers and other secret agents and special operatives.



Warlord Cyber-Doc O.C.C.

Also Known as Cyber-Hack, Machine-Doc and Field-Doc.

Alignment: Any, but many lean toward selfish.

Racial Restrictions: Exclusively human; about 40% are female.

Attribute Requirements: I.Q. 11 or higher and a P.P. of 12 or higher. A high M.E. and good hand/eye coordination are helpful but not required.

O.C.C. Bonuses: +1 to save vs disease and +2 to save vs horror factor, +1 to parry and dodge

O.C.C. Skills:

Speaks Native Language at 98% (33% are Ukrainian or other nationality).

Speaks two other languages of choice (+15%).

Literate in Russian (+20%)

Math: Basic (+20%)

Math: Advanced (+10%)

Biology (+30%)

Chemistry (+10%)

Pathology (+20%)

Medical Doctor (+15%)

M.D. in Cybernetics (+20%)

Electrical Engineer (+10%)

Mechanical Engineer (+5%)

Computer Operation (+10%)

Computer Programming (+10%)

Read Sensory Equipment (+20%)

Military Etiquette (+10%)

W.P. Knife

W.P. Energy Rifle

Hand to Hand: Basic, but can be changed to Expert for the cost of two O.C.C. Related Skills.

O.C.C. Related Skills: Select five other skills at level one, and two additional skills at levels 3, 6, 10 and 14. All new skills start at level one proficiency.

Communications: Any

Domestic: Any (+10%)

Electrical: Any (+5%)

Espionage: None

Mechanical: Any

Medical: Any (+15%)

Military: Field Armorer and Find Contraband only.

Physical: Any, excluding boxing, wrestling and acrobatics.

Pilot: Any, except tanks, APCs, robots, ships and power armor.

Pilot Related: Any

Rogue: None

Science: Any (+10%)

Technical: Any (+15%)

W.P.: Any

Wilderness: Identify plants, land navigation, & preserve food only.

Secondary Skills: The character also gets to select three Secondary Skills from the list at level one, plus one additional at levels 4, 8 and 12. These are additional areas of knowledge that do not get the advantage of the bonus listed in parentheses. All Secondary Skills start at the base skill level.

Medical Equipment: Medical harness with its many pouches, two dozen throw-away (paper) surgical gowns, hand-held computer, pocket-size CD audio recorder with 12 three hour discs, an additional laser scalpel, mechanic's tool kit and portable laboratory.

Medical kit with soap, disposable towels, bandages, suture tape, antiseptics, protein healing salve, aspirin, painkillers, antibiotics, sedatives, anesthesia, hypodermic gun, stethoscope, pen flashlight and portable **compu-drug** dispenser.

Surgical kit includes a variety of scalpels, one laser scalpel, needles, clamps, sutures, suture tape, suture gun, several **IRMSS/Internal Robot Micro-Surgeon Systems**, **RMK/Robot Medical Kit**, hand-held blood pressure machine (computer-

ized), 3D4 thermometers, six unbreakable specimen containers, 100 pairs of disposable surgical gloves, two pairs of reusable surgical gloves, surgical gown, digital stethoscope, several tiny surgical flashlights w/**clamps**, several plastic vials, portable compu-drug dispenser and other basic items.

Additional Field Equipment: Includes a suit of light body armor for field use, energy rifle of choice, energy pistol side-arm and two **E-Clips** for each, silver dagger, canteen, utility belt, backpack, bed roll, tent, air filter and gas mask, walkie-talkie (when not in armor), two signal flares, two smoke grenades, two standard uniforms and one dress uniform and a handful of personal items.

Equipment Available On Assignment: Depending on the character, the Warlord, and the assignment, the Cyber-Doc may have access to a field hospital, full hospital, bionics factory, and all types of cybernetics, implants, organs, and bionic weapons, as well as additional weapons, equipment, vehicles and medical assistants **and/or** protective troops.

Availability of equipment, bionic components, and resources may be dependent upon the local commander, supply stock, location, causalities and combat conditions. The Cyber-Doc tends to be at the top of priority lists, but supplies may be short.

Note: Cyber-Docs are highly regarded by most troops, but especially the many partial and full conversion cyborgs who may have to rely on them to save their lives and get them back into working order.

Money: Starts with 2D6x1000 credits and 3D6x100 worth of **tradeable** goods. A **Cyber-Doc's** monthly salary is 4000-6000 credits plus the finest accommodations, food, drink and services. They also get special items as bonuses and bionics if they want them.

Cybernetics: The use of bionics and sensory or optical implants and augmentation is left entirely to the discretion of the Cyber-Doc. Player characters can select the following if they so desire: One (mechanical looking) Multi-Optic eye and two sensory implants. Many experienced Warlord Cyber-Docs will have one bionic hand, or hand and arm, with one laser finger, one retractable finger blade, and a **fingerjack**, and some opt for one or two additional bionic arms (along with a partially rebuilt chest and spine).

Wingrider RPA Pilot O.C.C.

The Warlords of Russia have only been using **Wingriders** for the last 20 years, but several of them employ the Flying Wings to a great degree. *Warlord Kolodenko* was the first to introduce the Wingrider and uses them for courier service, reconnaissance and patrol, and combat (he has the largest fleet). The Wingrider Flying Wing has since been **knocked-off** by several other Warlords, as well as the Black Market who sells them to foreigners, bandits, mercenaries and unallied men at arms. A turn of events that angers and annoys Warlord Kolodenko and his crack group of Wingrider Pilots.

Wingrider Pilots are arrogant daredevils who pilot the tricky Wingrider Flying Wings. What makes them most unique is that these men and women really "work" their vehicles, pushing

them to the limit. They make deadly games of their flights and try to ignore the punishing ground fire conditions or flurry of missiles that is typically directed at them. These bold pilots can sit and hang in the stirrups or even stand atop their flying wings while racing, performing aerial acrobatics and daring feats of precision dives and maneuvers.

Seeing a squad of **Wingriders** at play or a company swooping in from the sky to attack in combat is as spectacular as it is frightening. They fly over treetops at breakneck speeds, wind through ravines and canyons, and sometimes enjoy crouching on the Flying Wing's body in flight between the two metal railings and steering with their feet! Every **Wingrider** Pilot must drive with his feet at least once to be accepted by the other pilots, and most take every opportunity they can get to "foot fly." They also enjoy suicide dives, upside-down flying and performing rolls, loop-de-loops and other acrobatic maneuvers.

One of the strangest maneuvers is the grapple-turn. By firing a special piton grapnel (called "**Chulki Hooks**") into surrounding structures, cliffs or trees, the pilot is able to whip around obstacles at incredible speeds. The grapple is hydraulic, tearing itself loose and rewinding during flight to be used again and again.

About a third of all Wingrider Pilots are partial cyborgs or Light Machines. Most are volunteers with the physical and mental aptitude needed to be a Wingrider Pilot and who have exhibited daring, incredible bravery and have distinguished themselves in combat. Those "with the knack," seem to take to the vehicle quickly and naturally — as if the machine itself brings something out in them that has, until now, lain dormant. Many enjoy listening to loud Russian Dog **muzik** while flying missions, and take the names of heros from the songs; "**Electrocutioner**," "**Marching Ludmilla**" and "**Captain Zuko**," to name a few.

Wingrider pilots are fundamentally RPA Pilots along the lines of the **NGR's** "Fly Boys." However, they specialize in the Wingrider and rarely know how to pilot more than one other type of flying power armor **and/or** 2-4 flying or hovering vehicles.

Special Wingrider O.C.C. Bonuses

All bonuses are accumulative.

+2 on initiative.

+2 to save vs punch, fall or impact.

+1 to save vs Horror Factor at levels 1, 3, 6, 8, 10, 12 and 14.

One Trick Shooting skill maneuver of choice (typically shoot while upside-down).

O.C.C. Bonuses when piloting flying vehicles

All are in addition to the O.C.C. bonuses above, as well as possible attribute and skill bonuses.

+1 **action/attack** per melee round when using a Flying Wing or other aerial or rocket vehicle (an extra turn, leap, shot with a vehicle's weapon, etc.).

+1 to strike with a vehicle (ram, sideswipe, etc.).

+2 to dodge when on a small vehicle (hovercycle, motorcycle, snow mobile).

+1 on initiative.

Wingrider RPA Pilot O.C.C.

Also known as Fly Boys or Wing Riders.

Alignment: Any, but most are Anarchist (50%).

Racial Restrictions: Those in the service of the Warlords are exclusively human; 20% are female, and 6% are of Ukrainian heritage.

As noted in the description, **knock-offs** of the Flying Wing have extended the Wingrider Pilot O.C.C. beyond the control of the Warlords. A fact that annoys Warlord **Kolodenko** to no end — he justifiably feels "his" discovery has been stolen and exploited by others. However, he still lays claim to the largest number of Flying Wings and most seasoned, skilled and deadly Wingriders in all of Russia. To prove their superiority, many of the Kolodenko Wingriders take special pleasure in targeting and defeating (often destroying) other Wingriders, especially those not affiliated with any Warlords.

The nerve needed, and the difficulty in piloting these vehicles, makes Wingrider Pilots a comparatively rare commodity; only Warlord Kolodenko has more than a few hundred at his command (four Battalions of 640 **each!**).

Attribute Requirements: I.Q. 8, M.E. 10, P.S. 14, P.P. 14 or higher, along with a lust for speed and sense of daring.

O.C.C. Skills:

Speaks Russian at 96%

Two other languages of choice (+20%).

Radio: Basic (+10%)

Military Etiquette (+10%)

Land Navigation (+20%)

Navigation (Flying using instruments, +15%)

Pilot: Wingrider Flying Wing (+35%)

Pilot Jet Pack (+20%)

Pilot Power Armor, Hover Vehicle or Aircraft of choice (+10%).

Acrobatics (+5%)

Body Building

W.P. Energy Pistol

W.P. Energy Rifles

W.P.: Two of choice (any).

Hand to Hand: Expert (or Assassin if evil).

O.C.C. Related Skills: Choose six other skills at level one and one additional at levels 3, 6, 9 and 12.

Communications: Any (+5%)

Domestic: Any

Electrical: None

Espionage: Intelligence and Wilderness Survival only (+5%).

Mechanical: Basic and Aircraft Mechanics only (+5%).

Medical: First Aid only.

Military: Any (+10%)

Physical: Any, except Wrestling.

Pilot Skills: Any (+10%; 15% for Hovercycles and Aircraft), except ships, tanks and APCs.

Pilot Related Skills: Any (+10%)

Rogue Skills: None, other than Card Sharp and Seduction.

Science: Astronomy and Math only.

Technical: Any (+5%)

W.P.: Any

Wilderness: None

Secondary Skills: The character also gets to select three Secondary Skills from the previous list at level one, and one ad-



ditional at levels 3, 5, 7, 10 and 13. These are additional areas of knowledge that do not get the advantage of the bonus listed in parentheses. All Secondary Skills start at the base skill level. Also, skills are limited as previously indicated.

Standard Equipment: Wingrider power armor, a **Vibro-Knife** (1D6 M.D.), an energy pistol and rifle of choice, one other weapon of choice, S.D.C. survival knife, pocket flashlight, signaling mirror, duct tape, a CD player with 2D6 discs, two rocket flares, two hand-held flares, two smoke grenades, two plasma grenades and 1D4+2 fragmentation grenades (thrown and dropped like bombs).

Additional equipment: Two uniforms denoting War Camp and Warlord, one set of dress clothing, casual clothing, a suit of light body armor (for those quiet moments and relaxing among a large War Camp), backpack, canteen, utility belt and a handful of personal items.

Additional weapons, special items and magic items may be acquired over time (and through role-playing).

Vehicles: Wingrider Flying Wing with corresponding power armor and jet pack.

Equipment Available On Assignment: The RPA Pilot may be given access to different power armor and vehicles, additional or different weapons (including fusion blocks), and other items necessary for a particular mission.

Money: Starts with 1D6x1000 credits. These devil-may-care lunatics tend to live fast, die young and spend money as fast as they get it. Under the Warlords, they are treated as an elite force under the War-Knights, but most warriors, except the most reckless, foolhardy and daring, don't associate with them. Most get a salary of about 1,500 credits a month and a small percentage of booty, plus their Wingrider Flying Wing, power armor, other equipment and general needs are provided for at the War Camp.

Cybernetics: Starts with none.

Note: The descriptions for the *Wingrider Flying Wing* and *Wingrider Power Armor* are found in the Vehicle Section of this book.

O.C.C. Note

See **Rifts® World Book Five: Triax™ & The NGR** for other military O.C.C.s suitable for a Russian campaign, including the Communications Officer, Medic/Medical Officer, Field Mechanic, Intelligence Officer, Euro-Juicer and others. These can be NGR expeditionary forces, deserters/rogue troops and mercenaries. Gypsies too.

The *Mystic Kuznya*, mentioned frequently in the O.C.C. section, is described in detail in **Rifts® Mystic Russia**, the companion to this book, available in stores everywhere.

Russian Bionics

One of the most startling aspects about Russia is the huge range and disparity of technology. Much of the Russian Frontier is a vast wilderness; less than four people per hundred square miles (259 square km). The typical village rarely numbers over a thousand people and most are like something from the 18th or 19th Centuries. Horses, bicycles and one's own feet are the most common and available modes of transportation, "manpower" is used to work the fields, build and labor. Currency, whether credits or Rubles, is not accepted at most places — they "trade" goods and services, and 93% of the people are illiterate and superstitious. Yet amidst these hardworking rural communities are people who wield magic, possess psionic powers, and beings from other worlds, combined with the monstrous and alien, and fragments of superscience. Mega-Damage body armor and energy weapons are just about as common as the pitchfork and hammer. The roar of engines from modern vehicles intrudes on the sounds of nature and the smoke of factories in the occasional city darken the skies above them. Even more surprising is the pervasive presence of cybernetics and cyborgs.

Perhaps because it was all that survived of the old Soviet War Machine, but cybernetic augmentation and full bionic conversion play a tremendous roll in the Warlords' bid for power. Cyborgs are everywhere throughout Western Russia, and number into the hundreds of thousands — 80% under the direct control of the Warlords.

Human augmentation through bionics has been taken farther in Russia than anywhere else in the world. Cyborgs are the norm, commonplace, and fill the roles of police, infantry troops, tanks and light artillery. Socially, Russian 'Borgs are completely accepted by the people and their mechanized power is so coveted by warriors that one is surprised when a warrior does not possess some measure of cybernetic augmentation. This acceptance and commonplace familiarity is so prevalent that a huge number of warriors have submitted to full bionic conversion into mechanical bodies that don't even look human (Cyborg **Shocktroopers**). In fact, many of the Warlords have adopted very specific bionic icons, images and artificial bodies that serve as the "image" or symbol of their particular War Camp. For example, only **Seriyev** uses the *Mantis*; only **Kolodenko** uses the *White Tiger*; and so on. These full conversion cyborgs have come to represent that particular Camp; whenever they are seen, there is no doubt that they represent a particular Warlord, Camp, code of conduct and trouble. In addition to the intimidation factor of these distinct looks, they are helpful on the field of battle, clearly distinguishing friend from foe. Even partial cyborgs and non-cyborg troops will wear body armor, helmets and insignias that reflect the imagery of these Cyborg Shocktroopers as part of the **motif/look** of their War Camp. The 'Borg Shocktroopers are just the ultimate statement of power.

It is interesting to note that other trademark machines of the alien and post apocalyptic world that has become Earth are not common in Russia. Except for the occasional foreign import, there are no Russian manufactured robots, large or **small**, not even robot horses. Nor is power armor **common**, and the majority of vehicles are either small hover-types, or of the wheeled,

tracked/treaded or ski variety. Likewise, aircraft are extremely uncommon (and not particularly useful or effective in the heavily forested and northern regions, particularly in the winter), although cyborgs may be equipped with flying capabilities and the use of jet packs is common practice. Even before the Great Cataclysm, the Soviets had focused on bionics as their area of expertise and military strength. What advanced technology regarding combat vehicles and aircraft existed before the Great Cataclysm, The Eighty Years of Winter and the subsequent invasion of the demonic, has been lost. The **Sovietski** possesses the greatest number of heavy **pre-Rifts** war machines, and even they rely heavily on cyborgs and wheeled or treaded vehicles.

Control of Cyber-Technologies

Only Warlords can authorize the use of bionics. All others, even those used for medical purposes, must either be sanctioned by a Warlord on a case by case basis, or are illegal! Most of the Warlords Capital Cities (their main base of operation and home of the Warlord, himself) offer limited cybernetic medical facilities with the authority to authorize and provide prosthetics and cybernetics for medical reasons. However, all such bionics are minimal systems (maximum P.S. and P.P. for hands and arms are 14 and Spd. 18). Bionic weapons, augmenting implants, and full bionic conversion are not available to ordinary people, only to the Warlord and the members of his War Camp. Such bionics can only be acquired through authorized military (War Camp) hospitals and Body-Chop-Shops.

Illegal bionics can be acquired through unauthorized Body-Chop-Shops and Black Market **operations**, or from foreign sources. Poland and underground Chop-Shops in the NGR offer bionics, as do scores of arms dealers and Body-Chop-Shops located along the Western border of Russia; many of which are disreputable, fly-by-night operations owned by unscrupulous opportunists, smugglers and other criminals. Those who get illegal bionics and operate in a Warlord's Sphere of Influence must keep their existence secret and hidden, or face **potential** charges of treason, conspiracy or banditry. Such charges are likely against those who oppose or clash with the Warlords or their War Camps. Those found guilty are subjected to the removal of their bionics without any substitute systems to replace them. This punishment cripples and kills. Those caught stealing or engaging in **cybersnatching** are tortured and publicly executed.

Bionics given to a warrior by his Warlord are usually a gift for life, so even if he later leaves the War Camp, that individual is free to go and to take the cybernetics with him. Such augmentation is only subject for removal should that warrior use them against his old master or if he is a deserter.

Cybernetics are always a hot commodity in Western Russia, which can lead some down and out mercenaries, Reavers, and 'Borg warriors to have their own cybernetics and bionics removed to sell or trade as parts.

Warlord Cybernetics

Outside Warlord Cybernetic Factories

Each Warlord has a Cybernetics Factory which produces their cyborgs and bionic replacement parts. They may also trade or make purchases from other sources such as arms dealers from

Poland and the New German Republic, mercenaries, and the Sovietski. In fact, 50% of all nuclear components come from outside the Warlords' Sphere of Influence. Warlords who aren't currently warring with one another may also trade among themselves for cybernetic parts and raw materials.

Most cybernetics factories are large, heavily defended, fortified complexes that are closely guarded at all times. They are precious beyond estimation, for they represent both the Warlords' power and Russia's future. As additional protection, the most important production facilities are located in an underground complex, and many are part of an old, pre-Rifts military base and factory. Only trusted Warlord representatives and conscripts are allowed inside, and many of the workers are themselves cyborgs, Light and Heavy Machines.

The factories are marvels of technology equal to anything the Coalition States possess, and only a notch or two below **Triax**. Many cover the equivalent of 3-10 city blocks. Every operation, doorway, hall, hydraulic lift, assembly line, sensor, hologram, and life support system is carefully monitored and kept in top working order. Most cybernetic factories are clean and run with incredible precision and care. Bionic reconstruction, conversion and implant installation are frequently part of the factory compound, along with satellite facilities at hospitals and Military Body-Chop-Shops (the latter being used primarily for repairs, and the installation of replacement parts, modifications and additions). Their operational parameters, diagnostic procedures, surgical techniques, and rate of success are among the best in the world, easily equal to, if not superior to, Triax and the NGR. Some of the Warlords even possess (**pre-Cataclysm/old Soviet**) *automated robot surgical systems* that can "build a 'Borg'" in about half the time of a team of Cyber-Docs.

All types of cybernetic augmentation and bionic conversions are routine for the skilled Warlord Cyber-Docs. Installing implants can take as little as 30 minutes depending on what it is, and full conversion rarely takes more than six or seven hours. Ironically, partial reconstruction takes longer, because it usually involves piece work, careful surgery and may require two or more operations. Thus, over time, partial 'Borgs can require up to a total of 24 hours of surgery.

After recovery, typically 24 hours, the individual goes through emotional and physical therapy, learning to adapt to his artificial body or body parts. This includes learning to adjust to the different senses, physical capabilities, weapon systems, and decreased tactile sensitivity of bionic limbs and bodies. However, this training period is fairly short, with the longest, 2-3 weeks, devoted to full conversion cyborgs and **Shocktroopers**.

Russian Cybernetic Systems

Note: The Warlord may award special bionic systems and features as a reward for heroism, loyalty in the line of duty, and other impressive actions in combat. For the player's convenience and because they are commonly imported **and/or knocked-off**, Triax cybernetics have been included in this section. For **Triax/NGR** cyborgs and additional weapons and equipment, see **Rifts® World Book Five: Triax & The NGR™**.

Unique Cyberlinking Features

Cyberlink Vehicle Interfacing

A cybernetic interfacing system (**fingerjack**, **headjack**, etc.) that allows an individual partial or full conversion cyborg to link to computers and computerized machines (including most Russian vehicles) to send and receive digital information. For example, being **cyberlinked** to a vehicle means the cyborg pilot instantly knows the **speed**, velocity and direction the vehicle is travelling, engine performance, system failures, any stress on or damage to the vehicle (engine, **wheels/tires**, body, weapon systems, etc.), and anything else monitored, managed or controlled by an on board computer and sensors. He can also access and control many of the vehicle's systems, like steering, accelerator, brake, engine, thermostat, radar, radio/communications, special optics, any video camera systems, HUD, weapons and other features.

The big advantages from this link are an instantaneous feed of information, as close to absolute control over the vehicle as is humanly possible, which, in turn, enables the driver to respond more quickly and to use equipment or weapons built into the vehicle with a thought — no need to glance away or use the hands. Thus, the driver can keep his hands on the wheel and eyes on the road while using the interface to access, open and use computerized systems, fire weapons without touching the trigger, punching a button, or using a computer keyboard, etc. The cyborg, in effect, becomes the vehicle, or, perhaps more to the point, the vehicle becomes an extension of his own mind and mechanical body!

Note: Most Russian cyborgs have one or two **cyberjacks** which come standard with their **conversions**, as do most 'Borgs across the planet. The finger and headjack are most common.

Limitations of the Cyberlink Interface:

1. While vehicle-linked in this way, the cyborg may not take any action other than piloting and using the vehicle. To exit the vehicle or to take some other action inside the vehicle, he must break the link and return to what might be considered "manual" piloting. When manual piloting resumes, all Cyberlink bonuses instantly end, and he and his associates (if any) are limited to their own training and skills.

2. This link and union between man and machine is only possible with small and comparatively simple vehicles like motorcycles, automobiles, construction vehicles, hovercycles, hover cars, and flying wings, including such vehicles as the Bushbike, Steppe Motorcycle, War Chariot, **Landflier**, **Wingrider** and Assault Hoversled. It cannot usually be used to pilot and command all features of large and complex combat vehicles (see #3).

3. The Cyberlink can be used with large and sophisticated military vehicles such as tanks, aircraft, ships, and giant robots, but only in a limited way. In this circumstance, the cyborg can only jack into one particular aspect of the vehicle, i.e. one specific weapon (with its related **computer-targeting**), or one specific computer, or the communications system (radio and sensory systems), or the specific piloting of the vehicle, and so on.

Cyberlink Bonuses and Special Abilities:

+1 on initiative when linked to a vehicle.

+1 to strike when using the vehicle or built-in weapon.

+1 to dodge when linked to a vehicle.

+1 melee **action/attack** when linked to a vehicle. This extra action involves the use of the vehicle, i.e. one extra evasive action, trick maneuver, blast from a vehicle weapon, etc.

- The Cyberlink gives the cyborg a base skill of 45% to pilot *any* small one- or two-man vehicle. Taking formal training in Piloting Skills improves the character's mastery over a specific class or type of vehicle (use the skill level instead of the base of 45%), and, in this case, provides a bonus of +10% to that particular piloting skill.
- The cyborg can also "**tweak**" the vehicle's speed, increasing its normal maximum speed by one percentage point equal to his I.Q. Thus, a cyborg with an I.Q. of 8 can increase the speed by 8%; a character with an I.Q. of 12 by 12%, and so on. This increased speed can be maintained for three minutes per M.E. point.

Cost: 250,000 credits.

Weapon to Cyborg Energy Link

Many Russian Heavy '**Borgs** and Cyborg **Shocktroopers** have an energy weapons link — a plug-in cable concealed in the mechanical body, allowing them to power weapons off their own internal energy sources. This gives an energy rifle or pistol effectively an unlimited payload; all other weapon stats like damage, range and rate of fire are unchanged.

Limitations & Penalties:

1. The connecting cord only has 5 M.D.C., and if severed, the energy connection is broken, the power going to the cable is shut off, and an **E-Clip** must be inserted into the weapon to use it (takes three melee actions to grab a remove the severed connector clip, grab and new **E-clip**, and slap it in). The cable is a small, difficult target to hit from long-range, so shooters must make a Called Shot and are -5 to strike.

It is much more vulnerable in close combat where it can be severed by **Vibro-Blades**, M.D. claws, and **M.D./supernatural** strength. The player must announce that the cable is the target of his character's attack and roll to strike as normal. A 12 or higher will hit and do damage unless the cyborg can parry or dodge.

2. The power drain reduces the **character's** speed by 10% and initiative is -1 while linked to and using an energy weapon.

3. After about 10 minutes of melee combat where the weapon has been in frequent use, the effects of the power drain are more pronounced. Reduce speed by 20%, no initiative bonuses apply (unmodified die roll only or -2 if the character normally has no initiative bonus), -1 to parry and dodge, and physical combat damage (punch, kick, etc.) is reduced by half.

The cyborg returns to full speed and ability 15 minutes after the weapon link has been disconnected.

4. This energy link can also be made to small, one- and two-man vehicles designed to accept an E-Pack, but the 'Borg immediately suffers the diminished capacity described in #3. If the vehicle is not designed for optional use of an E-Pack, an Operator can jury-rig a connection in about 1D4 hours.

5. Only available to heavy, full conversion cyborgs and **shocktroopers**, not Light Machines, partial cyborgs or humans with implants **and/or** prosthetics.

Cost: 120,000 credits.

Notable Bionic Features

Common to Warlord Cyborgs

Robot Strength (Optional Feature): Available to Heavy Machines and Cyborg Shocktroopers (automatic for the latter). The full conversion 'Borg is fitted with powerful, lightweight hydraulics, allowing it to take advantage of robot P.S. and inflict Mega-Damage from punches and kicks.

Drawbacks: The enhanced frame and power means the cyborg must be correspondingly big and bulky, and the sense of touch is reduced to about 45%. **Limitations:** Maximum Robot P.S. is 35 for Heavy Machines and 40 for Cyborg Shocktroopers. Partial 'Borgs and Light Machines cannot get robot strength. Cost: 200,000 credits for P.S. 20. Every one P.S. point above 20 costs an additional 10,000 credits per arm (another 100,000 to get to a bot P.S. of 30 for one arm).

Interchangeable Parts: Many bionic weapon systems and limbs, particularly hands and arms, are designed for easy removal and replacement or interchangeable weapons. Sometimes even an artificial face can be removed and replaced with an armored face-plate or a face with different features. Cost: 50,000 credits per each joint or section (**hand/wrist, forearm/elbow, upper arm/shoulder, forearm weapon/mounts** on the top or bottom of arm, **foot/ankle**, etc.) that is modular, with special couplings and connections.

Cyber-Optics

Note: As many as three different Eye features like targeting sight, passive night vision optics, filters, etc. can be combined in most bionic eyes to create a bit more limited multi-optic eye.

Light Filters: Reduces glare. Cost: 1,500 credits.

Macro-eye: A robot-looking eye that enables the character to magnify tiny objects or areas at close range (within three feet/0.9 m) like a microscope! It also comes equipped with a variety of filters. Microscopic magnification ranges from 1x to 30x. It is extremely popular among medical officers and doctors. Cost: 20,000 credits per single eye. A photographic camera (still or video) feature can be added for the additional cost of 20,000 credits. Add 10,000 credits to have a removable eye.

Macro-eye laser: This eye is very similar to the standard macro-eye except that it also has a tiny surgical laser built into it. A targeting beam indicates exactly where the laser will fire before it is engaged. The laser is used exclusively for internal surgery and inflicts little discernable physical damage to external targets (less than one S.D.C. point). It is another favorite of doctors. Microscopic magnification is 1x to 10x. Cost: 80,000 credits for a single eye. Note that a character would seldom get two macro-eyes of any kind.

Multi-system eye socket: This is a special, permanent housing that enables the character to put in and take out different types of eyes as needed or desired. Bio-system eyes do not work in this housing, only mechanical types. A character will seldom have more than one multi-system eye. Cost: 200,000 credits for the multi-system eye socket and 10,000 credits to make each eye interchangeable with the socket.

Panorama Cluster Lens: For the truly weird at heart, this allows the cyborg user to see not only 360° degrees, but above him as well! Imagine walking along looking straight up, but *also* being able to see everything around you (including your own



body) with perfect clarity. Some fields of vision overlap slightly due to the mindbendingly complex optics used.

Bonuses: Cannot be surprised when awake, +2 on initiative and +3 to dodge, +1 to disarm, +5% on the skills Detect Ambush, Detect Concealment, Detect Traps, and Intelligence, +10% to **Cardsharp**, and can pick one Trick Shooting skill (in addition to possible others from O.C.C.).

Drawbacks: The eye is obviously mechanical, plus there is typically an obvious lens protruding from one eye socket, the forehead, top of the head and one in the back of the head; as depicted in the Assassin Cyborg **Shocktrooper**. This means having a clearly inhuman appearance with noticeable mechanical implants sticking out of the head; reduce P.B. by 25% (max. P.B. is 10).

Roll for a random phobia at levels 3, 7 and 12, and tends to be jumpy and have some difficulty sleeping.

It takes 3D4 weeks to get used to it, during which time the character is distracted (no initiative bonuses), disoriented and clumsy (all combat bonuses are reduced to half, speed by 20%, and skill performance is -25%).

Note: Most people cannot adjust to the many images, making this optic system very rare; only one third of the Assassin 'Borgs use it, and less than 5% of all others.

Range: 1,200 feet (366 m). **Cost:** 470,000 credits.

Passive Nightvision Eye: Light amplification system that uses ambient light (the moon, starlight, etc.) to see clearly in the dark. 2000 foot (610 m) range, but can be increased if combined with a telescopic lens feature.

Third Eye: This is a cybernetic eye that is implanted either above a real eye or in the center of the forehead. The mechanical eye can be any of the available artificial eyes, but is typically one of the camera eyes or multi-optic eye. Cost: 350,000 credits.
Penalty: Reduce the character's P.B. by 20%.

Wide-Angle Vision: A wide-angle lens system that gives the character 180 degrees of peripheral vision. Ideal for field conditions, making ambushes, sneak attacks and surprise attacks from the sides impossible to spring on him. Bonuses: It also equates to bonuses of +1 on initiative and +1 to dodge. This feature can be included with other optic or multi-optic bionic eyes. Range: 1,000 feet (305 m). Drawback: The eye must be obviously mechanical and protrudes from the eye socket; reduce P.B. by 10%. Cost: 60,000 credits.

Spectra-Eye: A full-spectrum cybernetic eye, running all the way from light frequencies below infrared to well beyond ultraviolet, as well as microwaves, x-rays, gamma rays, and energy trails from weaponry discharges, heat and radiation. Bonuses: Ideal for scanning machines and metal for imperfections, damage and overheating, tracking (base skill of 40% or adds +15% to those with the tracking skill) and seeing the invisible (can see any being that generates heat or radiation, but not Astral beings or truly ethereal supernatural spirits or life essences). Range: 100 feet (30.5 m). Drawback: The eye must be obviously mechanical and protrudes from the eye socket; reduce P.B. by 10%. Cost: 350,000 credits.

Super-Telescopic Eye: Has six different magnifications from 10x to 50x. 5000 foot (1524 m) and filters to reduce glare. Cost: 20,000 credits (38,000 for a pair).

Cyber-Audio Systems

Low-Frequency (earthquake) Audio Rig: When activated, a tiny sensor slides out of the 'Borg's ear to touch the ground, rock or wall. The 'Borg must physically lean on and touch the ground or wall for the sensor to be effective. It is used to "listen" for the sound vibration carried through the earth for the sound of Cavalry, treads and wheels from vehicles, and the marching of troops, as well as explosions, earthquakes and volcanic activity. The sensor can tell whether the sound is getting louder and coming his way, or if it is becoming softer and going away. It can also tell what general direction with 80% accuracy, and identify the difference between surface disturbances, explosions, natural earthquakes (measure the power level too) and volcanic rumblings.

Ranges: Heavy vehicles/armored divisions: Approx. 4 miles (6.4 km).

Cavalry or herds of animals and city traffic: 3 miles (4.8 km).

Infantry Troops: 2 miles (3.2 km).

Heavy machines/factories: 1 mile (1.6 km).

Volcanic activity: 12 miles (19 km).

Earthquakes: 100 miles (160 km).

Cost: 5,000 credits.

Audio Filter & Enhancement: A sophisticated sound system that carefully edits out background noise to focus on 1-4 specific sounds or voices, which can be digitally enhanced. This

enables the character to hear specific conversations clearly and sounds that can be important for identification purposes (the hum of a machine or weapon, etc.).

Range: Base level of clarity from 80-300 feet (24.4 to 91 m) is 60%, but most effective at close range under 79 feet (24.1 m); great for eavesdropping at parties and confined areas like a room in a tavern, store, etc. Cost: 38,000 credits.

Synthetic Voice Enhancer: Rather than a full modulator, this gizmo makes the cyborg's voice **deeper**, and a bit gravelly to give it a menacing, animalistic quality. It also amplifies growls and roars to make them sound extremely menacing. This feature can be turned on and off as desired, and is used for dramatic effect and to intimidate. Range: The usual vocal range. Cost: 6,000 credits.

Notable Sensors & Special Systems

Gromeko Friend or Foe Identification Computer: This handy implant is connected with the internal cybernetic optics and communication systems. It is used for *Enemy Profiling*. The tiny computer can identify up to 200 different cyborg designs, armors, and insignias of known Russian, European and Asian cyborgs, plus 600 monsters and demons — each rendered in full color with schematics indicating known weaknesses, armor, weapons, powers, etc.; capable of rotation and zoom to key features. This program is designed to be a passive, silent Friend or Foe Identification system.

First, words, or symbols for the majority who cannot read, are displayed on the internal optics of the cyborg similar to a HUD display, to indicate the friend or foe based on the subject's mechanical design, identifying markings, physical appearance and supernatural nature (i.e. Gargoyles, demons, Necromancers, Witches and warriors from rival Camps are all designated as enemies). The *enemy* designation is also reserved for known "human" bandits, D-Bees, and creatures of magic.

If the threat is minimal, or the being is only a potential enemy (as is the case with unidentified humans and many D-Bees), the warning symbol is small and yellow. If the subject is known to be hostile toward humans or the War Camp, or known to be a powerful and evil supernatural being, the warning symbol is large and red. The complete profile on the being can be called up at will in words or sound bites. Visual icons also indicate key classifications including Cyborg, Robot, Demon, God-being, Dragon, Human, D-Bee, Animal, Entity/Ghost, Elemental, Evil Sorcerer (witch, necromancer, etc.) and Unspecified Supernatural Being (i.e. they exhibit supernatural powers or magical abilities but are unidentified). In addition, the FFI System indicates the being's relative power level on a scale of 1-10; a flashing 10 means its estimated power level is off the scale! Range: Line of sight. Drawback: Can only be installed in full conversion cyborgs, from Light to Heavy Machines to Cyborg Shocktroopers. Cost: 200,000 credits.

Medical Sensor Hand: This hand is very similar to the one described in the **Rifts® RPG** but has a few different features and calibrations. The artificial hand costs 20,000 for a mechanical type or 33,000 for a cosmetically natural looking human hand.

As many as 14 features can be instilled in the hand. Each sensor feature must be purchased separately. Available features are as follows:

Epidermic Analyzer: Molecular analyzers in the sensor hand can identify and measure the amount of salt, sugar and powerful enzymes or chemicals by touching a person's skin and/or perspiration. It can also measure the patient's body temperature by touch (touch for one minute). Cost: 35,000 credits.

Pulse & Pressure Detector: By simply squeezing and holding a patient's wrist or finger for a minute, the doctor can accurately measure the character's pulse rate. By squeezing, holding and slowly releasing the wrist, the doctor can also measure the patient's blood pressure. Cost: 25,000 credits.

Stethoscopic Feature (optional): This feature can only be used with one of the ear implants or a universal finger jack and receiver. The doctor can use his hand like a stethoscope, placing it on the patient's chest or back, and listen to his heartbeat or breathing. Cost: 10,000 credits.

Standard Clock Calendar: Same as described in the **Rifts® RPG**, page 230. Cost: 200 credits.

Standard Heat Sensor Feature: Same as described in the **Rifts® RPG**, page 230. Cost: 5000 credits.

Standard Gyro-Compass: Same as described in the **Rifts® RPG**, page 230. Cost: 600 credits.

Standard Motion Detector Sensor Feature: Same as described in the **Rifts® RPG**, page 230. Cost: 15,000 credits.

Standard Radar Sensor Feature: Same as described in the **Rifts® RPG**, page 230. Cost: 2000 credits.

Standard Radiation Sensor Feature: Same as described in the **Rifts® RPG**, page 230. Cost: 1200 credits.

Universal Finger Jack: This is a special connector or jack that is built into one of the fingers, allowing the character to plug directly into most sophisticated computers, audio and sensory equipment, radios, video systems, microphones and even conventional items such as CD players. A tiny receiver is inserted into the ear and linked to the hand jack. Cost: 10,000 credits.

Universal Laser Finger Scalpel: One of the fingers is really a laser scalpel used for surgery. Maximum damage is 1D4 S.D.C. points — it is not a Mega-Damage weapon. Cost: 5000 credits.

Universal Finger Camera: A tiny still camera fits inside the tip of one finger. The camera shoots 48 photos on microfilm and is designed to automatically adjust for low or high light exposures. Cost: 1200 credits.

Bio-Comp self-monitoring system: Nano-implants tied to a tiny computer system monitor, measure and transmit fundamental physiologic information about the person it is implanted in. The data is typically displayed on a **wristwatch** or bracelet style monitor, but can also be displayed and recorded on a computer, portable bio-scan or portable laboratory via a finger or headjack.

Data includes pulse rate, blood pressure, body temperature, blood sugar level, respiratory rate and difficulty breathing, and the presence of foreign elements in the bloodstream (indicating the presence of drugs or poison). Cost: 2500 credits.

Internal Comp-Calculator: A tiny computerized calculator usually connected to a headjack, ear implant or artificial eye. The computer responds to spoken, radio or computer transmitted mathematical equations. The answer is transmitted through the headjack, ear or eye implant. Cost: Basic math (addition, subtraction, multiplication, division and fractions): 1000 credits. Advanced math (algebra, geometry, and calculus): 5000 credits.

Chassis/Body Options

Cyborg Jet Pack: This is a heavy unit designed specifically with Heavy Machines and Cyborg **Shocktroopers** in mind. Special connectors are built into the cyborg's back to allow the jet pack to hook and snap right into the body frame, making it very solid and secure. Most also can tap directly into the 'Borg's power supply.

Stats: Maximum speed is 250 mph/400 km) with a cruising speed of around 70-100 mph (112.6 to 160 km). Maximum altitude is 2000 feet (610 m). Power Source is either an E-Pack (48 hours of life) or a cable that links to the cyborg and draws on his power supply (only the minor penalties apply; indefinite life). Needs to cool down after three hours of continuous use or has a 01-50% chance of overheating and shutting down; roll for every 30 minutes beyond three hours. Needs 40 minutes to cool. The heavy 'Borg jet pack has 140 M.D.C. Cost: 165,000 credits. Note: Heavy cyborg jet packs have seen only limited production in most Camps except **Kolodenco's**, **Romanov's**, and **Burgosov's** who use them extensively. Most others use the comparatively inexpensive standard jet pack for human troops and Light Machines.

Cyberjet Nodes: Mounted in the back and legs are small directional jets. These are typically used for jet assisted leaps and limited hovering. They are available to any full conversion cyborg.

Stats: Travelling by jet boosted leaps doubles the cyborg's normal running speed. Jet assisted leaps can propel *heavy cyborgs* 100 feet high (30.5 m) or 200 feet (61 m) lengthwise; increase by 30% with a running start. Increase the distance of all leaps by 50% for Light Machines. The jet propelled 'Borg can also hover in the air, up to 100 feet (30.5 m), for 1D4 minutes before altitude is lost and the character is quickly but gently lowered to the ground. Cost: 150,000 credits.

Head Collar & Hood: A retractable metal collar rises up to protect the back of the head and sides of the neck and head. The face remains uncovered and peripheral vision is not blocked in any way. Bonus: Adds 42 M.D.C. to the head. Cost: 35,000 credits.

Helmet and/or Face Plate: Most Light and Heavy Machines wear additional body armor over their bionic frames. Many, especially Heavy Machines, like to wear a Samurai style face mask that can either be worn in place of a visor, or worn as a helmet with the front face plate and covering for the back of the head. These helmets can be substituted for conventional ones and can be connected to all standard cyborg body armor, or they can be worn alone (non-environmental) or with an air filter and oxygen tank. The face plate can look high-tech, human, or monstrous. M.D.C.: 80. Cost: 36,000 credits. Add 1,500 credits if it has an independent oxygen supply, and 12,000 credits if the face plate has special connectors to the cyborg's real face and moveable parts that allow the mouth and eyebrow sections to move and make facial expressions.

Hydraulic Leg Boosters: These are simply hydraulics and mechanics to give the legs greater power. Bonuses: Increases normal running speed by 20% and adds +2 feet (0.6 m) to high jumps and +5 feet (1.5 m) to the distance of horizontal leaps. +1 to dodge. Drawbacks: Available only to full conversion borgs (any).

Cost: 90,000 credits.

Shoulder Weapon Mounts/Clamps: Basically, mountings on the shoulders, legs or back that can hold a rifle, **Vibro-Blade** or other weapon rather than "holster" it or slinging it on a belt. Snaps on and off as needed, but holds tight under all sorts of action in the field. Cost: 1,500 credits each.

Schematic Sensor Hand: The schematic sensor hand incorporates a schematic diagnostic sensor, a circuit tracer, a circuit modeler system and a remote repair feature allowing one to repair a circuit or reroute a signal from his or her operating location. It is a favorite to be sure, and has seen a lot of **non-Warlord** sales to adventurers and Operators who can afford them. The device looks like a mechanical hand. Cost: 40,000 credits.

Tool Hand: A mechanical hand that contains a **fingerjack**, fingertip screwdrivers with changeable heads, finger pliers, tiny lights built into each fingertip, plus a laser cutter finger with 6 foot (182 cm) beam, which can be adjusted to do 1D6x10 S.D.C. damage, one M.D., 1D4 M.D. or 1D6 M.D. There is also a small retractable drill in the middle knuckle. Cost: 24,000 credits.

Tool Mechanic's Arm: The Tool Hand as described above, plus a pair of retractable, folding, multi-jointed, three-fingered robot arms. They can hold and assist during repair and each mini-arm can also be fitted with special tool heads. These include a light drill, light **sander/buffer**, screw driver, cutting blades, wire cutters, pliers/clamp, needle-nose pliers (fingers actually), flashlight, and hammer. Several are stored in the arm (often in a housing similar to a forearm weapon mounted on the arm) and additional ones can be carried in a tool kit, backpack or leg compartment, arm P.S. 10, P.P. 10. Reach is two feet (0.6 m) beyond the normal hand. Cost: 190,000 credits.

Tread Leg Mode: How would you like to be a tank or tractor? With this enhancement, the full conversion 'Borg can opt not to have legs and have a vehicular body with treads from the waist down. The advantage is greater speed, lower body profile (typically about 15-20% shorter (2-3 feet/0.6 to 0.9 m shorter than the normal 'Borg of that type), and a torso housing that enables the upper body to revolve 360 degrees.

Speed: 90 mph (144 km), although cruising speed is typically 40-50 mph (64-80 km). M.D.C. of lower body is 100 and each of the two treads has 60 M.D.C. Cost: 185,000 credits.

Cyborg Weapon Systems

Cyber Shield: A shield that attaches or clamps to the arm. Mainly a shield is used to parry or block attacks. It is an excellent defense against **Vibro-Blades**, claws and punches. Note: See the weapon section for a complete description. **M.D.C.:** Human-sized: 40; Giant-Sized: 90. Cost: 20,000 credits for human-sized, 26,000 credits for giant-sized.

Electro-Cannon Forearm Blaster: Electro-Cannons are nifty weapons, even though they are extremely short-ranged and take a lot of juice to fire. When activated, the arm fires a bolt of intense electricity at its target. S.D.C. electronics will be fried. Rules pertaining to salt water, machinery and underwater electrical discharge apply to this weapon.

Primary Purpose: Anti-Personnel/Anti-Vehicle

Mega-Damage: 3D6 M.D.

Range: 300 feet (91.5 m)

Rate of Fire: Equal to the number of the **individual's** hand to hand attacks per round.

Payload: Effectively unlimited; draws on the 'Borg's power supply.

Cost: 30,000 credits

Extendable Hydraulic Hand/Arm: Typically only one limb will have an extendable, hydraulic hand. The control mechanism is usually mental or verbal and responds with the speed and flexibility of a normal arm. The arm's reach is typically increased by three to six feet (0.9 to 1.2 m). The extendable **hand/arm** enables the character to reach into narrow places like storm drains, ventilator shafts, and so on, as well as places normally out of reach, like a high shelf or window ledge. Typical Arm P.S.: 10 to 20, Cost: 150,000 credits.

Forearm Weapon Guards: A welcome addition for the war-weary 'Borg. These protect ranged weapons built into forearms, with a thick flaring arm guard that provides 25 M.D.C. Many are spiked, ribbed or bladed along the edges, more for dramatic effect than function. Cost: 18,000 credits.

Hydraulic Hammer Hand: This bionic hand is extra strong and hard (+15 M.D.C.), and is built into a special hydraulic forearm housing. When activated, the hand vibrates back and forth like a **jackhammer**. This rapid pounding or hammering motion inflicts additional damage.

Disadvantages: The hand can have no other cybernetics and its sense of touch is a meager 10%.

Mega-Damage: +1D6 M.D. in addition to normal punch damage and can hammer through sheets of steel, break rock, and anything else a jackhammer can do. However, to do so, the character must usually make a sustained attack on that one area or item for several melee rounds, and possibly minutes.

There is also a 01-50% of knocking human and human-sized opponents, including Light Machines (and small vehicles) under 250 lbs (112.5 kg) off their feet. Victims knocked off their feet lose initiative and one melee action. Note: A successful roll with impact will reduce the damage by half.

Rate of Fire: Each ram attack counts as one melee action/attack. Cost: 40,000 credits.

Hydraulic Ram Arm: Limited to Heavy Machines and **Shocktroopers**, because the ram is only truly effective on large, heavy cyborgs where the arm and ram can be oversized. The forearm and hand are basically a heavy battering ram and are used as such. The arm can be bent at the elbow or pointed straight to fire the heavy battering hand and forearm unit (typically shaped as a large, sometimes oversized, clenched fist and big arm; one piece, no wrist). Each punching or battering action inflicts heavy blunt damage.

Disadvantages: The hand and forearm can have no other cybernetics since the hand and forearm are one solid piece. The hand is not articulated, it is completely devoid of any sense of touch, and deprives the character of the use of one hand (-20% to most skills); the hand and forearm are a battering ram, not a functioning, dexterous limb.

Robot P.S. Equivalent: The hydraulic **ram/punch** has the equivalent damage of a power punch from a robot P.S. of 40, but counts as one melee action.

Mega-Damage: 4D6 M.D. and can hammer through sheets of steel, shatter concrete, and do anything else a heavy ram can do. However, to do break down doors or pulverize something, the character must usually make a sustained attack on that one area or item for several melee rounds, and possibly minutes.

There is also a **01-80%** chance of knocking human and human-sized opponents, including Light Machines (and small vehicles) under **500 lbs** (225 kg), off their feet and send them flying 2D4 yards/meters. Victims knocked off their feet lose initiative and two melee actions. There is also a **01-45%** chance that they drop their weapon or whatever they were holding at the moment of impact. A sustained attack could keep an opponent reeling and unable to attack in return. **Note:** A successful "roll with impact" will reduce the damage by half and the impact victim hangs on to all of his possessions.

Also note that unless the opponent has a shield or similar item to block the attack, or a P.S. of 30 or higher, the battering ram attack *cannot* be parried! It pounds right through. It **can**, however, be dodged, although the act of dodging typically uses up one melee action.

Rate of Fire: Each ram attack counts as one melee **action/attack**. One melee action will be needed to close ranks on a victim who has already been sent flying, but the next hammering punch should arrive before the victim can recover his wits and counter-attack (only parry or dodge are applicable when the 'Borg closes that quickly to continue the battering attack. See the limitations on the parry, above).

Cost: 80,000 credits.

Laser Cannon Arm: A dual system with a heavy, large-bore weapon in place of a hand or forearm, plus a light laser for precision targeting and sniping. Comes standard with a pop-up telescopic scope with passive nightsight (2000 **ft/610 m** range).

Primary Purpose: **Anti-Personnel/Anti-Vehicle**

Disadvantages: The hand and forearm are replaced by a weapon system, can have no other weapons or cybernetic features on that limb, it is completely devoid of any sense of **touch**, and deprives the character of the use of one hand (-20% to most skills).

Mega-Damage: The heavy laser does 4D6 M.D.; the light laser does 2D6 M.D., while a simultaneous dual blast does 6D6 M.D. Only the light laser can be used for sniping attacks.

Range: Heavy Laser: 3,000 feet (914 m); Light Laser: 2,000 feet (610m).

Rate of Fire: Each blast counts as one melee **attack/action**.

Payload: 12 blasts, followed by a recharge time of 1 Combat Round per blast.

Cost: 63,000 credits.

Mekanikal Rail Gun Weapon Arm: A modular weapon system designed with Heavy Machines and Cyborg Shocktroopers in mind. It can be substituted with any of the Mekanikal Weapon Arms.

An **Ammodyne** AR-36 rail gun, with a short ammo clip (140 rounds) or a belt-feed, trailing to an ammo-drum on the 'Borg's **back**, built into the forearm (the hand is a separate unit). The range is lessened due to shorter barrel length. The weapon is too large to be retractable and comes in only one size. The weapon makes for large, oversized forearms but retains fully articulated hands.

Primary Purpose: **Anti-Personnel/Anti-Vehicle**

Mega-Damage: A single burst fires 20 rounds and **inflicts** 4D6 M.D.; a single round does 1D4 M.D.

Range: **2,000** feet (610 m)

Rate of Fire: Each burst counts as one melee attack.

Payload: Seven bursts in a **short-clip**, 200 bursts with a 4000 round ammo-drum on the back. Cost: 90,000 credits per arm.

Mekanikal Barrage Weapon Arm: Another modular weapon system designed with Heavy Machines and Cyborg Shocktroopers in mind. It can be substituted with any of the Mekanikal Weapon Arms.

A multi-weapon bionic arm with a high-powered laser, ion blaster and a pair of mini-missiles. The weapon makes for large, oversized forearms but retains fully articulated hands.

Primary Purpose: **Anti-Personnel/Anti-Vehicle**

Mega-Damage: Laser: 3D6 M.D.

Ion: 4D6 M.D.

Mini-Missiles (2 per arm): Varies with missile type. Range: Laser: 2000 feet (**610 m**)

Ion: **1,200** feet (**366 m**)

Mini-Missiles: One mile (1.6 km)

Rate of Fire: Each blast counts as one melee attack. The laser and ion blaster can be fired simultaneously at the same target (7D6 M.D.) and count as one melee attack. A pair of mini-missiles also counts as one melee attack.

Payload: Laser and Ion weapons are effectively unlimited, because they draw on the cyborg's power supply. Mini-missiles: Two per weapon arm.

Cost: 90,000 credits per arm.

Mekanikal Vibro-Blade Multi-Weapon Arm: Another modular weapon system designed with Heavy Machines and Cyborg Shocktroopers in mind. It can be substituted with any of the Mekanikal Weapon Arms.

A multi-weapon bionic arm with a light, high powered, precision laser suitable for sniping, a pair top mounted Vibro-Swords, and a long, underarm blade used for slashing and parrying. The weapon makes for large, oversized forearms but retains fully articulated hands (extra long fingers with sharp Vibro-Finger Claws doing 3D4 M.D. are standard). See the illustration of the *Assassin Cyborg Shocktrooper* to see what this arm looks like. **Note:** Heavy Machines at 8-12 feet (2.4 to 3.6 m) tall (50% averaging around **10-11 ft/3 to 3.3 m** tall) are effectively giants, so these blades are all very large and inflict greater damage.

Primary Purpose: **Anti-Personnel/Anti-Vehicle**

Mega-Damage: Laser: 2D6 M.D.

Pair of Large (top mounted) **Vibro-Blades:** 3D6 M.D.

Large underarm Vibro-Blade/Sword: 3D6 M.D.

Vibro-Claw Fingers: 4D4 M.D.

Range: Laser: 1,600 feet (488 m)

Vibro-Blades extend reach about 2-3 feet (0.6 to 0.9 m)

Rate of Fire: Each laser blast counts as one melee attack.

Weapon Bonuses: +1 to strike with laser on Aimed and Called Shots.

+1 to strike and parry, and +2 to disarm when Vibro-Blades are used.

Payload: Laser is effectively unlimited. All weapons draw upon the cyborg's power supply.

Optional: Heavy Cyborgs can get one or two additional arms with this or other weapons. A pair of arms adds one melee attack but costs 130,000 credits each, plus the cost of the weapon arm features for a total of 440,000 credits (one third that cost for Warlords).

Cost: 90,000 credits per weapon arm.

Mekanikal Cutter Weapon/Utility Arm: Three tentacles slide out of their forearm compartment. One has a **Vibro-Knife**

on its tip (1D6 M.D.) and the other two have lasers. They can be used for construction and repair or as weapons. They are also handy in cutting the cyborg out of restraints and cutting through undergrowth. As prehensile mechanical limbs, they can also wrap-around and hold or carry items weighing less than 120 lbs (54 kg), as well as strike and entangle opponents. The weapon makes for large, oversized forearms but retains fully articulated hands.

Primary Purpose: Anti-Personnel/Anti-Vehicle

Mega-Damage: Lasers (2): 1D6 or 2D6 M.D. each.

Vibro-Knife: 1D6 M.D.

Whip Attack: 2D6 S.D.C.

P.S. & P.P. Equivalents: 12

M.D.C.: 15 each tentacle; can only be targeted by making a called shot at -3 to hit; no such penalty for hand to hand combat.

Bonuses: +1 attack per melee round and +1 to parry per set of tentacles (2 max.; one per arm).

Range: Lasers: 1,200 feet (366 m)

Vibro-Blade: Three feet (0.9 m)

Striking range for physical blows: Three feet (0.9 m) beyond the normal reach.

Rate of Fire: Each tentacle attack counts as one melee **attack/action**.

Payload: Lasers are effectively unlimited, because they draw on the cyborg's power supply.

Cost: 250,000 credits per arm (three tentacles each).

Laser Beam Eye (1 or 2): Suitable for bots and 'borgs. Short range. Usually draws its energy from the artificial power source. In the instances where this feature is used, the eye (or eyes) are unusually large or a visor-like implant rather than a human-looking eye. Sometimes the entire head is over-sized. **Note:** The NGR military has a particle beam version.

Primary Purpose: Assault

Mega-Damage: 2D6 M.D. per single eye blast or 4D6 M.D. per double blast (both eyes fire simultaneously at the same target). A double blast counts as one melee action.

Rate of Fire: Equal to the 'borg's total number of hand to hand attacks per melee.

Effective Range: 1000 feet (305 m)

Payload: Effectively unlimited.

Bonus: +1 to strike.

Cost: 130,000 credits each.

LGL-31 Grapple & Launcher: A launch compartment and housing that looks like a small weapon nozzle fires a collapsible grappling hook and line. A pneumatic winch reels the line back in helping characters to scale walls and non-metallic surfaces and hitch rides on giant bots and vehicles. The cord is a super thin, super strong wire with a test strength of 2000 pounds (900 kg).

Mega-Damage: None (negligible)

Range: 100 feet (30.5 m) of lightweight wire (retractable).

Market Cost: 5,000 credits.

W-41 Palm Laser Torch: A short-range laser built into the base of the palm and wrist of cyborgs, and extremely popular among Light Machines. The device can be used as both a weapon and a cutting tool.

Primary Purpose: Tactical Weapon and Tool/Self-Defense.

Mega-Damage: Has four settings: 2D4x10 S.D.C., 1 M.D., 1D6 M.D. and 2D6 M.D. per single blast, or as much as 4D6 per double blast (both hands combined).

Range: 200 feet (61 m)

Rate of Fire: Each blast counts as one melee action. A double blast from two palm lasers simultaneously at the same target also counts as one melee attack.

Payload: Effectively unlimited (typically built into bots, borgs and power armor and draws on the armor's energy supply).

Market Cost: 15,000 credits.

Psionic Electro-Magnetic Dampers: Brain implants that distort and fog telepathic and other psionic probes. Psychic opponents find it difficult to read the thoughts and emotions of characters with the psionic dampers.

Bonuses: +1 to save vs all psionic attacks, +2 to save vs possession, and +1 to save vs magic illusions and mind control.

Cost: 90,000 credits in the NGR, 50-100% more in Russia if it can be found. **Note:** Extremely rare in Russia and Asia.

RVB-31 Concealed Vibro-Blade: A standard Vibro-Blade short sword is concealed in a housing in one or both of the forearms. The blade is used as both a defensive and offensive weapon. Concealed, retractable **vibro-blades** are commonly installed in cyborgs, robots and, to a lesser degree, power armor.

Mega-damage: 2D4 M.D. standard, human-sized blade (sabre type). The larger, full-size sword does 2D6 M.D. and is used in Heavy Machines and Cyborg **Shocktroopers** eight feet (2.4 m) tall or bigger. Some giant-sized 'Borgs, 10 feet (3 m) and larger, have a big blade that does 3D6 M.D.

Range: Hand to hand combat.

Market Cost: 5000 to 10,000 credits.

Other Cybernetic Implants: See the **Rifts RPG** for additional cybernetic and bionic enhancements, starting on page 230.

Also see Cyborg O.C.C. Section

The section on the Cyborg O.C.C.s offers more information about bionics as well as several specific types of cyborgs complete with special weapons and features exclusive to those 'Borgs.

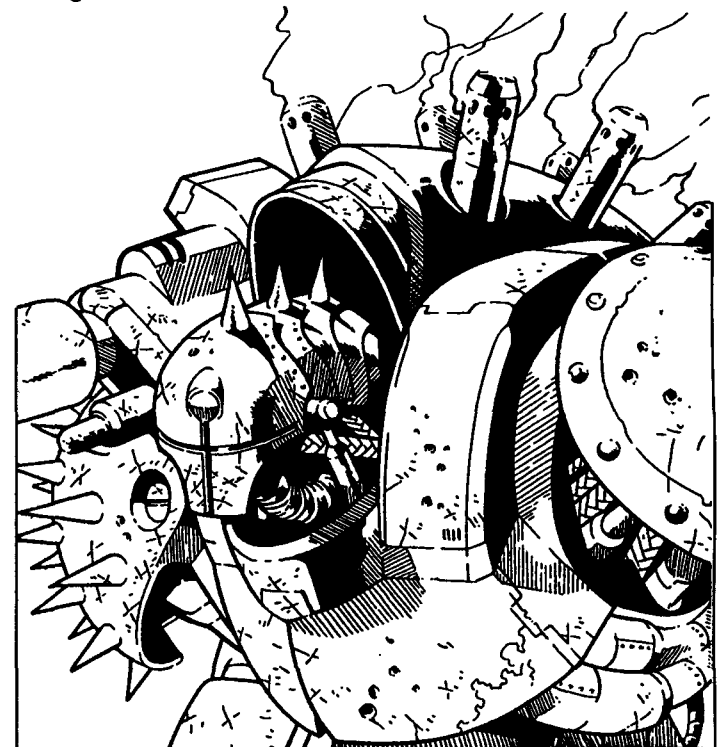

Cyborg O.C.C.s

The center of power within the armed "Camps" of the Warlords is the Cyborg **Shocktroopers** and other lesser 'Borgs. These elite infantry troops are savage, merciless warriors who love combat, excel at strategic strikes and full-press attacks, and possess the armor and **firepower** of walking tanks. According to legend, and these are legendary warriors, many enemies will flee or surrender at the very sight of a thousand plus Cyborg **Shocktroops** or Heavy Machines bearing down upon them — and during big military campaigns that number can be 10 to 20 times greater. Also according to legend, one Cyborg **Shocktrooper** (or pair of Heavy Machines or Cossacks) is equal to ten ordinary warriors. Whether this is an exaggeration or not is a matter of conjecture, but those on the receiving end of such forces usually admit that they have never seen anything quite as terrifying, especially when you add the **War-Knights**, Cossacks, Reaver Mechanized Cavalry and other forces to the equation. There is no dispute that the Warlords' cyborg legions, from Shocktroopers and Heavy Machines to Light Machines and partial cyborgs, are among the wildest, bravest and most fanatical of all their troops.

Remember that cybernetic augmentation, prosthetics, bionic conversions and cyborgs are commonplace among the Warlords' Camps and throughout Russia. Furthermore, bionics, cybernetic components, implants, their installation and full conversions are comparatively inexpensive for members of the War Camps; most are rewards or standard equipment provided by the Warlords! Yet even though cybernetics and cyborgs are considered commonplace, and the average person doesn't raise an eyebrow when they see one, the level of technology is no greater in Russia than the Coalition States or **Triax**. Things may seem otherwise only because the Warlords, and Russian people in general, have no inhibitions about cyborgs and have pulled out all the stops in regard to their creation, design and use, especially in military applications. Consequently, cyborgs are everywhere! The sheer number of cyborgs, partial and full conversion, is mind boggling, particularly in western Russia. Their accessibility, commonness, and the high esteem given cyborg warriors by the Warlords contributes to their open acceptance by the Russian people in all walks of life. In many ways, the Russian people under the Warlords' rule are becoming *Mashiniye Chilovyeki* — "Man Machines."

The widespread acceptance of cyborgs and cybernetic augmentation, and the hero status of 'Borg warriors means that Russians who become cyborgs, even monstrous looking ones, suffer from minimal mental decay and emotional disassociation with their fellow humans. They are mentally sound and happy!

Tactile sensitivity, with rare exception, is at least 50% that of normal humans, even in the most robotic looking cyborgs like the Shocktroopers. The sense of touch can range as high as 80% in Light Machines and prosthetics used for partial 'Borgs. Warlord cybernetics allow for blood to flow through the body to produce blood pressure to the brain and skin tissue, which also enhances tactile sensitivity (touch).

Player Note: A player character can be any *Light or Heavy Machine* without having ever served one of the **Warlords**, although the cost will be high or require 8-14 years of indentured

servitude to pay for the bionic augmentation. The Black Market, various other criminal organizations, some mercenary groups, foreign agents (usually criminals, meres, arm dealers and those willing to sponsor adventurers — typically splitting booty and valuables 50/50), as well as the occasional well-to-do community or city are such possible sponsors for bionic conversion. Likewise, Headhunters, partial 'Borgs, and full conversion 'Borgs from other parts of the world are likely to be regarded as Light or Heavy Machines. Initially, people *may* assume them to be agents of one of the Warlords, bandits or foreign spies.

Cyborg Shocktroopers must have been in the service of a Warlord for several years, and are likely to be active agents still in their service (even if they aren't, many people will refuse to believe it). Those who have severed their ties with their Warlord for one reason or another, are likely to still hold them and their War Camps in high regard and feel some degree of loyalty toward them. Such characters will avoid going against their old allies and may continue to offer their sympathy, support, information and services to them from time to time. If the character doesn't fall into one of these categories, he was either drummed out of service for dereliction of duty or some other wrong (may be unjustly accused or framed), or he is a hated traitor or cowardly deserter. These last guys will be despised by their old War Camp, and will be harassed or an attempt will be made on their lives whenever they encounter their old teammates. If they openly oppose their Warlord or old teammates, they will be the primary targets of numerous assailants wanting their blood. If their actions are too heinous **and/or** notorious, assassins and Smoke Soldiers or cyborgs will be assigned to hunt them down and dispatch them once and for all.

Light Machine

The *Mashiniye Chilovyeki*, or "Man Machines," are more commonly known as "Light Machines" or "Light Machine Cyborgs." These include a large range of humans heavily augmented with bionics.

The classic Light Machine is the *full conversion cyborg* designed to be roughly equivalent to a human being in size and shape, if not outright appearance. Light Machines typically range in size from five feet, six inches (1.7 m) to six feet, six inches (1.9 m). Their robot frame is roughly human-sized in configuration, so the cyborg can wear human clothing and body armor, ride a horse or hovercycle, and fit comfortably in a car and normal housing. Their comparatively small frame and human form limits the shielding and armor they can wear, but makes them suitable as inconspicuous but augmented spies, agents and soldiers easily concealed among fellow humans. Furthermore, most (about 83%) have human heads and faces, or synthetic features (namely face and hands) that look completely human. Of course, the human brain is organic and, often, so are the head, hands, and many of the internal organs — only encased, supplemented and augmented by cybernetic machine parts.

Also included in the category of "Light Machine" are **partial conversion cyborgs**, or what North Americans would probably call *Headhunters*. These are human soldiers and warriors who have 2-4 bionic limbs, a reinforced cybernetic spine, and implants designed for augmentation and war. Some internal organs and parts of the skull or jaw may also have been replaced with

bionic features (**bionic** lungs, **headjacks**, and head or jaw radios are common). However, the face **and/or** head, and usually the chest and torso, are that of an ordinary human being, and at least 50% also have one flesh and blood arm and hand as well.

Remember, the distinction between cybernetics (synthetic organs, minor implants and **prosthetics** as a mechanical replacement for the human body) and bionics is that bionics are built specifically for military use and combat. As such, bionics don't generally try to replicate delicate human limbs and function, nor try to disguise the mechanical appearance. Instead, they are obvious machines designed to augment and improve upon the human body for combat with built-in weapons and combat features. It is such "bionic" limbs that make the partial cyborg designated as a Light Machine or "Machine Man."

In the case where a partial or full conversion Light Machine wants to appear completely human (common among spies), their body, or at least legs, arms, hands, neck and head are outwardly living flesh or a synthetic skin equivalent, placed over a machine armature and circuitry. This makes for a ghastly sight if the **'Borg** is wounded and blood sprays over metal and circuitry. Only about 5% have their entire mechanical body covered in real or synthetic flesh. However, since bionics and cybernetics are so commonplace, and cyborgs are regarded as courageous heroes and patriots who have willingly sacrificed their bodies to protect the Russian people, the vast majority (87%) don't bother with hiding their machine nature in any way. In fact, most wear it like a badge of honor.

Bionic features common to Light Machines

55% Conversion Package for the typical Partial Cyborg

- One Headjack and ear implant, or **handiack**.
- Cyber-Link feature.
- Two sensor/communications system implants of choice.
- Reinforced **Endo-Skeleton** and Body Frame; 15 M.D.C.
- Full Leg Conversion (everything except blood vessels is artificial). Typical Speed: 45 (30 **mph/48** km). The legs can propel their owner in a leap 10 feet (3 m) up or 12 feet (3.6 m) across from a standing start, (twice that with a short run). Each leg has 60 M.D.C., each foot 15-20 M.D.C.
- One bionic arm (40 M.D.C.) and hand (12 M.D.C.) with two weapons each; P.S. 18-20. and P.P. 18-20
- Lung Implants: Gas Filtration System and Oxygen Storage Cell.
- Light Cyborg Armor (heavier and thicker than normal body armor, but can be more easily accommodated by the machine limbs and reinforced body frame) is 140 M.D.C., but ordinary body armor can be worn instead (30-90 M.D.C. on average).

Warlord Cost: 300,000 credits; North American or NGR equivalent, about 850,000 to 1 million credits. Note: Additional features like a radio, language translator, **cyber-disguise**, internal organs, eye and other implants can be

acquired by the individual as rewards from the Warlord for acts of heroism and courage under fire, or **purchased** with his own money.

70-80% Conversion Package:

- One Headjack and ear implant, or handjack.
- Cyber-Link feature.
- Four sensor/communications system implants of choice.
- Bionic reinforced Body Frame and full torso Conversion (everything save organs is artificial); 65 M.D.C.
- Full Leg Conversion (everything except blood vessels is artificial). Typical Speed: 50 (35 **mph/56** km). The legs can propel their owner in a leap 10 feet (3 m) up or 15 feet (4.6 m) across from a standing start, (twice that with a short run). The legs have 80 M.D.C. each, the feet 25 M.D.C. each.
- Both arms and hands are full bionic conversions. The arms have 40 M.D.C. each, and hands 18 M.D.C. each. Each arm has 2-3 weapons and a P.S. and P.P. of 20. Each hand also has 2-3 weapons or special features (a wrist weapon counts as one of the hand weapons).
- Bionic Lung with Gas Filtration System and Oxygen Storage Cell.
- Bionic or reinforced **head/skull** with Built-in Language Translator, Radio Receiver and Transmitter.
- Light Cyborg Armor (heavier and thicker than normal body armor, but can be more easily accommodated by the machine limbs and reinforced body frame) is 140 M.D.C., but ordinary body armor can be worn instead (30-90 M.D.C. on average).

Warlord Cost: 500,000 credits; North American or NGR equivalent, about 1.1 to 1.5 million credits. Note: Additional features like a cyber-disguise, internal organs, eye and other implants and features can be acquired by the individual as rewards from the Warlord for acts of heroism and courage under fire, or purchased with his own money.

Light Machine Full Conversion

Although called a "full conversion" cyborg, this is more like a 95% to 98% conversion, because many retain their human face, brain, blood and some internal organs. The emphasis with full conversion Light Machines is on human size and general appearance, although the **'Borg** may look completely mechanical. The conversion provides superhuman strength, agility, speed, stamina and an M.D.C. body, while, at the same time, allowing the individual to wear normal clothing and body armor, use standard equipment and vehicles, and otherwise appear as human as desired. These characters usually retain a strong sense of their original human identity and maintain close ties to family, friends and ordinary people.

Light Machine Cyborg Soldier/Warrior/Merc

Class: Full Conversion Light Cyborg.

Attribute Requirements: M.E. 9 or higher is suggested, as is a good I.Q. (8+), but all that is required is a human in good mental health, with the spirit to fight and the belief that being a *Mashiniye Chilovyeki* is a good and desirable thing. Once the bionic conversion is performed, there is no hope of ever becoming human again.



O.C.C. Skills:

Native Language (probably Russian; at 92%)
 Language: Euro (+20%)
 Language: One of choice (+15%)
 Radio: Basic (+15%)
 Radio: One of choice or Computer Operation (+10%)
 Pilot Hovercycle (+10%)
 Pilot: Two skills of choice (+10%)
 Military Etiquette (+10%)
 Climbing (+10%)
 Swimming (+10%)
 W.P. Paired Weapons
 W.P. Automatic Rifle
 W.P. Energy Rifle
 W.P. Trick Shooting (choice of only one)
 W.P. Two of Choice (any)

Hand to Hand: Basic, but can be changed to Expert for the cost of one O.C.C. Related skill, or to Martial Arts (or Assassin if anarchist or evil) for the cost of *two* skills.

O.C.C. Related Skills: Select three MOS skills (with a +15% bonus each) from *any* category regardless of whether or not it's normally available (i.e. can pick skills from Espionage, Electrical, Mechanical, Science, etc., which aren't otherwise available, or from an available category just to get the higher bonus). In addition, select two Military or Piloting skills, and three other skills of choice from the list below. One additional skill is selected at levels 4, 8 and 12. All new skills start at level one proficiency.

Communications: Any (+10%)

Domestic: Any (+5%)

Electrical: None

Espionage: Intelligence and Sniper only.

Mechanical: Basic and Automotive Mechanics only (+5%)

Medical: First Aid only (+5%)

Military: Any (+10%)

Physical: Any that are still appropriate.

Pilot: Any (+5%)

Pilot Related: Any (+10%)

Rogue: Any (+2%)

Science: Math only (+5%)

Technical: Any (+10%)

W.P.: Any, except additional Trick Shooting skills.

Wilderness: Any

Secondary Skills: The character also gets to select two secondary skills from the list, excluding those marked "None," at levels 2, 4, 8 and 13. These are additional areas of knowledge that do not get the advantage of the bonus listed in parentheses. All secondary skills start at the base skill level.

Standard Military issue for Cyborg Soldiers: All the appropriate ammunition and equipment for the Borg's body styling and weapon systems. Energy rifle of choice, four extra **E-clips**, four grenades of choice, distancing binoculars, utility belt, **backpack**, walkie-talkie (for backup), utility belt, long coat, cap or hat, scarf, gloves and boots (all clothes are either for show or disguise), and regular maintenance and repairs.

Also see Typical Bionics.

Vehicle: Starts with a battered looking **hovercycle**, minus 6D6 M.D.C., but otherwise in good condition.

Equipment Available Upon Assignment: Jet pack, hover vehicle or other transportation, additional weapons and equip-

ment. The character also has access to Warlord sanctioned or owned bionics facilities and free repairs and replacement of bionics damaged or lost in the line of duty. **Note:** Availability of equipment and bionics may be limited or unavailable depending on the local commander, supply stock, location and combat conditions.

Note: Light Machines are highly respected by the people and treated well by most of their fellow soldiers, including Heavy Machines and War-Knights. Only some of the envious Reavers tend to treat them poorly.

Money: The Light Machine starts with **6D6x10** credits and 3D6x10 in **tradeable** goods. The monthly salary is 900-1300 credits depending on rank and record, plus all his basic **needs**, weapons and repairs are provided for by the Warlord.

Cybernetics: Typical Bionics: The following stats, weapons and features are typical of the Light Machine. Customizing, personal tastes, and additional bionics acquired as rewards for heroism, duty, and rank, as well as authorized purchases, may come later. Of course there are reasonable limitations. Those not associated with a Warlord are on their own in acquiring additional bionics and start with one less weapon, one less head feature, and don't have the Gromeko **FFI** system.

Average Size: Roughly human, typically six feet (1.8 m).

Weight: 250-350 pounds (112.5 to 157.5 kg).

Power Source: Nuclear

M.D.C. by Location:

- * Palm Lasers (2) — 12 each
- * Concealed **Vibro-Blades** (2) — 50 each
- * Ion Beam Wrist Blaster — 10
- * Arms (2) — 60 each
- * Hands (2) — 25 each
- Legs (2) — 85 each
- * **Feet** (2) — 25 each

** Head — 80; it may be flesh outside, but underneath is a metal skull, plus it is usually protected with additional M.D.C. from a helmet and visor or helmet and face plate from bionic body armor; typically 80 M.D.C. Many 'Borgs, especially full conversion Heavy Machines, wear a bionic or metal face plate reminiscent of the ancient Samurai. The face plate can look high-tech, human or monstrous.

*** Main Body — 170 plus M.D.C. from conventional body armor (any of the Russian, **Triax** or imported environmental body armor suits: 30-100 M.D.C.) or light (140 M.D.C.) or medium cyborg armor (180); Light Machines cannot wear heavy cyborg armor. Bionic or Cyborg armor is heavier and thicker than normal body armor, but can be more easily accommodated by the augmented mechanical body with minimal penalty (-10% to prowl, acrobatics, gymnastics, swim, climb, palming, and similar skills).

Damage Notes:

* A single asterisk indicates a small **and/or** difficult target to hit. The attacker must make a "Called Shot" and even then he is -4 to strike. The hands and Vibro-Blades are extremely difficult targets to hit, and are -5 to strike on a Called Shot.

** Destroying the head of a cyborg will kill the character! This is where the brain is housed and when it's gone, that character is dead. However, the rest of the body can be salvaged and reused.

*** Depleting the M.D.C. of the main body will effectively destroy the artificial body, but emergency systems will keep the brain and vital organs alive for 12 hours. Recovery of the damaged body will enable Cyber-Docs to place the character on a life support system that will keep him alive until a new bionic frame becomes available. Failure to find the brain within 12 hours means the character dies. Massive amounts of damage (100+ M.D.C. below zero), completely destroy the 'Borg, with no hope of recovery.

Bionic Attributes:

- Tactile sensitivity: At least 50%; typically 85%
- Bionic P.S. of 28-30 (S.D.C. damage); power punch and leap kick do 1D4 M.D.
- Bionic P.P. of 20-24
- Face: P.B. Modifier: Pick one.
 1. Natural face, roll 3D6 as usual (+1D6 if a 16-18 is rolled).
 2. 3D6+6 if a sculpted human face is used and the character wants to be attractive (may be the original face tweaked and modified to look better).
 3. 1D6+4 if the face is the standard robotic one without any human facial features (as depicted in the illustration).
 4. 1D4+3 if a monstrous, frightening or inhuman face (animal, insect, etc.) is used; Horror Factor 10.

- Bionic Speed Running: 120 mph (192 km).
- Leaping: Super-powerful hydraulic leg pistons are capable of launching the full conversion Light Machine 15 feet (4.6 m) high or 25 feet (7.6 m) lengthwise; increase by 50% with a running start.
- Speed & Flight Options: Cyberjet Nodes for jet assisted leaps, increased speed and limited hovering, or human or 'Borg jet packs (see *cybernetic equipment section* for details), or by vehicle.

Bonuses:

- +3 on initiative.
- +1 to pull punch.
- +1 to strike and parry.

Cost: Around 1.4 million for the Warlords, 2.6 to 3.5 million credits on the open market.

Standard Cybernetic Systems (non-weapon types):

1. Full 20/20 Enhanced Color Vision (to **line-of-sight**).
2. Targeting Sight (+1 to strike) and light filters.
3. Telescopic Eye with Passive **Nightvision** (5000 ft/1524m).
4. Multi-System Eye Socket.
5. Universal **headjack/ear** implant with Augmentation
6. Amplified Audio
7. Built-in Language Translator
8. Built-in Radio Transmitter & Receiver (5 miles/8 km)
9. Cyberlink Vehicle Interface (2; one in hand and head).
10. Gromeko Friend or Foe Identification Computer.
11. Bionic Lung with gas filter & oxygen storage cell.

Standard Weapon Systems & Special Features:

1. **Concealed Vibro-Blades** (2): Each forearm has a retractable **Vibro-Short** Sword that can be extended at will and locked into place.

Primary Purpose: Anti-Personnel

Damage: 2D4 M.D. each.

Attacks Per Melee Round: Melee weapons; each strike counts as one attack.

Payload: Unlimited; draws on the 'Borg's power supply.

2. Ion Palm/Wrist Blaster (1 or 2): This item can be built into one or both hands/wrists. It too retracts when not in use and extends to fire. When only one unit is used in one hand, the other hand typically has a different weapon system, often a chemical spray, **garrote** wrist wire, or wrist needle and drug dispenser. The ion blaster is designed for close combat, assault and defense

Primary Purpose: Assault

Mega-Damage: 3D6 M.D. per blast.

Range: 500 feet (152 m).

Rate of Fire: Each blast counts as one melee attack. If the cyborg points both arms at the same target and fires both blasters simultaneously, the damage is doubled (6D6 M.D.) and it counts as one melee attack. However, this can only be done when the cyborg is standing still and the target is at least two times human-size. Running and trying to shoot is the equivalent of shooting wild and is done at -6 to strike, and all other combat bonuses are reduced by half.

Payload: Effectively unlimited; runs on internal power supply.

3. Additional Arm Weapons (to start): One arm will have a forearm weapon in addition to the **Vibro-Blade**.

4. Additional Hand Features or Weapons (to start): Two hand weapons of choice. The G.M. may modify or restrict certain items.

5. Additional Leg Features or Weapons (to start): One leg feature or weapon of choice for only one leg. The other has none.

6. Select type of face. If human, the character can select either the Type AA-1 Cyber-Disguise or two **face/head** or eye features.

7. Optional Weapons. In addition to bionic weapons and features, the character will own and use a variety of conventional weapons.

8. Vibro-Blade or other blade weapons may be plated in silver to combat supernatural beings vulnerable to such things.

9. Chemical Sprays may fire holy water — water or oil blessed by a priest and used against vampires and certain other supernatural beings.

Heavy Machines

The so-called "Heavy Machines" are large, heavily armored, full conversion cyborgs with a humanoid shape — a head, two legs, two feet, two arms, etc. They are not the alien or monstrous looking *Cyborg Shocktroopers* like the Mantis, White Tiger, Avenging Angel and many others, however, they are clearly massive cyborgs with full mechanical bodies. These hulking, human-shaped war machines bristle with obvious weapons and are motivated by deadly intent. The face **and/or** head may be human, or at least appear human. Many opt to get a synthetic head that has the character's original facial features with material that feels like real flesh. Synthetic hair can also look and feel like the genuine article, or have a mechanical appearance (cabling or wire instead of hair, a stylistic design rather than hair, etc.), to no hair at all (very common even among females). A sculpted and molded artificial face and synthetic skin doesn't age, so

while the individual has forsaken his or her humanity, he captures a small bit of immortality, for even a 'Borg who is 200 years old may have the facial appearance of a 20 year old. For many, the eternally youthful appearance is somehow rewarding, and helps them to retain some small piece of their humanity. A cyborg is believed to be able to live up to 200 years (maybe longer) with regular maintenance and periodic replacement of their power supply. However, as elite combat troops in a war against supernatural invaders (quite literally, demons), the average life expectancy is about 30-50 years. This is approximately 50% longer than the average "human" warrior. Of course, there are exceptions to the rule, so there are some veterans (15%) pushing 80, while some new 'Borgs perish after a few months of service. Such is war.

The ability to effectively create and use any face the person may desire is an example of why the Warlords try to keep such tight reign over the authorization process for bionic reconstruction and full conversions. If not careful, D-Bees and aliens could infiltrate their Camps by pretending to be humans in cyborg bodies sculpted with fake human features. This is a constant risk that the Warlords must live with. DNA testing can be performed on those suspected of being alien imposters, but there are too many warriors in each Camp to keep under constant scrutiny. Suspects found to be imposters are usually destroyed without hesitation. Killing them is the commonly preferred option because the capture and interrogation of a Heavy Borg is both difficult and dangerous. However, this choice is usually left to the discretion of the officer(s) in charge.

Heavy Machines are built for front-line combat and to take tremendous punishment. They are also designed to dish out tremendous punishment. Consequently, these 'Borgs have sacrificed speed, mobility and human appearance, for larger, stronger bodies, heavy armor and **firepower**.

The majority of Heavy Cyborgs and Cyborg Shocktroopers come to identify with their powerful robot bodies. They think of themselves as living weapons of destruction. Surprisingly, most have no regrets, and forget about, or push out of their minds, their past lives as human beings. Many associate primarily with other cyborgs, and feel detached from **and/or** a bit uncomfortable around flesh and blood people. For many, their past life is only a tiny fragment of their existence, submitting to bionic conversion at an early age (typically ages 17-24). Their days as soft, weak creatures are (gladly) gone forever. For some, those days are an unpleasant memory, or a passing experience like some half remembered dream. Now and forever more, they are creatures of incredible power. They have been rebuilt to be more than human — and they revel in it. The majority love what they have become and want nothing else. In the War Camps, they are among the greatest heroes, and enjoy social status and privileges that few can ever hope to attain. Only the *Cyborg Shocktroopers*, *War-Knights* and *Smoke Soldiers* are regarded more highly by their Warlord masters, and only the first two are acknowledged by the people. The common man heralds them as the ultimate patriots, willing to abandon their humanity to save humanity! Furthermore, the Heavy Machines see themselves as superheroes: incredibly, **superpowered** beings of flesh and metal fighting for a higher cause (and most ordinary folk share this sentiment).

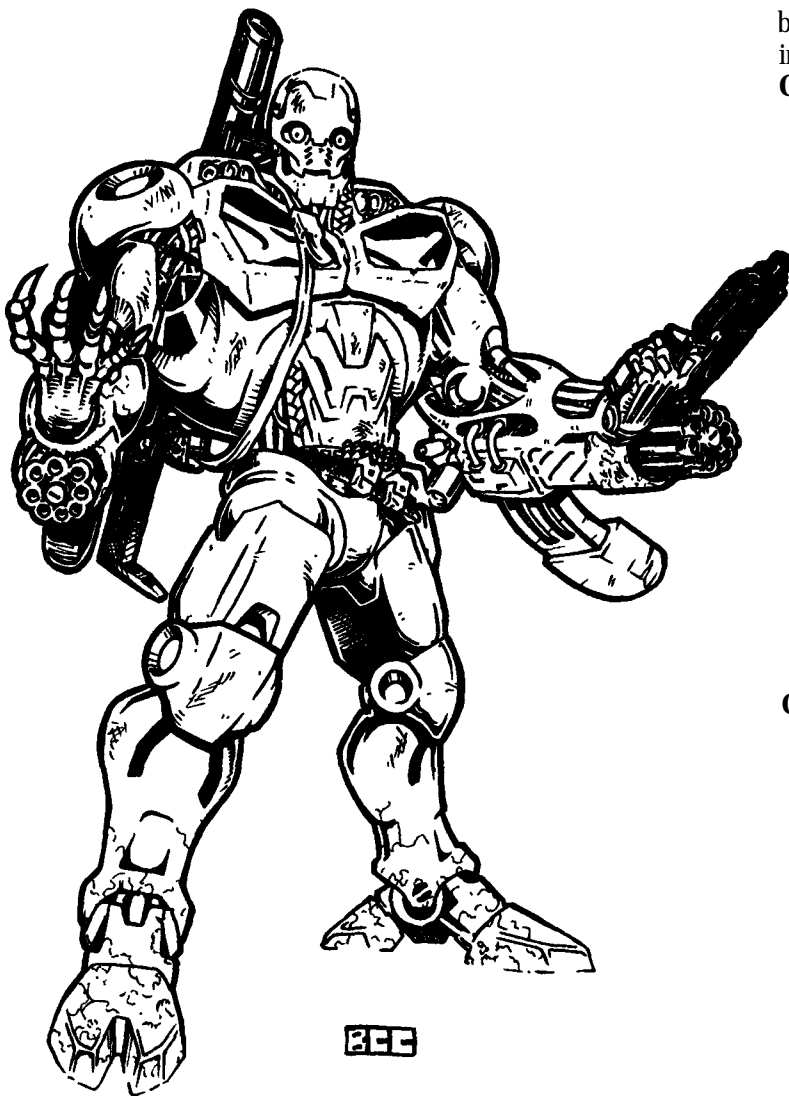

A small minority (about 4-6%) do regret their decision to become living machines, and grow to hate their inhuman bodies. These pitiful souls often become cold-hearted killing machines, sadists, and monsters who turn to crime and villainy. These are dangerous misanthropes who usually have little regard for humanoid life, and like to hurt, torture, torment and kill. Some also enslave other “weaker” beings (including humans) or establish their own small kingdoms or crime-rings where they rule as tyrants.

Heavy Machines are hulking giants that stand 8-12 feet (2.4 to 3 m) tall and often have unusual appendages and weapons protruding from their bodies, preventing them from wearing normal clothing and body armor, or use many types of equipment and vehicles standard for humans. It is impossible to mistake them as human, whether they retain a human face or not. Only about 40-50% of the Heavy Machine cyborgs keep their original human identity. The rest have mechanical or inhuman looking faces and their only identity is that of the mechanized, cyborg hero in the service of the Warlords and Mother Russia.

Heavy Machine Cyborg Soldier/Warrior/Merc

Class: Full Conversion Heavy Cyborg.

Attribute Requirements: M.E. 12 or higher is suggested, as is a good I.Q. (9+), but all that is required is a human in good mental health, with the spirit to fight and the belief that being a *Mashiniye Chilovyeki* is a good and desirable thing. Once the

bionic conversion is performed, there is no hope of ever becoming human again.

O.C.C. Skills:

Native Language (probably Russian; at 92%)

Language: Euro (+15%)

Language: One of choice (+10%)

Radio: Basic (+15%)

Radio: One of choice or Computer Operation (+10%)

Pilot: Two skills of choice (+10%)

Military Etiquette (+10%)

Climbing (+10%)

Swimming (+10%)

W.P. Paired Weapons

W.P. Knives or Swords

W.P. Energy Rifle

W.P. Heavy Weapons

W.P. Trick Shooting (choice of only one)

W.P. Three of Choice (any)

Hand to Hand: Expert, but can be changed to Martial Arts (or Assassin if anarchist or evil) for the cost of one O.C.C. Related skill.

O.C.C. Related Skills: Select three MOS skills (with a +15% bonus each) from *one* of the following categories: Communications, Espionage, Military, or W.P., regardless of whether or not it's normally available. In addition, select four other skills of choice from the list below. One additional skill is selected at levels 4, 8 and 12. All new skills start at level one proficiency.

Communications: Any (+10%)

Domestic: Any (+5%)

Electrical: None

Espionage: Intelligence and Interrogation only.

Mechanical: None

Medical: First Aid only (+5%)

Military: Any (+10%)

Physical: Any that are still appropriate.

Pilot: Any (+5%)

Pilot Related: Any (+10%)

Rogue: None

Science: Math only.

Technical: Any (+10%)

W.P.: Any, except additional Trick Shooting skills.

Wilderness: Land Navigation only (+5%).

Secondary Skills: The character also gets to select two secondary skills from the list, excluding those marked "None," at levels 2, 4, 8 and 13. These are additional areas of knowledge that do not get the advantage of the bonus listed in parentheses. All secondary skills start at the base skill level.

Standard Military issue for Cyborg Soldiers: All the appropriate ammunition and equipment for the Borg's body styling and weapon systems. One weapon and four extra E-clips for each W.P., distancing binoculars, utility belt, backpack, walkie-talkie (for backup), utility belt, and regular maintenance and repairs.

Also see Typical Bionics.

Vehicle: None to start. Vehicles must be able to support the heavy cyborg's bulk, size and weight.

Equipment Available Upon Assignment: Borg jet pack, vehicle or other transportation, additional weapons and equipment. The character also has access to Warlord sanctioned or

owned bionics facilities and free repairs and replacement of bionics damaged or lost in the line of duty. **Note:** Availability of equipment and bionics may be limited or unavailable depending on the local commander, supply stock, location and combat conditions.

Note: Heavy Machines are highly respected by the people and treated well by most of their fellow soldiers, including Cyborg Shocktroopers and War-Knights. Only some of the envious Reavers tend to treat them poorly or with disrespect.

Money: The Heavy Machine starts with **2D6x100** credits and **6D6x10** in **tradeable** goods. The monthly salary is 1,300-1,600 credits depending on rank and record, plus all their basic needs, weapons and repairs are provided for by the Warlord.

Cybernetics: Typical Bionics: The following stats, weapons and features are typical of the average Heavy Machine. Customizing, personal tastes, and additional bionics acquired as rewards for heroism, duty, and rank, as well as authorized purchases, may come later. Of course, there are reasonable limitations. Those not associated with a Warlord are on their own in acquiring additional bionics and start with one less weapon, one less head feature, and don't have the Gromeko FFI system.

Average Size: 8-12 feet (2.4 to 3.6 m) tall.

Weight: 700-1200 pounds (315 to 540 kg).

Power Source: Nuclear

M.D.C. by Location:

* Forearm Weapons (2; one each arm) — 25 each

* Arms (2) — 100 each

* Hands (2) — 30 each

Legs (2) — 125 each

* Feet (2) — 45 each

** Head — 100; it may be flesh outside, but underneath is a metal skull, plus it is usually protected with additional M.D.C. from a helmet and visor or helmet and face plate from bionic **body** armor; typically 80 M.D.C. Many 'Borgs, especially full conversion Heavy Machines, wear a bionic or metal face plate reminiscent of the ancient Samurai. The face plate can look high-tech, human or monstrous.

*** Main Body — 270, plus M.D.C. from light (140 M.D.C.), medium (180 M.D.C.), or heavy (280 M.D.C.) cyborg body armor. Heavy Machines cannot wear human-sized armor. Cyborg armor is heavier and thicker than normal body armor, but can be more easily accommodated by the augmented mechanical body with comparatively minimal penalties: -10% to prowl, acrobatics, gymnastics, swim, climb, palming, and similar skills when using light or medium armor, -20% for heavy.

Damage Notes:

* A single asterisk indicates a small **and/or** difficult target to hit. The attacker must make a "Called Shot" and even then he is -3 to strike.

** Destroying the head of a cyborg will kill the character! This is where the brain is housed and when it's **gone**, that character is dead. However, the rest of the body can be salvaged and reused.

*** Depleting the M.D.C. of the main body will effectively destroy the artificial body, but emergency systems will keep the brain and vital organs alive for 12 hours. Recovery of the dam-

aged body will enable Cyber-Docs to place the character on a life support system that will keep him alive until a new bionic frame becomes available. Failure to find the brain within 12 hours means the character dies. Massive amounts of damage (100 or more M.D.C. below zero) completely destroy the 'Borg, with no hope of recovery.

Bionic Attributes:

- Tactile sensitivity: Typically 45%.
- Robotic P.S. is typically 28-35 (M.D.C. damage from punches and kicks. See robot P.S. on page 25 of *Rifts® Conversion Book One*; does a minimum of 1D6 M.D., double for a power punch.
- Bionic P.P. of 20-24.
- Face: P.B. Modifier: Pick one.
 1. Natural face, roll 3D6 as usual (+1D6 if a 16-18 is rolled).
 2. 3D6+6 if a sculpted human face is used and the character wants to be attractive (may be the original face tweaked and modified to look better).
 3. 1D6+4 if the face is the standard robotic one without any human facial features (as depicted in the illustration).
 4. 1D4+3 if a monstrous, frightening or inhuman face (animal, insect, demon, etc.) is used; Horror Factor 11.
- Bionic Speed Running: 100 mph (160 km).
- Leaping: Super powerful hydraulic leg pistons are capable of launching the full conversion Heavy Machine 12 feet (4.3 m) high or 22 feet (6.7 m) lengthwise; increase by 50% with a running start.
- Speed & Flight Options: **Cyberjet** Nodes for jet assisted leaps, increased speed and limited hovering, or 'Borg jet packs (see *cybernetic equipment section* for details), or by vehicle.

Bonuses:

- +2 on initiative.
- +3 to pull punch.
- +1 to strike.

Cost: Around 2.1 million for the Warlords, 3.2 to 4.5 million credits on the open market.

Standard Cybernetic Systems (non-weapon types):

1. Full 20/20 Enhanced Color Vision (to **line-of-sight**)
2. Multi-Optic Eye
3. Multi-System Eye Socket
4. Universal **headjack/ear** implant with Augmentation
5. Amplified Audio
6. Built-in Language Translator
7. Built-in Radio Transmitter & Receiver (5 miles/8 km)
8. **Cyberlink** Vehicle Interface (2; one in hand and head).
9. Gromeko Friend or Foe Identification Computer.
10. Bionic Lung with gas filter & oxygen storage cell.
11. Clock Calendar
12. Gyro-Compass

Standard Weapon Systems & Special Features:

1. Major Weapon Forearm for one, if not two, arms: These can include Mekanikal Forearm Weapons, **Multi-Weapon** systems or Hydraulic arm features/weapons presented in this book, or two arm weapons of choice.

2. Wrist Weapon of choice: This item can be built into one or both hands/wrists. It retracts when not in use and extends to fire. When only one unit is used in one hand, the other hand typically has a different weapon system, often a chemical spray, **garrote** wrist wire, or wrist needle and drug dispenser.

3. Additional Hand Features or Weapons (to start): Two per hand, of choice. This may be in addition to features offered by Weapon Arm Packages. The G.M. may modify or restrict certain items.

4. Additional Leg Features or Weapons (to start): Each leg gets one bionic feature or weapon of choice for one leg.

5. Additional Head & Neck Features. Select three additional **face/head**, neck or eye features or weapons; the armored face plate is a very popular item

6. Optional Weapons. In addition to bionic weapons and features, the character will own and use a variety of conventional weapons. Most favor rail guns and other heavy weapons.

7. Vibro-Blade or other blade weapons may be plated in silver to combat supernatural beings vulnerable to such things.

8. Chemical Sprays may fire holy water — water or oil blessed by a priest and used against vampires and certain other supernatural beings.

Cyborg Shocktroopers

Sometimes referred to as "Ultra Machines," these are the Warlords' elite and most deadly cyborg warriors. The Shocktroopers are dedicated human soldiers who volunteer from the ranks of the Knights of the Realm to be transformed into some of the most powerful cyborgs on Earth. Most volunteers come from loyal families that have served one particular Warlord for generations. These dedicated men and women willingly subject themselves to full bionic conversion to massive mechanical constructs that have little to no human semblance.

These dedicated warriors hold a high place in the hierarchy of the War Camps, just below the War-Knights. Presumably it is the complete acceptance of cyborgs and the place of honor they hold in Russian society that helps keep these inhuman looking warriors mentally sound and emotionally happy. Of all the societies that use cyborgs, none encourages and welcomes cybernetic augmentation more than the Warlords of Russia. As a result, the Russian 'Borgs do not feel out of place, ostracized or inhuman, and exhibit tremendous self-esteem, confidence, pride and happiness. In this combat and machine oriented society, the biggest, strongest, bravest warriors are the most revered and the Shocktroopers are without **dispute**, the biggest and strongest. To prove they are also the bravest, these 'Borgs often take on overwhelming numbers of the enemy, and accept the most dangerous challenges offered by their commanders or Warlords. Likewise, they often lead the charge into battle and can usually be found in the thick of battle. Their machine bodies and emotion driven minds make the Cyborg Shocktroopers resilient and relentless combatants with a small arsenal literally at their fingertips.

The Cyborg Shocktrooper is built for heavy assault and mass destruction, but many are also capable of stealth and a variety of combat functions. Some sacrifice speed and mobility for fire-power or armor, and vice versa, but all are deadly; heavily ar-

mored and armed to the teeth. They lumber into combat as some of the most bizarre and frightening combatants on Rifts Earth! A squad of 11-13 foot (3.3 to 4.1 m) tall, four-armed Cyborg Shocktroopers wielding two pairs of 5 foot (1.5 m) long **Vibro-Blades** and a rail gun, thundering across a missile-crater field or a giant, metal-winged 'Borg diving from the sky like some demented robot angel, is an apocalyptic sight. And they are mild-looking when compared to Cyborg Shocktroopers like the *Aftermath*, *Holocaust*, *Butcher* and *Demonfist*. In combat, they are a nightmare given form. Using Vibro-Blades, Cutters and their bare hands, they wade into the thick of a battlefield. And tear through tanks, fortifications and supernatural fiends with guns blazing.

The vast majority (90+%) are dedicated and consummate soldiers who are seemingly fearless. They shrug off a bionic arm or leg being seared off from a shower of mini-missiles or magic lightning bolts as if it were nothing, and press the attack. Most will fight until the battle is won, or they physically cannot, or their commanders issue a retreat.

Cyborg Shocktroopers share a kinship and sense of unity unmatched among any other factions in the Warlord's Camp. They see each other as brother heroes, and part of an extended (and expansive) family or brotherhood to which each is steadfastly loyal. They fight at each others' side, confident that their comrades will not desert them. They bleed, fight and die for each other without remorse or hesitation. Fallen comrades are scooped up on the way off the battlefield, even during hasty retreats. Few cyborgs are ever intentionally left behind. Even shattered remains that seem devoid of life are grabbed and carried to safety, for fellow cyborgs know that it may literally contain the life blood and brain of the soldier held safely inside. Furthermore, parts from the dead can be salvaged and reused — better to be retrieved by their War Camp than to let them fall into enemy hands.

Cyborg Shocktroopers

Class: Full Conversion Heavy Cyborg.

Player Note: As an adventurer, the advantage of having a Cyborg Shocktrooper speaks for itself. It's nice to have a mountain of metal behind you when negotiating or facing down bandits or supernatural forces. On the other hand, they attract trouble and are often the targets of the worst assaults (assailants figuring they need to liquidate the cyborg threat first). The character can be any alignment, and played as a fiercely singular presence, a team player, a lone wolf, or quiet wall-flower (except in combat).

As noted earlier in this section, most Cyborg Shocktroopers (80%) stay in loyal service to their Warlords for their entire lives. Only about 15% ever leave the War Camp and their Warlord masters to embark on their own adventures, but even they usually hold onto old loyalties and stay loyal sympathizers to their old allies. This can mean periodic friendly encounters, trade with War Camps, and exchanges of information. These ex-patriots will freely warn and help their old War Camp whenever they can, and may even fight at their side or accept freelance missions on their behalf.

Although the exact number varies from Camp to Camp, only about 5% leave their Warlord and comrades under truly bad circumstances. This is typically under a cloud of suspi-

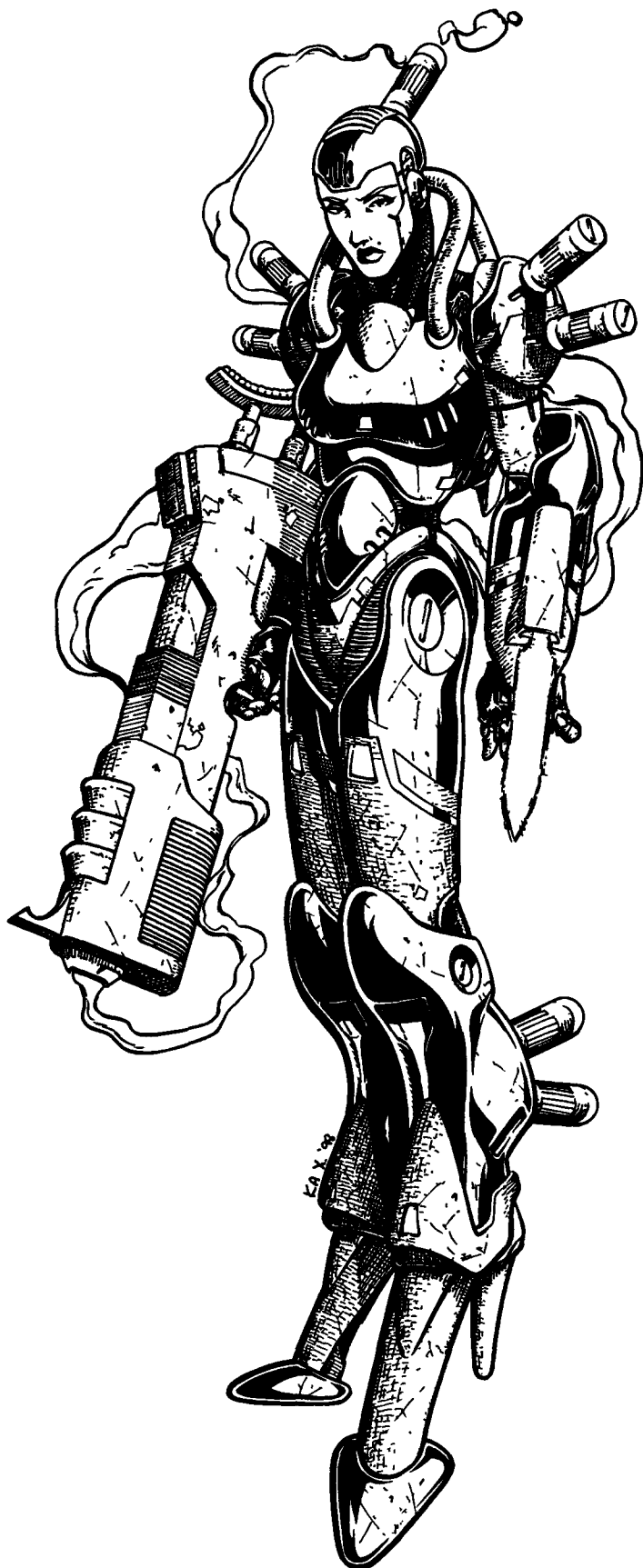

cion or an act of betrayal, treachery or desertion. Such villains are the lowest of the low and the most despised of all enemies.

Cyborg Shocktrooper O.C.C.

All Shocktroopers have the same basic training. In many ways, they are souped-up Heavy Machines designed explicitly for heavy combat, which their skills reflect.

Attribute Requirements: M.E. 12 or higher is suggested, as is a good I.Q. (9+), but all that is required is a human in good mental health, with the spirit to fight and the belief that being a *Mashiniye Chilovyeki* is a good and desirable thing. Once the bionic conversion is performed, there is no hope of ever becoming human again.

O.C.C. Skills:

Native Language (probably Russian; at 90%)

Language: Euro (+15%)

Language: One of choice (+10%)

Basic Math (+10%)

Radio: Basic (+15%)

Radio: One of choice or Computer Operation (+10%)

Pilot: Two skills of choice (+10%)

Military Etiquette (+10%)

Find Contraband (+10%)

Intelligence (+15%)

Interrogation (+15%)

Climbing (+10%)

Swimming (+10%)

W.P. Paired Weapons

W.P. Sword

W.P. Energy Rifle

W.P. Heavy Weapons

W.P. Four of Choice (any)

Boxing (don't forget about the extra attack this provides).

Hand to Hand: Expert, which can be changed to Martial Arts (or Assassin if anarchist or evil) for the cost of one O.C.C. Related skill.

O.C.C. Related Skills: Select four MOS skills (with a +15% bonus each) from *one* of the following categories: Communications, Espionage, Military, or W.P., regardless of whether or not it's normally available. In addition, select three other skills of choice from the list below. One additional skill is selected at levels 4, 8 and 12. All new skills start at level one proficiency.

Communications: Any (+10%)

Domestic: Any (+5%)

Electrical: None

Espionage: Intelligence and Interrogation only.

Mechanical: None

Medical: First Aid only (+5%)

Military: Any (+10%); many are demolitions experts.

Physical: Any that are still appropriate.

Pilot: Any (+5%)

Pilot Related: Any (+10%)

Rogue: Any

Science: Math only.

Technical: Any (+10%)

W.P.: Any, except Trick Shooting.

Wilderness: Any

Secondary Skills: The character also gets to select two secondary skills from the list, excluding those marked "None," at levels 2, 4, 8 and 13. These are additional areas of knowledge that do not get the advantage of the bonus listed in parentheses. All secondary skills start at the base skill level.

Standard Military issue for Cyborg Soldiers: All the appropriate ammunition and equipment for the **Borg's** body styling and weapon systems. One weapon and four extra **E-clips** for each **W.P.**, distancing binoculars, utility belt, backpack, walkie-talkie (for backup), utility belt, and regular maintenance and repairs.

Also see Specific Arch-Typical Cyborg **Shocktroopers**.

Vehicle: None to start. Vehicles must be able to support the heavy cyborg's **bulk**, size and weight.

Equipment Available Upon Assignment: 'Borg Jet **pack**, explosives, vehicle or transportation, additional weapons and equipment. The character also has access to Warlord sanctioned or owned bionics facilities and free repairs and replacement of bionics damaged or lost in the line of duty. **Note:** Availability of equipment and bionics may be limited or unavailable depending on the local commander, supply **stock**, location and combat conditions.

Note: Shocktroopers are highly respected by the people and treated well by most of their fellow soldiers, including and War-Knights. Only some of the envious Reavers tend to treat them poorly or with disrespect.

Money: The Cyborg **Shocktrooper** starts with **1D6x1000** credits and **3D6x100** in **tradeable** goods. The monthly salary is 1,600-2,200 credits depending on rank and record, plus all their basic needs, weapons and repairs are provided for by the Warlord.

Cybernetics: Typical Bionics: Each type of Cyborg Shocktrooper has its own unique design, strengths, weaknesses, abilities and *special* weapons. These design parameters and special weapons are only available to the Cyborg **Shocktrooper(s)** of a particular Warlord and his Camp. No others use them.

The following stats and features are typical of most Cyborg Shocktroopers, but the specific statistical data and unique weapons are described separately under the name of each Warlord. Some customizing and identification markings are allowed, but most Cyborg Shocktroopers of a particular Warlord look the same.

Racial Restrictions: Exclusively human, approved by the Warlord.

Average Size: 10-14 feet (3 to 4.3 m) tall.

Weight: 1-4 tons

Power Source: Nuclear

M.D.C. by Location: Varies with specific type.

Bionic Attributes:

- Tactile sensitivity: Typically 35% to 55%.
- Robotic P.S. is typically 35-50 (M.D.C. damage from punches and kicks. See robot P.S. on page 25 of *Rifts® Conversion Book One*; does a minimum of 1D6 M.D., double for a power punch.
- Bionic P.P. of 20-24.

Bonuses: Each Shocktrooper will have its own set of bonuses.

Standard Cybernetic Systems (non-weapon types):

1. Full 20/20 Enhanced Color Vision (to **line-of-sight**)
2. Multi-Optic Eye
3. Multi-System Eye Socket
4. Universal **headjack/ear** implant with Augmentation
5. Amplified Audio
6. Built-in Language Translator

7. Built-in Radio Transmitter & Receiver (5 miles/8 km)
 8. **Cyberlink** Vehicle Interface (2; one in hand and head).
 9. Gromeko Friend or Foe Identification Computer.
 10. Bionic Lung with gas filter & oxygen storage cell.
 11. Clock Calendar
 12. Gyro-Compass
 13. Weapon Mounts: 3-6
- ... and the usual features common to cyborgs.

The Warlords' Arch-Typical Cyborg Shocktroopers

The following are specific Cyborg Shocktroopers that have become synonymous trademarks of specific Warlords and their Camps. These designs are *never* knocked-off or duplicated, even by foreigners, because to do so means full-scale war from the offended Warlord (this happened only twice before everybody got the message).

Each Cyborg Shocktrooper is unique to his War Camp. Most Camps only have one type of elite Shocktrooper, but a few have two. All War Camps also have a legion of additional Light and Heavy Machines of varying types, as well as similar designs. Many use helmets and face plates that are reminiscent of the Cyborg Shocktroopers. Each suit is different, and stresses a *de-monic or monstrous* appearance. The Warlords and their troops believe the look adds to their grim visage and helps to intimidate and frighten both their enemies and the people they rule. They are also designed with combating demons, monsters, and the supernatural in mind. Each is listed by Warlord.

The Warlords of Russia

Alekseyevna — Tempest

Burgasov — Ripper and Butcher

Kolodenco — White Tiger

Orloff — Holocaust and Aftermath

Romanov — Avenging Angel

Seriyev — Assassin and Mantis

Sokolov — Demonfist

Alekseyevna 'Borg Tempest

The Tempest is one of the few flying cyborgs and may have been inspired from old American Empire designs for the SAMAS power armor "acquired" by the New Soviet Union before the Great Cataclysm. Like the SAMAS, it is a low altitude flyer with large jets in its back. When not flying, the wings can fold up behind the back. The Tempest is built for speed, stealth and agility, although it is not as **fast**, mobile or stable as a SAMAS.

The flight system is where the similarity to the SAMAS ends. The Tempest is a cyborg, not power armor. The body is thick and heavily armored. The head is that of a mechanical dragon, with a crown of jagged spikes that look like real bone. The bone-like spikes jut from the crest of the head and run down

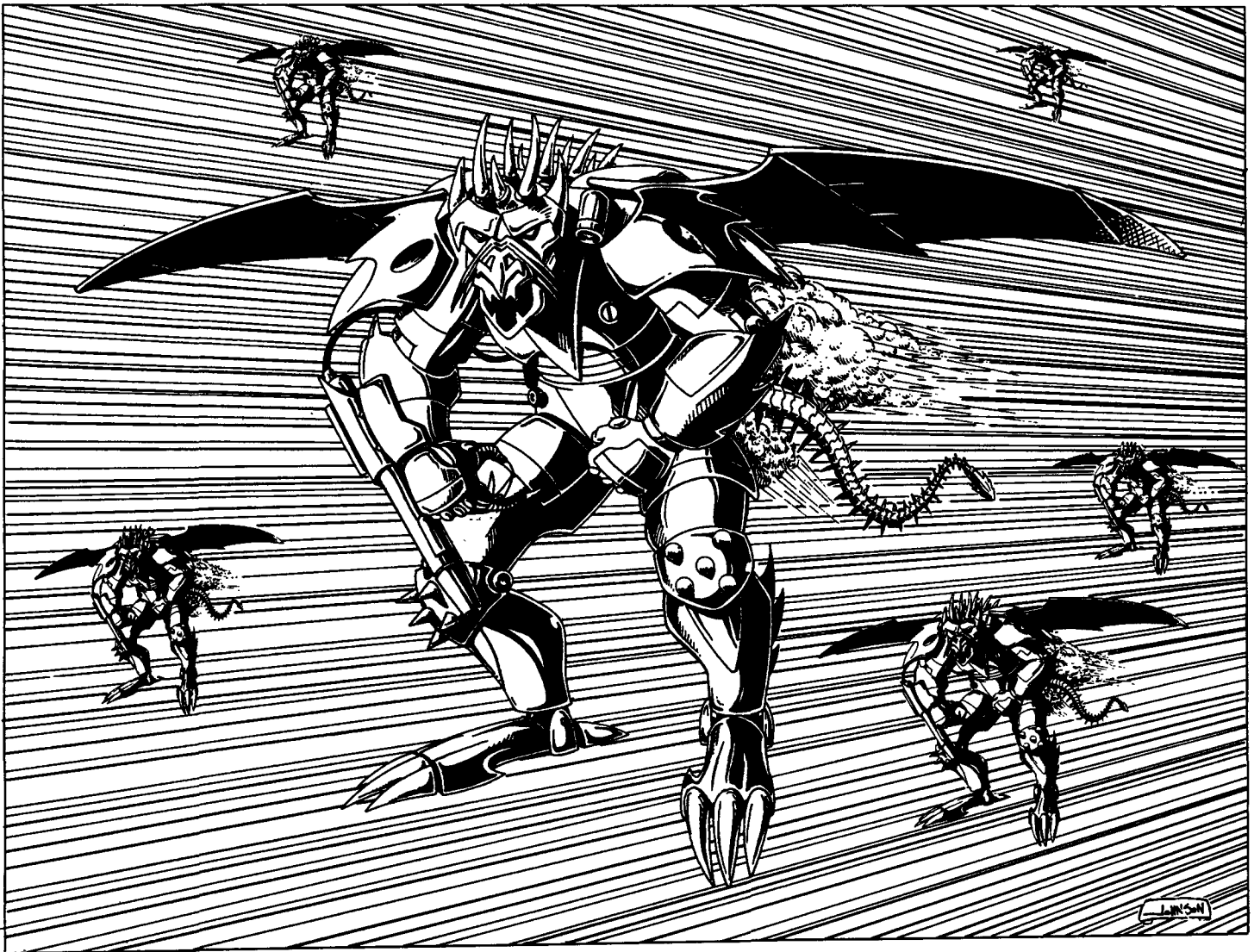

the spine and along its long, prehensile, mechanical tail. A tail that can be used to rake opponents with its spines, ensnare the enemy, or strike them with an energy ball at its tip, like an energized mace.

From the grinning mouth of its large dragon head comes bursts of fire, and from its eyes, twin laser beams. The feet are large and flat, enabling the Tempest to ski across the surface of water, ice and snow. Its three long toenails are **Vibro-Blades** that can be used to slash, cut and impale opponents as it flies by them. The fingers of the hands are designed to have a "taloned," bird of prey appearance, complete with retractable finger claws. Mounted on the right arm is a heavy gun, either a plasma cannon or rail gun (Borg's option), and concealed in the left is a light laser. The large, ribbed shoulder plates also offer more than extra protection to the head and shoulders. Concealed under each is a pair of mini-missile launchers. The Tempest was the first of the flying cyborgs and arguably the most successful. Although it has been improved and upgraded over time, it has been in use for nearly 70 years. According to rumor, the **Wingrider** Flying Wing and **Avenging Angel** were developed as a **countermeasure** to the powerful Tempest. **Note:** What the Tempest lacks in speed and mobility, it makes up for in raw firepower and can withstand tremendous amounts of damage.

Tempest Cyborg Shocktrooper

Class: Flying, Full Conversion Cyborg

M.D.C. by Location:

- Forearm Plasma Gun (or optional rail gun) — 60
- Shoulder Plates/Mini-Missile Launchers (2) — 100 each
- * Concealed Forearm Laser (1; left) — 10
- * Head & Spine Spikes (approx. 60) — 10 each
- * Hands (2) — 50 each
- Arms (2) — 120 each**
- Legs (2) — 180 each**
- Feet (2) — 80 each
- * **Tail (1) — 60**
- Shoulder Wings (2) — 75 each
- Main Rear Jets (2) — 70 each
- Lower Maneuvering Jets (3) — 25 each
- ** Head with Built-in Dragon Face Plate — 160
- *** Main Body — 340, plus 180 M.D.C. (medium) or 280 (heavy) from additional cyborg body armor.

Damage Notes:

* A single asterisk indicates a small and/or difficult target to hit. The attacker must make a "Called Shot" and even then he is -3 to strike.

** Destroying the head of a cyborg will kill the character! This is where the brain is housed and when it's gone, that character is dead. However, the rest of the body can be salvaged and reused.

*** Depleting the M.D.C. of the main body will effectively destroy the artificial body, but emergency systems will keep the brain and vital organs alive for 18 hours. Recovery of the damaged body will enable Cyber-Docs to place the character on a life support system that will keep him alive until a new bionic frame becomes available. Failure to find the brain within 18 hours means the character dies. Massive amounts of damage (100 or more M.D.C. below zero) completely destroy the 'Borg, with no hope of recovery.

Speed:

Running: 70 mph (112.6 km) maximum.

Leaping: The jet propulsion jets and wings, even when folded, make leaping awkward and difficult. Can leap eight feet (2.4 m) high and 12 feet (3.6 m) lengthwise; increase by 20% with a running start. Jet **thruster** assisted leaps can hurl the Tempest 100 feet (30.5 m) high and 200 feet (61 m) across.

Flying: The rocket propulsion system enables the Tempest to hover stationary up to 200 feet (61 m) high and fly at a maximum speed of 240 mph (384 km). Cruising speed is considered to be around 100 mph (160 km). Maximum altitude is 500 feet (152 m).

Flying Range: The jets need to cool after about 8 hours of constant use. Draws on the nuclear power supply of the 'Borg for unlimited power.

Statistical Data:

Average Height: 13 feet (3.9 m) to the tip of his horns.

Width: Five feet, 6 inches (1.7 m) at the shoulders; 16 feet (4.9 m) with wings fully extended.

Length: 7 feet (2.1 m).

Weight: 2 tons.

Tactile sensitivity: 45%.

Robotic P.S.: 38

Bionic P.P.: 22

Face: Monstrous Dragon head and face plate.

Horror Factor: 11

Bonuses:

+1 melee attack from the prehensile tail

+2 on initiative

+1 to strike

+2 to parry

+2 to dodge while airborne

+3 to pull punch

+2 to roll with punch, fall or impact

+5 to save vs Horror Factor

Power System: Nuclear; average life is 20 years.

Black Market Cost: N/A. The process is secret and never shared with outsiders, much less offered for sale!

Warlord Cost: 3.5 million credits; the equivalent elsewhere would cost 6-8 million.

Tempest Weapon Systems:

1. Breathe Fire/Flame Thrower: Streams of fire can be unleashed from the mouth of the Dragon-like head.

Primary Purpose: Anti-Personnel & Defense.

Mega-Damage: 2D6 M.D. per blast.

Rate of Fire: Each blast counts as one melee attack.

Range: 100 feet (30.5 m).

Payload: 12 blasts before the fuel canister needs replacing.

2. Laser Beam Eyes: Actually, a pair of tiny, hidden lasers are located just under the glowing red eyes of the Tempest, so

when they are fired, they appear to be coming directly from the eyes. A single blast can be fired from one eye or twin blasts from both. Line-of-sight aiming and positioning, so the entire head must move to take aim.

Primary Purpose: Anti-Personnel and Defense.

Mega-Damage: 1D6 M.D. per single blast, 2D6 per simultaneous, dual blast at the same target (counts as one melee attack).

Rate of Fire: Each blast counts as one melee attack.

Range: 1,600 ft (488 m).

Payload: Effectively unlimited.

3. Concealed Forearm Laser: A laser pops out of a concealed compartment in the forearm (typically the left arm) for additional **firepower**.

Primary Purpose: Cutting Tool and Precision **Shooting/Sniping**.

Mega-Damage: Can be adjusted to fire 1D6 or 2D6 M.D. per blast.

Rate of Fire: Each blast counts as one melee attack.

Range: 1,600 ft (488 m).

Payload: Effectively unlimited.

4. Forearm Plasma Gun: Typically worn on the right forearm.

Primary Purpose: Anti-Personnel/Anti-Vehicle.

Mega-Damage: 6D6 M.D. per blast.

Rate of Fire: Each blast counts as one melee attack.

Range: 1,200 feet (366 m).

Payload: Effectively unlimited, because it draws on the cyborg's power supply via a connecting cable.

Note: The comparatively short-ranged plasma gun can be replaced with a rail gun that does 1D4x10 M.D. per burst, can fire 100 bursts, at a range of 4000 feet (1200 m), but requires an ammo-drum hooked to the back behind the head, and between the wings. It offers slightly better firepower and significantly greater range, but has a limited payload.

5. Mini-Missile Shoulder Launchers (2): Four shot mini-missile launchers are mounted on the shoulders under armored plates.

Primary Purpose: Anti-Aircraft and Flying Monsters.

Missile Type: Any mini-missile can be used, but standard issue is armor piercing (1D4x10 M.D.) or plasma (1D6x10). Fragmentation may be used against ground troops.

Mega-Damage: Varies with missile type.

Range: About a mile (1.6 km).

Rate of Fire: One at a time or volleys of two or four.

Payload: 8 total, four per shoulder.

6. Vibro-Blade Finger Claws: The fingers on each hand have **Vibro-Blades**.

Mega-Damage: 4D4 M.D. per claw strike.

Range: Hand to Hand combat; the reach of the arm, which is about 6 feet (1.8 m).

7. Vibro-Blade Feet: The large, flat feet are tipped with foot long Vibro-Blades that do additional damage when kicks are performed and can be used to rake, cut and stab enemies as the demonic Cyborg **Shocktrooper** streaks down from the sky.

Mega-Damage: +3D6 M.D. to kick damage (in addition to P.S. damage), or 1D6 M.D. from a glancing blow/cut (one of the outer toe-blades hits).

Range: Hand to Hand combat; the reach of the leg, which is about 7 feet (2.1 m).

8. Spiked Prehensile Tail: The 10 foot (3 m) long tail can be used as a slashing weapon with the spikes, a striking weapon

with the weighted ball or spike at the tip of the tail (releases an electrical charge), or as an additional appendage to grab, hold and carry.

Mega-Damage: A hit from the spiked tail does 4D6 M.D. while the **Electro-Spike/Ball** at the end of the tail does 3D6 M.D. by touch or a short-range blast.

Range: Hand to Hand combat; the reach of the tail, which is about 10 feet (3 m), or a short-range blast up to 20 feet (6 m) away.

9. Robot P.S. and Punch Damage:

Claw Strike — 4D4 M.D.

Head Butt with Spikes — 3D6 M.D.

Tail Strike — 4D6 M.D.

Restrained Punch — 1D4 M.D.

Full Strength Punch — 2D6 M.D.

Power Punch — 4D6 M.D.

Kick — 2D6 M.D. +3D6 **Vibro-Blade** damage.

10. Cyber Shield: Optional.

11. Hand-Held Weapons: Additional hand-held weapons, from energy rifles and rail guns to clubs and magic weapons, may be used by the flying cyborg. Many carry a dozen hand grenades in a satchel, which they drop or throw like mini-bombs.

Warlord Burgasov's 'Borgs The Butcher

Warlord Burgasov is said to have been cut from the same mold as the likes of Ivan the Terrible. He is a tough, no non-sense military man who is building an empire through military might and conquest. The two Cyborg **Shocktroopers** that dominate his legions are said to reflect his violent and merciless nature. This may be an exaggeration, but like Warlord Burgasov, they are cleverly designed, practical and efficient.

The Butcher Cyborg **Shocktrooper** is a large, hulking machine with a human shape and a massive, heavily armored frame. The head is protected by a cowl that rises up from the back of the main body, covering the back of the head and neck, as well as the top of the head. The head is also recessed behind a heavy metal collar that completely covers the neck and jaw portions of the head. The armor that covers the large shoulders offers additional protection to the head from the sides, ultimately making it an extremely difficult target to hit, even on a Called Shot by a sniper. He has maximum head protection, while at the same time, the cyborg has an unobstructed line of vision in the front and sides; a good example of Burgasov's ingenuity, practicality and efficiency.

The weapon systems include a pair of large Vibro-Swords, **Vibro-Knuckle** Blades, three forearm mini-missile launchers and a high-powered laser disguised like a forth launcher. The Butcher 'Borg can be equipped with a *Cyborg Jet Pack* for flight capabilities, plus roughly 25% have **Cyberjet**Nodes for jet assisted leaps, enhanced speed and limited hovering capabilities.

Butcher Cyborg Shocktrooper

Class: Superheavy, Full Conversion Cyborg

M.D.C. by Location:

* Forearm Mini-Missile Launchers (3) — 25 each.

* Heavy Laser (1; looks like a launcher) — 25

* Large Vibro-Swords (2) — 60 each

Heavy Shoulder Plates (2) — 140 each

* Concealed Palm Laser (1; left) — 10

* Hands (2) — 35 each

Arms (2) — 130 each

Legs (2) — 160 each

Feet (2) — 70 each

** Head with Mechanical Face Plate — 160

*** Main Body — 320, plus 180 M.D.C. (medium) or 280

M.D.C. (heavy) from additional cyborg body armor.

Damage Notes:

* A single asterisk indicates a small **and/or** difficult target to hit. The attacker must make a "Called Shot" and even then he is -3 to strike.

** In this case the attackers must make a "Called Shot" to hit the head, and even then are -6 to strike. Destroying the head of a cyborg will kill the character! This is where the brain is housed and when it's gone, that character is dead. However, the rest of the body can be salvaged and reused.

*** Depleting the M.D.C. of the main body will effectively destroy the artificial body, but emergency systems will keep the brain and vital organs alive for 18 hours. Recovery of the damaged body will enable Cyber-Docs to place the character on a life support system that will keep him alive until a new bionic frame becomes available. Failure to find the brain within 18 hours means the character dies. Massive amounts of damage (100 or more M.D.C. below zero) completely destroy the 'Borg, with no hope of recovery.

Speed:

Running: 120 mph (192 km) maximum.

Leaping: Those without jet propulsion can leap 12 feet (3.6 m) high and 20 feet (6 m) across; increase by 50% with a running start. Jet **thruster** assisted leaps can hurl the Butcher 100 feet (30.5 m) high and 200 feet (61 m) across.

Flying: Not possible unless a *Cyborg Jet Pack* is used, or the 'Borg has the *Cyberjet Node* package. See the Cybernetics section for details about the jet pack and Cyberjet Node.

Statistical Data:

Average Height: 11 feet (3.3 m)

Width: Five feet, 6 inches (1.7 m) at the shoulders.

Length: 5 feet (1.5 m)

Weight: 2.3 tons

Tactile sensitivity: 45%

Robotic P.S.: 38

Bionic P.P.: 22

Face: Tech/machine-looking face plate.

Horror Factor: 11

Bonuses: In addition to attribute and skill bonuses.

+2 on initiative

+1 to strike

+2 to parry

+4 to pull punch

+2 to roll with punch, fall or impact

+5 to save vs Horror Factor

Power System: Nuclear; average life is 20 years.

Black Market Cost: N/A. The process is secret and never shared with outsiders, much less offered for sale!

Warlord Cost: 2.9 million credits; the equivalent elsewhere would cost 6-7 million.

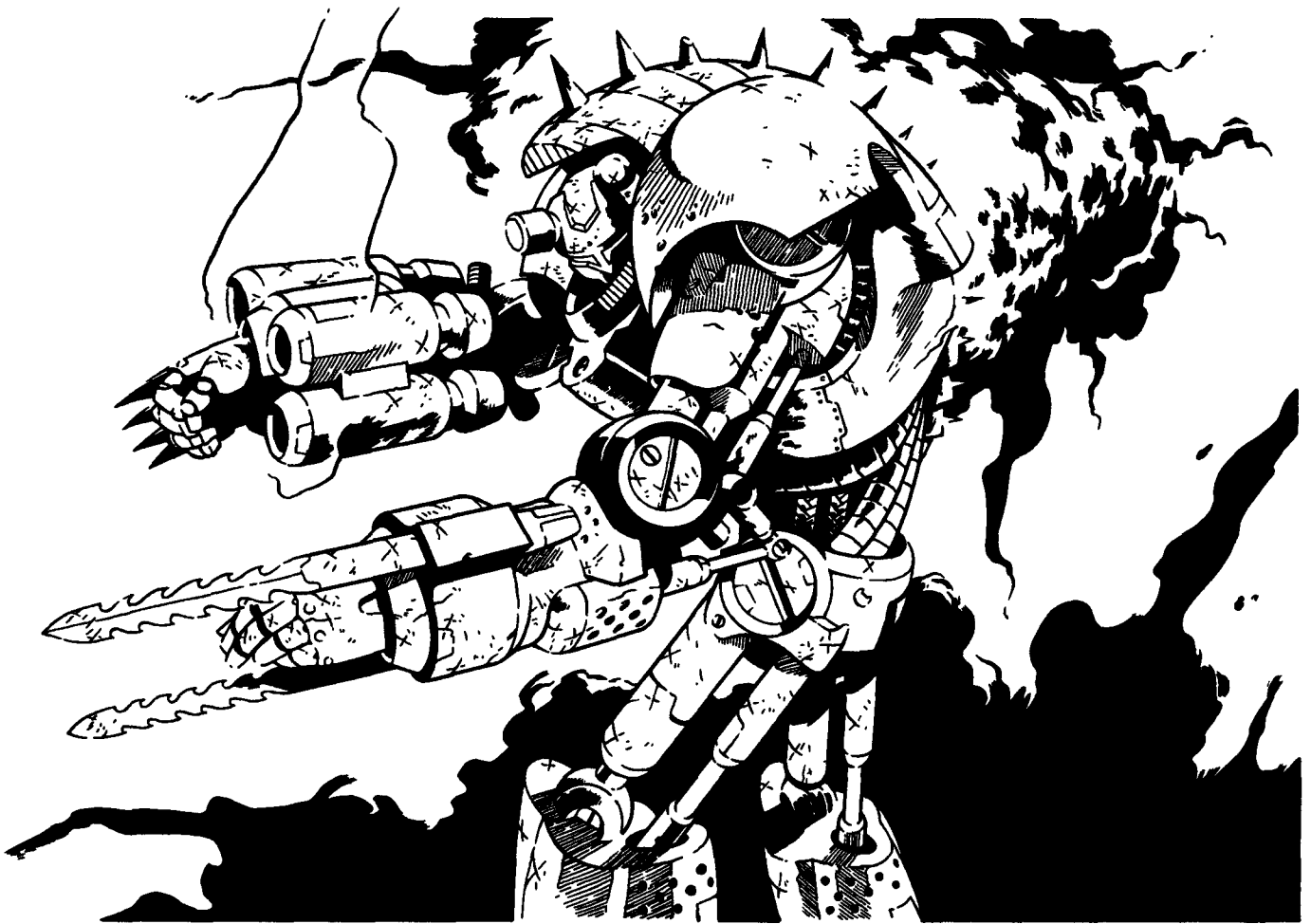

Butcher Weapon Systems:

- 1. Mini-Missile Forearm Launch Tubes (3):** Four three-shot mini-missile launchers are mounted on the right forearm. However, only three contain missiles; the fourth is a laser (see #2).

Primary Purpose: Anti-Aircraft and Anti-Flying Monsters.

Missile Type: Any mini-missile can be used, but standard issue is armor piercing (1D4x10 M.D.) or plasma (1D6x10). Fragmentation may be used against ground troops.

Mega-Damage: Varies with missile type.

Range: About a mile (1.6 km).

Rate of Fire: One at a time or volleys of three.

Payload: 9 total, three per launcher.

- 2. High-Powered Laser:** This forearm weapon is disguised as one of the mini-missile launchers on the right forearm. Point and shoot.

Primary Purpose: Anti-Personnel and Defense.

Mega-Damage: 3D6 M.D. per single blast.

Rate of Fire: Each blast counts as one melee attack.

Range: 3,000 ft (914 m).

Payload: Effectively unlimited.

- 3. Vibro-Blade Knuckle Claws:** The knuckles of the right hand have Vibro-Blades for additional punch damage and for raking opponents; silver plated.

Mega-Damage: 4D4 M.D. per raking claw strike, or add +4D4 M.D. to punch damage when they are used in a punching strike.

Range: Hand to Hand combat; the reach of the arm, which is about 8 feet (2.4 m).

- 4. W-42 Concealed Palm Laser:** A somewhat larger, heavier version of the short-ranged W-42 laser. It is built into the base of the palm and wrist of the left hand and offers better range. The device can be used as both a weapon and a cutting tool.

Primary Purpose: Tactical Weapon and Tool/Self-Defense.

Mega-Damage: Has four settings: 2D4x10 S.D.C., 1D4 M.D., 1D6 M.D., or 2D6 M.D. per single blast.

Range: 400 feet (122 m)

Rate of Fire: Each blast counts as one melee attack.

Payload: Effectively unlimited.

- 5. Vibro-Swords:** A pair of large, jagged, retractable Vibro-Blades are built into the left arm. Either one or both can be extended at a time and are excellent for parrying and striking.

Mega-Damage: 3D6 M.D. for one blade, or 6D6 M.D. from two.

Range: Hand to Hand combat; about 10 feet (3 m) when extended (3 feet/0.9 m longer than the arm).

- 6. Robot P.S. and Punch Damage:**

Raking Knuckle Claws — 4D4 M.D.

Vibro-Knuckle Punch — 4D6+2 M.D.

Restrained Punch — 1D4 M.D.

Full Strength Punch or Kick — 2D6 M.D.

Power Punch — 4D6 M.D.; but counts as two attacks.

- 7. Cyber Shield:** Optional

- 8. Hand-Held Weapons:** Additional hand-held weapons, from energy rifles and rail guns to clubs and magic weapons may be used by the cyborg.

9. Additional Bionic Systems Common to the Butcher:

- Interchangeable left weapon arm.
- One additional Bionic Eye feature of choice.
- 25% have Cyberjet Nodes for jet assisted leaps, enhanced speed and limited hovering capabilities.
- Cyborg Jet Pack is issued as needed.
- Hydraulic Ram Arm sometimes replaces the **Vibro-Blade** arm.

Ripper

The Ripper Cyborg **Shocktrooper** is a front-line assault unit designed to first decimate the enemy with missile barrages and then continue the assault in hand to hand combat with slicing and cutting claws and armor-cutting buzz saw blades. On the battlefield, the Ripper can be seen cutting through armored vehicles, fortifications and through bionic limbs, with the Butcher and Heavy Machines offering support. It is one of the most heavily armored of all the Warlords' cyborgs and can take a pounding.

The Ripper is a hellish looking monstrosity with a protective face plate that looks like a screaming demon. A pair of light lasers are built into the cheeks and are barely noticeable until the 'Borg uses them. Likewise, the warrior can expel noxious chemicals from its mouth and the chest plates open to reveal mini-missiles. The two long, pillar-like protrusions from the back are also missile launchers.

If the Ripper has a weakness, it's that it is comparatively slow and has minimal use of the hands; one is a **tri-blade** buzz saw, the other, a two-fingered (and thumb) hand **designed** for clamping and cutting rather than performing delicate work.

The Ripper 'Borg can be equipped with a *Cyborg Jet Pack* for flight capabilities, plus roughly 30% have Cyberjet Nodes for jet assisted leaps, enhanced speed and limited hovering capabilities.

Ripper Cyborg Shocktrooper

Class: Superheavy, Full Conversion Cyborg

M.D.C. by Location:

- * **Tri-Blade** Buzz Saw (3 blades; right arm) — 25 each
- Buzz Saw Forearm Shield (1; right) — 120
- Chest Mini-Missile Launchers (2) — 60 each
- Back Mini-Missile Launch Tubes (2; large) — 60 each
- ** Cheek Lasers (2; head) — 15 each
- * Concealed Laser Rod (1; left leg) — 50
- * Concealed Palm Laser (1; left) — 10
- * **Hand** (1; large, left) — 45
- Arms** (2) — 150 each
- Legs** (2) — 200 each
- * **Feet** (2) — 100 each
- ** Head with Mechanical Demon Face Plate — 160
- *** Main Body — 360, plus 180 M.D.C. (medium) or 280 M.D.C. (heavy) from additional cyborg body armor.

Damage Notes:

* A single asterisk indicates a small **and/or** difficult target to hit. The attacker must make a "Called Shot" and even then he is -3 to strike.

** In this case, the attacker must make a "Called Shot" to hit the head, and even then is -4 to strike because it is protected by shoulder plates and the rear missile launchers. Destroying the head of a cyborg will kill the character! This is where the brain is housed and when it's gone, that character is dead. However, the rest of the body can be salvaged and reused.

*** Depleting the M.D.C. of the main body will effectively destroy the artificial body, but emergency systems will keep the brain and vital organs alive for 18 hours. Recovery of the damaged body will enable Cyber-Docs to place the character on a life support system that will keep him alive until a new bionic frame becomes available. Failure to find the brain within 18 hours means the character dies. Massive amounts of damage (100 or more M.D.C. below zero) completely destroys the 'Borg, with no hope of recovery.

Speed:

Running: 90 mph (144 km) maximum.

Leaping: Those without jet propulsion can leap 15 feet (4.6 m) high and 20 feet (6 m) across due to hydraulics built into the legs; increase by 50% with a running start. Jet **thruster** assisted leaps can hurl the Ripper 100 feet (30.5 m) high and 190 feet (58 m) across.

Flying: Not possible unless a *Cyborg Jet Pack* is used, or the 'Borg has the *Cyberjet Node* package. See Cybernetics section for details about the jet pack and Cyberjet Node.

Statistical Data:

Average Height: 11 feet (3.3 m)

Width: Five feet (1.5 m) at the shoulders.

Length: 4 feet (1.2 m)

Weight: 2.1 tons

Tactile sensitivity: 25%

Robotic P.S.: 44

Bionic P.P.: 24

Face: Machine-like demon face plate.

Horror Factor: 12

Bonuses: In addition to attribute and skill bonuses.

+2 on initiative

+1 to strike

+2 to parry

+1 to dodge (hydraulic legs)

+4 to pull punch

+2 to roll with punch, fall or impact

+6 to save vs Horror Factor

Power System: Nuclear; average life is 20 years.

Black Market Cost: N/A. The process is secret and never shared with outsiders, much less offered for sale!

Warlord Cost: 2.8 million credits; the equivalent elsewhere would cost 6-8 million.

Ripper Weapon Systems:

1. Mini-Missile Back Launch Tubes (2; rear): Two large tubes hooked to the Ripper's back are a pair of multi-shot mini-missile launchers. The top folds open to fire the missiles. It takes one minute to reload by hand.

Primary Purpose: Anti-Aircraft and Anti-Flying Monsters.

Missile Type: Any mini-missile can be used, but standard issue is armor piercing (1D4x10 M.D.) or plasma (1D6x10). Fragmentation may be used against ground troops.

Mega-Damage: Varies with missile type.

Range: About a mile (1.6 km).

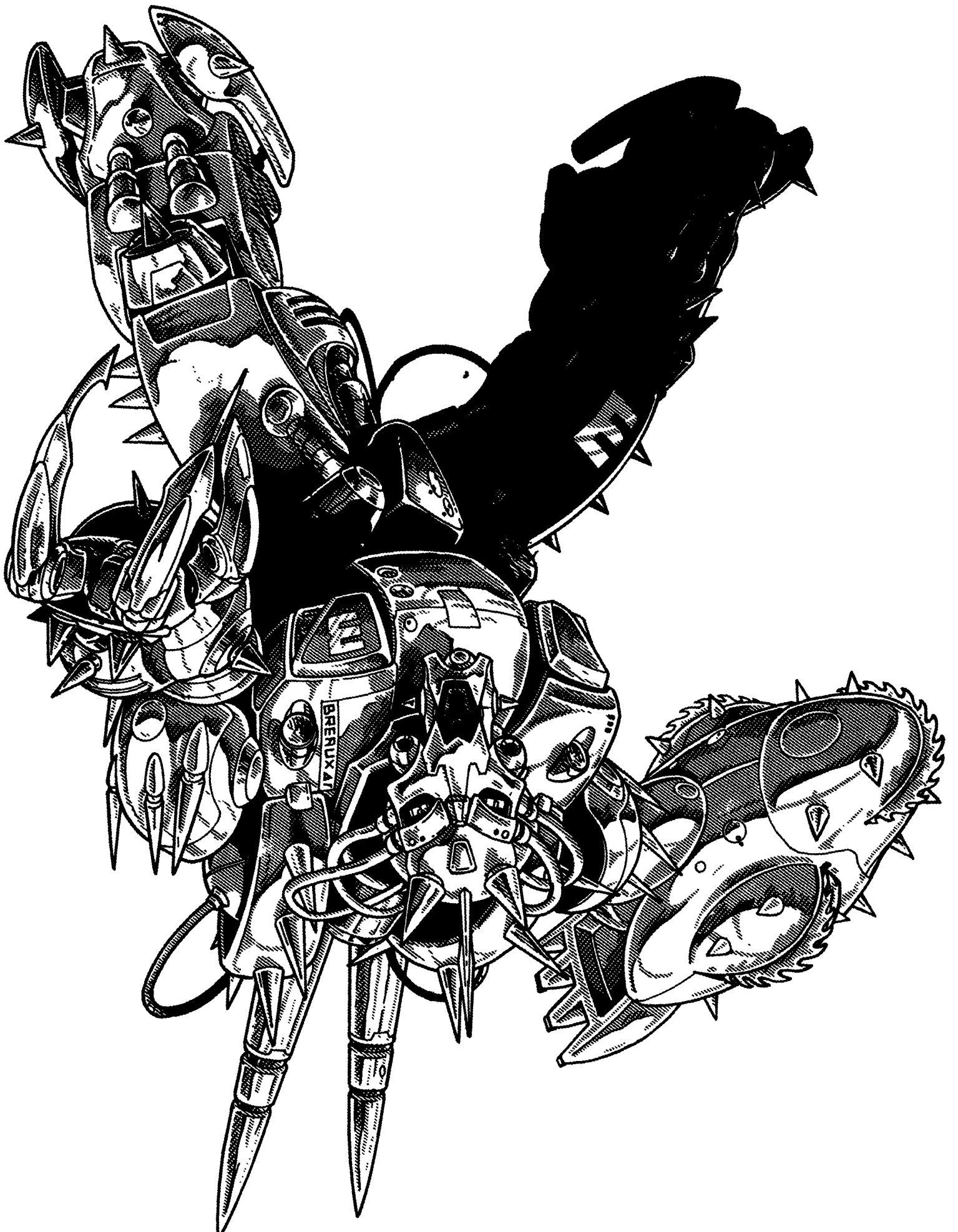

Rate of Fire: One at a time or volleys of two or four.

Payload: 18 total, nine per launcher.

2. Mini-Missile Chest Launch Tubes (2):

Primary Purpose: Anti-Aircraft and Anti-Flying Monsters.

Missile Type: Any mini-missile can be used, but standard issue is armor piercing (1D4x10 M.D.) or plasma (1D6x10). Fragmentation may be used against ground troops.

Mega-Damage: Varies with missile type.

Range: About a mile (1.6 km).

Rate of Fire: One at a time or volleys of two or four.

Payload: 12 total, six per launcher.

3. Tri-Blade Buzz Saw Forearm (1): Three buzz saw blades are built into a large, heavily plated forearm shield. The shield is used to block hand to hand attacks, as well as to shield the body from missile attacks (better to blow the arm off than take a hit to the head or body). One buzz saw blade is built into the front of the "V" shaped shield, and another one in each side. The blades are used to cut through armored troops, cyborgs, bots, vehicles, cables and fortifications.

Mega-Damage: 4D6 M.D. from one blade, 1D4x10 from getting sliced by two (the front and a side saw blade).

Range: Hand to Hand combat; the reach of the arm, which is about 6 feet (1.8 m).

Payload: Effectively unlimited; draws on the cyborg's power.

Bonus: +1 to parry and +3 to disarm when using this weapon.

4. Cheek Lasers: A pair of inconspicuous, light lasers are built into the cheek area. Each can rotate 90 degrees in all directions and they can be fired one at a time or simultaneously.

Primary Purpose: Anti-Personnel and Defense.

Mega-Damage: 2D6 M.D. per single blast, or 4D6 M.D. per simultaneous dual blast directed at the same target.

Rate of Fire: Each blast counts as one melee attack.

Range: 1,600 ft (488 m).

Payload: Effectively unlimited.

5. Chemical Spray: The mouth can open to release a chemical spray. See the **Rifts® RPG**, page 240, for details; may also spray holy water.

Primary Purpose: Anti-Personnel and Defense.

Damage: Varies with the type of chemical.

Rate of Fire: Each blast counts as one melee attack.

Range: 20 ft (6 m).

Payload: 20

6. Concealed Laser Rod (1): Located in the left leg is a concealed Laser Rod.

Primary Purpose: Anti-Personnel and Defense.

Mega-Damage: 3D6 M.D. per blast.

Rate of Fire: Each blast counts as one melee attack.

Range: 2,000 ft (610 m).

Payload: Effectively unlimited.

7. W-42 Concealed Palm Laser: A somewhat larger, heavier version of the short-ranged W-42 laser. It is built into the base of the palm and wrist of the left hand and offers better range. The device can be used as both a weapon and a cutting tool.

Primary Purpose: Tactical Weapon and Tool/Self-Defense.

Mega-Damage: Has four settings: 2D4x10 S.D.C., 1D4 M.D., 1D6 M.D., or 2D6 M.D. per single blast.

Range: 400 feet (122 m)

Rate of Fire: Each blast counts as one melee attack.

Payload: Effectively unlimited.

8. Vibro-Blade Fingers (2): A pair of curved, silver plated blades extend from the two large fingers. They are used for slashing and cutting.

Mega-Damage: 2D6 M.D.

Range: Hand to Hand combat; about six feet (1.8m).

9. Robot P.S. and Punch Damage:

Head Butt — 2D6 M.D.

Raking Vibro-Claws (left hand) — 3D6 M.D.

Vibro-Claw Clamping/Cut (left hand) — 4D6 M.D.

Restrained Punch — 1D4 M.D.

Full Strength Punch or Kick — 3D6 M.D.

Power Punch or Leap Kick — 1D6x10 M.D.; but counts as two attacks.

Also see buzz saw damage above.

10. Hand-Held Weapons: Additional hand-held weapons, from energy rifles and rail guns to clubs and magic weapons, may be used by the cyborg.

11. Additional Bionic Systems Common to the Ripper:

- Interchangeable right weapon arm.
- Its feet and legs use powerful servos and hydraulics which give it great stability, speed and leaping distance. All bonuses and extra speed are included in the stats above.
- 30% have Cyberjet Nodes for jet assisted leaps, enhanced speed and limited hovering capabilities.
- Cyborg Jet Pack is issued as needed.
- Hydraulic Ram Arm or other weapon arm sometimes replaces the buzz saw arm.

Warlord Kolodenko's Cyborg White Tiger

The White Tiger is a Cyborg **Shocktrooper** designed with speed, stealth and infantry combat in mind. The armor is either white or dull grey with black, tiger-stripes as design accents. It is roughly **humanoid** shaped but big and husky, with broad, armored shoulders, a barrel chest, thin waist and short, powerful, thick legs. It can run on two legs, but increases its speed by running on all fours in a loping manner. The hands and toes are clawed, like its namesake, and a number of inconspicuous and concealed weapons add to the **firepower** of the weapons it may carry into combat (typically rail guns and other heavy weapons).

The face plate and helmet have vaguely feline features with almond shaped **eyes**, and styling that resembles a muzzle and ear. Like **Burgasov's** 'Borgs, the White Tiger has hands with two thick fingers and a thumb, each ending in a hooked claw, but the White Tiger does not sacrifice manual dexterity with this design and can use weapons and machines.

The right forearm has a low profile, triple-barreled laser that, at a quick glance, looks like additional armor plating. The left arm has three retractable tentacles with bladed tips and electrical energy that fries whatever they grab/entangle. Or they can be used as an electrified, slashing whip. The chest plates open to reveal mini-missile launchers.

The White Tiger is one of the few Cyborg **Shocktroopers** that functions well as both a heavy assault unit and stealth operative.

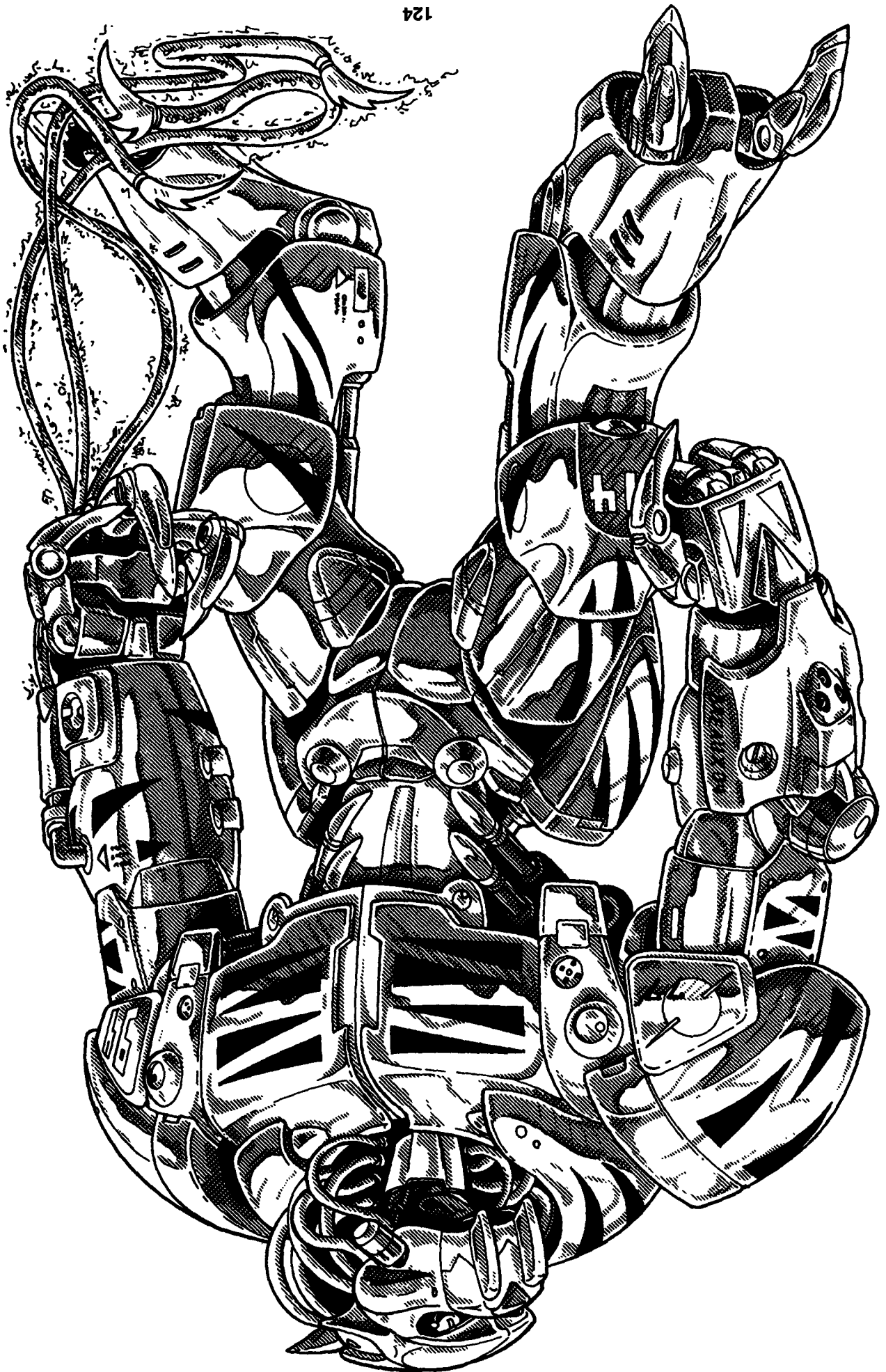

They serve well as intelligence operatives, in reconnaissance squads, as **trackers/hunters** and in surgical strikes or commando style raids.

White Tiger Cyborg Shocktrooper

Class: Superheavy, Full Conversion Cyborg

M.D.C. by Location:

* Electro-Tentacles (3) — 25 each.

Chest Mini-Missile Launchers (2) — 60 each

* Concealed Hip Laser Rod (1; left leg) — 40

* Concealed Hip Plasma Ejector (1; right) — 40

* Clawed Hands (2) — 45 each

Arms (2) — 130 each

Legs (2) — 200 each

* Clawed Feet (2) — 90 each

** Head with Mechanical Tiger Face Plate — 160

*** Main Body — 300, plus 180 M.D.C. (medium) or 280 M.D.C. (heavy) from additional cyborg body armor.

Damage Notes:

* A single asterisk indicates a small **and/or** difficult target to hit. The attacker must make a "Called Shot" and even then he is -3 to strike.

** In this case the attacker must make a "Called Shot" to hit the head, and even then is -4 to strike because it is low profile. Destroying the head of a cyborg will kill the character! This is where the brain is housed and when it's gone, that character is dead. However, the rest of the body can be salvaged and reused.

*** Depleting the M.D.C. of the main body will effectively destroy the artificial body, but emergency systems will keep the brain and vital organs alive for 18 hours. Recovery of the damaged body will enable Cyber-Docs to place the character on a life support system that will keep him alive until a new bionic frame becomes available. Failure to find the brain within 18 hours means the character dies. Massive amounts of damage (100 or more M.D.C. below zero) completely destroys the 'Borg, with no hope of recovery.

Speed:

Running: 144 mph (230 km) maximum; augmented with hydraulics.

Leaping: Those without jet propulsion can leap 20 feet (6 m) high and 25 feet (7.6 m) across due to hydraulics built into the legs; increase by 50% with a running start. Jet **thruster** assisted leaps can hurl the White Tiger 100 feet (30.5 m) high and 200 feet (61 m) across.

Flying: Not possible unless a *Cyborg Jet Pack* is used, or the 'Borg has the *Cyberjet Node* package. See Cybernetics section for details about the jet pack and Cyberjet Node.

Statistical Data:

Average Height: 10 feet (3 m)

Width: Six feet (1.8 m) at the shoulders.

Length: 4 feet (1.2 m)

Weight: 2 tons

Tactile sensitivity: 30%

Robotic P.S.: 46

Bionic P.P.: 24

Face: Mechanical feline-looking face plate.

Horror/Awe Factor: 10

Bonuses: In addition to attribute and skill bonuses.

+1 attack per melee round from tentacles

+3 on initiative

+1 to strike

+1 to parry

+2 to dodge (hydraulic legs)

+4 to pull punch

+2 to roll with punch, fall or impact

+15% to climbing skill.

+5 to save vs Horror Factor

No prowl penalty

Power System: Nuclear; average life is 20 years.

Black Market Cost: N/A. The process is secret and never shared with outsiders, much less offered for sale!

Warlord Cost: 2.6 million credits; the equivalent elsewhere would cost 6-7 million.

White Tiger Weapon Systems:

1. Mini-Missile Chest Launch Tubes (2):

Primary Purpose: Anti-Aircraft and Anti-Flying Monsters.

Missile Type: Any mini-missile can be used, but standard issue is armor piercing (1D4x10 M.D.) or plasma (1D6x10). Fragmentation may be used against ground troops.

Mega-Damage: Varies with missile type.

Range: About a mile (1.6 km).

Rate of Fire: One at a time or volleys of two or four.

Payload: 12 total, six per launcher.

2. Chemical Spray: The mouth can open to release a chemical spray. See the **Rifts® RPG**, page 240, for details.

Primary Purpose: Anti-Personnel and Defense.

Damage: Varies with the type of chemical.

Rate of Fire: Each blast counts as one melee attack.

Range: 20 ft (6 m).

Payload: 20

3. Vibro-Blade Fingers: Each finger and thumb has a curved, silver plated blade. They are used for slashing, cutting and climbing.

Mega-Damage: 1D4 M.D. from a single finger, 3D4 M.D. from a slashing claw strike or 2D4 M.D. added to the 3D6 M.D. from a full strength punch with the fingers pointing out; a full strength stabbing attack.

Range: Hand to Hand combat; about six feet (1.8 m).

4. Tri-Laser Forearm Weapon: A small, low-profile triple-shot laser is built into the right forearm

Primary Purpose: **Anti-Armor** and Anti-Monster.

Mega-Damage: 2D6 M.D. per single blast, 4D6 M.D. per double blast, or 6D6 per triple blast.

Rate of Fire: Each blast counts as one melee attack.

Range: 2,000 ft (610 m).

Payload: Effectively unlimited.

5. Concealed Hip Plasma Ejector: Located in a compartment on the right hip is a plasma ejector.

Primary Purpose: Assault and Defense.

Mega-Damage: 4D6 M.D. per blast.

Rate of Fire: Each blast counts as one melee attack.

Range: 1,600 ft (488 m).

Payload: Effectively unlimited.

6. Concealed Hip Laser Rod (1): Located in a compartment on the left leg is a concealed Laser Rod.

Primary Purpose: Assault and Defense.

Mega-Damage: 3D6 M.D. per blast.

Rate of Fire: Each blast counts as one melee attack.

Range: 2,000 ft (610 m).

Payload: Effectively unlimited.

7. Electro-Tentacles (3): Three retractable tentacles can extend from the left forearm. One, two or all three can be used at any time. They are prehensile, so they can be used to entangle, hold and carry items or enemies, as well as to climb, or as a whip. Once per melee round, the White Tiger can send an electrical charge through the tentacles to inflict additional damage and possibly stun his victim.

Primary Purpose: Anti-Personnel and Defense.

Mega-Damage: Whip or **Punch/Jab** attack: 1D6 per tentacle, 3D6 M.D. from all three at once.

Electro-Blast: As little as **1D6x10** S.D.C. or 1D6 M.D. per each tentacle or 3D6 M.D. from all three. This electrical damage can be inflicted when used as a whip (add it to the strike damage) or when an opponent touches or is held by one or more tentacles. There is also a chance that the shock will stun an opponent for 1D4 melee rounds. The stunned individual has only two attacks/actions per round, no initiative, -8 on all combat maneuvers like strike, parry, etc., and skill performance and speed are reduced by 70%. The likelihood of a stun is as follows:

01-92% Human/humanoid/D-Bee without body armor.

01-65% Mortal M.D.C. being with no body armor or human in armor.

01-50% Light Machine or Partial 'Borg, or lesser demon.

01-30% Heavy Machine, Power Armored opponent, greater demon.

01-05% Cyborg Shocktrooper, robot, adult dragon or demon lord.

P.S. of Tentacles: 15

Rate of Fire: Once per melee round, and counts as one melee attack.

Range: 10 feet (3 m) beyond the reach of the arm and hand (about 16 feet/4.9 m total).

Payload: Effectively unlimited.

8. Robot P.S. And Punch Damage:

Head Butt — 2D6 M.D.

Restrained Punch — 1D4 M.D.

Full Strength Punch or Kick — 3D6 M.D.

Power Punch or Leap Kick — 1D6x10 M.D.; but counts as two attacks.

9. Hand-Held Weapons: Additional hand-held weapons, from energy rifles and rail guns to clubs and magic weapons, may be used.

10. Additional Bionic Systems Common to the White Tiger:

- Interchangeable right weapon arm.
- Audio-Filter & Enhancement.
- Its feet and legs use powerful servos and hydraulics which give it great stability, speed and leaping distance. All bonuses and extra speed are included in the stats above.
- Cyborg Jet Pack is issued as needed.
- 5% have **Cyberjet** Nodes for jet assisted leaps, enhanced speed and limited hovering capabilities.
- Optional Panorama Cluster Lens or **Wide-Angle** Lens; about 20% have one or the other.

Warlord Orloff's Cyborgs Holocaust

The Holocaust Cyborg **Shooktrooper** is a frightening visage that has been called a mechanized demon. Indeed, the head resembles that of a demonic knight, complete with curved horns and a skull-like face plate. The body is a mass of weapons mounted on tank treads rather than human-like legs.

It is the creation of Warlord Orloff, the **cruelest**, most brutal and savage of the seven Warlords of Russia. The *Holocaust* and *Aftermath* are both products of alien technology stolen by Orloff. Actually, the technology is a combination of Earth and alien science. These monstrous cyborgs are not significantly more advanced than most cyborgs throughout Europe and Asia. However, the alien technology gives them access to high-tech energy weapons that the others do not possess. They also enjoy a slight edge from miniaturization and weapon technology that gives these cyborgs an incredible arsenal of devastating weapons.

Unfortunately, like their master, the Holocaust and Aftermath Cyborgs tend to be a savage, bloodthirsty lot who engage in torture, brutality, intimidation and wholesale slaughter. They are among the least tolerant and most violent warriors in Russia, and tend to follow the practice of "if not a member of the Camp, and in hostile territory, shoot first and who cares about questions, as long as we win and get what the Warlord wants." This cold-blooded, murderous attitude is exacerbated by the fact that many of the souls inside these war machines have become detached from their human roots and have little regard for life. They love combat because it makes them feel important and powerful to dominate and kill others. All of Orloff's cyborgs, not just the Cyborg Shocktroopers, but especially them, believe themselves to be superior to all other War Camps, and desire to one day crush the other War Camps and unite all of Russia under the rule of Warlord Orloff.

Holocaust Cyborg Shocktrooper

Class: Heavy Combat, Full Conversion Cyborg

M.D.C. by Location:

Mini-Missile Launchers (2; front & rear) — 75 each

Shoulder Plasma Cannon (1; right) — 100

Shoulder Rail Gun (1; left) — 100

* Forearm Particle Beam Gun (1; left) — 35

* Forearm Pulse Laser (1; right) — 35

Large, Main Arms (2) — 150 each

Large, Main Hands (2) — 60 each

* Small, Secondary Arms (2) — 80 each

* Small, Secondary Hands (2) — 25 each

Treads (2) — 120 each

* Helmet Horns (2) — 15 each

** Head with Built-in Demon Knight Face Plate — 180

*** Main Body — 360, plus 180 M.D.C. (medium) or 280 M.D.C. (heavy) from additional cyborg body armor.

Damage Notes:

* A single asterisk indicates a small **and/or** difficult target to hit. The attacker must make a "Called Shot" and even then he is -3 to strike.

** Destroying the head of a cyborg will kill the character! This is where the brain is housed and when it's gone, that

François Pérez 1998

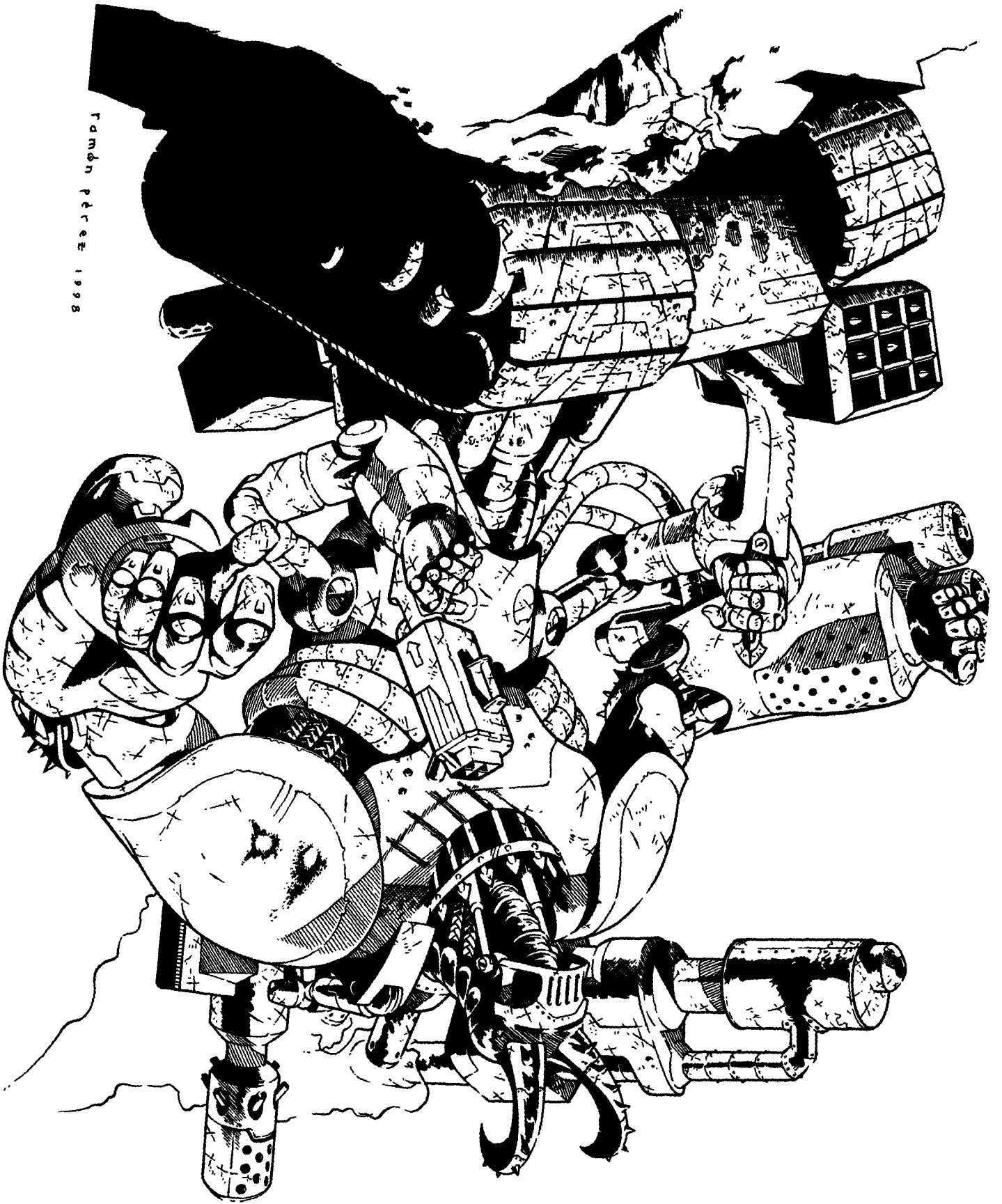

character is dead. However, the rest of the body can be salvaged and reused.

*** Depleting the M.D.C. of the main body will effectively destroy the **artificial** body, but emergency systems will keep the brain and vital organs alive for **18** hours. Recovery of the damaged body will enable Cyber-Docs to place the character on a life support system that will keep him alive until a new bionic frame becomes available. Failure to find the brain within 18 hours means the character dies. Massive amounts of damage (100 or more M.D.C. below zero) completely destroys the 'Borg, with no hope of recovery.

Speed:

Running/Rolling: 80 mph (128.7 km) maximum.

Leaping: Not applicable.

Statistical Data:

Average Height: 12 feet (3.6 m) to the tip of his horns.

Width: 6 feet (1.8 m) at the shoulders; 7 feet (2.1 m) overall including the width of the treads.

Length: 8 feet (2.4 m)

Weight: 3.6 tons

Tactile sensitivity: 35%

Robotic P.S.: 40

Bionic P.P.: 22

Face: Monstrous Demon Knight face plate.

Horror Factor: 14

Bonuses:

+2 melee attacks; one from the extra pair of arms and one from the way the weapon systems are integrated.

+1 on initiative

+1 to strike

+3 to parry

+1 to pull punch

+8 to save vs Horror Factor

Power System: Nuclear; average life is 20 years.

Black Market Cost: N/A. The process is secret and never shared with outsiders, much less offered for sale!

Warlord Cost: 4.2 million credits; the equivalent elsewhere would cost 8-9 million.

Holocaust Weapon Systems:

1. Mini-Missile Launchers (2): A pair of box launchers provides heavy **firepower**. One is located in the front, right side above the tread, and one in the back, in the middle of the track, behind the main cyborg at the base of his hip area.

Primary Purpose: Anti-Aircraft and Anti-Flying Monsters.

Missile Type: Any mini-missile can be used, but standard issue is armor piercing (1D4x10 M.D.) or plasma (1D6x10). Fragmentation may be used against ground troops.

Mega-Damage: Varies with missile type.

Range: About a mile (1.6 km).

Rate of Fire: One at a time or volleys of two or four.

Payload: 54 total; 27 per launcher.

2. Shoulder Plasma Cannon: Behind the right shoulder is a heavy plasma cannon. To fire it, the weapon moves from its locked back, storage position to the desired angle pointing forward. It can be positioned in a 45 degree arc of fire, up and down, to directly parallel with the cyborg's eyes (as shown in the illustration). It can also turn 45 degrees left and right.

Primary Purpose: Anti-Cyborg and Anti-Monster.

Mega-Damage: 6D6 M.D per blast.

Rate of Fire: Each blast counts as one melee attack.

Range: 2000 feet (610 m).

Payload: Effectively unlimited.

3. Forearm Pulse Laser: Mounted on the right forearm is a high-powered pulse laser. Point and shoot.

Primary Purpose: Long-range attacks and Defense.

Mega-Damage: 1D6 M.D per single blast, 2D6 M.D. per double pulse or 4D6 M.D. per quadruple pulse blast.

Rate of Fire: Each blast counts as one melee attack.

Range: 3000 feet (914 m).

Payload: Effectively unlimited.

4. Shoulder Rail Gun: Behind the left shoulder is a heavy rail gun (can be loaded with silver-plated rounds). To fire it, the weapon moves from its locked back, storage position (as shown in the illustration) to the desired forward position. It can be positioned in a 45 degree arc of fire to directly parallel with the cyborg's eyes. It can also turn 45 degrees left and right.

Primary Purpose: Long-Range Attacks and Anti-Armor & Anti-Monster.

Mega-Damage: 1D6 M.D per single blast, 1D6x10M.D. per 20 round burst.

Rate of Fire: Each burst counts as one melee attack.

Range: 6,000 feet (1828 m).

Payload: 200 bursts; a 4000 round drum is mounted in the rear behind the cyborg.

5. Forearm Particle Beam Gun: The two halves of this weapon open up to reveal a short-range **P-Beam** gun. Point and fire.

Primary Purpose: Close Combat and Defense.

Mega-Damage: 1D4x10 M.D per blast.

Rate of Fire: Each blast counts as one melee attack.

Range: 1000 feet (305 m).

Payload: Effectively unlimited.

6. Extra pair of Arms: A pair of small arms are located underneath the main, large ones. They are used primarily to operate other hand-held weapons and in close combat. The extra attack per melee round they provide is accounted for in the bonuses listed earlier.

7. Robot P.S. and Punch Damage:

Head Butt — 3D6 M.D.

Restrained Punch — 1D4 M.D.

Full Strength Punch — 3D6 M.D. (2D6 for the small arms).

Power Punch — 1D6x10 M.D. (4D6 M.D. for the small arms); but counts as two attacks.

Ram — 5D6 M.D., but counts as two attacks.

8. Hand-Held Weapons: Additional hand-held weapons, from energy rifles and rail guns to clubs and magic weapons, may be used by the cyborg. A **Vibro-Knife** or short sword, one energy pistol and one energy rifle are pretty standard.

Aftermath

The Aftermath is another one of Warlord Orloff's walking juggernauts. Like its brother Cyborg **Shocktrooper**, it is bristling with a diverse variety of weapons. It is sometimes called Orloff's Grim Reaper, because of its chain saw arm (something a modern, mechanical Grim Reaper might possess) and because it usually comes in *after* the Holocaust as part of a second wave or to help "mop up" and finish off the enemy after the initial assault. The initial assault typically includes Heavy Machines and Reaver Mechanized Cavalry led by the Holocaust. The Aftermath usually leads the second wave with Cossacks, and Soldati, Light Machines and Reavers following behind.

The Aftermath has a special cooling system necessary to keep the heavy particle beam cannon and other high-energy weapons from overheating and exploding. Consequently, the Aftermath is constantly engulfed in a cloud of smoke and steam, which only adds to its dramatic appearance. Its main weapon is a particle beam cannon that can inflict tremendous damage at a range comparable to most laser rifles. It has a heavy rail gun mounted on the left forearm, along with a retractable **Vibro-Blade** and a robotic hand. Meanwhile, a multi-weapon system takes up the entire right arm. In place of a hand is a wicked chain saw, and under it, a Vibro-Blade.

The head is protected by a face plate that resembles a knight of old, and by a head collar that rises up over the top and back. Behind it is the weapon's cooling system which offers additional head protection and makes it impossible to shoot the head from behind. The Aftermath is also surprisingly strong and fast.

Aftermath Cyborg Shocktrooper

Class: Heavy Combat Full Conversion Cyborg

M.D.C. by Location:

Chain Saw (1; right) — 60

Chain Saw Weapon Forearm (1; right) — 135

* Vibro-Blade & Retractable Arm (1; right) — 50

Shoulder Particle Beam Cannon (1; right) — 100

* Retractable Vibro-Blade (1; left) — 50

* Forearm Rail Gun (1; left) — 40

Upper Arms (2) — 110 each

Hand (1; left) — 50

Forearm (left) — 90

Legs (2) — 130 each

Feet (2) — 40 each

Cooling Unit (1; hunchback) — 170

** Head with Built-in Knight Face Plate — 160

*** Main Body — 350, plus 180 M.D.C. (medium) or 280 M.D.C. (heavy) from additional cyborg body armor.

Damage Notes:

* A single asterisk indicates a small **and/or** difficult target to hit. The attacker must make a "Called Shot" and even then he is -3 to strike.

** Attackers are -5 to strike the head, which can tuck itself into its collar and against the main cooling unit, like a turtle. Destroying the head of a cyborg will kill the character! This is where the brain is housed and when it's gone, that character is dead. However, the rest of the body can be salvaged and reused.

*** Depleting the M.D.C. of the main body will effectively destroy the artificial body, but emergency systems will keep the brain and vital organs alive for 18 hours. Recovery of the damaged body will enable Cyber-Docs to place the character on a life support system that will keep him alive until a new bionic frame becomes available. Failure to find the brain within 18 hours means the character dies. Massive amounts of damage (100 or more M.D.C. below zero) completely destroys the 'Borg, with no hope of recovery.

Speed:

Running: 100mph (160.9km) maximum.

Leaping: Those without jet propulsion can leap 20 feet (6 m) high and 25 feet (7.6 m) across due to hydraulics built into the legs; increase by 50% with a running start. Jet **thruster** assisted leaps can hurl the Aftermath 100 feet (30.5 m) high and 200 feet (61 m) across.

Flying: Not possible unless a *Cyborg Jet Pack* is used, or the 'Borg has the *Cyberjet Node* package. See the Cybernetics section for details about the jet pack and Cyberjet Node.

Statistical Data:

Average Height: 14 feet (4.3 m) to the top of the cooling unit.

About 12 feet (3.6 m) at the shoulders.

Width: 5 feet (1.2 m) at the shoulders.

Length: 4 feet, 6 inches (1.4 m).

Weight: 4 tons

Tactile sensitivity: 35%

Robotic P.S.: 40

Bionic P.P.: 22

Face: Monstrous Demon Knight face plate.

Horror Factor: 13

Bonuses:

+2 on initiative

+2 to strike

+3 to parry

+2 to dodge

+2 to pull punch

+7 to save vs Horror Factor

Power System: Nuclear; average life is 20 years.

Black Market Cost: N/A. The process is secret and never shared with outsiders, much less offered for sale!

Warlord Cost: 4.8 million credits; the equivalent elsewhere would cost 8-10 million.

Aftermath Weapon Systems:

1. Chain Saw Multi-Weapon Arm (1): The most obvious weapon on this arm is a chain saw used to cleave through body armor, bionic limbs and vehicles. It is so menacing that most people don't notice the arm's other features until it is too late.

Underneath the housing for the saw is a curved Vibro-Blade, but even this simple weapon is more than it seems. The "blade" is basically the hand of a small retractable arm that slides out to swing and stab at fools who get too close. It can also fire a handful of mini-missiles from the two openings at the base of the saw.

Primary Purpose: Assault

Mega-Damage: Chain Saw: 5D6 M.D.

Vibro-Blade Arm: 2D4 M.D.

Mini-Missiles: Damage varies by type.

Range: Chain Saw and Vibro-Blade: 12 foot (3.6 m) reach.

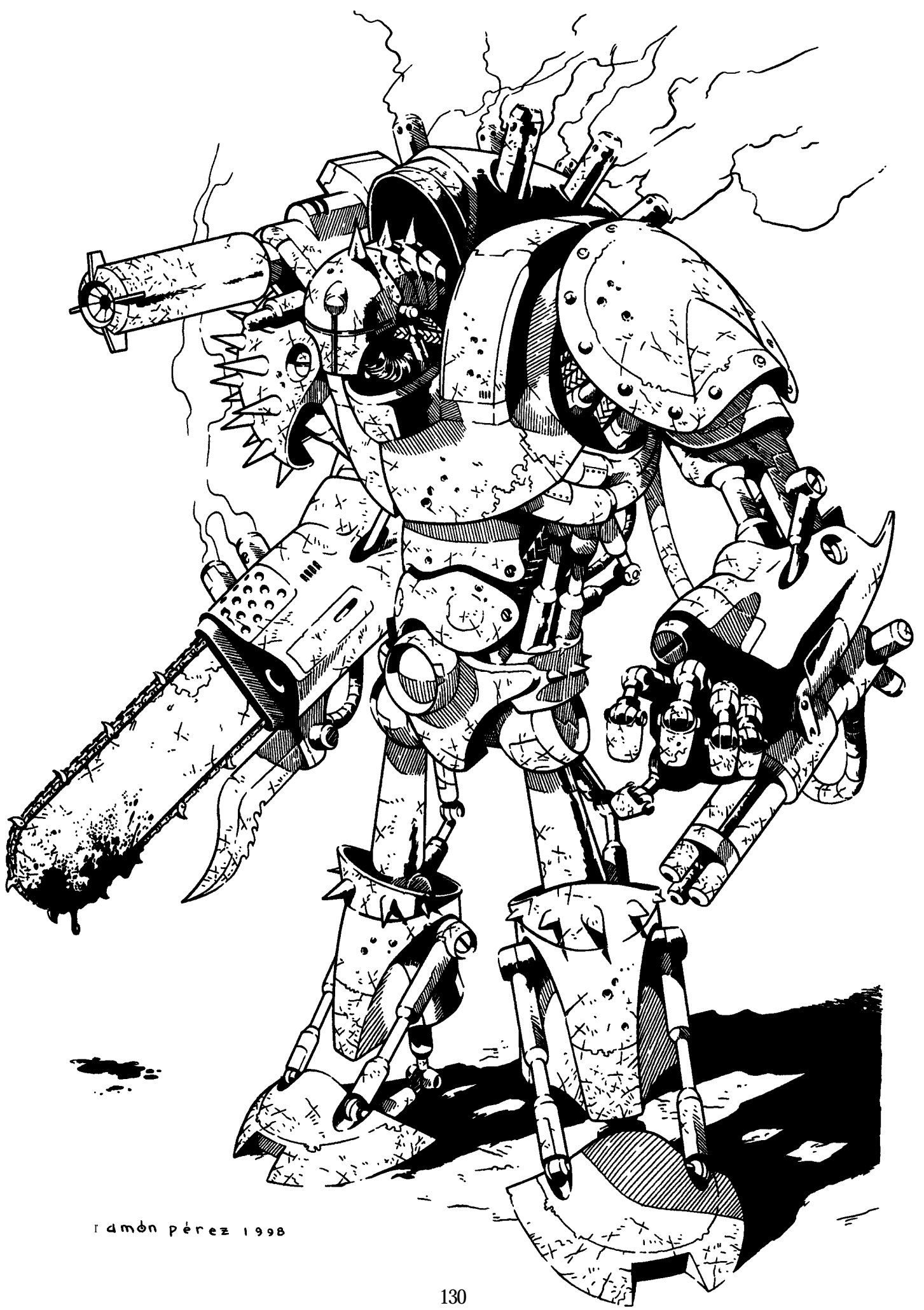

Ramón Pérez 1998

Mini-Missile: A mile (1.6 km).

Rate of Fire: Saw or Blade: Hand to hand combat.

Mini-Missiles: One at a time or volleys of two.

Payload: Mini-Missiles: Six total; three per each side of the arm launcher.

- 2. Shoulder Particle Beam Cannon:** Behind the right shoulder is a heavy Particle Beam cannon. To fire it, the weapon moves from its locked storage position on the back, to a forward position. It can be positioned in a 45 degree arc of fire, up and down, to directly parallel with the cyborg's eyes (as shown in the illustration). It can also turn 45 degrees left and right.

Primary Purpose: Anti-Cyborg and Anti-Monster.

Mega-Damage: 1D6x10 M.D per blast.

Rate of Fire: Each blast counts as one melee attack.

Range: 2000 feet (610 m).

Payload: Effectively unlimited.

- 3. Forearm Rail Gun:** On the underside of the left forearm is a light rail gun (can be loaded with silver-plated rounds). To fire it, the Aftermath points and shoots.

Primary Purpose: Long-range attacks and Anti-Armor & Anti-Monster.

Mega-Damage: 1D4 M.D per single blast, 1D4x10 M.D. per 20 round burst.

Rate of Fire: Each burst counts as one melee attack.

Range: 4,000 feet (1220 m).

Payload: 100 bursts; a 2000 round drum is mounted on the back.

- 4. Concealed Vibro-Blade:** A large, silver plated **Vibro-Blade** is housed in the circular compartment above the left hand, and can be extended as needed.

Mega-Damage: 2D6 M.D.

Range: Hand to Hand combat; about 10 feet (3 m) when extended (3 feet/0.9 m longer than the arm).

- 5. Robot P.S. and Punch Damage:**

Head Butt — 2D6 M.D.

Restrained Punch — 1D4 M.D.

Full Strength Punch — 3D6 M.D. The chain saw can be used like a club when turned off.

Power Punch — 1D6x10 M.D.; but counts as two attacks.

Running Ram — 5D6 M.D., but counts as two attacks.

- 6. Hand-Held Weapons:** Additional hand-held weapons, from energy rifles and rail guns to clubs and magic weapons, may be used by the cyborg. One energy pistol or one energy rifle is pretty standard. Grenades and other explosives may also be used.

7. Additional & Special Bionic Systems for the Aftermath:

- Interchangeable, right weapon arm.
- Its feet and legs use powerful servos and hydraulics which give it great stability, speed and leaping distance. All bonuses and extra speed are included in the stats above.
- Extendable head on a flexible, telescoping neck. The Aftermath has an accordion-style neck that allows the head to extend approximately five feet (1.5 m) and to look around the cooling pod and over its shoulders to look completely behind itself. The neck has 100 M.D.C. and is +1 to dodge.
- 8% have **Cyberjet** Nodes for jet assisted leaps, enhanced speed and limited hovering capabilities.
- Optional: Cyborg Jet Pack is issued as needed.
- Optional: Wide-Angle Lens; about 20% have one.
- Optional: Cyber Shield.

Romanov's Cyborg Avenging Angel

The Avenging Angel is the twisted image of a mechanical angel. The body is clad in armor reminiscent of Medieval knights and has metal and ceramic wings with the stylized look of feathers. The wings are actually part of a detachable jet propulsion system, so should one of the wings get so badly damaged that it cannot be repaired the entire unit can be taken off and the Avenging Angel can continue on foot, unencumbered by a "broken wing." This is a new design for the Romanov Camp, introduced only eleven years ago (the older model was bulkier and could only leap and glide rather than fly under its own power). The Avenger is a swift, mobile flying cyborg the equal of most power armor, and faster than the Tempest. It is particularly effective when fighting superstitious people who fear or revere angels.

The Avenging Angel has sacrificed **firepower** for speed, mobility and silence. On and off the ground, they are among the fastest cyborg units in Europe, capable of steep dives, precision maneuvers and incredible aerial acrobatics. They are also capable of swooping down in a silent "glide" to catch their opponents unawares. This and similar tactics in which they use the sun, clouds and other tricks to hide their presence or true numbers has earned them the nickname, "Angels of Death," for once they are upon you, there is no escape.

To accentuate the nobility and grandeur of the mechanical angels, the armor is the color of gold with rich purple, red or silver trim and either matching golden or white wings. Most scouts are sky blue with white wings and trim (to better blend into the sky), while troop leaders are red with gold and black highlights. The helmet has a bird's head shape, while the face plate is typically that of an **angelic**, golden, human face.

The feet are clawed, and the two-fingered hands resemble the clawed talons of an eagle. Both are used to claw and rake opponents as the Angel cuts through the heavens, and literally carves a swath through enemy troops. Its weapon of choice is a hand-held, giant-sized, golden, **Vibro-Scythe polearm** specifically designed for the Avenging Angel. The blade end cuts and stabs, while the pole end can be used as a blunt weapon, or made to fire powerful ion blasts. However, this is not its only weapon. The fingers of the hands have small claws, each forearm has a concealed light laser, and four mini-missiles can be hooked to the shoulder end of each wing. Meanwhile, the clawed feet can be used to kick, slash and rake opponents while flying.

Avenging Angel Cyborg Shocktrooper

Class: Flying, Full Conversion Cyborg

M.D.C. by Location:

* Wing Mini-Missiles (8; self-launch) — 15 each

* Concealed Forearm Lasers (1 per arm) — 10 each

* Hands (2) — 30 each

Arms (2) — 90 each

Legs (2) — 120 each

Feet (2) — 65 each

Wings (2) — 175 each

* Main Rear Jets (3; small) — 40 each

Lower Maneuvering Jets (3; even smaller) — 25 each

** Head with Golden Human Face Plate — 150

*** Main Body — 290, plus 150 M.D.C. (light) or 180 M.D.C. (medium) from additional cyborg body armor.

Damage Notes:

* A single asterisk indicates a small **and/or** difficult target to hit. The attacker must make a "Called Shot" and even then he is -3 to strike.

** The head is also -3 to strike. Destroying the head of a cyborg will kill the character. This is where the brain is housed and when it's gone, that character is dead. However, the rest of the body can be salvaged and reused.

*** Depleting the M.D.C. of the main body will effectively destroy the artificial body, but emergency systems will keep the brain and vital organs alive for 18 hours. Recovery of the damaged body will enable Cyber-Docs to place the character on a life support system that will keep him alive until a new bionic frame becomes available. Failure to find the brain within 18 hours means the character dies. Massive amounts of damage (100 or more M.D.C. below zero) completely destroys the 'Borg, with no hope of recovery.

Speed:

Running: With wings, 70 mph (112.6 km) maximum. Without wings, 130 mph (208 km).

Leaping: Without jet assistance, the Avenging Angel can leap 15 feet (4.6 m) high and 20 feet (6 m) across; increase by 60% with a running start. Jet **thruster** assisted leaps can hurl the Angel 100 feet (30.5 m) high and 200 feet (61 m) across.

Flying: Silent Glide: 10-20 mph (16 to 32 km). Silent dive: 60-100 mph (96 to 160 km).

The jet propulsion system and wings enable the Avenging Angel to hover stationary at any height within its altitude range, **float/glide** on wind currents, and fly at a maximum speed of 340 mph (544 km). Cruising speed is considered to be 60-100 mph (96 to 160 km). Maximum altitude is 12,000 feet (3,657 m); a little more than two miles (3.2 km).

Flying Range: The jets need to cool after about 8 hours of constant use, but switching from powered flight to gliding can keep the Avenging Angel in the air for days. Draws on the nuclear power supply of the 'Borg for unlimited power.

Statistical Data:

Average Height: 10 feet (3 m) to the top of the head. The wings fold but add about two feet (0.6 m), for an overall height of 12 feet (3.6 m)

Width: Three feet, 6 inches (1.1 m) at the shoulders; 16 feet (4.9 m) with wings fully extended. Eight feet (2.4 m) with wings folded in half.

Length: 4 feet (1.2 m)

Weight: 1.2 tons

Tactile sensitivity: 45%

Robotic P.S.: 38

Bionic P.P.: 24

Face: Angelic face plate.

Horror/Awe Factor: 12; +2 if religious or fearful of angels.

Bonuses:

+1 melee attack with pole-arm as the only weapon used in that melee round other than claws.

+4 on initiative

+2 to strike

+2 to parry

+4 to dodge while airborne

+3 to pull punch

+2 to roll with punch, fall or impact

+4 to save vs Horror Factor

Bonus Skill: Prowl (+15%)

Bonus Skill: Acrobatics (+5%)

Power System: Nuclear; average life is 20 years.

Black Market Cost: N/A. The process is secret and never shared with outsiders, much less offered for **sale!**

Warlord Cost: 3.4 million credits; the equivalent elsewhere would cost 6-8 million.

Avenging Angel Weapon Systems:

1. Vibro-Scythe Polearm (1): The Avenging Angel Cyborg **Shocktroopers** are specially trained in the use of this **long**, elegant, M.D. weapon. This training, combined with their robot strength allows the 'Borg to use it one- or two-handed (for all others, it is a two-handed weapon; Hero-Knights and Huntsmen would love to get their hands on this weapon, even though it is a bit large for ordinary humans). As noted earlier, the blade is a silver plated **Vibro-Weapon** and the other end of the polearm fires powerful, although comparatively short-range, energy bolts.

Primary Purpose: Assault and Defense.

Mega-Damage: Vibro-Scythe: 4D6 M.D. Ion Blaster: Can be adjusted to fire 2D6 or 4D6 M.D. blasts.

Rate of Fire: Each blast counts as one melee attack.

Range: Ion Blaster: 1,200 ft (366 m). Vibro-Blade: Melee combat; the reach of the pole-arm, roughly 13 feet (4 m). Or 600 feet (183 m) when thrown like a spear by the cyborg.

Payload: 30 blasts before needing recharging. Recharging is done via a special connector cable that hooks to the cyborg's power supply. It takes three minutes to recharge completely. Or it can be powered by a standard **E-Clip (15 shots)**.

2. Wing Mini-Missiles (8): A total of eight self-launching mini-missiles can be hooked to the wings.

Primary Purpose: **Anti-Aircraft** and Flying Monsters.

Missile Type: Any mini-missile can be used, but standard issue is armor piercing (1D4x10 M.D.) or plasma (1D6x10). Fragmentation may be used against ground troops.

Mega-Damage: Varies with missile type.

Range: About a mile (1.6 km).

Rate of Fire: One at a time or volleys of two or four.

Payload: 8 total, four per wing.

3. Concealed Forearm Lasers (2): Each arm has a concealed, light laser. Point and shoot.

Primary Purpose: Anti-Personnel and Defense.

Mega-Damage: 1D6 M.D. per single blast, 2D6 per simultaneous, dual blast at the same target (counts as one melee attack).

Rate of Fire: Each blast counts as one melee attack.

Range: 1,600 feet (488 m).

Payload: Effectively unlimited.

4. Clawed Hands (2): Each finger on each hand has a silver plated Vibro-Blade.

Mega-Damage: 3D4 M.D. per claw strike.

Range: Hand to Hand combat; the reach of the arm, which is about five feet (1.5 m).

5. Vibro-Blade Feet: The two front toes and rear talon are tipped with six inch (0.15 m) long, silver plated, **Vibro-Blades** that do additional damage when kicks are performed and can be used to rake, cut and stab enemies as the winged Cyborg Shocktrooper streaks down from the sky.



Mega-Damage: +2D6 M.D. to kick damage (in addition to P.S. damage), or 2D6 M.D. from raking or clawing attacks and 1D6 M.D. from a glancing blow/cut (one of the toe-blades hits).

Range: Hand to Hand combat; the reach of the leg, which is about 6 feet (1.8 m).

6. Robot P.S. and Punch Damage:

Claw Strike — 3D4 M.D.

Head Butt — 2D4 M.D.

Restrained Punch — 1D4 M.D.

Full Strength Punch — 2D6 M.D.

Power Punch — 4D6 M.D.

Kick — 2D6 M.D. +2D6 M.D. from the **Vibro-Blade** damage.

Flying Leap Kick or Power Dive (feet first) — Does 1D6x10 damage, plus has a 01-75% likelihood of knocking the opponent off his feet **and/or** stunning him for one melee round (15 seconds). The stunned individual has only two attacks/actions per round, no initiative, -8 on all combat maneuvers like strike, parry, etc., and skill performance and speed are reduced by 70%. The stun aspect of this attack is not effective against giant robots, cyborgs weighing more than two tons, vehicles, adult dragons, demon lords or similarly giant or superhuman creatures.

7. **Cyber Shield:** Optional, but used by about one third.

8. **Hand-Held Weapons:** Additional hand-held weapons, from energy rifles and rail guns to clubs and magic weapons, may be used by the flying cyborg. Many carry a dozen or more hand grenades in a satchel, which they drop or throw like mini-bombs.

9. Additional Bionic Systems Common to the Avenging Angel:

- Audio-Filter & Enhancement.
- Super-Telescopic Eye (5000 foot/1524 m range).
- Its feet and legs use powerful servos and hydraulics which give it great stability, speed and leaping power. All bonuses and extra speed are included in the stats above.
- Optional: Wide-Angle Lens; about 20% have one.
- Optional: One additional forearm weapon of choice on one or both arms.

Seriyev's Cyborgs Assassin

Seriyev is a master of subterfuge, strategy, espionage, and some would say, treachery. He was the first to develop the *Assassin Cyborg Shocktrooper*, although he tends to use it more as a superspy and cyborg commando than as an assassin, or so he claims. It is the only Shocktrooper design that is frequently copied and used by the other Warlords. However, these other designs replace the head with each Warlord's trademark Cyborg Shocktrooper's head and face plate (demon, dragon, angel, etc.) to denote their War Camp, don't have the Psionic Electro-Magnetic Dampers (Seriyev has a secret connection from the NGR to get that rare commodity) and sacrifice one or two of the audio or optic features in favor of another forearm weapon or even a Mekanikal Weapon Arm.

Seriyev's Assassin Cyborg Shocktrooper is designed for stealth, intelligence gathering and killing. To the issue of stealth,

the 'Borg is only 10 feet (3 m) tall, wears light armor and moves like a cat. For intelligence gathering, it has a number of audio, optic, and sensor systems. For killing and combat, it has four arms, blades, light weapons, and lightning reflexes.

Assassin Cyborg Shocktrooper

Also Known As the Silent Spy and Silent Death.

Class: Heavy Full Conversion Cyborg

M.D.C. by Location:

* Concealed Forearm Laser (1 per arm) — 10each

* Hands (4) — 25 each

Arms (4) — 95 each

Legs (2) — 120 each

Feet (2) — 45 each

** Head with human face and Tech or Demon Face Plate — 130

*** Main Body — 270, plus 150 M.D.C. (light) or 180 M.D.C. (medium) from additional cyborg body armor.

Damage Notes:

* A single asterisk indicates a small **and/or** difficult target to hit. The attacker must make a "Called Shot" and even then he is -3 to strike.

** The head is also -3 to strike. Destroying the head of a cyborg will kill the character. This is where the brain is housed and when it's gone, that character is dead. **However**, the rest of the body can be salvaged and reused.

*** Depleting the M.D.C. of the main body will effectively destroy the artificial body, but emergency systems will keep the brain and vital organs alive for 18 hours. Recovery of the damaged body will enable Cyber-Docs to place the character on a life support system that will keep him alive until a new bionic frame becomes available. Failure to find the brain within 18 hours means the character dies. Massive amounts of damage (100 or more M.D.C. below zero) completely destroys the 'Borg with no hope of recovery.

Speed:

Running: 110mph (176 km).

Leaping: Leap 12 feet (3.6 m) high and 18 feet (5.4 m) across, plus the distance gained from acrobatic or gymnastic skills. Increase 30% with a running start.

Flying: Not possible unless a *Cyborg Jet Pack* is used, or the 'Borg has the *Cyberjet Node* package. See the Cybernetics section for details about the jet pack and Cyberjet Node.

Statistical Data:

Average Height: 10 feet (3 m) to the top of the head.

Width: Three feet, 6 inches (1.1 m) at the shoulders.

Length: 4 feet (1.2 m).

Weight: 1200 pounds (540 kg).

Tactile sensitivity: 75% for two limbs, 45% for the other two.

Robotic P.S.: 38

Bionic P.P.: 24

Face: A tech or demonic face plate (not shown in the illustration).

Horror/Awe Factor: 12

Bonuses:

+2 melee attacks; takes into account the boxing skill and extra pair of arms.

+4 on initiative

+4 to pull punch

+3 to strike

+2 to roll with punch, fall or impact

+3 to parry

+4 to save vs Horror Factor

Bonus Skill: Boxing
Bonus Skill: Prowl (+15%)
Bonus Skill: Acrobatics (+5%)
Power System: Nuclear; average life is 20 years.



Black Market Cost: N/A. The process is secret and never shared with outsiders, much less offered for sale!

Warlord Cost: 3.2 million credits; the equivalent elsewhere would cost 6-8 million.

Assassin Weapon Systems:

- 1. One Arm out of Four:** Will have a pair of *retractable Vibro-Blades* (2D6 M.D.), *Wrist Needle and Drug Dispenser* (see **Rifts® RPG**, page 241), and a *fingerjack*.
- 2. One Arm out of Four:** Will have a *Mekanical Vibro-Blade Multi-Weapon Arm*, described in the Cybernetics section of this book.

Laser: 2D6 M.D.

Large underarm *Vibro-Blade/Sword*: 3D6 M.D.

Vibro-Claw Fingers: 4D4 M.D.

- 3. One Arm out of Four:** Will have a *forearm particle beam gun* (6D6+6 M.D.; 1000 ft/305 m range), *climb cord and grappling hook* (see **Rifts® RPG** page 240), *shooting, explosive knuckle spikes* (1D4 M.D., 50 ft/15.2 m range), and *finger camera* (see **Rifts® RPG**, page 239).

- 4. One Arm out of Four:** Will have a *Tool Hand*: A mechanical hand that contains a *fingerjack*, fingertip screwdrivers with changeable heads, finger pliers, tiny lights built into each finger tip, plus a laser cutter finger with 6 foot (182 cm) beam, and can be adjusted to do 1D6x10 S.D.C. damage, one

M.D., 1D4 M.D. or 1D6 M.D. There is also a small, retractable drill in the middle knuckle.

Plus a *Garrote Wrist Wire* (see **Rifts® RPG**, page 240), and an optional forearm weapon; about half have one, half don't. May be substituted with a small secret compartment.

5. Robot P.S. and Punch Damage:

Claw Strike — 4D4 M.D.

Head Butt — 1D6 M.D.

Restrained Punch — 1D4 M.D.

Full Strength Punch — 2D6 M.D.

Power Punch — 4D6 M.D., but counts as two melee attacks.

Kick — 2D6 M.D.

6. Hand-Held Weapons: Additional hand-held weapons, from energy rifles and rail guns to clubs and magic weapons, may be used by the cyborg.

7. Special: Psionic Electro-Magnetic Dampers: Brain implants that distort and fog telepathic and other psionic probes. Psychic opponents find it difficult to read the thoughts and emotions of characters with the psionic dampers. Bonuses: +1 to save vs all psionic attacks, +2 to save vs possession, and +1 to save vs magic illusions and mind control. Extremely rare in Russia and Asia.

8. Additional Bionic Systems Common to the Assassin:

- Audio-Filter & Enhancement.
- Panorama Cluster Lens
- Low-Frequency (earthquake) Audio Rig
- Audio-Filter & Enhancement
- Modulating Voice Synthesizer
- Molecular Analyzer
- Optional: One additional forearm weapon of choice on one or both arms.
- Optional: Cyber Shield

Mantis

Another unique, full conversion Cyborg **Shocktrooper** that looks like a humanoid version of a Praying Mantis. Being a **Seriye** creation, it is designed for stealth, scaling walls, and spying as much as it is for combat. The body is tall and slender. The legs and upper arms are long and thin. The waist thin, and shoulders wide. The head resembles that of the Mantis, complete with bulbous optic and sensor clusters for eyes (telescopic lens, cameras, etc.) and a mechanical, Mantis-like **mouth/jaw** capable of biting in combat. The chest and shoulder area is comparatively heavy and lean, forward, giving it a bit of a slouch or somewhat bent over appearance.

The most Mantis-like aspects are the weapon arms. The mechanical upper arms are thin and delicate looking, although strong. Likewise, the four articulated fingers and thumb are long and slender. The forearms are, like the Mantis, disproportionately heavy and wide. The outer side of the arm is lined with four small, jagged **Vibro-Blades** resembling the spines on the arms of the insect. They serve as razor-edged Vibro-weapons used for slashing, parrying, and climbing. Flipped back on the top of each of the forearms is a long, scythe-like **Vibro-Blade** that locks forward and extends from the wrist, over the hand, for use as a slashing and chopping blade. The extended blade also helps to give the cyborg the appearance of a Praying Mantis. Cyborg troops accustomed to this design are deadly in close combat. To complete the Mantis imagery, the cyborg is painted in shades of green or greenish-grey.

But there is more to this 'Borg. Under the wrists, on the oversized forearms, are six tiny slots or openings. Each is a light laser that can fire individually, in pairs or six at a time. This can be used with **devastating** effect, especially against large targets, like other cyborgs and demonic foes.

The feet have three prehensile, clawed **toes**, two in the front and one in the back. They are designed for climbing, but can also grab and carry. The powerful legs are also designed for leaping and 60% have the *Cyberjet Node* package for greatly enhanced abilities to leap.

Mantis Cyborg Shocktrooper

Class: Heavy Full Conversion Cyborg

M.D.C. by Location:

* Hands (2) — 25 each

* Long Vibro-Blades (2) — 60 each

Forearms (2) — 110 each

Upper Arms (2) — 95 each

Legs (2) — 200 each

Feet (2) — 55 each

** Head with Insect Face Plate — 130

*** Main Body — 280, plus 150 M.D.C. (light) or 180 M.D.C. (medium) from additional Mantis cyborg body armor.

Damage Notes:

* A single asterisk indicates a small **and/or** difficult target to hit. The attacker must make a "Called Shot" and even then he is -3 to strike.

** The head is also -3 to strike. Destroying the head of a cyborg will kill the character. This is where the brain is housed and when it's gone, that character is dead. However, the rest of the body can be salvaged and reused.

*** Depleting the M.D.C. of the main body will effectively destroy the artificial body, but emergency systems will keep the brain and vital organs alive for 18 hours. Recovery of the damaged body will enable Cyber-Docs to place the character on a life support system that will keep him alive until a new bionic frame becomes available. Failure to find the brain within 18 hours means the character dies. Massive amounts of damage (100 or more M.D.C. below zero) completely destroys the 'Borg, with no hope of recovery.

Speed:

Running: 120 mph (192 km).

Leaping: Leap 18 feet (5.4 m) high and 32 feet (9.7 m) across, plus the distance gained from the acrobatics skill. Increase 30% with a running start.

Jet Assisted Leaps with the **Cyberjet Node** Package: Small jet **thrusters** are mounted in the back and legs, with smaller directional jets here and there used for jet assisted leaps and limited hovering.

Travelling by jet boosted leaps doubles the cyborg's normal running speed. Jet assisted leaps can propel the Mantis 100 feet high (30.5 m) or 200 feet (61 m) lengthwise; increase by 30% with a running start. The jet propelled 'Borg can also hover in the air up to 100 feet (30.5 m) for 1D4+1 minutes before altitude is lost and the character is quickly, but gently, lowered to the ground.

Flying: Not possible, except limited hovering as noted above.

Statistical Data:

Average Height: 12 feet (3.6 m) to the top of the head.

Width: Three feet, 6 inches (1.1 m) at the shoulders.

Length: Three feet, 6 inches (1.1 m).

Weight: One ton

Tactile sensitivity: 45%

Robotic P.S.: 42

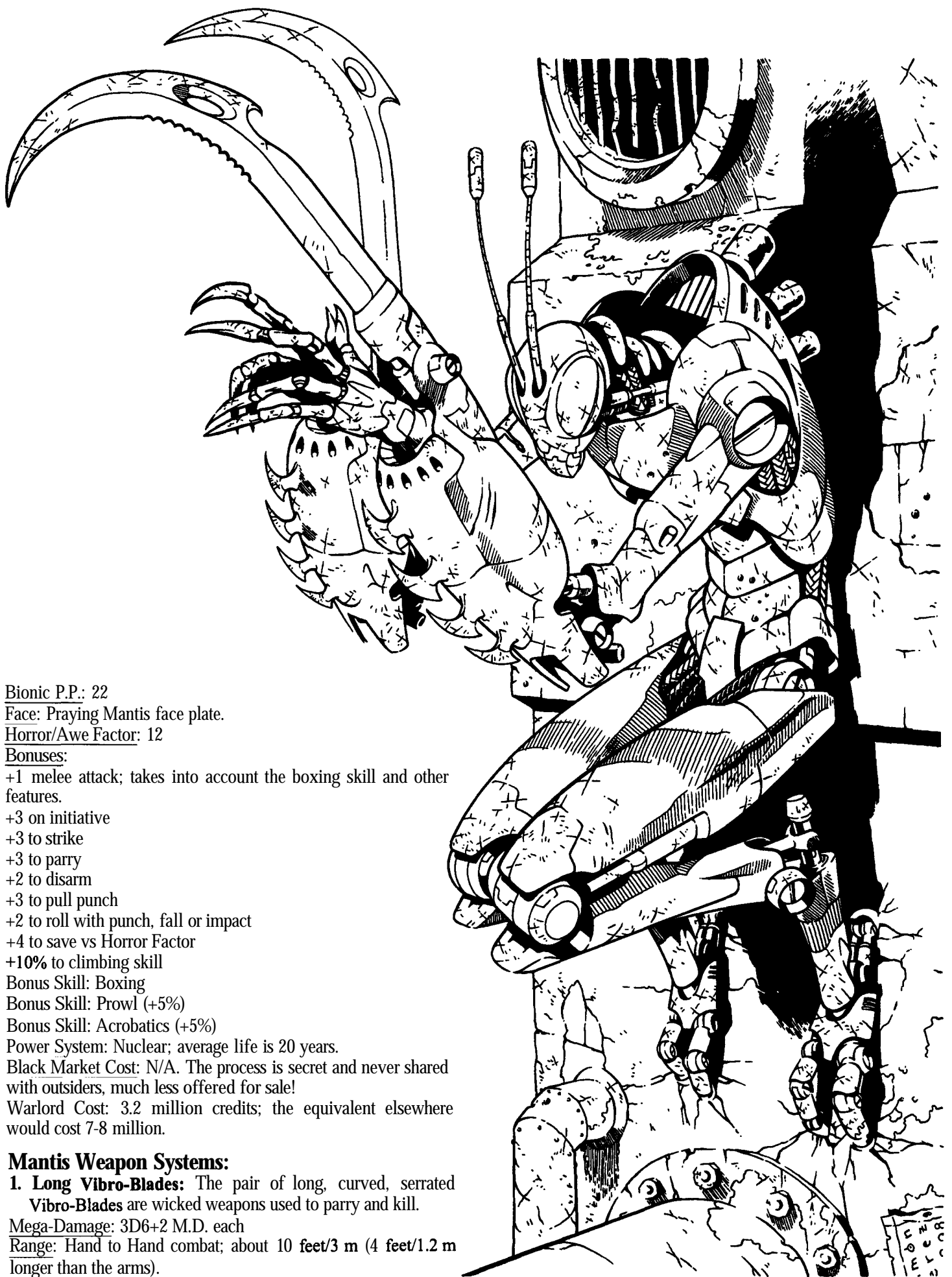

Bionic P.P.: 22

Face: Praying Mantis face plate.

Horror/Awe Factor: 12

Bonuses:

+1 melee attack; takes into account the boxing skill and other features.

+3 on initiative

+3 to strike

+3 to parry

+2 to disarm

+3 to pull punch

+2 to roll with punch, fall or impact

+4 to save vs Horror Factor

+10% to climbing skill

Bonus Skill: Boxing

Bonus Skill: Prowl (+5%)

Bonus Skill: Acrobatics (+5%)

Power System: Nuclear; average life is 20 years.

Black Market Cost: N/A. The process is secret and never shared with outsiders, much less offered for sale!

Warlord Cost: 3.2 million credits; the equivalent elsewhere would cost 7-8 million.

Mantis Weapon Systems:

1. Long Vibro-Blades: The pair of long, curved, serrated Vibro-Blades are wicked weapons used to parry and kill.

Mega-Damage: 3D6+2 M.D. each

Range: Hand to Hand combat; about 10 feet/3 m (4 feet/1.2 m longer than the arms).

2. Forearm Vibro-Blades: Used for climbing, parrying and slashing.

Mega-Damage: 4D4 M.D.

Range: Hand to Hand combat.

3. Forearm Light Laser Battery: Each of the bulbous forearms contains a battery of light lasers that can shoot individually, two at a time or six at a time.

Primary Purpose: Assault and Defense.

Mega-Damage: 1D6M.D per single blast, 2D6 per dual blast, or 6D6 from a full simultaneous laser volley at the same target (counts as one melee attack). Both arms cannot be fired at the same time.

Rate of Fire: Each blast, whether one, two or six simultaneous laser bolts, counts as one melee attack.

Range: 2,000 feet (610 m).

Payload: Effectively unlimited.

Plus, one arm has a *Garrote Wrist Wire* (see **Rifts® RPG**, page 240).

4. Robot P.S. and Punch Damage:

Head Butt — 1D6 M.D.

Bite — 1D4 M.D.

Restrained Punch — 1D4 M.D.

Full Strength Punch — 3D6 M.D.

Power Punch or Leap Kick — 1D6x10 M.D., but counts as two melee attacks.

Kick — 4D6 M.D.

5. Hand-Held Weapons: Additional hand-held weapons, from energy rifles and rail guns to clubs and magic weapons, may be used by the cyborg.

6. Special: Psionic Electro-Magnetic Dampers: About 15% of the Mantises have brain implants that distort and fog telepathic and other psionic probes. Psychic opponents find it difficult to read the thoughts and emotions of characters with the psionic dampers. Bonuses: +1 to save vs all psionic attacks, +2 to save vs possession, and +1 to save vs magic illusions and mind control. Extremely rare in Russia and Asia.

7. Additional Bionic Systems Common to the Mantis:

- Prehensile Feet
- Audio-Filter & Enhancement
- Wide Angle Vision
- Low-Frequency (earthquake) Audio Rig
- Modulating Voice Synthesizer
- Molecular Analyzer
- Optional: One additional Hand weapon of choice on one or both hands.

Sokolov's Cyborg Demonfist

Sokolov's Demonfist Cyborg **Shocktrooper** is one of the oldest, largest and strangest designs, but remains extremely formidable. The Demonfist has the body of a walking tank, complete with a pair of large shoulder cannons, a pair of forearm **guns**, and three long Vibro-Blades on the right hand. To give a monstrous, demonic appearance, the cyborg wears a protective face plate with the face of a demon, complete with long, curling

ram's horns. Strangest of all is the cyborg's body armor, made of thick plates covered in jagged spines to give it a monstrous appearance.

Compared to the **Shocktroopers** that have come after it, the Demonfist is slow and ponderous, but like a tank, it is heavily armored and powerful. The heavy armor, especially when the chest plate is worn (not shown in the illustration), enables the Demonfist to take a pounding and keep on coming. Its strength is also legendary. Note: The small nozzles or outcroppings in the chest, at the waist and on the back, are cooling nodules/release valves, and not weapons.

Demonfist Cyborg Shocktrooper

Class: Super-Heavy Combat Full Conversion Cyborg

M.D.C. by Location:

Shoulder Plasma Cannons (2) — 100each

* Retractable Vibro-Blades (3; right) — 50 each

* Forearm Guns (2) — 40 each

Forearms (2) — 80 each (140 with spiked demon armor)

Upper Arms (2) — 120 each (240 with demon armor)

Hands (2) — 65 each

Legs (2) — 140 each (240 with demon armor)

Feet (2) — 80 each (120 with demon armor)

Cooling Nodules (10 in front, 8 in back) — 10 each

** Head with Built-in Demon Face Plate — 180

*** Main Body — 350, plus 300 M.D.C. from additional heavy, spiked, demon body armor.

Damage Notes:

* A single asterisk indicates a small **and/or** difficult target to hit. The attacker must make a "Called Shot" and even then he is -3 to strike.

** Attackers are -5 to strike the head, which is protected by a thick collar and horns, as well as being somewhat tucked into the chest. Destroying the head of a cyborg will kill the character! This is where the brain is housed and when it's gone, that character is dead. However, the rest of the body can be salvaged and reused.

*** Depleting the M.D.C. of the main body will effectively destroy the artificial body, but emergency systems will keep the brain and vital organs alive for 18 hours. Recovery of the damaged body will enable Cyber-Docs to place the character on a life support system that will keep him alive until a new bionic frame becomes available. Failure to find the brain within 18 hours means the character dies. Massive amounts of damage (100 or more M.D.C. below zero) completely destroys the 'Borg, with no hope of recovery.

Speed:

Running: 50 mph (80.4 km) maximum.

Leaping: 8 feet (2.4 m) high and 14 feet (4.3 m) across; increase by 50% with a running start.

Flying: Not possible unless a *Cyborg Jet Pack* is used, and even then the normal speed and altitude is reduced by 60% due to its size, bulk and weight. **Cyberjet**Node systems are useless.

Statistical Data:

Average Height: 14 feet (4.3 m) to the top of the horns, and with the big guns pointed forward. About 12 feet (3.6 m) at the shoulders.

Width: 7 feet (2.1 m) at the shoulders; 10 feet (3 m) in spiked demon armor.

Length: 5 feet (1.5 m)



Weight: 7.1 tons
Tactile sensitivity: 35%
Robotic P.S.: 50
Bionic P.P.: 20
Face: Monstrous Horned Demon
Horror Factor: 13
Bonuses:
+1 on initiative
+2 to strike

+3 to parry
+1 to disarm
+4 to pull punch
+7 to save vs Horror Factor
Power System: Nuclear; average life is 20 years.
Black Market Cost: N/A. The process is secret and never shared with outsiders, much less offered for sale!
Warlord Cost: 4.2 million credits; the equivalent elsewhere would cost 8-10 million.

JOHNSON

Demonfist Weapon Systems:

1. Shoulder Plasma Ejector Cannons (2): Mounted on the back, between the shoulders are a pair of high-powered plasma cannons. They can be devastating weapons but have comparatively short-range for such large guns (such are the problems with plasma ejector weapons). To fire, one or both of the weapons move from their locked storage positions on the back (as shown in the illustration), to a forward position. They can be positioned in a 45 degree arc of fire, up and down, to directly parallel with the cyborg's eyes. They cannot move side to side, but the Demonfist can rotate 360 degrees at the hips.

Primary Purpose: Anti-Armor and Anti-Monster.

Mega-Damage: 1D4x10 M.D per single blast or 2D4x10 per simultaneous dual blast (counts as one melee attack).

Rate of Fire: Each blast counts as one melee attack.

Range: 2,000 feet (610 m).

Payload: Effectively unlimited.

2. Forearm Lasers (2): Each forearm has a double-barrelled laser. To fire it, point and shoot.

Primary Purpose: Anti-Personnel & Anti-Monster.

Mega-Damage: 4D6 M.D per dual blast. Both arm weapons cannot be fired simultaneously at the same target.

Rate of Fire: Each dual blast counts as one melee attack.

Range: 2,000 feet (610 m).

Payload: Effectively unlimited.

3. Triple Vibro-Blade (1): Three, silver-plated Vibro-Blades extend over the hand of the Demonfist. They are housed in the circular compartment above the right hand, and can be extended as needed.

Mega-Damage: 3D6 M.D. +Robot P.S. damage.

Range: Hand to Hand combat; about 11 feet (3.3 m).

4. Concealed Ion Rod (1): A concealed ion rod is located in the left leg.

Primary Purpose: Anti-Personnel & Defense.

Mega-Damage: 4D6 M.D per blast.

Rate of Fire: Each blast counts as one melee attack.

Range: 1,600 feet (488 m).

Payload: Effectively unlimited.

5. Left Hand Weapons & Features:

Chemical Spray: 10 doses, 15 foot (4.6 m) range, and in addition to the chemicals noted on page 240 of the **Rifts® RPG**, it is often loaded with holy water.

Silver Palm Needle: Used against the supernatural (1D6 S.D.C.).

Laser Finger: 1D6 M.D.; 500 feet (152 m).

Fingerjack

6. Right Hand Weapons & Features:

Chemical Spray: 10 doses, 15 foot (4.6 m) range, and in addition to the chemicals noted on page 240 of the **Rifts® RPG**, it is often loaded with holy water.

Laser Finger: 1D6 M.D.; 500 feet (152 m).

Garrote Wire: For strangling; located in the palm.

7. Robot P.S. and Punch Damage:

Head Butt — 3D6 M.D.

Restrained Punch — 1D6 M.D.

Full Strength Punch or Kick — 3D6 M.D.

Power Punch — 1D6x10 M.D.; but counts as two attacks.

Running Ram — 6D6 M.D., but counts as two attacks.

8. Hand-Held Weapons: Additional hand-held weapons, from energy rifles and rail guns to clubs and magic weapons, may be used by the cyborg. One energy pistol or one energy rifle is pretty standard. Grenades and other explosives may also be used.

9. Additional & Special Bionic Systems for the Demonfist:

- The Demonfist can rotate 360 degrees at the hips.
- Two large storage compartments are in the left leg.
- Synthetic Voice Enhancer for grunts, growls and roars.
- Optional: Cyborg Jet Pack is issued as needed.
- Optional Wide-Angle Lens; about 15% have it.

Russian Vehicles & War Machines

Old Style, Pre-Cataclysm Vehicles

One of the things about Russia that strike adventurers from Western Europe and North America, is the number of (comparatively) low-tech "wheeled" and "gasoline" powered, 20th century vehicles, not to mention bicycles, horses and animal drawn carts and wagons (pulled by horses, oxen and D-Bee animals). Old, 20th Century style motorcycles, jeeps, trucks, tractors and half-track (tread) vehicles are comparatively easy and inexpensive to build. Yet even these are relatively expensive (compared to 20th Century prices) and fairly uncommon. 20th Century ve-

hicles are most numerous in and around the Sovietski and some of the big cities under the protection of the Warlords. Even in these (relatively) modern cities (most of which are also equal to roughly early to mid-20th Century technology, culture and appearance), *motorized vehicles* are fairly uncommon. Seventy to eighty percent of these are owned by and serve the military and government, with 12-17% belonging to businesses and farms, leaving only 8% or less to wealthy individuals.

For example, a medium-sized farm might have 1-3 tractors, 1-6 trucks, 2-8 motorcycles and maybe a jeep, car, or one other vehicle (possibly an M.D.C. one). A large farm might have twice as many vehicles, while a small one isn't likely to have more than one tractor, one or two trucks and one or two motor-

cycles — farms in the wilderness, steppes and northwest may not have even one *motorized* vehicle, relying entirely on animals and manual labor! An estimated 50% of all plowing, field work, hauling goods, transportation and general labor on farms is done by horses, oxen, or other animals, and the calloused hands and strong back of the common worker. The amount of man and animal labor jumps to 85% in the wilderness and steppes, where motorized vehicles among the common people are very rare. Except for the rare city, the Sovietski, and the technology held closely by the Warlords for their Camps, modern vehicles and technology greater than 19th to 20th century levels are very uncommon and found in scattered patches across a land area more than three times the size of the United States!

The use of horses, other riding animals and bicycles as a means of transportation is common throughout Russia, and let's not forget the mode of transportation provided by one's own feet. Russians do a lot of walking.

Magic and magical vehicles are uncommon in Russia. Other than the handiwork of the *Mystic Kuznya* (smithy) augmenting animals with magical horseshoes and men with enchanted tools, there is little in the way of magic that can help the average peasant. This is why, against the decree of the Warlords, some peasants enlist friendly faerie folk, spirits and D-Bees to help them in their backbreaking labors.

Used Vehicles: The prices for used vehicles are typically 30-50% less depending on their condition and state of repair. However, the S.D.C. (or M.D.C.) will be 1D6x10% less than a new vehicle, and the maximum speed will be 3D6% slower (either a clogged, tired old engine or improperly calibrated; needs a tune-up). Some used vehicles may also be missing standard features or have other little problems or broken parts (door sticks, lock doesn't work, stereo is missing, etc.)

Note: For worldwide continuity, prices are presented in Universal Credits. However, the Rubles (Rb) currency has been reinstated by the Warlords. The current rate of exchange (among those who will accept Rubles is two Rb for one Universal Credit. Also note that most villagers and wilderness people won't accept Rubles or Universal Credits! Instead they trade goods and services for everything.

Common, Conventional, S.D.C. Vehicles

Note: Listed in order of most common/numerous.

Bicycles

Common Street Bike: A.R. 6, S.D.C. 40, Speed: 5-15 mph (8 to 24 km) on the streets, dirt roads and well worn trails. Reduce to 3-5 mph (4.8 to 8 km) off-road. Plus the bike will suffer 1D4 S.D.C. damage for every five miles (8 km) travelled on rugged conditions. Range: Varies with the stamina (P.E.) of the person pedaling (typically about 4 miles/6.4 km per P.E. point of the individual character); can travel up to 15 miles (24 km) per hour. **Cost:** 60 Universal Credits.

Racing Bike: A.R. 5, S.D.C. 30, Speed: 10-20 mph (16 to 32 km) on the streets, dirt roads and well worn trails. Reduce to 5-8 mph (8 to 13 km) off-road. Plus the bike will suffer 1D6 S.D.C. damage for every five miles (8 km) travelled on rugged conditions. Range: Varies with the stamina (P.E.) of the person ped-

aling (typically about 4 miles/6.4 km per P.E. point of the individual character); can travel up to 20 miles (32 km) per hour. **Cost:** 150 Universal Credits.

Mountain Bike: A heavy-duty bike with tires designed for travelling off-road on dirt trails, grass, and other uneven and rugged terrain.

A.R. 7, S.D.C. 60, Speed: Around 10-12 mph (16 to 19 km) along dirt roads, wide trails and flat terrain, 6-8 mph (9.6 to 13 km) on rocky, rugged or overgrown terrain. Range: Varies with the stamina (P.E.) of the person pedaling (typically about 4 miles/6.4 km per P.E. point of the individual character); can travel up to 12 miles (19 km) per hour (15 miles/24 km on smooth roads and streets). **Cost:** 150 Universal Credits.



Motorcycles

Scooter: Basically a motorized Mountain Bike. A.R. 7, S.D.C. 50, Speed: 50 mph (80 km), Range: 200 miles (322 km). **Cost:** 150 to 300 credits.

Motorcycle — Light: A.R. 7, S.D.C. 50, Speed: 90 mph (145 km), Range: 120 miles (193 km). **Cost:** 300-800 credits.

Motorcycle — Medium: A.R. 8, S.D.C. 100, Speed: 110 mph (177 km), Range: 350 miles (563 km). **Cost:** 1,000-2,000 credits.

Motorcycle — Heavy: A.R. 10, S.D.C. 150, Speed: 140 mph (224 km), Range: 350 miles (563 km). **Cost:** 3,500-25,000 credits.

Note: Custom modifications for Motorcycles:

Add 600-1000 credits for souped-up bikes and increase speed by 20%.

Add 500 credits for a sidecar attachment.

Add 10,000 credits to the price for motorcycles customized to have 20 M.D.C. maximum.

Trucks and Work Vehicles

Pickup Truck (4 wheel drive): A.R. 7, S.D.C. 350, Speed: 120 mph (193 km), Range: 400 miles (644 km). **Cost:** 14,000 to 20,000 credits.

Small Truck: A.R. 8, S.D.C. 300, Speed: 120 mph (193 km), Range: 300 miles (483 km). **Cost:** 18,000 to 24,000 credits.

16 to 20 foot Truck: A.R. 9, S.D.C. 400, Speed: 120 mph (193 km), Range: 200 miles (322 km). **Cost:** 30,000 to 45,000 credits.

24 to 30 foot Truck: A.R. 10, S.D.C. 500, Speed: 120 mph (193 km), Range: 190 miles (306 km). **Cost:** 60,000 to 80,000 credits.

Semi- (Truck Cab only): A.R. 11, S.D.C. 600, Speed: 120 mph (193 km), Range: 150 miles (241 km). **Cost:** \$90,000 and up. Add another \$90,000 for the cargo bed (trailer).

Full-Size Van: A.R. 7, S.D.C. 400, Speed: 120 mph (193 km), Range: 200 miles (322 km). **Cost:** 16,000 to 28,000 credits.

Note: Custom modifications for Trucks:

Increase price by 20% for a heavy-duty rig; also increase A.R. by 2 points and S.D.C. by 10%.

Add 1000 credits for souped up trucks and increase speed by 20%.

M.D.C. armor: 10,000 credits per 20 M.D.C.; 60 M.D.C. max.

Weapon systems can also be added for the cost of the weapon and its power supply, plus 1,000 to 4,000 credits for installation.

Automobiles

Note: Most automobiles are found only at industrialized cities, and are nonexistent in the steppe and wilderness regions (which is most of Russia). Even jeeps and trucks are uncommon in the wilderness.

Jeep (4 wheel drive): A.R. 6, S.D.C. 300, Speed: 120 mph (193 km), Range: 400 miles (644 km). **Cost:** 24,000 to 30,000 credits.

Compact Automobile: A.R. 5, S.D.C. 300, Speed: 110 mph (177 km), Range: 350 miles (563 km). **Cost:** 15,000 to 25,000 credits.

Mid-Sized Automobile: A.R. 6, S.D.C. 350, Speed: 110 mph (177 km), Range: 300 miles (483 km). **Cost:** 25,000 to 30,000 credits; uncommon.

Full-Sized Sedan: A.R. 7, S.D.C. 450, Speed: 120 mph (193 km), Range: 250 miles (402 km). **Cost:** 30,000 to 40,000 credits; rare.

Sports Car (any make): A.R. 5, S.D.C. 350, Speed: 180 mph (290 km), unmodified, but can be souped up to 220 mph (352 km). Range: 200 miles (322 km). **Cost:** 55,000 to 100,000 credits; rare.

Customizing Cars: Automobiles (rare to begin with) are seldom customized, but can get the same modifications as the truck.

Aircraft — Super-Rare

Single Engine: A.R. 6, S.D.C. 400, Speed: 300 mph (483 km), Range: 680 miles (1094 km). **Cost:** 70,000-100,000 credits; rare (the Sovietski has 60).

Twin Engine: A.R. 7, S.D.C. 550, Speed: 420 mph (676 km), Range: 600 miles (966 km). **Cost:** 300,000 to 500,000 credits; rare (the Sovietski has 40).

Small Jet: A.R. 9, S.D.C. 850, Speed: 600 mph (966 km), Range: 1370 miles (2205 km). **Cost:** 750,000 to 1.1 million credits; very rare (the Sovietski has 20).

Fighter Jet: A.R. 10, S.D.C. 900, Speed: 670 mph (1072 km) to 2010 mph (3216 km), Range: 2000 miles (3200 km). **Cost:** One million credits and up; super-rare (the Sovietski has 6).

Helicopter: A.R. 7, S.D.C. 350, Speed: 300 mph (483 km), Range: 680 miles (1094 km). **Cost:** \$500,000 to 800,000 credits; very rare (the Sovietski has 96).

Russian Combat Vehicles

Note that the manufacture, sale and distribution of many M.D.C. combat vehicles are under the direct control of the respective Warlords. Certain vehicles not under their control may also be outlawed for the common man. Although many Warlords will sell and trade specialty vehicles under their control to rival Warlords and their Camps (each personalizes the vehicle with their own unique **insignias/emblems**, logos, paint jobs and other custom modifications), ordinary citizens are usually forbidden to own or use such combat vehicles.

Punishment is the seizure of the illegal vehicle, a thorough search of the person's home and business for other contraband (mainly things that could be used in a rebellion against the Warlord), a stern warning and possibly a beating. Repeat offenders will be beaten, their property plundered and warned for the last time. If caught again, they will be killed, their families (if any) cast into the street, and all their property seized by the Warlord (or it may be destroyed as an example, but only after all valuables have been removed).

Note: In addition to the variety of M.D.C. vehicles noted below, a variety of *Polish* and *Triax/NGR* vehicles, robots, bionics, weapons and equipment can be found in the Russian Frontier. Even the occasional item from the *Phoenix Empire*, *Middle East*, *Italy*, *Atlantis*, *North American* and technology from other far-off places can be found in Russia and the surrounding regions, as well as the occasional **alien/D-Bee** artifact and gizmo.

The descriptions that follow are only some of the most common and notable vehicles and war machines of Russian design and manufacture. As noted, the manufacture of many are controlled by the Warlords and used exclusively by their War Camps.

Features Common to Russian M.D.C. Vehicles

1. Cyber-Link: The Warlords' pervasive use of cybernetics and cyborg warriors means most *small vehicles*, particularly combat and wilderness types, have jacks and hook-ups to link the cyborg pilot directly to the vehicle. This means a direct and instant feed of information to and from onboard computers, sensors, communication systems and weapons, making the vehicle a fast-responding extension of his own body (+5% to piloting

skill, +1 on initiative, etc.; see the *Cyber-Link* description in the Cybernetics Section for complete bonuses and details).

2. Gromeko Battlefield Computers: Takes care of communications, visual data and internal cybernetic systems (monitors personal damage). All communications are automatically encrypted/decrypted by the sender/receiver units without their operators having to specify it. This can be turned off if desired, but rarely is (unless you want to "leak" some information).

It also features "Enemy Profiling" for up to 600 different cyborg designs, styling, and armor, 1000 identifying insignias and marks, as well as 2000 monsters and demons — each rendered in full color with schematics of known weaknesses, armor, weapons, etc., capable of rotation and zoom to x25 magnification. The Gromeko functions as a kind of passive *Friend or Foe Identification system*, flashing words, or symbols for the majority who cannot read, on the monitor and HUD display. This vehicle model of the Gromeko is larger, has a more powerful computer and larger memory compared with the bionic version tied into the cyber-optics of many 'Borgs. Visual Range: 6,000 feet (1828 m). Requirements: A video camera with telescopic capabilities (otherwise reduce range to 2000 feet/610m).

3. Enviro-Sensors: An external and internal sensor system that monitors the environment outside and inside the vehicle. This is done on a molecular level and used to detect and measure impurities, chemical, germ/biological and other dangerous agents (toxic gases, smoke, pollution, spores, radiation, etc.) in the immediate area surrounding the vehicle. It can identify 6000 elements, gases and agents as well as measure temperature, wind speed, humidity, barometric pressure and similar air and environmental aspects.

The same is true inside the vehicle with links to the life support system to monitor conditions and warn of breaches and dangers inside. When exposed to gases, oxygen masks drop from concealed compartments in the ceiling (similar to those in 20th Century airplanes) to protect crew and passengers.

4. Cyber Harness: A metal harness normally kept tilted up over the pilots, sensor operators and gunners. These pull down over the user, and have cyber-jacks that link into the cyborg, to pilot the vehicle. The computer controls the vehicle's functions, and is controlled cybernetically by the user. While in this condition, a cyborg may not move or take any effective action.

The most incredible thing about this set-up is that the cyborg can simultaneously fire a number of weapons systems equal to his level of experience! Warlords sitting in their can usually access almost all their weapons at once!

5. Cybernetic Locking Mechanisms: Hatches and doors to sensitive areas, like engines, may be fitted with a lock, which means the individual must link with the lock for it to open. While linked, the lock accepts information to open based on the Warlord's "Symbol," a recognition pattern built into every Warlord's cyborgs. Other systems, like energy weapons, rail guns, ignition switches and more, have this feature.

6. Cyborg Containment Slings (CCS's): Most larger Warlord vehicles come standard with cyborg containment slings, which are connected to the ceiling of the main troop compartment near the sides. 'Borgs may rest in these harness slings while a vehicle is in motion, for Warlord vehicles tend to be on the rough and bouncy side. Without the slings, there is a 50% chance every few minutes the vehicle is in motion (I'm thinking

battlefield conditions) that anyone standing in the main compartment(s) area will be thrown around and/or lose their footing. The CCS's can be exited immediately through a buckle release.

7. Other Common Sensor Systems: Perfect, crisp, 20/20 digital vision optics relay, video camera, Infrared/Ultraviolet 1,000 feet (304 m), Passive 2,500 feet (762 m), and Digital Recorder (16 hours maximum data).

8. Long-range radio communication system: Approx. 500 mile (800 km) range in the steppes and tundra, 300 miles (482.7 km) in the forests and around cities (interference) and 100-200 (160 to 320 km) in the mountains (Note: The interference from the latter two is common to all ground vehicles, not just Russian designs).

9. Radar: Can identify and track up to 56 aerial targets simultaneously at a range of 30 miles (48 km).

10. Power Source: Most large vehicles are nuclear powered, but many smaller vehicles are available with a choice of liquid fuel engines or electrical/solar powered engines. The average life of a small nuclear powered vehicle is 10 years, while large vehicles typically have 20 years.

11. Full environmental pilot and crew compartment: Warlord robot vehicles typically contain enough room to seat 2-4 cyborgs (4-8 human-sized passengers), and are sealed airtight and pressurized when in use. They are suitable for use in all hostile environments and can even survive underwater for a few hours (300 -400 feet/91-122 m maximum depth). However, unless stated otherwise, the vehicle cannot propel itself underwater nor move along the bottom of a lake or sea floor.

The following features are common on all larger Warlord vehicles.

- Computer controlled life support system. In Warlord vehicles, this constantly monitors the status of the vehicle's interior. It checks air quality, presence of harmful gases or radiation, excessive heat and cold and so on. Any suspicious conditions will be instantly red-lighted in the cockpit and all control stations of the vehicle.
- Automated blast doors. These will close and lock without being given a signal in the presence of high levels of radiation (cracked fusion power plant for example), nerve gas or any other toxic element. They will not open until overridden by a special code, electronically picked or blown apart. Blast doors all have 100 M.D.C. Note: Small vehicles don't have blast doors, and may not have an environmental compartment.
- Internal cooling and temperature control.
- Air purification filters and circulation system, and gas filtration, humidifier/dehumidifier (which is often in disrepair), all of which automatically engage in low oxygen or contaminated air environments. 36-48 hour oxygen supply units in most vehicles.
- Insulated, high temperature resistant shielding for up to 400 degrees centigrade. Normal fires do no damage. Nuclear, plasma, and magic fires do full damage.
- Radiation shielded to at least 1,000 rads (enough to make a character ill almost instantly).
- Polarized and light sensitive/adjusting tinted observation windows (when applicable).
- Heads Up Display (HUD).

Adventuring & Combat Vehicles

Novyet Vehicles

Note: Novyet vehicles are quickly becoming the most popular Mega-Damage vehicles in Russia and can be found throughout Russia and the old Eastern Block states (Poland, Hungary, Ukraine, etc.), but are most common in and around *Krakow (Poland)*, *Kiev (Ukraine)*, and *New Moscow (northeastern Russia)*. Novyet Manufacturing has its origins and main base of operations, design and manufacturing in Kiev, with satellite opera-

tions and factories in New Moscow (its second largest complex) and Krakow. Novyet also trades, buys and sells to the *NGR/Triax* on a limited basis (mostly raw materials and nuclear engines) and to Poland (vehicles, parts, the works). The New Soviet government purchases Novyet vehicles at a quantity discount of 30-40%.

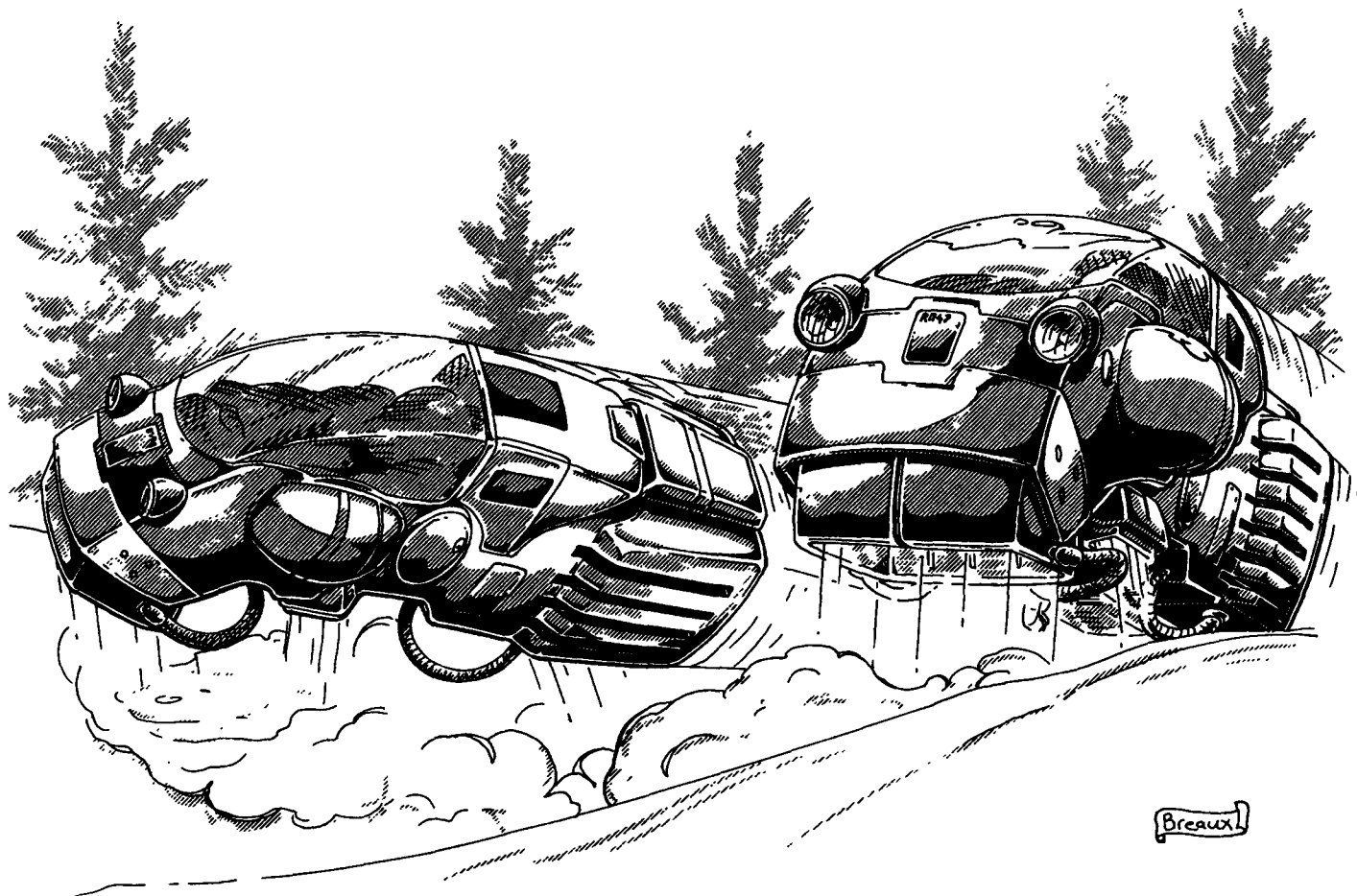

Novyet Arctic Hoverbike

The latest and hottest release from Novyet Manufacturing is a heavy-duty, reliable hovercycle suitable for use in the winter and under arctic conditions — most traditional hovercycles have a tendency to stall, freeze (won't go until **unfrozen**) and cause avalanches. A special heat circulation and air cycling system keeps the engine and hoverjets from freezing, while an enclosed and heated cockpit protects the driver. Heated locks keep them from freezing and an excellent defrost system keeps the glass of the cockpit and rear view mirrors from freezing. Field tests show that the Arctic Hoverbike can perform in sub-zero conditions up to 130 degrees Fahrenheit below zero (-90 C), and has performed with minimal stalling and freezing problems at temperatures down to 200 degrees below zero (-129 C). A muffled "soft-flow" hover jet system causes minimal noise and distur-

bance of the snow to help prevent avalanches and similar snow and ice slides.

If this excellent vehicle has a downside, it is its slow speed compared to conventional hovercycles, but faster speeds dramatically increases the chance of snow slides.

Crew: One

Capacity: One human-sized passenger up to 7.6 feet (2.3 kg) and 500 pounds (225 kg); suitable for partial and Light Machine 'Borgs, but full conversion cyborgs and Heavy Machines may be too large **and/or** heavy to use this vehicle.

Cargo: Minimal; space for a rifle, survival kit, backpack, and a couple of small items or packages. An additional 200 pounds (90 kg) can be strapped to the outside of the Hoverbike and it can pull up to an additional 300 pounds (136 kg).

Height: 4 feet (1.2 m) body; landing gear is three skis, two in the rear on the sides of the vehicle, and one centered under the front section.

Width: 3.6 feet (1.1 m); wide at the rear, tapers a foot (0.3 m) toward the front.

Length: 8 feet (2.4 m)

Weight: One ton.

Power Source: Internal combustion engine (alcohol and/or gasoline mix) or nuclear.

Range: Liquid fuel: 300 miles (480 km); nuclear: unlimited.

Speed: Hover stationary to 100 mph (160 km), but cruising speed is typically around 60 mph (96.5 km).

Leaps: Capable of thruster assisted leaps 30 feet (9 m) high and 100 feet (30.5 m) across.

Flight Ceiling: 150 feet (76.2 m); VTOL capable.

Life Support: Air circulation and cleaning system with gas filtration and toxic warning system. The bike can also be sealed tight and has an internal oxygen supply with one hour of air. Can withstand up to 200 Rads of radiation.

M.D.C. by Location:

* Hoverjets (6) — 22 each

* Landing Skis (3) — 20 each

* Headlights (2) — 3 each

Reinforced Windshield of the Cockpit — 60

** Main Body — 135

* Locations marked with a single asterisk are small and/or difficult targets to hit. Thus, they can only be hit when a character makes a *called shot* and even then, the attacker is -3 to strike.

** Depleting the M.D.C. of the entire main body will destroy the vehicle.

Cost: 90,000 to 120,000 credits (cost is higher in remote regions) for the standard alcohol or gasoline mixed, internal combustion engine with a range of 300 miles (480 km); good availability. 1.1 million credits for the nuclear powered bike with a 10 year life and effectively unlimited range; poor availability.

Note: The Sovietski has 20,000 with another 20,000 on order; 5% are nuclear powered.

Novyet Snow-Jetsled

A low, sleek snowmobile usually fitted with a turbine engine that takes liquid fuel. It can operate over a fair range of terrain,

but is limited somewhat by very rugged landscapes and mountainous regions (needs a trail or path). The snowmobile operates by means of vector jets controlled by a computer system in the steering control, and has a retractable exhaust baffle. This allows the pilot to attempt spectacular stunts if desired by thumbing the booster at opportune moments. Forward braking jets in the underbelly and nose are used for sudden stops. The pilot must be careful when attempting leaps and other stunts because they could damage the chassis of the Jetsled. More than 30 M.D.C. taken in a single crushing fall (or attack) will knock out one of the jet engines and reduce speed by 30%.

Crew: One

Capacity: One human-sized driver and one human-sized passenger up to 7.6 feet (2.3 kg) and a total of 600 pounds (270 kg); suitable for partial and Light Machine 'Borgs, but full conversion cyborgs and Heavy Machines are usually too large and/or heavy to use this vehicle.

Cargo: Minimal; space for a rifle, survival kit, and backpack. An additional 200 pounds (90 kg) can be strapped to the outside of the Snow-Jetsled and it can pull up to an additional 200 pounds (90 kg), but speed is reduced by 20% and control (pilot skill) is -10%.

Height: 2.5 feet (0.76 m)

Width: 3 feet (0.9 m)

Length: 6 feet (1.8 m)

Weight: 1000 pounds (450 kg)

Power Source: Liquid fuel turbine, turbojet engine or nuclear.

Range: 250 miles (400 km) for the liquid fuel engine, effectively unlimited when nuclear powered.

Speed: Top speed is 150 mph (240 km), but cruising speed is usually around 70 mph (112.6 km). *Kruger Note:* I don't know how many of you have driven snowmobiles, but 150 mph better be reserved for flat-out open spaces like the steppes! Traveling through woodlands or rugged terrain will reduce maximum speed by 50-70%; to go faster is suicide (will crash into something).

Leaps: Capable of thruster assisted leaps 15 feet (4.6 m) high and 50 feet (15.2 m) across.

M.D.C. by Location:

Rear Turbo-Jets (2) — 25 each

* Small Braking/Maneuvering Jets (4) — 6 each

* Snow Skis (2) — 25 each

* Headlights (2) — 3 each

Reinforced Windshield — 10

** Main Body — 100

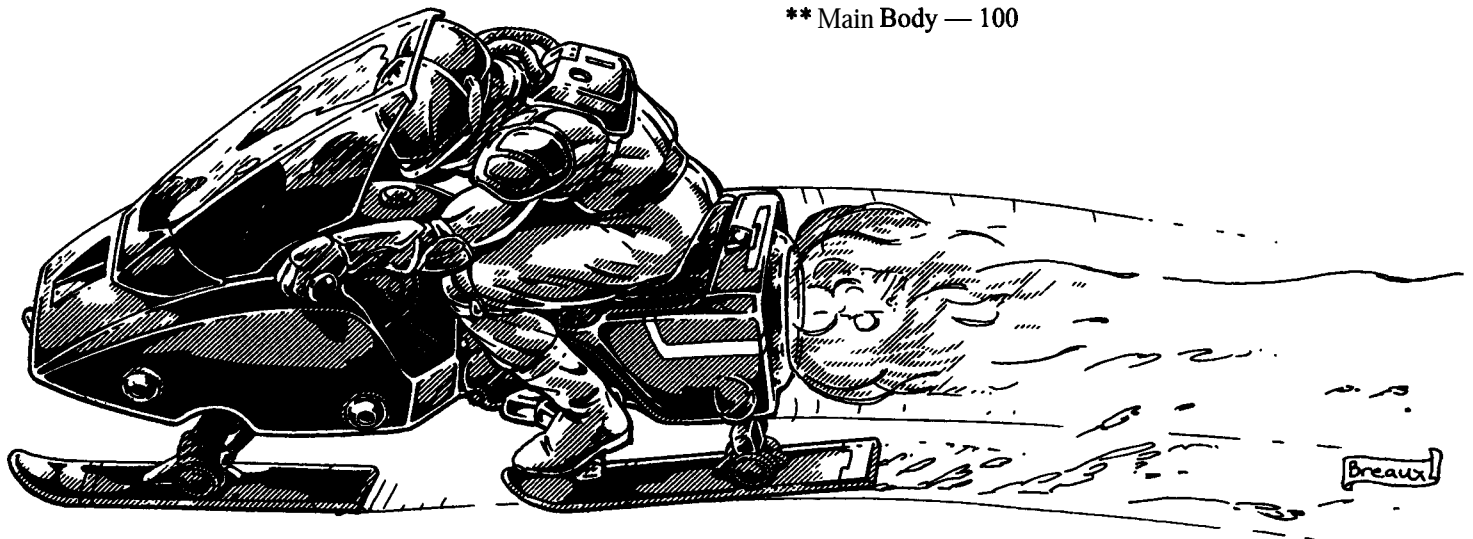

* Locations marked with a single asterisk are small and/or difficult targets to hit. Thus, they can only be hit when a character makes a *called shot* and even then, the attacker is -3 to strike.

** Depleting the M.D.C. of the entire main body will destroy the vehicle.

Cost: 45,000 to 60,000 credits (cost is higher in remote regions) for the standard alcohol or gasoline mixed, turbine engine with a range of 250 miles (400 km); excellent availability. One million credits for the nuclear powered bike with a 10 year life and effectively unlimited range; rare.

Note: The Sovietski has 40,000 of these vehicles; 2% are nuclear powered.



Novyet Landcrawler-Sku

This small, three-man vehicle has a pair of treads/tracks in the rear and a pair of large M.D. wheels in the front, each with independent suspension for travelling over rugged, uneven terrain. The front wheels can be replaced with sturdy skis in the winter to navigate on top of deep snow. The vehicle is designed for short-range exploratory missions and personnel transport. Its small size allows the Landcrawler to navigate narrow streets and trails, stairs, and fairly steep hills and mountains. The Landcrawler can ascend inclines of up to 55° maximum (30° to 45° is optimum). The pilot's compartment is comfortable, if not overly spacious.

Crew: Two with space for two passengers; two could also ride on top of the vehicle.

Capacity: 2, another human-sized passenger can squeeze in if necessary.

Cargo: Up to 1,000 pounds (450 kg), set in "saddlebag" compartments on the sides; up to three tons can be pulled.

Height: 6 feet (1.8 m)

Width: 5 feet (1.5 m)

Length: 9 feet (2.7 m)

Weight: 3 tons

Power Source: Choice of gasoline, electricity/solar batteries (both with a 250 mile/400 km range on one tank or charge) or nuclear. **Note:** The electric/solar version can recharge itself outdoors using a built-in solar panel array. It takes 10 minutes of daylight to recharge the batteries for one mile.

Speed: Top speed is 72 mph (120 km), cruising 42 mph (70 km); half under treacherous conditions.

Sensors: The landcrawler has a digital HUD with passive nightvision and auto-range-finding, 1,500 feet (457 m) each, and radio to 10 miles (16 km).

Internal Life Support: 16 hours internal oxygen with gas filtration, withstands up to 500 Rads of radiation.

M.D.C. by Location:

Windows (6) — 25 each

* Headlights (2) — 2 each

Rear Treads (2) — 60 each

* Forward Wheels or Skis (2) — 45 each

Reinforced Pilot's Compartment — 50

** Main Body — 130

* Locations marked with a single asterisk are small and/or difficult targets to hit. Thus, they can only be hit when a character makes a *called shot* and even then, the attacker is -3 to strike.

** Depleting the M.D.C. of the entire main body will destroy the vehicle.

Market Cost: 185,000 Universal credits; add one million to the cost for a nuclear powered Landcrawler, but also add 40 to the M.D.C.

Note: As many as two light weapon systems can be built into the vehicle at extra cost, and up to 80 M.D.C. at a cost of 10,000 credits per 20 M.D.C.

Note: The Sovietski has 10,000 of these vehicles, with another 2000 on order; 30% are nuclear powered.

Novyet Explorer-Sku

The Explorer is a large and heavily built, four tread vehicle. There is a small pilot's compartment with room for the driver and 2-3 passengers. Behind the pilot's compartment is a trailer or cargo area that can be used for hauling cargo or turned into a spacious passenger compartment capable of accommodating eight human-sized passengers in reclining seats and still have room for two computer stations, a large storage cabinet, a 20 gallon water cooler, mini-grill, and a small bathroom with sink

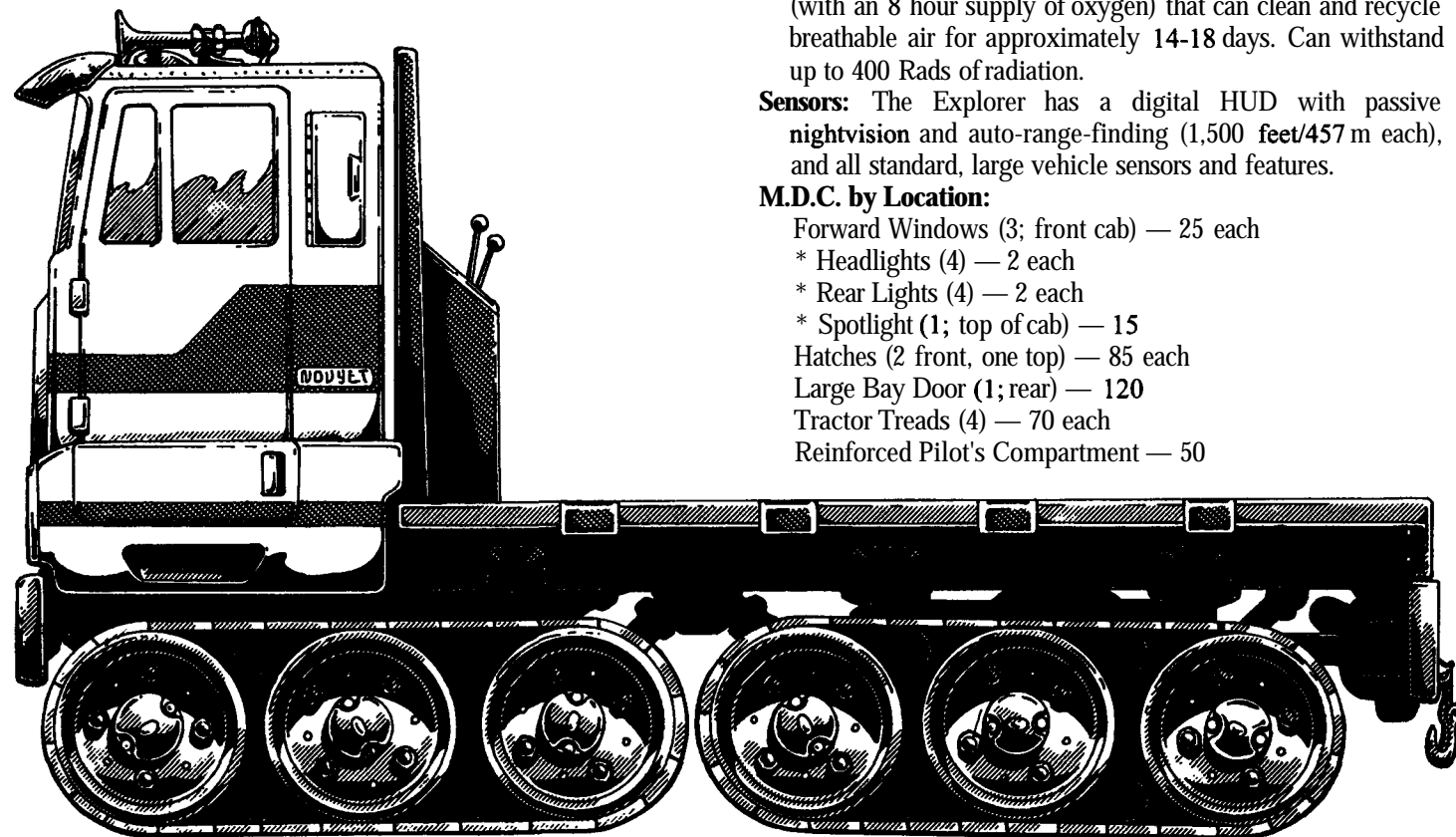

and toilet (100 gallon flush tank). However, most (65%) Explorer-Sku see the back cargo bay turned into a field laboratory with 3-4 bunk bed style sleeping areas, a refrigeration unit, specimen cabinet, mini-laboratory, audio and video recording station, a small communications/sensor station, and mini-kitchen with a small grill and range, a storage cabinet, sink with a 100 gallon water tank, as well as two computer stations, water cooler and bathroom.

The Explorer can take on the toughest of the unforgiving Eurasian landscape and looks good doing it. It can drive through snow blizzards and ride atop deep snow. The Explorer's track/tread system also makes it suitable as an all-purpose transport, cargo hauler and it even does an adequate job at farming, and construction.

Crew: 2-4

Capacity: Can transport 6-8 passengers comfortably, 14 cramped, depending on the configuration and use of the rear cabin/cargo bay. It can carry 20 tons and pull an additional 20 tons (although max. speed is reduced by half).

Height: 8 feet (2.4 m)

Width: 12 feet (3.6 m)

Length: 22 feet (6.7 m)

Weight: 7 tons

Power Source: Liquid fuel combustion engine (plus independent laboratory generator) with a range of 700 miles (1120 km), or nuclear (about a 50/50 split are manufacturers).

Speed: Top: 70 mph (112 km), with a typical cruising speed of 40 mph (64 km). Deep snow and treacherous terrain may reduce speed to under 20 mph (32 km).

Life Support: Air circulation and cleaning system with gas filtration and toxic warning system. The vehicle's cab/pilot's forward section and rear cabin can be sealed independently and have an air purification, purge and circulation system (with an 8 hour supply of oxygen) that can clean and recycle breathable air for approximately 14-18 days. Can withstand up to 400 Rads of radiation.

Sensors: The Explorer has a digital HUD with passive nightvision and auto-range-finding (1,500 feet/457 m each), and all standard, large vehicle sensors and features.

M.D.C. by Location:

Forward Windows (3; front cab) — 25 each

* Headlights (4) — 2 each

* Rear Lights (4) — 2 each

* Spotlight (1; top of cab) — 15

Hatches (2 front, one top) — 85 each

Large Bay Door (1; rear) — 120

Tractor Treads (4) — 70 each

Reinforced Pilot's Compartment — 50

** Main Body: Forward Cab Section — 230

** Main Body: Rear Cabin/Lab Section — 310

* Locations marked with a single asterisk are small and/or difficult targets to hit. Thus, they can only be hit when a character makes a *called shot* and even then, the attacker is -3 to strike.

** Depleting the M.D.C. of the entire main body will destroy the vehicle.

Market Cost: 565,000 Universal credits for a basic cargo Explorer with a liquid fuel system.

Add one million to the cost for a nuclear powered vehicle (+40 additional M.D.C.).

Add 20,000 for a fully outfitted living quarters for eight.

Add 100,000 for the laboratory and research cabin.

As many as four light weapon systems can be built into the vehicle at extra costs. However, since the vehicle is not intended for combat, most street version have no weapons or just one.

Note: The Sovietski has 2,300 of these vehicles equipped with one MK "Saber" Quad-Rail Gun Turret, one Kharkov M9 Manned Rail Gun Turret and a mini-missile launcher (64 missile payload); 60% are nuclear powered, 70% are lab versions.

Novyet Bear ATV

A thick-bodied ATV with large, wide, balloon tires similar to the Big Boss ATV (from the *Rifts® RPG*). The Bear is larger than the Big Boss and the front tires are somewhat larger than the rear ones, enhancing the "bear" similarity. The front of the vehicle is also wider, taller and bulkier than the rear. The ATV has four-wheel drive, with **posi-traction** favoring the front wheels in case of steep grades. With most of the weight in the front, hill climbs become somewhat easier.

The vehicle seats six comfortably and has room for two in the pilot's area. It also comes with a tow hitch (100 feet/30.5 m) and built-in winch (equal to a robot P.S. of 30).

Crew: One driver

Capacity: 6-9 additional human-sized passengers.

Cargo: Up to two tons (900 kg), plus it can pull an additional five tons.

Height: 10 feet (2.1 m) in the front, 7.6 feet (2.3 m) in the rear.

The tires are four feet (1.2 m) in diameter.

Width: 8 feet (2.4 m)

Length: 18 feet (5.4 m)

Weight: 6 tons

Power Source: Liquid fuel system with a 500 mile (800 km) range, or nuclear.

Speed: 95 mph (152 km) maximum, with a typical cruising speed of 50 mph (80 km). The Bear handles well on ice and snow up to three feet (0.9 m) deep. Snow deeper than that presents a danger of getting stuck.

Life Support: Air circulation and cleaning system with gas filtration and toxic warning system, and can handle up to 300 Rads of radiation.

Sensors: Nothing special except Cyber-Link.

M.D.C. by Location:

Forward Windows (3) — 25 each

Side windows (4; two on each side) — 25 each

Rear Window (1; large) — 25

* Headlights (2) — 2 each

* Rear Lights (4) — 2 each

* Spotlight (1; small, on the driver's side) — 8



- * Hatches (2 front/driver section) — 55 each
- Side Cargo Doors (2, one on each side) — 60 each
- Rear Cargo Door (1) — 70
- Balloon Tires (4) — Front: 35 each, Rear: 30 each
- ** Main Body — 135

* Locations marked with a single asterisk are small and/or difficult targets to hit. Thus, they can only be hit when a character makes a *called shot* and even then, the attacker is -3 to strike.

** Depleting the M.D.C. of the entire main body will destroy the vehicle.

Market Cost: 136,000 Universal credits for a basic Bear with a liquid fuel system.

Add one million to the cost for a nuclear powered vehicle (+40 additional M.D.C.).

Add 10,000 credits per 20 additional M.D.C. up to 80 extra, maximum.

As many as three light weapon systems can be built into the vehicle at extra costs. However, since the vehicle is not intended for combat, most street versions have no weapons or just one.

Note: The Sovietski has 2,100 of these vehicles, equipped with one Kharkov M9 Manned Rail Gun Turret and a mini-missile launcher (32 missile payload); 33% are nuclear powered.

Other Vehicles of Note

Heavy M.D.C. Snowmobile

A reliable, heavy-duty, M.D.C. snowmobile. At temperatures under 30 degrees Fahrenheit below zero (-34 C), the locks and ignition are likely to freeze (01-80% chance), and the vehicle will perform sluggishly (-30% to speed, -10% to skill performance). At 50 degrees below (-46 C) or colder, the entire engine will freeze up within five minutes after it is turned off. There is also a 01-50% chance it will stall and shut down (roll every 15 minutes); impossible to restart unless allowed to warm up to at least freezing (32 degrees Fahrenheit/Zero Celsius). Furthermore, travelling faster than 40 mph (64 km) over loose or fresh

snow on the slopes of a hill or mountain has a 01-60% chance of causing an avalanche and similar snow and ice slides.

Crew/Capacity: One human-sized driver (and passenger) up to 7.6 feet (2.3 kg) and 500 pounds (225 kg); suitable for partial and Light Machine 'Borgs, but full conversion cyborgs and Heavy Machines may be too large and/or heavy to use this vehicle.

M.D.C. by Location:

* Snow Skis (2 or 3) — 15 each

* Headlights (2) — 2 each

Reinforced Windshield — 30

** Main Body — 85

* Locations marked with a single asterisk are small and/or difficult targets to hit. Thus, they can only be hit when a character makes a *called shot* and even then, the attacker is -3 to strike.

** Depleting the M.D.C. of the entire main body will destroy the vehicle.

Speed

Speed: 100mph (160 km), but cruising speed is typically around 50mph (80.5 km).

Leaps: Capable of leaps six feet (1.8 m) high and 12 feet (3.6 m) across.

Range: Liquid fuel: 200 miles (320 km); nuclear: unlimited.

Statistical Data

Height: 3 feet (0.9 m)

Width: 3.6 feet (1.1 m)

Length: 6 feet (1.8 m)

Weight: 500 pounds (225 kg)

Power Source: Internal combustion engine (alcohol and/or gasoline mix) or nuclear.

Cargo: Minimal; space for a rifle, winter survival kit, backpack, and a couple of small items or packages. An additional 100 pounds (45 kg) can be strapped to the outside of the snow mobile and it can pull up to an additional 300 pounds (136 kg).

Cost: 26,000 to 40,000 credits (cost is higher in remote regions) for the standard liquid fuel engine; good availability.

925,000 to 1.1 million credits for the nuclear powered vehicle with a 10 year life and effectively unlimited range; poor availability.

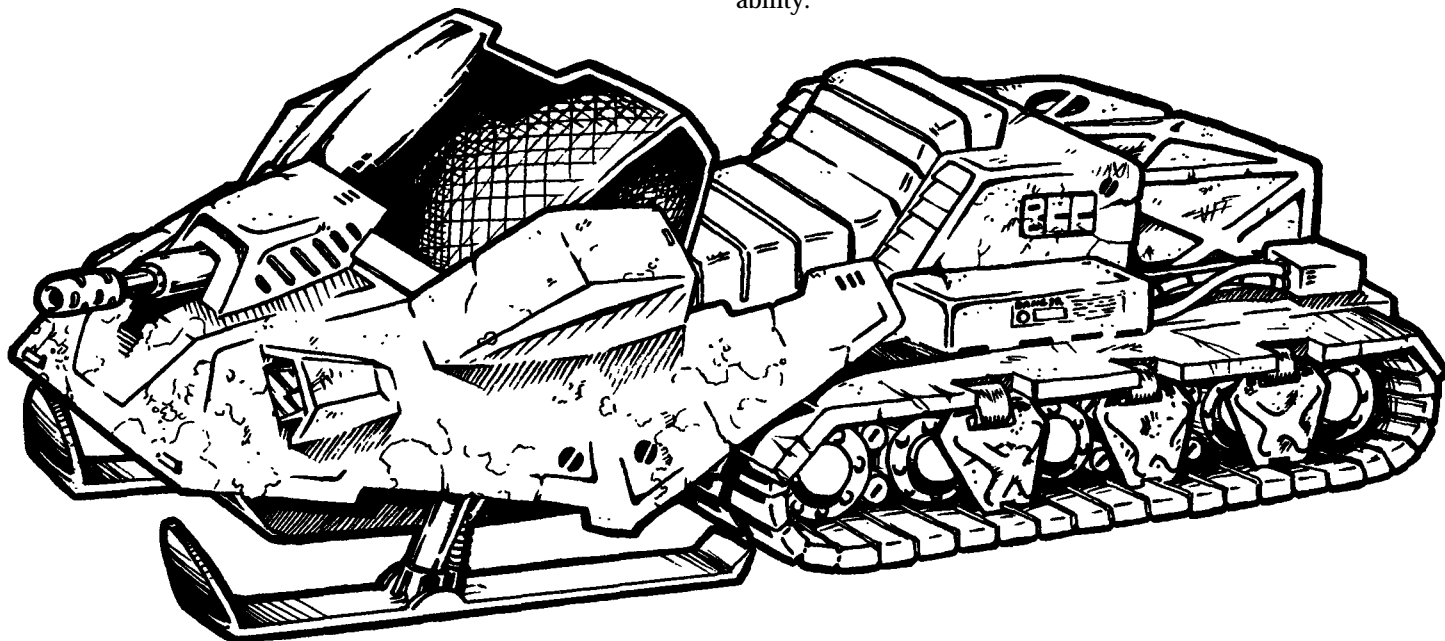

Note: As many as two light weapon systems can be built into the vehicle at extra cost, and up to 50 M.D.C. can be added at a cost of 5,000 credits per 10 M.D.C. Sold by the Black Market and Poles.

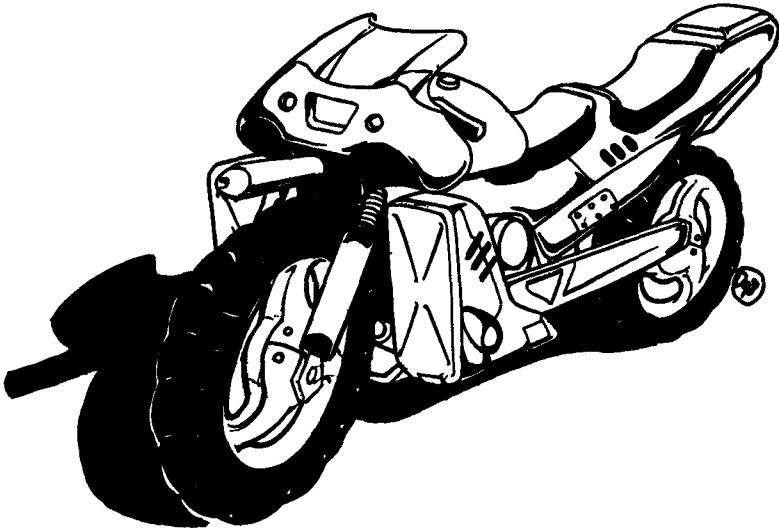

Tek-12 YY110 Bushbike

A favorite for general travel as well as military usage, the Bushbike is a heavy, solid-tire, combat motorcycle capable of excellent overland speed and mobility. The YY110 has one reverse speed as well as forward gears, and a dual shock absorption system that reduces potential damage to the chassis. They can be seen roaring heedlessly through thick forests, squashing through swampland, or rocketing up steep, rocky hillsides (up to 50° inclines). Bushbikes are used extensively by the Reavers of War Camps for patrols, reconnaissance, and combat, as well as by adventurers and mercenaries.

Tek-12 YY110 Bushbike

Model Type: YY110

Class: Overland motorcycle

Crew: One; pilot, and can hold another 'Borg sized passenger.

M.D.C. by Location:

* AR-36 Machinegun or Laser (1) — 30

* Mini-Missile Launchers (2) — 15

* Headlight (1) — 2

* Solid Tires (2) — each 45

Armored Windshield — 30

Armored Backrest — 30

** Main Body — 135

* Areas marked with an asterisk are small and difficult targets to hit, thus they can only be hit when a character makes a called shot and even then the attacker is -3 to strike. Many YY110 Bushbikes carry one spare tire strapped to the back.

** Depleting the main body will turn the bike into useless scrap.

Speed

Land: 137 mph (219 km) maximum with 60 mph (96.5 km) a typical cruising speed. Rugged, uneven terrain will reduce best speed by 30-50%.

Range: Liquid fuel: 350 miles (560 km); electric: 275 miles (440 km); nuclear: unlimited.

Leaps: Leaps 10 feet (3 m) high and 30 feet (9 m) across.

Statistical Data

Height: 3 feet (0.9 m)

Width: 2 feet (0.6 m)

Length: 7 feet (2.1 m)

Weight: 1,600 pounds (727 kg)

Capacity: One human-sized driver up to 7.6 feet (2.3 m) and 500 pounds (225 kg); suitable for partial and Light Machine 'Borgs, but full conversion cyborgs and Heavy Machines may be too large and/or heavy to use this vehicle.

Cargo: There is a small storage compartment in the rear with space for a rifle, backpack, and a couple of small items or packages. An additional 200 pounds (90 kg) can be strapped onto the Bushbike. It can also pull up to an additional 500 pounds (225 kg), typically in a side car or small, two wheeled, detachable trailer, but speed is reduced by 10% and there is a -5% piloting skill penalty.

Power Source: Internal combustion engine (alcohol and/or gasoline mix), electric, or nuclear.

Cost: 32,000 credits for a tripped down (no weapons) version and 65,000 credits for the fully loaded combat version with a liquid fuel or electric engine. Add 900,000 for a nuclear powered bike. Add 1500 credits for a sidecar or trailer with three M.D.C., or 10,000 credits for a sidecar or trailer with 20 M.D.C. Add 40,000 credits for the Blunderbus launcher.

Weapon Systems

1. **AR-36 Machinegun or Laser:** A fixed-forward mounted machinegun. Note: Nuclear powered bikes usually have a laser instead of the machinegun.

Primary Purpose: Defense

Secondary Purpose: Assault

Mega-Damage: Machinegun: A burst is 10 rounds and inflicts 1D6 M.D.; only fires bursts. If the laser is used, it does 2D6 M.D.

Rate of Fire: Equal to the number of combined hand to hand attacks of the pilot (usually 3-5).

Maximum Effective Range: 1,600 feet (487 m) for both the machinegun and the optional laser.

Payload: Machinegun: 800 rounds in a small ammo drum (80 shots).

Laser: Unlimited with nuclear power supply.

2. **Mini-Missile Launchers:** Set alongside the rear wheel on either side and pointing out and forward are a pair of mini-missile launchers (2 each). These can be launched by cyber-link or the press of a button.

Primary Purpose: Anti-Vehicle

Secondary Purpose: Assault

Mega-Damage: Varies with missile type, but typically Armor Piercing (1D4x10 M.D.).

Rate of Fire: 1, 2 or 4 missiles in a volley.

Maximum Effective Range: One mile (1.6 km).

Payload: Four total, two per each launcher.

3. **Optional Mini-Missile Blunderbuss Launcher:** The rear storage compartment can be replaced with a multi-shot mini-missile launcher known as the "Blunderbuss." Basic gear can be strapped to the bike or carried in saddlebags.

Primary Purpose: Anti-Vehicle

Secondary Purpose: Assault

Mega-Damage: Varies with missile type, but typically Armor Piercing (1D4x10 M.D.).

Rate of Fire: 1, 2 or 4 missiles in a volley.
Maximum Effective Range: One mile (1.6 km).
Payload: Twelve total.

4. Sensors and Features of Note: Communicator (10 miles, 16 km), **Cyber-Link**, and for night driving, the bike has its own passive **nightvision** optic screen with a 1,000 foot (304 m) range.

Note: The driver can also use his own hand-held weapons to attack while moving and driving with one hand, but with a piloting skill penalty of -20%.

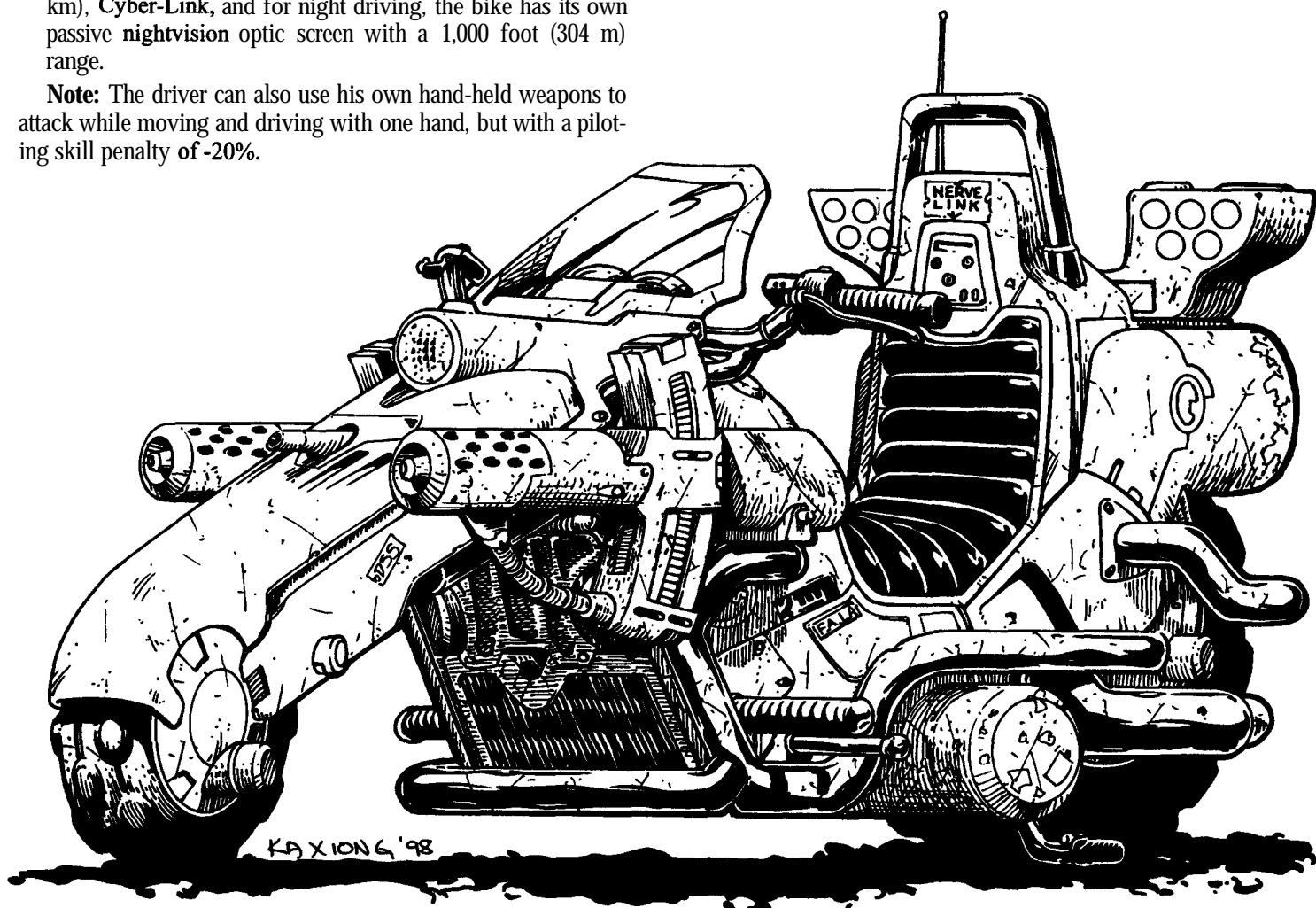

Tek-20 YY210 'Borgbike

The 'Borgbike is a big, burly, hulk of a motorcycle designed specifically for use by Heavy Machines and full conversion cyborgs of all kinds. It is an M.D.C. combat bike with heavy armor, serious weapons and a pair of jet boosters for greater speed and **thruster** assisted leaps. It can move forward or backward (1/4th top speed backwards), as the rider chooses.

When the jet boosters are engaged, a special turbine kicks in and propels the motorcycle to incredible speeds for short distances. When using this feature, the pilot *must* be **cyber-linked** to the vehicle or he is likely (-60% to pilot skill) to lose control and crash!

The 'Borgbike is used extensively by the cyborgs and Reaver Cavalry troops of the War Camps. Each Camp customizes their bikes with paint, decals, insignias, and other things that identify their particular War Camp and Warlord. The bike is also used by adventurers, mercenaries and large, heavy D-Bees.

Tek-20 YY210 'Borgbike

Model Type: YY210

Class: Overland Motorcycle

Crew: One; Pilot (May take up to one additional passenger of 'Borg size or smaller)

M.D.C. by Location:

AR-44 Rail Gun — 55

Missile Launcher (1, rear) — 60

* Forward Laser (1) — 20

* **Vibro-Lance** — 65

* Solid Tires (2) — 60 each

* **Headlight** (1) — 5

* Jet Thrusters (2, rear) — 30 each

Armored Windshield — 50

** Main Body — 216

* Areas marked with an asterisk are small and difficult targets to hit, thus they can only be hit when a character makes a called shot and even then the attacker is -3 to strike. Many YY210 'Borgbikes carry one spare tire strapped to the back.

** Depleting the main body will turn the bike into useless scrap.

Speed

Land: 204 mph (327 km) at top speed without thrusters, but cruising is a more sedate 85 mph (136 km). Rugged, uneven terrain will reduce best speed by 30-50%.

Range: Liquid fuel: 250 miles (400 km); nuclear: unlimited.

Jet Boost: Engaging the jet thrusters increases speed up to 350 mph (560 km) in two seconds (one melee action). This speed

can be maintained for up to 45 seconds (three melee rounds), after which the jet automatically turns off (needs one minute before it can be engaged again). **However**, for jet **thruster** assisted leaps, only **6-10** seconds are needed.

Frequent use of the jet **thrusters** is not a problem for nuclear powered bikes (70%), but they consume liquid fuel quickly and drivers can run out of gas if they don't keep careful watch — every **15** seconds of jet thrust uses up extra fuel and reduces the *range* by 10 miles (16 km).

Leaps: Normal Leaps are 8 feet (2.4 m) high and 20 feet (6 m) across, but jet thruster leaps can hurl the bike 30 feet (9 m) high and 100 feet (30.5 m) across.

Note: All attackers are -3 to strike the bike or driver when airborne or travelling over **200 mph** (320 km). The driver suffers a piloting skill penalty of **-10%** when travelling at speeds greater than 200 mph (320 km), plus penalties for trick maneuvers.

Statistical Data

Height: 4 feet (1.2 m) to handlebars; 6 feet (1.8 m) overall.

Width: 3 feet (.6 m) overall.

Length: 11 feet (3.3 m).

Weight: 2.1 tons.

Range: Liquid Fuel: 450 miles. Fuel capacity is 60 liters (a liter of jet fuel typically costs **10** credits). Nuclear: unlimited.

Capacity: One giant-sized driver, 7-10 feet (2.1 to 3 m) tall, driver and 1,500 pounds (675 kg); suitable for Light and Heavy Machines and most full conversion **'Borgs**.

Cargo: There is a small storage compartment in the rear with space for a rifle, extra **e-clips**, backpack, and a couple of small items or packages. Some additional items can be strapped onto the bike, but may get damaged during combat, and, if not secured carefully, may be torn off when thrusters are engaged. It can also pull up to an additional 1500 pounds (675 kg), but speed is reduced by **10%** and there is a **-5%** piloting skill penalty.

Power Source: Liquid fuel (30%) or nuclear (70%).

Cost: 185,000 credits for the fully loaded combat version with a liquid fuel engine, or 1.5 million for a fully loaded nuclear powered bike. Sidecars and trailers are not possible because they cause drag, imbalance and break off during jet boosted leaps and high speeds (**-30%** piloting skill penalty and a **01-50%** chance of breaking off when a sidecar is used).

Weapon Systems

1. AR-44 Rail Gun: It rests behind the rider's shoulder in a swivel bracket which can be pulled down for firing. The rail gun can also be aimed and fired via **Cyber-link** if desired.

Weight: 155 pounds (69.75 kg)

Primary Purpose: Anti-Personnel

Secondary Purpose: Anti-Vehicle

Mega-Damage: A burst is 40 rounds and inflicts **1D6x10 +10** M.D. Only fires bursts.

Range: 5,000 feet (**1522 m**)

Payload: Belt-fed ammo drum with 2,400 rounds (60 shots).

2. Short-Range Laser: Mounted in a fixed forward position is a high-powered, short-range laser; can be fired with the push of a button or via **Cyber-Link**.

Primary Purpose: Anti-Personnel

Secondary Purpose: Defense

Mega-Damage: 3D6 M.D. per shot.

Rate of Fire: Equal to the pilot's attacks per round, +1 if only

the laser is used the entire melee round.

Maximum Effective Range: 1200 feet (610 km)

Payload: Effectively unlimited if nuclear; otherwise has a generator pack with a 120 shot payload.

3. Mini-Missile Blunderbuss Launcher: Behind the drive, in the rear is a multi-shot mini-missile launcher known at the "Big Blunderbuss."

Primary Purpose: Anti-Vehicle

Secondary Purpose: Assault

Mega-Damage: Varies with missile type, but typically Armor Piercing (**1D4x10** M.D.).

Rate of Fire: **1, 2** or 4 missiles in a volley.

Maximum Effective Range: One mile (1.6 km).

Payload: Eighteen total.

4. Vibro-Lance: Mounted to one side of the front wheel is a retractable Vibro-Lance. In this case, it is a pointed, quadruple edged blade that can extend to 7 feet (2.1 m) in front of the bike. It is used for intimidating ground troops, all-out charges, rams and slashing and impaling ground troops (actually, most run or dive out of the way, losing two melee actions in the process).

Primary Purpose: Anti-Personnel

Secondary Purpose: Intimidation Factor (H.F. 12).

Mega-Damage & Special attacks:

Slash Attack: 2D6 M.D. +1D6 M.D. per 20 mph (31 km) of speed.

Impale Attack: **1D4x10 +1D6** M.D. per 20 mph (31 km) of speed. If the M.D.C. of the victim's body armor is not completely destroyed by an impale attack or impalement from an all-out charge, the armor holds (is not punctured through to the person inside), but is severely dented and cracked at the point of impact, and the victim of the impaling attack or all-out charge is thrown **2D4x10** yards/meters, loses three melee attacks/actions, and suffers **4D6 S.D.C./Hit Point** damage from the impact and fall (if a cyborg, robot, creature of magic, supernatural being or M.D.C. creature, there is no additional damage).

All-out charge/headlong rush: A favorite tactic of the **Warlords'** cyborgs and Cavalry Reavers who use this bike is to ride or jet-leap into a crowd or group of soldiers causing them to flee, creating confusion and, with any luck, slashing a number of them and impaling one. The driver always targets one for impaling but is **-3** to strike (due to the speed **and/or** leap and confusion); roll 1D20 to strike as normal. Whether the impalement is successful (damage above) or not, the all-out charge will cause the following damage:

- **1D6** M.D. to **1D4** characters struck by the bike or one person who has been hit and sent flying by the bike. Plus they lose three melee attacks/actions.
- Slash damage (as above) to **1D4** characters.
- All who run or leap out of the way lose two melee actions. Idiots who hold their ground and fire, or who are transfixed in horror and in the direct line of attack are automatically slashed. Those nearby are knocked off their feet and take **1D6** M.D.

Note: The all-out charge counts as three melee attacks and does **2D6** M.D. to the 'Borgbike and **1D6** M.D. to the Vibro-Lance.

Note: The driver can also use his own hand-held weapons to attack while moving and driving with one hand, but with a piloting skill penalty of **-20%**.

5. Sensors and Features of Note: Communicator (10 miles, 16 km), Cyber-Link, short-range radar (5 miles/8 km), bullhorn (300 ft/91 m effective range), spotlight (200 ft/61 m range), and for night-driving, the bike has its own passive **nightvision** optic screen with a range of 1,000 feet (304 m).

Landflier

A three wheeled ground and hover flight vehicle offered by the Black Market and the Poles. It is a sturdy, reliable all-terrain hover vehicle popular among explorers, couriers, adventurers and mercenaries. It has two seats (one behind the other), three retractable wheels (two in the rear, one in the front), dual forward lasers, and a storage compartment in the rear. The hover jets are built into the undercarriage, plus one in the nose of the vehicle and a pair of rear **thrusters** in the tail.

Landflier

Crew/Capacity: One human-sized driver plus one passenger up to 7.6 feet (2.3 m) tall and 1,500 pounds (675 kg); suitable for humans and full conversion cyborgs alike. A second small passenger may be squeezed in but the seating will be uncomfortable for all and causes a -10% piloting penalty.

M.D.C. by Location:

- * **Wheels/Tires** (3) — 8 each
- * **Headlights** (1; large, center) — 4
- * **Underbelly Hover Jets** (4) — 12 each

Nose Hover Jet (1) — 15

Rear Thruster Jets (2) — 35 each

Reinforced Windshield — 25

- * **Forward Lasers** (2) — 15 each

****Main Body** — 120

* Locations marked with a single asterisk are small **and/or** difficult targets to hit. Thus, they can only be hit when a character makes a *called shot* and even then, the attacker is -3 to strike.

** Depleting the M.D.C. of the entire main body will destroy the vehicle.

Speed

Ground/Wheeled Speed: 120 mph (192 km)

Hover Speed: 200 mph (320 km) maximum, but cruising speed is typically around 60 mph (96.5 km).

Hover Leaps: Capable of leaps up to 20 feet (1.8 m) high and 50 feet (15.2 m) across without actually getting airborne.

Range: Liquid fuel: 300 miles (482 km); nuclear: unlimited.

Statistical Data

Height: 3 feet (0.9 m)

Width: 3.6 feet (1.1 m), overall.

Length: 12 feet (3.6 m)

Weight: 1500 pounds (675 kg)

Power Source: Liquid fuel engine or nuclear.

Cargo: Rear cargo bay with space for winter survival kit, four backpacks, two bedrolls, and a handful of small items or packages. An additional 500 pounds (225 kg) can be strapped to the outside of the bike or slung in saddlebag compartments. Mounts in front of the compartment hold two rifles. The Landflier can also pull up to an additional 1000 pounds (450 kg).

Black Market Cost: 64,000 to 85,000 credits (cost is higher in remote regions) for the standard liquid fuel engine; poor availability (only about 20% have fuel engines).

1.2 million credits for the nuclear powered version with a 12 year life and effectively unlimited range; fair availability.

Note: As many as two light weapon systems can be built into the vehicle at extra cost, and up to 60 M.D.C. can be added at a cost of 5,000 credits per 10 M.D.C.

Weapon System

1. Dual Forward Lasers (2): A pair of stubby lasers are mounted in the nose of the Landflier. They are controlled by the pilot.

Primary Purpose: Defense

Secondary Purpose: Assault

Mega-Damage: 2D6 M.D. per single shot, or 4D6 per dual blast.

Rate of Fire: Equal to the number of hand to hand attacks of the pilot (usually 4-6).

Maximum Effective Range: 1,200 feet (610 m).

Payload: E-Pack with 100 shots if a fuel engine, or unlimited if nuclear powered.

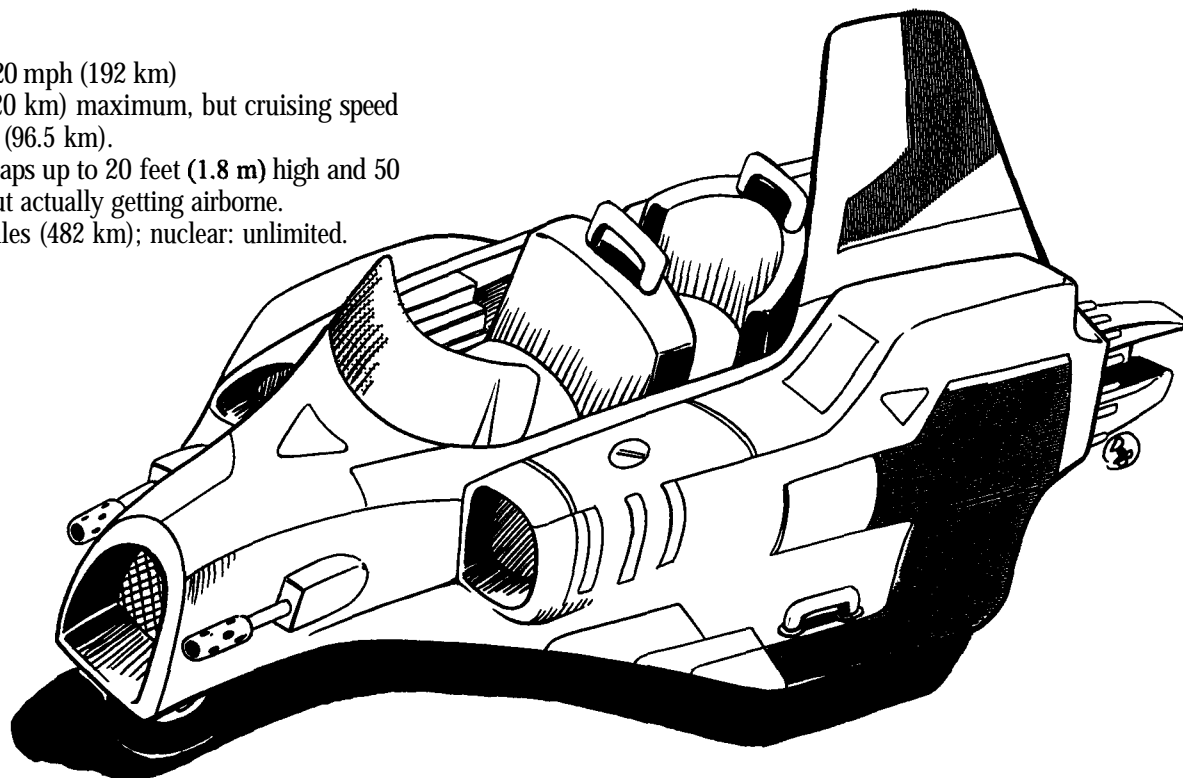

Warrior Assault Hoversled

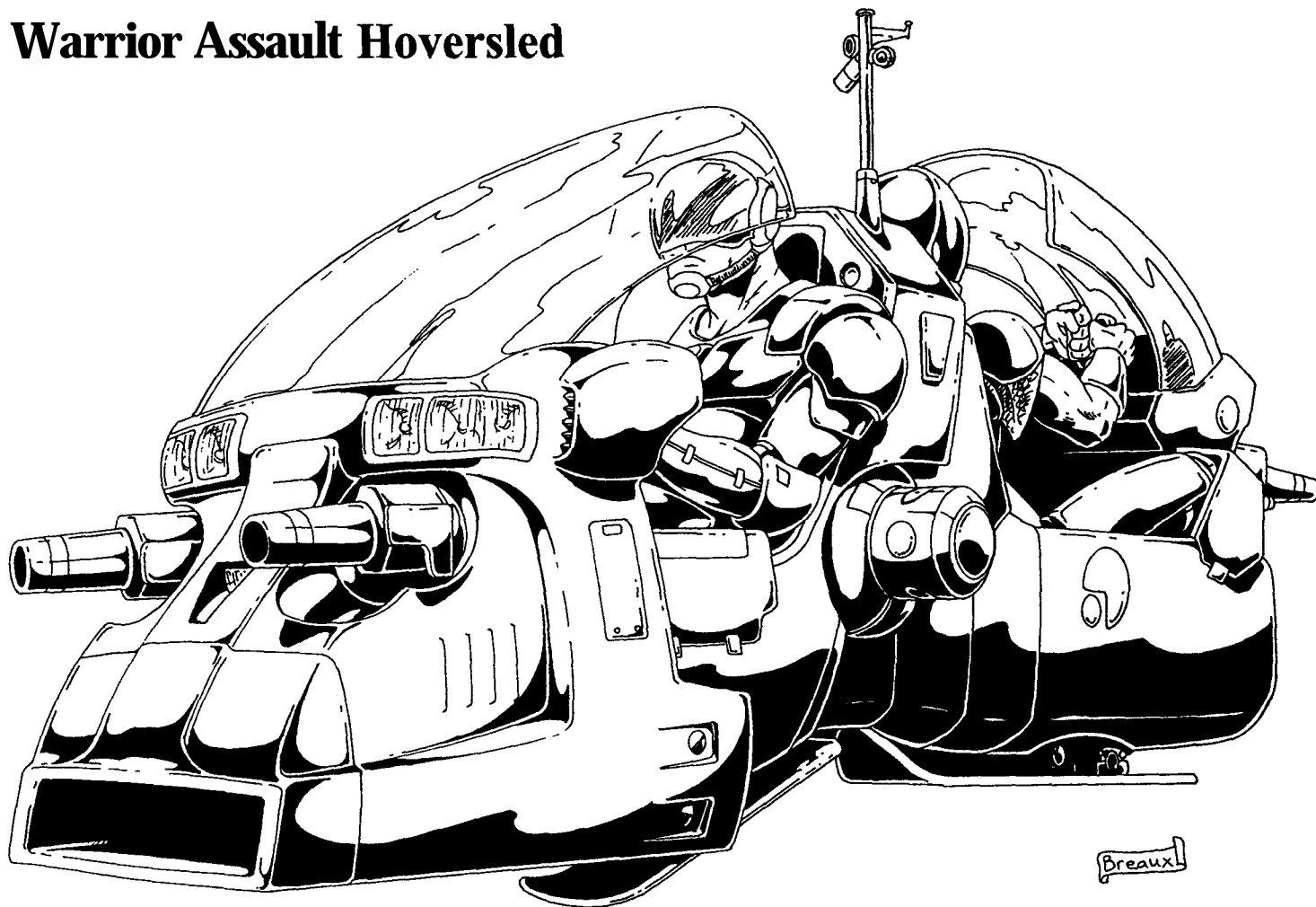

The Warrior Assault Hoversled is a quick, agile, all-terrain, land and air vehicle ideal for the long, snow-laden winters of the Ukraine, Russia and Siberia. It is fast and small enough to maneuver and function in congested environments with narrow passages and rugged terrain. The flight capability enables the pilot to be airborne whenever necessary and to perform vertical take-offs and landings (VTOL) in small areas (ideal for hiding too). The hover jets can rocket the vehicle along on snow and ice at astonishing speeds and enable the pilot to make breathtaking jumps that literally send him through the air without actually engaging the flight system.

As a "hover" vehicle, the Assault Hoversled can rise above the ground and fly up to 300 feet (91.5 m) high, although most of the daredevil Russian drivers typically fly only 2-3 feet (0.6 to 0.9 m) above the snow. Going airborne is also an excellent way to avoid leaving tracks. In fact, a favorite means of setting up an ambush is to deliberately leave a ski trail that suddenly vanishes (literally) into thin air. When that happens, anybody with knowledge about the Warlords and their Camps will suddenly realize that they have ridden (or are about to ride) into a trap and are probably surrounded, and certainly outflanked, if not outgunned.

The Assault Hoversled (also known as the AH-sled) comes in two sizes, one for ordinary humans and partial 'Borgs and one for the larger "Heavy Machines" (full conversion cyborgs, which means it can also be used by large, heavy D-Bees). Note that both versions of the Assault Hoversled are designed for *two riders* (three under cramped conditions and -10% piloting pen-

alty), although there is only one driver/pilot. Hundreds of thousands of AH-sleds are used by *all* the Warlords' Camps.

Warrior AH Assault Hoversled

Model Type: Light & Heavy Assault

Class: Hover assault vehicle

Crew: Two (or four, see above); pilot/gunner, gunner/navigator.

M.D.C. by Location: The first number is for the smaller light sled, the second is for the larger (by 20%), heavier version.

Laser Cannons (2) — 60 each — Heavy: 70 each

Manned, Rear Laser (1) — 40 — same

Mini-Missile Launchers (3) — 40 each — Heavy: 60 each

Raker Blades (2) — 40 each — Heavy: 50 each

* Skis (2) — 30 each — Heavy: 40 each

* Sensor Antenna (1) — 6 — Heavy: 10

* Rear Jets (2) — 50 each — Heavy: (3) 60 each

* Hoverjets (4) — 30 each — Heavy: (6) 30 each

* Forward Headlights (2) — 8 — same

* Underbelly Landing lights (4) — 6 each: same

Pilot's Windshield — 80 — Heavy: 90

** Main Body — 212 Light — 275 Heavy (for 'Borgs).

* Areas marked with an asterisk are small and difficult targets to hit, thus they can only be hit when a character makes a *called shot* and even then the attacker is -4 to strike. In addition, the fast moving, low profile vehicle is difficult to hit in the first place: Attackers are -1 to strike for every 50 mph (80 km) the AH-sled is travelling. This penalty applies to shooting the main body, pilot or passengers and is added to

the -4 penalty of small, difficult targets (thus hitting the hover jet of a sled travelling at 200 mph/320 km, is -8, while hitting the vehicle or pilot is -4). **Note:** The pilot or passenger firing hand-held weapons from a moving vehicle also strikes with a penalty of -1 per 50 mph (80 km), but no such penalty applies to weapons built into the Assault Hoversled.

** Depleting the main body will shut the hoversled down completely, making it useless.

Speed: Both versions of the sleds have the same speeds.

Air: Top speed is 306 mph (490 km). Cruising speed is 120 mph (192 km); maximum altitude is 300 feet (91.5 m).

Ground: 220 mph (352 km) on snow and/or ice, although speeds under 150 mph (240 km) are more usual. The "sled" cannot slide on dry ground without damaging the ski blades and undercarriage (maximum speed is 40% normal), but it can hover and fly above it, using the skis as landing gear.

Statistical Data

Height: Light: 3 feet (0.9 m)

Heavy: 4 feet (1.2 m)

Width: Light: 3.6 feet (1.1 m)

Heavy: 5 feet (1.5 m)

Length: Light: 7 feet (2.1 m)

Heavy: 10 feet (3 m)

Weight: Light: 2 tons — Heavy: 3.6 tons.

Cargo: Minimal space, but can carry or pull 1000 pounds (450 kg) of weight in addition to the pilot and passenger (estimated to be 500 to 800 lbs./225 to 360 kg).

Power System: Varies: Liquid fuel with a range of 325 miles (520 km) for the light sled, 400 miles (640 km) for the heavy sled.

Electric battery and solar power system with a range of 210 miles (336 km) for the light sled, 300 miles (480 km) for the heavy sled.

Nuclear, with effectively unlimited range; 10 year life.

Availability: Only the Warlords and the members of their Camps have "official" access to these combat vehicles (issued to deserving warriors under the Warlord's service). Others use them illegally.

Black Market Cost: The Black Market and gutsy Polish manufacturers offer illegal versions of this vehicle at the prices below.

Liquid Fuel engine, Light AH-Sled: 900,000 credits.

Electric/Solar powered, Light AH-Sled: 1.1 million credits.

Nuclear powered, Light AH-Sled: 2.2 million credits.

Note: Add 600,000 credits for the heavy version, regardless of the power system.

An inexpensive, Mega-Damage, noncombat version (no built-in weapons) is available in the gasoline model, which is also produced at the low, low cost of 380,000 Universal Credits. It has 105 M.D.C. for its main body, and most other specific location/parts of the vehicle have the same M.D.C. as the light version sled. Fair to poor availability. The Warlords are not happy with the availability of these knock-offs.

Weapon Systems

1. Guraskov G-110 Laser Pulse Cannons (2): Thick-bodied Guraskov laser cannons are mounted in the front armored section. They can swivel up and down 45 degrees in all directions.

Primary Purpose: Assault/Siege

Secondary Purpose: Defense

Mega-Damage: 5D6 M.D. per single dual pulse blast or 1D6x10 M.D. for a simultaneous, dual burst from both guns at the same target.

Maximum Effective Range: 3,000 feet (914 m).

Rate of Fire: Each single or dual blast counts as one of the pilot's melee attacks/actions.

Payload: Powered by either an e-clip with 20 pulse blasts each or 50 blasts each from a mini-generator (recharges at a rate of one blast every two minutes). Effectively unlimited if the sled is nuclear powered.

2. Manned AR-60 Rail Gun or Laser Gun: The weapon is set in a low swivel mount at the rear of the Assault Hoversled, behind the passenger seat. The gunner must twist (-1 to strike) or turn around completely to fire it, but can stay buckled into his passenger's seat harness (a necessity when traveling at high speeds) or it can be fired from the forward HUD fire control unit if desired (at -3 to hit).

Primary Purpose: Anti-Personnel

Secondary Purpose: Defense

Mega-Damage: The sled will have only one gun or the other, not both, so pick one.

Rail Gun: A burst is 10 large shells and inflicts 1D4x10+10 M.D.; only fires bursts.

Laser Gun: 3D6 M.D. per blast.

Rate of Fire: Equal to the number of attacks per melee of the gunner; each blast or burst counts as one melee action.

Maximum Effective Range: Rail gun 4,000 feet (1200m), or laser 2,000 feet (610 m).

Payload: Rail Gun: A belt-fed ammo drum with 1,200 rounds (120 shots).

Laser: 20 per G-Clip (side mounted E-clip) or effectively unlimited if nuclear.

3. Mini-Missile Launchers (3): Three separate mini-missile launchers are built into the sled, two on the sides and a third in the rear of the vehicle behind the passenger. When preparing to fire, an iris-swivel opens in the front of the launch tube. This can be a clear sign in the battlefield that the hoversled is about to fire its missiles. Anyone who understands its significance (assuming they notice it) is granted an additional +2 to dodge/roll with impact. The launchers don't impede the sled in any way.

Primary Purpose: Anti-Personnel

Secondary Purpose: Support

Mega-Damage: Varies with missile type (5D6, 1D4x10, or 1D6x10 M.D., or silver flechette that does 3D6 M.D. to humans but 1D6x10 M.D. to vampires and supernatural beings vulnerable to silver, or smoke).

Rate of Fire: 1, 2 or 4 missiles in a volley.

Maximum Effective Range: One mile (1.6 km).

Payload: 18 total, six per each launcher.

Note: Destroying the missile launcher has the possibility of detonating all the missiles, but its only a 01-20% chance.

4. Raker Blades (2): A pair of giant vibro-blades that unfold beneath the Assault Hoversled to rake those beneath in high-speed strafing runs. Each blade is 5 feet (1.5 m) long.

Primary Purpose: Anti-personnel

Secondary Purpose: Support

Mega-Damage: 4D6 M.D. per blade from a fly-by raking strike.

5. The Passenger can attack with hand-held weapons or use the rear gun.

6. Sensor Systems of Note: HUD, short-range directional communications system: 20 miles (32 km), bullhorn: 400 feet (122 m) and special sensor antenna for mini-radar system (can identify and track up to 20 aerial targets), extended radio communications (adds 20 miles/32 km) and Cyber-Link.

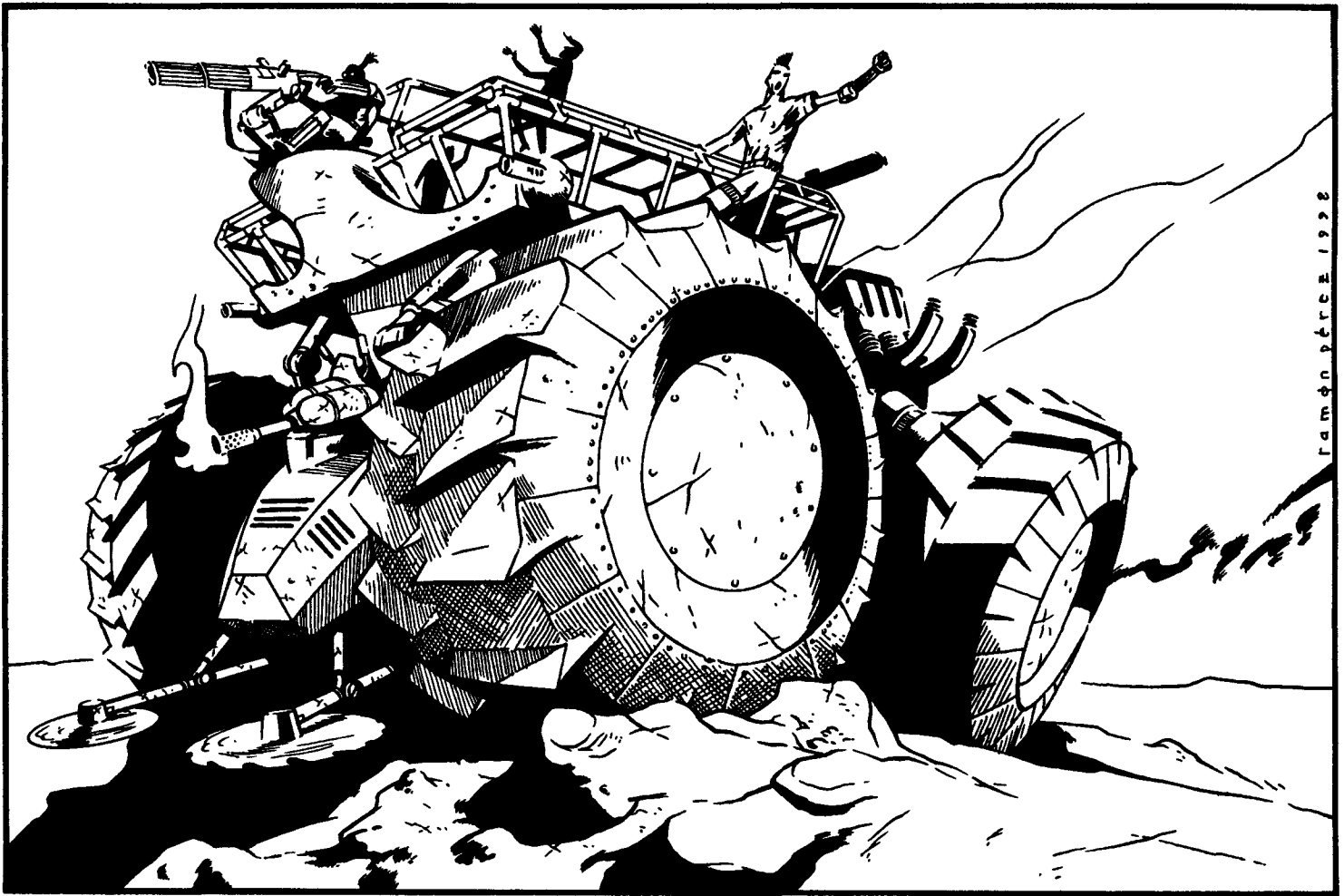

War Chariot

Somewhat of a misnomer, the War Chariot is actually a modern war machine of fearsome appearance. It is a huge, four-wheeled monstrosity. Each wheel is eight feet (2.4 m) in diameter and four feet (1.2 m) wide. They are each made of Mega-Damage ceramics and metal, fitted with short blades (4 ft/1.2 m long) across the face of the rolling tire surface. These are designed to chop up anything in its path (fences, walls, small vehicles, ground troops, etc.) and are capable of grinding a 'Borg to scrap with only a few passes! One might think of the War Chariot as a giant tractor with attitude — typically manned by a pack of 5-6 shrieking Reavers, blasting away at the enemy.

The pilot's compartment is hidden within a heavily armored, sealed compartment hung low between the wheels. The pilot area is small, but comfortable, and is equipped with the main weapon systems and controls (completely with Cyber-Links and HUD systems). The drivers of these vehicles are often thought of as being a little "touched in the head," and tend to be some of the most savage, merciless and often psychotic members of the Reaver Cavalry (3rd to 8th level is the average range of experience). With its M.D.C. wheelgrinder and battery of weapons, a squad (5-10) can "pulp" the average village, D-Bee tribe or band of demons in short order.

Passengers are seated or hang on to the heavy metal framework (with roll bars) of the main body above the fortified pilot's compartment. The top of a War Chariot is a metal cage for Reavers to hang on to, with armored barriers (M.D.C. plates) to crouch behind. Reavers assigned to War Chariots delight in striking with **Vibro-Blades** as well as energy weapons. Many take insane chances, hanging over the edges to swing or shoot at opponents. Anyone who loses his grip and falls under the wheels (-4 to dodge or roll) doesn't have to worry about being made fun of afterwards by his companions.

This big wheeled vehicle is especially effective in cultivated lands, urban settings, light forests, grasslands and the steppes, but has difficulty on steep, rocky land and is completely defeated by thick forests (too much heavy vegetation and trees). It is used by *a*/Warlord Factions.

Warlord War Chariot

Model Type: Standard chassis for all Warlord sales.

Class: Armored Infantry Vehicle

Crew: One pilot, plus 4-5 Reavers, partial or full conversion 'Borgs hanging from the outer cage. In a pinch, or when used as a troop transport, 10 additional warriors can cling to the cage, but in combat, more than five get in each other's way and there is insufficient protection for each.

M.D.C. by Location:

- * **AR-210** Rail Guns (2) — 80 each
- * Flamethrower Cannon — 30
- * Forward Lasers (2) — 20 each
- * Dual Buzz Saw — 100 each
- M.D.C. Armored Wheels (4) — 200 each
- Reinforced Pilot's **Compartment/Cabin** — 200
- Hatchway to Pilot's Compartment — 75
- Armored Barriers (5) — 100 each
- Heavy Cage & Bars (overall structure) — 300
- ** Main Body — 550

* Areas marked with an asterisk are small and difficult targets to hit, thus they can only be hit when a character makes a called shot and even then the attacker is -3 to strike.

** Depleting the main body will shut the War Chariot down completely, rendering it useless. Special Note: Because of its position between the four wheels, an unmodified roll of at least 16 is necessary to hit it!

Speed

Land: Top speed is 110 mph (176 km). Cruising is a more sedate 60 mph (96 km).

Flight: Not possible

Underwater: Not possible, however, the vehicle can drive through water up to four feet (1.2 m) deep.

Statistical Data

Height: 12 feet (3.7 m) to the assault platform above the pilot's compartment. Wheel Height: 8 feet (2.4 m).

Width: 14 feet (4.3 m); Wheel Width: 4 feet (1.2 m).

Length: 18 feet (5.5 m)

Weight: 10 tons

Cargo: The chariot has a storage bay (60 M.D.C.) on the outside of the pilot's compartment for rifles, extra ammo, grenades, and canteens.

Power System: Liquid fuel (40%) with a 200 mile (352 km) range, or nuclear (unlimited).

Weapons

1. Giant Wheels: These big, blade-lined wheels crush and grind everything in their path.

Primary Purpose: Anti-Personnel

Secondary Purpose: Utility/ground clearing, field plowing, etc.

Mega-Damage: Anyone caught beneath the wheels will automatically take 1D4x10 M.D.

Maximum Effective Range: Impact.

2. Manned AR-210 Rail Guns (2): There are a pair of open-air, swivel rail gun unit on top of the cage. Each operator is seated and has hand and foot controls that enable him to rotate the gun 360 degrees with a 50 degree arc of fire, up and down.

Primary Purpose: Anti-Armor

Secondary Purpose: Anti-Personnel

Weight: 500 pounds (225 kg) each.

Mega-Damage: A burst is 30 rounds and inflicts 2D4x10 M.D. per rail gun. Both guns are manned and fired separately; both cannot fire at the same target simultaneously.

Rate of Fire: Equal to the number of combined hand to hand attacks (usually 4-6) of each gunner.

Maximum Effective Range: 4,000 feet (1200 m)

Payload: 3,000 rounds per each gun (100 shots each).

3. Flamethrower: Mounted on top of the pilot's compartment is a manned flamethrower cannon. It is an upright swivel mount that can turn 360 degrees and has a 45 degree arc of fire, up and down. Typically a Light or Heavy Machine 'Borg stands and fires it, raking targets where opportunity permits. Reavers often trade off this duty.

Weight: 300 pounds (135 kg)

Primary Purpose: Anti-personnel

Mega-Damage: A single shot inflicts 2D6 M.D., a long spray (counts as a burst and uses two melee actions) does 4D6 M.D.; each blast has a 01-70% likelihood of setting combustibles on fire.

Maximum Effective Range: 800 feet (244 m).

Rate of Fire: Equal to the number of combined hand to hand attacks (usually 4-6) of the gunner.

Payload: 100 single shots or 50 long sprays/bursts.

4. Short-Range Lasers: Mounted in a forward position is a pair of high-powered, short-range lasers. They can move up and down in a 45 degree arc of fire, and can be fired with the push of a button or via **Cyber-Link**.

Primary Purpose: Anti-Personnel

Secondary Purpose: Defense

Mega-Damage: 3D6 M.D. per single blast or 6D6 M.D. per simultaneous dual blast (counts as one melee attack).

Rate of Fire: Equal to the pilot's attacks per round.

Maximum Effective Range: 1200 feet (610 km)

Payload: Effectively unlimited if nuclear; otherwise has a generator pack with 120 shot payload.

5. Dual Buzz Saws (2): A pair of large (4 ft/1.2m in diameter), M.D.C. Buzz Saws are mounted below the pilot's compartment and can be extended forward about four feet (1.2 m) and lowered down as low as two feet (0.6 m) to about five feet (1.5 m) above ground.

Primary Purpose: Anti-Armor & Barriers

Secondary Purpose: Anti-Personnel

Mega-Damage: 4D6 M.D. per cut of the blade.

6. Sensor Systems of Note: HUD, short-range directional communications system: 20 miles (32 km), bullhorn: 400 feet (122 m) and special sensor antenna for mini-radar system (can identify and track up to 20 aerial targets), extended radio communications (adds 20 miles/32 km) and Cyber-Link.

War Wagon/Mechanized Ram

This frightful creation blends heavy mechanization with savage practicality. A War Wagon is a large troop **carrier/APC** that runs on six pairs of solid-construction, spiked wheels (6 axles). There is a blast door on either side in the exact middle, as well as one in the rear. The top sections have low railings for troops to hold onto, or kneel and fire, using the railing to steady the weapon. Reavers and soldiers pile on top of the APC during parades and grand entrances, holding weapons aloft in a show of strength. The vehicle may also be festooned with war banners, as well as the skulls of humans, D-Bees and monsters, and sometimes, even corpses!

The War Wagon is designed to breach enemy fortifications and run enemy vehicles and troops off the road with its huge, V-shaped, hydraulic ram. The ram fires with a punching motion at the moment of impact to intensify the battering force of the ramming vehicle.

Similar to ancient Clipper ships, the War Wagon has a bank of ion cannons on both sides. Each of these small, low profile turrets can be tilted up and down 45 degrees and turn 90 degrees right and left. They are used to deliver punishing broadside attacks, especially when driving down a street and blasting buildings on either side.

Inside the War Wagon there is a full bridge section which accommodates up to one Commander/pilot, one co-pilot, one navigator, one communications officer, one weapons officer, one field doctor or scientist, and one Heavy Machine cyborg. The bridge controls all the vehicles functions, including the main guns. Behind this is a long troop compartment area and the gunnery mounts, and two gunnery crewmen. Additional troops, particularly full conversion cyborgs, can also ride on the outside of the APC.

The drawbacks of the War Wagon are its size and comparatively low speed. Most Reavers, warriors and knights of the War Camps prefer fast vehicles ideal for raids and hit and run tactics. The large APC is long, slow and ponderous, making it annoying for the speed demons in the Camps, an easy target and limited to comparatively flat and even terrain (ideal for urban settings). The Warlords do have a fond place for BIG war machines as well as small, fast ones, but War Wagons have limited applications and are sometimes caught up in rocky or rough terrains, bogged down in swamps, and travel poorly in woodlands, get stuck in deep snow, and generally get stuck more often than their operators would like. War Wagon crews joke about this among themselves, but bristle if someone else mentions it. Still, against an entrenched and fortified enemy, city, or village, as well as against foot soldiers and operations in the steppes and other lowlands, the War Wagon is excellent. They are also good for short-range transport and city defense.

War Wagon/Mechanized Ram

Model Type: None

Class: Armored Personnel Carrier and Assault Vehicle.

Crew: Pilot/Commander, Co-Pilot, Navigator, Communications Officer, Weapons Officer, and one Heavy Machine. The War Wagon can be driven by a single **cybernetically-linked** pilot at -20% if necessary.

Troop Complement: Varies with military needs. Can accommodate up to one full platoon of 40 human troops (50 in cramped conditions) plus 10 Light Machines and 10 Heavy Machines (a standard complement), or 40 human troops and 25 Light Machines, or 50 Light Machines, or 36 Heavy Machines.

M.D.C. by Location:

Ion Turrets (20 total, 10 on each side) — 50 each

* Manned Rail Gun Turrets (2) — 100 each

* Laser Cannon Turrets (2) — 50

* Mini-Missile Turrets (2) — 30

Medium-Range Missile Launcher (1) — 100

* Solid Construction Wheels (12) — 75 each

Blast Doors (3; two sides, 1 rear) — 150 each

Headlights (4, front) — 3 each

* Spotlights (4, two front/two back) — 6 each

Hydraulic Ram — 500

Bridge/Pilot's Compartment — 100

** Main Body Forward Section — 400

** Main Body Troop Section — 800

* Areas marked with an asterisk are small and difficult targets to hit, thus they can only be hit when a character makes a called shot and even then the attacker is -3 to strike.

** Depleting the main body of the forward section will shut the War Wagon down but the troop section remains intact and the troops safe; blast doors can be opened manually, and the rail guns can also be manned. Destroying both main body sections reduces it to twisted scrap.

Speed

Land: Top speed is 70 mph (112 km). Cruising speed is a more sedate 40 mph (65 km). Pilots try to choose routes with the least terrain resistance. Forests and rugged terrain will cut maximum speed in half or lower, and dense forests and rocky terrain cannot be traveled at all. The War Wagon can crunch through quite a bit but elevation differences and rough terrain will prove hazardous.

Flying: Not Possible

Water: None; the War Wagon is not amphibious.

Statistical Data

Height: 17 feet (5 m)

Width: 18 feet (5.5 m)

Length: 90 feet (27.4 m)

Weight: 150 tons

Cargo: There is a small storeroom aft, capable of holding a total of 2 tons. The APC can carry/pull a total of 110 tons.

Power System: Liquid fuel (30%) or nuclear (70%).

Note: This vehicle is used extensively by the **Burgasov**, **Orloff**, and **Sokolov** Camps, and to a lesser degree, the **Seriye** Camp.

The **Sovietski** has 432 slightly modified War Wagons, painted in traditional black and red. They are used primarily in Urban defense.

Weapon Systems

1. Ion Turret Banks (20 total): Small turrets on the top of the vehicle run along both sides. Each turret can tilt up and down 45 degrees and turn 90 degrees right and left. They can be fired in pairs or ten at a time. Each bank of ten is controlled by its own gunner. They are most effective against large targets such as the sides of buildings, large vehicles, giant robots and monsters, and large numbers of people/ground troops. War Wagons are often deployed to lay siege to cities and fortified encampments.

Primary Purpose: Barrage and Anti-Fortifications.

Secondary Purpose: Anti-Personnel

Mega-Damage: 3D6 M.D. per individual blast, 6D6 M.D. per twin blast. No more than two blasts can hit a human-sized target up to 8 feet (2.4 m) tall, even when in a crowd (the difference being others in the crowd are also struck). 1D4 shots from a broadside blast will hit a small, fast vehicle such as a hovercycle or jetsled, or fast moving Heavy Machine. 1D4+2 will hit a vehicle, 'Borg or monster the size of a sedan, and 1D4+6 blasts will hit the side of a building, bunker, cargo truck, ship or similarly large vehicle.

Rate of Fire: Two at a time or the full bank of ten, equal to the number of attacks of the gunner (typically 4-8).

Maximum Effective Range: 1,200 feet (366 m)

Payload: Effectively unlimited if nuclear, 100 per turret if powered by a multi-generator pack system common to liquid fuel vehicles.

Note: The ten turret broadside is only effective against buildings, bunkers, tanks, giant robots and other large (ideally stationary) targets. These small turrets cannot point forward.

2. Manned Rail Gun Turrets (2): On the top, toward the front sides of the War Wagon are manned rail guns. They are used to protect troops as they enter and exit the vehicle. Each has a small hatch so they can be accessed from inside the APC.

Primary Purpose: Defense

Secondary Purpose: Anti-Personnel

Mega-Damage: A burst is 10 shells and inflicts 1D4x10 M.D.

Maximum Effective Range: 4,000 feet (1,200m)

Payload: 2,000 rounds (200 shots) each.

3. GU-SO Series Support Laser Cannon Turrets (2): Mounted in the middle of the APC are a pair of laser turrets. Each can rotate 360 degrees and has a 90 degree arc of fire.

Primary Purpose: Assault/Support

Mega-Damage: 6D6 per blast, per cannon, or 1D6x10+10 from simultaneous blasts from both.

Rate of Fire: Equal to the number of combined hand to hand attacks (usually 4-6) of the operator.

Maximum Effective Range: 4,500 feet (1,371 m)

Payload: Effectively unlimited if nuclear, 200 per cannon if powered by a multi-generator pack system common to liquid fuel vehicles.

4. Mini-Missile Turrets (2): Mounted on top, these squarish launchers can rotate in any direction to unleash clusters of missiles at the enemy.

Primary Purpose: Anti-Vehicle

Secondary Purpose: Support

Mega-Damage: Varies with missile type.

Rate of Fire: 1, 2 or 4 missiles in a volley.

Maximum Effective Range: About one mile (1.6 km).

Blast Radius: Varies

Payload: 80 total; 40 per each launcher.

5. Medium-Range Missile Launcher (1): Mounted in the back end, above the rear exit hatch.

Primary Purpose: Anti-Vehicle

Secondary Purpose: Support

Mega-Damage: Varies with missile.

Rate of Fire: 1, 2 or 4 missiles in a volley.

Maximum Effective Range: About 20 miles average (32 km).

Blast Radius: Varies

Payload: 24

6. Hydraulic Ram System: In the nose of the vehicle, the large V-shaped ram runs a quarter of the length of the War Wagon, sort of a bottom-spinal mount. The ram slides back, then shoots forward at the moment of collision for extra destructive power. This is used to breach the walls of the enemy and as such, can end up doing some damage to the APC itself. When a "run" is started, a claxon will sound in the troop compartment and everyone who is capable of it, straps in. The pilot will start a countdown computer going so everyone knows when the collision is coming. Any ordinary humans, not harnessed up, even those clad in body armor, will find themselves airborne and suffer 2D6 M.D. from impact in the collision.

Primary Purpose: Siege

Secondary Purpose: Anti-vehicle

Mega-Damage: 2D4x10 M.D. +20 M.D. per 20 mph of speed.

Damage to the War Wagon: The APC suffers 1D4x10 M.D. to the ram.

Rate of Fire: One; uses up 10 to 15 seconds and all but one of the pilot's attacks for that melee round.

7. Sensor Systems of Note: Gromeko battle computer, holographic optics, HUD, enviro-360 sensor screens, full communications suite with a range of 100 miles (160 km), radar to 50 miles (90 km; registers up to 64 different targets simultaneously), four spotlights (300 ft/91 m), loudspeaker (600 feet/182.8 m) and Cyber-Links for the pilot, co-pilot and gunners.

8. Features: Hydraulic Bracers/Boarding Ramps: Hydraulic ramps and bracers extend and retract to allow easy entrance and exit of troops and small vehicles; the rear hatch is a "jump" hatch (no ramp, must hop in and out). They can be tilted up or down 20 degrees.

Warthrone

The Warthrone is a low altitude hover vehicle with a low speed, because it is designed as a showpiece and mobile stage from which the Warlord can address his troops, make speeches and participate in celebrations with, but at the same time removed from, his people. These pageant pieces are an insidious lure to Warlord egos and each and every one has one plus two spares.

The Warthrone is a large hover-platform that resembles a rather flat flying saucer with a large throne on top. There is plenty of room for the giant throne/seat (where the Warlord sits) and as many as a dozen others (standing or kneeling), but the standard complement is two trusted guards on either side of the throne (typically Heavy Machine cyborgs, psychics or mages), plus 2-4 advisors, aides, and/or honored heroes. The back of the throne rises 15 feet (4.6 m), tapering to a metal double-edged knife point. Next to it, on each side, are flagpoles for flags and standards of the Warlord and his Camp. In case of an emergency, a panel opens up in the floor in front of the throne, offering the Warlord a safe compartment (100 M.D.C.) where he can hide. The sides of the Warthrone are often decorated for show with shields, skulls, and designs.

Recessed in what is the front section of the flying disk (10 ft/3 m in front of the throne) is a pilot, and two gunners, each with his own small compartment, controls and clear bubble canopy (their heads barely show above the floor of the hover disk). The two gunners each control one of the weapon arms built into the front section of the undercarriage, while the pilot does the driving. In addition, it packs missiles and other surprises, plus is typically escorted by 24-48 elite guards on hovercycles, Wingriders, jet packs or other flying vehicles or power armor.

The Warthrone is an important consideration in understanding the Warlords themselves — a display of their power and open defiance of the world around them. In battle, the symbol of the Warthrone, hanging defiantly in mid-air, gives the War Camp encouragement, inspiration and energy. Reavers and Knights of the Realm often chant war songs as they march with the Warthrone into war (with the Warlord usually only going a short way and nowhere near the battle zone).

Warthrone

Model Type: Military Hover Platform

Class: Mobile Command Platform

Crew: Three; a pilot and two gunners, plus the Warlord and his entourage.

Troop Complement: 24-49 escorts, but more may be assigned depending on the situation.

M.D.C. by Location:

* Concealed Forward Lasers (4) — 35

* Concealed Underbelly Lasers (10) — 20 each

Weapon Arms (2) — 150 each

Mini-Missile Launchers (2; top) — 100 each

Medium-Range Missile Launcher (1; Underbelly) — 120

* Pilot & Gunner Canopies (3) — 50 each

* Spotlights (5; underbelly) — 10 each

* Sensor Antennas (2) — 10 each

Rear Booster Jets (2) — 60 each

* Hover Jets (6 large; undercarriage) — 90 each

Armored Throne (1) — 450

* Warlord's Hidden Chamber (1) — 100

** Main Body/Platform — 900

* Areas marked with a single asterisk are small and/or difficult targets to hit. Thus they can only be hit when a character makes a called shot and even then the attacker is -4 to strike. Knocking out one hover jet will reduce the Warthrone's speed by 15%, knocking out two will reduce it by 30%, four by 75%, plus it will wobble; maximum altitude is 20 feet (3 m) and piloting is done at a -40% penalty — it is best to land. Please note that the hover jets are actually quite large, but are mostly buried in the body of the platform, making them hard to hit.

** Depleting the main body will cause the Warthrone to crash and render all systems useless.

Defense & Weapon Notes: The pilot and gunner's control compartment is recessed inside the top of the flying disk and thus protected by the main body. Blasting into the control panels (assuming the locking bubble canopy has been destroyed) will fry the controls when 30 M.D.C. has been inflicted. Unknown to most, the Warlord can also pilot the disk and fire the missiles and lasers using concealed control panels in his throne. The throne also conceals a compartment that contains a first-aid kit, a pair of **Vibro-Blades**, a Type Two Fusion Block, six grenades, and an energy rifle of the Warlord's choice. Further note that the Warlords usually make their appearance in full military regalia, complete with environmental body armor, weapons and perhaps even a jet pack or power armor.

Speed

Air: Hover to 68 mph (109 km), Cruising 40 mph (65 km). The Warthrone can achieve an altitude of just 100 feet (30.5 m). It normally hovers only 15-20 feet (4.6 to 6 m) above the ground.

Statistical Data

Height: The disk part of the body is 8 feet (2.4 m) thick/tall from top to bottom, with the clear pilot and gunner canopies extending another two feet above the flat surface of the deck top, but the throne and flagpoles add another 15 feet (4.6 m) for an overall height of 23 feet (7 m).

Width & Length: 25 feet (7.6 m) in diameter; a circular disk.

Weight: 23 tons fully loaded.

Cargo: Not designed to carry cargo, although it can handle about nine tons.

Power System: Nuclear with a 25 year life span.

Warlord Cost: 6-10 million depending on how ornate the individual platform. Only about 40 Warthrones are in existence, and all are the exclusive property of the Warlords of Russia.

Weapons System

1. Concealed Forward Lasers (4): Four powerful, medium-range lasers are concealed by sliding panels in the front of the disk (pointed in the direction that the throne faces). Each is fixed forward and fires straight ahead so the hover platform must rise or lower itself entirely, and/or dip or elevate the front section to hit targets not directly in its horizontal path. They are controlled by the pilot or the Warlord.

Primary Purpose: Defense

Mega-Damage: A single blast does 3D6 M.D., two 6D6 M.D., three 1D4x10+10 M.D., and all four do 1D6x10+10 M.D.

Rate of Fire: Once per Combat Round (15 seconds).

Maximum Effective Range: 1,200 feet (366 m)

Payload: Effectively unlimited.

2. Concealed Underbelly Lasers (10): Ten light lasers are concealed in the underbelly to literally "rain" death and destruction from above. This is especially effective against large crowds and ground troops. The lasers can be made to shoot in a random sequence straight down, or all at a 10-40% degree angle.

Primary Purpose: Barrage and Anti-Personnel

Secondary Purpose: Defense

Mega-Damage: 2D6 M.D. per individual blast, 4D6 M.D. per twin blast. No more than one blast can hit a human-sized target up to 8 feet (2.4 m) tall, or small vehicle like a hovercycle, even when in a crowd (the difference being several others in the crowd are also struck). 1D4 blasts will hit animals the size of a horse or larger, and vehicles the size of a sedan or small truck. Large vehicles and structures the size of a semi-truck and trailer, tank or APC will be struck by 1D4+2 blasts.

Rate of Fire: Four showers of laser blasts per melee round (automated and on a timer).

Maximum Effective Range: 500 feet (152 m); yes, that's 500 feet even though the maximum altitude of the disk is 100 feet (30.5 m).

Payload: Effectively unlimited.

Note: The ten underbelly lasers are only effective against large crowds and large (ideally stationary or slow moving) targets. Targets that number 1-5 human-sized people are +1 to dodge. These small lasers cannot point directly forward or backwards.

3. Multi-Weapon Arms (2): Each Gunner controls one weapon arm that is stowed, folded up against the undercarriage until needed. Each can rotate 360 degrees and has a 170 degree arc of fire up and down. These are the main assault and defense weapons used in conjunction with the missile launchers.

The arms end in a heavy-looking weapon housing that has a twin-barrel rail gun and a single-barrel heavy laser, plus a rod that can fire an electrical discharge (the advantage of this is that it hits everything in a 10 ft/3 m diameter). The two arms cannot fire simultaneously at the same target unless it is especially large and either slow moving or stationary (i.e. a bunker, or crashed aircraft, etc.). The arms are articulated enough where they can also be used to bat at enemies who get close enough, striking them with the side of the forearm weapon housing or gun barrels.



Primary Purpose: Defense

Secondary Purpose: Anti-Personnel

Mega-Damage: Varies with weapon used.

- High-powered, precision laser: 4D6 M.D. per blast, per arm; +1 to strike.
- Rail Gun: 1D4x10 M.D. per 10 round burst.

- Electro-Blast: 3D6 M.D. to a 10 foot (3 m) diameter.

- Physical **Punch/Strike:** 1D6 M.D.

Maximum Effective Range: Laser: 3,000 feet (914 m)

Rail Gun: 4,000 feet (1,200 m)

Electro-Blast: 120 feet (36.6 m)

Physical **Punch/Strike:** 12 feet (3.6 m)

Payload: Rail gun: 2,000 rounds (200 shots) each. All energy weapons are effectively unlimited.

4. Mini-Missile Launchers (2): A pair of launcher fold out from a concealed compartment on deck to fire their payload.

Primary Purpose: Assault

Secondary Purpose: Anti-Personnel

Mega-Damage: Varies with missile type.

Rate of Fire: 1, 2 or 4 missiles in a volley.

Maximum Effective Range: About one mile (1.6 km).

Blast Radius: Varies

Payload: 64 total; 32 per each launcher.

5. Medium-Range Missile Launcher (1): A large, forward, nose/underbelly launcher.

Primary Purpose: Anti-Vehicle

Secondary Purpose: Support

Mega-Damage: Varies with missile type.

Rate of Fire: 1, 2 or 4 missiles in a volley.

Maximum Effective Range: About 20 miles average (32 km).

Blast Radius: Varies with missile type.

Payload: Eight

6. Sensor Systems of Note: Gromeko battle computer, holographic optics, HUD, **enviro-360** sensor screens, full communications suite with a range of 100 miles (160 km), radio **scrambler**, directional laser communication system, radar to 50 miles (90 km; registers up to 64 different targets simultaneously), five underbelly spotlights (300 **ft/91 m**), **loud-speaker/P.A.** system (1000 **feet/305 m**), built-in language translator, onboard computer (in throne as well as pilot compartment) and **Cyber-Link** (in throne as well as for pilot and gunners).

Wingrider Flying Wing

The Wingrider is a term used to describe both a particular Russian war machine and the daring men who fly them. The Wingrider vehicle is basically a flying wing in which the pilot is attached via a flexible harness so that he can perform **twists**, **turns**, and swings, as well as lay prone when zooming along. The rider is suspended perpendicular to the vehicle in a harness between two rails jutting from its center, above the main wing assembly. The twin jets propelling the wing are mounted within the main assembly under the rider. Tiny maneuvering jets in the front and underbelly of the wing help to slow and control it. A pair of retractable skis serve as landing gear.

Flying Wings are tricky to use. Taking off is accomplished by putting one foot on the wing and pulling on the handles to drag the nose up. The rider leaps up into the **harness**, while thumbing the jets and, hopefully, gets airborne (uses up **3-4** of the pilot's melee actions to get going). Landing is even trickier, for it requires the rider to pull up at the last moment to bring the craft to a proper landing. Landings can range from comical to tragic among inexperienced pilots to truly remarkable pinpoint maneuvers by experienced ones. Once airborne, the Flying Wing is wobbly and unstable, and requires hundreds of hours of practice to master it. And Wingrider Pilots do master these dangerous vehicles to the point of making operating them look (relatively) easy. They are so skilled that they can perform dead

falls, suicide dives, and fly upside-down, performing rolls, loop-de-loops and other acrobatic maneuvers. Perhaps the most bizarre maneuver is the "**Chulki** Hook Turn," named after a Wingrider by the name of Chulki who perfected the maneuver, but who is, unfortunately, no longer among the living.

The Wingrider makes a superior reconnaissance vehicle because of its small size and ability to not only fly low to the ground, but skip along the ground with only inches to spare, and to fly sideways through narrow openings and passages — this makes them -30% to read accurately on radar (-30% to Read Sensory Equipment skill). However, the vehicle is composed of super-light alloys which makes it vulnerable to heavy weapons fire, and is so difficult to fly that most adventurers, mercenaries and Warlords avoid using them. Only Warlords Romanov, Seriyev and **Kolodenko** use them as an elite combat force (and with devastating effectiveness). The rest find them unreliable and "questionable" as combat vehicles, especially compared to other more stable hover vehicles. **Note:** Also see the *Wingrider Pilot O.C.C.* for more about these vehicles and the daredevils who use them.

Wingrider

Model Type: Warlord Wingrider

Class: One-Man Aerial Hover Jet Combat Vehicle

Crew: One; pilot.

M.D.C. by Location:

* Chulki Hooks (4) — 5 each

* Strafing Lasers (2) — 20 each

* Mini-Missile Launcher — 50

* Short or Medium-Range Missiles (2; optional) — 30 each

* Rear Jet Engines (2) — 75 each

* M.D.C. Railings (2) — 25 each

* Railings and Pilot Harness System — 50

Wings (2) — 130 each

** Main Body — 180

* The Pilot hanging suspended and areas marked with a single asterisk are small **and/or** difficult targets to hit. Thus they can only be hit when a character makes a called shot and even then the attacker is -5 to strike. In addition, the attackers are -1 to strike per 50 **mph** (80 km) of speed the Wing is travelling. So at 300 **mph** (482 km), attackers are -11 to hit these areas/items. The Chulki Hooks are so small they are at -6 to hit! Destroying the armoring on the **short/medium-range** missile launcher has the possibility of detonating all the missiles! There is a 1% chance per point of M.D. from the first missile detonated, that all the missiles in the launcher will detonate at once.

** Depleting the main body destroys the aircraft. If this happens in flight, the pilot could fall to his death (1D6 M.D. per 200 **feet/61 m** of height).

Speed

Flying: Top speed of 300 **mph** (482.7 km). Cruising is typically 100-170 **mph** (160 to 272 km).

Gliding: The Wingrider is capable of silent gliding at speeds between 60 and 160 **mph** (96.5 to 256 km).

Dive: 400 **mph** (643 **km**)!

Altitude Ceiling: 6,000 feet (1,828.8 meters). Above this, wind currents make it too difficult for the light craft to remain stable (-30% to piloting skill and reduce speed 40%).

Driving on the Ground: Not possible, although the ski-like **land-**

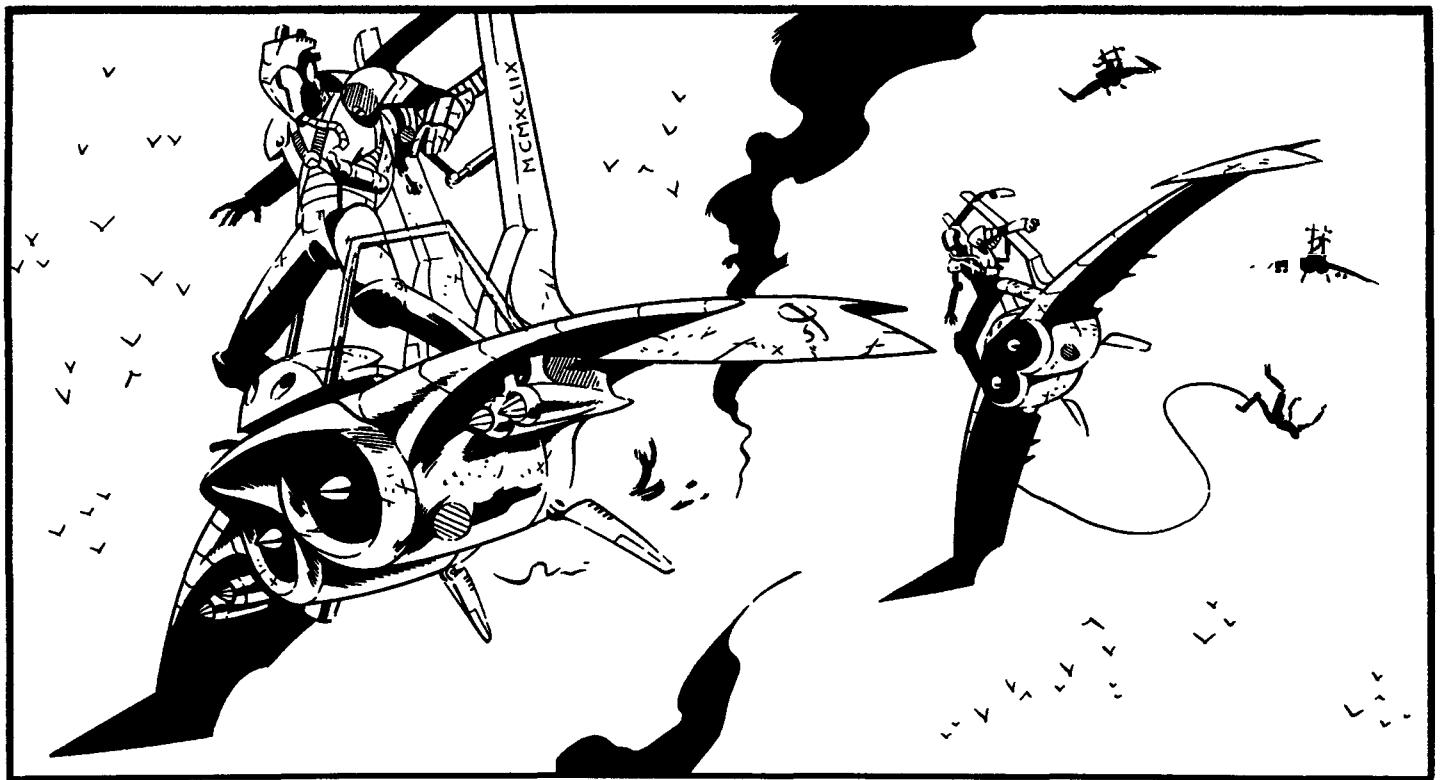

ing gear can be used to slide across ice and deep snow.

Underwater: Not Possible.

Range: 500 miles at full speed for liquid fuel systems (12%) unlimited for nuclear systems (88%).

Statistical Data

Height: The main body is about three feet (0.9 m) high/thick at its thickest point, narrowing from the center fuselage to the wing tips. The pilot's harness and railings add four feet (1.2 cm), and another foot when landing gear is down, for an overall height of about 7-8 feet (2.1 to 2.4 m).

Width/Wingspan: 18 feet (5.4 m)

Length: 6 feet (1.8 m) at the center of the body, tapering to two feet (0.6 m) at the wing tips.

Weight: 600 pounds (272.2 kg)

Cargo: None

Power System: Liquid fuel (a rarity) or nuclear.

Black Market Cost: 500,000 to 700,000 credits.

Weapon Systems

1. Chulki Hooks (4; two on each wing): Mounted on the underside of the wings about 4 feet (1.2 m) from their tips, are a pair of launchers that fire hooked grapnels. They have several novel uses, including hooking onto aircraft, hover vehicles and power armor to be pulled along while slowly closing ranks or engaging in close quarters Dog Fights, or snaring unsuspecting ground troops (not 'Borgs) and pulling them off their feet (**Combat Note:** Counts as two melee attacks, but the victim also loses two attacks and initiative), and may drag them along the ground or up into the air (**Combat Note:** While airborne or being dragged, the victim loses half his attacks per round, loses initiative, shooting is done as "wild", and is -6 to strike, parry and dodge, and -50% to perform a skill. Furthermore, those dragged across the ground suffer 1D6 M.D. per melee round and can be slammed into something big and heavy, taking 4D6 M.D. +6 M.D. additional for every 50 mph/80 km of speed the Wing is travelling; half

damage if only dropped from a great height. Note that the act of slamming into an object usually knocks the victim off the hook and line; 01-90% chance).

Chulki Hooks are also used on Light and Heavy Machine 'Borgs, but only to pull them off their feet (lose two melee actions and initiative); they are usually too heavy and/or too dangerous to try to drag or pull into the air. The Wingrider pilot will swoop out of the sky, fire the hooks, and send his opponent flying! **Note:** The grapnel launcher has an automatic disengage and rewind feature that unlatches the grapple and zips the head back into the launcher with the press of a button or 60 seconds (four melee rounds), whichever comes first.

The hook and grapnel is also used to make incredibly sharp turns by shooting the grapnel to hook onto a pole, tree, giant robot, etc., to swing the craft and rider around terrain features at high speeds and tight angles and then release and continue to fly in the new or opposite direction without slowing down more than 5%! This "sling-shot" maneuver stuns everybody who sees it, causing spectators and would-be-assailants to lose one melee **attack/action** before they can recover and respond.

The cable attached to the grapnel can also be mechanically detached while in its firing housing and shot out as a projectile, but only does 1D4 M.D. and has a limited range of about 400 feet (122 m).

Primary Purpose: Assault

Secondary Purpose: Maneuvering

Mega-Damage: As noted above under *Combat Notes* for the hook and carry maneuver; plus the following:

Wing Clip: 1D6 M.D. per 50 mph (80 km) of speed. This maneuver is also likely to knock the Wingrider crooked and a control roll is necessary to avoid crashing (-20% to the Wingrider piloting skill roll). An unsuccessful skill roll means roll percentile and see what happens:

01-33 Crash! The vehicle takes 2D6x10 M.D., the pilot 6D6 M.D., he is stunned for one melee round, and the vehicle must be started up and made airborne, which uses up three melee actions of the next round.

34-66 Clip the ground or trees. Loses control of the vehicle for two melee rounds (no attacks) as he spins out of control, and **nicks**, clips, and butts the ground, **treetops** or buildings, but manages to stay airborne and the vehicle only takes 5D6 M.D., and he only 1D6 M.D.

67-00 Spins out of control briefly, but stays airborne and takes no **damage** — loses **1D4+2** melee actions/attacks (may include loss for the rest of one round and into the next melee).

Body Skip/Clip: 1D6 M.D. per 50 mph (80 km) of speed. A maneuver in which the Flying Wing is used to butt, clip or just skip off a target (man-sized to big vehicles).

Body Slam: 2D6 M.D. per 50 mph (80 km) of speed. This maneuver involves flying at good speeds and at the last minute, pulling up so that the bulk of the main body takes the impact and the Flying Wing can ricochet up, backwards or side to side and keep on flying (at half speed for one melee round). This attack does **1D4** M.D. per 50 mph (80 km) of speed to the main body of the Flying Wing.

Rate of Fire: Once each Combat Round (15 seconds).

Maximum Effective Range: Touch or clip.

Payload: N/A

2. Strafing Lasers (2): A pair of small, short-range lasers are located above the shoulders on either side of the pilot.

Primary Purpose: Defense

Mega-Damage: A single blast does 2D6 M.D. and simultaneous twin blasts do 4D6 M.D. (counts as one melee attack).

Rate of Fire: Equal to the pilot's hand to hand attacks.

Maximum Effective Range: 1,200 feet (366 m)

Payload: Effectively unlimited, or 100 each for liquid fuel models.

3. Mini-Missile Launcher: Mounted in the center, forward section of the Flying Wing is a mini-missile launch system. It can be fired with the push of a button.

Primary Purpose: Assault

Secondary Purpose: Sabotage

Mega-Damage: Varies with missile type.

Rate of Fire: 1 or 2 missiles.

Maximum Effective Range: 8 miles (12.8 km)

Payload: 12 mini-missiles in the main system, but four additional mini-missiles (two on each wing tip) or two short-range or medium-range missiles (one on each wing tip) can be attached.

4. Optional: Weapons: The pilot can also use the weapons built into **Wingrider** Power Armor or his bionic weapons if a cyborg. Hand-held weapons are impossible to use except when gliding, because of the constant use of hands on the controls and **movement/repositioning** of the pilot in the harness.

5. Bonuses: +1 on initiative, +1 to parry and +2 to dodge; all apply only when airborne, and are in addition to bonuses from the Wingrider Pilot O.C.C.

Wingrider Power Armor

The Flying Wing comes with a special suit of power armor worn by the pilot. That suit is presented here, because it is as much a part of the vehicle as anything else. It is a sleek, rela-

tively light, full environmental armor with a helmet that offers maximum use of peripheral vision (bird styling and others are used). The suit has all the standard features common to power armor (see *Triax™ & NGR* or *Riffs® RPG*), however, it is a fairly basic armored exoskeleton.

Note: The pilot does not need to wear the power armor to fly the Wingrider, provided he has a helmet. However, those without the power armor are -20% to pilot it, -3 on initiative, and lose one melee action, unless the pilot is a full conversion cyborg, Light Machine or Heavy Machine — cyborgs don't need to wear power armor.

Notable Features & Weapons:

- Augments P.S. equal to a robot P.S. of 24.

- M.D.C.: Main Body — 140; **Head/Helmet** — 75.

Housing for easy attachment of a jet pack; however, no backpack of any kind can be worn while piloting the Wingrider (too cumbersome).

One arm has a retractable Vibro-Sword (2D6 M.D.).

The other has **vibro-claws** extending from the top of the hand to beyond the fingers (2D4 M.D.) and a small forearm laser (2D6 M.D.; 1000 ft/305 m range).

The warrior can also carry and use an energy weapon that can be stowed by attaching to the top side of the wing next to the railing (within reach).

The **Cyber-Link** is not available for this vehicle.

Mega-Steeds

The True Megahorse

The term "Megahorse" originated with the appearance of a powerfully built alien creature that closely resembles Earth War Horses, only about 50% larger. A true Megahorse appears to be a huge, thickly muscled horse sculpted from pure white marble with a mane of flowing white hair. They are cool to the touch and their eyes sparkle with (low) human intelligence (I.Q. 1D4+6). They are intuitive creatures who possess **empathic** and telepathic abilities enabling them to communicate with humans and accept Knights and other people as their partners, friends and companions. Best of all, they are Mega-Damage creatures with a disdain for supernatural evil. As fate would have it, these magnificent horse-like beings were first encountered by War-Knights and the two (both with similar goals regarding the destruction of demonic forces) became immediate allies. Megahorses are also fond of **Bogatyr**, Cossacks, Huntsmen and Mystic **Kuznya**, but may befriend people of any occupation, race or nationality.

As an intelligent creature, it is virtually impossible to "break" a Megahorse like an ordinary riding animal. The great animal will only allow those whom it personally likes to ride it. If the Megahorse dislikes a person, it takes an act of God for that individual to ride on its back. Most Megahorses are especially fond of genuine heroes, children and gentle or innocent people.

True Megahorse

Player Character Note: The Megahorse is primarily intended to be a Non-Player Character (NPC), but is smart enough that it could, in theory, be played as a player character. This might be especially amusing if the Megahorse was smarter than the rider; its partner. Megahorses aren't usually spiteful or arrogant, so they would not snub a character with a low I.Q., provided the individual had a kind heart and/or the heart of a hero.

Alignment: Any, but most are Principled (20%), Scrupulous (25%), Unprincipled (20%) or Aberrant (15%).

Attributes: I.Q. 1D4+6 (human intelligence), M.A. 2D4+6, M.E. 2D6+8, P.S. 3D6+20, P.P. 2D6+12, P.E. 2D6+12, P.B. 2D6+14, Spd. 4D6+58 (42-58 mph/67 to 93 km minimum). P.S. is considered Supernatural.

M.D.C.: P.E. x10 plus 3D6 per level of experience (use the Explorer O.C.C. experience table).

Awe/Horror Factor: 12, +3 when charging an opponent only).

Size: 10-12 feet (3 to 3.6 m) long; about 7-8 feet (2.1 to 2.4 m) at the shoulders.

Weight: 1 to 1.4 tons.

Average Life Span: 150-220 years.

P.P.E.: 6D6+6

O.C.C.: Technically none, but could be considered something of an animal-like knight or **Bogatyr**.

Natural Abilities: Great speed, strength and endurance; can run without pause or suffering from exhaustion for three hours! Can leap 12 feet (3.6 m) high and 20 feet (6 m/yards) across, +1 yard/meter per every 5 P.S. points with a short gallop; increase by 50% when the leap is made at full gallop. Excellent day vision, but night sight is only slightly better than a human's. Has a keen sense of hearing and a fair sense of smell. A single Megahorse can pull as much as 15 tons and carry up to 4 tons on its back! Can sense supernatural evil similar to Earth horses. Also see R.C.C. skills.

Riding Bonus: When a Megahorse likes the person and the two are working together for a common cause, the rider enjoys a +10% to horsemanship skill, and even those with no riding experience can ride the animal equal to a horsemanship skill of 55%.

R.C.C. Skills: As an intelligent creature, the Megahorse starts with the following skills: Wilderness Survival (+30%), Land Navigation (+20%), Track Animals, Tracking (people; +5%), Dowsing (+5%), Swim, Prowl and understand one language of choice (+5%). It can also learn any four Technical skills that don't require the use of hands at level one, and one additional at levels 2, 5, 7, 10 and 13. Skills improve with experience.

R.C.C. Combat: Attacks/Actions Per Melee: Starts with three, +1 at levels 2, 4, 6, 9, 12 and 15.

Bonuses: +3 on initiative, +3 to strike, +5 to dodge, +3 to roll with punch, fall or impact, +1 to save vs magic, +2 to save vs poison and disease, +3 to save vs possession, and +4 to save vs Horror Factor. All are in addition to attribute bonuses.

Damage:

Bite — 4D6 S.D.C.

Restrained Kick or Head Butt — 3D6 S.D.C.

Head Butt — 1D4 M.D.

Body Butt/Slam — 1D6 M.D.

Stomp — 2D6 M.D.

Kick from Front Legs — equal to Supernatural P.S.

Kick from Rear Legs — equal to Supernatural P.S. +10.

Power Kick with rear legs only; double damage but counts as two melee attacks.

Magic: None

Psionics: Limited psionic abilities include Sense Evil, Sense Magic, *Sense Time*, Empathy, Telepathy, *Mask I.S.P. & Psionics*, Mind Block, *Telekinetic Push* and *Psionic Invisibility*. See *Rifts® Psyscape™* for abilities listed in italic.

Base I.S.P. is M.E. x2 plus 1D6 per level of experience.

Enemies: Demons and all beings of supernatural evil, Necromancers, Witches, large predators, and those who wish to enslave it.

Allies: Heroes, knights and those dedicated to destroying supernatural evil. Children and innocent and compassionate people are also looked upon favorably.

Value: Considered priceless, but as intelligent creatures, they are difficult to enslave. Most Megahorses will not submit to slavers or allow themselves to be bought and sold like animals! A Megahorse can command 15-20 million credits, sometimes more.

Availability: Rare, only 14% of all War-Knights have a traditional Megahorse. **Bogatyrs**, Cossacks and other warriors and adventurers may befriend and earn a true Megahorse as a companion, but only the Megahorse decides who it accepts as an ally and who rides it. The Megahorse often picks its rider/companion/partner.

Approximately 76,000 True Megahorses are believed to exist in all of Russia, with roughly 58,000 allied to **War-Knights** under the service of the Warlords and about three thousand allied to Cossacks. The remaining 15,000 either live free and independent, or are allied to those not affiliated with the Warlords; other Cossacks and Bogatyrs, adventurers and heroes.

An additional 10,000 or so are suspected to inhabit China and a few hundred may have found their way to Poland, Romania, Yugoslavia, Turkey, The Middle East, and India.

Habitat: Originates from an alien world. Seems comfortable in most climates, but prefers forests, jungles and wide open grasslands like the steppe.

Horned Steed

Also known as the Devil Horse

The Horned Steed, or Devil Horse (so named because of its pair of devil-like horns), is a horse-like creature from another dimension. Except for the horns and thick, leathery plates on their heads, necks and spines, they look and act very much like Earth horses. This natural body armor offers excellent M.D.C. protection, while the horns both protect the head and provide a means of defense. The horns are used much like a bull or stag, to butt and ram rivals and predators. The ear is a small circular area behind the eye. Horned Steeds are herbivores that graze on grass, grains and berries.

They have adapted well to eastern Russia and can be found in the Steppe, southern Siberia (at least in the summer), Mongolia and China. Wild Horned Steeds number into the millions, with at least one million that have been domesticated. The Devil Horse, as the Cossacks prefer to call them, is a favorite among the Cossacks, War-Knights and messengers.



Horned Steed or Devil Horse

Classification: Mega-Steed.

Alignment: Animal; generally considered to be good or anarchist.

Attributes: Animal attributes are very consistent and offer a smaller range of attribute aptitude. I.Q. High animal intelligence (1D4+4), M.E. 2D6+6, M.A. 2D6+10, P.S. 3D6+12, P.P. 2D6+8, P.E. 2D6+8, P.B. 2D6+4, Spd 48+3D6 (35 to 45 mph/56 to 72 km). P.S. is considered supernatural.

Mega-Damage: 3D6x6 +P.E. attribute number.

Awe/Horror Factor: 9

Size: 6-8 feet (1.8 to 2.4 m) long. 5 to 5.4 feet (1.5 to 1.6 m) at the shoulders; approx. 7 feet (2.1 m) overall height.

Weight: 1200-1800 pounds (544 to 816 kg).

Average Life Span: 24-30 years.

P.P.E.: 4D6

O.C.C.: None; animal.

Natural Abilities: Excellent speed and can run at maximum speed without pause or exhaustion for one hour, but can trot at a steady pace (20 mph/32 km) for up to four hours without rest or becoming exhausted. The animal can carry up to 1000 pounds (450 kg) on its back and pull up to ten tons. It has good vision, **nightvision** 600 feet (183 m), good hearing and sense of smell, land navigation 80%, prowl 40%, and swim 65%. The animal can leap six feet (1.8 m) high and 12 feet (3.6 m) lengthwise, one third longer at full gallop.

R.C.C. Combat: Attacks/Actions Per Melee: Three.

Damage:

Bite — 1D4 M.D.

Stomp — 4D6 S.D.C.

Kick with front Legs — 2D6 M.D.

Kick with Rear Legs — 3D6 M.D., counts as one attack.

Head Butt — 1D6 M.D.

Charging Body Slam/Ram — 2D6 M.D., but counts as two melee attacks and has a 01-50% chance of knocking a human-sized opponent off his feet. The victim loses initiative and two melee actions.

R.C.C. Bonuses: +2 on initiative, +3 to strike, +1 to parry, +4 to dodge. All bonuses are in addition to attribute bonuses.

Magic: None

Psionics: None

Enemies: Large predators, pack hunters like wolves, and humanoids.

Allies: Not applicable; is as easy to domesticate as Earth horses.

Value: 2,000-4,000 credits per animal; used mainly as riding animals and beasts of burden to haul cargo and plow fields. The Devil Horse is edible, but the meat is tough and extremely chewy. Their armor-plated hide can be used as light M.D. armor (a suit of leather armor has 25 M.D.C., and combining it with other M.D.C. materials can get a composite suit with 35-55 M.D.C.). They are a favorite of the Cossacks.

Known Habitat: Western Russia, Mongolia and China. They love grasslands and prefer moderate climates, but can survive Siberian Winters.

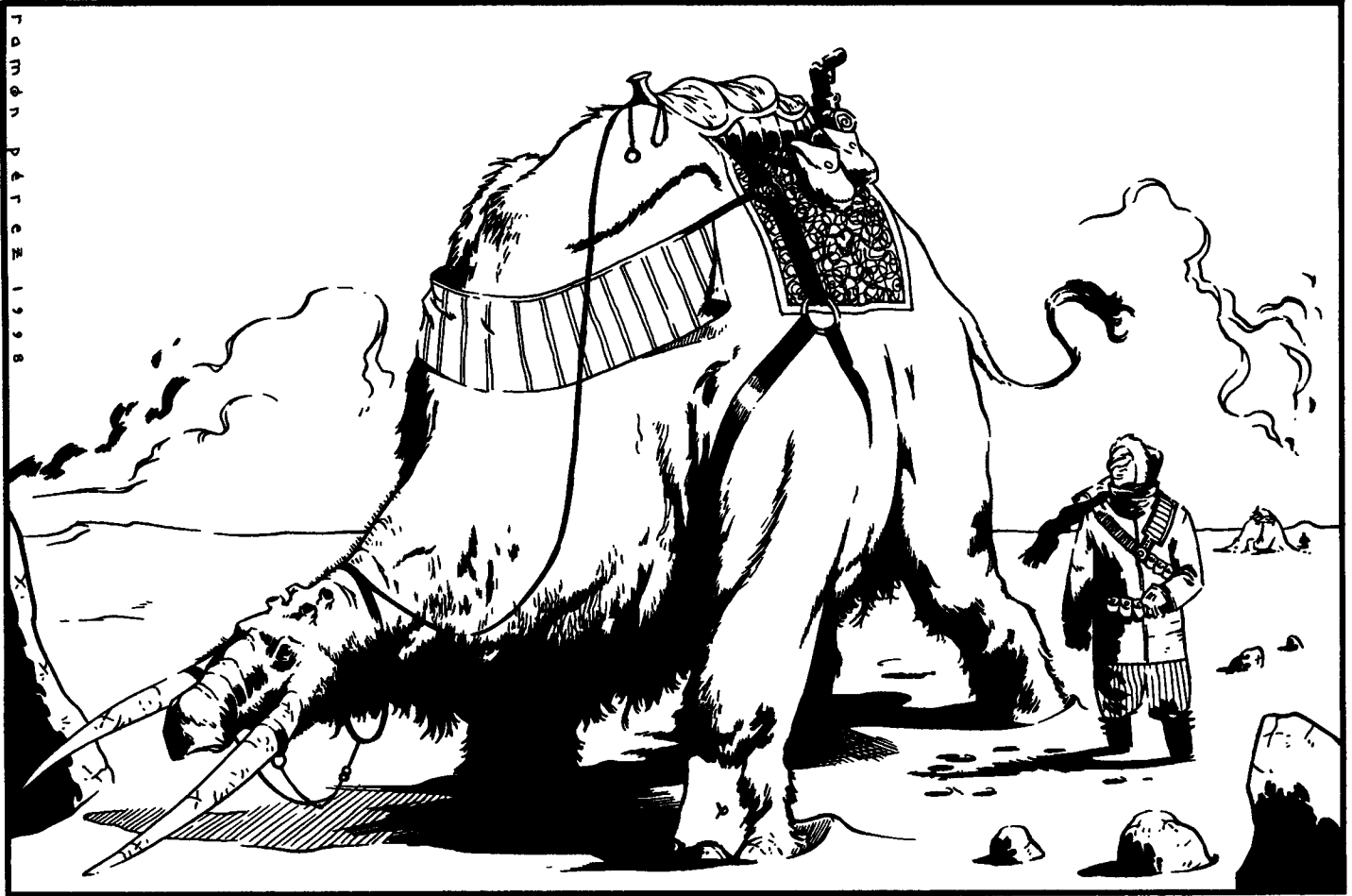

Burkov Mastodon

A tremendous beast of burden, especially in the arctic regions of Russia and during the long winters, is the Burkov Mastodon. As one might suspect, this large woolly animal is neither a native of Earth nor a Mastodon/elephant. However, this great, shaggy beast from another world has tusks like an elephant and a body the size of an elephant, although the body is shaped a bit more like that of a huge rhinoceros. The head is hung low on the massive body so the animal can graze on grass, shrubs and roots. The head is long, with a pair of tusks that extend from the jaw to well beyond the snout. The tusks are used to dig up edible roots and fish out water plants, as well as for self defense. The Tusks are used defensively as clubs, with the Burkov Mastodon swinging its head side to side in a thrashing, clubbing motion rather than impaling. The neck may appear short, compared to its large, mountain-like body, but is actually 7-9 feet (2.1 to 2.7 m) long and extremely flexible, allowing the creature to turn its head side to side 180 degrees. The Burkov Mastodon also uses its long tusks and powerful neck to either pin an attacker to the ground or to ensnare and toss it to the side or up into the air (up to 20 ft/6 m). This is very effective against predators like wolves, dogs and cats. The massive beast may also stomp and roll over onto attackers low to the ground.

Burkov Mastodon

Classification: Mega-Steed

Alignment: Animal; generally considered to be of selfish alignment.

Attributes: Animal attributes are very consistent and offer a smaller range of attribute aptitude. I.Q. Medium animal intelli-

gence (1D4+2), M.E. 1D6+6, M.A. 1D6+6, P.S. 2D6+40, P.P. 10+1D6, P.E. 20+1D6, P.B. 2D6+2, Spd 33+2D4; a minimum speed of 22 mph (36 km).

Mega-Damage: 2D6x10+110

Horror Factor: 9; +3 when charging an opponent only.

Size: Length: The body is 14-16 feet (4.2 to 4.8 m) long, with the neck and head adding an additional 7-9 feet (2.1 to 2.7 m) and the tusks another 3-5 feet (0.9 to 1.5 m) past the snout (the full length of the tusks are 5-8 feet/1.5 to 2.4 m long), for an overall body length of 24-30 feet (7.3 to 9 m) from the tip of the tusk to the hindquarters. The comparatively short and rope-like tail adds another 3-4 feet/0.9 to 1.2 m.

Height: 10-12 feet (3 to 3.6) at the shoulders; overall height is 15-18 feet (4.6 to 5.5 m).

Weight: 7-9 tons.

Average Life Span: 25-30 years.

P.P.E.: 3D6

O.C.C.: None; animal.

Natural Abilities: Fair speed and can run at maximum without pause or exhaustion for one hour. However, the Burkov Mastodon can walk or trot at a steady pace (6-10 mph/9.6 to 16 km) for up to six hours without rest or becoming exhausted. The animal can carry up to ten tons on its back, and pull up to 60 tons! The tusks and neck can be used to pick up or pry up and roll out of the way, up to four tons. It has fair vision, a keen sense of smell (can locate and identify plants and roots it can eat up to eight feet/2.4 m under snow; skill equivalent of 75%), swim 60%, and the equivalent of land navigation at 45%. The Burkov Mastodon is a herbivore with a gentle disposition, making it easy to train and domesticate; a gentle giant, except when threatened.

R.C.C. Combat: Attacks/Actions Per Melee: Females tend to be slightly larger than males and have three attacks/actions per round. Males have four **attacks/actions** per round.

Damage: Females do 1D6 M.D. additional damage except for restrained attacks.

Bite — 6D6 S.D.C.

Restrained Head Butt or Tusk Strike — 1D6x10 S.D.C.

Head Butt — 1D6 M.D.

Tusk Strike — 4D6 M.D.

Power Tusk Strike — 4D6x2 M.D., but counts as two attacks.

Stomp — 5D6 M.D.

Kick from Rear Legs only — 1D4x10 M.D.

Body Slam/Butt — 6D6 M.D.

Charging Body Slam/Ram — 2D4x10 M.D., but counts as two melee attacks.

R.C.C. Bonuses: +1 on initiative, +3 to **strike**, +2 to parry, +1 to dodge, and +6 to save vs Horror Factor.

Magic: None

Psionics: None

Enemies: Large predators, pack hunters, and humanoids.

Allies: Not applicable; domesticated by Cossacks and other people.

Value: 5,000-10,000 credits per animal, used mainly as beasts of burden for hauling heavy **cargos**, and for riding. Their meat is delicious and is the equivalent of 10-16 full grown cows. Their skin and horns are also useable; the skin can be used as light M.D. armor (a suit of leather armor has 20 M.D.C., combining it with other M.D.C. materials can get a composite suit with 40-50 M.D.C.). Unfortunately, they are not practical to raise as cattle because they eat so much. The fanners who do use them as cattle often kill them when they are young (half the size and weight) and those who use them as beasts of burden rarely have more than one.

Habitat: The steppe and tundra of Russia are their favorite, but they can also survive in forests in cold to moderate climates. An estimated half million are said to exist in the Russian Wilderness, but the real number is likely to be 3-5 times greater. At least 35,000 have been domesticated. Typical wild herd: 4D4x100.

Steppe Ostrich

According to legend, the Steppe Ostrich is a giant, mutant chicken created by radiation released from nuclear missiles and power plants scattered throughout Russia. This legend is firmly held by most peasants, farmers and Cossacks (the latter probably because they find it amusing). However, it is more likely that the Steppe Ostrich is another animal transplanted from an alien world via dimensional Rifts.

The Steppe Ostrich is both good eating (one being the equivalent of 12-18 chickens) and a satisfactory riding animal. Many people of the Steppe, southern half of **Siberia/tundra**, Mongolia, western Russia and northern China have domesticated the animal and use them mainly for food, but many, particularly the Mongols and Chinese, also use them as riding animals. The bird-like creatures are fast and their movement is surprisingly smooth and **fluid**. Only the Cossacks absolutely refuse to use them as steeds, because they say it is "**unflattering** for Cossacks — the greatest horsemen in the world — to ride giant chickens."

However, they do capture, raise and sell Steppe Ostriches, as well as hunt wild ones.

Despite the joking about being giant chickens, the wild Steppe Ostriches can be dangerous animals. They are omnivorous Mega-Damage creatures which means they eat grain, seed, nuts, and berries, but also eat insects, garbage scraps and meat. Meat is usually rodents and carrion, but can also include livestock and people! As individuals and small groups of 1-4, these creatures are skittish and wary of humanoids. Most will run away, attacking only if threatened, cornered or if the humanoid is injured or a small child. However, like birds, the Steppe Ostriches gather in flocks of 5D6, and sometimes in flocks as large as 2D4x10. In large groups they are much bolder, and will attack children, one or two people and small animals (dogs, cats, livestock, etc.) without hesitation. Even groups of as many as 8-12 people are likely to be attacked. Steppe Ostriches "**test**" their targets by having 8-16 individuals take a run at their prospective prey. This involves the giant birds running into people with their bodies, pecking and biting, but the most dangerous attacks are clawing and leap attacks. The Steppe Ostrich is an excellent leaper and can jump up to 12 feet (3.6 m) high with just a few steps running. Full speed leaps can get as high as 20 feet (6 m). They use these leap attacks to pounce on top of their prey, knock them down and then peck, bite and claw with their taloned feet. Thankfully, Steppe Ostriches are (please forgive the pun) "chickens" ... cowards who will not battle potential prey who put up too much of a fight, and will flee from such

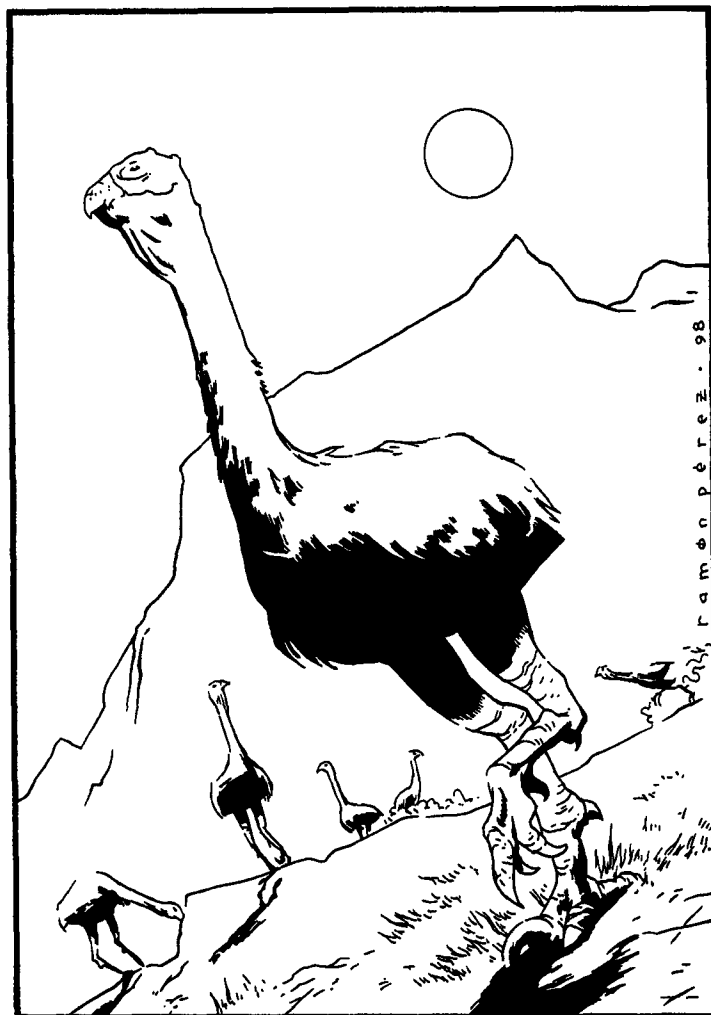

formidable opponents even if they outnumber them six to one. Scavenging predators, the Steppe Ostriches are also cannibals who will grab slain members of their flock and carry them away to be eaten. They never attack any animal the size of a horse or bigger, unless it is clearly injured.

Steppe Ostrich

Classification: Mega-Steed

Alignment: Animal; generally considered to be evil or anarchist.

Attributes: Animal attributes are very consistent and offer a smaller range of attribute aptitude. I.Q. low animal intelligence (1D4), M.E. 1D6+6, M.A. 1D6, P.S. 2D6+12, P.P. 16+1D6, P.E. 16+1D6, P.B. 2D6, Spd 45+2D6 (30-38 **mph/48** to 60.8 km).

Mega-Damage: 4D6 +P.E. attribute number.

Horror Factor: 9 as one, but an attacking flock has an H.F. of 14.

Size: 8-10 feet (2.4 to 3 m) tall from the feet to the top of the head; 4.6 to 5 feet (1.4-1.5 m) at the shoulders. Only about **4-5 feet (1.2 to 1.5 m)** long.

Weight: 250 to 400 pounds (112.5 to 180 kg).

Average Life Span: 15-20 years.

P.P.E.: 2D6

O.C.C.: None; animal.

Natural Abilities: Excellent speed and can run at maximum without pause or exhaustion for one hour, but can trot at a steady pace (**18 mph/29** km) for up to five hours without rest or becoming exhausted. The Steppe Ostrich can also run at speeds 50% greater (approx. **48 mph/77** km) in a short burst of 1D4 minutes. This burst of speed can only be done at the beginning of a melee round and only three times per hour. It can leap 12 feet (3.6 m) high and across with a short run and **20 feet (6 m)** at full speed.

The animal can carry up to 500 pounds (225 kg) and pull up to one ton. It has keen vision (can track via sight equal to * a skill level of 50%), a good sense of smell and hearing, **nightvision** 200 feet (**61** m), can see ultraviolet light, and has the equivalent of land navigation at 85% and prowl 50%. The animal hates water and cannot swim.

R.C.C. Combat: Attacks/Actions Per Melee: Four.

Damage:

Peck — One M.D.

Bite — 1D4 M.D.

Claw Strike — 2D6 M.D.

Power Claw Strike — 4D6 M.D., but counts as two attacks.

Stomp — 4D6 S.D.C.

Kick from one Leg — 2D6 M.D.

Kick from both Legs — 4D6 M.D., counts as one attack.

Body **Slam/Butt** — 1D4 M.D.

Charging Body **Slam/Ram** — 2D4 M.D., but counts as two melee attacks.

R.C.C. Bonuses: +4 on initiative, +4 to strike, +1 to **parry**, +3 to dodge, and +3 to save vs poison and disease. All bonuses are in addition to attribute bonuses.

Magic: None

Psionics: None

Enemies: Other large predators, pack hunters like wolves, and humanoids.

Allies: Not applicable; can be domesticated.

Value: 300-500 credits per animal, used mainly as food and for riding. Their meat is delicious, and yes, it tastes like chicken (actually, more like turkey, and the meat from wild birds tends to be a bit tougher, but still good). Their feathers and claws are also used for a variety of things.

Habitat: The steppe and light forests of southern Russia, Mongolia, and China. There are millions of them.

Ursan Forest Steed

The Ursan Forest Steed, more commonly known simply as the Ursan or Shaggy Ursan, is a bear-like or heavy canine-like creature from another world. Similar to Earth bears, the Ursan has a large, bulky body with broad, powerful shoulders and claws for digging and fighting. The head is comparatively small and round, its four tiny ears (a pair on each side) hidden by its shaggy mane of reddish-brown fur. The hindquarters are lower to the ground and more **tapered**, with legs that are more dog-like than a bears.

The Ursan is both a scavenger eating carrion, scraps, insects, honey, and roots, and a predator digging up young burrowing **animals**, snakes and eggs, to stalking and killing deer, elk, sheep, **goats**, other small mammals and livestock. Unlike most **animals**, the Ursan has no fear of man, although it does not attack humans or humanoids unless it is attacked first, injured, old (humanoids are easy prey) or feels threatened. They are easily domesticated by humanoids and can serve as pets, guard animals, and steeds. As a pet or guard animal, the Ursan, if treated well, is as loyal and playful as any dog, and gentle and patient with children, the mentally retarded, sickly and elderly. They are a favorite companion and riding animal of the Huntsman Trapper.

Riding these hulking beasts places the rider low to the ground and is easy when trotting along or slowly prowling. However, running at full tilt is an experience, because the Ursan runs in a loping motion at speeds that its hulking frame does not suggest, and the beast makes sudden turns and quick stops.

Ursan Forest Steed

Classification: Mega-Steed

Alignment: Animal; generally considered to be good or anarchist.

Attributes: Animal attributes are very consistent and offer a smaller range of attribute aptitude. I.Q. Medium animal intelligence (1D4+2), M.E. **1D6+10**, M.A. 2D6+10, P.S. 3D6+20, P.P. 16+1D6, P.E. 10+1D6, P.B. 2D6+2, Spd 38+2D6 (**28-35 mph/44** to 48 km). P.S. is considered supernatural.

Mega-Damage: 3D4x10 +P.E. attribute number.

Horror Factor: **10**; +3 when attacking.

Size: 8-10 feet (2.4 to 3 m) long. 4-4.6 feet (1.2 to 1.4 m) at the shoulders; 5-6 feet (1.5 to 1.8 m) overall height, but the head hangs at about 3-3.6 feet (0.9 to 1 m) above the ground.

Weight: 1000-1500 pounds (450 to 675 kg).

Average Life Span: 18-24 years.

P.P.E.: 4D6

O.C.C.: None; animal.

Natural Abilities: Excellent speed and can run at maximum speed without pause or exhaustion for one hour, but can trot at a steady pace (**20 mph/32** km) for up to four hours without rest or becoming exhausted. The Ursan can leap six feet (1.8



m) high and eight feet (2.4 m) across with a short run and 33% more at full speed. The animal can carry up to 1200 pounds (544 kg) on its back and pull up to five tons. It has good vision, **nightvision** 600 feet (183 m), keen hearing, and an excellent sense of smell (can track by smell at 50%; +15% to follow blood scent or other very strong and distinctive odor), land navigation 85%, prowl 50%, and swim 75%. The animal cannot climb trees but is sure-footed on rocky slopes.

R.C.C. Combat: Attacks/Actions Per Melee: Five

Damage:

Nip — 4D6 S.D.C.

Bite — 1D6 M.D.

Claw Strike — 3D6 M.D.

Power Claw Strike — 6D6 M.D., but counts as two attacks.

Stomp — 1D4 M.D.

Kick from Hind Legs — 1D6 M.D.

Body Slam/Butt — 1D4 M.D.

Charging Body Slam — 5D6 M.D., but counts as two attacks.

Pounce — 3D6 M.D. and counts as two melee attacks. However, the **Ursan** will knock down anything its size or smaller (victim loses two melee actions). Furthermore, there is a 01-65% (-15% if larger than 12 feet (3.6 m) and heavier than one ton) chance that its prey will be pinned under the **Ursan**, leaving its **victim/prey** unable to fight back. This means the **Ursan** can keep its prey pinned and bite with its mouth. It can also tear with one of its claws, but that action will allow its victim the ability to strike back with one arm or even push or squirm free.

R.C.C. Bonuses: +4 on initiative, +4 to strike, +1 to parry, +3 to dodge, +3 to save vs poison and disease, and +3 to save vs Horror Factor. All bonuses are in addition to attribute bonuses.

Magic: None

Psionics: None

Enemies: Other large predators, pack hunters like wolves, and **humanoids**.

Allies: Not applicable; can be domesticated.

Value: 3,000-6,000 credits per animal, used mainly as riding and guard animals, and beasts of burden to haul cargo and plow fields. The **Ursan** is edible and the meat good tasting. Their skin and claws are also useable; the skin can be used as light M.D. armor (a suit of leather armor has 12 M.D.C., and combining it with other M.D.C. materials can get a composite suit with 30-40 M.D.C.). They are a favorite multi-purpose animal at villages and farms throughout western Russia where an **Ursan** can function as a beast of burden, steed, guard defense/animal and pet (and in hard winters, if necessary, food).

Known Habitat: Western Russia, the Ukraine, Poland, Romania, the Ural Mountains, Norway, Sweden, Finland and northern Russian forests. They may have spread to other forested and mountain regions to the East in small numbers. They prefer cold and cool forests and mountain forests. Their exact numbers are unknown, but at least 200,000 have been domesticated, and there should be at least ten times that number in the wild.

Bionic Horses

Fielding horses in the day and age of Mega-Damage weapons, cyborgs and supernatural monsters is ludicrous, although the traditional Earth horse holds a special place in the hearts and affections of all Russian horsemen, particularly the Cossacks. Unfortunately, horses are vulnerable to instant death from an M.D. blast or the slashing claws of a demon or dragon. Placing light, Mega-Damage body armor (man-made or magical) on a horse is one alternative used by many warriors, particularly poor adventurers and mercenaries, but the beloved horse is still awfully vulnerable. This has led Russian horsemen to look for alternatives — mechanical ones.

Robot horses are in fairly good supply and imported from dealers in and around the NGR and Poland. However, in a bizarre, yet logical twist, a few of the Russian bionic manufacturers have (based on designs pirated from the robot horses) developed bionic components for horses! The use of bionics for horses has proven to be very effective and half as expensive as the robot counterparts. The horse adapts surprisingly quickly to his artificial limbs and the incorporation of the real horse's mind circumvents the necessity for complex and costly artificial intel-

ligence (technology beyond the scope of current Russian capabilities). Best of all, the Cossacks prefer having a "real" horse's mind and instincts behind their steeds, because the riding animal retains the natural "feel" and "personality" of the genuine animal — they love it!

There are two fundamental types of bionic horses, although there are dozens of different stylings. Also see **Rifts® New West** for robot horses.

Type One Partial Bionic Horse

The first and least expensive bionic horse is one that has had its four legs, hips and chest replaced with strong bionic ones. Body armor is needed to protect the head, neck and upper body of the animal, but leaves the mechanical and armored legs unencumbered (about half are covered with synthetic skin and fur to look like a completely normal horse). Speed and strength is roughly comparable to the original, natural animal, although horses with partial bionics lose one third of their natural P.P.E. and are a third less sensitive to the supernatural.

Weight: 800 lbs (360 kg)

Running Speed: 40 mph (64 km)

Leaps: Increased by 10%.

Fatigue Factor: Reduced by 40%

P.S.: Physical Strength is roughly equal to a human P.S. of 35; can pull two tons.

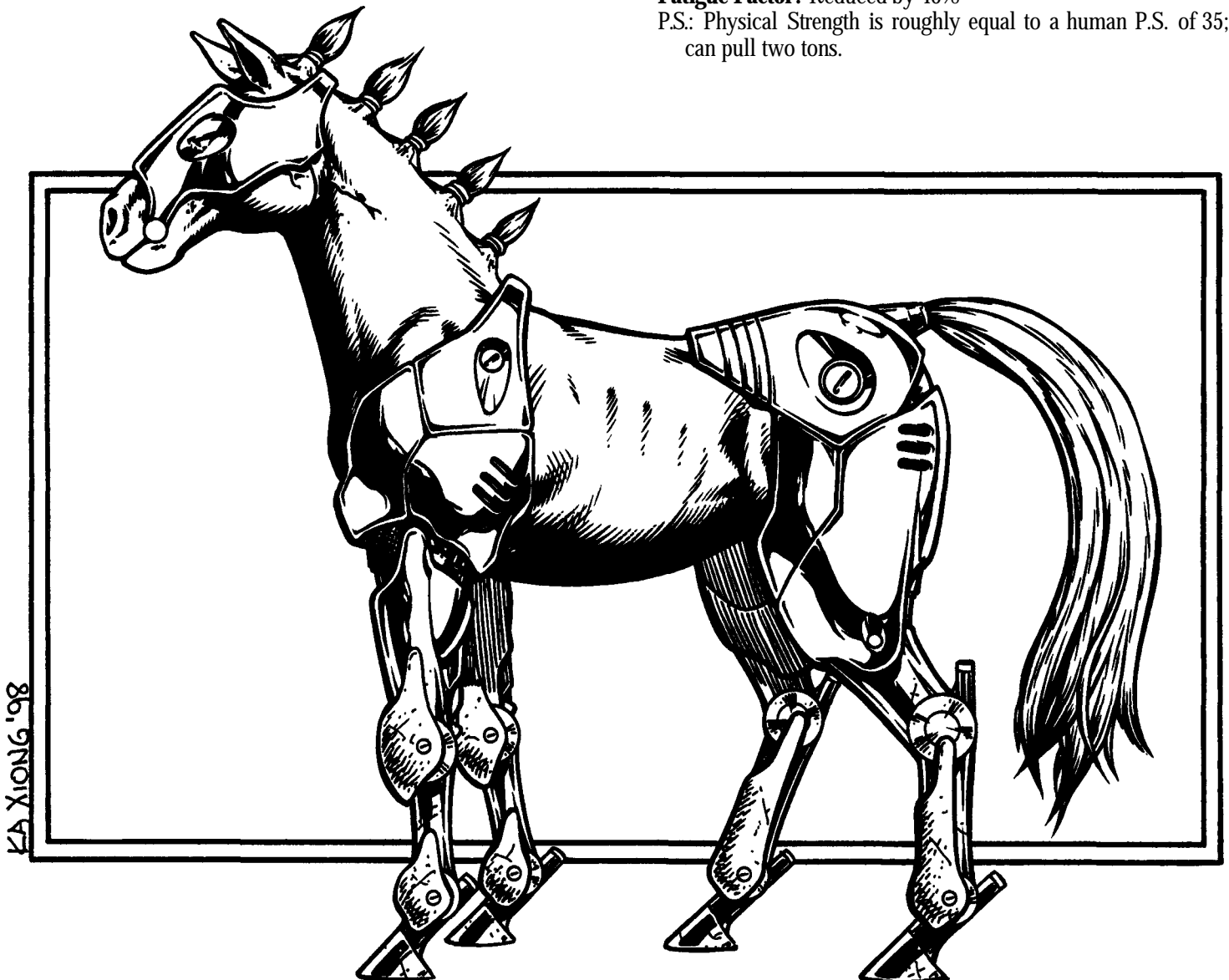

M.D.C. by Location:

- * Front Legs (2) — 90 each
- * Rear Legs (2) — 120 each

Chest — 110

* Standard body armor for head & neck — 100

Standard body armor for main body — 150

Note: Hitting a moving and weaving target is difficult to begin with, so most attackers shooting at a moving horse and/or rider are usually -3 to strike to begin with (this penalty does not apply to marksmen, including Cossacks, Samurai, and American Cowboys, Gunfighters and Gunslingers). Those body areas marked with an asterisk are even more difficult to hit and give attackers an additional penalty of -4 to strike (a total of -7 for most assailants).

Bonuses: +1 on initiative, +1 to dodge when running and +1 to roll with punch, fall or impact.

Damage (includes P.S. bonus):

Stomp: 3D6+15 S.D.C.

Kick with the front legs: 5D6+15 S.D.C.

Kick with the back legs: 1D6x10+15 S.D.C.

Power kick from hind legs: 1D6 M.D., but counts as two of the animal's melee attacks.

Market Cost: 1.5 million credits; sometimes 10-30% less during sales or when the horse is stolen. Add 80,000 credits for a bionic lung, 100,000 for bionic augmented hearing, and 300,000 for a bionic heart. Warlord cost is around 250,000 to 350,000 credits.

Note: Both types of bionic horses have good to excellent availability in Western Russia, and good availability in Poland and Romania. Poor to no availability most elsewhere. The NGR tends to look at this as inhumane and a little bit bizarre and has passed a law making it illegal in that country. They'd rather build robot horses than "mutilate" an innocent animal. Of course, this hasn't stopped unscrupulous arms and bionics dealers from establishing factories out of country (typically Poland and Romania), near the Western Russia border — the market is just too big and profitable to ignore for many opportunists.

Type Two

Full Conversion Bionic Horse

The second bionic horse is much more expensive because it is a full bionic conversion horse with a mechanical body and the head or brain of a real horse. It retains the behavior and personality of the original animal and adapts well to its more powerful, artificial body. However, horses with full bionic conversion lose one half their natural P.P.E. and all their sensitivity to the supernatural (hence the H.F. bonus).

Weight: 1400 lbs (630 kg)

Running Speed: 60 mph (96 km)

Leaps: 12 feet (3.6 m) high and 24 feet (7.3 m) lengthwise with a running start.

Fatigue Factor: Reduced by 90%.

P.S.: Physical Strength is roughly equal to a robot P.S. of 26 and can pull six tons.

M.D.C. by Location:

* Front Legs (2) — 125 each

* Rear Legs (2) — 180 each

Chest — 160

Head & Neck — 140

Bionic Body & Armor (main body) — 275

Note: Hitting a moving and weaving target is difficult to begin with, so most attackers shooting at a moving horse and/or rider are usually -3 to strike to begin with (this penalty does not apply to marksmen such as Cossacks, Samurai, or American Cowboys, Gunfighters and Gunslingers). Those body areas marked with an asterisk are even more difficult to hit and give attackers an additional penalty of -4 to strike (a total of -7 for most opponents).

Bonuses: +3 on initiative, +3 to dodge when running, +2 to roll with punch, fall or impact, and +2 to save vs H.F.

Damage (includes P.S. bonus):

Stomp: 2D6x10 S.D.C. or one M.D.

Kick with front legs: 1D4 M.D.

Kick with back legs: 2D4 M.D.

Power kick with hind legs (only): 2D6+4 M.D., but counts as two of the animal's melee attacks.

Market Cost: 3.6 million credits; sometimes 10-20% less during sales or when the horse is used or stolen. Warlord cost is one million credits.



Horse Barding

While we're at it, here are the stats for horse barding or body armor used on real horses unmodified with bionics.

Weight: 100 lbs (45 kg); non-environmental armor.

Running Speed: Reduce by 5% (averages around 32 mph/51 km).

Leaps: Reduce leaps by 10% due to encumbrance more than the weight.

Fatigue Factor: Unchanged; normal.

P.S.: As per the natural animal.

Armor Rating: 18, which means a higher roll (with bonuses) could penetrate the armor and kill the horse instantly.

M.D.C. by Location:

* Front Legs (2) — 40 each

* Rear Legs (2) — 60 each

Chest — 90

Head & Neck — 100

Main Body Armor — 140

Note: The usual penalties apply in regard to hitting a moving and weaving target as they do for bionic animals (-3 and -7).

Market Cost: 24,000 credits; sometimes 10-30% less during sales or when the armor is used or stolen. Warlord cost is 6,000 credits.

Body Armor

All Russian environmental body armors have the following properties.

- A minimum of 30 M.D.C.
- Complete environmental battle armor suitable for use in most hostile conditions.
- Computer controlled life support system that can tolerate temperatures as low as 50 degrees Fahrenheit below zero (-46 C).
- Artificial air circulation systems, gas filtration, humidifier.
- Computer controlled, independent oxygen supply and purge system that automatically engages in low oxygen or contaminated air environments. Minimum of three hour oxygen supply.
- Insulated, high temperature resistant shielding for up to 200 degrees Centigrade. Normal fires do no damage. Nuclear, plasma, and magic fires do full damage.
- At least minimal radiation shielding. Most suits can protect at up to 100 Rads of radiation or higher.
- Polarized, light sensitive/adjusting tinted visor.
- Directional short-range radio built into the helmet. Range is 5 miles (8 kilometers).
- Helmet face plate or visor is removable (in most cases). The M.D.C. of a typical helmet is 50.
- Skill penalties: -5 to -30% on prowl, acrobatics, gymnastics, climbing and swimming. Typically, the heavier or bulkier the armor, the greater the penalty.

Note: Most Sovietski armor, vehicles and equipment are red, or red and black, or black and grey with red insignias and accents. The heads of households, as well as members of local militias, village defenders and young **turks**, will possess a suit of M.D.C. armor (sometimes homemade) and at least one M.D. weapon, typically a rifle and/or **Vibro-Blade**.

For worldwide continuity, prices are presented in universal credits. The equivalent in Rubles (Rb) is twice that of the universal credits. Also note that most villagers and wilderness people won't accept Rubles or Universal Credits! Instead they trade goods and services for everything.

Homemade M.D.C. Armor

Homemade or piecemeal armor (also referred to as "hodge-podge" armor) is typically composite armor made from M.D.C. animal hides and bone, and pieces salvaged from modern armor or specially ordered. Salvage pieces are typically ceramic or alloy **vambraces**, helmets, and arm, shoulder, leg and chest plates. **Unfortunately**, homemade armor usually looks it, and is *never* environmental armor (has none of the usual features noted previously). However, some customized homemade armor looks very nice and may have a more traditional or classical "knight" design and styling.

- M.D.C. Range: 30-45 for light armor; 50-65 for medium armor. Heavy armor is not possible.
- Weight: 25-35 pounds (11.2 to 15.7 kg).

- Fair mobility; a penalty of -10% applies to the skills prowl, climb, swim, acrobatics, and gymnastics.
- Cost: 8,000-12,000 credits. Good availability even in wilderness regions.

Trapper Body Armor

A high-tech, non-environmental body armor worn by hunters, trappers, loggers and other "working" individuals who must spend time away from the relative protection of their village or city, and who want a light, mobile suit. The armor resembles a suit of quilted or padded armor with chest plates, and forearm plates with elbow protection. The thighs and lower legs are also protected by plates and each arm has a retractable Vibro-Blade built into the forearm vambrace, which is used for self-defense or work.

- **M.D.C.:** 45
- Weight: 10 pounds (4.5 kg)
- **Vibro-Blades** inflict 2D4 M.D. each.
- Superior mobility, no penalties!
- Cost: 12,000 credits. Excellent availability and very popular among members of the Warlords' Camps; even some of the Warlords use it when they feel relatively safe and are looking for a comfortable suit of light armor.

Sovietski "Red Star" Medium Body Armor

Red Star body armor looks very similar to the Sovietski light cyborg armor except it has a full (removable) face plate that is a one-way mirrored surface (the wearer can see out, but others can't see in). The most distinguishing features of this armor are that it doesn't have the shoulder or helmet **spikes**, and the padded undergarment on the legs and arms is a deep red rather than black, and the smooth, overlapping super-ceramic plates are grey. The trademark Star emblem is, of course, red. This armor is worn by non-cyborg Sovietski troops and police.

- **M.D.C.:** 75
- Weight: 18 pounds (8.1 kg)
- Good mobility, with a penalty of -10% applied to the skills prowl, climb, swim, acrobatics, and gymnastics.
- Black Market Cost: 28,000-32,000 credits with the spikes put back (customers love **'em**), and the Soviet Red Star typically replaced with a laughing or burning skull. This bootlegged, knock-off armor is available in the following colors (the first color designates the color of the plates): Steel blue and black, grey and dark blue, winter camouflage of white and light grey, desert colors of tan and warm grey, forest colors of greenish grey and dark green, or completely painted in camouflage patterns of green, grey and brown. Good availability outside the Sovietski and sold by the Black Market/Russian Mafia and Poles. **Note:** This bootleg armor is illegal in the Sovietski and visitors wearing it must remove it and pay a 500 credit fine, or leave the territory. This armor is never worn by the members of a Warlord's Camp, except for the purpose of disguise and infiltration.

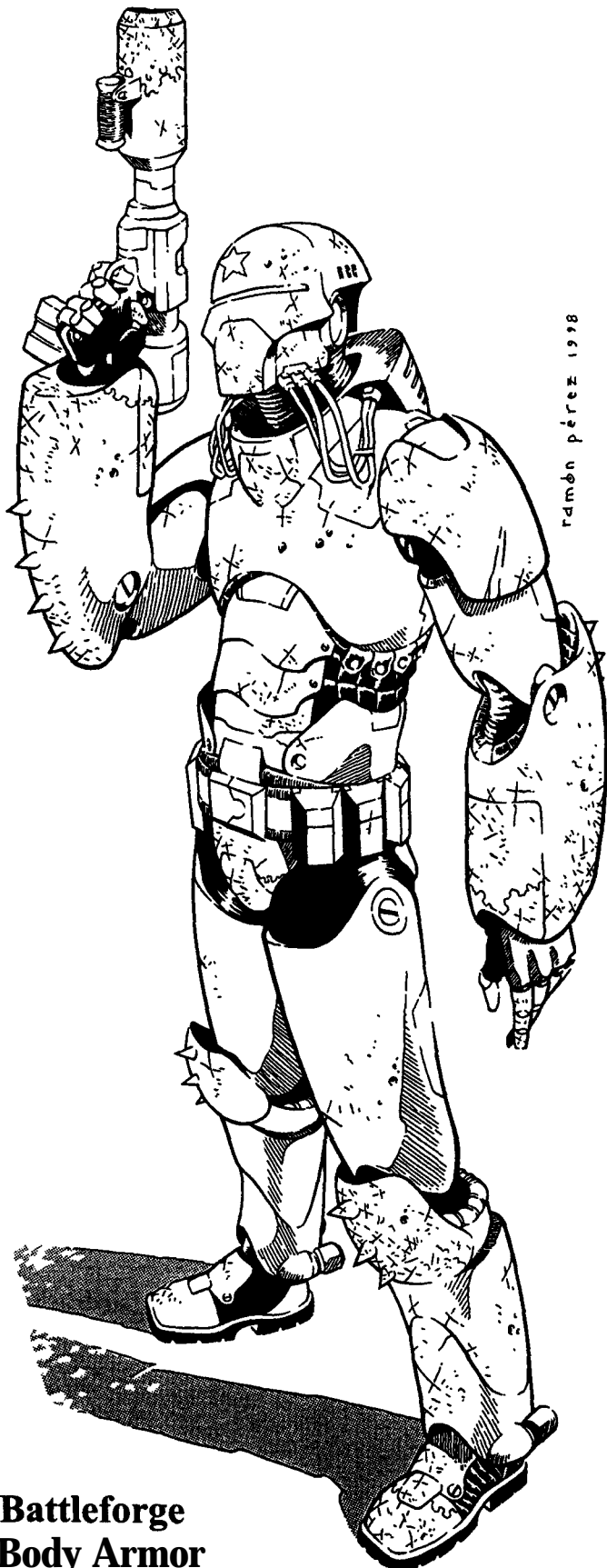

Battleforge Body Armor

A suit of heavy environmental armor popular among the Warlords' troops, mercenaries and adventurers. It is heavily armored with lightweight ceramic and composite armor, and comes with all standard body armor features. The forearms feature a low profile storage compartment about two inches deep, and a

retractable **Vibro-Blade** (1D6 or 2D4 M.D.) can be installed for an extra 6,000 credits. The back plating has modular clamps and housings for easy attachment of a jet pack, power pack, rail gun ammo-drum or other backpack.

- M.D.C.: 90 and the helmet has 60 M.D.C.
- Weight: 25 pounds (11.2 kg).
- Fair mobility; a penalty of -20% applies to the skills prowl, climb, swim, acrobatics, and gymnastics.
- Cost: 27,000-30,000 credits. Good availability throughout Western Russia dominated by the Warlords, fair availability in wilderness regions, Mongolia, Poland and Romania.

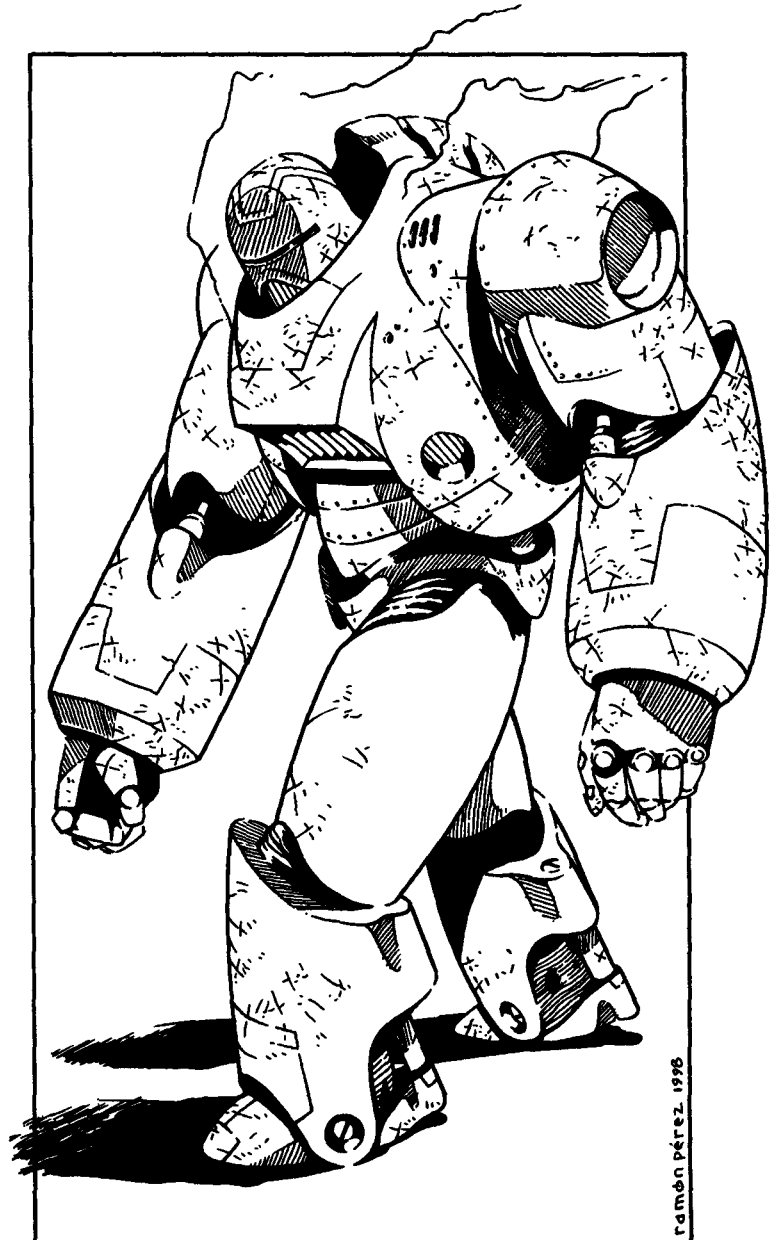

Bear Body Armor

The Bear armor is a full environmental suit of body armor that is big and bulky, with thick arms, legs and a barrel chest.

It is quite possibly, the most heavily plated "body armor" ever produced by anybody. It has a reinforced exoskeleton that enables the wearer to manage the heavy load of the armor, as well as to carry and lift great weights (up to 1200 lbs/540 kg).

Yet even with the robot enhancement of the exoskeleton (making it basic, light power armor), the armor is best suited for Light Machines, partial cyborgs and humanoids with great strength. A special heating and circulation system makes the armor able to tolerate temperatures as low as -100° Centigrade (-148° Fahrenheit). That and its heavy armor makes it popular in Siberia and other cold and hostile wilderness regions.

- **M.D.C.:** 150 — Helmet has 70 M.D.C.
- **Weight:** 160 pounds (72 kg).

- **Height:** Generally 1-2 feet (0.3 to 0.6 m) taller than the wearer.
- **Exoskeleton** provides a robot P.S. of 26, capable of inflicting Mega-Damage: 1D4 M.D. from a restrained punch, 1D6 M.D. from a full strength punch or kick, and 2D6 M.D. for a power punch (counts as two attacks).
- **Poor to fair mobility;** a penalty of -30% applies to the skills prowl, climb, swim, acrobatics, and gymnastics.
- **Black Market Cost:** 75,000 credits. Fair availability.

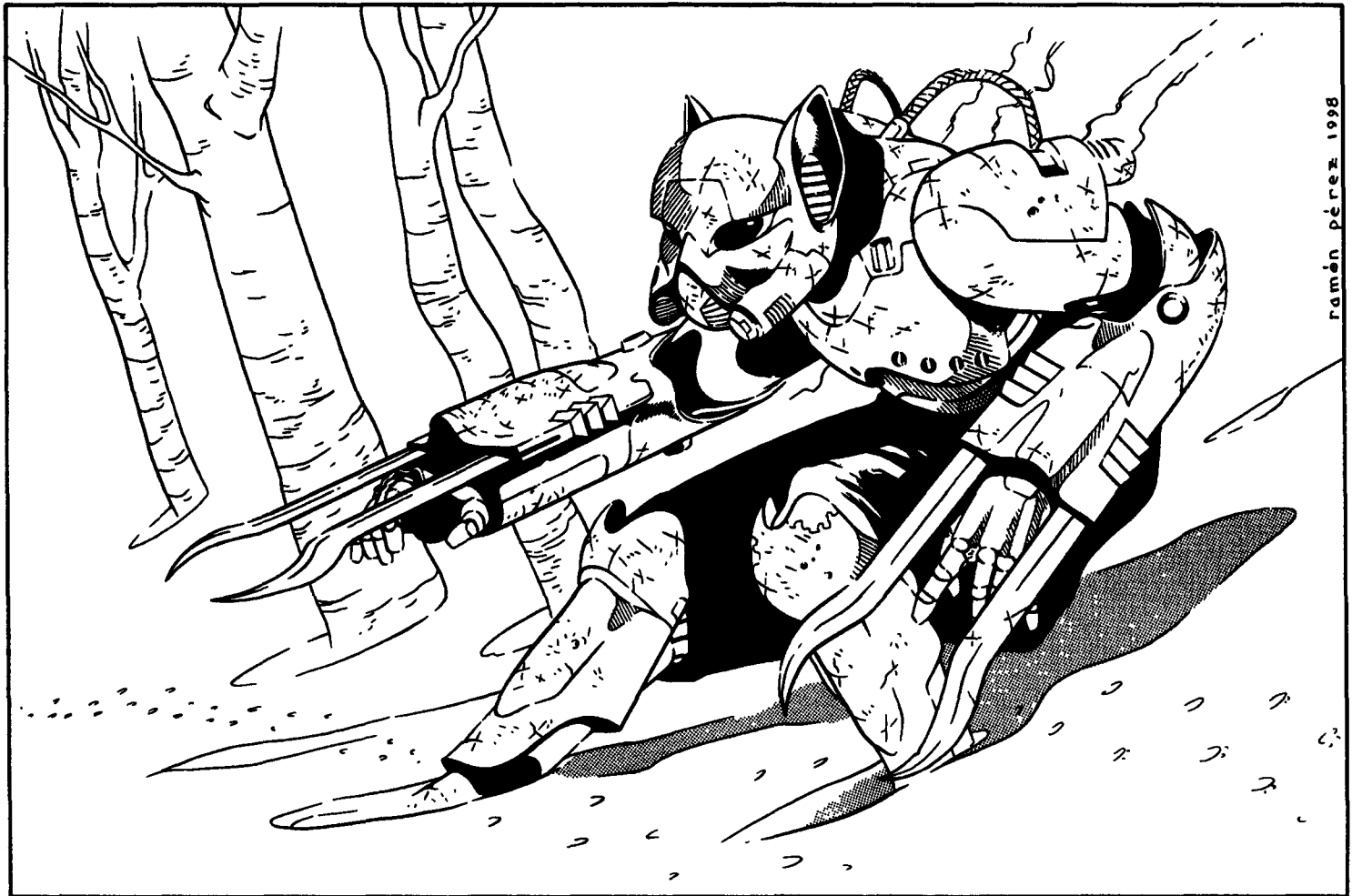

Lynx Body Armor

A fully environmental body armor with stylized helmet guards and sound amplification system (basically the same as the bionic *amplified hearing*, page 231 of the Rifts RPG) that resemble the ears of a lynx. The helmet also has a feline appearance. A pair of long, curved retractable **Vibro-Blades** on each forearm gives the "cat" its claws and bite. It has seen large production in the northern and western regions of Russia and is a favorite with adventurers, explorers and the **Kolodenko War Camp** who originally designed the armor. The armor features a number of slots and connectors for hooking items to the armor.

- **M.D.C.:** 60; the helmet has 40 M.D.C.
- **Vibro-Blades:** A single, large blade does 2D6 M.D., a single pair does 4D6 M.D. and offers a bonus of +1 to parry.
- **Weight:** 17 pounds (7.6 kg).
- **Excellent mobility;** a penalty of -5% applies to the skills prowl, climb, swim, acrobatics, and gymnastics.

- **Black Market Cost:** 26,000 credits. Excellent availability. Another great Kolodenko design that has been pirated and sold as **knock-offs**.

Cyborg Battle Armor

Light and Heavy Machines automatically enjoy M.D.C. protection from their mechanical limbs and augmentation. However, they can also wear additional body armor. Cyborg body armor is usually denser and heavier because the bionic frame and robot strength can handle it. This also means the armor offers superior protection. These armors may offer full environmental protection or not.

The Cyborg Battle Armor depicted here is a basic example of medium-heavy body armor for Light and Heavy Machines of a **humanoid** configuration. It can be customized with additional spikes, spines, blades, designs, and **insignias**, as well as modified to accommodate bionic weapons and features.

Minsky Mekanikal

MM-61 Explorer Exoframe

The Explorer Exoframe is effectively a crude suit of heavy-duty, all-purpose robot or power armor. Although originally designed for exploration, it is used for **construction, repair,** mining, and hauling cargo. The pilot's cockpit housing is roomy enough to accommodate a human in body armor, a Light Machine or even a relatively small Heavy Machine cyborg (must be under 7.6 feet/2.3 m tall and be human shaped). The operator steps backwards into the external harness (parachute style), straps in and is supported by a cushioned seat. Since the pilot area is open to the air, most operators wear body armor for **pro-**tection. However, the heavy plating of the back and sides do offer some protection, making the pilot vulnerable only from the front. The Explorer Exoframe is also equipped with a **Cyber-Link** system so cyborgs can jack right in and use the exoskeleton with superior skill (the usual bonuses).

Size: 12 feet (3.6 m) tall and 6.6 feet (2 m) wide.

Weight: 2.4 tons.

Physical Strength: Equal to a Robot P.S. of 35.

Hand to Hand Damage:

Crush/Squeeze with Hand: 1D4 M.D.

Restrained Punch and Stomp: 1D4 M.D.

Full Strength Punch or Kick: 2D4 M.D.

Power Punch: 3D6 M.D., but counts as two attacks.

M.D.C. by Location:

Hydraulic Arm (1) — 100

Other Arm (1) — 124

* Underarm Tool (1) — 25

* Concealed Laser (1) — 15

* Hands (2) — 35 each

Legs (2) — 80 each

Feet (2) — 90 each

* Spotlights (4) — 2 each

Main Body — 200

* Items marked by an asterisk are difficult targets to strike, require a Called Shot, and the attacker is -3 to strike. Destroying the main body turns the exoskeleton into scrap.

Power Source: Two **E-Packs** (24 hours of use per pair of packs); each **arm/tool/weapon** is also powered by an E-Pack. Or nuclear.

Speed: 25 mph (40 km) on land, half underwater; maximum depth is 500 feet (152 m), or less, depending on what the pilot is wearing.

Features of Note:

- Hydraulic hand and arm (1; right or left): Extends up to an additional 5 feet (1.5 m). A modular tool system is built into the underarm. It can be any of the following:

Plasma **torch/flamethrower:** 2D6 M.D.; 50 **foot/15 m** range.

High-powered laser: 3D6 M.D.; 2000 **foot/610 m** range.

Extendible Heavy Drill: Does 5D6 S.D.C., 1D6x10 S.D.C., 2D4x10 S.D.C., One M.D., 1D4 M.D. or 1D6 M.D.; can extend two feet beyond the hand when the hand is retracted.

The other hand cannot be extended but has a concealed laser in the forearm. The laser is intended for use as a tool for cutting and welding metal and stone, and excavation. It can regulate the amount of damage as follows: One M.D., 1D6 M.D., 2D6 M.D. and 3D6 M.D.; 1200 **foot/366 m** range.

- Three mini-missiles can be mounted on each forearm.

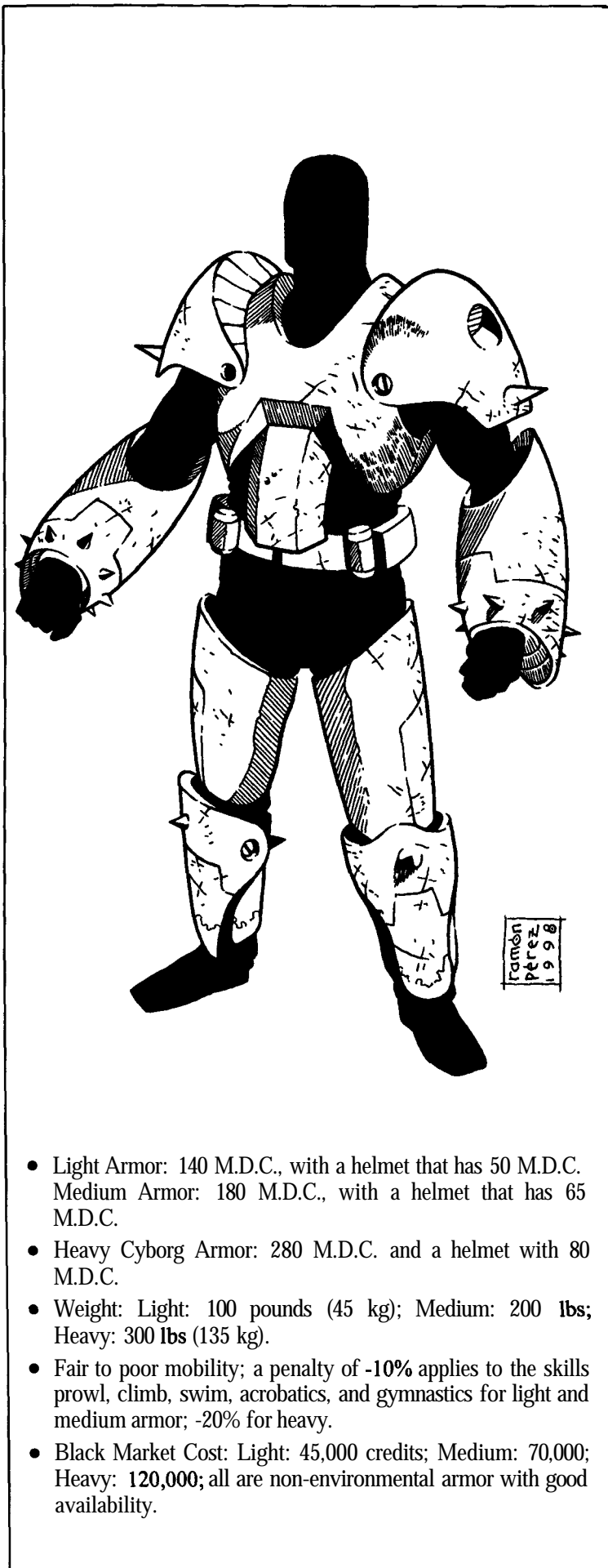

- Light Armor: 140 M.D.C., with a helmet that has 50 M.D.C. Medium Armor: 180 M.D.C., with a helmet that has 65 M.D.C.
- Heavy Cyborg Armor: 280 M.D.C. and a helmet with 80 M.D.C.
- Weight: Light: 100 pounds (45 kg); Medium: 200 **lbs**; Heavy: 300 **lbs** (135 kg).
- Fair to poor mobility; a penalty of -10% applies to the skills prowl, climb, swim, acrobatics, and gymnastics for light and medium armor; -20% for heavy.
- Black Market Cost: Light: 45,000 credits; Medium: 70,000; Heavy: 120,000; all are non-environmental armor with good availability.

- Can carry one ton (plus the weight of the pilot), and can pull six tons (half speed).
- Other features include: Four small spotlights (range: 300 feet/91 m), radio communications system (10 miles/16 km), grapnel and rewind cord (200 feet/60 m).

Note: The explorer **exoframe** is not **environmental!** It is completely open to the air.

Black Market Cost: 750,000-900,000 credits for the E-Pack version; 2.8 million credits for the nuclear one (only 15% are nuclear). Good availability in western Russia, poor in the eastern wilderness.

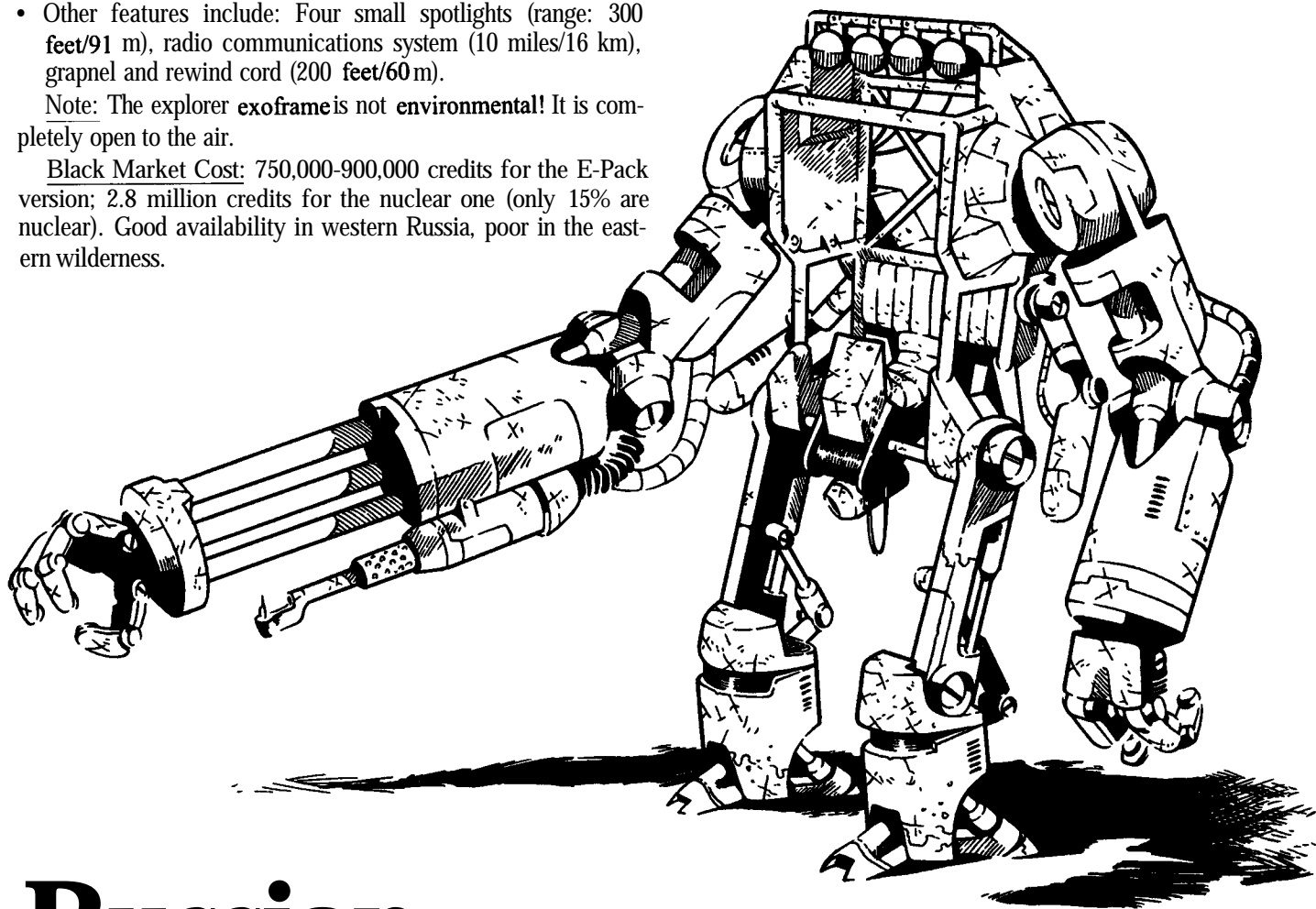

Russian Weapons

Generally, most Russian weapons are big and bulky. Many are attached to shoulder **and/or** back and chest harnesses with the gun itself "slung" under the arm or over the shoulder when not in use. Weapons, E & G-Clips, E-Packs, missiles, grenades, explosives, and **Vibro- Weapons** are all excellent trade goods, as well as the targets of raids by bandits, mercenaries and Warlord Reavers. As trade goods, one can usually get up to 80% market value, however, if selling for silver, gold, gems, Rubles, or credits, one will be lucky to get 33% (15-30% is typical).

Warlord weapons tend to be of the vicious and destructive nature, very much designed to kill and destroy. A Warlord desires to spread fear, to break his enemy's resolve and scatter him. Thus, wicked designs have emerged to maximize terror on the battlefield.

Exotic & Foreign Weapons

The most common foreign weapons, armor, vehicles, magic and equipment will come from the *New German Republic* and *Poland*; as will other characters, D-Bees, and monsters.

See **Rifts® World Book 5: Triax™** and the **NGR and Rifts® Sourcebook 3: Mindwerks™** — do not ignore these valuable references, especially **Mindwerks™** which has a large variety of D-Bees, monsters, magic and valuable world information.

Weapons, Vehicles, Rune Weapons, Magic Items and Symbiotes common to the **Splugorth** and their minions (as well as their minions themselves) *occasionally* make their way to Eastern Europe, Russia and Asia (more common in **Africa**, the Middle East and India); see **Rifts® World Book 2: Atlantis**.

Likewise, items from **Rifts® England, Africa**, and to a much lesser degree, **Rifts® Underseas** and **Japan**, as well as North America, *may* occasionally find their way to Russia and Asia, however they are very rare. Japanese items (and adventurers) are most likely to be found in the eastern portions of Asian Russia, Mongolia and China.

Additional Vampire Fighting Weapons: Russia offers all of the usual vampire fighting weapons found in **Rifts® World Book 1: Vampire Kingdoms™** but **techno-wizard** items are very rare.

E-Clips

E-Clip Adaptor: Western style E-Clips (including NGR/Triax and CS types) are too narrow to fit into Russian weapons so they are useless without an adaptor. The E-Clip snaps snugly into the wide housing of the adaptor, which in turn snaps into the weapon. Cost: 1,000 credits.

E-Packs: These are about half the size of a backpack and can be worn on the hip or on the back (2-3 can fit on the back of a human-sized character). A unit that looks like an **E-Clip** attached to a cable, is connected to the energy **pack/battery** to fit into a **weapon**, generator or other machine. **E-packs** can run everything from computers and light machines to generators and tractors.

Payload: A typical E-Pack is roughly equal to four standard **E-Clips** when used in a weapon, and can run 4-6 light machines like a computer, monitor, radio, light, fan, etc. for 72 hours before requiring recharging. It can run a jet pack, vehicle or generator for about 24 hours.

Cost: 35,000 for the E-Pack and 7000 credits to recharge it.

G-Clips: The **G-Clip** is the Russian style Long Energy-Clip with double the standard E-Clip capacity and is common for most weapons manufactured in Russia, Ukraine, Yugoslavia, Mongolia and parts of China. These Energy-Clips are a bit wider than the NGR and American CS types. The "G" stand for "gdye." An example of Russian pragmatism and humor in action, because Gdye means "where" in Russian. Most Russian energy weapons may take a standard type of E-Clip with an adaptor, as well as the G-Clip, but "where" the clip is loaded into the weapon can be dramatically different from weapon to weapon. Approximately 55% of all Russian energy rifles and handguns load on one side or the other, but some load from the top, others the bottom, others in the handle or in the back, or are connected to an E-pack or other power source. **Cost:** **G-Clips** sell for 4,500 credits for short clips (up to 20 shots), and 4,500 credits for long clips (50 shots). Excellent availability.

M.D.C. Shields

War-Knight Combat Shield: A relatively small to medium-sized shield made of reasonably light Mega-Damage materials. It is most commonly used by War-Knights, **Bogatyr**, and Cavalry troops for additional protection when charging and to parry Mega-Damage melee weapons like **Vibro-Blades**, **Neuro-Maces**, and magic weapons. A shield *cannot* be used to block bullets, rail gun burst, energy blasts, or magic energy bolts, at least not easily. Any such attempt is done without any bonuses (straight die roll) with a penalty of -8 to parry! Blocking thrown rocks, knives, spears and other weapons is basically the same but are only -3 to parry on an unmodified die roll.

The shield has 30 M.D.C. and only really takes damage when used to block energy blasts, explosions or is specifically targeted by an opponent with the intention of destroying or chopping through the shield. **Cost:** 12,000 credits. **Weight:** 15 pounds (6.8 kg).

Heavy Cyber-Shield: A large, heavy Mega-Damage shield, designed for gritty battlefield conditions. The smallest is four feet (1.2 m) tall, the largest is six feet (1.8 m). They can be used by any character with a P.S. of 25 or higher and is designed to clamp on to the forearm of body armor, power armor or bionic limb. The shield is actually a machine in itself with sliding panels that moves back and forth hydraulically, to better distribute damage done to it. This is accomplished through sensor arrays lining the shield's edges (not visible save as circuitry). The **Cyber-shield** is used by heavy cyborgs in all the Warlord Camps, but is not overwhelmingly popular.

Like any shield it offers protection when charging and the ability to parry Mega-Damage melee weapons. A shield *cannot* be used to block bullets, rail gun burst, energy blasts, or magic energy bolts, at least not easily. Any such attempt is done without any bonuses (straight die roll) with a penalty of -8 to parry! Blocking thrown rocks, knives, spears and other weapons is basically the same but are only -3 to parry on an unmodified die roll.

A large shield has 90 M.D.C. and a small, human-sized shield has 40 M.D.C. It only takes damage when used to block energy blasts, **missiles**, explosions or is specifically targeted by an opponent with the intention of destroying or chopping through the shield. **Cost:** Small: 20,000; Large: 26,000 credits. **Weight:** 70 pounds (31.7 kg).

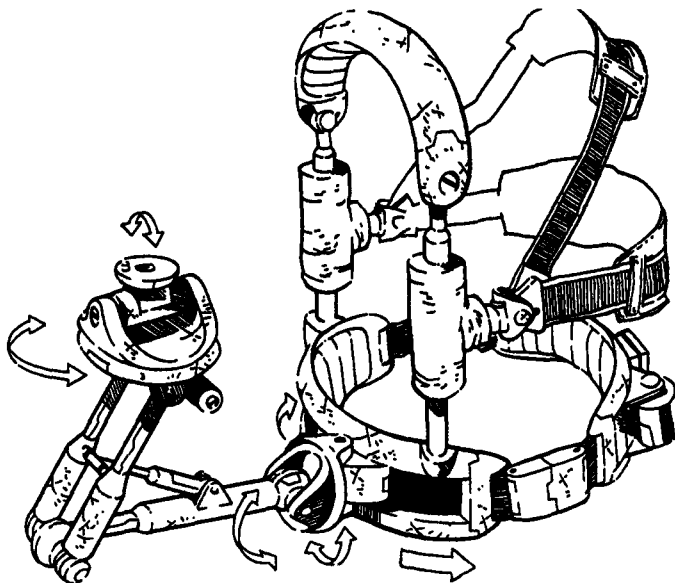

Servo-Harness Rig

Many heavy weapons are supported with a shoulder **and/or** back and chest harness, with the gun itself "slung" under the arm or over the shoulder when not in use. This harness is called a "Servo-Harness Rig," or simply a "Servo-Rig" or even just "The Rig."

The Rig enables ground troops to carry and use weapons larger and heavier than they could normally handle. This includes rail guns, heavy energy weapons/cannons, and missile launchers. It is worn like a parachute harness over body armor. There are two popular styles of the Weapon Rig, but both are made of padded, M.D.C. metal bars and M.D.C. ceramic plated straps linked to a gyro-stabilizer and a light hydraulic system. The weapon connector unit is modular to accommodate most heavy weapons of Russian manufacture. It lets an individual use the weight of his entire body to maneuver and hold a weapon steady, giving him the capability of fielding big guns normally reserved for cyborgs.

A weapon mated to the Servo-Harness rig must be worn under one arm or over the shoulder. What it all boils down to in game terms is that an individual with a P.S. as low as 9, can carry and use weapons equaling his body weight x2. *For Example:* Ivan weighs 160 pounds (72 kg) and has a P.S. Attribute of 11. Using a Servo-Harness Rig, he can now field a rifle weighing 320 pounds (144 kg).

Market Cost: 8,000 credits (2200 for the Warlords to make it).

Rail Guns

The **Ammodyne series of rail guns** are pre-Cataclysm relics of the Soviet Military Machine unearthed and reverse engineered. They are manufactured and sold by the **Sovietski**, Poland and the Black Market, as well as offered by numerous arms dealers in and around Russia.

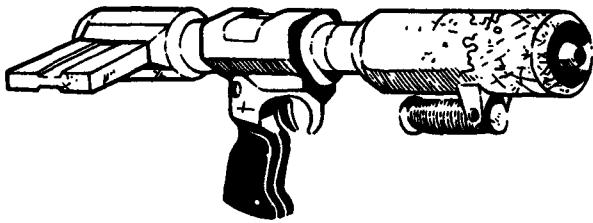

AR-36 "Clenched Fist" Light Rail Gun

The AR-36 is a light but rugged rail gun popular among Reavers. It is designed in the "bullpup" configuration (ammo clip or belt feed inserts behind the grip), and uses a **g-clip** or power feed directly from a cyborg to power it. The weapon is light and small enough to be used one in each hand by Heavy Machines and Cyborg **Shocktroopers**; two-handed by most ordinary humans and Light Machines (-3 to strike if used one-handed).

Primary Purpose: Anti-Personnel

Weight: Gun: 30 pounds (13.5 kg) plus one short ammo-clip (8 lbs/3.6 kg), or one ammo-belt (300 rounds; 12 lbs/5.4 kg), or a 1200 round ammo-drum (50 lbs./22.5 kg) hooked to a Servo-Harness Rig. The weapon has 40 M.D.C.

Mega-Damage: A burst is 10 rounds and inflicts 3D6 M.D.C. per burst.

Rate of Fire: Only fires bursts of 10 rounds. Each burst counts as one melee attack.

Maximum Effective Range: 3,000 feet (914 m)

Payload: 100 round mini-clip (10 bursts), 300 round belt (30 bursts) or full 1200 round drum (120 bursts).

Market Cost: 30,000 credits, plus most humans will need a Rig to handle it, unless they have a P.S. of 24 or greater. Without a Rig the character is -10% to climb and prowl, acrobatics, gymnastics and swimming are impossible, and speed is reduced by 40%. With the Rig the first penalties are negated, and speed is normal, but acrobatics, gymnastics and swimming are still impossible.

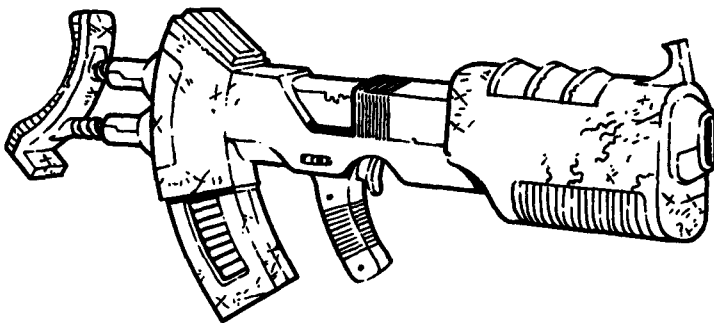

AR-41 "Howler" Rail Gun

The Howler is the intermediary, medium weight rail gun, designed in a "bullpup" configuration. It has a large top-loading

banana clip for an extra ammo reserve and a built-in shock absorption system.

Primary Purpose: Assault

Weight: Gun: 100 pounds (45 kg); plus E-pack, and dual ammo-clips (15 lbs/6.7 kg), or one ammo-belt (400 rounds; 20 lbs/9 kg), or a 2000 round ammo-drum (100 lbs./45 kg) hooked to a Servo-Harness Rig. The weapon has 80 M.D.C.

Mega-Damage: A burst is 15 rounds and inflicts 4D6 M.D.C.

Rate of Fire: Only fires 15 round bursts, and each counts as one melee attack.

Maximum Effective Range: 4,000 feet (1200 m)

Payload: 120 round mini-clip (8 bursts), 300 round belt (20 bursts) or full 2000 round drum (133 bursts).

Market Cost: 60,000 credits, plus humans will need a Rig to handle it.

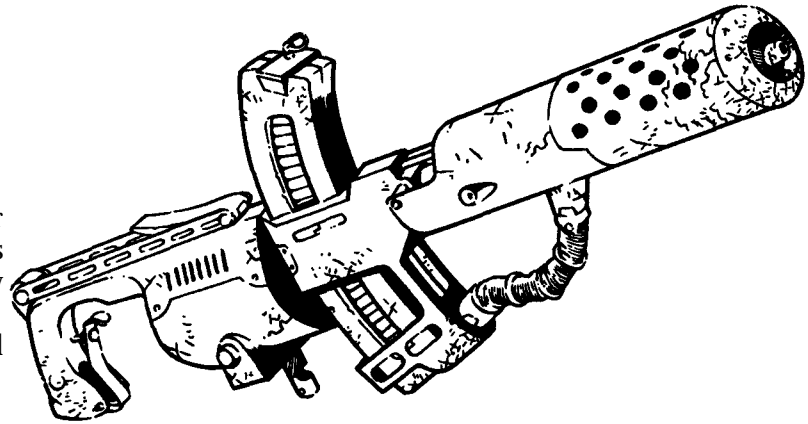

AR-44 "Sledgehammer" Rail Gun

The AR-44 is unique for its very high rate of fire. It uses an experimental chambering system that forces shells into the weapon chamber at a higher pressure, coupled with a timing system set about as high as its designers could make it. It is also a heavy weapon, designed as an anti-vehicle, **anti-Borg** and anti-monster weapon. AR-44s have been used extensively by Warlords **Burgasov**, **Kolodenko**, **Seriyev** and **Sokolov**.

Primary Purpose: Anti-Armor & Monsters.

Weight: Gun: 150 pounds (67.5 kg); plus E-pack, and one ammo-clip (200 rounds; 20lbs/6.1 kg), ammo-belt (500 rounds; 35 lbs/15.7 kg), or a 3000 round ammo-drum (140 lbs./63 kg) hooked to a Servo-Harness Rig. The weapon has 100 M.D.C.

Mega-Damage: A burst is 20 rounds and inflicts 1D4x10 M.D.C. per burst.

Rate of Fire: Only fires 20 round bursts, and each counts as one melee attack.

Maximum Effective Range: 4,000 feet (1200 m)

Payload: 200 round clip (10 bursts), 500 round belt (25 bursts) or full 3000 round drum (150 bursts).

Market Cost: 80,000 credits, plus humans will need a Rig to handle it.

AR-60 "Nikita" Super-Rail Gun

This very large rail gun has a padded shoulder rest worn over the shoulder (something like the Glitter Boy **Boomgun**). It can be used by Heavy Machines and Cyborg Shocktroopers, but most humans and Light Machines can't handle it, even with a Rig, due to the weight and bulk.

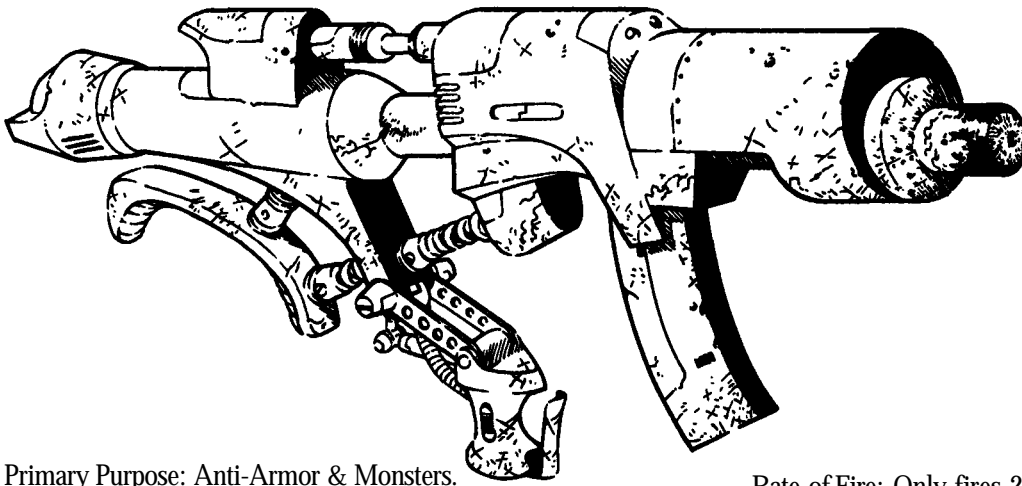

Primary Purpose: Anti-Armor & Monsters.

Weight: Gun: 250 pounds (120 kg); plus E-pack, and one ammo-clip (100 rounds; 20 lbs/6.1 kg), ammo-belt (500 rounds; 45 lbs/20 kg), or a 3000 round ammo-drum (180 lbs./81 kg); may be hooked to a Servo-Harness Rig or not. The weapon has 120 M.D.C.

Mega-Damage: A burst is 20 rounds and inflicts **1D6x10** M.D.C. per burst.

Rate of Fire: Only fires 20 round bursts, and each counts as one melee attack.

Maximum Effective Range: 5,000 feet (1520 m)

Payload: 100 round clip (5 bursts), 500 round belt (25 bursts) or full 3000 round drum (**150** bursts).

Market Cost: **110,000** credits, plus humans will need a Rig to handle it.

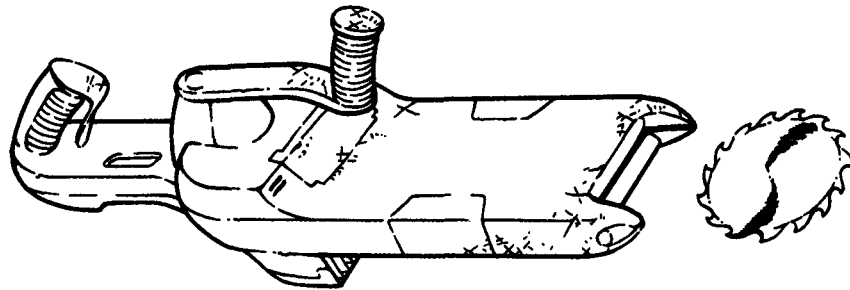

AR-110 Razor Disk Cannon

The AR-110 is an interesting weapon development, employing a Lateral-Magnetic (L-Mag) rail system. The whole thing is just wider and flatter than a normal rail gun. It fires M.D.C. discs, about twice the size of a 20th century compact disc, at Mach speed velocity. However the distance is dramatically less than most true rail guns. A Servo-Rig is required by humans and it is sometimes used by 'Borgs.

Primary Purpose: Anti-Armor & Monsters.

Weight: Gun: 150 pounds (67.5 kg); plus E-pack, and one ammo-belt (200 rounds; 35 lbs/15.7 kg), or a 2000 round

ammo-drum (180 lbs./81 kg); may be hooked to a Servo-Harness Rig or not. The weapon has 80 M.D.C.

Mega-Damage: A single blade does **1D6** M.D. and a burst **fires 10** discs to inflict **1D6x10 M.D.C.**, but counts as two melee attacks. Rate of Fire: One at a time or a 10 round burst; bursts count as two melee attacks.

Maximum Effective Range: 2,000 feet (**610**m)

Payload: 200 round belt (20 bursts) or full 2000 round drum (200 bursts).

Market Cost: 80,000 credits, plus humans will need a Rig, at **8,000 credits**, to handle it.

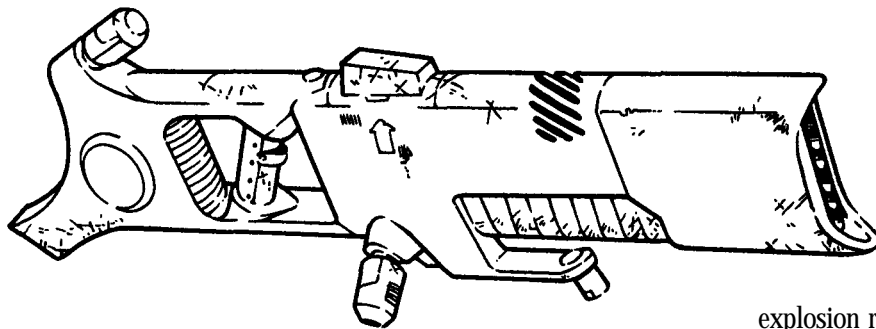

AR-210 Grapeshot Cannon

This weapon fires a nasty payload of M.D.C. rockets which explode on impact or at 3500 feet, whichever comes first. The

explosion releases a volley of tiny metal balls that inflicts damage, shotgun style, to a larger area. This is a favorite weapon of Warlords Orloff and Sokolov.

Primary Purpose: Anti-Armor & Monsters.

Weight: Gun: 200 pounds (90 kg); plus E-pack, and ammo-belt

(100 rounds; 35 lbs/15.7 kg), or a 1000 round ammo-drum (180 lbs./81 kg); may be hooked to a Servo-Harness Rig or not. The weapon has 100 M.D.C.

Mega-Damage: A single round does 1D6 M.D. and a burst fires 10 rounds to inflict 1D6x10 M.D.C. to a target under 3500 feet (1066.8 m).

The shotgun effect occurs at 3500 feet (1066.8 m) and the **grapeshot** hurls another 500 feet (152 m) for a total range of 4000 feet (1200 m). It does 3D6 M.D. (1 point of M.D.C. for a single shot) to everybody or everything in a 12 foot (3.6 m) wide area of fire (if one large, tank- or building-sized target, the grapeshot peppers it for 1D6x10 M.D./1D6 from a single shot). Note: The shotgun effect can also be set to occur at 1000 feet (305 m) and hurl the tiny balls another 500 feet (152m) for a total range of 1500 feet (457 m), for use against infantry troops.

Rate of Fire: One at a time or 10 round bursts; bursts count as two melee attacks.

Maximum Effective Range: 4,000 feet (1200m)

Payload: 100 round belt (10 bursts) or full 1000 round drum (100 bursts).

Market Cost: 100,000 credits, plus humans will need a Rig, at 8,000 credits, to handle it.

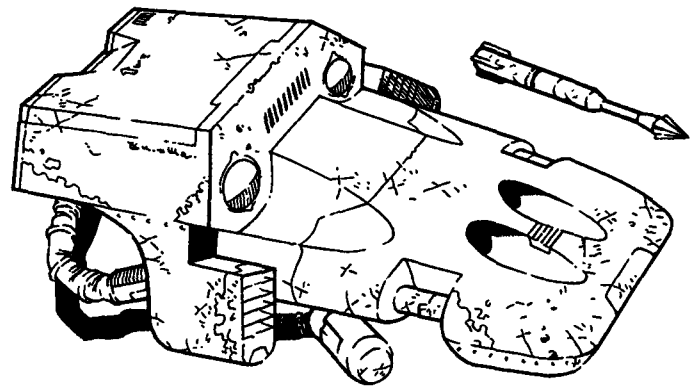

The top section launches four mini-missiles, while the lower, front launchers fire wooden stakes. Obviously, this weapon was designed for slaying vampires and similar creatures harmed by shafts of wood.

Primary Purpose: Anti-Vampire

Secondary Purpose: Anti-personnel and riot control.

Weight: Launcher: 50 pounds (22.6 kg) plus 20 pounds (9 kg) fully loaded. The weapon has 40 M.D.C.

Mega-Damage: Varies by missile type (typically 1D4x10M.D.). Wooden Stakes do 2D6 S.D.C. per single shaft (fired with great velocity) or 4D6 S.D.C. per twin shafts, or in a burst of four doing 6D6 S.D.C./H.P. damage.

Maximum Effective Range: Mini-Missiles: One mile (1.6 km).

Wooden Stakes: 1000 feet (305 m).

Rate of Fire: Mini-Missiles: 1 or 2. Wooden Stakes: 1-4.

Payload: Four mini-missiles; hand loaded, and 40 stakes.

Market Cost: 15,000 credits for the launcher, 2,000 credits each for light missiles, and 3,500 for heavy ones. Wooden stakes cost around 5 credits each.

Missile Launchers

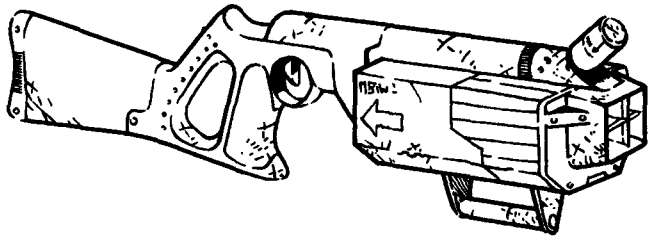

AR-M36 Rifle Mini-Missile Launcher

A rifle style mini-missile launcher that can be used by humans and Light Machines using a Servo-Rig, or by Heavy Machines one-handed. Point and shoot — tends to be front-heavy.

Primary Purpose: Anti-Aircraft & Flying Monsters.

Secondary Purpose: Anti-Armor and Cyborgs.

Weight: Gun 50 pounds (22.6 kg) plus 20 pounds (9 kg) fully loaded with eight mini-missiles. The weapon has 40 M.D.C.

Mega-Damage: Varies by missile type (typically 1D4x10M.D.).

Maximum Effective Range: One mile (1.6 km).

Rate of Fire: 1, or in volleys of 2, 3 or 4.

Payload: Eight mini-missiles; hand loaded. An extra pack of eight mini-missiles can be carried in a 20 M.D.C. case; weighs 30 lbs (13.6 kg). Takes two melee rounds (30 seconds) to reload.

Market Cost: 19,000 credits for the launch-rifle, 2,000 each credits for light missiles, and 3,500 for heavy ones.

AR-M40 Dual Launcher

The Dual launcher is comparatively, a small, light launcher that hooks to a Servo-Rig, although Heavy Machines can use it as a hand-held gun. A handle and trigger is located underneath the launcher, with a second handle for control in the back — it is a two-handed weapon for humans, even with a Rig.

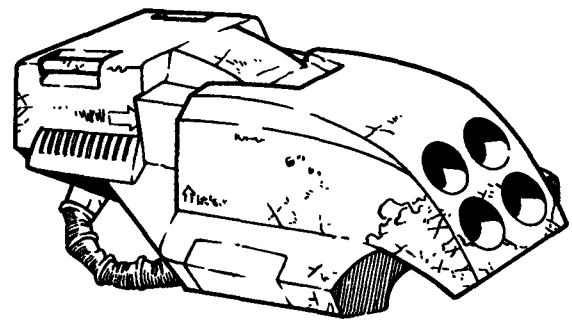

AR-M45 Cyborg Missile Launcher

A mini-missile launcher that can be used as a shoulder mounted weapon on Heavy Machines and Cyborg **Shocktroopers**, or as a Servo-Rig mounted weapon. In the latter case, there is a handle and trigger in the back of the launcher. It is a favorite among Heavy Machines.

Primary Purpose: Anti-Aircraft & Flying Monsters.

Secondary Purpose: Anti-Armor and Cyborgs.

Weight: Launcher: 80 pounds (36 kg) plus 30 pounds (13.6 kg) fully loaded. The weapon has 50 M.D.C.

Mega-Damage: Varies by missile type (typically 1D4x10M.D.).

Maximum Effective Range: One mile (1.6 km).

Rate of Fire: 1, or in volleys of 2, 3 or 4.

Payload: 12 mini-missiles; hand-loaded. An extra pack of eight mini-missiles can be carried in a 20 M.D.C. case; weighs 30 lbs (13.6 kg). Takes three melee rounds (45 seconds) to reload.

Market Cost: 25,000 credits for the launcher (has 40 M.D.C.), 2,000 credits each for light missiles, and 3,500 for heavy ones.

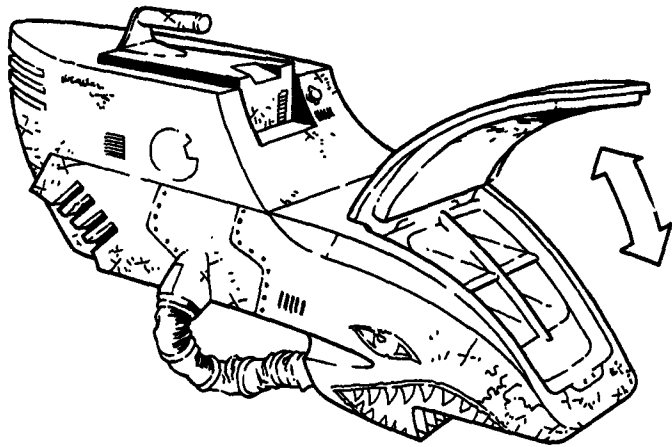

AR-M50 Heavy Missile Launcher

A massive mini-missile launcher that can be used as a shoulder mounted weapon on Heavy Machines and Cyborg Shocktroopers, or as a Servo-Rig mounted weapon. In the latter case, there is a handle and trigger in the back of the launcher as well as a handle in the top. Its shape, size and weight make it difficult to handle by humans, even with a Servo-Rig. Fortunately, one does not need to point the missiles with tremendous accuracy. It is a favorite among Heavy Machines as a hip blasting Servo-Rig unit.

Primary Purpose: Anti-Aircraft & Flying Monsters.

Secondary Purpose: Anti-Armor and Cyborgs.

Weight: Launcher: 140 pounds (63 kg) plus 44 pounds (20 kg) fully loaded. The weapon has 90 M.D.C.

Mega-Damage: Varies by missile type (typically 1D4x10M.D.).

Maximum Effective Range: One mile (1.6 km).

Rate of Fire: 1, or in volleys of 2, 3 or 4.

Payload: 18 mini-missiles; hand-loaded. An extra pack of eight mini-missiles can be carried in a 20 M.D.C. case; weighs 30 lbs (13.6 kg). Takes four melee rounds (one minute) to reload.

Market Cost: 45,000 credits for the launcher (has 45 M.D.C.), 2,000 credits each for light missiles, and 3,500 for heavy ones.

Energy Weapons

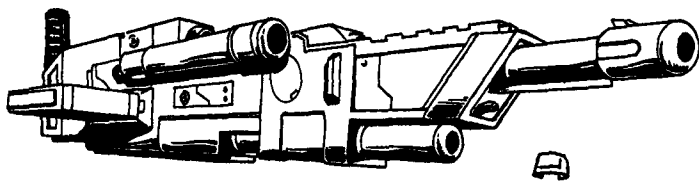

Belofsky Double-Dealer Laser Cannon

A massive, four-barreled, heavy energy weapon that can be used as a two-handed weapon by Light Machines and humans with a P.S. of 22, or one-handed by Heavy Machines and Cyborg Shocktroopers. The top barrel is a heavy laser, the one below it, a short-range ion blaster (the one on the side is a scope).

Primary Purpose: Assault

Weight: Gun: 60 pounds (27 kg). Backpack Weight: 55 pounds

(24.75 kg; holds two E-Packs). The weapon has 90 M.D.C. Mega-Damage: Laser: 3D6 M.D.; Ion Blaster 5D6 M.D.

Rate of Fire: Each blast counts as one melee attack. Both can not be fired simultaneously, so the shooter must pick one or the other.

Maximum Effective Range: Laser: 3000 feet (914 m); Ion: 2,000 feet (610 m).

Payload: Varies with power source; about 10 shots from a standard E-Clip and 100 from an E-Pack, but uses a dual pack system.

Market Cost: 65,000 credits.

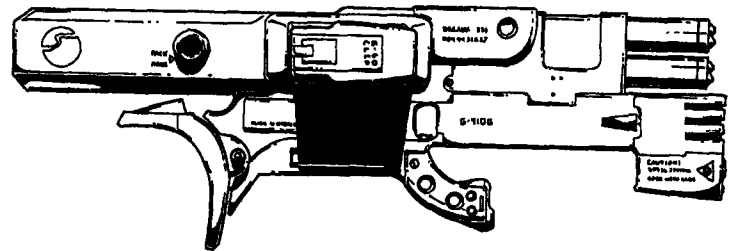

G-410C Goldbeam Laser Cannon

A bulky and ominous looking shoulder-mounted weapon used by Heavy Machines and Cyborg Shocktroopers, but can be used by Light Machines in conjunction with a Servo-Rig, as well as mounted on vehicles by cavalry troops as a heavy support weapon, and heavy assault piece. Support cavalry troops carry the G-410C, as well as heavy infantry and certain S & D squad members. It has four separate lasers that can be fired individually, one at a time, two at a time or all at once. The advantage of this cannon over the Belofsky is its lighter weight and versatility.

Weight: 135 pounds (61 kg); Backpack Weight: 55 pounds (24.75 kg; holds two E-Packs). The weapon has 70 M.D.C.

Mega-Damage: 3D6 M.D. per single blast, 6D6 per double blast or a rapid-fire burst from all four lasers, doing 1D6x10+10 M.D. (counts as one melee attack).

Rate of Fire: Each blast counts as one melee attack.

Range: 2,800 feet (853 m).

Payload: 20 single shots, 10 dual shots or 5 shots from a standard E-Clip, or 50 from an E-Pack, but typically uses a dual E-Pack system.

Market Cost: 124,000 credits.

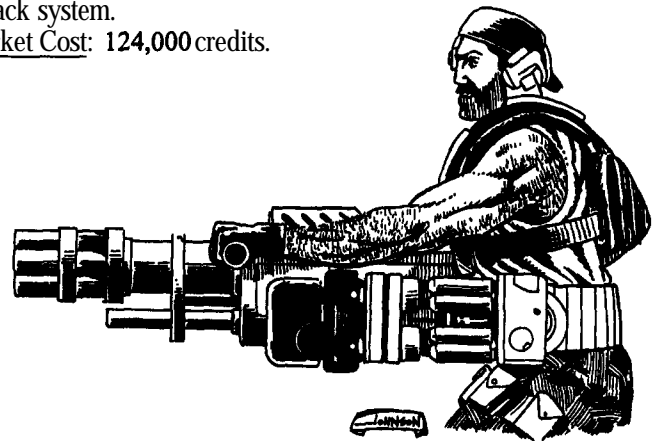

Belofsky Heavy Laser Cannon

A massive, four-barreled, heavy laser with increased range and payload. It is worn with a Servo-Rig. All barrels fire simultaneously.

Primary Purpose: **Anti-Vehicle**

Weight: Gun: 200 pounds (90 kg). Backpack Weight: 55 pounds (24.75 kg). The weapon has 110 M.D.C.

Mega-Damage: 1D6x10+10 M.D.; all barrels fire simultaneously.

Rate of Fire: Each blast counts as one melee attack.

Maximum Effective Range: 3,000 feet (914 m).

Payload: Three shots from a standard E-Clip, or 50 from an E-Pack, but typically uses a dual E-Pack system.

Market Cost: 90,000 credits.

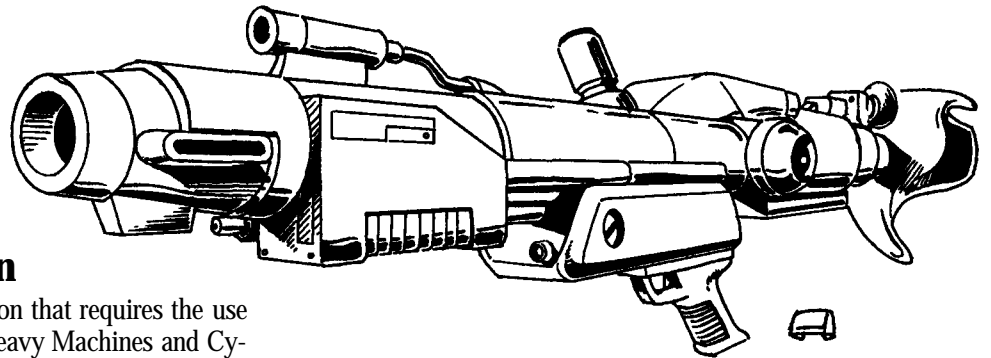

Belofsky Plasma Cannon

Another massive, heavy energy weapon that requires the use of a Servo-Rig when used by humans. Heavy Machines and Cyborg Shocktroopers can use it as a two-handed weapon.

Primary Purpose: **Anti-Vehicle & Anti-Monster.**

Weight: Gun: 170 pounds (76.5 kg). Backpack Weight: 55 pounds (24.75 kg). The weapon has 100 M.D.C.

Mega-Damage: 1D4x10+10 M.D.

Rate of Fire: Each blast counts as one melee attack.

Maximum Effective Range: 1,800 feet (548.6 m).

Payload: Varies with power source; four shots from a standard E-Clip and 70 from an E-Pack, but typically uses a dual E-Pack system.

Market Cost: 145,000 credits.

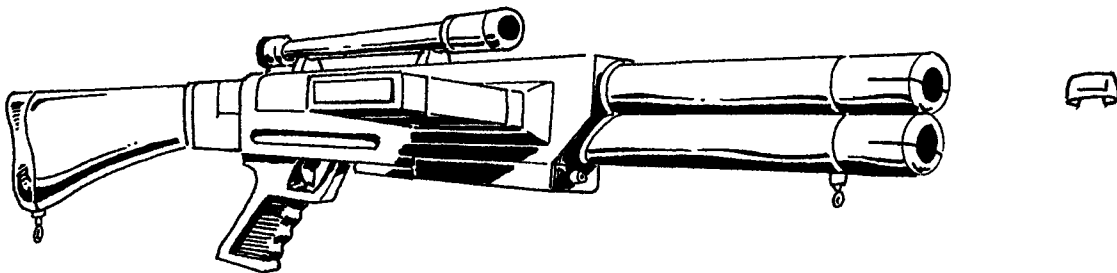

Lynx Laser Rifle

A dual-barrel Laser rifle that has proven to be sturdy and reliable. It is popular among Reavers, Huntsmen, assassins and adventurers as a backup or assault weapon. Its really interesting feature is that it can take either e-clips or g-clips.

Weight: 6 pounds (2.7 kg); has 35 M.D.C.

Mega-Damage: 2D6 M.D. from a single blast or 4D6 M.D. from a dual, simultaneous blast (counts as one melee attack).

Rate of Fire: Each blast counts as one melee attack.

Maximum Effective Range: 1,800 feet (548.6 m).

Payload: 20 shots from a standard E-Clip.

Market Cost: 19,000 credits.

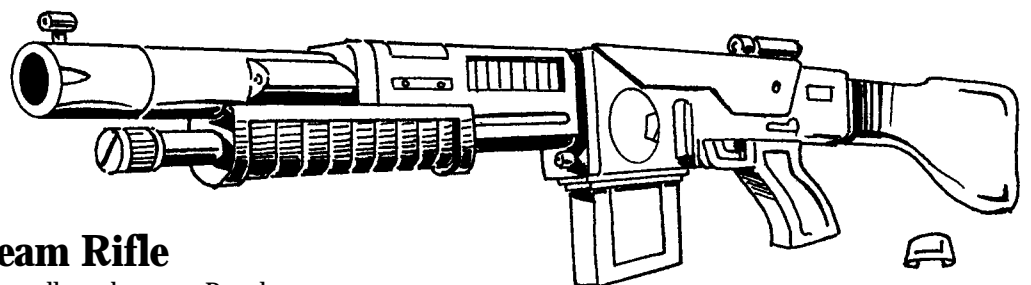

"Homesteader" Ion Beam Rifle

A heavy ion rifle for inflicting excellent damage. Popular among Reavers and soldiers of all kinds.

Weight: 9 pounds (4 kg); has 40 M.D.C.

Mega-Damage: 4D6 M.D.

Rate of Fire: Each blast counts as one melee attack.

Range: 1,700 feet (518 m).

Payload: 12 shots from a standard E-Clip.

Black Market Cost: 21,000 credits.

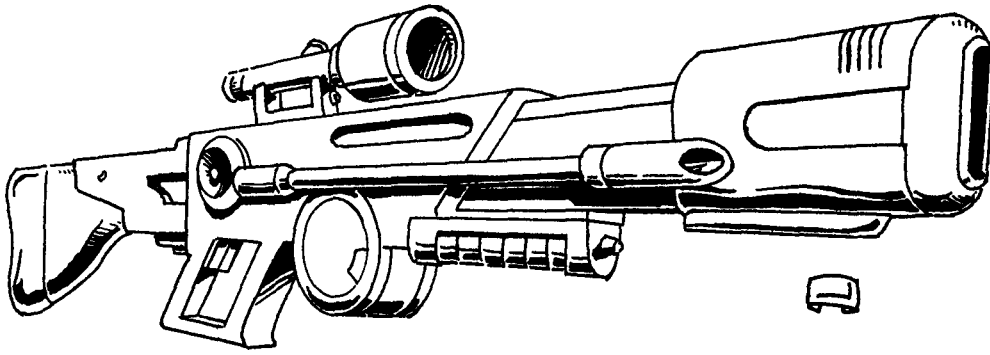

Big Bear Plasma Rifle

A heavy assault weapon that has been outlawed by the Warlords — only members of the War Camps may legally possess this weapon. However, that hasn't slowed down brisk trade through the Black Market and other criminal arms dealers and mercenaries. It is popular among War-Knights, Heavy Machines and adventurers, particularly the Huntsman-Trapper.

Weight: 14 pounds (6.4 kg); has 50 M.D.C.
Mega-Damage: 5D6 M.D. per single shot.
Rate of Fire: Each blast counts as one melee attack.
Range: 1,600 feet (488 m).
Payload: 10 shots from a standard E-Clip.
Market Cost: 29,000 credits.

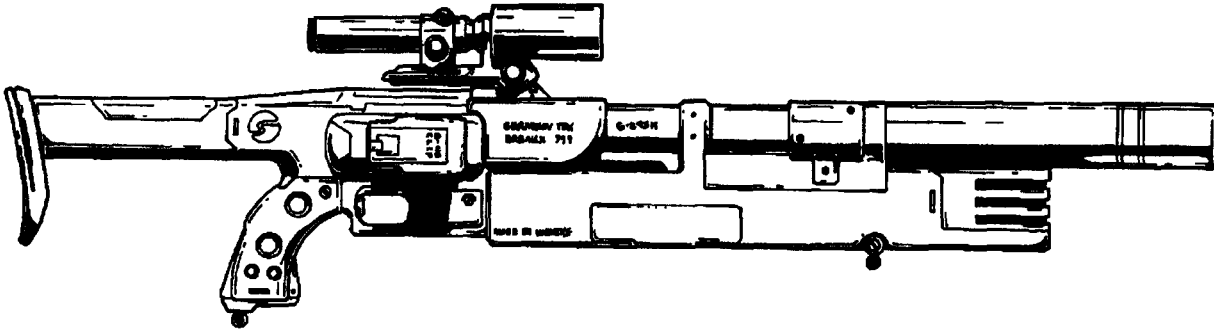

G-295R "Steamer" Pulse Laser Rifle

The "Steamer" is a long-range, heavy laser rifle that can be used as a single-shot sniper rifle. Comes standard with laser targeting and telescopic sight. It is popular among War-Knights, Heavy Machines and adventurers, particularly the Huntsman-Trapper.

Weight: 15 pounds (6.8 kg); has 45 M.D.C.

Mega-Damage: 4D6 M.D. per single shot.
Rate of Fire: Each blast counts as one melee attack.
Range: 2,200 feet (670 m).
Payload: 14 shots from a standard E-Clip.
Market Cost: 32,000 credits.

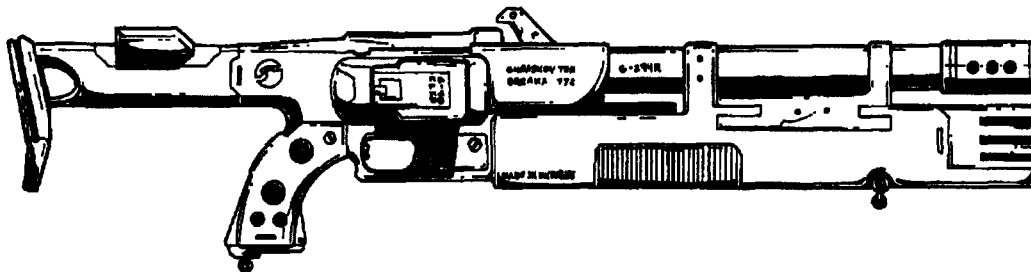

G-294R "Toughman" Laser Rifle

A superior quality, standard laser rifle that is effective, rugged and reliable in the field. It functions at up to 150 degrees Fahrenheit (-101 C) below freezing (most others jam up at 100 degrees below/-73 C). This weapon has been in use for over 60 years.

Weight: 13 pounds (6 kg); has 50 M.D.C.
Mega-Damage: 3D6 M.D. per single shot.
Rate of Fire: Each blast counts as one melee attack.
Range: 1,600 feet (488 m).
Payload: 20 shots from a standard E-Clip.
Market Cost: 32,000 credits.

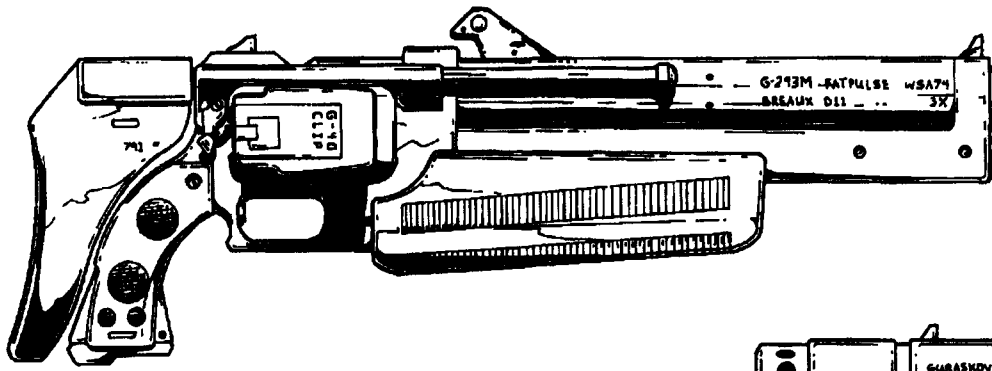

G-293M "Fat Boy" Laser

A short-barrel laser similar to a **sawed-off** shotgun or sub-machinegun, with an **over and under, pump**, grenade launcher. The weapon fires a laser from the top barrel and explosive **cartridges/bullets/rounds** from the lower barrel (a knock-off of the **Triax Pump** pistol). These explosive rounds have good range, and contain a powerful explosive charge. Another favorite among Reavers, War-Knights, Huntsmen, adventurers and heroes.

Weight: 6 pounds (2.7 kg); has 30 M.D.C.

Mega-Damage: 3D6 M.D. per single shot.

Rate of Fire: Each blast counts as one melee attack.

Range: Laser: 1,000 feet (305 m). Grenades: 800 feet (224 m).

Payload: Laser: 20 shots from a standard **E-Clip**. Grenades: Six rounds, and can be hand loaded in one melee round (15 seconds).

Market Cost: 32,000 credits.

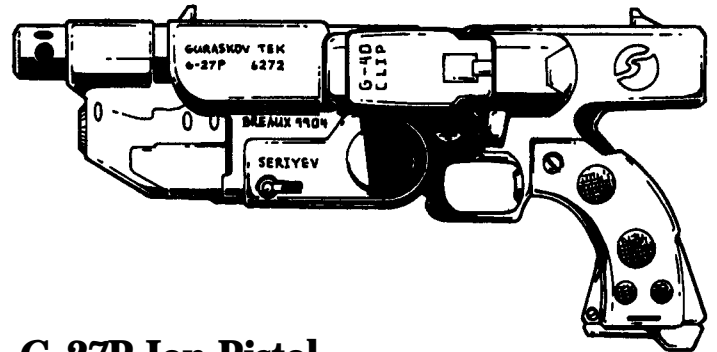

G-27P Ion Pistol

A universally popular sidearm found throughout Russia. It does more damage than the laser but has inferior range, as usual, but is another one of those super-reliable weapons that works underwater and in freezing temperatures.

Weight: 4 pounds (1.8 kg); has 30 M.D.C.

Mega-Damage: 4D6 M.D. per single shot.

Rate of Fire: Each blast counts as one melee attack.

Range: 500 feet (152 m).

Payload: 20 shots from a standard E-Clip.

Market Cost: 12,000 credits.

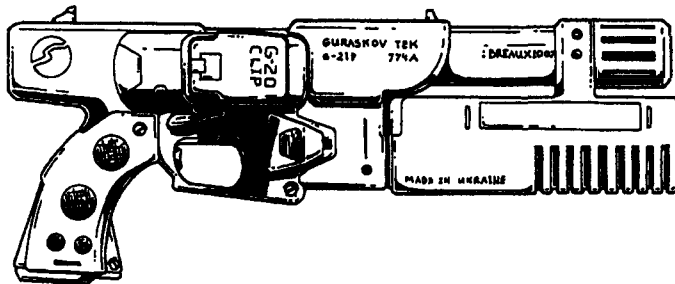

G-21P Laser Pistol

A universally popular, heavy laser **sidearm** found throughout Russia.

Weight: 4 pounds (1.8 kg); has 30 M.D.C.

Mega-Damage: 2D6 M.D. per single shot.

Rate of Fire: Each blast counts as one melee attack.

Range: Laser: 900 feet (274 m).

Payload: 20 shots from a standard E-Clip.

Market Cost: 12,000 credits.

Triax Weapons

Triax rifles, pistols, hand grenades, explosives, **Vibro-Blades**, Neural Maces, Electro-Maces and other giant-sized weapons, gun scopes and other equipment are either sold or "**knocked-off**" and sold by other manufacturers throughout Russia and the neighboring countries.

Odds & Ends

Vibro-Blades

All Vibro-Blades are blade weapons surrounded by an invisible high-frequency energy field that gives them Mega-Damage capabilities. They were originally developed by the Coalition States and "**knocked-off**" (imitated) by Triax and, ultimately, other weapon manufacturers. They are popular among Reavers, Russian cyborgs, soldiers, mercenaries, city rats, adventurers, bandits, Brodkil, and just about everybody else.

Vibro-Knife: 1D6 M.D. (2D4 M.D. if giant-sized).

Vibro-Saber (short sword): 2D4 M.D. (2D6 if giant-sized).

Vibro-Sword (larger, one-handed sword): 2D6 M.D. (3D6 M.D. if giant-sized — truly giant blades may even do 4D6 M.D.).

Vibro-Sword for Bots (giant-size): 3D6 M.D. to 4D6 M.D.

Vibro-Spear: 1D6 M.D. (2D6 M.D. if giant-sized).

Vibro-Axe: 2D6 M.D. (3D6 M.D. or 4D6 M.D. if giant-sized).

Vibro-Polearm: 3D6 M.D. for large blade **polearms** (which is most; 4D6 M.D. if truly giant-sized).

Vibro-Claws: 2D6 M.D. (3D6 if giant-sized); usually three hooked blades attached to a forearm gauntlet or protective plate. Great for parrying and slashing.

Note: The ancient weapon proficiency skill and bonuses apply to the **vibro-blades**. Claws fall into the W.P. Knife category.

High-tech Arrowheads

Bows and arrows are popular among gypsies, wilderness scouts, adventurers, bandits, and many of the monster races. The bow and arrow have the advantages of not needing an artificial energy supply, being lightweight, silent, and extremely accurate in skilled hands. Furthermore, the same weapon can fire S.D.C., M.D. or magic projectiles.

Types of Arrowheads: All are suitable for either crossbows or conventional bows and arrows.

Light Explosive: 1D6x10 S.D.C.; cost 100 credits each.

Medium Explosive: 1D6 M.D.C.; cost 300 credits each.

Heavy Explosive: 2D6 M.D.C.; cost 550 credits each.

High Explosive: 3D6 M.D.C.; cost 900 credits each.

Gas: Arrowhead shatters on impact, releasing a toxic gas that fills a ten (10) foot area (3 m). Tear gas costs 100 credits, tranquilizer gas (**sleep/knockout** for 1D6 minutes) costs 250 credits, paralysis gas (a nerve toxin, causing temporary paralysis for 1D6 minutes) costs 400 credits each. Everybody in the gaseous area must roll to save versus harmful drugs (15 or higher).

Smoke: No damage; creates a smoke screen covering a 20 foot (6 m) area. Cost: 60 credits each; comes in four colors, yellow, red, grey and black.

Flare: Emits a bright, sparking light; burns for 60 seconds. Cost: 10 credits each.

Neural Disrupter: Works like a one-shot neural mace. Cost: 400 credits each; rechargeable and reusable 1D6 times before breaking. Inflicts no other damage.

Tracer Bug: Transmits a radio signal that can be followed up to 8 miles (12 km) away. Battery powered, with a limited life of 72 hours of constant transmission. Arrow must stick into the target or fall on top of the object (without falling off). There is always a chance that the tracer bug arrow will become dislodged and fall off (roll once for every half hour; 1-32% chance). Cost: 200 credits each. Inflicts normal S.D.C. arrow damage.

Magic: The availability and cost of magic or **Techno-Wizard** bows and arrows varies dramatically. The most comparatively common arrows are lightning and fire balls. Cost: 800 to 8,000 credits.

Basic Types of Bows

Weight: Average 2 to 5 lbs (0.9 to 2.3 kg)

Damage: Varies with type of weapon and arrowhead. See the **Rifts® RPG**, page 32, W.P. Archery & Targeting, for S.D.C. damage and effective ranges.

Rate of Fire: 2 to 8; see W.P. Archery & Targeting.

Effective Range: Varies with bow type; maximum is 700 ft (213 m).

Market Cost (simpler types available in wilderness towns too):

Typical short bow: 200 credits.

Typical long bow: 400 to 600 credits.

Typical modern composite bow: 500 to 1200 credits.

Typical traditional crossbow: 400 to 600 credits.

Typical crossbow pistol: 200 credits. 1D4 S.D.C. damage.

Typical modern crossbow: 600 to 1200 credits.

Note: The **modern** bow weapon is a product of high technology and is typically built out of man-made materials, lightweight (2 or 3 pounds), accurate and are very durable.

Miscellaneous Equipment

Note: Unless stated otherwise, all items have good to excellent availability. Of course, most everything is difficult to find in the **wilderness** regions, and often costs 10-30% more.

Computer: Portable Field Unit: Somewhat similar to others used across the Megaverse, the hand computer has a pistol grip for easier handling, and has a built-in scanner and laser **distancer** so it can be used to accurately determine range and measurements by pointing it at or along something. The standard unit comes with a clock and calendar, as well as a mathematics calculating capability, word processing and other basic programs. One can plot vectors, figure out ratios and algebraic functions, send or receive signals to/from any device it is plugged into (it comes with two universal **cyberjack** plugs and two 10-foot (3 m) cords), and sort lists of numbers and names by various parameters. The screen is a concave oval, and easily seen in even harsh daylight conditions. Cost: 2,500 credits.

Ecto-Sensor: A portable device about the size of a backpack field radio that can detect motion, changes in temperature, electromagnetic energy and changes in the electromagnetic field — a so-called "Ghost Detector." The device detects barely **discernable** shifts in molecular structure which match patterns stored in its computer. This is done via neutrino bombardment of the surrounding area, with data feeding back in real time through over sensors. Its imaging system is capable of portraying a rough image on a HUD or built-in monitor/screen. It can detect entities and similar energy beings, and solid but invisible beings (including those made invisible by magic) with a 89% level of accuracy (roll once every minute to maintain contact). It can also pinpoint and track the movement of such beings (89% level of accuracy). Ethereal beings such as supernatural spirits, Astral beings and fragmented life essences usually escape detection; only a 01-12% chance of detection, +12% if they are using magical energy, casting a spell, moving physical objects and similar.

Detection range is extremely limited, only a 300 foot radius (183 m). Cost: 350,000 credits; poor availability.

Jet Pack (common): An all-purpose jet pack that can be used by humans and Light Machine cyborgs. Heavy 'Borgs can use the jet pack too, but speed and altitude are reduced by 40%.

Speed: 220 mph (352 km) maximum speed; cruising speed is typically 60-100 mph (96.5 to 160 km). Maximum altitude is 2,500 feet (762 m).

M.D.C.: 100

Range: 24 hours of use from an E-Pack, or Nuclear with a 10 year life. Needs to cool down after three hours of continuous flight or will overheat (needs to cool down for 30 minutes).

Cost: 55,000 credits for an E-Pack powered unit, 900,000 credits for nuclear powered.

Jet Pack (light & cheap): Speed: 90 mph (145 km) maximum. Duration of Flight: One hour maximum, before it overheats and shuts down; needs a half hour to cool. 22 M.D.C. Maximum altitude: 300 feet (91 m). **Cost:** 19,000 for E-Pack powered units only.

Optics: Magnovo Corp. MO-2050 Long-Range Optic System: Mounted on a short tripod for steadiness (it won't work otherwise unless held by a 'Borg or placed on a **sturdy**, flat surface like the hood of a vehicle, stone fence, etc.). This optical lens system is quite sophisticated and is sometimes used in surveying projects. For those who don't need pocket-style optics, the MO-2050 delivers superior range and unsurpassed accuracy of measurement; 99.8%. It has a built-in laser **distancer** and measuring system with extended range, plus macro and micro magnification (up to **x150**), telescopic magnification (x40), passive nightvision, and infrared optics, all controlled and augmented by computer digital enhancement. The **MO-2050** can be linked up to other computers, vehicle systems, and weapon systems.

Weight: 15 pounds (6.75 kg)

Optics' Range: 3,000 feet (914 m); **line-of-sight**.

Laser **Distancer/Measuring:** To 6,000 feet (1828 m).

Cost: 26,000 credits. Fair to poor availability.

Radio: Communicator: These units come in three sizes. The smallest is the size of a pack of cigarettes, fitted with a handy clip allowing it to hook onto armor, pockets, collars and vests, as well as **fit** in most pants pockets and belt pouches. It has a **transmission/reception** range of five miles (8 kilometers).

The second largest is the size of a 20th Century walkie-talkie with a range of 10 miles (16 kilometers).

The largest is a belt, hip or backpack unit the size of a toaster. It has a range of 20 miles (32 kilometers).

Cost: Small: 1,500 credits, Medium: 3,000 credits, Large 6,000 credits; good availability for all types.

Radio: Communication Helmet: A common protective helmet used by people in all walks of life, from messenger and laborers to adventurers and warriors. Its visor has automatic polarizing optics that adjust to the sun, and it has a radio receiver and transmitter built into it (most environmental armor automatically comes with this means of communication). Miniature headphones pipe the message to both ears and a slide-out microphone allows for two-way communication. Range is typically 5-10 miles (8 to 16 km). M.D.C.: 30, to the head only. Cost: 5,500 credits.

Skis: Downhill/Cross-Country: Modern Russian downhill skis are made of super-ceramics and possess superior turning, "shushing" ability. Cross-country skis are also of superior manufacture and designed for extended treks across rough terrain. Both types can be broken down into two pieces per ski for easier storage. Cost: Downhill: 500-750 credits, **Cross-Country:** 300-500 credits. Excellent availability.

Thermal Suit: This is a waterproof, environmental suit, customized for cold-weather operation. It has additional padding, an insulation weave and is equipped with battery-powered warming coils. Gloves are extra-thick, but molded so they can still manipulate larger items like weapons and machinery. Wearing a thermal suit is less restrictive than body armor, so they are used extensively in winter construction projects and by certain adventurers. One is completely protected from temperatures as low as -100° Centigrade (-148° Fahrenheit). Good mobility, so there is only a -5% penalty to the skills prowl, climb, swim, acrobatics, and gymnastics. Battery Life: One winter of constant use. Cost: 150 credits for the battery, 750-850 credits for the suit.

Thermal Jacket: Fundamentally the same as the waterproof, heated, thermal suit system, but limited to a hooded jacket that comes down to just below the waist and includes heated gloves. Cost: 150 for the battery, 450 credits for the jacket.

Thermal Arctic Boots: Reinforced with ceramic overlapping plates, insulated, and warmed by an internal electric battery, these wonderful inventions are already centuries old in Russia. Developed at the end of the 21st century, the boots are in widespread use. Even the average Russian family will have at least one pair if not one for each family member. M.D.C.: 5.

Battery Life: One winter of constant use; replacement battery costs 40 credits. Cost: 180 credits for a pair of boots.

Winter Survival Kit: Standard issue for the Warlords reavers, knights, and soldiers, and is used extensively throughout Europe and Russia by mercenaries, explorers and adventurers. A winter survival kit is a light metal box (25 S.D.C.) that contains 3 hand-held flares, one smoke grenade, signal mirror, box of 36 waterproof matches, a cigarette lighter, 6 **sterno** canisters, folded **thermo-blanket**, 4 heat packs (the size of a paperback novel; each lasts 4 hours), freeze-dried food and vitamins for seven days, 16 concentrated fat pills, an extra pair of thick mittens, pair of thick socks, a ski mask, scarf, tinted goggles, pocket knife, and a hand axe (1D6 S.D.C.).

Cost: 100 credits. Excellent availability.

Field Equipment

Note: Prices reflect very good to excellent quality.

Hunting, Trapping, Hiking & Camping

Backpack, large, high quality — 100-200 cr.

Backpack, small, high quality — 40-100 cr.

Animal Trap, small — 30-50 cr.

Animal Trap, **large/bear/wolf** — 120 cr.

Bedroll — 30 cr.

Blanket, Heavy — 20 cr.

Blanket, Light — 10 cr.

Canteen: Aluminum — 30 cr.

Canteen: Plastic — 20 cr.

Canteen: 2 M.D.C. — 2200 cr.

Chain, Light, per **foot/0.3 m** — 3 cr.

Chain, Heavy, per **foot/0.3 m** — 6 cr.

Chain, 1 M.D.C., per **yard/meter** — 700 cr.

Cigarette Lighter (**refillable**) — 10-25 cr.

Cigarette Lighter Fluid — 6 cr. per 16ounce can.

Compass — 50 cr.

Disposable Lighter or Box of 200 matches — 1 cr.

Duffle Bag — 25-80 cr.

Fishing Line — Per 50 **feet/15 m** — 5 cr.

Fishing Net — 20 cr.

Fishing Rod and Reel — 50 cr.

Flashlight, large — 12 cr.

Flashlight, **pen/pocket** size — 6 cr.

Grappling Hook and Line (100 **feet/30 m**) — 80 cr.

Hammock — 50 cr.

Insect Repellent — 4 cr.

Knapsack — 50-100 cr.

Knife: Large — 20-100 cr.

Knife: **Small** — 15 cr.

Knife: Survival — 120 cr.

Knife: Throwing — 100 cr.

Knife: Silver Plated — +100 cr. to normal cost of the weapon.
 Machete: with canvas sheath. 2D4 S.D.C. damage — **40-100** cr.
 Mosquito Netting, per square **yard/meter** — 12 cr.
Pillow — 10-25 cr.
 Rappelling Equipment — 1200 cr.
 Rope Ladder, per 10 **ft/3 m** — 40 cr.
 Rope, Per 20 **feet/6 m** — 15 cr.
 Sleeping Bag — 110-160 cr.
 Snare **Cord**, per **yard/meter** — 5 cr.
 Tackle Box — 20-40 cr.
 Tent Canvas, per square **yard/meter** — 20 cr.
 Tent, Four-Man — 300-500 cr.
 Tent, Two-Man — 150-200 cr.
 Tent — One-Man — 100-150 cr.
 Tent, Military Command Post (25 **pounds/11 kg**, 8x8 foot floor, 5 foot **ceiling/2.4x2.4x1.5 m**; **camo-green** or khaki) — 500 cr.
 Utensil Kit (knife, fork, spoon set with sheath) — 25 cr.

Containers

Backpack, large, high quality — 100-200 cr.
 Belt Purse (attaches to belt) — 10 cr.
 Cask, Wooden, 4 **gallons/15 liters** — 30 cr.
 Cask, Wooden, 10 **gallons/38 liters** — 40 cr.
 Cask, Wooden, 25 **gallons/95 liters** — 60 cr.
 Cask, Wooden, 50 **gallons/189 liters** — 100 cr.
 Cask, Wooden, 100 **gallons/378 liters** — 170 cr.
 Cloth Handle Bag — 10-20 cr.
 Crate, Large Wooden — 50 cr.
 Crate, Medium Wooden — 35 cr.
 Crate, Small Wooden — 20 cr.
 Jar, one **gallon/3.8 liters** — 10 cr.
 Jar — 2 **pints/0.9 l** — 2 cr.
 Jar — 4 **pints/1.9 l** — 4 cr.
 Jar, Glass — 1 **pint/475 ml** — 1 cr.
 Jug, plastic, 1/2 **gallon/1.9 liters** — 2 cr.
 Jug, plastic, one **gallon/3.8 liters** — 4 cr.
 Jug, ceramic/pottery, 1/2 **gallon/1.9 liters** — 10 cr.
 Jug, ceramic/pottery, one **gallon/3.8 liters** — 25-50 cr.
 Jug, ceramic, five **gallons/19 liters** — 125-250 cr.
 Metal Security Box, Large, 15 **lbs/6.8 kg**, 90 S.D.C. — 100 cr.
 Metal Security Box, Small, 5 **lbs/2.3 kg**, 30 S.D.C. — 40 cr.
 Metal Trunk, Large, 80 **lbs/36 kg**, 200 S.D.C. — 500 cr.
 Metal Trunk, Small, 35 **lbs/16 kg**, 100 S.D.C. — 250 cr.
 Metal Trunk, Large, 80 **lbs/36 kg**, 40 M.D.C. — 25,000 cr.
 Metal Trunk, Small, 35 **lbs/16 kg**, 20 M.D.C. — 12,000 cr.
 Pocket Purse, Small — 5 cr.
 Sack, Large — 15-30 cr.
 Sack, Medium — 10-20 cr.
 Sack, **Small** — 6-10 cr.
 Saddlebags (horse) — 100-200 cr.
 Shoulder Purse, Large — 35-100 cr.
 Shoulder Purse, Small — 20-50 cr.
 Tobacco Pouch — 10-20 cr.
 Vial, Glass — 2 **ounces/60 ml** — 4 cr.
 Water Skin — 1/2 **gallon/1.9 liters** — 15-30 cr.
 Water Skin — 1 **gallon/3.8 liters** — 30-50 cr.

Miscellaneous Equipment

Bullet Resistant Attache Case: 6 M.D.C., **Cost:** 5,000 cr.
Courier Briefcase: 15 M.D.C., **Cost:** 11,000 credits.

Acoustic Noise Generator: Muffles conversations, distorts bugging systems by 35%. **Cost:** 900 credits.

Camouflage Paint Kit: 4 spray cans plus 6 stencils allow for easy camouflaging of vehicles, bunkers, and any field equipment. One kit will cover approximately 100 square feet of surface. Available in jungle, forest or arctic. **Cost:** 35 credits.

Camouflage Tape: The ever popular duct tape. Comes in rolls 26 feet (7.9 m) long and two inches (5 cm) wide. Available in jungle, forest or desert camouflage, or in olive drab. **Cost:** 6 credits per roll.

Camouflage Compact: A one-man kit for camouflage or night operations. Includes enough face and hand paint for 6 applications. Mirror, brush and disposable cleaning pads are also included in a neat, black case, 4 inches in diameter and 1/2 inch high (10x1.3 cm). **Cost:** 20 credits each.

Climbing Kit: A complete set of equipment for rappelling, rock scaling or climbing. Includes three 600 foot (183 m) reels of 4500 pound (20,000 Newton) test rope (each reel weighs 40 pounds/18 kg). An adjustable harness with clamps, 6 pairs of canvas climbing gloves. 48 clamps, 48 fasteners, 48 pitons, 3 hammers, 2 grappling hooks, and one pulley, straps, harness, boots, and backpack. Weight with shipping crate is 190 pounds (86 kg). **Cost:** 1200 credits.

Ear Protector Headphones: The answer to the Demo expert's and grenadier's dreams. The same model is used by airport workers to preserve hearing in noisy environments. **Cost:** 40-80 credits.

Rechargeable, unbreakable flashlight that's 10 times brighter than most conventional types; **quartz-halogen bulb**, 12 inches (30 cm), 1.8 pounds (0.8 kg), 30,000 candle power. **Cost:** 160 credits.

Treated Torch — 10 credits.

Candle Stick, per box of 12 — 10 credits.

Oil Lantern, 6 hours/1 pint — 20-50 credits.

Oil Lantern, 12 hours/2 pints — 30-60 credits.

Oil Lamp 6 hours/1 pint — 30 credits.

Padlock, Light 25 S.D.C. 4-8 credits.

Padlock, Medium, 40 S.D.C. — 8-15 credits.

Padlock, Heavy, 60 S.D.C. — 15-30 credits.

Padlock, Burglar proof, -40% to be picked, 80 S.D.C. — 30 cr.

Padlock, Burglar proof, -40% to be picked, 5 M.D.C. — 3000 cr.

Handcuffs, 2 M.D.C. — 1,200 credits.

Wire-cutters: 8 inch (20 cm) wire-cutter has nonconducting handles to avoid the nasty "shock" of electrified fences. Complete with belt sheath. **Cost:** \$65.00.

Gas Mask to filter out smoke, fumes, particles, and a variety of military gases. Not recommended as protection against nerve gas or radiation. **Cost:** 50-80 credits.

Sunglasses or Goggles, light adjusting — 25-150 credits.

Sunglasses, fancy, light adjusting — 100-200 credits.

Shooting Glasses: Change color and density in response to changes in light and weather. Also reduces glare and improves visibility — 100-200 credits.

Protective Work Goggles — 10 credits.

Clothing of Note

Military Field Jacket: Includes adjustable collar and cuffs, epaulets, 4 large outer pockets with heavy brass zippers, hidden hood, waist cord and snap closures. Cost: **80-150** credits.

Reversible Flight Jacket: Comes in navy blue, **grey**, green and brown. Cost: 100-200 credits.

Extreme Cold Weather Flight Jacket: Heavily insulated; comes in navy blue, grey, **green**, brown and white. Cost: 250-400 cr.

Battle Dress Utility: Shirt and pants in choice of arctic, desert, jungle or autumn forest camouflage. Shirt has two breast pockets, one pen pocket, and one (left-side) interior pocket. Pants equipped with hip, bun and thigh pockets. Lightweight (desert and jungle): 85 credits. Medium Weight (forest and mountain): 130 credits. Arctic Weight (down lined): 300-500 credits.

Battle Jacket: Comes equipped with breast, hip and interior pockets on both sides. A hidden pocket on the inside of the back is also useful. Available in camouflage, khaki, green or black. Cost: **225-400** credits.

Arctic Parka: High quality down lining provides protection in sub-zero conditions (-50 degrees below zero Fahrenheit). Same pocket arrangement as Battle Jacket. Available in orange, green, grey, and white only. Cost: 450-600 credits.

Wool Sweaters: Finest quality knit with leather reinforcements at shoulders, elbows and neck. Cost: **100-160** cr.

Ponchos: Waterproof nylon. Useful for rain protection, ground cover, emergency tent, etc. 5 feet by 5 feet square (1.5x1.5 m). Available in camouflage. Cost: 50-100 credits.

Clothes: General Purpose

Arctic Trooper Hat with Fur **Earflaps** — 25-40 cr.

Baseball Cap — 12-25 cr.

Bathrobe — 35-80 cr.

Boots, High Quality **Hunter/Woodsman**, & insulated — 140+ cr.

Cape or Cloak, Long — **150-250** cr. +200-400 cr. if fur.

Cape or Cloak, Long & Hooded — 300-400 cr. **+300-400** cr. if fur.

Cape or **Cloak**, Short — 100-200 cr. **+150-200** cr. if fur.

Coveralls, Insulival Vest, 6 pocket — 50 cr.

Lab Coat — **50-100** cr.

Machinist's Apron, 6 pocket — 25-50 cr.

Rain Hat — **8-15** cr.

Rain Poncho — 30-60 cr.

Rain Suit; Hooded Coat & Pants — 100-150 cr.

Raincoat — 30-75 cr.

Reversible Hunting Parka — **120** cr.

Robe, Heavy — **100-200** cr.

Robe, Hooded — **150-300** cr.

Running Shoes — 50-200 cr.

Shop Service ated — **60-100** cr.

Coveralls, Work — 35-60 cr.

Denim Jeans — **50-120** cr.

Dress Shirt — **40-100** cr.

Dress **Shoes/Boots** — **150-300** cr.

Flannel Shirt — 30-50 cr.

Hard Hat — **40** cr.

Hat, Fur (classic Russian hat) — **40-100** cr.

Hat, Fur with ear coverings — **60-120** cr.

Hat, Large Brim — **60-150** cr.

Hat, Leather, large brim — 80-120.00 cr.

Hat, Short Brim — **40-100** cr.

Insulated **SurvCoat**, knee length, 4 pockets — **50-100** cr.

Steel-Toed Boots — 60-200 cr.

Survival Coat, Insulated, 4 big pockets & hood — **160** cr.

T-Shirt — 20 cr.

Thermal Parka, Hooded Sweat Shirt — 85-120 cr.

Waterproof Hunter's Boots — **80-150** cr.

Waterproof Rubber Boots: Knee High — 50-80 cr.

Waterproof Rubber Boots: Hip High — 100-125 cr.

Windbreaker Jacket — 30-80 cr.

Winter Gloves — 30-50 cr.

Winter Jacket, down to knees — 200-300 cr.

Winter Jacket, waist length — **125-200** cr.

Winter Mittens — 30-50 cr.

Winter Ski Mask — **10-25** cr.

Work Apron, **Denim**, 4 pockets — 30-50 cr.

Work Boots — **50-100** cr.

Work Gloves — 6-20 cr.

Work Pants — 35-60 cr.

Work Shoes — **40-200** cr.

Note: Generally double or triple the price for fancy/dress articles and multiply the price by 10 times (or more, in some cases) for custom-made articles.



New Rifts Skills

The following section presents some new skills common to the Russian Frontier along with a variety of skills that have appeared in other Rifts® World Books, but are reprinted here for everybody's convenience. This includes combat skills, horsemanship and other skills from **Rifts® Coalition War Campaign™** and **Rifts® New West™**, among others. Skills new for Russia (although many may have appeared elsewhere) are noted in the list as "new" and are highlighted in italic.

Complete Alphabetical List of Skills, Old and New by Category

Communications

Cryptography
Electronic Countermeasures (new)
Laser
Optic Systems
Radio: Basic
Radio: Scramblers
Surveillance Systems
T.V. & Video

Domestic

Cook
Dance
Fishing
Play Musical Instrument
Sewing
Sing

Electrical

Basic Electronics
Computer Repair
Electrical Engineer
Robot Electronics

Espionage

Detect Ambush
Detect Concealment
Disguise
Escape Artist
Forgery
Imitate Voices/Impersonation (new)
Intelligence
Interrogation Techniques (new)
Pick Locks
Pick Pockets
Sniper
Tracking
Wilderness Survival

Mechanical

Aircraft Mechanics
Automotive Mechanics
Basic Mechanics (new)
Field Armorer (new)
Locksmith
Mechanical Engineer
Robot Mechanics
Weapons Engineer

Medical

Animal Husbandry (new)
Brewing (new)
Criminal Science & Forensics
First Aid
Field Surgery (new)
Holistic Medicine
Paramedic
Medical Doctor
M.D. in Cybernetics
Pathology

Military

Armorer (new)
Camouflage (new)
Demolitions
Demolitions Disposal
Find Contraband, Weapons & Cybernetics (new)
Military Etiquette (new)
Military Fortification (new)
Nuclear, Biological, & Chemical Warfare (new)
Parachuting (new)
Recognize Weapon Quality (new)
Trap Construction (new)
Trap/Mine Detection (new)
Underwater Demolitions (new)

Physical

Hand to Hand: Basic
Hand to Hand: Expert
Hand to Hand: Martial Arts
Hand to Hand: Assassin
Acrobatics
Athletics (general)
Body Building & Weight Lifting
Boxing
Climbing
Gymnastics
Prowl
Running
Swimming
S.C.U.B.A.
Wrestling

Pilot

Airplane
Automobile
Boat: Sail Type
Boat: Motor & Hydrofoils
Boat: Ship
Helicopter (Transport & Combat)
Horsemanship: General
Horsemanship: Knight (new)
Horsemanship: Exotic Animals (new)
Hover Craft (Ground)
Hovercycle (new)
Jet Aircraft
Jet Fighters
Jet Packs
Motorcycle & Small Vehicles (expanded)
Robots & Power Armor
Robot Combat: Basic
Robot Combat: Elite
Pilot Snow Mobile (see Small Vehicles)
Truck
Tanks & APCs
Track Vehicles (new)
Wingrider Flying Wing (new)

Pilot Related

Navigation
Read Sensory Equipment
Weapon Systems

Rogue

Cardsharp (new)
Computer Hacking
Concealment
Find Contraband (new)
Palming
Pick Locks
Pick Pockets
Prowl
Safe Cracking (new)
Seduction (new)
Streetwise
Ventriloquism (new)

Science

Anthropology
Archaeology
Astronomy
Biology
Botany
Chemistry
Chemistry: Analytical
Mathematics: Basic
Mathematics: Advanced

Technical

Art

Breed Dogs (new)

Computer Operation

Computer Programming

Falconry (new)

Gemology (new)

General Repair/Maintenance (new)

Language

Chinese (new)

Mongolian (new)

Russian (new)

Literacy

Lore: Cattle & Animals (new)

Lore: Demons & Monsters

Lore: D-Bees (new)

Lore: Faerie

Lore: History of Russia (new)

Lore: General Law (new)

Lore: Magic (new)

Lore: Psychic & Psionics (new)

Lore: Religion (new)

Masonry (new)

Photography

Prospecting (new)

Rope Works (new)

Whittling/Sculpting (new)

Writing

Weapon Proficiencies

Ancient Weapon Proficiencies

W.P. Archery & Targeting

W.P. Blunt

W.P. Chain

W.P. Grappling Hook (new)

W.P. Knife

W.P. Net (new)

W.P. Paired Weapons

W.P. Shield (new)

W.P. Sword

W.P. Trick Shooting (new)

W.P. Whip (new)

Modern Weapon Proficiencies

W.P. Revolver

W.P. Automatic Pistol

W.P. Bolt-Action Rifle

W.P. Automatic & **Semi-Automatic** Rifles

W.P. Siege Weapons (new)

W.P. **Sub-Machinegun**

W.P. Heavy Weapons

W.P. Energy Pistol

W.P. Energy Rifle

W.P. Heavy Energy Weapons & Rail Guns

Wilderness

Boat Building

Carpentry

Dowsing (new)

Hunting

Identify Plants & Fruits

Land Navigation

Preserve Food

Skin & Prepare Animal Hides

Track Animals

Trap Construction (new)

Trap/Mine Detection (new)

Skill Descriptions

Communications

Electronic Countermeasures (Jamming): Useful for preventing the enemy's communications from working. Since all armor, power armor and robot vehicles are linked by radio transmissions, jamming can cause unit confusion and disrupt communications. Military organization breaks down, causing a loss of effectiveness for all but the best of units.

Just about any high-powered radio can be used for jamming. Armed with a radio, a small guerrilla unit can completely disrupt the maneuvers of large enemy groups. This skill also enables the radio operator to "follow" the enemy's attempted transmissions over jammed frequencies to trace their general location, a specific building, or direction. This tactic is extremely useful in finding and eliminating lone power-armor troopers.

Base Skill: 30% +5% per level of experience. **Note:** If the G.M. likes, he can make this part of the *Radio: Scramblers* skill, but still with a base of 30%.

Espionage

Imitate Voices & Impersonation: The ability to *imitate the voice*, accent and expressions of another person or regional dialect. This skill is common among thieves and assassins, as well as demons and other villains. The first number indicates the character's ability to change his voice and imitate accents, inflections and expressions from other regions. A successful roll means he has disguised his **normal/true** speaking voice and accent, and convincingly sounds like he is from another region or part of the world.

The second number indicates the **character's** ability to accurately imitate the voice, inflections and attitude *of a specific person!* This is much more difficult, and the character will either need to know the person being imitated very well, or have spent hours studying **him/her**. **Base Skill:** 36%/16% +4% per level of experience.

Impersonation Note: When combined with the disguise and intelligence skills, the character is able to completely impersonate a specific person or person of a particular occupation (soldier, knight, **wizard**, priest, etc.). This is likely to include knowledge of the subject being impersonated, military procedure, dress, heraldry/rank, and will usually require speaking the language fluently. This means the character can convincingly impersonate a general type of **person/soldier/advisor** with an accurate disguise, proper action, and language. A failed roll means some element of the impersonation is flawed, most likely some incorrect behavior or character trait, or lack of information about the person being impersonated ("Tell me again what you said that night," etc.). Such "holes" will give the character away sooner or later. Thus, the longer a character remains under the eyes of others, the more likely that something will happen to reveal the character is an impostor. This is fun to role-play, so take advantage of it.

Base Skill: 16% +4% per level of experience for a regional disguise of an average local person (farmer, laborer, vagabond, **etc.**), +12% +4% to impersonate a person in a specific occupation (sheriff, **guard**, inspector, messenger, merchant, priest, etc.), and 10% +4% per level of experience to impersonate a specific, known person.

Interrogation Techniques: This skill is common among policemen, intelligence officers, and **assassins/spies/bounty** hunters. The character knows the techniques to get information from (typically unwilling) subjects. This includes such old methods as "good cop, bad cop" (one interrogator is threatening and intimidating, the other is sympathetic and friendly), deceiving and misleading the subject into giving away information, and similar. The character can also judge if the subject is lying (the Game Master might assess bonuses and penalties depending on how good a liar the subject is, **and/or** on the victim's M.E., M.A. **and/or** P.B; the higher any or each of these attributes, the more convincing the lies). This skill also includes some basic knowledge on methods of torture, from basic tactics like depriving the subject of sleep, to the use of "medieval" instruments, drugs and psionics. Note: Only evil characters will engage in actual torture. **Base Skill:** 20% +5% per level of experience.

Mechanical

Basic Mechanics: A general familiarity and understanding of basic mechanics. This character can fix a toaster, repair a bicycle, replace a belt on a motor, repair or replace a switch, handle or knob, replace a spark plug, change oil, assist in automobile repairs, maintain machinery, read a schematic and similar fundamental tasks. **Base Skill:** 30% +5% per level of experience.

Field Armorer: See armorer under Military skills.

Medical

Animal Husbandry: This area of study provides the character with a knowledge of the care, feeding, breeding, reproduction, treatment and behavior of domestic animals. This includes cattle, sheep, goats, horses, ducks, chickens, and similar creatures (see horsemanship for breeding horses). The percentile number indicates the degree of knowledge and skill one has about animals and their care. Reduce the skill ability by half when caring for captive or injured wild animals.

Base Skill: 35% +5% per level of experience.

Brewing: Is the making of juices, teas, tonics, **elixers** and fermented alcoholic beverages from grains or fruits. This specifically includes wine, **mead**, ale, beer and moonshine. Strong alcohol such as brandy, rum, and whiskey, are not included, nor are champagnes or fine wines. The first percentile number indicates the chance of success (a failed roll means a ruined batch of booze). The second indicates the quality of the brew — the higher the number rolled the tastier the drink). **Base Skill:** 25%/30%+5% per level of experience.

Field Surgery (By Pat Nowak): This skill **reflects** training in emergency, life-saving surgical procedures that can be performed in the field to keep critically wounded characters alive. Given the proper tools, the surgeon character can perform amputations, suture torn arteries, check internal bleeding, cauterize wounds, give blood transfusions and even install cybernetic implants (penalty of -15% except if the character has *basic cybernetics* skill). Field expedient surgery is a dangerous proposition that all too **often** results in the death of the patient. Because of the risk involved, field surgery is attempted only when it is the only chance the wounded character has for survival! If the operation is successful the patient lives and can be evacuated to a hospital, but a failed roll results in the immediate death of the patient. **Base Skill:** 16%+ 4% per level of experience.

Optional Guidelines for Fatal Injury Treatment: In the violent world of **Rifts**, regular humans and similar non-Mega-Damage beings are at an extreme disadvantage. Once a human's body armor is destroyed, a single M.D. blast will usually obliterate **him/her**. These guidelines are provided to give player characters a chance, however slight, to survive a blast that would normally evaporate the character. If the G.M. agrees, the character can survive a mega-damage intensity wound if a trained medic makes a **successful field surgery** skill roll.

Unless the attacker made a called shot or rolled an unmodified 19 or higher, the character has the chance to live. The basic idea is that the M.D. blast was partially absorbed by nearby cover or merely sheared off a limb (G.M.s, give some reasonable explanation). Within 1D4 melee rounds after the character's being hit, a medic character must attend to **his/her** injuries. If the medic makes a successful skill roll the character is incapacitated but survives the attack, though just barely (reduce S.D.C. to zero and hit points are at 1D6 above zero). A failed roll means the injured character was beyond saving and dies an instant later. Even if the field operation succeeds, the wounded character is in **shock**, crippled, may require additional extensive surgery and is likely to require cybernetic or bionic reconstruction and a long recovery period before he is able to adventure again. Although crippled, the character lives (it may be appropriate to also determine an insanity and permanent physical side-effects from the injury). **Note:** This optional survival rule is also applicable to Medical Doctors and Cyber-Docs.

Military Skills

Armorer/Field Armorer: This is a somewhat simplistic version of the weapons engineer as it applies to infantry weapons. A competent armorer character can maintain, fix, modify, mount, **reload/charge** ammunition, and figure out most small arms. The Armorer can repair all types of pistols and rifles, repair minor damage to body armor (20 M.D. maximum), adjust targeting sights, use and repair optical enhancements, reload missiles and ammo drums, recharge **E-clips**, **install/mount** a rail gun or machinegun on a vehicle, and even fix most simple robot and bionic weapons like forearm blasters and retractable blades, as well as make arrows and arrowheads, sharpen blades/weapons, make horseshoes and basic metal items (including nails, spikes, and chain links). He can also deactivate, reset and fix simple traps (roll for each attempt). **Base Skill:** 40% +5% per level of experience. **Note:** Automatically gets the basic mechanics skill at +20% as part of this package.

Camouflage: The skill of concealing a fixed base position, vehicle, bot, equipment or individual, using natural or artificial materials. A fair amount of time is involved in the preparation of a larger position. Large cargo nets, cut branches or underbrush are used most often in camouflage. This skill is also used to conceal traps. **Base Skill:** 20% +5% per level of experience.

Military & Rogue Skill Categories: Find Contraband, Weapons & Cybernetics: The character with this skill knows where to find arms dealers, smugglers, body chop-shops, **cyber-snatchers**, M.O.M. and Juicer conversions, criminal cyber-docs and illegal medical treatment, as well as how to spot them. He is also familiar with their practices, **hang-outs**, gang or criminal ties, codes of conduct, pricing structures and modes of operation. Likewise, the character has a good idea of what black market weapons and cybernetics should cost and what these

people pay for contraband items (typically only 20% of the retail market price). The character also knows the penalty for being caught with an illegal weapon, implant or bionics. In most societies, any M.D. weapons, concealed weapons and **sidearms** are forbidden inside large population centers.

This skill is especially appropriate in the modern cities of the Coalition States, as well as in the large cities of the NGR, Atlantis, Japan, and other large, urban communities. **Base Skill:** 26% +4% per level of experience. **Note:** This skill *should* be considered separate and apart from streetwise.

Military Etiquette: This skill grants a clear understanding of the way the military works, including rules of behavior (when to salute, how to address superiors/subalterns, etc.), military procedures and routines, standard issue of equipment, special ordering procedures, proper display of rank and medals, advancement in rank (and the duties that come with it), proper troop formations, how to deal with military bureaucracy, the chain of command, proper channels, who to contact to get things done, and other useful information in matters of military protocol and bureaucracy. **Base Skill:** 35% +5% per level of experience. **Note:** All soldiers have a fundamental knowledge of military etiquette (base skill 30% with no improvement), but this skill is much more complete with a strong knowledge of what is expected, correct and the formal approach (e.g. by the book knowledge).

Military Fortification: This is the skill of designing and building defensive fortifications suitable for modern Mega-Damage combat. If provided with the time and materials the character can greatly increase the defensive value of natural terrain with murderous defenses that include obstacles to impede movement and protective structures to shield **friendly** forces from enemy fire. The character is trained to prepare mine fields, barbed wire, tank obstacles, tanglefoot wire, booby traps, trenches, tank ditches, foxholes/shell scrapes, reinforced concrete or earthen walls, bunker complexes, rail **gun/mortar** emplacements, tunnel systems and similar defensive constructions. **Base Skill:** 30% +5% per level of experience.

Even with the advent of Mega-Damage warfare the old standby fortifications listed above have useful applications. Obstacles like ditches and mine fields slow the advance of **bots**, infantry and tanks, exposing them for longer periods to defender **firepower**. Earthen walls and foxholes, made from S.D.C. materials, still afford soldiers some protection and can disperse energy blasts or deflect shrapnel from explosives. If these protective structures are built with Mega-Damage concrete and alloys they provide defenders with as much protection as any robot vehicle or tank!

Nuclear, Biological, & Chemical Warfare (NBC): This is the knowledge of safety precautions to protect oneself and others from the **effects** of nuclear, biological or chemical warfare, waste and contamination. The character is also knowledgeable in the safe handling and "clean-up" and containment of such hazardous materials. **Base Skill:** 35% +5% per level of experience.

Recognize Weapon Quality: The ability to accurately determine a weapon's durability, reliability, and quality by physically examining it. This includes knowing which manufacturers are reputed to make the best weapons, the ability to recognize damage or signs of misuse, modifications/customization or wear and

tear, whether the weapon can be made as good as new with a little repair work **and/or** cleaning, whether it is a cheap (or quality) "**knock-off**" (copy/imitation), and so on. The character can also recognize if the weapon is stolen (serial numbers filed away, etc.), new, old, and if it has any other special features or properties as well as know what the fair price should be. **Base Skill:** 25% +5% per level of experience. **Note:** Reduce the skill ability by half if the item is not actually handled (seen but not **touched/examined**).

Military and Wilderness Skill Categories: Trap Construction (by Nowak & Siembieda): Training in the design and application of traps and mines used in anti-personnel and defense tactics. With readily available materials and simple tools, including shovels, knives, sticks, wire and rope, the character can build fiendish traps. Any who would scoff at the effectiveness of traps in modern Mega-Damage combat should reconsider. It is true that traps cannot easily be made to destroy or even damage M.D. equipment, unless explosives and the demolitions skill are used, but these traps can hamper or disable enemy robots and vehicles, and injure or kill **unarmored** or lightly armored soldiers! Traps can also be used as alarms to alert the trap maker to the presence of intruders or the enemy (fires a flare, activates a video camera and transmission, makes noise, etc.).

The greatest drawback of traps lies in the amount of time required to prepare them — it can take hours to prepare rock slides, large pits and similar traps — but, even this time can be shortened with help from others since only one character needs the skill to successfully direct workers. Ingeniously prepared traps can, and often do, shift the advantage of a battle to the side that prepared the field for combat. **Base Skill:** 20% +4% per level of experience.

The following are some examples of traps, complete with their effects, a character can include using the *Trap Construction* skill. All damage, penalties and considerations are based on a human-sized victim unless stated otherwise.

Pit, Man-Sized: Typically a simple **pit/hole** 7-14 feet (2.1 to 4.2 m) deep and concealed with twigs and leaves. Pits can slow an enemy advance by delaying troop movement (must pause to climb out of the pit or to help comrade out of the pit), injure the victim (typically twist, pull or bruise and sometimes break a leg or arm), damage light (S.D.C.) equipment, trap unfortunate soldiers and disable robots (at least temporarily).

A person blundering into a pit trap falls, taking 1D6 S.D.C./hit points damage per every seven feet (2.1 m) of depth, even if wearing M.D. body armor (the impact has an affect on the person inside; no damage to power armor or robot **pilots**)! The same damage is applied to fragile S.D.C. items that tumble into the pit. The character also loses one melee **attack/action** in that act of falling and 1D4 melee actions gathering his wits and getting back on his feet; stun effect.

To climb out of the hole unassisted requires 1D6 melee actions. An especially deep pit will require a *climbing* skill roll or somebody to give the character a hand. Robot vehicles that step into the hole have a 01-70% likelihood of tripping and falling. Crew members suffer 1D4 S.D.C. damage and must spend 1D4 melee rounds to right the vehicle. While trapped **and/or** while the victim(s) are attempting to recover, the trap maker and his allies usually launch a vicious attack or surround the victim. The pit trap is very common in the wilds of Russia.

Monster Pit: In some instances the trap designer will place a small (or large), vicious creature inside the pit. The creature will be terrified **and/or** angry and attack anything that falls into the pit. These creatures typically fight until slain. Lasae, worms of Taut and M.D. monsters of similar size are often used in this capacity, as well as wild canines, felines, bears and snakes.

Snake Pit: A shallow pit, 4 or 5 feet deep (1.2 to 1.5 m), filled with poisonous snakes or small worms of Taut. Characters who fall or stumble into the pit receive 1D4 bites. Regular snake bites inflict 1D4 S.D.C. damage plus 3D6 S.D.C. from poison if the creatures bite unprotected flesh. Creatures like worms of Taut and other alien "crawly things" may inflict Mega-Damage. The trap is rarely used in North American and Europe, but is frequently used in the jungles of South America and Asia.

Tank Trap/Giant Pit: Basically the same as a man-sized pit but dug to a depth of 18 to 30 feet (5.4 to 9 m). Infantry ground troops who blunder into the hole suffer 1D6 S.D.C. for every seven feet (2.1 m) of depth from falling and need 2D4+2 melee attacks/actions to climb out, unless helped out by people outside the pit with rope and such.

Robot vehicles and tanks can also fall victim to these deep and often wide pits. The crew suffers 2D4 S.D.C. damage from getting jostled around. Humanoid robots and power armor suits can climb or pull themselves out of the pit with relative ease; must spend one or two full melee rounds (15-30 seconds) unless the vehicle or power armor can fly or leap out (counts as one melee action).

Tanks, trucks and other ground vehicles may have part or all of the vehicle stuck or wedged in the pit and require a crane or giant robot(s) or several power armor troops to pull it out. Just how stuck and immobilized the vehicle is will depend on the size and depth of the pit.

Mined Pit: A pit with land mines or other explosive device(s) dug into or placed on the floor of the pit. It detonates when one or more victims hits the bottom.

Punji Stake Pit: Typically a pit 8-10 feet (2.4 to 3 m) deep, concealed with twigs and leaves. The bottom of the pit is lined with a bed of sharp wooden stakes. Roll 1D6 to see how many stakes the falling character lands on; each inflicts 1D6 S.D.C., damage plus damage and penalties from the fall (see the *man-sized pit* description). **Vibro-blades** and special M.D.C. materials can be used to inflict Mega-Damage; roll 1D6 to see how many stakes the falling character lands on; each inflicts 1D6 M.D. plus possible damage and penalties from the fall.

Punji pits are extraordinarily effective against vampires and are found throughout Mexico! They are often used (camouflaged and open) as **countermeasures** along defensive perimeters and dug-in fortifications.

Punji Sticks: Sharp wooden stakes stuck into the base of trees, in tree branches, or on the ground at strategic locations near settlements, defensive perimeters, off to the sides of paths and so on. People who stray off the path or go where they don't belong may step on, stumble, trip, fall or lean into 1D4 stakes/spikes. Each stake inflicts 1D6 points of S.D.C. damage. Wood and S.D.C. material punji stakes do no damage to characters in M.D. body armor and are rarely used for that reason.

As noted previously, **vibro-blades** and other Mega-Damage materials may be used, but are not as effective; vibro-blades

tend to hum, tipping off their **locations**, and M.D.C. materials scrape but seldom puncture M.D.C. armor unless the victim falls onto or drives across them with some force. Punji sticks are a form of guerilla warfare designed for use against humanoid enemies. Travelling slowly and carefully, they are easy to detect and avoid, but being reckless or **running**, the character is likely to run into them headlong.

Punji-Stick Drop-Fall Trap: A large weight bristling with sharp, wood stakes is suspended in a tree. It is released by a trip wire and either drops down or swings across the target area. Characters can try to dodge but are -3 to do so. This trap inflicts 6D6 S.D.C. damage to **unarmored** victims. Those wearing M.D. body armor suffer 2D4 S.D.C. damage from the impact and are knocked off their feet; lose initiative and one melee action!

Swinging Log: A huge log or piece of debris (cannon barrels and the legs from giant robots are also used) is suspended in a tree which, when released by a trip wire or pressure plate, swings across the target area. All characters in the path of its swing are struck and suffer damage unless they successfully dodge at a -3 penalty. Characters wearing M.D. body armor suffer 6D6 S.D.C. damage from impact, unarmored victims suffer 2D6x10 S.D.C. (or one M.D. **point**)! Individuals struck by the log are **knocked out** cold by the tremendous impact for 3D4 melee rounds. The trap is a favorite for attacking groups of soldiers walking in single file, as well as against power armor.

Robot vehicles struck by the huge weight have a 01-50% likelihood of being knocked off their feet; vehicles knocked off their path. The vehicle crew suffers 1D4 S.D.C. damage from being thrown around the cockpit.

Barbed Wire Barrier: Cords or rolls of barbed wire are laid across a pathway, entrance or particular area (concealed or not) to bar its path. While the wire will not hurt Mega-Damage body armor, it still hooks and entangles the feet and snags any fabric, thus impairing movement (the wire must be cut or pulled away) and makes noise. Power armor units and bots can often tear right through it or stomp it down with no **penalties**, however, their passage will still make some noise.

Rock Slide/Log Fall: Rocks or massive logs or debris piled at the top of an incline are released to tumble into the target area. Every foot soldier, bot or vehicle in the area suffers 1D4 M.D. from the impact of rocks or M.D.C. debris or 1D6x10 S.D.C. from logs. Unless the victims make successful dodges at -8 and are able to dive for cover, they are struck and carried away by the tumbling **rocks**, logs or debris. Most will become pinned in or trapped beneath the fallen materials until rescued by companions. Even those individuals who dodged successfully are trapped at the edge of the pile and need 3D4 melee rounds to work themselves free. Robots and vehicles, who are often targeted by this trap, have no chance to dodge and have a **01-90%** likelihood of getting knocked down or pushed 1D6x10 feet off the path. Furthermore, they are struck by more of the falling debris, suffer triple damage and are likely (01-75%) to need a crane, giant robot or several power armor troops to pull them free. The crew of the vehicle suffers 2D6 S.D.C. damage. During this time, the designers of the trap typically swarm the helpless vehicles, bots or soldiers, attacking or taking prisoners. In addition, the debris covered **road/area** is more difficult to travel over. This trap is very popular in hilly and mountainous regions.

Crossbow Trap: A crossbow attached to a tree or in a pit that shoots when a trip wire is pressed or broken. The bolt strikes the target on a 1D20 roll of 14 or higher. Damage from an ordinary crossbow is 2D6 S.D.C., but any of the high-tech types can be used. Often the crossbow will be loaded with an explosive high-tech bolt that inflicts 3D6 M.D. rather than a conventional projectile. Fairly common.

A variation can use an S.D.C. or energy pistol (because of the short range of the trap and typically only fires a single shot) by having the wire depress the trigger on the gun. However, this is a rarity because of the waste and cost of using a more sophisticated and high-tech weapon.

Trip Snare: Causes the character to trip. No damage, but the fall is embarrassing, the character loses initiative, two melee actions, and makes a loud noise that will alert nearby enemies and predators to the character's location. Usually the snare is set as part of an ambush, leaving the fallen character vulnerable to the opening volley of an attack. This type of trap is extremely common.

Variations include trip flares, in which in addition to the above, a rocket flare is shot into the sky and explodes. The flare indicates the exact location of the intrusion and, at night, illuminates the immediate area of the snare.

Animal Snare: A simple snare designed to catch or lasso the animal's foot or head. This is typically used to capture small animals.

Rope Snare: This is a concealed, lasso-style snare tied to a tree. When the snare is triggered, the lasso snares the foot or feet and whips the character or animal up and suspends it, dangling from a tree, usually 5-10 feet (1.5 to 3 m) above the ground. There is no damage but the character loses two melee actions and needs another melee action or two to cut himself down. It is most effective in forested areas.

Net Trap: Rather than using a lasso-style snare, a net can be used in the above rope snare trap. The net is spread on the ground and camouflaged, but wraps around the target when triggered. The character or animal is whipped up and suspended from the tree 10 feet (3 m) above the ground. There is no damage caused by the trap but the character loses two melee actions and needs a further three melee actions to cut himself loose.

Bear Trap: A pair of large, clamping metal jaws that snap shut when the prey steps on the pressure plate. The metal jaws are typically chained to a tree or stake and require a combined P.S. of 24 to pry them open; a hand activated release switch will also open and reset the trap. Damage is 4D6 S.D.C., but holds its prey in place until the jaws are opened or the prey literally tears itself free; animals often bleed to death. This trap is effective against animals and **unarmored humanoid** prey. It is sometimes combined with a snare to trigger flares or drop a grenade.

Naruni Bullet Mine: A crippling trap design which employs a Naruni plasma cartridge or small explosive. The cartridge is placed in a small hole in the ground atop a nail or firing pin, then covered by a camouflaged wooden slat. When someone steps on the slat the cartridge is pressed down on the firing pin, triggering a plasma blast that inflicts 1D4x10 M.D. to the victim's foot. This is uncommon, due to the generally poor availability of Naruni ammunition. Hand grenades and other explosives are sometimes substituted.

Grenade Trap: A regular grenade, with its pin removed, is attached to a trip wire and placed in a can hanging from a tree. When the trip wire is pulled, the grenade falls from the can and explodes on or near the unfortunate victim. The explosion causes regular damage by grenade type; fragmentation (2D6 M.D.) and plasma grenades (5D6 M.D.) are typically used. This is a fairly common trap.

Variations include the use of riot control **flash/stun** grenades, tear gas and smoke grenades.

Mini-Missile Trap: Typically a snare that triggers the launch mechanism of a **mini-missile!** Fairly uncommon; another guerrilla tactic.

Fusion blocks, plastique charges and land mines are all frequently used in booby traps throughout the world. However, the character must have the *demolitions skill* to use them.

Military and Wilderness Skill Categories: Trap/Mine Detection: Knowledge of the strategic placement of booby traps and mines, the tell-tale trademarks and indications of traps and mines, how to avoid them, and the use of mine and explosive detection equipment. The character has been trained to watch for suspicious objects, dirt mounds, trip wires and camouflaging materials that may denote the presence of a trap. Simple snare traps and trip wires can be easily disarmed by the character, but the *demolitions disposal* skill is required to disarm mines, explosives or complex traps. **Base Skill:** 20% +5% per level of experience on visuals alone. Add +50% when using special detection equipment to locate mines/explosives or +10% to locate other types of traps with detection equipment.

Note: **Psi-hounds/Dog Boys** who are of the Bloodhound and German Shepherd/Alsatian breeds have a base skill of 35% +5% per level of experience to literally "sniff-out" explosives, magic traps, and "sense" other types of traps without benefit of special equipment! However, these "Sniffers" must undergo special training, and this special focus reduces their other sensing abilities by -10%. The ordinary Bloodhound or Shepherd Dog Boy does not get any special bonus or ability and must use mechanical equipment and his ordinary senses to locate mines and traps.

Underwater Demolitions: Fundamentally the same basic skills and training as demolitions, but with an emphasis on using explosives in an underwater environment, including underwater techniques, area affect, sound wave damage, different types of explosives, as well as arming, disarming and repairing torpedoes and depth charges. **Base skill:** 56% +4% per level of experience. **Note:** Any character with the demolitions skill can use explosives underwater, but is -10%.

New Piloting Skills

Pilot Hovercycle: Characters who select the *pilot hover craft* skill can drive hovercycles, **hovercars**, etc., however, those who specifically select the *pilot hovercycle* skill can pilot any type of hovercycle, rocket sleds, or jet propelled, one or two-man hover vehicles with skill and finesse. They can also perform jumps, stop on a dime, perform dive-drops (i.e. soar off the edge of a cliff, keep control of the hovercycle and keep on going without crashing when they reach the bottom), and tricks without penalty (-20% to piloting rolls if the only skill is the general *pilot hover craft*). **Base Skill:** 70% +3% per level of experience.

Pilot Motorcycle and Small Vehicles (New): This includes snow mobiles, jet sleds, **Landfliers**, Bushbikes and similar one

and two-man **vehicles**, as well as motorcycles, dirt bikes, and all two and three-wheeled vehicles. **Base Skill:** 60% +4% per level of experience.

Pilot Track Vehicles (New): Includes **landcrawlers**, half-tracks, light tanks, tractors and heavy construction vehicles (bulldozers, steamshovels, etc.). **Base Skill:** 40% +4% per level of experience.

Pilot: Wingrider Flying Wing (New): The very specialized and difficult skill of piloting the Wingrider Flying Wing, gliders and similar "Wing" shaped vehicles. **Base Skill:** 15% +5% per level of experience.

Horsemanship

The horsemanship skill is a sub-set of the piloting skills. There are several levels and styles of horsemanship skills. In Russia they include: General, Knight, and Exotic Animals. Each indicates a certain degree of training and expertise. The individual O.C.C. will indicate which of these applies to that occupation (general knowledge is most common). Each type of horsemanship has the following skills and areas of knowledge. The higher the skill percentage the better the skill or ability. **Note:** To avoid being thrown from the horse when jumping, charging, kicking or performing some other difficult maneuver or trick, the character must roll under his second percentage to remain in the saddle and in control of his animal. Also note that the American Cowboy is arguably, the most skilled and versatile horseman in the world with skills such as roping and herding cattle as part of his repertoire of horsemanship related skills; all elements that are not usually available to Russian Horsemen (the only exception being the Cossack).

Ride & care of horses: The first percentile number indicates the character's riding ability and a fundamental knowledge of feeding, caring, and grooming of horses.

Recognize **quality/breed:** The first percentile number also indicates the success ratio of recognizing the breed quality, age, strength, speed, health, and general attributes/capabilities (race horse, workhorse, **warhorse**, etc.) of the animal.

Breed horses: The second percentile number indicates the knowledge in the raising, breaking, training and breeding of horses. It includes shoeing horses, giving birth, and curing minor ailments and injuries.

Jumping: The second percentile number also indicates the success ratio of NOT being thrown from the horse when jumping, charging, kicking or performing some other difficult maneuver or trick. The character must roll under his percentage to remain in the saddle and in control of his animal. Damage from being thrown off a horse is typically 1D6.

Racing: The second percentile number also indicates the success ratio of maintaining control and getting maximum speed while racing at full gallop. A failed roll means the horse runs quickly but 10% short of its maximum speed attribute. A successful roll not only means running at maximum speed, but the rider can coax that little extra spirit and speed out of the animal. Once every four minutes, the rider can get the horse to kick into overdrive and run at 25% faster than its normal maximum. However, this speed can only be maintained for one minute at a time and cannot be done more than three times in a 15 minute period. Maximum running speed can be maintained for a period of minutes equal to the horse's P.E. attribute. Pushing the horse

beyond its endurance will cause it to slow down by 30% and after 4D4 minutes, collapse from exhaustion (requires at least a half hour rest and light activity for another hour).

Horsemanship: General: All the basic skills as noted above. **Base Skill:** 35%/20% +5% per level of experience.

Combat: All bonuses are in addition to other combat skills, weapon proficiencies, or attribute bonuses. They apply to the rider, not the horse. The rider gains a combat advantage from the height and speed of being mounted.

- +1 to parry or dodge while on horseback.
- Inflicts +1D4 to damage when on horseback.
- Charge attack (running horse) with a lance, pole-arm or spear: +1D6 damage. The attacker must roll under the second percentile number to avoid being dismounted. Charge attacks count as two melee actions/attacks.
- Horse attack: This indicates that the rider is skilled enough to remain saddled while he attacks and has his horse rearing or kicking in simultaneous attack (roll under second percentile number). Damage from the kick of a horse will vary with the size and breed of the animal; generally 2D6 from the front legs and 4D6 from the rear legs.

Horsemanship: Knight: All the basic skills as previously noted. **Base Skill:** 40%/30% +5% per level of experience.

Combat: All bonuses are in addition to other combat skills, weapon proficiencies, or attribute bonuses. They apply to the rider, not the horse. The rider gains a combat advantage from the height and speed of being mounted.

- +1 on initiative when on horseback.
- +1 to roll with fall or impact when knocked from a horse.
- +2 to parry or dodge while on horseback.
- Inflicts +1D6 to damage when on horseback.
- Charge attack (running horse) with a lance, pole-arm or spear: +2D6 damage. The attacker must roll under the second percentile number to avoid being dismounted. Charge attacks count as two melee actions/attacks.
- Horse attack: This indicates that the rider is skilled enough to remain saddled while he attacks and has his horse rearing or kicking in simultaneous attack (roll under second percentile number). Damage from the kick of a horse will vary with the size and breed of the animal; generally 2D6 from the front legs and 4D6 from the rear legs.

Horsemanship: Cossack: Exclusive to the Cossack O.C.C. and described in that section.

Horsemanship: Exotic Animals: Basically the same as the *general horsemanship* skill, except that the character is experienced in riding other types of "tame" animals. This can include elephants, camels, lamas, pegasus, gryphons, giant insects, Mega-Steeds, and other monstrous beasts trained (or willing) to be riding animals. Wild, untamed creatures cannot be ridden (except by **druids** and others with special animal skills). **Base Skill:** 30%/20% +5% per level of experience.

Note: Characters with the traditional "horsemanship" skill for riding horses and other very horse-like animals can quickly figure out how to ride exotic and alien riding animals, but at a skill penalty of -12% to ride **ground/running** animals and -16% to ride flying or tree climbing and leaping animals. Similarly,

beings from other dimensions not familiar with riding the fast and sleek Earth horses are -10% to ride them.

Rogue Skills

Cardsharp: A skill that involves the manual dexterity of hand and finger manipulation to perform tricks, palming, and other gimmicks of sleight of hand with playing cards. This includes dealing from the bottom or middle of the deck, stacking a deck (to the **cardsharp's** favor), hiding cards up the sleeve (and elsewhere), fancy and impressive methods of shuffling and dealing the cards, as well as "marking" cards, card counting and understanding the odds.

Marking cards often includes a complex series of Braille-like indentations, punctures or trimmed edges so that they were slightly concave or convex, all things that the delicate touch of the professional **cardsharp** can feel as he deals the cards. Other types of "marks" include incredibly subtle, almost indiscernible variations of the pattern on the back of cards, typically in the right, upper corner.

A failed roll means the character has **fumbled** the trick, missed (or misread) one of his secret markings, or was too obvious and is caught cheating! **Base Skill:** 24% +4% per level of experience. Add +4% if the character also has *the palmingskill*.

Safecracking: This is a specialized skill in which the character studies the strengths, weaknesses, and construction of safes and how to open them without damaging the contents inside. The fingers of the safecracker are so sensitive that they can "feel" the subtle calibration of combination locks and other locking mechanisms. When using explosives, they can use their abilities to such precision that they can "blow" the lock off a safe, security door, safe deposit box and similar without creating a big, area affect explosion or inflicting damage to the contents (a failed safecracking skill or demolitions roll means the explosion was too much and the contents are damaged). **Base Skill:** 20+4% per level of experience. **Bonuses:** Adds +5% bonus to the lock picking and demolitions skill. **Penalties:** Requires focus, concentration and keen hearing; characters with an **M.E.** under 15 are -10% on this skill.

Seduction: This is the ability to make the opposite sex melt with desire. This skill is somewhat similar to the interrogation skill, in that the seducer knows how to ask the right questions to get information without being obvious. The seducer usually seems attentive, sympathetic, and **alluring/sexy**. Men and women who are seduced tend to have loose lips — meaning they tend to talk freely, say more than they should, and tell secrets. They also lose track of time, spend big money to impress and please their seducer, and lavish her or him with their affection, time and attention, while oblivious to everything else around them.

Most of all, somebody who is seduced is vulnerable. The person who is *successfully seduced* is distracted, skill performance is half and takes twice as long to perform, the character has *no* initiative, doesn't notice people or events around **him/her**, and is easily caught off-guard; no initiative and all bonuses are at half when attacked by a character other than the seducer. Worse, the victim(s) of the seduction is completely vulnerable to the seducer! The seducer always gets the first **strike/attack/action** (any roll above a 4 hits or is successful). The victim has no chance of self-defense against that first attack, plus loses one **attack/action**

from surprise or horror. In addition, the seducer is +5% to pick the pockets of, palm, or plant things on **his/her** victim of seduction, as well as +5% to the skills **cardsharp**, sing and dance. Research has shown that the more alcohol the intended victim drinks, the easier it is to seduce someone (+5%). **Base Skill:** 20% +3% per additional level of experience. **Skill Bonuses:** +1% for every *one* M.A. attribute point above 20, and every *two* P.B. above 17. So a character with a P.B. 23 (+3) and M.A. 24 (+4) would be +7% to successfully seduce. The seducer can influence more than one person at a time; one additional per every three levels of experience.

Ventriloquism: The practiced ability to throw one's voice. This can be used to create the illusion of not speaking while making a voice or verbal noise appear to be coming from someone or something else, such as a puppet, a tree, box, chair, etc. Maximum range is 10 feet (3 m) away. A failed roll means the voice is not well thrown or the ventriloquist's mouth is seen moving, so the trick does not work. **Base Skill:** 16% +4% per level of experience.

Technical

Reprinted for your convenience from **Rifts®** New West™ and other places.

Breed Dogs: The first percentile number indicates the art of raising, **mating/breeding**, taming and training domestic and wild canines, as well as a knowledge about canines in general.

The second percentile number is used to attempt to tame a wild canine, teach a dog tricks, or to train the animal for a specific task like tracking, retrieving, pointing, herding animals, attacking on command, and so on. A failed roll means that the animal refuses to learn that particular trick or specialty. Note: These are trained work animals or pets, not familiars. **Base Skill:** 40%/20% +5% per level of experience.

Falconry: The art of training and handling falcons, and other birds of prey. The use of these animals is much more limited than many fantasy gamers would believe. Falcons were used specifically for the entertainment of the rich and hunting game fowl. A standard hunt would entail a game bird, such as a quail, pheasant, duck, etc., being flushed out into the air by dogs, and the falcon released to strike it down.

Players take note! For game purposes, let us presume that these avian predators can be trained to pursue and attack any, visible, flying foe or target, strike down other birds, and return them to its master. Let us further suppose that they can be trained to strike at any "moving" target that they are directed at. This means a falcon could be sent to fly in the face of an opponent and slash at him with its claws for up to two attacks before returning to its master or flying into the sky. These trained birds respond to hand signals and whistles. They are trained to strike and return, little more. Under no circumstances can these birds fly alongside their masters or follow even simple instructions — this is a dumb bird, not a dog with wings.

Note: Falcons or any uncaged birds *cannot* be taken into underground dwellings or inside buildings without panicking. This is one reason they are always blinded with a leather hood. Another reason is that they instinctively attack any small, moving prey and are easily startled. Furthermore, it is impossible to engage in combat with a falcon on **one's** wrist or shoulder without injuring the falcon or oneself.

Trainers must roll two out of three successful rolls to succeed in training their bird. Failure means that the animal cannot be broken of bad habits and training is a general failure. **Base Skill:** 30% +5% per level of experience.

Gemology: Skill in identifying and appraising the value of precious metals (silver, gold, etc.) and stones (jade, ruby, sapphire, diamond, etc.). This ability also enables the person to identify fakes, but at a penalty of -10%. A failed roll means the character cannot tell whether or not the item is fake or real, or its value is grossly under or overestimated. **Base Skill:** 25% +5% per level of experience.

General Repair/Maintenance: Not everyone can be an Operator, blacksmith or carpenter, but many are good with their hands and capable of doing satisfactory repairs on simple mechanisms, gears, pulleys, wheels, rope, and so on. The general repair/maintenance skill includes: sharpening blades, minor repairs on weapons, pack their own S.D.C. bullets/ammunition, sew tears in clothes (it may not look pretty, but does the job), replace a wagon wheel, change a tire, shoe a horse, repair furniture, paint, varnish, nail and assist in basic woodworking, and even do minor patchwork on armor (restores 1D6 M.D.C.).

Roll once to see whether the character can figure out what's broken, what must be done to fix it, and whether it's beyond his meager abilities. Roll again to determine success or failure in making the actual repair. If failure, the player may try again, but only twice. **Base Skill:** 35% +5% per level of experience. Reduce skill proficiency by half if the item is extremely damaged, complex, high-tech or alien.

Language: Chinese (New): The Chinese language continues to flourish in that part of the world and in neighboring regions such as southern Russia, Mongolia, and parts of the Middle East and India. It is included in *Rifts® Russia* because of the large number of refugees fleeing demon infested China. **Base Skill:** 40% +5% per level of experience for all Asians, but only 25% for all Westerners.

Language: Mongolian (New): Modern day Mongolian is a bastardized form of Chinese, Pakistani and Himalayan sub-dialects, mixed with various Russian words for certain items, people, weather and so on. It is spoken in eastern Kazakh, Afghanistan, and Pakistan, as well as Mongolia and parts of Siberia and northern China. **Base Skill:** 40% +5% per level of experience. Note: Characters who speak Russian or Chinese can pick out words and phrases at about a 35% level of understanding; those who speak Euro can only understand at a 10% level.

Language: Russian (New): The Warlords are so drive to reclaim and rebuild Russia that they insist on speaking the Russian language as it existed prior to the Great Cataclysm. The only changes in the language are some words added to describe dimensional Rifts, ley lines, D-Bees, and magical references, as well as local slang words for various spirits, undead and monstrous creatures. A speaker of Old Russian can understand other Slavic dialects (Ukrainian and Polish at -40%). **Base Skill:** 50% +5% per level of experience.

Lore: Cattle/Animals: This is a general knowledge about cattle, horses, livestock, and other notable animals of Russia. This knowledge includes what they eat, where they live in the wild, their means of defense, the value of their meat, fur, hides and horns, and their natural predators, as well as the most notable tales about supernatural animals, spirits, gods and magic at-

tributed to or involving animals. **Base Skill:** 30% +5% per level of experience.

Lore: D-Bees: Most D-Bees (the slang for Dimensional Beings) are just alien humanoids from another dimension or planet. To be classified as a D-Bee, the creature must be remotely humanoid in appearance, usually a biped, have a human-like intelligence and must not possess supernatural powers. Creatures who are not humanoid in appearance and have extremely monstrous or demonic appearances **and/or** powers, are usually considered to be monsters rather than D-bees.

D-Bee lore is the general study of alien humanoids. This area of study will include culture shock, common types, common behavioral patterns, the distinction between instinctive predators and socially oriented beings, myths and legends. The skill is often limited to those living in a specific geographic region where the skill is being taught. In this case, that would be beings living in Russia, eastern Europe, Mongolia, and Northern China. D-Bee lore is not a science. Consequently, it is *not* always accurate, complete or in-depth. See the anthropology skill for an in-depth approach to behavioral science. **Base Skill:** 25%+5% per level of experience.

Lore: History of Russia (New): This is a basic historical knowledge of the myths, legends and (distorted) history of the pre- and post-Rifts Russia. It includes the history of the Soviet Union, Communism in Russia, bits and pieces about the Ukraine, Poland and Mongolia, but focuses mainly on **pre-Communism** traditions, Christianity, ancient gods and myths, and basic information about notable monsters, vampires and famous Russian people, heroes, and outlaws. The base skill percentage indicates the approximate degree of information the character has learned or can remember accurately. **Base Skill:** 30% +5% per level of experience.

Lore: General Law (New): The study of Law allows the character to know many legal precedents, procedures and punishments *common* throughout the Russian Frontier. It includes the laws, customs and punishments of the Warlords, Cossacks and Sovietski, the code of the War-Knight and Huntsman, as well as the laws, customs and practices of most villages and major cities. This can be an invaluable skill when trying to bargain for one's life before a Warlord or Council of Elders. **Base Skill:** 25%+5% per level.

Lore: Magic: This area of study does *not* give the character any magic powers, or the ability to use **Techno-Wizard** devices, or read magic symbols. What it provides is general information about magic, practitioners of magic, magical creatures (dragons, unicorns, etc.), and regional myths, legends and rumors about magic and magical places. For example, a character with this skill knows about the general powers and abilities of infamous magic creatures such as the various types of dragons, sphinxes, unicorns, and so on. He'd know the main types of magic (on Earth or at least his geographic area), such as spell **casting/Line** Walkers, summoning/Shifters, **Techno-Wizardry**, Smith Magic of the **Kuznya**, Necromancy, Witchcraft, and so on. Likewise, the character is likely to know legends about powerful magic items, places, curses and notorious practitioners of magic. Although the character cannot read runes or mystic symbols, he is likely to be able to recognize whether the symbol is a real magic ward, rune or warning.

The following abilities come with this layman's skill: **Base Skill (general knowledge):** 25% +5% per level of experience.

Recognize wards, runes and circles: 15%+5% per level of experience. **Recognize Enchantment:** i.e. magic items, people under the influence of magic charms, possession, curses, mind control and similar: 10% +5% per level of experience.

Lore: Psychics & Psionics: Knowledge about psionic powers, how they are believed to work, how they affect people, their limitations, and who possesses them. This skill also provides a rudimentary knowledge about people and beings who possess psionic powers such as minor and major psychics, healers, **Psi-Stalkers**, Simvan, Bursters, Mind Melters, Mind Bleeders, and the most infamous supernatural creatures (vampires, possessing entities, Goquas, Mindolars, **Raksashas**, etc.). The character may also have a passing knowledge about some of the psionic weapons and **symbiotes** of Atlantis, famous psychics in the region, mind control (via drugs, psychology, hypnosis, magic and psionics) and myths and legends about such places as the Astral Plane, **Dreamstream**, The Enclave and Psyscape. The character does not have to be a psychic himself, but he should believe that psychic powers really exist. **Base Skill:** 25% +5% per level of experience.

Lore: Religions: The study of religions, gods and beliefs. This skill provides a comprehensive study of the religions of Russia and Europe, past and present, their beliefs, rituals, holy places, pantheons of deities and supernatural creatures (demons, spirits, angels) and their stories of creation, myths and legends. The skill will help a character recognize specific rituals, their purpose, the **deity(s)**, whether a blood sacrifice is necessary as well as religious fetishes, charms, icons, and similar. The percentile number indicates the degree of knowledge one has about a particular religion and his ability to remember it. At least half the Russian people are Catholic, 10% are some other Christian faith, 15% practice Judaism and 25% other (Buddhism, Hindu, Moslem, and many others). Peasants and Soldati alike are surprisingly religious and speak of "God," holiness, blessing and faith. **Base Skill:** 30% +5% per level of experience.

Masonry (New): A rudimentary understanding of the principles of bricklaying and stone construction. The percentile number indicates the success ratio of recognizing deterioration, improper construction, the intended purpose of construction, styles of masonry, approximate age or period of construction, identify alien and human construction, and general data about mason guilds. The character can also mend masonry and assist in construction and demolitions. **Base Skill:** 30% +5% per level of experience.

Prospecting: The character can recognize and evaluate precious and semi-precious metals (gold, fool's gold, silver, bronze, copper) in their natural ore appearance and as refined and polished jewelry. In addition, the character has a good idea of where to look for such mineral deposits, and the fundamentals of "panning" for gold and the general knowledge of mining and how to use various types of simple mining equipment.

Furthermore, the character can identify and appraise the value of precious metals (silver, gold, etc.) and stones (diamonds, rubies, etc.), and identify fakes, but at a penalty of -10%. A failed roll means the character cannot tell whether or not the item is fake or real, or he grossly under or overestimates its value. **Base Skill:** 20% +5% per level of experience.

Rope Works (New): This is a skill that takes into account the various needs and uses of rope. The character knows a vari-

ety of ways to tie knots, the advantages to various types of ropes and cords, their tensile strength and how to weave/make rope. A failed roll to tie a knot means that it is loose and sloppy and easy to untie, slip out of, or likely to unravel or snap when strained. **Base Skill:** 30% +5% per level of experience. Characters **bound/tied** by this character are -10% to escape/slip knots.

Whittling & Sculpting: The art of carving wood, bone and horn into three dimensional figures/statues/toys, designs, and simple objects like wooden stakes, arrows, fishing hooks, walking sticks, staves, bowls, a simple flute or whistle, and similar. Many characters with this skill simply use it to pass time and don't necessarily make anything from their whittling. The percentile number indicates the quality of technique and the quality of the **work/appearance**. Taking the skill twice indicates a professional quality and gets a bonus of +10%. Selecting it once indicates a talented amateur. **Base Skill:** 30% +5% per level of experience.

Weapon Proficiencies

A note about Weapon Proficiencies (W.P.): Each W.P. provides combat training with a particular type of weapon. The result is hand to hand combat bonuses to strike and parry whenever that particular weapon is used. All bonuses are cumulative. Each W.P. counts as one skill. The character may select several W.P.s or a few. Note: Characters without a W.P. *can* use any weapon, but without benefit of the W.P. bonuses.

W.P. Grappling Hook (New): Trained use of a grappling hook for climbing, scaling walls (adds +5% to that skill), boarding vessels, tripping an opponent (by hooking the foot, ankle or leg. Does no damage, but knocks victim to the ground and he loses initiative and one melee attack) and impaling (does 1D6 damage). +1 to strike or entangle at levels 3, 6, 9 and 12. This weapon *cannot* be used to parry!

W.P. Net (New): Primarily a gladiator or slaver's skill, the net is used to trip an opponent (same as grappling hook), parry or snare/entangle. **Bonuses:** +1 to strike or entangle at levels 2, 5, 8, 11 and 15. +1 to parry at levels 2, 4, 6, 9 and 12.

In addition to the regular *entangle* attack, there are two other types of attacks possible with a net:

Snaring an opponent's weapon: The weapon becomes entangled and is pulled out of the opponent's hand. A natural, unmodified (no bonus) roll of 18, 19 or 20 will disarm an opponent in this way, unless he can roll an equally unmodified high parry (no bonuses).

Snare one's opponent by throwing the net over him: The intended victim must *dodge* or be netted — only characters with a spear, pole-arm or staff can *parry* a thrown net attack. If caught in the net, the victim is -8 to strike, -10 to parry and dodge, and running is impossible. It will require 1D4+1 melee rounds to cut free of the net.

If the character dodges or the net thrower **misses**, it is the net wielder who will suddenly find himself weaponless. Even if the net has a drawstring attached to it, the thrower will need one melee **action/attack** to pull it back to him or to grab a different weapon; the throwing of a net to capture an opponent requires the use of two hands. However, if the net is being used to parry, entangle or whip an opponent, it can be used with one hand, while the other wields a sword or other weapon; parry the same as usual. Using the net as a whipping weapon does 1D4 damage.

W.P. Paired Weapons: Users of paired weapons can:

1. Strike and parry simultaneously. In other words, warriors skilled in paired weapons can often perform *two actions* for every *one melee action/attack*.

2. Twin, simultaneous strikes against the same target. Both weapons hit, but is considered ONE melee **attack/action**, (roll only once to strike). The defender can only try to parry *one* of the weapons in the parry! The other will **strike**, unless he too is using two weapons, or a weapon and a shield, and *has* the W.P. paired weapons skill.

3. Strike two different targets (or strike one and parry the other), simultaneously; both must be within reach.

4. Parry two different attackers; one with each hand.

Weapons are limited to the one-handed types and can be used in any combination; for example, two short swords, or short sword and broadsword, sword and knife, mace and shield, etc. Two-handed weapons cannot be used as paired weapons.

W.P. Shield (New): Combat skills with large and small shields used primarily for parrying and self-defense in close combat. **Bonuses:** +1 to parry at levels 1, 3, 6, 9, 12 and 15. A shield can be used in one hand and a weapon in the other. +1 to strike with a shield (1D4 damage) at levels 4, 8 and 12. No bonus to strike when thrown. **Note:** A shield cannot be used to block bullets, rail gun bursts or energy blasts, at least not easily. Any such attempt is done without any bonuses (straight die roll) and at -8 to parry.

W.P. Siege Weapons (New): An understanding of the tactics, use and mechanics of siege weapons, including **balista**, catapult, onager and **trebuchet**. +1 to strike at levels 2, 5, 9 and 12.

W.P. Trick Shooting (New): This weapon skill is a modified version of the one presented in **Rifts® New West™**. Most Men at Arms O.C.C.s can pick *one* of the six tricks (or roll 1D6 for random determination). Only the *Cossack* gets all six, and a few others get 1-3; they'll be noted under the respective O.C.C.

1. Can fire a traditional two-handed weapon, like a rifle, one-handed without penalty (normally the shooter loses all strike bonuses).

2. Can shoot over his shoulder by holding up a mirror and using the reflection to aim. Reduce the bonus to strike by half, unless a *Cossack* who keeps full bonuses to strike.

3. Accurately shoot while riding a horse or a moving vehicle (normally a wild shot), but strike bonuses are half and a "called" shot is impossible.

4. Shoot accurately while standing on head or hanging upside down; all bonuses applicable at full.

5. Dodge, roll or somersault and come up shooting (normally a wild shot), no bonuses or penalties to strike; straight roll of the dice.

6. Ricochet shot! The shooter can bounce bullets, arrows, slings, and other fired *projectiles* (depending on the specific W.P.) off of one surface and angle the shot in such a way that the projectile **ricochets/bounces** off and hits a **different/second** target! Inflicts only one point of damage to the first surface and normal damage to the second. Reduce bonuses to strike by half.

This can also be done with laser weapons but the **ricochetting** surface must be mirrored or highly polished. Glitter Boys are excellent reflective surfaces for performing a ricochet laser shot.

Particle beams, ion blasters, rail guns, mini-missiles and other types of weapons *cannot* be used.

Restrictions & Conditions:

- The Trick Shooting abilities are applied to any *Modern Gun/W.P.* or *Archery & Targeting* (sling, crossbow, and bow and arrow) W.P. skill known to the character. It cannot be used with weapons that are hand-held or thrown, or any projectile weapon/gun in which the character does *not* have a W.P. (this skill basically augments W.P. skills with long-range weapons).
- This skill is never available to robots, master psionics, practitioners of magic, dragons, demons or any creatures of magic or supernatural beings.
- Juicers, Crazies, and 'Borgs are limited to only one Trick Shooting skill, maximum.
- The Trick Shooting ability is *NOT* available as a Secondary Skill selection.

W.P. Whips: Skill at "whipping" or snapping with long, flexible weapons typically made of leather, rawhide, reeds or M.D.C. cords.

Damage: Single cord whip: 1D6 S.D.C., Bull Whip: 2D6 S.D.C., Cat-O-Nine Tails: 2D6 S.D.C.

Bonuses: +1 to strike, disarm, or entangle at levels 2, 4, 7, 10 and 13. +1 to damage (special) at levels 2, 4, 8 and 12. This weapon *cannot* be used to parry! An M.D.C. whip still inflicts S.D.C. damage, but is more resistant to damage.

Combat Notes

Disarm: In hand to hand combat, the act of disarming is simply getting rid of the opponent's weapon; it does no damage. It can be used as a defensive move in place of a dodge or parry, or can be done as an **attack/strike**. In modern combat, the act of disarming may involve shooting an opponent's weapon out of his hand; it does no damage.

The disarm move with a hand-held weapon like a sword, knife, **staff** or whip is a strike, and a hold or grappling maneuver that causes an opponent to drop his weapon or whatever he's holding. Using a gun to shoot a weapon out of an opponent's hand requires a called shot and careful aim (only the Gunslinger can shoot to disarm on a quick draw). The maneuver counts as one melee **attack/action**. Disarming an opponent does not mean the weapon falls into the hand of the character making the disarm move. True, the item is forced out of the victim's grasp, but it is either knocked away or falls to the ground.

Typically an opponent is disarmed on a roll of a natural 19 or 20, and it is used as a defensive action. A few O.C.C.s get a bonus to disarm.

To disarm, roll to *strike* as usual — high roll wins. A failed disarming attack does no damage, but means one's opponent remains armed, is probably mad, and ready to strike back.

Entangle: A defender can attempt to trap the weapon, arm or foot of an opponent. This is done instead of parrying or dodging, and counts as one melee **attack/action**. An entangle is successful if the defender rolls above the attacker's strike roll. It takes one attack and another roll to entangle to keep an opponent's arm or weapon **trapped/pinned** every melee round. In order to get free, the entangled opponent must roll a dodge against the entangle roll; high roll wins. The character using the entangle move can-

not attack without releasing his entangling hold.

Entangle with a whip or rope is a bit different in that it can be used at a distance to disarm or to ensnare and knock or pull an opponent down. Roll to strike as usual. Also see the Roping skill in **Rifts® New West™**.

Physical: Swimming & Fatigue Note: For humans and similar surface dwelling D-Bees, the act of swimming on the surface of the water has the same fatigue rate as running and medium to heavy exertion, especially at great speed or very long periods of time. Swimming underwater with S.C.U.B.A. equipment or other underwater equipment is considered to be light activity, unless extremely active, involved in combat or fast swimming (in which case it is considered strenuous or heavy activity).

For most aquatic life forms, including D-Bees and mutants, underwater activities such as fast swimming, diving, playing and underwater acrobatics are considered light activities and can be conducted for hours without fatigue. Pulling a heavy load and engaging in combat is considered medium to heavy activity.

The buoyancy of water *reduces the weight of most items by 30%* when *used/carried* underwater. This means the fatigue rate for carrying a heavy load is reduced by 30% — meaning 30% more can be carried at the normal fatigue rate. Characters can also lift 30% heavier weights.

Power Armor Skill Note: The skill described in the **Rifts RPG**, page 30, includes non-combat models of light, medium and heavy power armor as well as diving suits and experimental and light combat underwater power armor. *Robot Combat Elite* is required to pilot heavy combat power armor, underwater robots and advanced robot vehicles.

Most types of power armor, including airborne types like the **SAMAS**, are suitable for use underwater, although **flight/propulsion** speed is reduced by 80%. Power armor without jet propulsion can travel underwater (swim or walk along the bottom), but also at -80% their normal land speed.

Wilderness

Dowsing (New): This is the ability to locate fresh water whether it be with a divining rod or by more scientific and logical means. For some (like Gypsies) it is a mystical ability, while for others (like the **Huntsman-Trapper**), it is done through deductive analysis and knowledge of nature. The percentage number indicates the success ratio of locating fresh water. A person can roll once every melee to sense water, but must roll *two consecutive* successful rolls to locate the water. **Base Skill:** 20% +5% per level of experience.

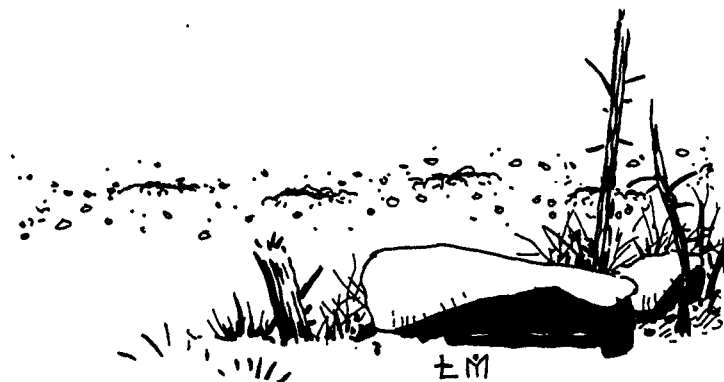

The Sovietski

The people of the New Soviet argue that they are the only direct line to Russia's past — the only fragment of the ancient **pre-Rifts** civilization to survive through the Dark Ages and into the present. To a large degree this statement is both true and false.

The Sovietski of Rifts Russia originates from an ultra-modern **21st** Century military installation that survived the Great Cataclysm unscathed by the destruction of the Great Cataclysm. Scant moments after the world erupted into chaos, communications with Moscow and the rest of the world were lost. Except for their own internal communications and chatter from other communities within a few hundred miles, they were suddenly shut-off from the rest of the world. Thirty-six hours later, all satellite feeds vanished and even the chatter from panicked citizens stopped. There was only radio silence and the raging storms outside. They were alone.

The base had its own nuclear power plant and locked down to weather the holocaust around them. According to the records of the Sovietski, the base was shut and sealed completely for nine weeks while freak storms (and much worse) swept across the planet. The first reconnaissance patrol reported total carnage. All of Moscow had been consumed, leaving a steaming radioactive crater in its place. All radio attempts failed to contact any known military installations, satellites or civilian outposts. The skies were grey and the snow was already falling. Freak storms of snow and ice and strange atmospheric effects ripped at the skies daily and without warning. Great billows of soot, sulfur clouds and acid rain rolled down from the north and sometimes made it impossible to breathe. There were also strange noises, lights and reports of monsters. Several reconnaissance teams never **returned** and less than 200 civilian survivors were found and brought back to the safety of the base.

At first, the survivors suspected a nuclear attack by the Chinese, but they quickly realized that the entire world had been engulfed in **armageddon**. Strong leadership at the military installation maintained control over its 26,000 troops and kept morale as high as could be expected. The base, 75% of which was underground and **designed** to survive a nuclear onslaught, and could accommodate three times as many troops, was **secured**, locked down and quietly maintained. They would not resurface for three and a half years. When they did surface, Russia was locked in an ice age. Patrols were dispatched to scrounge provisions, mainly food. Long-range patrols confirmed Russia and neighboring countries had been transformed into desolate wildernesses. Leningrad (**aka** St. Petersburg) and most communities were either destroyed or buried under snow and ice. Unbelievable volcanic activity from Leningrad to the White Sea prevented anybody from coming within miles of the region and prevented land patrols into Scandinavia. Poland and some of the other border countries of Europe appeared to be as devastated as Russia (at least from the vantage point of the Russian patrols), although the snow seemed less severe.

The appearance of powerful and monstrous "alien beings" led to the theory that Earth had been invaded by an extraterrestrial force. This which seemed to explain the loss of satellite communications and the global devastation wrought in a matter of minutes — a coordinated space attack. This popular theory

(along with a few others) held for 40 years. In the meanwhile, the troops did what they could to survive and maintain their position, desperately praying that other military forces had survived and would eventually join them (others had survived the initial Cataclysm, but most would perish while a small percentage would make their way to Germany and other comparatively safe bastions of humanity).

Under the strong leadership of the base command, structure and organization was maintained. With the passage of time, children were born, and the base became a military community. The military leadership maintained stringent military order and the communist ideal. Suffice it to say, they survived and grew. When the Eighty Years of Winter came to an end, the military installation was bursting at the seams with people, had weathered all manner of strife, and come out of it all the stronger. They were the first to find old cities and other military bases and strip them of their resources. They quickly established a compound around the base and, armed for bear, fought off all who stood in their way, human and inhuman.

In the early days, people flocked to them because they could offer impressive military protection, military/political order, some measure of stability and the old, lost way of life. This made the New Soviet, or "**Sovietski**" as it quickly became known, grow geometrically over the first few decades of its appearance. A strong fortress city grew around the base, while a dozen small towns and villages sprung up around it. An old geothermic power plant near the base site (shut down in the early days of the snow and chaos due to earthquakes, volcanic activity and unpredictable conditions) was reactivated. Tactical nukes (most of which were deployed during conflicts in the first century after the snow receded) and a vast armory of military equipment, supplies, weapons and vehicles were successfully recovered from numerous other Soviet installations. Hordes of monsters were obliterated and driven away.

Over the next two centuries, the descendants of the military base successfully hung on to their heritage, technology, and their faith in God and the New Soviet government. They have tried to rebuild their world the best they can by establishing the New Soviet Nation.

Unfortunately, in recent years, the Sovietski has suffered some serious setbacks at the hands of the emerging Warlords of Russia. For the last two decades, the Sovietski has lost 60% of its land holdings to one Warlord or another, and Warlord **Orloff** continues to threaten their sovereignty. This situation arose, in part, because the Sovietski did not take the Warlord threat seriously. Approximately 80 years ago when the Warlords began to show themselves as potential powers, the Sovietski dismissed them as savage, mostly low-tech barbarians who could not challenge their power (true at the time), warred over vast expanses of wilderness and ruled over medieval-level peasants, and who (they believed) were not organized or civilized enough to ever amount to anything. The Sovietski also underestimated how the "wilderness peasants" would embrace the Warlords. Both were tactical errors that would haunt the Soviet nation for years to come.

Other things that had served them well in the beginning, would later become liabilities. Early on, the Sovietski had made a conscious decision to consolidate their efforts in one, comparatively small, but super-strong region. They were careful to never overextend themselves and to build (comparatively) modern, civilized communities that **harkened** back to the era before the Great Cataclysm. However, the Earth would never be the

same, and the Sovietski's fierce determination to recapture the old ways would make them slow to adapt and change with the times and the new, alien world that Earth had become. Along these lines, they also decided to keep a "low profile" presence and isolationist policy to avoid attracting the attention of monstrous and alien forces. Again this worked for them, especially in the early days when the Russian people, especially those in the region, found their way to the new nation, but in the years to come it would work against them. Many peasants and returning refugees had no idea the Sovietski existed. Likewise, other burgeoning city-states, groups and nations (like the NGR) knew nothing about it, except for the occasional story about a grand city in the northwestern forest. The Sovietski has really only made its presence known to the rest of the world in the last couple of decades. Ironically, had they done so sooner, they may have established diplomatic and military relations with the New German Republic and gotten them to quell the threat of the Warlords. As it is, the NGR sees no one, strong government or nation, and has elected to stay out of the affairs of this turbulent part of the world.

Their isolationist practice and stern protectiveness of the Soviet people made them seem cold, uncompassionate and unresponsive toward people outside their closed community. They also suffered from culture-shock: The people of the Sovietski are comparatively well educated and live by social standards, ethics and morals of a bygone era, while the rest of Russia (and the world) had sunken into poverty and chaos, most with little or no idea of what the world was like 300 some years ago before the Great Cataclysm. Consequently, both are disturbingly and distastefully alien to one another. The Russian and Eastern European peasants have returned to simpler ways of life and don't particularly understand or want high technology or city life, which is what the Sovietski has to offer. While the Sovietski has a policy of accepting human refugees from all walks of life, they do tend to be elitists who exhibit a fair amount of disdain, intolerance and condescension toward the ignorant and superstitious "backwoods peasants" that represent the majority of the scattered humanity of Rifts Russia. The Sovietski also suffers from "location" problems. They occupy and control a small region of northern Russia up around the old Moscow region (and at one point, as far north as Novogorod and **Leningrad/St. Petersburg**). The land is rugged, wooded, and isolated. The winters are long and cold, and the land is not particularly well suited for farming or raising livestock. As a result, many people preferred to live in the rich, arable lands of the Ukraine, Lithuania, Latvia, the western steppe, and the light forests and plains of central Russia. Following their plan of isolationism, they made no efforts to recruit or collect these "backwoods peasants," leaving them easy and willing targets for the emerging Warlords who offered to preserve their way of life, protect them and free Russia from the invading demon hordes. To these "peasants" the Warlords appeared to be proactive patriots willing to help them and restore Mother Russia, while the Sovietski seemed like an uncaring fort in the wilderness concerned only for their own necks (which to a large extent was true).

The Sovietski Today — Circa 105 P.A.

Statistical Data for The New Soviet

Population Total: 3.6 million

Population Breakdown: Human — 98%

Approximately 62% are of Russian descent; 36% originate from other regions, including Poles, Finns, Ukrainians,



Byelorussians, Slavs, Turks, Georgians, and Armenians; 2% are D-Bees.

Major Cities: The New Moskva (New Moscow) Superfortress is the city that has grown around the military base and serves as the heart of industry, the military complex and the Soviet government. Population: 1.9 million.

Other cities include *New Leningrad*, *Kaliningrad*, *Kurlensk*, and the *Volga Fortress compound* (the newest military complex, hydro-electric station and city). Each is a partially industrialized city with a center area of modern buildings, fortifications and military defenders. Populations are 77,000, 68,000, 54,000 and 33,000 respectively.

Numerous farms, villages and outposts are scattered throughout the Sovietski.

The Moskva Crater, the largest of the western Deadzones, is also located in the Sovietski. It still radiates low, but dangerous levels of radiation and is haunted by ghostly spirits and seems to attract supernatural beings.

Flora & Fauna. This is a temperate region, with changing seasons and dense forests. Other than land cleared for agriculture and urban expansion, most of the land in and around the Sovietski is covered with brooding forested wilderness broken by occasional marshlands or swift streams and rivers. An abundance of wildlife is found here: grey fox, black bear, lynx, wolves, wild hare, game birds and geese, sable, beaver, moose/elk and Russian white-tail deer to name a few. Alien creatures, demons and D-Bees also stalk the woodlands. **Note:** Attitudes toward D-Bees range from hostile to quiet acceptance.

Brodkil and Gargoyle Invaders: Brodkil and gargoyles are exterminated wherever they are found. The savage wars in Germany and Poland have enticed growing numbers to emigrate eastward into the new Russian Frontier (as well as Sweden, Finland, Lapland, Norway, Romania, Bulgaria, Yugoslavia and Czechoslovakia). See *Rifts® Triax & The NGR™* for details about these races, their weaponry, plans and haunts.

The Gargoyle and Brodkil wars and migrations are also sending other creatures and intelligent beings eastward.

Civilized Russia

The Sovietski, or "New Soviet," is the most advanced human civilization in western Russia at this time (Kiev, in the Romanov Sphere, comes in second, with the Burgasov key city complex coming in third). Although it calls itself a nation, the Sovietski holds the smallest, although most (comparatively) densely populated region in Western Russia. The government is based on old Bolshevik doctrine. The individual's first duty is to the Gosudarstvenny, "the State," which provides for them and their "Comrades."

This small but powerful nation has been beset by Gargoyles and Brodkil from Eastern Europe as well as entities and a host of beings unique to Russia and China. They've responded with sufficient force to make these ravaging hordes think twice before launching raids on the Sovietski! They've also done much more than most people realize in driving supernatural beings from western Russia (the Warlords tend to take all the credit). Although they hate and fear demonic beings, and the inhuman in

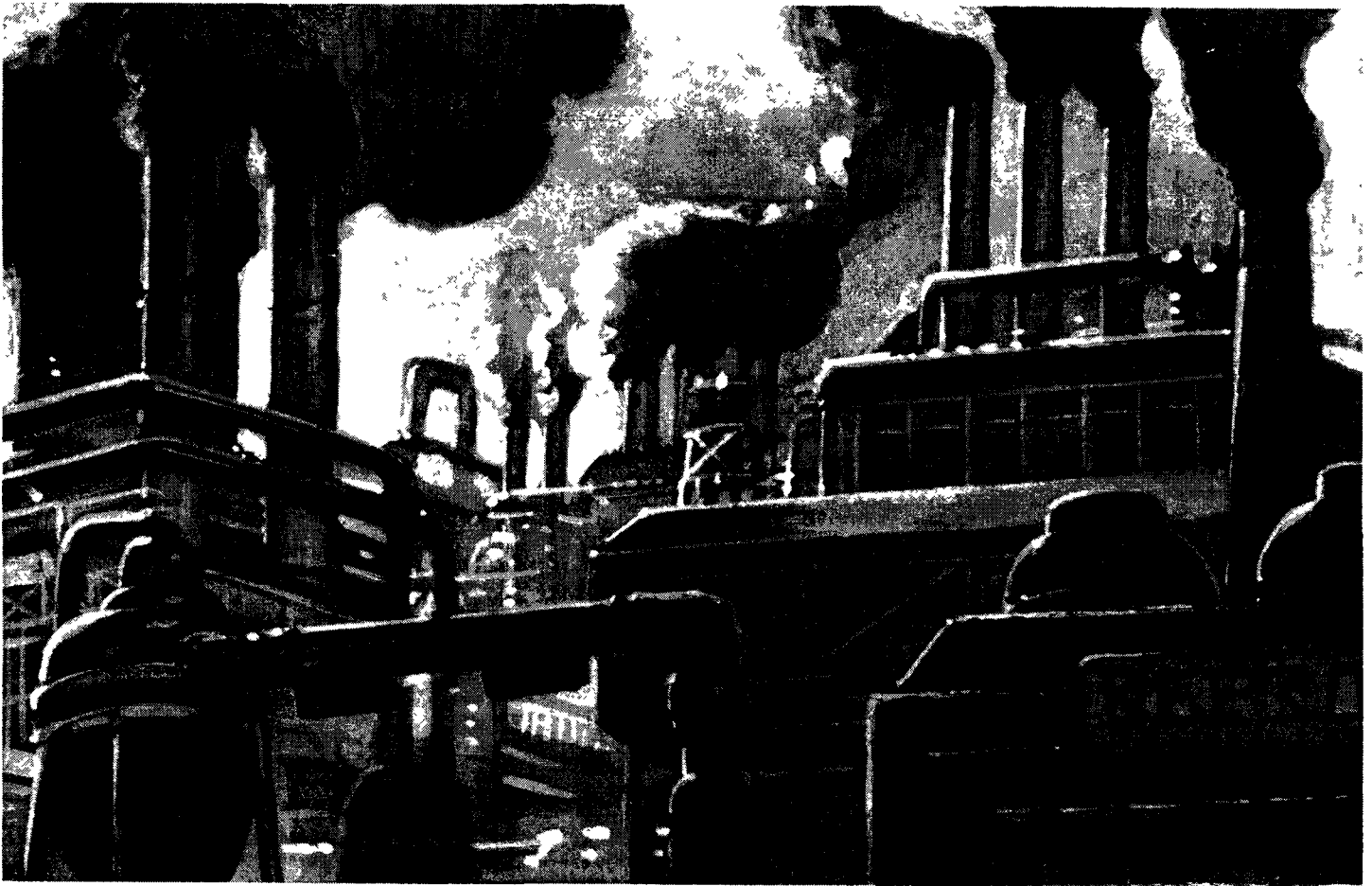

general, they harbor no manic genocidal urge like the Coalition States. In fact, a small percentage of their population is nonhuman (although most are human-like in appearance), and they will sometimes trade with bands of D-Bee nomads.

The Sovietski is frighteningly similar to the way the old Soviet Union was before the Great Cataclysm. If anything, the system of government is more organized, efficient and responsive to the needs of the Soviet people than at any time in history. The military and political leaders tend to be brooding and thoughtful people, perhaps a little grim and suspicious considering the dangerous times they live in and recent incursions by Warlords Orloff and Sokolov. Likewise, the average citizen tends to be practical and hardworking. They can be as cheerful and fun-loving as anybody, but tend to be a bit grim and worried about their future, and very distrusting of outsiders. Of the Warlords, only *Sonya the Great* and her "increasingly civilized" people of the Romanov Sphere are regarded as genuine allies who can be trusted. All others, including *Burgasov* (who has seized approximately 35% of the Sovietski's old landholdings in the north over the last 30 years, but has recently made overtures regarding peaceful coexistence and has acknowledged and observed Sovietski borders for nearly a decade) and *Seriyev* are viewed as dangerous, self-serving predators who respect the Sovietski for its military strength, but little else. Trade with the other warlords is carefully monitored and restricted, mostly food and basic supplies.

The Sovietski government is based on Soviet Communism. The individual works for the State first, then towards his own endeavors. The principle is that by strengthening the government (i.e. "the State," which is in essence the people themselves), it grows stronger to better serve the people as a whole.

There is a very real sense of unity and camaraderie among the people of the Sovietski. This is made all the stronger by a sense of belonging and pride, and, ironically, a certain sense of elitism. The elitism rises from the sentiment that the people and government of the Sovietski represent the "true" Russia. In this case, most citizens of the Sovietski see themselves as (relative) equals, and outsiders, including fellow Russians who don't support the Sovietski, as inferior. While this elitist attitude has already bred some degree of distrust and intolerance toward others, it has helped to cement the people of this sovereign nation and keep them focused and motivated. Furthermore, they are willing to accept any human who is willing to accept their way of life and serve their community.

In this new age and relatively closed environment, working together has meant the difference between life and death. The fundamental concepts of communism (supported by a strong, benevolent military-based government) has worked well in the Sovietski. The communist government is determined not to make the same mistakes as its predecessors, and works hard to keep itself grounded and close to the people. Except within the military rank and file, all citizens (supposedly including the military) are equals and live at the same general social and economic level. Generally speaking, there is no rich or poor. Everybody is on the same level, with surplus wealth and resources going to the State which applies it toward the maintenance, defense and future of the Sovietski. Again, in this particular situation, the Sovietski government has been able to provide for its people. There is ample housing, medicine, food, clothing, and other creature comforts, including public entertainment and programs for the arts. Distribution of goods and services are readily available to those who need and want them.

Thus, the citizens of the Sovietski feel that they are contributing to a strong government that keeps them safe, healthy and treats them fairly. There is even freedom of speech, religion, and the press (within reason), as well as other personal freedoms that were all too often lacking under the old communist regimes. Institutions like *kolkhoz* (collective farming) and government intervention in nearly all aspects of daily life, have worked in the Sovietski.

The people see themselves as a giant community and (for the most part) happily work with one another to preserve, protect and maintain their way of life. The average Sovietski citizen spends approximately 40-50 hours a week at work and 6-12 hours involved in voluntary civil services: restoration projects, volunteer fire/rescue work, **beautification** projects, parks and recreation, public works, and many other State sponsored activities. The rest of their time is their own. Crime is very low and education is outstanding compared to the rest of Russia and much of the world. Over 60% are literate in Russian (equal to 8-10th grade high school levels), and 21% of those have the equivalent of a college education! The work force, or "proletariat," often comprised of immigrants and uneducated farmers and laborers outside the cities, have at least 1-4 years of vocational training, if not a more formal education, as noted above, or a lifetime of experience. Unemployment is at less than one percent. Those living in poverty conditions are under five percent

and are typically uneducated immigrants and those living and working in wilderness regions away from the cities and the heart of the Sovietski.

As one might suspect, maintaining absolute equality is impossible, so there are some comparatively poor and some disproportionately wealthy individuals and families, but they are a tiny portion (less than 6%). Then again, closer inspection of the military government shows some clear levels of (understandable?) inequity.

One of the most obvious is the power of the military. Only the military can build, issue, own and use Mega-Damage weapons, body armor, bionics and vehicles. The military empowered government also controls the manufacture, distribution, sale, use and trade of M.D.C. materials, electronics and cybernetics. Military level bionics are *not* available to the average citizen, and it is illegal to acquire them through unauthorized means (via the Black Market, out of town, etc.). It is also illegal for the average citizen to possess Mega-Damage weapons or magic weapons of any kind. Even a **Vibro-Blade** is considered off-limits. Only select S.D.C. weapons, primarily those used for hunting, are allowed to the average citizen, and then permits and registration are required and the owners carefully screened and monitored for abuses. Some farmers and business leaders *may* be given special permits and supplied by the Soviet State with authorized M.D. weapons, armor and/or vehicles for their protection, the



protection of their workers, or the hunting of M.D.C. animals, but such permission is uncommon and carefully monitored. In situations where the environment is hostile, the police or army will assign guards, escorts, and protectors to the work site, or place the work under military jurisdiction, supervision and protection.

A military and police presence is everywhere — primarily for maintaining the law and protecting the citizens of the Sovietski. The fact that the military has its fingers in all aspects of industry (directly controls 53%), distribution (60%), communications (58%) and absolute control over military and civil defense (99%), gives these military-government leaders and their troops a decided advantage over the average citizen. Furthermore, top priority goes to the military, which means a huge amount of the Sovietski's resources goes toward building, maintaining and expanding the military — of course they need a strong military to survive. This also creates a certain class strata within the military through rank. Political leaders, because of their place in and control of aspects of government (90% of these leaders are also military leaders), and the armed forces in general, are considered a cut above the average citizen and an important priority as the defenders of civilization (as they see it). In many respects, the Sovietski military-government is not all that different than the Warlords, they are just more benevolent, socially equitable, sophisticated and civilized about it.

Sovietski Cities

The cities are typically built around or near major military installations. The heart of the cities are typically the industrial complexes where raw materials are processed and refined, and machines for both civilian life and the military are manufactured. The factories and key buildings will be made of M.D.C. materials whenever possible. Likewise, M.D.C. walls and bunkers (above and below the ground) provide additional support, cover and defenses. Most of the buildings are thick and chunky, many with an art deco styling.

New Moscow is the oldest, largest and most heavily defended of the Sovietski's cities. It is the birthplace of the Sovietski and the heart of its civilization and military (33-50% of the Soviet Army is stationed at New Moscow).

All Sovietski cities are fairly modern, with indoor plumbing, electricity, regional communications network (telephones, radio broadcasts, and even local television, limited to 6-8 hours of telecasts per evening and offering public addresses, news and weather reports, public information, and emergency warnings as well as entertainment programming), as well as other modern conveniences. The general tech-level for the average household is roughly equivalent to mid to late 20th Century, while the military complexes are state-of-the-art 21st Century level technology, with modern weapons, vehicles and equipment.

Roughly 50% of the roads in New Moscow (particularly in the industrial and government sections) are wide, paved, and well maintained. However, only 20-40% of the roads are paved in the other cities, and most roads outside the big cities are unpaved gravel or packed dirt roads. One third of New Moscow is built underground, with a massive underground military complex in the southeastern quadrant. Most other Soviet cities also have an underground city complex and military complex that represents about 15-30% of the city-works.

Items of note in the Sovietski

Rubles (Rb): The Sovietski has kept the Ruble as its official currency. The Romanov Sphere and, to a lesser degree, Seriyev and other Warlords, will usually accept Rubles as a secondary currency largely because the Sovietski and Romanov Sphere value them, and also use the Ruble to some degree. The Sovietski's isolationist policies give it minimal use of Universal Credits, although credits are valuable for trade and purchase from Poland, the NGR and foreign traders. Currently two Rubles equal one credit, and many wilderness people, traders, War Camp factions, and even bandits will not accept the Ruble under any condition. The NGR and most Polish kingdoms do not recognize or accept the Ruble as legal tender — to them it's worthless.

The modern Ruble (Rb) is a bronze coin (dark gold color) about the size and mass of a 20th Century American quarter. It bears the image of the Kremlin Monument on its Reverse and the symbol of the hammer and sickle on its face. Rubles are minted in 1, 10, 100 and 1,000 Rb amounts. For large purchases such as State Land grants, one uses diamonds, gold or State issued "papers" valued at so many tens of thousands of Rubles. Note: Rubles are *not* used extensively throughout Russia.

Diamonds: The standard going rate per-karat on a quality stone is currently 5,000 Rubles. Gem sizes range as high as 20 karat stones, but the average diamond is one half to four karats. With a little pouch full of these goodies, the enterprising individual can purchase items costing hundreds of thousands of Rubles.

Matryoshka Dolls: Matryoshka, "little mother," dolls are hand-painted wooden dolls that are roughly bowling-pin or squash-shaped. The doll opens at the mid-section to reveal another, smaller doll inside it, which contains another and another, with 8-16 total and the smallest being about the size of a hazel nut. Each doll comes apart in the center to reveal a slightly smaller version of itself inside. Some matryoshka dolls contain as many as 16 smaller dolls inside them, although most average 6-10. Prices are high (100-500 credits) for these beautiful, often whimsical and fragile dolls (it takes weeks to hand carve and paint even with modern tools). They are highly regarded not only as works of art, but for having preserved an ancient Russian tradition from before the Great Cataclysm. In fact, Matryoshka dolls that can be authenticated as pre-Cataclysmic artifacts can command tens of thousands of credits (the New Moscow museum of history has three dozen of these ancient relics). Popular dolls include: Recent Sovietski Directors, Warlords, Ballet stars, Saints and soldiers in pre-Rifts costumes. Prices range from 100 to 500 credit; large and/or especially fancy dolls can command twice as much.

Caviar: Known as *Ikra* (ik-RA), sturgeon roe caviar comes in three grades of quality. *Beluga*, the best and most expensive (50-150 credits for three ounces); *Sevruga*, which are pale greyish eggs (20-45 credits for five ounces); and *Ossetrina* which is darker grey in color (8-15 credits for 12 ounces/0.41 kg).

Red Caviar comes from salmon and is one of the most common caviar delicacies (4-6 credits for eight ounces).

Russians eat caviar with crackers, bread and maybe a dry white wine.

Vodka: Nearly as old as the country itself, Vodka is a spirit distilled from potatoes. It is sold at 80-100 proof (40-50% pure alcohol) and is a common and favorite hard liquor among Russians and Poles in all walks of life, from laborers, farmers and

soldiers to the Heads of State. The cost for a three pint (1.4 liter) bottle is 4-6 credits.

Russians especially enjoy flavored vodka; *limmonaya* (lemon vodka), *persovka* (with hot pepper), *zubrovka* (made with certain grasses), *ryabinovka* (containing ash berries), *tminaya* (caraway), *starka* (dark and velvety), *ahotnichaya* (hunter's) and *zveroboy* (the only reference we could find said "Animal Killer!"); all cost about 1-3 credits more than usual.

Other Common Goods: See the Equipment section for more gear. Wool and fur goods are everywhere at about 30-40% less than the list price.

General Katya Nikoforov

Current Director of the Sovietski

The first female Director in Sovietski history has been in power since 99 P.A. (2385 A.D.). Katya Nikoforov comes from good Russian stock. She is a beautiful woman with a strong will and a good military mind. She studied hard throughout her youth and excelled in all academic, citizenship and military training. Katya became a General by the age of 38, Politburo member by 42 and was first in line for the Directorship by the time she turned 47. She assumed the Directorship with the death of her friend **Oleg Gromeko**, whom she always felt was more of a father to her than her own. His blessing went with her, along with his wish that Katya be considered for his position. "Listen to little *Katyana*." He said, "She sees further and clearer than most other eyes looking to fill my seat."

Katya loves Russia and her people with a passion similar to Warlord **Sonya Romanov's**, but with a little less raw emotion and little desire for political power. Director Nikoforov honestly sees herself as a servant of the people. She is highly intelligent, sensitive and aware, quick to catch on to new things and has an insatiable desire to learn. She is both a humanist and a realist capable of making hard decisions. A firm believer in humanity's right to rule the Earth, she actively pits the Sovietski forces against supernatural menaces. While she allows trade with D-Bees (from a position of strength), and has allowed a tiny percentage to become citizens of the Sovietski, she is extremely suspicious of them and often treats them harshly. To hard-line human or Russian supremacists, she insists D-Bees should not be exterminated out of hand, because they represent a potentially valuable resource and it's best to have some contact in order to understand the enemy.

"*Katyana*" to her **friends** and family, she is always busy with matters of State. Getting to speak with her is almost impossible, but she is the kind of person who would listen to anything that involves security of the State. She has small civic projects underway, encourages scientific studies in several areas, encourages (slow) technological advances, keeps New Moscow and most government agencies running smoothly, and keeps the Soviet Army well supplied and prepared for war at a moment's notice. She has authorized several skirmishes against demonic forces, and is currently reinforcing the southern border and secretly preparing for war at the hands of Warlord **Orloff and/or Sokolov** — she can see it coming and has no intention of getting caught by surprise by Orloff and insane ally ever again. The Orloff invasion and conquest of Sovietski territory is (in her eyes and the eyes of her detractors) her one big failure. She secretly hopes to recapture the lost Soviet holdings should the opportunity avail itself, and certainly has no intention of ever falling prey to southern Warlords again. Several **armored**, cyborg and missile divisions have been moved into place to deal with Orloff's and **Sokolov's** incursions into the Sovietski.

The Director is always accompanied by a retinue of 4D6+12 people depending on the situation. These are bodyguards, aides, councilors, military advisors, civil representatives, and others. She is in New Moscow for about eight months of the year, with offices and a residence in the Kremlin. The rest of the year she journeys far and wide to keep morale high and check on the other cities, military outposts, villages, farms and "hot spots." During these excursions, she is accompanied by a company of crack military troops, including a platoon of Heavy Cyborgs and a platoon of Cyborg **Shocktroopers**. She has nothing to fear from her people, as the common man loves and admires her, and she has the support of the military (88% of it, anyway).

Quick Stats

Alignment: Scrupulous

Attributes: I.Q. 18, M.E. 15, M.A. 21, P.S. 28 (**bionic**), P.P. 24 (**bionic**), P.E. N/A, P.B. 19, Bionic Speed: 100 mph (160 km).

Hit Points & S.D.C.: Not applicable.

M.D.C.: Light Machine — Partial Cyborg; two bionic arms and hands made to look human (75% sensitivity), reinforced neck, head and spine, and various cybernetic implants and bionic weapons.

Age: 53 (looks like an attractive and vibrant 40).

Experience Level: 10th level Military Specialist; Director of the Sovietski and General in the Army.

Religious Enclaves

"... I've often been asked by my parishioners how I am able to keep my faith in these trying times. How does any man keep his faith? My father became a martyr for what he believed in. I sometimes think every man has a martyr inside him, waiting to see release. It may be easier for martyrs to keep their faith, for in the end, faith is all they have ..."

— Excerpt from "Thoughts on the New Purgatory." Pope Pious XXI (born Vladimir **Horwitz**) of the Moskva Enclave.

There are currently 74 official "Enclaves"; religious factions/splinter groups who all claim to be the one, true Orthodox Russian Catholic faith. The Sovietski has the largest and most popular "enclave" that is also the closest to the **pre-Rifts** Russian Catholic church. In all cases, the leaders/priests of these enclaves are spiritual leaders, operating throughout western Russia where 60-80% of all the people follow one Catholic faith or another. These factions of the Catholic faith are scattered throughout the Warlords' Spheres of Influence; virtually every village has at least one church and enclave. In the Sovietski, 62% of the people are members of the expansive Moskva Enclave Russian Orthodox Church, with another 17% following 23 **other**, much smaller Enclaves.

An enclave organization begins with the church structure and the priests that live, teach and work there. Churches in western Russia are often surrounded by a **kremlin** and have 1D6 outbuildings. They are supported by local tithes, donations, volunteer work, endowments and so on.

The average Enclave has 4D6x10 personnel, ranging from Bishops to Priests to Acolytes. There are usually only one or two Arch-Bishops and 1-6 Bishops, with around 40% of the enclave personnel being Priests, 30% Sisters, and the rest dedicated Acolytes; Deacons, Brothers, and similar helpers and followers (A half dozen Enclaves are 20-50 times larger, but the Moskva Enclave is 200 times this size, with Priests, Sisters and community churches scattered throughout the Sovietski and beyond).

The Russian Catholic Orthodox churches have again become "preservers of past knowledge." Books, CD's, films, works of art and microfilm are stored in dry, cool vaults located in special sanctuaries, sometimes under the churches themselves. Access to them is restricted, often reserved for high members of the church or for trustworthy adventurers and heroes involved in "God's work" — which can be pretty broad and include protecting the church or its priests or parish, defending Mother Russia from demonic forces and battling supernatural evil, particularly demon lords and vampires. Such heroes are always accompanied by one or two "Fathers" or "Sisters" (and may include one or more protectors of the church; meres, 'Borgs or mages). The artifacts or writings may be examined and read, and they even allow passages to be copied, but the item never leaves its sacred resting place. Some of these historical archives are impressive, large libraries, others a handful of items kept in a small room, closet or box.

Above all else, the Catholic Church, in all its incarnations in Rifts Russia, serves as part of the glue which holds many of the Russian people together during these trying times. The church is a place one can go to find prayer, comfort and talk to God. Most churches offer the usual services of penance, baptism, marriage, mass, blessings and prayers, as well as advice and counsel on many subjects. Some offer additional services such as bible studies, the teaching of mathematics, reading, writing, language, history, art, cooking, etc.

Unlike the priests, shamans and agents of elder, ancient (and dare we say it, "pagan") gods, the Catholic/Christian priests of any demonation have no combat style or magical *supernatural* abilities. They are well-known in their communities and are always hailed on the street with a **friendly** word or a joke (clean ones, mostly). They teach religious doctrine and offer advice on how to live good, pious lives, offer masses, attend births, marriages and funerals, visit the sick, attend town meetings, and are many people's first choice for advice when trouble arises. They serve as both spiritual ministers to help soothe, comfort and direct the human soul and down-to-earth friends and counselors who offer advice in matters of conscience, justice, fair play, marriage, self-esteem, goodness and life in general. Considering the day and age, many are also well versed in lore regarding demons, monsters, faeries, religions (other than their own), philosophy and **frequently**, law and medicine.

Among the supernatural powers of the Catholic Priest (in a role-playing game context) are:

- The priest's knowledge of the supernatural and ways to recognize and avoid their evil and treachery.
- The ability to bless water — makes holy water which can be used like acid against vampires and other select demons.
- Draw upon the power of the **Crucifix/Cross** as a holy symbol that can be used to keep vampires, ghouls and most other lesser demons and Faerie Folk at bay. It also gives the priest spiritual focus and strength: +1 to save vs magic and illusions, +2 to save vs possession and demonic mind control.
- The laying of the cross which will burn vampires and all demons who touch it (does the equivalent of 1D6 S.D.C. or M.D., as the case may be).
- Exorcism, which can be used to expel possessing entities and other evil possessing spirits from their unwilling human hosts (not effective against the willing witch).
- Furthermore, the church in Rifts Russia is indeed a *sanctuary* from evil supernatural forces. Vampires, lesser demons,

sub-demons, entities, ghosts, and most other evil supernatural beings *cannot* enter a church. These vile beings can attack the structure of the church building from a distance, but trying to enter a church is both painful and the equivalent of fighting the power of the crucifix as it repels **them/holds** them at bay. Only the most powerful greater demons, demon lords, and fragmented life essences of gods and alien intelligences can penetrate the sanctuary and enter "the House of God." Faerie Folk feel uncomfortable in churches and tend to avoid them, but can enter them if they wish.

Cultural Note: Unlike the churches of modern Earth, the Catholic church of Rifts Russia is understated, demure, poor, and close to the people, especially peasants. They teach goodness, compassion, inner strength and religious doctrine in an attempt to bolster and assure the human spirit.

Women in the Sovietski can become **Acolytes/Deacons** and Sisters, but not Priests or Bishops, while those of Warlord-controlled Spheres must remain content with volunteer work for their churches due to more traditional attitudes.

Some of the religious Enclaves feel it necessary to hire mercenary guards or members of the faithful (some will offer their services "pro bono") as protectors/defenders of the church, messengers, special agents and for other services. Most enclaves and their protectors are well intentioned and fight only in self-defense, but some zealots can be aggressive, militant and dangerous.

Catholic Priest NPC

Note: This is a very general Priest O.C.C. designed specifically with Rifts Russia in mind. These Priests tend to settle in one community and serve to inspire and counsel people in living good, honorable lives. They are not prone to adventure or war and are not recommended as player characters. This NPC is included because Christianity has played a large role in the lives of the Russian (and Polish) people throughout history.

Including modern religions and beliefs in a "game" can be awkward, inappropriate and disrespectful. If played badly, it can offend fellow players or make someone's faith a laughing stock, and none of us want that. We believe that in the context in which it is presented in these pages, there is nothing offensive or in poor taste. Use the Catholic Priest, Church and faith sparingly and as more of a backdrop and good guy helper and advisor rather than an active military, political or monster-stomping force.

Alignment: Any, but most are good or unprincipled.

Racial Restrictions: None, although the majority (80%) are human.

Attribute Requirements: I.Q. 8, M.A. 10, and P.E. 10 or higher.

Psionics: Psionic abilities are not a requirement.

Special O.C.C. Bonuses:

+3 to save vs demonic possession.

+1 to save vs poison and disease.

+2 to save vs Horror Factor.

O.C.C. Skills:

Basic Math (+20%)

Speaks Russian at 98%

Speaks Euro and two other languages of choice (+10%).

Literacy: Russian (+10%) and one of choice (+5%).

Lore: Demon & Monsters (+20%)

Lore: Religion (+15%)

Lore: Two of choice (+10%)

Anthropology (+10%)

Pilot: One of choice (+5%; any except power armor & robots).

Animal Husbandry (+10%)

Preserve Foods (+10%)

Cook (+15%)

Sing (+20%)

Land Navigation (+10%)

Hand to Hand: Basic (no others are available) can be selected as one O.C.C. Related Skill choice.

O.C.C. Related Skills: Choose three specialized skills (similar to a military M.O.S.) from any category (even those excluded below) except Espionage, Rogue, Military, and W.P.; plus four others of choice at level one and one additional skill at levels 2, 5, 8 and 12.

Communications: Any (+10%)

Domestic: Any (+10%)

Electrical: Basic only.

Espionage: Wilderness Survival only.

Mechanical: Basic and Automotive only.

Medical: Any (+5%)

Military: None

Physical: Any, except Gymnastics and Acrobatics.

Pilot Skills: Any, except robots, power armor, military vehicles, ships and aircraft.

Pilot Related Skills: Any

Rogue Skills: None, other than Streetwise (+2%).

Science: Any (+10%)

Technical: Any (+15%).

W.P.: Any, except heavy weapons (rarely knows more than one).

Wilderness: Carpentry and Identify Plants & Fruits only.

Secondary Skills: The character also gets to select two Secondary Skills from the previous list at levels 1, 3, 6, 9 and 12. These are additional areas of knowledge that do not get the advantage of the bonus listed in parentheses. All secondary skills start at the base skill level. Also, skills are limited as previously indicated.

Standard Equipment: Light suit of M.D.C. body armor (typically homemade and used for traveling), a pocket knife (1D4 S.D.C.), walking stick or staff (1D6 S.D.C.), cooking utensils, frying pan, small pot, small kettle, bowl and grinder, chalice, bottle of wine, small silver cross worn on a chain, rosary, eight inch (20 cm) wooden cross, 2D4+2 vials of holy water, small box for carrying communion wafers to the sick, three small sacks or a duffle bag, two sets of priestly raiments (robes, etc. for mass), one set of travelling clothing, cloak or long coat, hooded robe, backpack, bedroll, a canteen or water skin, belt, boots, flashlight, language translator, note pad, 2D4 markers and a dozen pencils, 10 feet (3 m) of thin nylon cord (600 lb./270 kg test strength), and a handful of personal items.

Additional items may be acquired over time (and through role-playing).

Vehicle: None to start; most like to walk, but eventually acquire a bicycle, horse or small vehicle.

Secret Resources: The Priest will know most everybody in his community and will have numerous friends and acquaintances who will provide information, warnings, special items and services, as well as products at a substantial discount (20-40%). Most are also glad to lend a helping hand when needed, and many will stand up to protect their Priest(s) and church. Priests who are compassionate and generous with

their time are highly regarded, especially by peasants and ordinary folk. They are also regarded favorably by the *Mystic Kuznya*, *Mega-Horses*, good practitioners of magic and the gentler of the Faerie Folk. This will mean influence with the common people and the favor, friendship and contact with a variety of different people in all walks of life (but especially the poor). Most Huntsmen, **Bogatyr**s and adventurers regard them with respect, and even Reavers are careful of beloved Priests.

Money: Starts with 3D6x10 credits and 3D4x10 rubles. Wealth is of little concern to many (60%) Priests; most offer prayers, blessings, offer advice and a helping hand to those in need, and graciously accept a meal, wine and a warm, safe place to sleep as their reward.

Cybernetics: None to start and usually avoid them.

The Sovietski War Machine

Armiya Sovietski

— The New Soviet Army

The Russian military was, at one time, one of the largest and most feared on the planet. Although this has changed since the Great Cataclysm, the New "Krasnaya Armiya Sovietski" ("Red Army of the Soviet" or "Soviet Red Army") is comparatively large, extremely mobile, and powerful for its day and age. The Sovietski sees the entire world as a potential threat; not without good reason. Enemy number one are the supernatural forces of evil, actual demons and hellish monsters from beyond the veil of human reality. Warlords Orloff and Sokolov run a close second, with the Brodkil and Gargoyle Empires in the east, the growing gargoyle population in the north, the demon hordes of China in the south and scores of entities, demons, dragons, D-Bees and strange creatures all around them and newcomers coming through dimensional portals all too frequently.

There is mandatory conscription for all male children who are not suffering from a physical impairment, and even they can volunteer for bionic reconstruction or conversion. The age of conscription is 19, unless deferred due to special considerations, typically exceptional scholastic performance or natural abilities that suggest one's talents should be developed through higher education and/or special training (approx. 5% get such deferment). Females may enter the Army on a voluntary basis, and are not limited because of gender. All cadets and soldiers are judged on their individual merits. Roughly 23% of the soldiers in the Soviet Army are female. The period of service is a mandatory five years, with about 39% (67% among cyborgs) becoming career soldiers. The mortality rate in the Army over the last decade has ranged between 14-21%. A war with Orloff and Sokolov is likely to see those number increase to 30-40%.

Sovietski Armor, Weapons and Vehicles: The Sovietski use a combination of grays, reds and black for the colors of their vehicles, weapons and body armor. Those assigned to the arctic and winter (snow) missions will be white and grey.

Body armor for human troops and cyborgs alike is red and black, or red and grey, or red, grey and black; most are sleek and slick looking but incorporate large shoulder and lower leg guards. The helm has a single, wide visor (1x10 in strip).

Sovietski Police

Like the other military powers in Russia, the Sovietski has come to rely on cyborgs as their mainline troops. Since they are a more civilized culture established around the powerful

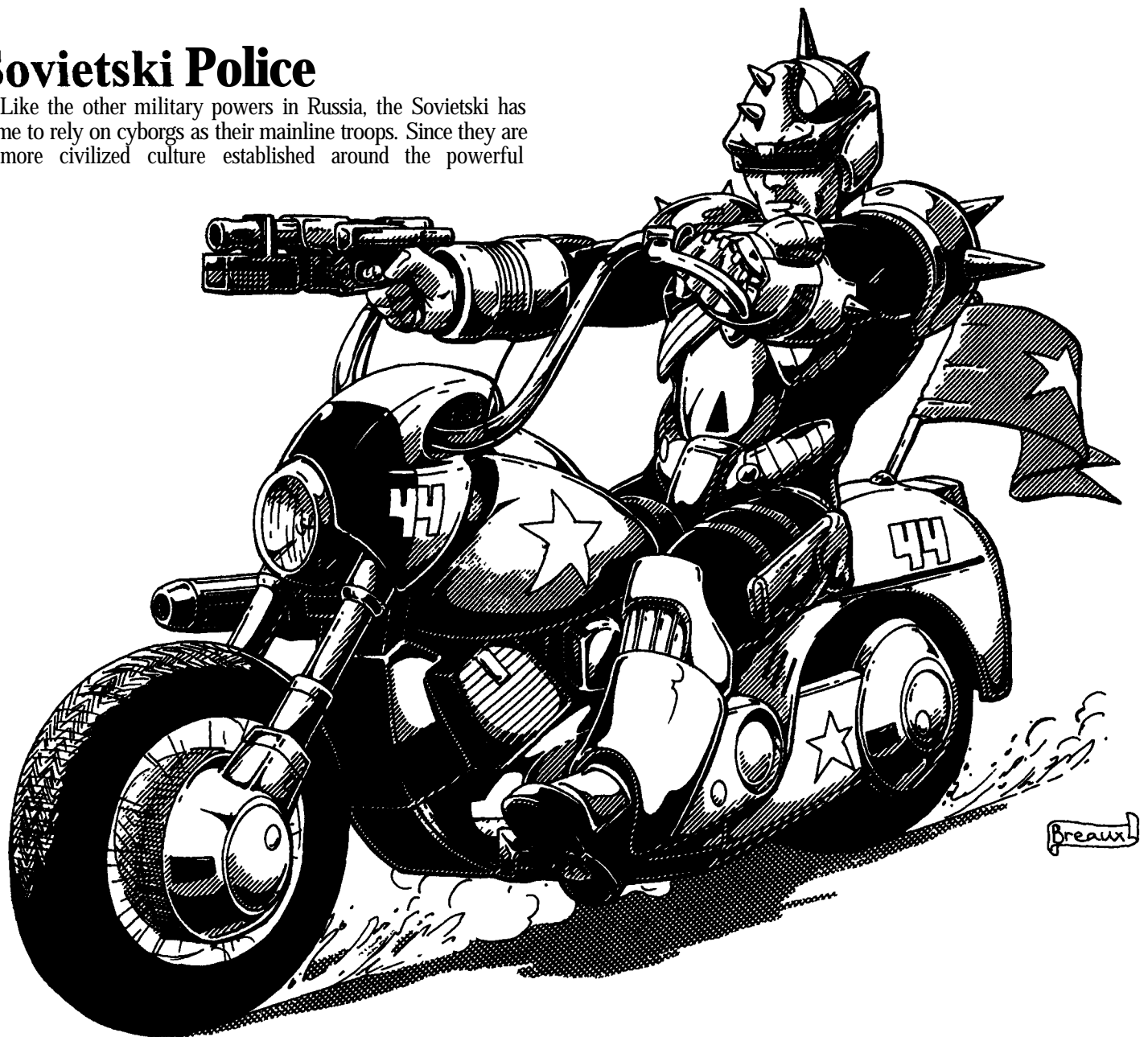

city-state of New Moscow and several smaller cities and towns around it, they also have need for a civilian police force, as well as an Army. The police force is actually a branch of the Army assigned to civil defense and law enforcement. As segments of the same military regime the distinction between the two are often blurred. Not only is the body armor similar and the weapons identical, but both the army and the police answer to the same government authority and both possess a lot of the same law enforcement powers and jurisdictions. For **example**, both can conduct searches of homes and businesses, both can make arrests, both are ever vigilant for dangerous criminals, smugglers, D-Bees, supernatural invaders, monsters, dragons, etc., and both frequently work together, although the police force is generally considered inferior to the military (they have much less combat field experience and military training).

Even the physical differences are negligible. Both use the same basic body armor and medium cyborgs, the only difference being the color — the police cyborgs have the same color scheme as the Red Star body armor used by human law officers, with hands, arms, and legs being dark red with grey armor plating and a red star — the army is black with red metallic plating and a silver star with a soft, reddish tint to it.

Soviet law enforcement divisions have access to the light and medium weapons, armor, cyborgs and vehicles of the Red Army, while the army has access to those same items plus heavy military vehicles, weapons, bionics and Cyborg **Shocktroopers**.

The Soviet police might be considered the "local" or regional authorities who deal with the day to day routine of each city, town and village, while the Soviet Army is more concerned with matters of national security. The duty of the Army includes defense of borders, defense of important factories, cities, military **bases**, and other strategic locations, dealing with raids and encroachment by Warlords, defense against supernatural creatures and full-scale war. Battling the supernatural includes fighting hordes of Gargoyles, **Brodkil** and demons, to the extermination of bands of ghouls, vampires, evil practitioners of magic, witches, necromancers, and other menaces.

The police deal with law enforcement, crime, civil unrest, and similar urban problems. The police also engage terrorists, spies (who may be turned over to military intelligence), smugglers of contraband, criminal factions, local branches of the Black Market, civil disturbances, and similar "city matters." They may call upon the Army (or the Army may intervene) when they don't believe they can contain or reasonably handle

the problem. Such intervention typically involves large bands of heavily armed criminals and raiders, and powerful or widespread supernatural or magical forces.

The Typical Soviet Police Officer

Alignment: Any, although good, unprincipled and aberrant are ideal.

Racial Restrictions: Exclusively human.

Attribute Requirements: I.Q. 9, P.S. 9, P.E. 10 or higher. A high M.A. and P.E. are helpful, but not a requirement.

O.C.C. Bonuses:

- +3 on initiative.
- +2 to pull punch.
- +1 to strike and parry.
- +1 to disarm.
- +2D6+10 to S.D.C.
- +1 to save vs Horror Factor at levels 1, 3, 6, 9 and 12.

O.C.C. Skills:

- Native Language: Russian at 98%
- Literacy: Russian at 90%
- Language: Euro (+20%)
- Language: One of Choice (+15%)
- Basic Math (+10%)
- Radio: Basic (+15%)
- Computer Operation (+10%)
- Pilot Hovercycle (+10%)
- Pilot Motorcycle (+12%)
- Pilot: One of choice (+10%; any except power armor & robots)
- Military Etiquette (+10%)
- Streetwise (+10%)
- Climbing (+10%)
- Swimming (+10%)
- W.P. Paired Weapons
- W.P. Energy Pistol
- W.P. Energy Rifle
- W.P. Trick Shooting (choice of only one)
- W.P. One of Choice (any)
- Hand to Hand: Basic, but can be changed to Expert for the cost of one O.C.C. Related skill, or to Martial Arts (or Assassin if anarchist or evil) for the cost of *two* skills.

O.C.C. Related Skills: Select three MOS skills (with a +15% bonus each) from one of the following categories regardless of whether or not it's normally available: Communications, Espionage, Mechanical, Medical, Military, Piloting, or Rogue (undercover). Also pick four other skills of choice from the list below. One additional skill is selected at levels 3, 6, 9 and 12. All new skills start at level one proficiency.

- Communications: Any (+10%)
- Domestic: Any
- Electrical: None
- Espionage: Any
- Mechanical: Basic and Automotive Mechanics only.
- Medical: Paramedic only (+5%)
- Military: Find Contraband and Demolitions (any) only (+5%)
- Physical: Any, except Acrobatics.
- Pilot: Any (+5%)
- Pilot Related: Any (+5%)
- Rogue: Computer Hacking, **Cardsharp** and Seduction only.
- Science: Any (+5%)
- Technical: Any (+10%)
- W.P.:** Any, except an additional Trick Shooting skill.
- Wilderness: None

Secondary Skills: The character also gets to select two secondary skills from the list, excluding those marked "None," at levels 2, 4, 8 and 13. These are additional areas of knowledge that do not get the advantage of the bonus listed in parentheses. All secondary skills start at the base skill level.

Standard Soviet Police Issue: Red Star body armor (light cyborg armor equivalent, has 120 M.D.C.), energy pistol and energy rifle of choice (including **Triax** weapons, but the **G-21P** and **S-20-20** pistols are the most popular), four extra **E-clips**, one **Vibro-Knife** (1D6 M.D.), small silver plated knife (1D6 S.D.C.), **1D4 stun/flash** hand grenades, two flares, a pocket-sized silver cross, distancing binoculars, signal mirror, utility belt, and backpack or duffle bag. Detectives also get a suit, long coat, scarf, gloves and boots.

If the officer is a Light Machine or Partial 'Borg (most are), he also gets the appropriate ammunition, equipment and body armor for the cyborg's body styling and weapon systems, plus regular maintenance and repairs. Also see Typical Bionics.

Vehicle: Starts with an M.D.C. motorcycle (75 main body, 8 per wheel).

Equipment Available Upon Assignment: Jet pack and other vehicles or transportation, additional weapons, explosives and equipment, plus access to Police facilities, computers and back-up. **Note:** Availability of equipment and bionics may be limited or unavailable depending on the local commander, supply stock, location and combat conditions.

Cybernetics: Typical Bionics: 30% of Soviet police officers are 55% conversion package partial cyborgs, a quarter are 70-80% conversion package partial 'Borgs, and another quarter are full conversion Light Machines. Only 20% are completely human with 1D4 implants. In all but 2% of the cases, cyborg police have a human-looking face and head. **Note:** See the section on *Cyborg O.C.C.s* for details on standard stats common to most Light Machines.

Common Cyborg Police features include:

1. Full 20/20 Enhanced Color Vision (To **line-of-sight**).
2. Targeting Sight (+1 to strike) and light filters.
3. Telescopic Eye with Passive **Nightvision** (5000 ft/1524 m).
4. Multi-System Eye Socket.
5. Universal **headjack/ear** implant with Augmentation
6. Amplified Audio
7. Built-in Language Translator
8. Built-in Radio Transmitter & Receiver (5 miles/8 km)
9. **Cyberlink** Vehicle Interface (2; one in hand and head).
10. **Gromeko** Friend or Foe Identification Computer.
11. Bionic Lung with gas filter & oxygen storage cell.
12. Bionic Speed Running: 120 mph (192 km).
13. Leaping: 12 feet (3.6 m) high or 18 feet (5.4 m) lengthwise; increase by 50% with a running start.
14. 98% have an attractive, human face.

Common Police Cyborg **Combat/Police** Systems: Typically has the first three items and 1D4+2 "optional" systems of choice. Other bionics may be available as well, depending on the situation, character and G.M.; tends to avoid items that are disfiguring, especially to the face.

One forearm weapon on each arm (typically laser or ion).

Concealed **Vibro-Blade**

Climb Cord and Grapple (wrist)

Optional: Chemical Spray

Optional: Palm Laser Torch

Optional: Camera Finger

Optional: Laser Finger (1D4 M.D.; 300 ft/91 m range).

Optional: Tool Hand
 Optional: Built-in Loudspeaker
 Optional: Molecular Analyzer
 Optional: Cyber-Shield
 Optional: Cyber-Disguise (either)

The Typical Soviet Soldier

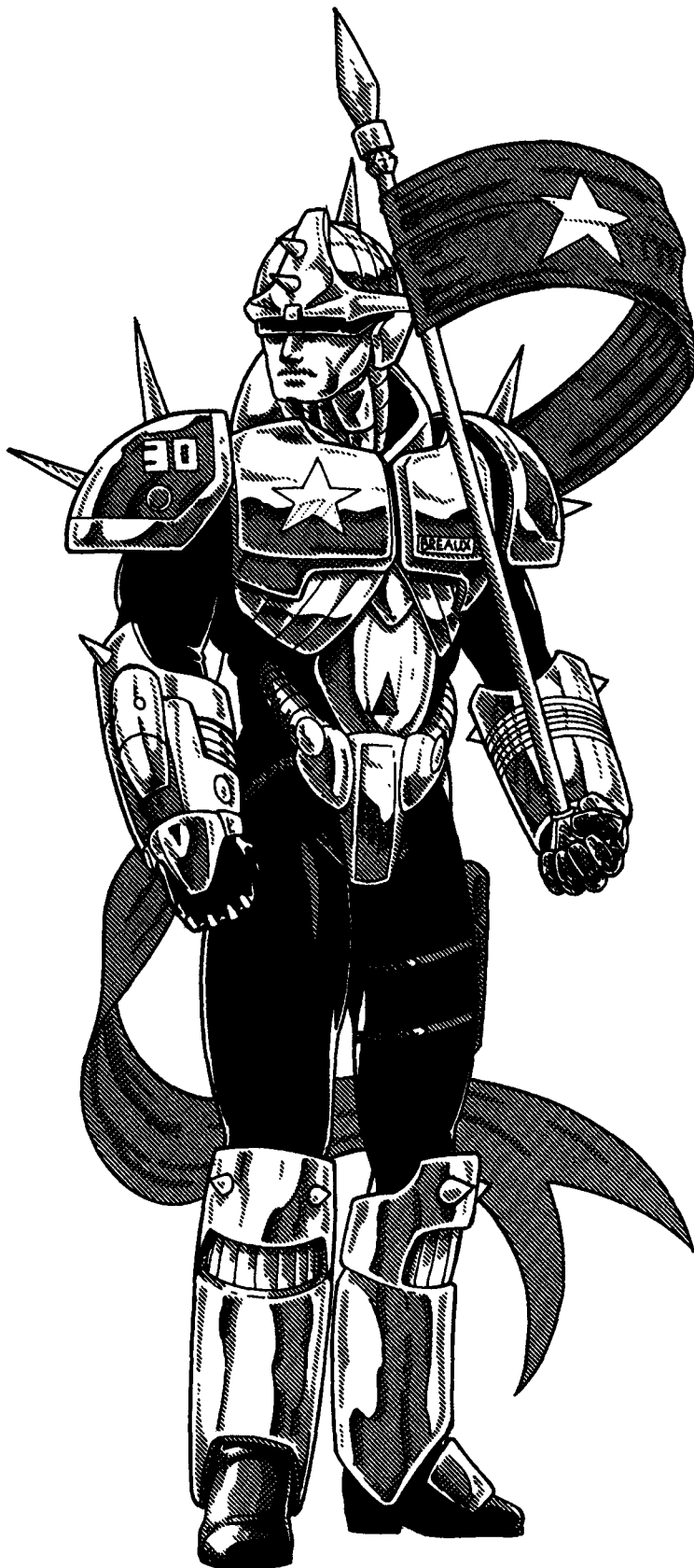

Alignment: Any, although good, unprincipled and aberrant are ideal.

Racial Restrictions: Exclusively human.

Attribute Requirements: I.Q. 7, P.S. 10, P.E. 10 or higher. A high I.Q. and physical attributes are helpful, but not a requirement.

O.C.C. Bonuses:

+2 on initiative.
 +1 to pull punch.
 +1 to strike, parry and dodge.
 +1 to roll with punch, fall or impact.
 +2 to save vs Horror Factor at levels 1, 3, 6, 9 and 12.
 +3D6+12 to S.D.C.

O.C.C. Skills:

Native Language: Russian at 98%
 Literacy: Russian at 62% (+2% per level of experience)
 Language: One additional of Choice (+15%)
 Basic Math (+5%)
 Radio: Basic (+15%)
 Pilot Hovercycle (+10%)
 Pilot Jet Pack (+12%)
 Pilot Tracked Vehicles & APCs (+10%)
 Pilot: One of choice (+10%; any except power armor and robots)
 Military Etiquette (+15%)
 General Athletics
 Running
 Climbing (+10%)
 Swimming (+10%)
 Wilderness Survival (+10%)
 W.P. Knife or Sword (includes use of Vibro-Blades)
 W.P. Energy Rifle
 W.P. Trick Shooting (choice of only one)
 W.P. One of Choice (any)
 Hand to Hand: Expert, but can be changed to Martial Arts (or Assassin if anarchist or evil) for the cost of one O.C.C. Related skill.

O.C.C. Related Skills: Select three MOS skills (with a +15% bonus each) from *any* of the skill categories regardless of whether or not it is normally available. Also pick three other skills of choice from the list below. One additional skill is selected at levels 4, 7, 10 and 13. All new skills start at level one proficiency.

Communications: Any (+10%)
 Domestic: Any
 Electrical: None
 Espionage: Sniper only.
 Mechanical: Basic and Automotive Mechanics only.
 Medical: First Aid only (+5%)
 Military: Any (+10%)
 Physical: Any, except Acrobatics.
 Pilot: Any (+5%)
 Pilot Related: Any (+5%), except Power Armor and Robot vehicles.
 Rogue: Streetwise and Palming only.
 Science: None
 Technical: Any (+10%)
 W.P.: Any, except an additional Trick Shooting skill.
 Wilderness: Any (+5%)

Secondary Skills: The character also gets to select two secondary skills from the list, excluding those marked "None," at levels 2, 4, 8 and 12. These are additional areas of knowledge that do not get the advantage of the bonus listed in parentheses. All secondary skills start at the base skill level.

Standard Soviet Soldier Issue: Standard Red Star body armor or cyborg body armor, energy pistol and energy rifle of choice (usually heavy types, and can include Triax weapons), six extra E-clips, one Vibro-Knife or Sword, silver plated survival knife (2D4 S.D.C.), 1D4 fragmentation hand grenades, two smoke grenades, two signal flares, a pocket-sized silver cross, signal mirror, utility belt, backpack, bedroll, language translator, flashlight, and uniforms.

If the soldier is a Light Machine or other type of 'Borg, he also gets the appropriate ammunition, equipment and body armor for the cyborg's body styling and weapon systems, plus regular maintenance and repairs. Also see Typical Bionics.

Vehicle: None to start. Vehicles may be issued upon assignment and officers usually get a jeep, hovercar or hovercycle.

Equipment Available Upon Assignment: Additional equipment, weapons, explosives, heavy armor, jet pack or other military vehicles, plus access to military bases (low security clearance), military doctors, hospitals, and other facilities. **Note:** Availability of equipment and resources may be de-

pendent upon the local commander, supply stock, location and combat conditions.

Cybernetics: Typical Bionics: 20% of the Sovietski soldiers are 55% conversion package partial cyborgs, 15% are 70-80% conversion package partial 'Borg, and 15% are full conversion Light or Heavy Machines. Approximately 50% are completely human with 1D4 implants and/or one bionic limb. **Note:** See the section on *Cyborgs O.C.C.s* for details on standard stats common to most Light and Heavy Machines.

Common Military features include:

1. Full 20/20 Enhanced Color Vision (To line-of-sight).
2. Targeting Sight (+1 to strike) and light filters.
3. Telescopic Eye with Passive Nightvision (5000 ft/1524 m).
4. Universal headjack/ear implant with Augmentation
5. Amplified Audio
6. Built-in Radio Transmitter & Receiver (5 miles/8 km)
7. Cyberlink Vehicle Interface (2; one in hand and head).
8. Gromeko Friend or Foe Identification Computer.
9. Bionic Lung with gas filter & oxygen storage cell.



10. Bionic Speed Running: 120 mph (192 km).
11. Leaping: 12 feet (3.6 m) high or 18 feet (5.4 m) lengthwise; increase by 50% with a running start.
12. 70% have an attractive, human face.

Common Military Cyborg Combat/Police Systems: Typically has the first three items and 1D4+1 "optional" systems of choice. Other bionics may be available as well, depending on the situation, character and G.M.; tends to avoid items that are disfiguring, especially to the face.

One forearm weapon on each arm (typically laser or ion).
Two hand weapons of choice or a concealed **Vibro-Blade**.

Helmet and Face Plate

Optional: Climb Cord and Grapple (wrist)

Optional: Palm Laser Torch

Optional: Laser Finger (1D4 M.D.; 300 ft/91m range).

Optional: Tool Hand

Optional: Built-in Loudspeaker

Optional: **Cyber-Shield**

Optional: Shoulder Weapon Mounts

Optional: Cyborg Jet Pack

Typical Soviet Officer

Fundamentally the same as above, except select four M.O.S. skills (+15% each), five other skills (instead of three), and Hand to Hand Combat is Martial Arts (or Assassin if anarchist or evil).

Sovietski Military Cyborgs

One of the big differences between the use of cyborgs by the Warlords and the Sovietski is that the majority of Soviet 'Borgs look very human. Most are human-sized and have human **faces/heads** and features. Even their Heavy Machines are human in appearance. Only the monstrous *Thunderstorm Artillery Cyborg*, *Thunderhammer*, and to a lesser degree, *Thunderstrike* cyborgs compare to the inhuman Cyborg **Shocktroopers** of the Warlords (and even they retain a humanoid shape, with human faces concealed behind their combat face plates).

Favored Hand-Held Weapons: The preferred **sidearms** among the Sovietski Military and Police Force are the heavy *G-21P laser pistol* (see page 185) and dual purpose *S20-20 pistol* (described elsewhere in this War Machine section). The *S-500 Cyclone* and *S-1000 Thunderhead* heavy assault rifles are preferred above all others among Light and Heavy Cyborgs, as well as by the Thunderstrike and Thunderhammer Cyborg Shocktroopers (described elsewhere in this section). However, virtually any of the weapons described in this book, *Triax & the NGR™*, *Mindwerks™*, *American imports* and weapons from other neighboring territories can be used — typically heavy and long-range weapons. Magic items are viewed with some suspicion by the Sovietski Military, but officers, soldiers and 'Borgs with distinguished records can usually get them approved for field use. Magic items are a rarity among the Police Force.

Vibro-Blades and Energy Hammers are also popular.

Light Machine Cyborgs

See Sovietski Soldier above and the Light Machine Cyborg O.C.C. section (see page 107) for details.

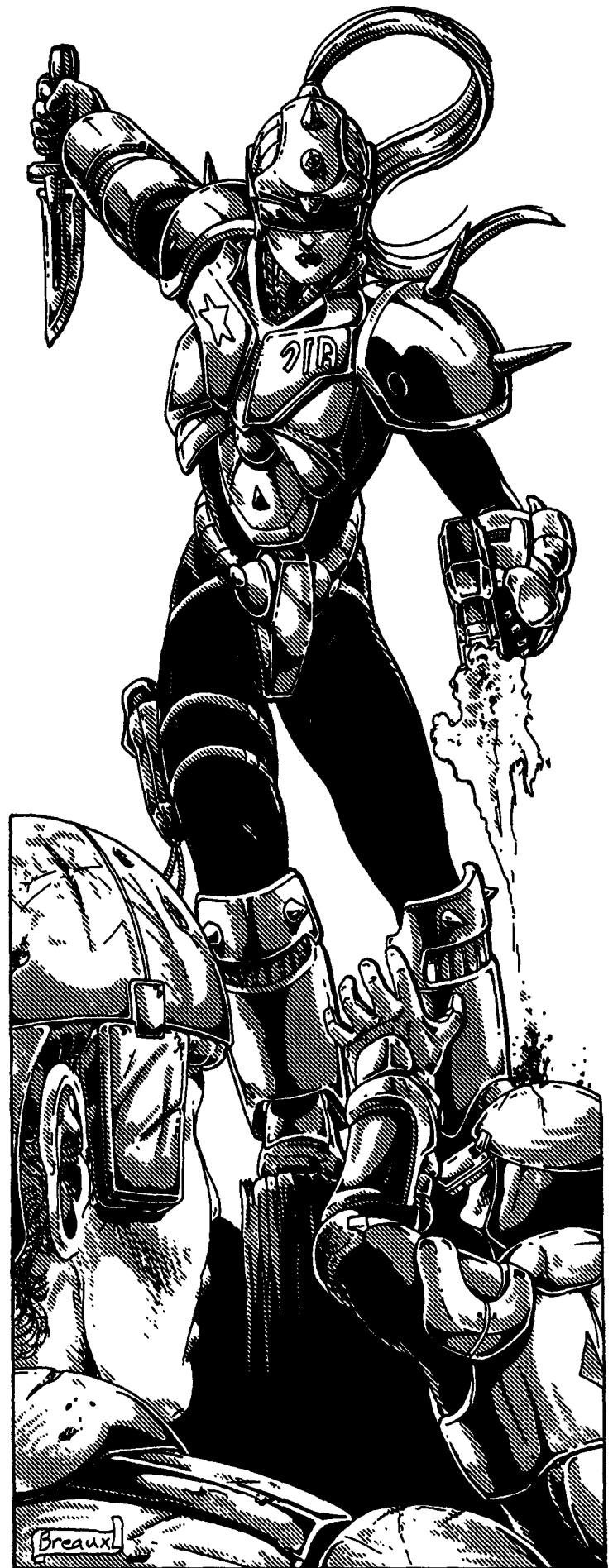

Human shape and size: 6 to 6 feet, 10 inches (1.8 to 2.08 m). Human facial features. Can wear conventional clothing and body armor, or light or medium cyborg body armor.

Standard Weapon Systems & Special Features of Full Conversion Light Machines:

1. Concealed Vibro-Blades (2): Each forearm has a retractable Vibro-Short Sword that can be extended at will and locked into place.

Primary Purpose: Anti-Personnel

Damage: 2D4 M.D. each.

Attacks Per Melee Round: Melee weapons; each strike counts as one attack.

Payload: Unlimited; draws on the 'Borg's power supply.

2. Ion Palm/Wrist Blaster (1 or 2): This item can be built into one or both hands/wrists. It too retracts when not in use and extends to fire. When only one unit is used in one hand, the other hand typically has a different weapon system, often a chemical spray, garrote wrist wire, or wrist needle and drug dispenser. The ion blaster is designed for close combat, assault and defense.

Primary Purpose: Assault

Mega-Damage: 3D6 M.D. per blast.

Range: 500 feet (152 m).

Rate of Fire: Each blast counts as one melee attack. If the cyborg points both arms at the same target and fires both blasters simultaneously, the damage is doubled (6D6 M.D.) and it counts as one melee attack. However, this can only be done when the cyborg is standing still and the target is at least two times human-size. Running and trying to shoot is the equivalent of shooting wild and -6 to strike, and all other combat bonuses are reduced by half.

Payload: Effectively unlimited; runs on internal power supply.

3. Forearm Weapons: Each arm will have one forearm weapon in addition to (sometimes in place of) the Vibro-Blade.

4. Optional Additional Hand Features or Weapons: Two weapons of choice per hand. The G.M. may modify or restrict certain items.

5. Optional Additional Leg Features or Weapons: Each leg has one.

6. Optional Weapon Appendage. Typically a large or multi-weapon system used in place of a hand and forearm (any).

7. Cyborg Jet Pack or Cyber-Jet Nodes are both frequent options incorporated into the Light Machines of the Soviet Army.

Sovietski Heavy Machine

All military Heavy Machines in the Sovietski look identical. All are human in shape and appearance, complete with a natural or synthetic version of their natural face. However, they stand 8-9 feet (2.4 to 2.7 m) tall and are much bulkier and broad-shouldered. During light combat and at base camp, the 'Borg may wear a light helmet without a face plate, or no helmet at all (and sometimes no additional armor). For infantry combat and most heavy assault missions, heavy cyborg armor (providing 250 M.D.C.) complete with a protective, high-tech face plate (provides an extra 80 M.D.C. to the head and face) is worn. The cyborg and armor are designed for speed and freedom of movement. The toes and feet are designed for traction and climbing.

See the Sovietski Soldier above for skills and training, and the Heavy Machine Cyborg O.C.C. section for additional details about this type of cyborg. However, the Sovietski Military Heavy Machine has some very specific features and characteristics as described here.

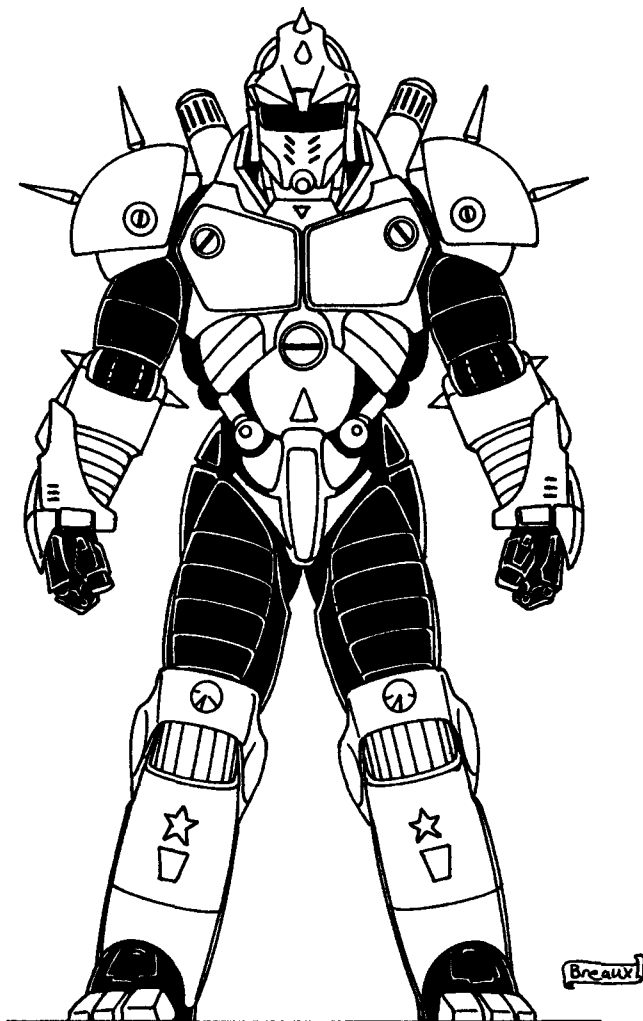

Sovietski Heavy Cyborg Soldier

Average Size: 8-9 feet (2.4 to 2.7 m) tall.

Weight: 800-900 pounds (360 to 405 kg).

Power Source: Nuclear

M.D.C. by Location:

* Forearm Weapons (2; one each arm) — 25 each

* Arms (2) — 100 each

* Hands (2) — 24 each

* Retractable Vibro-Knife (2; hands) — 50 each

Cyberjet Node (1; backjet system) — 80

Legs (2) — 135 each

* Feet (2) — 45 each

** Head — 80; it may be flesh outside, but underneath is a metal skull, plus it is usually protected with additional M.D.C. from a helmet and visor or helmet and face plate from bionic body armor that provides an additional 80 M.D.C.

*** Main Body — 240, plus M.D.C. from light (125 M.D.C.), medium (160 M.D.C.), or heavy (250 M.D.C.) Sovietski cyborg body armor. Heavy Machines cannot wear human-sized armor.

Full conversion Sovietski Heavy Machine in heavy cyborg body armor. A Cyborg Jet Pack is mounted on his back and he is armed with the S-1000 "Thunderhead" assault rifle.

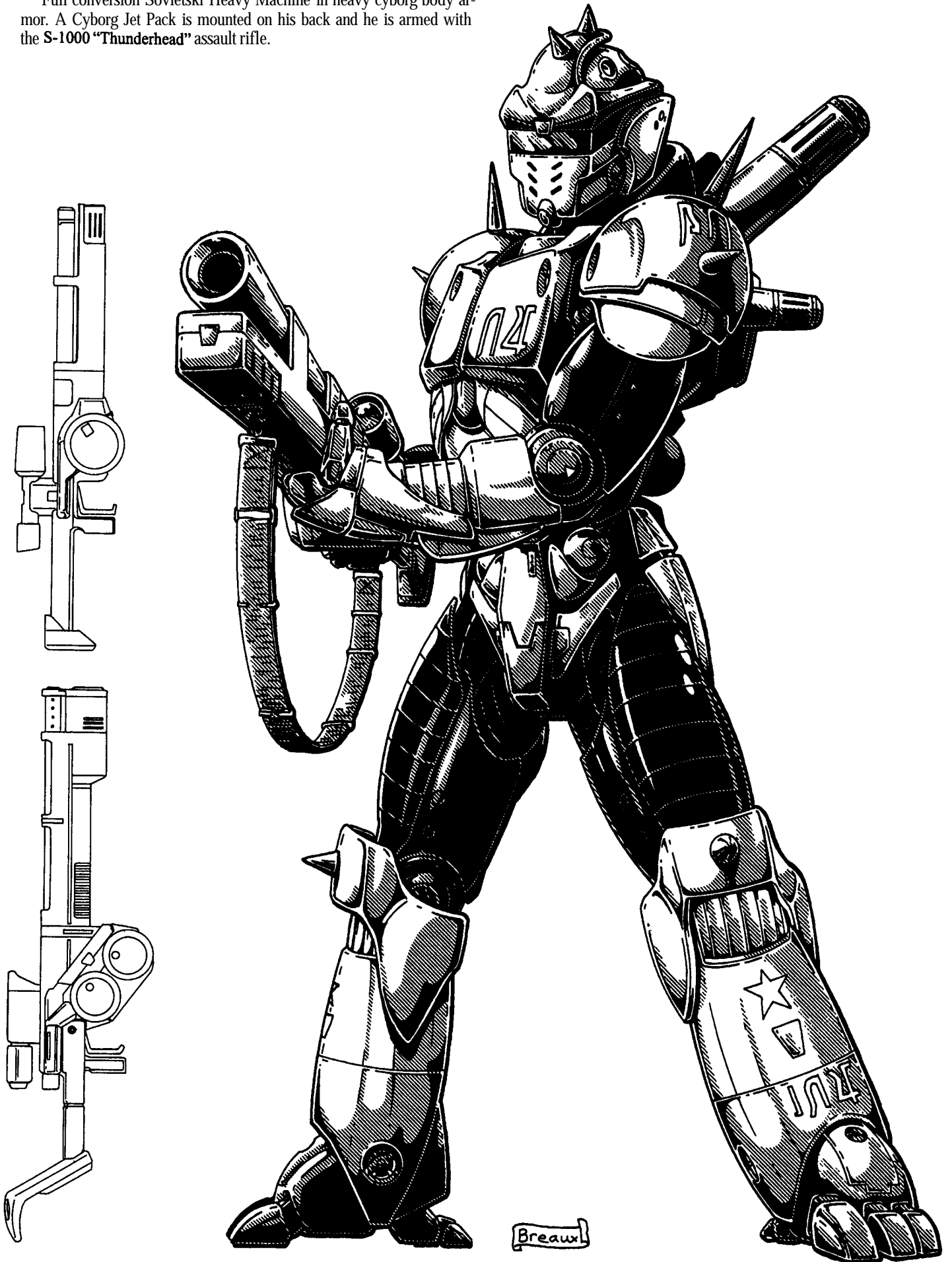

Sovietski Cyborg Armor Penalties: -5% to **prowl**, acrobatics, gymnastics, swim, climb, palming, and similar skills when using light armor, -10% for medium armor, and **-15%** for heavy armor.

Damage Notes:

* A single asterisk indicates a small **and/or** difficult target to hit. The attacker must make a "Called Shot" and even then he is -3 to strike.

** Destroying the head of a cyborg will kill the character! This is where the brain is housed and when it's gone, that character is dead. However, the rest of the body can be salvaged and reused.

*** Depleting the M.D.C. of the main body will effectively destroy the artificial body, but emergency systems will keep the brain and vital organs alive for **18** hours. Recovery of the damaged body will enable Cyber-Docs to place the character on a life support system that **will** keep him alive until a new bionic frame becomes available. Failure to find the brain within 18 hours means the character dies. Massive amounts of damage (100 or more M.D.C. below zero) completely destroys the 'Borg, with no hope of recovery.

Bionic Attributes:

- Tactile sensitivity: 45%
- Robotic P.S.: 32 and does M.D. damage from punches and kicks: 2D4 from a punch, 3D6 M.D. From a power punch and leap kick, 2D6 M.D. from normal kicks, and 1D4 M.D. from head butts.
- Bionic P.P.: 22
- Bionic Speed Running: 100 mph (160 km).
- Leaping: Super powerful hydraulic leg pistons are capable of launching full conversion Heavy Machines 15 feet (4.6 m) high or 25 feet (7.6 m) lengthwise without having to activate **Cyberjet** Nodes; increase by 50% with a running start.

Speed & Flight Options: 1. 40% have *Cyberjet Nodes*. Mounted in the back and legs are small directional jets. These are typically used for jet assisted leaps and limited hovering. Travelling by jet boosted leaps doubles the cyborg's normal running speed. Jet assisted leaps can propel *heavy cyborgs* 100 feet high (30.5 m) or 200 feet (61 m) lengthwise; increase by 30% with a running start. Increase the distance of all leaps by 50% for Light Machines. The jet propelled '**Borg** can also hover in the air, up to 100 feet (30.5 m), for **1D4** minutes before altitude is lost and the character is quickly but gently lowered to the ground.

2. 30% have a modular, detachable *Cyborg Jet Pack*. Maximum speed is 250 mph/400 km) with a cruising speed of around 70-100 mph (112.6 to 160 km). Maximum altitude is 2000 feet (610 m). Power Source is either an E-Pack (48 hours of life) or a cable that links to the cyborg and draws on his power supply (only the minor penalties apply (see page 100); indefinite life). Needs to cool down after three hours of continuous use or has a 01-50% chance of overheating and shutting down; roll for every 30 minutes beyond three hours. Needs 40 minutes to cool. The heavy '**Borg**jet pack has 140 M.D.C.

Bonuses for Sovietski Heavy Machines: In addition to bonuses from bionic attributes, skills and Military O.C.C. training.

+2 on initiative.

+3 to pull punch. +1 attack per melee round.

+1 to strike and parry. +2 to save vs Horror Factor.

W.P. Paired Weapons skill (**Vibro-Blades**)

Standard Cybernetic Systems (non-weapon types):

1. Full 20/20 Enhanced Color Vision (To **line-of-sight**)
2. Multi-Optic Eye
3. Multi-System Eye Socket
4. Universal **headjack/ear** implant with Augmentation
5. Amplified Audio
6. Built-in Language Translator
7. Built-in Radio Transmitter & Receiver (5 miles/8 km)
8. Cyberlink Vehicle Interface (2; one in hand and head).
9. Gromeko Friend or Foe Identification Computer.
10. Bionic Lung with gas filter & oxygen storage cell.
11. Clock Calendar
12. **Gyro-Compass**

Standard Weapon Systems & Special Features of Full Conversion Heavy Machines:

1. **Concealed Vibro-Blades (2):** The small shielding that extends over the wrist and part of the hand contains a retractable **Vibro-Blade** that can be extended at will and locked into place.

Primary Purpose: Anti-Personnel

Damage: 2D4 M.D. each.

Attacks Per Melee Round: Melee weapons; each strike counts as one attack.

Payload: Unlimited; draws on the 'Borg's power supply.

2. **Ion Palm/Wrist Blaster (1 or 2):** This item can be built into one or both hands/wrists. It too retracts when not in use and extends to fire. When only one unit is used in one hand, the other hand typically has a different weapon systems, often a chemical spray, **garrote** wrist wire, or wrist needle and drug dispenser. The ion blaster is designed for close combat, assault and defense.

Primary Purpose: Assault

Mega-Damage: 3D6 M.D. per blast.

Range: 500 feet (152 m).

Rate of Fire: Each blast counts as one melee attack. If the cyborg points both arms at the same target and fires both blasters simultaneously, the damage is doubled (6D6 M.D.) and it counts as one melee attack. However, this can only be done when the cyborg is standing still and the target is at least two times human-size. Running and trying to shoot is the equivalent of shooting wild and -6 to strike, and all other combat bonuses are reduced by half.

Payload: Effectively unlimited; runs on internal power supply.

3. **Forearm Weapons:** Each arm will have one forearm weapon in addition to the Vibro-Blade. Laser and ion blasters are typical. Only 10-15% use *Hydraulic* or *Mekanikal Arms* (see pages 104-105).

4. **Optional Additional Hand Features or Weapons:** Two weapons of choice, per hand.

5. **Optional Additional Leg Features or Weapons:** Each leg has two features, typically a concealed compartment and a laserrod.

6. **All Sovietski Heavy Machines also carry hand weapons:** The S-1000 or S-500 or rail guns are the most common, but other weapons can be used; heavy ones are usually preferred. Most also have one **sidearm**, typically an S20-20 pistol, but Triax pistols, the Energy Hammer and **Vibro-Sickle** are also popular.

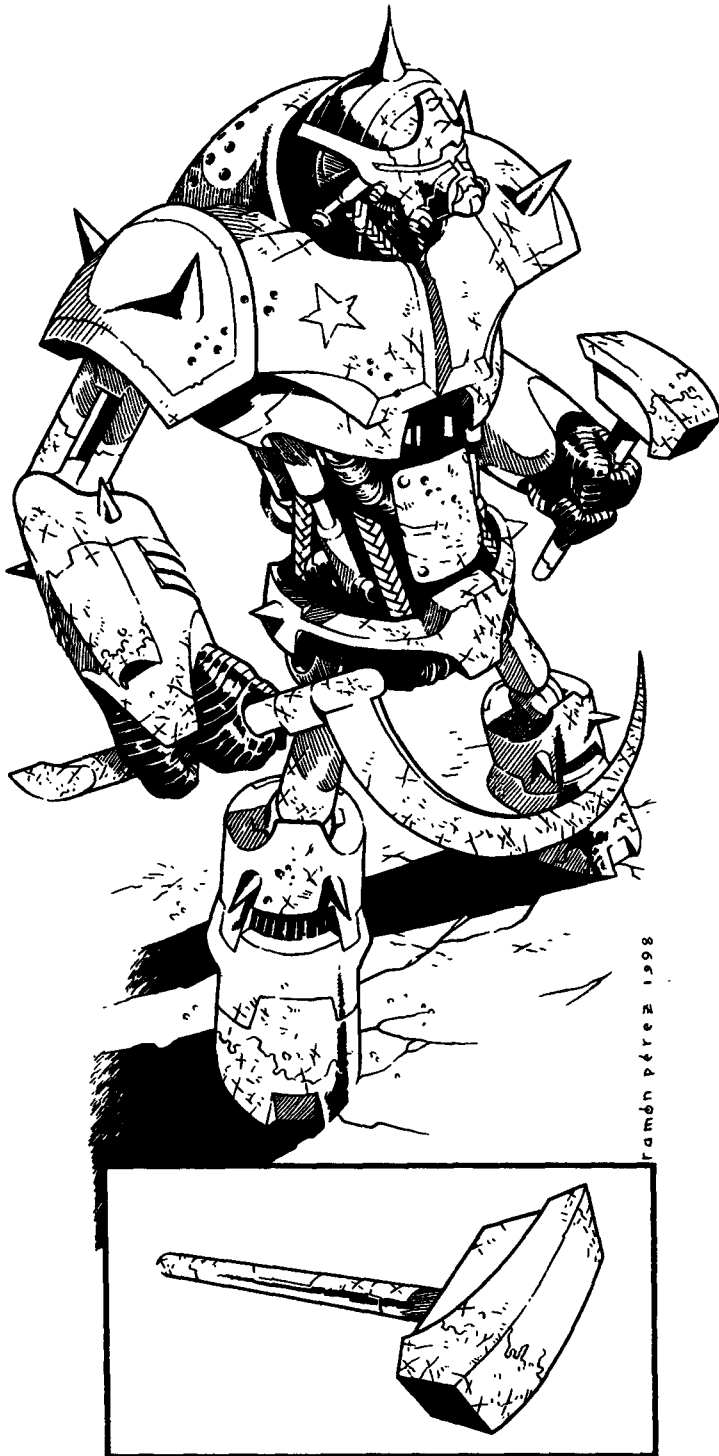

Thunderhammer Shocktrooper

This is the most famous and numerous of the **Sovietski** Cyborg Shocktroopers (depicted on the cover and on these pages). It is built for heavy, frontline combat, but retains reasonable speed and is capable of a variety of combat functions. The Thunderhammer is human in general shape, with special heavy armor, barrel chest, back missiles, thick forearms with weapon mountings and concealed features, thick lower legs and its trademark Energy Hammer and Vibro-Sickle. Under the tech-face plate is usually (90%) a synthetic human face, typically based on the soldier's original birth features.

There are a number of subtle and not so subtle design variations within this line of combat 'Borgs, usually in regard to the hands and arms, although there are some face plate variations which designate specific troop divisions. The Vibro-Sickle and Energy Hammer are the standard issue sidearms, but not all Thunderhammer 'Borgs will carry them into combat. This cyborg is strictly a ground unit. Its back-mounted mini-missile launch system prevents the use of Cyberjet Nodes or a backpack, although the 'Borg can pilot suitably large hovercycles and other vehicles.

The vast majority of the Sovietski's military machines, including the Thunderhammer and Light and Heavy Machines, are **pre-Cataclysm** designs of the old Soviet Union. As such, they are state-of-the-art machines equal to most anything the Warlords, Triax or the Coalition States have to offer. The Sovietski has seen little need to improve upon perfectly good war machines and is actually quite slow to make changes and take new directions. The *Thunderstrike* and *Thunderstorm* cyborgs are examples of recent innovations, and are generally unimpressive.

Thunderhammer Cyborg Shocktrooper

Class: Superheavy, Full Conversion Cyborg.

Colors: Steel blue-grey with black highlights and red star emblem.

M.D.C. by Location:

Back Mini-Missile Launcher (1) — 120

* Heavy Laser (1; right forearm) — 35

* Concealed Extra Appendage or Laser Rod (right arm) — 50

* Plasma Ejector (1; left forearm) — 35

* Concealed Palm Laser (1; left hand) — 10

* Large Vibro-Sickle (1; hand-held) — 80

* Large Energy Hammer (1; hand-held) — 90

Heavy Shoulder Plates (2) — 110 each

* Hands (2) — 35 each (3-fingered) or 50 each (2-fingered)

Arms (2) — 150 each

Legs (2) — 170 each

Feet (2) — 100 each

** Head with Mechanical Face Plate — 160

*** Main Body — 320, plus 200 M.D.C. (medium) or 300 (heavy) from additional cyborg body armor specifically designed for the Thunderhammer.

Damage Notes: The usual fare, see the Heavy Machine described previously.

Speed:

Running: 90 mph (144 km) maximum.

Leaping: 12 feet (3.6 m) high and 20 feet (6 m) across; increase by 50% with a running start.

Flying: Not possible.

Statistical Data:

Average Height: 12 feet (3.6 m)

Width: Five feet, four inches (1.6 m) at the shoulders.

Length: Five feet (1.5 m).

Weight: 2.6 tons

Tactile sensitivity: 45%

Robotic P.S.: 38

Bionic P.P.: 22

Face: Tech/machine-looking face plate; human underneath.

Horror Factor: 10

Bonuses: In addition to attribute and skill bonuses.

+2 on initiative.

+1 to strike.

+3 to parry

+3 to pull punch.

+1 to roll with punch, fall or impact.

+4 to save vs Horror Factor

Power System: Nuclear; average life is 20 years.

Black Market Cost: N/A. The process is secret and never shared with outsiders, much less offered for sale!

Sovietski Cost: 3 million credits; the equivalent elsewhere would cost 6-7 million.

Thunderhammer Weapon Systems:

1. Mini-Missile Launch System: Built into the back of the Thunderhammer is a mini-missile launcher.

Primary Purpose: Anti-Aircraft and Anti-Flying Monsters.

Missile Type: Any mini-missile can be used, but standard issue is armor piercing (1D4x10 M.D.) or plasma (1D6x10). Fragmentation may be used against ground troops.

Mega-Damage: Varies with missile type.

Range: About a mile (1.6 km).

Rate of Fire: One at a time or volleys of two or four.

Payload: 32 total.

2. High-Powered Laser (right arm): A deadly forearm weapon. Point and shoot.

Primary Purpose: Anti-Personnel and Defense.

Mega-Damage: 3D6 M.D. per single blast.

Rate of Fire: Each blast counts as one melee attack.

Range: 3,000 ft (914 m).

Payload: Effectively unlimited.

3. Concealed Extra Appendage or Laser Rod (right arm):

The right arm typically contains a concealed mechanical arm and hand (usually a Tool Hand) that folds into the armored forearm casing. This limb can be used as an extra arm to effect repairs, pick up and carry items, fire an extra weapon, etc. It does *not* provide an extra attack.

Robot P.S.: 18

4. W-42 Concealed Palm Laser: A somewhat larger, heavier version of the short-ranged W-42 laser. It is built into the base of the palm and wrist of the left hand and offers better range. The device can be used as both a weapon and a cutting tool.

Primary Purpose: Tactical Weapon and Tool/Self-Defense.

Mega-Damage: Has four settings: 2D4x10 S.D.C., 1D4 M.D., 1D6 M.D., or 2D6 M.D. per single blast.

Range: 400 feet (122 m)

Rate of Fire: Each blast counts as one melee attack.

Payload: Effectively unlimited.

5. Plasma Ejector: The left forearm weapon is a plasma ejector designed to inflict severe damage at close range. Its mechanics and energy needs are such that the large forearm cannot have a second weapon or extra appendage, although there is a palm weapon (see number 4).

Primary Purpose: Anti-Personnel and Defense.

Mega-Damage: 6D6 M.D. per single blast!

Rate of Fire: Each blast counts as one melee attack.

Range: 1,000 ft (305 m).

Payload: Effectively unlimited.

6. Optional: Vibro-Blade Knuckle Claws: When the three-fingered hand is used (as shown on the cover), extendable knuckle blades can be used on one or both hands to inflict additional punch damage and for raking opponents; silver plated.

Mega-Damage: 3D4 M.D. per raking claw strike, or add +3D4 M.D. to punch damage when they are used in a punching strike.

Range: Hand to Hand combat; the reach of the arm, which is about 8 feet (2.4 m).

7. Vibro-Sickle: A large, curved Vibro-Blade that is used as a hand-held weapon and ideal for slashing and chopping attacks as well as parrying.

Weight: 70 pound (32 kg).

Mega-Damage: 3D6+2 M.D.; giant-sized.

Range: Hand to Hand combat; about 11 feet (3.3 m; 3 feet/0.9m longer than the arm).

8. Large Energy Hammer: A large hand-held weapon that can be used as both a blunt M.D. weapon and energy blaster.

Weight: 80 pound (36 kg).

Primary Purpose: Hand to hand combat.

Mega-Damage: 2D6 M.D. per physical strike or 2D6 M.D. per single blast. 5D6 S.D.C./H.P. damage when the hammer is without energy.

Rate of Fire: Each blast counts as one melee attack.

Range: 500 ft (152 m).

Payload: 30 energized strikes or blasts per E-Clip (concealed in the back of the hammer's head). Effectively unlimited if cabled to the cyborg.

9. Robot P.S. and Punch Damage:

Restrained Punch — 1D4 M.D.

Full Strength Punch or Kick — 2D6 M.D.

Power Punch or Leap Kick — 4D6 M.D.; but counts as two attacks.

10. All Sovietski Cyborgs may also carry hand weapons: The S-1000, S-500A, rail guns or other heavy weapons are typically issued to the Thunderhammer cyborg.

Thunderstrike Shocktrooper

The Thunderstrike is one of the Sovietski's new, original cyborg designs (the previous ones are **pre-Rifts** designs used by the old Soviet Empire). Only a few hundred are currently in use and undergoing field testing. The idea behind them was to create a truly supercyborg with an incredible amount of armor to withstand heavy enemy bombardment. Unfortunately, the end

result has been less than spectacular. The heavy armor has made the cyborg slow and ponderous, not a bad feature in a stand-up **battle**, or blazing gun siege, but not very effective in combat situations that require stealth or a range of mobility or combat capabilities.

The head has an insect look to it mainly because of the Panoramic Cluster Lens eyes. The Cyborg Jet Pack is standard equipment to provide greater speed and mobility, but even the jet pack is reduced by 30% from the bulk and size of this 'Borg. Its main weapons are a pair of rail guns mounted on each forearm with an ammo drum on the back, under the jet pack.

Thunderstrike Cyborg Shocktrooper

Class: Superheavy, Full Conversion Cyborg.

Colors: Greenish-grey with black and light blue highlights and a red star emblem.

M.D.C. by Location:

* Rail Guns (2; forearms) — 35 each

* Concealed Palm Lasers (2; both hands) — 10 each

* Large Vibro-Sickle (1; hand-held) — 80

* Large Energy Hammer (1; hand-held) — 90

Cyborg Jet Pack (1; back) — 140

* Hands (2) — 35 each (3-fingered) or 50 each (2-fingered)

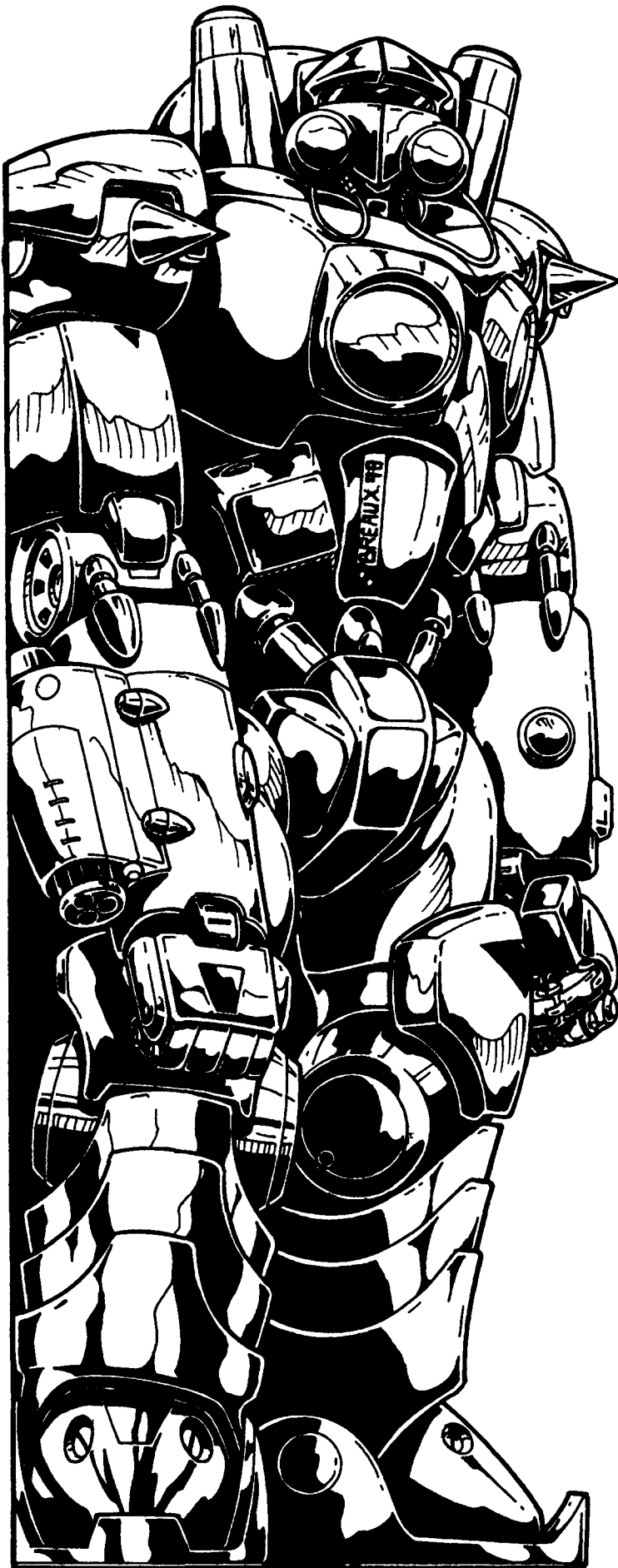

Arms (2) — 190 each

Legs (2) — 250 each

Feet (2) — 150 each

** Head with Mechanical Face Plate — 180

*** Main Body — 320, plus 360 M.D.C. from heavy cyborg body armor specifically designed for the Thunderstrike.

Damage Notes: The usual fare, see the Heavy Machine described previously.

Armor Penalties: -30% to prowl, **acrobatics**, gymnastics, swim, climb, palming, and similar skills when wearing the heavy armor; -5% without it.

Speed:

Running: 70 mph (122.6 km) maximum.

Leaping: 10 feet (3 m) high and 15 feet (4.6 m) across; increase by 25% with a running start.

Flying: The standard jet pack enables the Thunderstrike to fly at a maximum speed of 175 mph/280 km, with a cruising speed of around 70-100 mph (112.6 to 160 km). Maximum altitude is 1200 feet (366 m). Power Source is a cable that links to the cyborg and draws on his power supply (only the minor penalties apply; indefinite life). Needs to cool down after three hours of continuous use or has a 01-50% chance of overheating and shutting down; roll for every 30 minutes beyond three hours. Needs 40 minutes to cool. The heavy 'Borg jet pack has 140 M.D.C.

Statistical Data:

Average Height: 13 feet (3.9 m)

Width: Five feet, four inches (1.6 m) at the shoulders.

Length: Five feet (1.5 m) with jet pack (4 ft/1.2 m without).

Weight: 3.8 tons

Tactile sensitivity: 45%.

Robotic P.S.: 42

Bionic P.P.: 20

Face: Tech/machine-looking face plate; human underneath.

Horror Factor: 11

Bonuses: In addition to attribute and skill bonuses.

+1 on initiative.

+1 to strike.

+2 to pull punch.

+2 to roll with punch, fall or impact.

+3 to save vs Horror Factor

Power System: Nuclear; average life is 20 years.

Black Market Cost: N/A. The process is secret and never shared with outsiders, much less offered for sale!

Sovietski Cost: 4 million credits; the equivalent elsewhere would cost 7-8 million.

Thunderstrike Weapon Systems:

1. Rail Guns (2): Built into each forearm of the Thunderstrike is a rapid-fire rail gun providing great range and heavy firepower. The large size and heavy armor of the cyborg allows for range and damage common to normal rail guns and not the mini-versions found on most 'Borgs.

Primary Purpose: Anti-Armor and Monsters.

Secondary Purpose: Anti-Aircraft and Anti-Personnel.

Mega-Damage: A burst is 16 rounds and inflicts 1D4x10 M.D.C.

Rate of Fire: Only fires 16 round bursts, and each counts as one melee attack.

Maximum Effective Range: 4,000 feet (1200 m)

Payload: A pair of 3200 round drums (200 bursts per arm) are standard issue, but a 160 round clip (10 bursts) and 400 round belt (25 bursts) are also available.

2. W-42 Concealed Palm Laser (2): Built into the base of each palm and wrist is a small laser. The device can be used as both a weapon and a cutting tool.

Primary Purpose: Tactical Weapon and **Tool/Self-Defense.**

Mega-Damage: Has four settings: 2D4x10 S.D.C., 1D4 M.D., 1D6 M.D., and 2D6 M.D. per single blast.

Range: 400 feet (122 m).

Rate of Fire: Each blast counts as one melee attack.

Payload: Effectively unlimited.

3. Vibro-Blade Knuckle Claws: Extendable knuckle blades are built into each hand to inflict additional punch damage and for raking opponents; silver plated.

Mega-Damage: 4D4 M.D. per raking claw strike, or add +4D4 M.D. to punch damage when they are used in a knuckle strike/punch.

Range: Hand to Hand combat; the reach of the arm, which is about 8 feet (2.4 m).

4. Vibro-Sickle or Energy Hammer: One or the other is typically selected as a **sidearm** (sometimes both or the Hammer and a giant Vibro-Sword that does 4D6 M.D.) — the Hammer is a bit more popular because of its diversity. See the **Thunderhammer** Cyborg for descriptions of these weapons.

5. Robot P.S. and Punch Damage:

Restrained Punch — 1D6 M.D.

Full Strength Punch or Kick — 3D6 M.D.

Power Punch or Leap Kick — 1D6x10 M.D.; but counts as two attacks.

Head Butt or Stomp — 1D6 M.D.

6. Other Hand-Held Weapons may be used. Additional hand-held weapons, from energy rifles and rail guns to clubs and magic weapons, may be used by the cyborg.

7. Additional Bionic Systems Common to the Thunderstrike:

- Cyborg Jet Pack is standard issue.
- 25% have one of the hydraulic hand features.
- Interchangeable left weapon arm.
- Panoramic Cluster Lens.
- Two additional Bionic Eye features of choice.
- Two hand weapons or features of choice.
- Optional **Cyber-Shield.**
- Optional Head and Neck Collar.

Thunderstorm Heavy Artillery Cyborg

This is a huge artillery cyborg that is hunched over with a pair of big twin cannons mounted on its back! This gives the cyborg a sort of big gorilla appearance with thick arms and legs, and a very **bulky**, hulking look

The cannon mounting can be used separate from the cyborg if necessary, but on the 'borg it is a mobile artillery unit. The cannon housing also has **five** mini-missile launch tubes on both sides of the cannon for additional support. To fire, the giant **'borg** must brace itself on all fours, resembling a robot football linesman ready to charge.

This is another of the **Sovietski's** newish and somewhat experimental designs. Approximately 1,200 have been created and were put into service five years ago. The hulking cyborg is believed to be the biggest ever created in Europe and Asia. It towers 15 feet tall (4.6 m) fully erect, but is usually bent in half

by the huge artillery unit carried on its back. Bent over by the big guns, the cyborg crouches at a height of about 8 feet (2.4 m) to the top of his head, and about 12 feet to the top of the cannon barrels. When the cannons are attached, the Thunderstorm cannot stand erect and must walk on all fours in a bent-over position with knuckles dragging on the ground (speed is also reduced by half). The entire body of the Thunderstorm is massive, adding to the illusion of the **'Borg** being even bigger than it is (most people insist the cyborg is 20 feet/6m tall bent over). The cyborg has a massive, short neck, broad **shoulders**, comparatively small head and one long slit for an eye. The arms are nearly as thick as the legs and lock into place for greater stability, as well as equipped with shock absorbers to cushion the jolt of the cannons. Each forearm has a pair of rail guns and concealed laser rods the size of leg units on a normal cyborg (3D6 M.D.). The twin canisters on the head flip open to reveal triple-barrelled lasers for ground assault and defense of its position from enemy ground troops.

The Thunderstorm is a walking mound of **armor**, giving it unimaginable protection for a cyborg, and greater than many giant robots its size. Unfortunately, the cannons and layers of heavy M.D. armor plating make the Thunderstorm the slowest of all Russian cyborgs and it suffers from movement and skill penalties.

The advantage of a giant, cyborg artillery unit is the mobility compared to armored vehicles. The cyborg can lumber along with ground troops, trudge through swamps and forests, amble across rugged terrain, climb hills and even negotiate mountain cliffs and trails provided they are not too steep. The Thunderstorm also functions well in urban settings. There is also the advantage of having one human mind controlling the cannon and other defenses, as opposed to the two-man artillery trucks; six men if a reload team is required. A three man team to help with targeting and reloading the cannons for the cyborg is required for the Thunderstorm to maintain a prolonged bombardment.

The cannons and mini-missile artillery unit are **detachable**, but the cyborg loses all of its long-range capabilities and becomes a slow moving target. The Thunderstorm Artillery cyborgs are used for civil defense where they may have the additional protection of an M.D.C. bunker or hole dug into the earth, as well as combat support units and border defenders where they can be protected by other **'Borgs**, armored vehicles and troops.

One concern of the Sovietski Military is the effect that being a giant, monstrous cyborg will have on the human mind. Unlike the other cyborgs, the Artillery **'Borg** is clearly inhuman, plus the size, weight and bulk makes it impossible for the human volunteer to function in any normal capacity. Even skills and games are difficult to impossible. This isolation and the 'Borg's crippling power may eventually lead to dangerous psychological instability and detachment. However, so far the cyborgs currently in the field have shown no such signs of mental or emotional deterioration. All Thunderstorm cyborgs know that they can request immediate (within 48 hours) reconstruction into a human-like Light or Heavy Machine. This knowledge alone may act as a safety-valve for the human essences inside the monster-'Borgs. Once transformed from the Thunderstorm to a smaller, conventional cyborg, there is no returning to be a Thunderstorm.

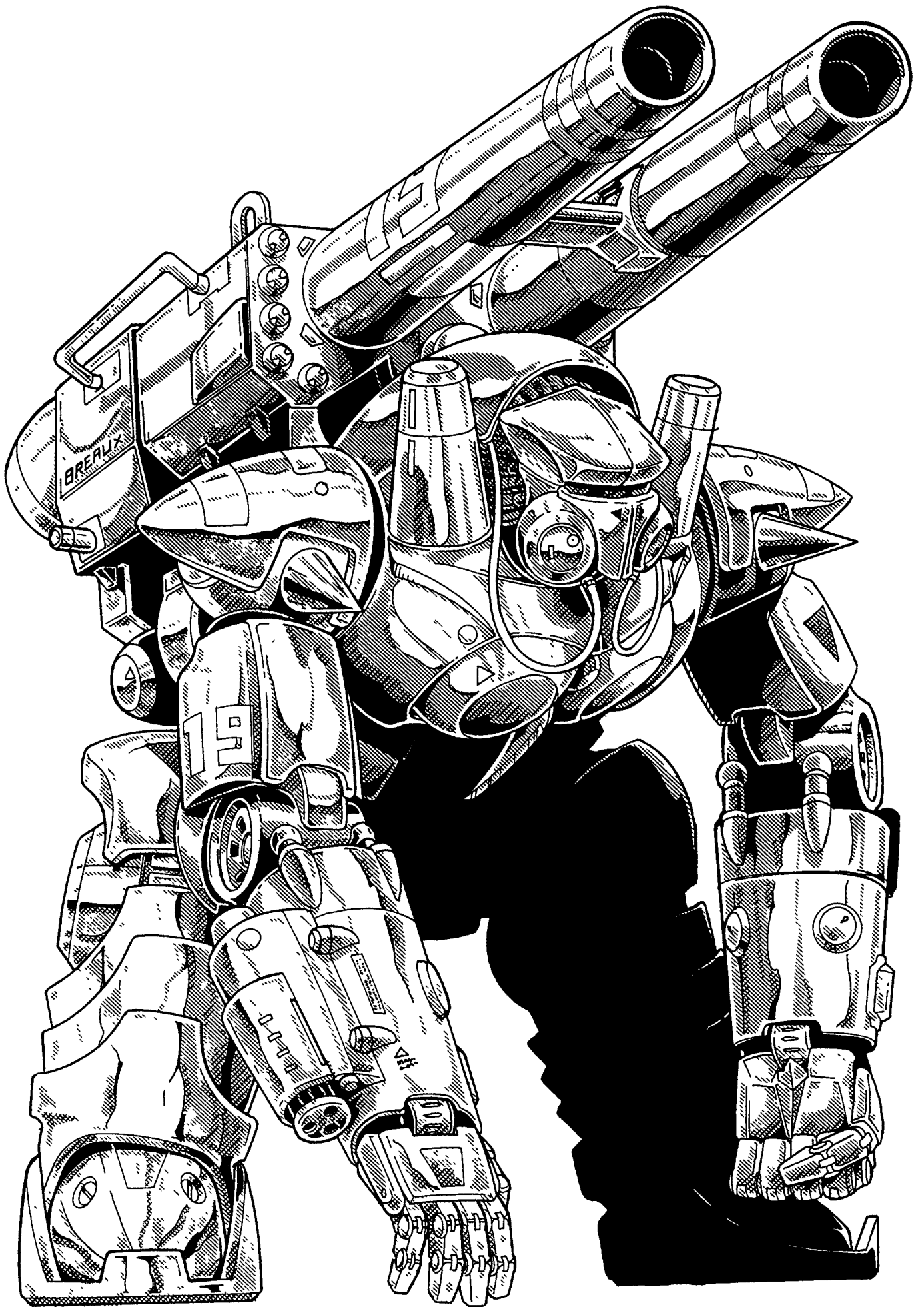

Thunderstorm Artillery Cyborg

Class: Superheavy, Full Conversion Cyborg.

Colors: Silvery grey with red markings and highlights.

M.D.C. by Location:

Cannon Barrels (2) — 180 each

Cannon & Missile Housing — 300

* Rail Guns (2; forearms) — 40 each

* Concealed Laser Rods (2; both arms) — 20 each

* Head Canister Lasers (2) — 60 each

* Large Energy Hammer (1; hand-held) — 90

Hands (2) — 75 each

Arms (2) — 240 each

Legs (2) — 350 each

Feet (2) — 150 each

** Head with Mechanical Face Plate — 200

*** Main Body — 1,240 M.D.C. with heavy armor plating.

Damage Notes: The usual fare, see the Heavy Machine described previously.

Armor Penalties: -20% on the performance of most skills (including swim, climb and palming) because of the cyborg's incredible size, bulk, weight and armor. It is impossible to prowl or perform acrobatics, gymnastics and similar skills.

Speed:

Running: 50 mph (80.4 km) maximum; 25 mph (40 km) when the cannon unit is attached.

Leaping: Impossible when the cannon unit is attached, 10 feet (3 m) high and 15 feet (4.6 m) across when it is not; increase by 25% with a running start.

Flying: Impossible.

Statistical Data:

Average Height: 15 feet (4.6 m) fully erect; 8 feet (2.4 m) when bent over by the cannon unit.

Width: Six feet, six inches (2 m) at the shoulders.

Length: Five feet (1.5 m) without the cannon unit, 10 feet (3 m) bent over with the cannon unit.

Weight: 18.5 tons without the cannon unit, 38 tons with it.

Tactile sensitivity: 35%.

Robotic P.S.: 45

Bionic P.P.: 18

Face: Tech/machine-looking even under the face plate.

Horror Factor: 13

Bonuses: In addition to attribute and skill bonuses.

+1 on initiative.

+1 to strike.

+2 to pull punch.

+3 to save vs Horror Factor

Power System: Nuclear; average life is 20 years.

Black Market Cost: N/A. The process is secret and never shared with outsiders, much less offered for sale!

Sovietski Cost: 5.5 million credits with cannon artillery unit; the equivalent elsewhere would cost 10-14 million.

Thunderstorm Weapon Systems:

1. Artillery Unit: A self-loading, double-barrelled Howitzer plus mini-missile launch system.

Primary Purpose: Tactical bombardment of the enemy.

Secondary Purpose: Anti-Armored Vehicles and Infantry Support.

Mega-Damage: Cannons: 2D4x10 M.D. per single round, 4D4x10 per double, simultaneous blast (two rounds). A simultaneous twin blast counts as one melee attack.

Mini-Missiles: Varies with missile type.

Range: Cannon: 8,300 feet (2530 m); about a mile and a half

Mini-Missiles: One mile (1.6 km).

Rate of Fire: Each single or double blast counts as one melee attack.

Payload: 20 cannon shells total, for 10 double blasts or 20 single ones. A three-man team with two wearing MM-61 Explorer Exoframes (see page 176) or two being Light or Heavy Machines, can reload four shells per melee round.

2. Rail Guns (2): Built into each forearm of the Thunderstorm is a rapid-fire rail gun providing great range and heavy firepower. The large size and heavy armor of the cyborg allows for range and damage common to normal rail guns and not the mini-versions found on most 'Borgs.

Primary Purpose: Anti-Armor and Monsters.

Secondary Purpose: Anti-Aircraft and Anti-Personnel.

Mega-Damage: A burst is 16 rounds and inflicts 1D4x10 M.D.C. per burst!

Rate of Fire: Only fires 16 round bursts, and each counts as one melee attack.

Maximum Effective Range: 4,000 feet (1200 m)

Payload: A 3200 round drum per each arm (200 bursts per arm) is standard issue, but a 160 round clip (10bursts) and 400 round belt (25 bursts) are also available.

3. Concealed Laser Rods (2): Built into each arm is a concealed laser rod; remove, point and fire. Used for precision shooting.

Primary Purpose: Anti-Personnel & Defense.

Mega-Damage: 3D6 M.D. per single blast.

Range: 2000 feet (610 m).

Rate of Fire: A single or double cluster blast counts as one melee attack.

Payload: Effectively unlimited.

4. Head Laser Clusters (2): Located on both sides of the face are two canisters that open to reveal three-barrelled lasers. They can be fired one cluster at a time or simultaneously.

Primary Purpose: Anti-Personnel & Defense.

Mega-Damage: 1D6x10 M.D. per single cluster bombardment or 2D6x10 per simultaneous attack from both clusters.

Range: 2000 feet (610 m).

Rate of Fire: Each blast counts as one melee attack.

Payload: Effectively unlimited.

5. Vibro-Blade Knuckle Claws: Extendable knuckle blades are built into each hand to inflict additional punch damage and for raking opponents; silver plated.

Mega-Damage: 4D6 M.D. per raking claw strike, or add +4D6 M.D. to punch damage when they are used in a knuckle strike/punch.

Range: Hand to Hand combat; the reach of the arm, which is about 9 feet (2.7 m) with blades extended.

6. Robot P.S. and Punch Damage:

Restrained Punch — 1D6 M.D.

Full Strength Punch or Kick — 3D6 M.D.

Power Punch or Leap Kick — 1D6x10 M.D.; but counts as two attacks.

Head Butt or Stomp — 2D6 M.D.

7. Other Hand-Held Weapons may be used. Additional, giant-sized, hand-held weapons, from energy rifles and rail guns to clubs and magic weapons, may be used by the cyborg.

8. Additional Bionic Systems Common to the Thunderstorm:

- Wide-Angle Vision with Multi-Optics.
- Two additional Bionic Eye features of choice.

- Two hand weapons or features of choice.
- Internal **Comp-Calculator**.
- Low-Frequency (earthquake) Audio Rig.
- Sound Filtration System.
- Optional Head Collar & Hood.

Weapons Unique to the Sovietski

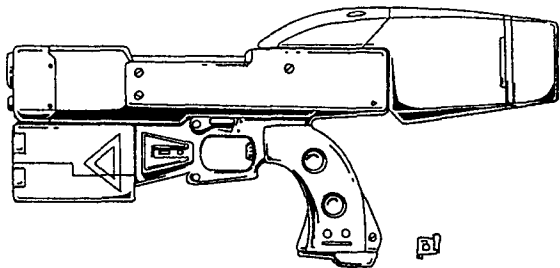

S-20-20 "Popper" Assault Pistol

A dual system weapon that combines a double barreled laser on the bottom and a rapid-fire grenade launcher on the top. This weapon is also based on **pre-Rifts** Soviet technology and is intended for use by cyborgs. Ordinary humans need a P.S. of 21 or higher to use it one-handed without penalty. Those with a P.S. of 16-20 are -3 to strike, while those who are weaker are -6 to strike (if they can aim it at all) unless they use *two hands* (even then, still -1 to strike). It is a favorite among the Sovietski's cyborg soldiers and police.

Primary Purpose: Heavy Assault and Defense.

Weight: 11 lbs (5 kg) fully loaded (10 lbs/4.5 kg without the grenades). The weapon has 50 M.D.C.

Mega-Damage: Laser: 2D6 M.D. from a single beam or 4D6 M.D. from a simultaneous double beam blast (counts as one melee attack).

Grenades: 5D6 M.D. per single grenade. Cannot fire in bursts. Blast radius is four feet (1.2 m).

A switch on the weapon changes the firing from laser to grenade. Both cannot be fired simultaneously.

Rate of Fire: Laser: Each single or double blast counts as one melee attack. A single grenade counts as one melee action.

Maximum Effective Range: Laser: 800 feet (244m).

Grenade Launcher: 600 feet (183 m).

Payload: Laser: 20 shots per each E-Clip. The weapon draws upon a side mounted G- or E-Clip and can take an additional E-Clip in the handle for a greater payload (40 total).

Grenade Launcher: Six hand-loaded grenades. The cap on the rear housing flips open to load. It takes one melee round (15 seconds) to reload.

Black Market Cost: 50,000 credits and up. Extremely rare, because its design is exclusive to the Sovietski and no **knock-offs** have come onto the market.

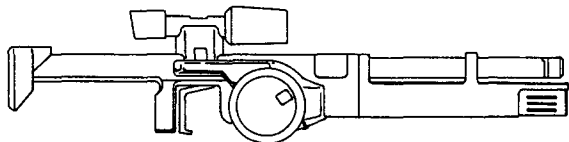

S-500 "Cyclone" Pulse Laser Rifle

A large, rapid-fire laser based on pre-Rifts Soviet technology. It is a large weapon designed specifically for use by Light and Heavy Machines. Ordinary humans need a Servo-Rig to use it,

or must possess a P.S. of 25 or greater. The weapon fires four nearly simultaneous pulses and draws upon an E-Pack contained in the circular housing in the center undercarriage of the weapon. It is a favorite among the cyborg soldiers of the Sovietski.

Primary Purpose: Anti-Monsters and Assault.

Secondary Purpose: Anti-Personnel and Defense.

Weight: 45 lbs (20 kg). The weapon has 90 M.D.C.

Mega-Damage: 1D6x10 M.D. per pulse blast. A switch can make the weapon fire one, precision shot doing 2D6 M.D.

Rate of Fire: Each blast counts as one melee attack.

Maximum Effective Range: 3,000 feet (914 m).

Payload: Four shots from a standard E-Clip (inserted in the side), or 60 from an E-Pack which is standard issue.

Black Market Cost: 100,000 credits and up. Extremely rare, because its designs are exclusive to the Sovietski and no knock-offs have come onto the market (namely because only Triax and the CS have the technology to do so).

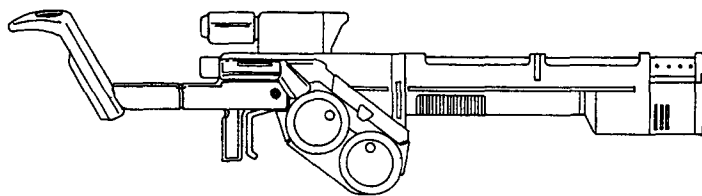

S-1000 "Thunderhead" Assault Rifle

A dual system weapon that combines a heavy laser with a rapid-fire grenade launcher. This weapon is also based on pre-Rifts Soviet technology. It is a very large weapon designed specifically for use by cyborgs. Ordinary humans need a Servo-Rig to use it, or must possess supernatural P.S. The weapon draws upon an E-Pack contained in the lower housing. The upper housing contains the payload of self-loading grenades. It is a favorite among the cyborg soldiers of the Sovietski.

Primary Purpose: Anti-Armor and Monsters.

Secondary Purpose: Anti-Personnel and Defense.

Weight: 90 lbs (40.8 kg) fully loaded (62 lbs/28 kg without the grenades and firing canister). The weapon has 100 M.D.C.

Mega-Damage: Heavy Laser: 4D6 M.D.

Grenades: 5D6 M.D. per single grenade, but can be fired in bursts of 2-4 grenades at the same target (counts as two melee attacks). Blast radius is four feet (1.2 m) regardless of the number of grenades fired.

A switch on the weapon changes the firing from laser to grenade. Both cannot be fired simultaneously.

Rate of Fire: Laser: Each blast counts as one melee attack. A single grenade or burst of 2-4 grenades counts as one melee action.

Maximum Effective Range: Laser: 2,000 feet (610 m). Grenade Launcher: 1200 feet (366 m).

Payload: Laser: 100 shots per E-Pack or 14 per standard E-Clip.

Grenade Launcher: 32; takes four minutes to reload grenades by hand, one at a time, or one melee round (15 seconds) to slap in a preloaded canister (weighs 28 lbs/12.6 kg).

Black Market Cost: 140,000 credits and up. Extremely rare, because its design is exclusive to the Sovietski and no knock-offs have come onto the market (only Triax and the CS have the technology to do so).

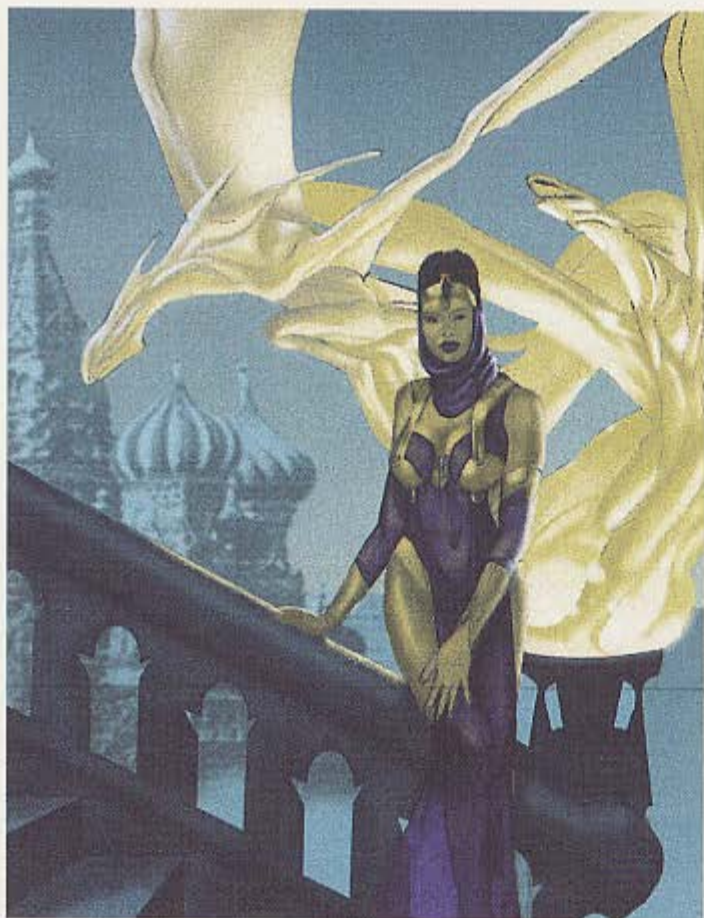

Mystic Russia

This world book picks up where the last one ends, as we focus on the mystical, monstrous and demonic aspects of the country and its people — human and inhuman.

- D-Bees, ancient gods, demons and monsters galore!
- Russian magic & magical creations.
- Gypsies, Mystic Kuznya and other O.C.C.s.
- A dangerous link to the Americas.
- More world information and adventure ideas.
- Written by Kevin Siembieda and Kevin E. Krueger.
- Art by Perez, Breaux, Johnson and others.
- \$16.95 — 160 pages.

Rifts® Australia

- Dream Time magic and Song Lines.
- Dream Time monsters, demons and gods.
- The wise and mystical Aborigine (several O.C.C.s).
- The Outbackers and D-bees.
- The Outback — more dangerous than ever.
- The last vestiges of the old civilization.
- The fortified cities of Perth and Melbourne.
- \$20.95 — 224 pages.

Rifts® Warlords of Russia™

Russia and the slavic countries are said to be monster-ridden hell-holes. Perhaps, but the indomitable human spirit has risen from the chaos to challenge their claims to human lands.

The Warlords might be described as part barbarian, part animal and part machine, for it is through the technological sorcery of bionics that the Warlords and their cyborg hordes dominate the land.

- The Warlords of Russia, their armies and politics.
- Cyborgs like you've never seen 'em before.
- The Sovietski, their war machines and history.
- New O.C.C.s like the Hero-Knight & Ecto-Hunter.
- Tons of world information and adventure ideas.
- Written by Kevin Siembieda and Kevin E. Krueger.
- Art by Perez, Breaux, Johnson and others.
- 224 pages

\$20.95

Cat. No. 832

I.S.B.N. 157457-010-2

ISBN 1-57457-010-2



9 781574 570106