

Palladium Books® Presents:

# New West™

Rifts® World Book 14

By Christopher R. Kornmann  
& Kevin Siembieda



# Warning!

## Violence and the Supernatural

The fictional World of Rifts® is violent, deadly and filled with supernatural monsters. Other dimensional beings, often referred to as "demons," torment, stalk and prey on humans. Other alien life forms, monsters, gods and demigod, as well as magic, insanity, and war are all elements in this book.

Some parents may find the violence and supernatural elements of the game inappropriate for young readers/players. We suggest parental discretion.

Please note that none of us at Palladium Books® condone or encourage the occult, the practice of magic, the use of drugs, or violence.

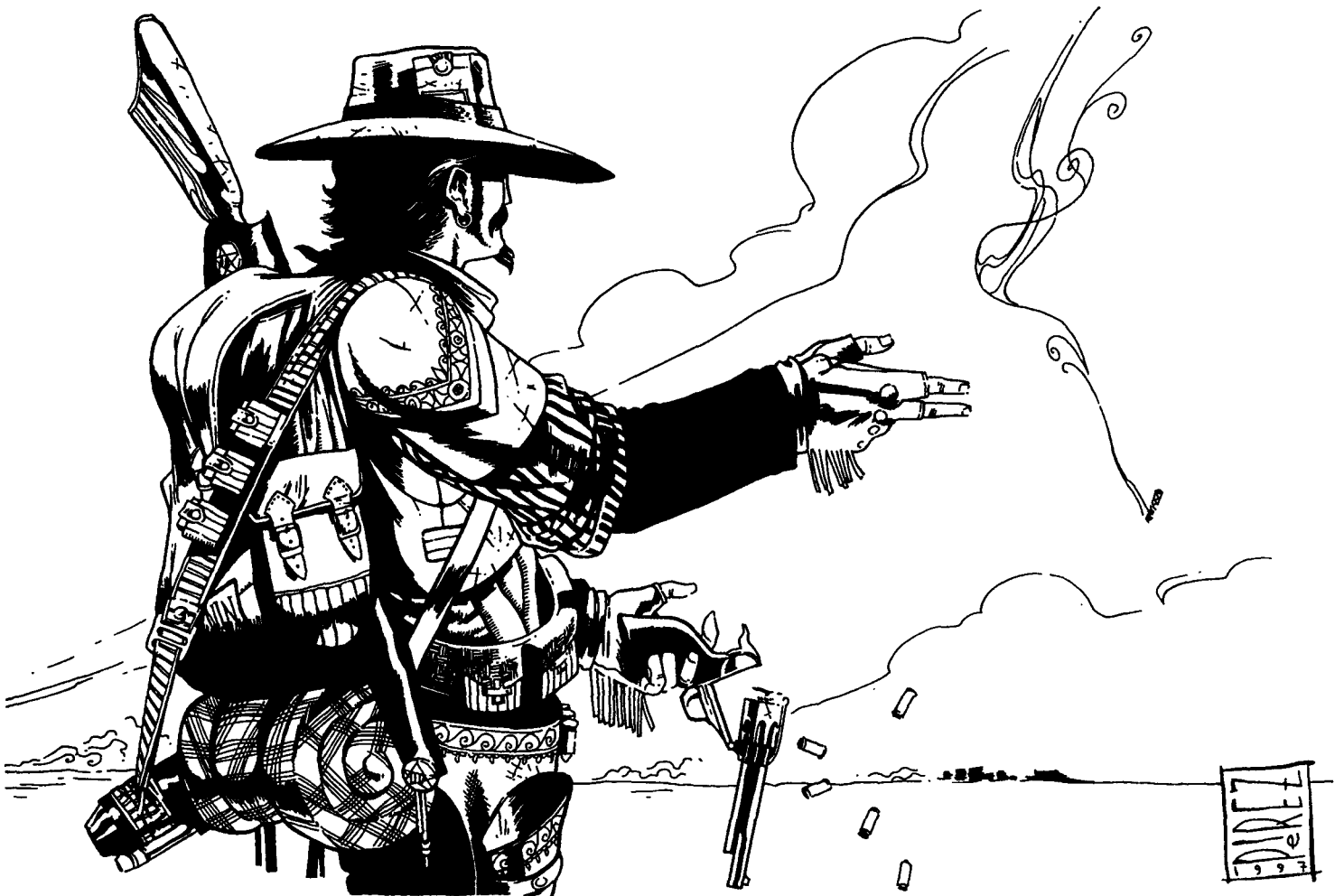

An epic world book for the Rifts® series.  
Compatible with the entire Palladium Books® Megaverse™!

**This work is dedicated to everybody in my life who, in whatever way, played a part in helping me create the New West. To the imagination and hearts of Brian, Darren and Ray without whom the New West would not have been possible. To the support of my parents, and most of all to my Mom who kept all of us fed, and to everyone else who believed in me. A special thanks to Kevin Siembieda for giving me the chance to fulfill a dream. Finally, here is to all the players and game masters out there. Remember we don't play games, we build worlds.**

*— Christopher R. Kornmann, 1997*

---

**Chris Kornmann, for his exciting writing and wonderful ideas; they were an inspiration and made my work on this book that much more fun. And to my love, Maryann, who struggled so hard to literally get back on her feet after a car accident a few weeks ago, to get this book typeset and to the printer. Also thanks to Wayne Smith (he knows why).**

*— Kevin Siembieda, 1997*

---

## **Second Printing — December 1998**

Copyright Palladium Books Inc. & Kevin Siembieda 1997

All rights reserved, world wide, under the Universal Copyright Convention. No part of this book may be reproduced in part or whole, in any form or by any means, without permission from the publisher, except for brief quotes for use in reviews. All incidents, situations, institutions, governments and people are fictional and any similarity, without satiric intent, of characters or persons living or dead, is strictly coincidental.

The use of such names as Colt, Remington, Winchester, Sharp and others are used in a fictional context and reflect their influence in the American Old West (and now Rifts® New West™). Palladium Books Inc. does not claim any ownership in these companies, products, or their trademarks.

Palladium Books®, Rifts®, RECON®, and Megaverse® are registered trademarks owned and licensed by Kevin Siembieda and Palladium Books Inc., New West, Coalition States, Psi-Slinger, Wired Gunslinger, Slinger, Sky-Knight, Justice Ranger, Worm Wraith, Fennodi, Sky-Knights, Cyber-Knights, Techno-Wizard, Erin Tarn, Emperor Prosek, Lone Star, SAMAS, Skelebots, Dog Boys, Dog Pack, Psi-Stalker, Simvan, Juicer, Cloud-weaver, and other names and titles are trademarks owned by Kevin Siembieda and Palladium Books Inc.

[www.palladiumbooks.com](http://www.palladiumbooks.com)

Rifts® **World Book 14: New West™** is published by Palladium Books Inc., 12455 Universal Drive, Taylor, MI 48180. Printed in the USA.

Palladium Books® Presents:

# Rifts™ New West™

WRITTEN BY: KEVIN SIEMBIEDA  
& CHRISTOPHER R. KORNMANN

RODEO SECTION BY: JULIUS ROSENSTEIN

EDITORS: ALEX MARCINISZYN  
JIM OSTEN

PROOFREADER: JULIUS ROSENSTEIN  
RANDI CARTIER

COVER PAINTING: JOHN ZELEZNIK

INTERIOR ARTISTS: RAMON PEREZ JR.  
WAYNE BREAUX JR.  
MICHAEL DUBISCH  
SCOTT JOHNSON  
MARTIN MCKENNA  
BRADON C. CLARK  
MARK DUDDLEY  
KA XIONG  
CHRISTOPHER MORRILL

ART DIRECTION, MAPS & KEVLINING: KEVIN SIEMBIEDA

TYPOGRAPHY: MARYANN SIEMBIEDA

PALLADIUM BOOKS ON-LINE: [WWW.PALLADIUMBOOKS.COM](http://WWW.PALLADIUMBOOKS.COM)

SPECIAL THANKS TO CHRIS KORNMANN WHO HELPED BRING THE NEW WEST TO LIFE. RAMON PEREZ JR. AND WAYNE BREAUX JR. FOR SOME TRULY WILD ARTWORK/ SCOTT JOHNSON AND THE DRUNK STYLE STUDIO FOR THEIR ART CONTRIBUTIONS. JOHN ZELEZNIK FOR A ROLLICKING WIRED GUNSLINGER IN BLAZING ACTION ON HIS TRUSTY ROBOT HORSE. ALSO TO JULIUS FOR STAYING LATE ON THE WEEKEND TO PROOFREAD, RANDI CARTIER FOR COMING IN TO LEND A HAND, TO MARYANN'S HERCULEAN EFFORTS, STEVE, ALEX, JIM AND ALL THE PALLADIUM DUDES FOR THEIR HARD WORK AND EFFORTS.

DD KEVIN SIEMBIEDA, 1997

---

# Contents

---

Introduction.....	9	Horsemanship Skills.....	72
A glimpse of the New West .....	10	Rogue Skills (new).....	78
<b>The New West .....</b>	<b>11</b>	Weapon Proficiencies.....	79
An Overview of life in the American Wilderness ..	11	Snapshooting Bonuses.....	80
Some Common Slang & Expressions .....	16	Combat Notes .....	81
The Trouble with Credits .....	17	<b>O.C.C.S &amp; NPC Villains of the New West. ....</b>	<b>82</b>
<b>New West Overview of Territories .....</b>	<b>19</b>	The Code of the New West.....	83
Bandito Arms .....	22	Bandits.....	83
Lost Treasures of Utah .....	24	Bounty Hunter.....	87
Most Desolate Territories.....	24	Gunfighter.....	90
Indian Population Centers .....	24	Gunslinger.....	92
Notable Groups & Operations .....	25	Sheriff/Lawman.....	102
<b>1st Apocalyptic Cavalry .....</b>	<b>26</b>	Wired Gunslinger .....	107
General Kenneth Sprite .....	27	<b>Adventurers of the New West.....</b>	<b>110</b>
<b>Arizona.....</b>	<b>29</b>	Cowboy .....	110
Wormrot.....	29	Professional Gambler .....	117
Phoenix Area.....	29	Saloon Girl/Barmaid.....	123
Northern Arizona .....	31	<b>Racial Character Classes of the New West.....</b>	<b>125</b>
Canyon & Mountain Vegetation .....	31	A few comments about D-Bees.....	125
People & Places in the Grand Canyon Region.....	32	Fennodi R.C.C. ....	128
<b>The Golden Ones.....</b>	<b>33</b>	Lyn-Srial R.C.C. ....	133
The magic & nobility of the Lyn-Srial.....	33	<b>Monsters Common to the New West.....</b>	<b>138</b>
The Lyn-Srial .....	34	Devil Unicorn .....	140
Tryth-Sal: The Cliff City .....	34	Grigleapers .....	146
The Elegant Art of Cloudweaving .....	36	Scorpions & Snakes.....	161
<b>Cloud Magic.....</b>	<b>37</b>	Worm Wraith.....	169
Clouds of War.....	37	<b>Bandito Arms.....</b>	<b>171</b>
Clouds of Defense.....	39	Bandito Arms Weapons .....	172
Clouds of Peace .....	40	BigBore Series.....	174
Clouds of Travel.....	41	Light Rail Guns.....	175
Clouds of Survival .....	42	Bandito Body Armor.....	177
Clouds of the Mind.....	43	Northern Gun Armor.....	179
Clouds of Creation .....	44	Bandito Arms Power Armor.....	181
<b>Colorado.....</b>	<b>45</b>	Bionics.....	187
Silvereno.....	45	<b>New West Cyborgs.....</b>	<b>189</b>
Sheriff Whispering Wind .....	48	Cyberslinger Series of Cyborgs .....	189
The Lost .....	49	<b>Robot Vehicles .....</b>	<b>193</b>
Places of Note in Silvereno .....	52	The Tarantula ATV.....	193
The Story of Shaft 8 .....	54	Robot Horses.....	195
<b>The Colorado Baronies.....</b>	<b>55</b>	Bandit K-9 Companion.....	199
The Barony of Hope.....	57	Bronco Scooter .....	201
The Other Baronies.....	59	Cavalry War Wagon .....	202
The City of Charity.....	61	<b>Wilk's Laser Technologies .....</b>	<b>203</b>
<b>Rodeos.....</b>	<b>62</b>	Wilk's Laser Weapons .....	203
Resolving the (Rodeo) Events .....	65	Wilk's-Remi Firearms.....	207
Medicine Shows .....	66	Other Wilk's Products of Note .....	209
<b>New Skills.....</b>	<b>70</b>	<b>Conventional Revolvers.....</b>	<b>210</b>
Cowboy Skills.....	71	<b>Techno-Wizard Weapons.....</b>	<b>213</b>

---

## Quick Find ---

Barding (horse armor).....	181
Bionics.....	187
Black Market: Area 51.....	22
Black Market: Bandito Arms.....	171
Black Market: Customized Armor .....	178
Black Market: Patchwork & Used Armor.....	179
Cloud Magic.....	37
Coalition States & the New West.....	15
Code of the New West.....	83
Code of the Cowboy.....	III
Cowboy.....	110
Credits.....	17
Culture and mindset (overview).....	12
Cyber-Knights (overview).....	14
Disarm.....	81
Drink others under the table (rules).....	121
Dr. Geller's Carnival of Wonders .....	66
Education in the West (overview) .....	11
Ghost Towns (overview) .....	14
Golden Ones (Lyn-Srial) .....	33 & 133
Grand Canyon.....	31
Guns, Conventional .....	210
Horses, General Notes & Stats.....	72
Horsemanship Skills.....	72
Law: Frontier Justice (overview).....	13
Law: Lawmen (overview) .....	12
Law: Lawmen/Sheriff O.C.C. ....	102
Lyn-Srial: Background.....	33
Lyn-Srial: City (Tryth-Sal).....	34
Lyn-Srial: Cloud Magic .....	37
Lyn-Srial R.C.C.s.....	133
Mining (see Mining 'Borg) .....	113
Mining 'Borg Attachments.....	187
Nebraska: 1st Cavalry .....	26
Nebraska: Fort Prospect.....	28
Old Style Guns that are Energy Weapons .....	207
Overview of the New West .....	11
Quick Draw (see Gunslinger).....	94
Religion in the New West (see Preacher) .....	115
Revolvers (conventional).....	210
Romanticism with the past.....	11
Saloons (see Saloon Bum).....	120
Saloon Services & Prices (see Saloon Bum).....	120
Saloon Bum .....	121
Saloon Girl .....	123
SAMAS (new types).....	181
Snapshooting W.P. ....	79
Snapshooting Bonuses .....	80
Snapshooting: Trick Shooting.....	81
Showdown (description).....	81
Six-Shooters (weapons) .....	210
Terms: Geological .....	19
Terms: Slang.....	16

Technology Levels (overview).....	11
Towns, Typical.....	12
Towns of Arizona.....	29
Town: Silvereno.....	45
Town: City of Hope .....	57
Trick Shooting (part of Sharpshooting).....	81
Vampires: The Lost .....	49
William McKinnith, Diary of.....	10
Wilk's History.....	203
Wilk's Laser Cane.....	210
Wilk's Laser Guns.....	203
Wilk's Laser Grenades .....	209
Wilk's Laser Knife .....	209
Wilk's-Remi Weapons .....	207

### O.C.C.s of the New West

#### Men at Arms O.C.C.s

Bandit (Peasant Thug).....	83
Bandit: Highwayman .....	85
Bounty Hunter.....	87
CyberSlinger Cyborgs.....	189
Gunfighter.....	90
Gunslinger.....	92
Justice Ranger.....	96
Psi-Slinger.....	98
Saddle Tramp .....	101
Sheriff/Lawman.....	102
Sheriff's Deputy .....	105
Wired Gunslinger .....	107

#### Adventurers & Others

Cowboy.....	110
Mining 'Borg.....	113
Preacher.....	115
Professional Gambler .....	117
Saloon Bum/Stoolie .....	121
Saloon Girl/Barmaid.....	123

#### Racial Character Classes (R.C.C.s)

Cactus People .....	125
Fennodi.....	128
Keepers of the Desert .....	130
Lyn-Srial: Average Citizen.....	133
Lyn-Srial: Cloudweaver.....	135
Lyn-Srial: Knight.....	134
Mountain Giants .....	136
Phantasm (optional) .....	158
Psi-Pony (optional).....	156

#### Monsters Common to the New West

Desert Sleepers .....	138
Devil Unicorn .....	140

Duckbilled Honkers .....	141
Giant Canyon Worms .....	143
Great Dream Snakes.....	144
Great Plains Buffalo .....	145
Grigleapers .....	146
Gwylack.....	147
Leatherwing.....	148
Mammoth Brontodon .....	149
Moss-Back Scuttler.....	151
Oborus-Slitherer .....	152
Ostrosaurus .....	153
Panthera-Tereon .....	155
Phantasm.....	157
Psi-Ponies .....	156
Rhino- Buffalo.....	158
Scorpions & Snakes .....	161
Silonar.....	160
Tiger Claw Raptor.....	162
Tree Spiders.....	163
Tri-Tops.....	164
Tyrannosaurus Rex .....	166
Whisker Coyote.....	167
Worm Wraith.....	169

**Dinosaurs**

Desert Sleepers .....	138
Duckbilled Honkers .....	141
Leatherwing.....	148
Mammoth Brontodon.....	149
Moss-Back Scuttler.....	151
Ostrosaurus .....	153
Panthera-Tereon.....	155
Rhino- Buffalo .....	158
Silonar.....	160
Tiger Claw Raptor.....	162
Tri-Tops.....	164
Tyrannosaurus Rex .....	166

**Maps**

American Empire, The (USA) .....	21
Bandito Arms/Area 51 .....	22
Colorado Baronies.....	57
Colorado Barony of Hope.....	57
Colorado Territory .....	20 & 45
Colorado River .....	20
Kansas.....	22
Montana.....	22
Nevada.....	22
New Mexico .....	23
New West, The .....	20
New West: Areas of Magic.....	25
North & South Dakota .....	21
Utah.....	23

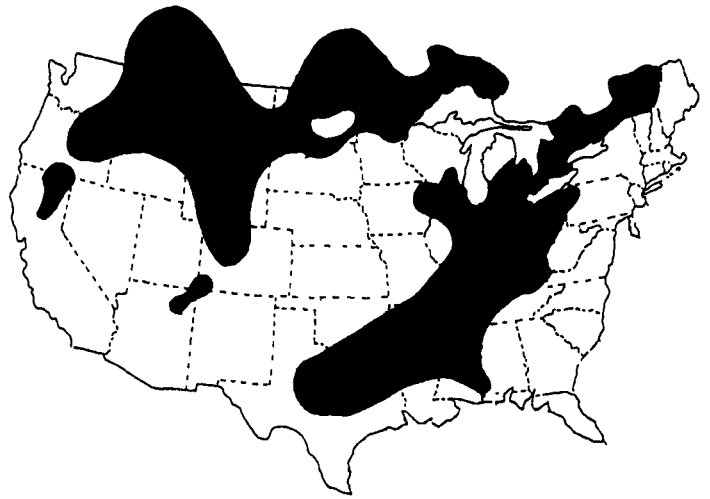

**Major Ranges of Psi-Stalker Activity**

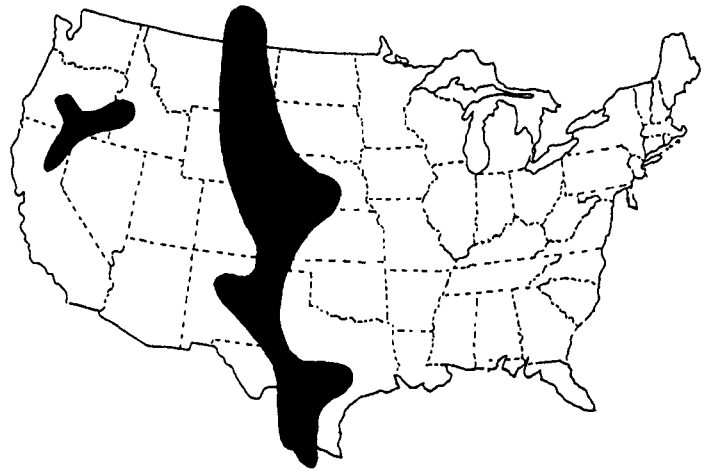

**Major Simvan Ranges**

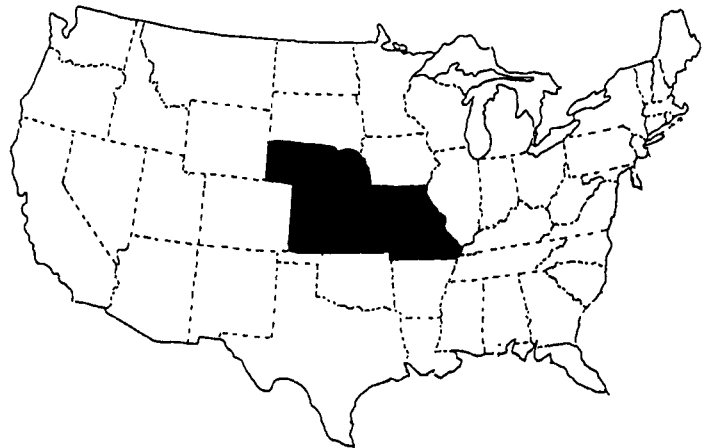

**Home Range of the 1st Cavalry**

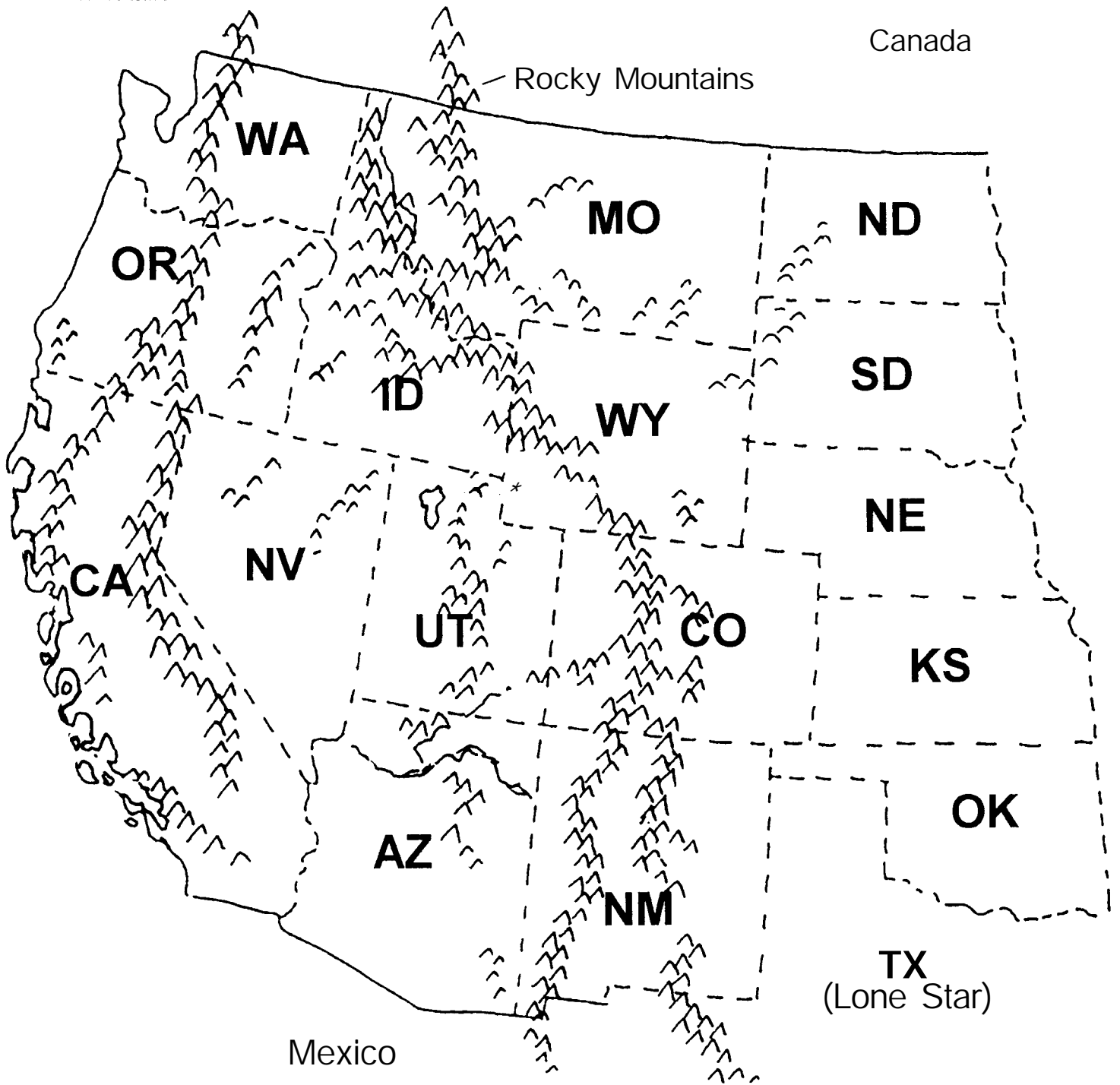

# New West Territories

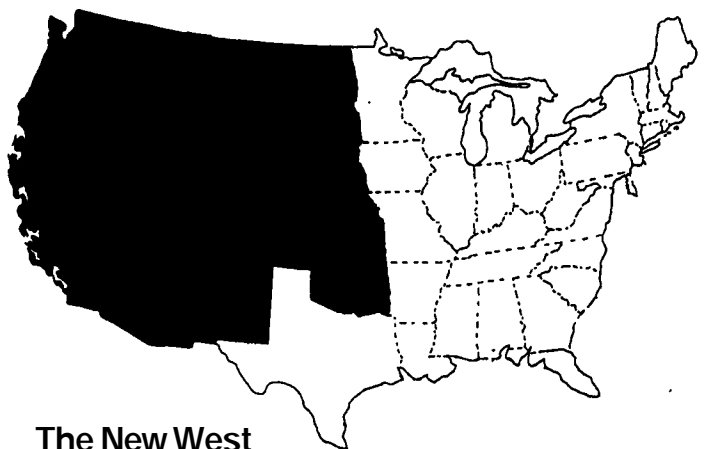





---

# Introduction

Palladium Books had been promising a book entitled the **New West** for some time, when I decided to write my own version and submit it for their consideration. Apparently, it had a lot of elements Kevin Siembieda had planned for New West, so the next thing I knew, we were working out an agreement that would incorporate my manuscript into Kevin's. I hope that this book lives up to the Palladium Books and Rifts tradition of magic, technology, high adventure, monsters and mayhem put into a believable setting.

This publication is meant to be used as a sourcebook for the entire Rifts® Megaverse®. It deals mostly with the western portions of the United States and some northern areas such as what used to be *Montana, Idaho, and Wyoming*; I will try to bring back the days when the west was an untamed wilderness and there was always adventure and danger. The days when buffalo roamed the great plains and living legends walked among men. Legends like Geronimo, Cochise, Wyatt Earp, Jessie James, Wild Bill, and others. All of this combined with the mystical powers of psionics and magic, and the advanced technology that have all become the trademarks of the Rifts Megaverse®.

— Christopher R. Kornmann

---

## A few words from Siembieda

Rifts New West was a tremendously fun book for me. I don't know whether it was the subject matter, the tons of fun research, Chris Kornmann's exciting writing (which inspired me to add and change a lot more than I had planned — I hope Chris isn't too disappointed by that), or the advent of Spring, but I had a blast writing Rifts® New West!

The subject matter and expansive geographic region makes it impossible to "detail" even a quarter of the New West (heck, the CS State of Lone Star got its own book), but Chris and I have tried to provide a good *general* idea about the region, people, and the dominant culture and outlooks of the inhabitants. Of course, the companion World Books, **Rifts® Lone Star** and **Rifts® Spirit West™**, will help complete the overall picture and add dramatically to the scope and details of the western setting. Future books focusing on the *Cyber-Knights*, *Black Market* and specific locations will add even more to the rich details of the North American continent and the world of Rifts.

I think I focused most on the people and culture. This means a large section about the Occupational Character Classes and Villains of the New West, with some pretty elaborate descriptions and details about their lives, work, and ethics. I felt descriptions of O.C.C.s like the Bounty Hunter, Cowboy, Gunslinger, and others were Old West *icons* that represented the culture and flavor of this environment as much or more than anything else, so I went wild with them. I hope you like the end result, and find them informative, dynamic, and a delight to play.

Like most of the books in the **Rifts® RPG** series, **Rifts® New West™** combines both the familiar and the alien, the commonplace and with the fantastic. Personally, I think this book really delivers! Of course, I'm riding the high of excitement in producing several fun Rifts® titles, as well as the success of the **Palladium Fantasy RPG series** and developing new stuff for

**Heroes Unlimited™, Palladium Fantasy, and Nightbane™**, so I may be blinded by my own enthusiasm. In any case, enjoy.

Oh, if you're looking for additional reference material books about the Old West, there is a quintet of books I must mention for both their value as references and joy to read.

**The Old West**, by Time Life Books, © 1990, ISBN 0-13-631151-2. This book is truly outstanding, full of fun facts, maps, and fun to read. I give this book my highest recommendation.

**The Wild West**, by Warner Books (in conjunction with Time-Life Books and clearly has some stuff derivative of the previous book); ISBN 0446-51761-5

**The Taming of the West: Age of the Gunfighter**, by Joseph G. Rosa, © 1993, **Smithmark** Publishing. This is another book with lots of fun facts about the gunmen and violence of the Old West (1840-1900), but I found it remarkable for the incredible number of crystal clear and large, color photographs of weapons, including derringers, revolvers, rifles, holsters, and other paraphernalia, as well as maps, drawings and reproductions of actual old photographs; a beautiful visual (and text) reference.

**Native American Mythology**, by Gill & Sullivan; one of the most comprehensive references I've ever found.

**The People Called the Apache**, by Thomas E. Mails, ©1974 & 1993. This is another excellent reference with beautiful drawings, maps, photographs and informative text.

I personally referred to over 30 books in the research of the three western wilderness books for **Rifts®**, including several modern *Travel Handbooks* by Moon Publications, the *Atlas of the North American Indian*, and too many others to list. The five above are a few that I thought fans might find the most interesting and fun to read.

—Kevin Siembieda, 1997

---

# A glimpse of the New West

---

## From the Diary of William McKinnith

By Christopher Kornmann

The following information is taken from the audio diary of William McKinnith, one of the many brave and hardy men who have lived and died in this wild, new west. He was one of the many who had taken to the life of the *Gunslinger*.

### April 15

Woke up early this morning jus' as the sun was risin'. I thought I heard **somethin'** over in some rocks, but it turned out just to be a rattlesnake. Damn snakes are everywhere, but they're the least of my worries. The whole town of **Silvereno** wants my ass dead. I was jus' defend'n myself from that little bastard who pulled his **Remi** on me. He should'a known better. '**Sides**, I wasn't even **tryin'** to cheat him or them others. As a matter of fact, that was the first fair game of cards I played in a long time.

How's I supposed to know he was the mayor's son? Shit, he didn't look like no mayor's son to me. Now I'm stuck hidin' in the damn mountains. Well, I guess I'll head south to **Purespring**. Got friends there ya know.

### April 18

Spotted one of those damn injun scouts today. He was sittin' all nice an pretty up on a mesa jus' waitin' to lead sum poor sum bitch into an ambush. I had 'im right in the sights of my **Wilks-Remi** when I decided, why not leave '**em** for the posse? I snuck right past the red man. Never knew I was there. Never even heard the damn horse. Yeah, I'm pretty damn good, if I do say so myself.

### April 19

I waited that night to see if the posse still had my scent, '**sides** I wanted to see how they handled my injun friend. I found myself a nice little hole to crawl into up on this little mesa. Had a great view of that Apache scout and of that posse when they come **ridin'** in. They rode into that valley **makin'** all kinds a noise. Two suits of power armor, six hoverbikes, a jeep, and their lead scout who was on horseback. Almost felt kinda sorry for that horse, cuz soon as they got into that there valley, fifty screamin' **Paches** came outta nowhere. They tore up that power armor first with those damn bows shootin' those crazy lookin' **flamin'** arrows. As soon as they fired one, another was notched and ready to go. Craziest thing that injun magic.

The jeep was next, with some big ol' laser machinegun on the back. Four of them Apache warriors jus' snuck right up and killed the poor bastards inside with their tomahawks. Why them good ol' boys weren't **wearin'** no body armor I don't know. Stupid.

The guy on the horse put some kinda magic shield up and started to blaze away with his Wilk's. I think he actually hit one of the Apaches '**fore** one o' their shaman sent some spirit wolf into his brain. He was dead '**bout** four seconds later. Damn Apache mind magic. Can't fight what ain't real.

The guys on the bikes tried to run but them Apaches cut '**em** down in short order with the stolen **Remi's** and **Wilk's** they was **carryin'**. I almost feel sorry for them poor sons a bitches, but hell they shoulda jus' left me be. Well on to *Purespring*.

### April 24

Ran out of water today. Good thing **Purespring** is only about a days ride from here. I'll jus' have to see what I can find out here in the desert. You jus' gotta kinda let the desert talk to ya. If ya respect her, she'll take care of ya. If ya don't, she'll kill ya dead, fer sure. Passed by a **Gwylack Burrow** '**bout** an hour ago. Good thing they only come out at night cuz I **don't** treasure the thought of **runnin'** into a twelve foot tall, half scorpion, half tarantula. I jus' don't know how them injuns catch and eat those ugly things.

### April 25

I was headin' into **Purespring** this noon and I seen some smoke on the horizon, lots of it. I kept **headin'** toward town and the smoke just kept gettin' heavier. I knew that little town was on fire.

There was people lyin' dead everywhere in town. Buildin's was on fire, trucks turned over — looked like the almighty himself come down and killed everybody. The place looked like it was hit by the injuns. Never really can tell though, since they never leave their dead behind. Damn injuns are **gettin'** real up-pity as of late. Don't know **what** got '**em** all riled up. Been attackin' all kinds of settlements like their ready to up the stakes. Well, I really can't be worryin' about all that, now can I? I've plenty o' my own problems. There's still probably a posse on my tail. Maybe a price on my head, so I gotta watch out fer meres and bounty hunters; strangers in general. As for **Purespring**, I guess I'll get some water and be **headin'** south. I hopes my buddies made it outta here alive. Hell, ain't no injun yet who could get **Furth** anyway. That little desert-elf is sneakier than a starvin' rattlesnake.

### April 27

Made it to the little town of Mesa Bay this mornin'. Funny thing is, the rest o' that damn posse made it here too. Picked me up right as I rode into town. The bastards shot me twice '**fore**I even got my **Remi** out. Ah well, at least I got the stupid one who tried to '**cuff** me. Got '**em** right in the knee with my **Peacebringer**. Ha **Peacebringer**, more like "**pieces bringer**" considering that poor kid ain't ever gonna walk straight again without bionics. 'Parently, they never learned him, ya never get that close to an angry rattler.

Well, the next thing I know I'm floating in the air with my guns in the dirt below me. That posse was laughin' and havin' themselves a good ol' time while that damned psychic jus' lifted me right into this damn jail cell. Well, at least they let me keep this diary and healed me up. Their mistake though, ain't a jail built that can hold ol' Bill McKinnith. I'll be out by morning. I gotta get that **Wilks-Remi** back though, I love that gun.

**Note:** William McKinnith was hung on April 28 in the town of Mesa Bay. His only possessions were confiscated by the town. His audio diary was sold to a passing historian who published parts of it in a popular, underground (and illegal) book (available on disk and paper) entitled: *Outlaws of the New West*.

William McKinnith was just one of a thousand such outlaws who have lived and died in this new world.



# The New West

## An Overview of life in the American Wilderness

"The New West" commonly refers to the vast wilderness that lies beyond the western borders of the Coalition States. It covers a very large part of what used to be the Old American empire. Just as the settlers of the past once did, the people who live in the western wilderness are pioneers, outcasts, refugees and desperadoes trying to eke out a life in this harsh and dangerous part of the country. The New West roughly consists of the following states of the old American Empire: *Nebraska, South Dakota, North Dakota, Montana, Wyoming, Colorado, New Mexico, Arizona, Utah, Nevada, Idaho, Colorado, Arizona*, and what's left of *California*. *Oregon* and *Washington* are usually also included, although some give them the separate distinction of The Northwest. *Texas* is the disputed Coalition State of Lone Star.

Sections of the Western territories are occupied or claimed by human and D-bee kingdoms, tribes, clans, settlers, ranchers, and gangs, but it is largely a vast disputed wilderness with a variety of terrains, from forests and mountains to prairies and deserts. Throughout the entire territory, there is an incredibly broad

range and mix of technologies, some common to all, others claimed by specific human and/or D-bee communities or organizations. Despite this, most of the New West is cut off from the rest of the country. Long-range radio is constantly broken up by frequent ley line storms, dimensional anomalies, or natural weather occurrences. For this reason the people in this region know little about the rest of the country, fear the Coalition States, and have developed hundreds, if not thousands, of tiny, independent and often unique communities and societies (mostly small clans, tribes and gangs —see **Rifts® Lone Star** for general data concerning the sizes and structures of such communities).

**The prevailing technology** is generally low tech, roughly equal to 1830 to 1900. Only weapons, armor and vehicles are consistently and comparatively high-tech, and many of these are modified or thrown together jalopies and hybrids using whatever was available. The look and designs of the pre-Rifts Old West are loved by the people of the New West, so except for the mega-damage body armor, energy rifle, laser pistols and hover-cycle, the average Joe looks like a Cowboy, Indian or citizen who just walked out of the Old West. This retro-look is perpetuated by the Black Market, Northern Gun, **Wilk's**, CFT and other manufacturers and traders who cater to the wants of the people. Consequently, cowboy boots, hats, chaps, clothing, gear, holsters, spurs, hover-stagecoaches and weapons are commonplace. Robot horses traverse the land along with live horses, alien riding animals, motorcycles, **hovercycles**, power armor and robots. In fact, robot horses are all the rage among adventurers and many Men at Arms. Other people, including cowboys, shun the robots because of their high price or because they favor the genuine animal. One of the most interesting means of transportation in the territory is the "Iron Horse" — a **Techno-Wizard** hover-train system! Just like the towns of the old west, many communities in this bold new era have flourished around a train station.

**Education** in the New West is usually focused on specialized "trades" that reflect the characters' occupation. The average town person is a tradesman or laborer — farmer, rancher, cowboy, carpenter, etc. — who cannot read or write (80% illiteracy), although most (65%) have rudimentary math skills. Only a small minority are highly skilled and formally educated (rogue scientists, doctors, scholars, operators, etc.). Nomads, adventurers, drifters, bandits, mercenaries and even lawmen and town leaders tend to have little formal education. Their knowledge centers around their occupation, whether it be wilderness **scout/hunter**, shaman, gunslinger or thief. Of course, the level of formal education and tech skills will vary from place to place and people to people.

**Romanticism with the past.** Nobody knows exactly who started it, but the Old West of pre-Rifts Earth has been romanticized and glamorized throughout the wilderness of the American west and Canadian southwest. Historical figures such as Wyatt **Earp**, Buffalo Bill, Wild Bill Hickok, General Custer, Sitting Bull, Cochise, Geronimo, Jessie James and Billy the Kid, Butch & **Sundance**, along with fictional heroes, outlaws and "film" cowboys like the Lone Ranger, the Magnificent Seven, Roy Rogers, Gene **Autry**, John Wayne and **Clint** Eastwood are all legendary figures! The real and the fictional have become blurred and intertwined to make an even wilder and woollier image of the

Old West than it really was. Many fictional films and stories preserved and rediscovered on ancient video film disks, books and comic books from the days before the Great Cataclysm are regarded as factual or dramatizations based on fact! Thus, the Hollywood depiction of the cowboy, outlaw hero and images of the Old West have become *icons* for this new and very different age. Even D-bees, trying to fit into the prevailing society of the land have adopted the appearance and ways of the (old) New West.

In an effort to recapture their lost heritage (or because it looked or felt exciting, dynamic — "cool"), people began to copy the buildings, style of clothes, general appearances, and even the mannerisms and slang of the Hollywood Old West. Manufacturers exploited this romantic view of the Old West by creating weapons, clothing and products that have the appearance of something out of a cowboy movie; mostly the images from the time period of 1830 to 1890. This, of course, only perpetuates and ingrains the romantic view, images, stylings and ways of the bygone era. Not only have these manufacturers copied the appearance, they have also taken many familiar names. For example, there are entire lines of weapons with the familiar names of **Colt, Remington, Winchester** and others. In most cases, the weapons even *look* just like an old six-shooter or a repeating rifle, and may be an S.D.C. weapon or a laser pistol or other advanced, mega-damage energy weapon. Likewise, Techno-Wizards have magically turned ordinary looking revolvers into magic weapons that fire magical energy bolts instead of bullets! Wilk's has an entire line of weapons known as the **Wilk's-Remington**, more commonly known as "**Remis**," and has made these weapons the most popular in the New West!

**The culture and mindset** of people in the New West are very different than the Eastern portion of the continent. The average town seldom exceeds a population of 600 and even "big" towns usually have less than 3000 people. The number of "cities," like Silvereno, can be counted on two hands. The New West is lawless and hard. Most of the inhabitants have come to accept the principles of "might makes right," "might makes (or ignores) the law," and "the fastest gun does the talking." Consequently, anarchy reigns.

The culture is very much a **throwback** to the Old American West of the 18th and 19th Century. In some cases this is a deliberate "retro-fitting" by individuals who prefer the old ways, old technology or mysticism over the high technology of the East. Some have intentionally tried to recreate the old ways and (perceived) freedom, courage and heroics of the Old American West. In other cases, it is a logical response and a lifestyle that is reflective of the environment, especially among cowboys, ranchers, trappers/skinners, gunslingers and bounty hunters.

**Towns** of the New West tend to be based around one or two major types of industry, typically mining, farming, cattle ranching or the raising of other livestock, banditry, train stations with water and shops, or, to a lesser degree, large industry, such as the Black Market and Wilk's Laser Industries factories.

The average town in the New West tends to be small and often lawless. There is usually a main city street, merchant district, town square (often a park), drinking well or stream, a bank or loan office and trading post, general store, hotel, and city hall, all in the same general vicinity which serves as the town's center or "downtown" area.

Most of the residential homes are spread out, often for miles, interspersed with farms and ranches, around the town's center. Most buildings are no taller than 2-4 stories and tend to be made out of either light mega-damage material or inexpensive S.D.C. materials; wood, brick and concrete being the most common. Virtually all have a western motif, and for this reason, a dance hall and 2-12 saloons are typically located at the center of every town. A gambling casino and dens of iniquity may also be part of the town, although they may be located on the outskirts or other end of town depending on the moral fortitude and general alignment of the townspeople — **some** places don't allow gambling, drugs or prostitution, while some don't like it, but accept it, and others (usually the most lawless) welcome it. **Doctors/healers**, dentists and operators/mechanics are among the most valued and most difficult professions to find at a town. Only one in ten small towns will have one or all of them, although most large towns (70%) and cities (95%) will have at least one of each.

The biggest and/or most self-sufficient towns (2000-6000) will have a *local* radio broadcasting network or even a television station for music, entertainment and news. Broadcasting range rarely exceeds 100 miles (160 km), and programming is usually very basic, repetitive and limited. In addition, most usually have one bank, a jail, sheriff's office, livery, one or more doctors, dentists, mechanics/operators, locksmith, saddler, butchers, bakers, carpenters, and similar tradesmen and businesses with 1-6 garages, 12-40 saloons, 2-10 hotels, 2-4 churches, 2-4 school-houses, and 3-6 blacksmiths.

**The Law.** Generally, the law tends to be maintained by an elected or appointed sheriff and his deputies, but can also be enforced by one or more champions (human or not, often empowered with magic), a gang (including outlaws), business tycoon and his men, an influential or powerful family clan, or left to vigilante justice (citizens who gather to right wrongs and defend their town). Some places may have a militia or other *military* type of protector instead of or in addition to a **sheriff**, while others are protected and ruled (openly or secretly) by a powerful rancher, business person or superhuman **being(s)**.

Lawmen are all too often a luxury at most towns, making the West a lawless and violent place. Only about 40% of the small towns (100-600 inhabitants) have a resident sheriff, while 70% of the large towns (typically 700-3000 people) have a sheriff and deputies, or one or more champions/defenders, or a volunteer militia dedicated to keeping the peace. In some cases, a Sheriff or group of official or unofficial lawmen (like Reid's Rangers, the Justice Rangers, and **Cyber-Knights**) patrol a wide territory where they make regular visits (sometimes weekly, monthly or once every several months) to the towns, villages, farms, ranches and outposts to make sure everything is okay and to settle disputes, assign punishments, conduct hangings, and roust criminals. All cities have a Sheriff and a police force.

In addition, the most powerful ranchers, mining companies, landowners and businesses are likely to have their own force of protectors, guards, enforcers, and henchmen; sometimes the equivalent to a private army. Others hire elite mercenaries, gun-fighters, gunslingers, and sorcerers as freelance agents as the situation demands.

**Note:** Players and G.M.s must remember that the majority of the New West is an expansive wilderness, so while one might



encounter a cluster of tiny towns, farms and ranches in a particular region, the next nearest town in any given direction could be hundreds, even thousands of miles away, and have under 200 people. Most are poor communities with little to offer other than a warm meal, a bottle of booze and a place to sleep. At least 50% are populated by D-bees who may not like humans.

**Frontier justice** tends to be harsh and quick — an eye for an eye. So if an outlaw steals or destroys a man's livelihood (crops, horse, cattle, land, water, etc.) the punishment is death. The deliberate cold-blooded murder of an innocent person is also death, although some people and communities *may* allow the brutalizing and slaughter of certain races without punishment. Stealing a man's woman (i.e. kidnapping and/or rape) is usually (not always) a death sentence too. Hangings, firing squads, posse chases, and **gunfights** are common occurrences; in some towns they are daily occurrences.

Armed robbery, theft that doesn't jeopardize one's life or livelihood, breaking and entry, battery, brawling, drunkenness, vandalism, blackmail, confidence games, swindling, and similar things are typically considered (relatively) pretty crimes that can result in a fine (large or small), jail time, a work and restitution program (usually with the culprit spending nights in jail and the day in leg irons while he works), to months or years in jail. Repeat offenders typically see stiffer penalties and longer jail time.

Smuggling, gun running, selling drugs and alcohol, prostitution, and gambling are not crimes in most wilderness towns, although they are usually looked down upon, especially by polite society. Likewise, professions such as smuggler, bounty hunter, gunslinger, gunman, mercenary, card **shark/gambler**, drug dealer and pimp are generally looked upon as being vulgar and undesirable.

Cheating at cards, dice or other games also offers a wide range of punishment, from the cheater getting beaten up and his/her ill-gotten winnings taken away, to being tarred and feathered, to showdowns and shootouts in the street or at the gaming tables.

Most towns and places of business *do not* allow visitors to bring bows and arrows, spears, **polearms**, obvious magical weapons, energy and S.D.C. rifles, shotguns, heavy weapons, power armor, and military vehicles (i.e. tanks, APCs, giant robots, etc.) into their communities or establishments. Such weapons should be left outside of town with a friend, or at the Sheriff's office, or at the door. However, many places allow handguns (revolvers, pistols and derringers), as well as Vibro-Blades, stunners, and conventional knives, small swords, axes, whips, and similar smallish weapons; spears, polearms and large swords are usually not allowed. Places that don't allow handguns can be easily circumvented by concealing the gun on one's person or in a saddlebag or backpack — many towns go by the honor system and do not search visitors.

The penalty for having a "concealed" weapon is typically confiscation of the weapon (returned when the person is leaving town) and a fine that can range for 25 to 500 credits. Using a concealed weapon in the commission of a crime, typically adds 25% to jail time and/or triple the usual fine, plus permanent confiscation of the weapon (which is either added to the town's armory or sold and the proceeds put into the community).

Of course, specific laws, ethics, morals, justice and punishment will change, sometimes radically, from town to town.

Thus, what may be a minor offense at one place, may be a capital offense at another.

**Bandits and outlaws** are commonplace in the New West. These brigands can range from organized gangs of professional criminals and thugs who steal, bully and cheat to earn a living, to groups and gatherings of cowboys and ruffians who *sometimes* stray from the straight and narrow to commit crimes and intimidate those weaker than they. Although the average citizen dislikes, fears and is often victimized by bandits and outlaws, most tolerate their presence and just try to give them a wide berth when they are in town. Gunslingers, **Gunfighters**, smugglers and most mercenary fighters are viewed as troublesome **undesirables**, but a fact of life in the west — some are as bad or worse than bandits.

**The average citizen** is a hard working person used to toiling in the field, hard labor and living in dangerous times. Every person above the age of twelve has at least one weapon proficiency and adults who engage in physically demanding occupations (farmers, miners, **carpenters/builders**, etc.) get an S.D.C. bonus of +2D6 points. Most citizens do not wear body armor most of the time, but most are armed or have quick and easy access to firearms (in a desk drawer, the closet, under the mattress, etc.). Many also have a suit of partial or full environmental body armor to wear in case of an attack leveled against their homestead or community.

**The major threats** to the people of the New West comes from **D-bees**, aliens and monsters from the Rifts! The western wilderness is a haven for various Dimensional Beings, mutants, dinosaurs, alien animals and supernatural monsters. The Xitcix have a presence in the northwest and sometimes scouts and raiding parties venture south. Vampires are a major concern in the south where it is hot and dry, while Brodkil, Simvan, **Psi-Stalkers**, and Indians, among others, can be found in small hunting parties, outlaw gangs, clans and tribes scattered throughout the western wilderness. Demonic entities, the reptilian Tautons, **Loogaroo**, **werebeasts**, Indian spirits, and a host of demons and spirits can be periodically encountered almost anywhere. The deserts are home to many mutations such as the Gwylack, Rad Freaks, and nomadic **Psi-Stalkers**, as well as Indians, bandits, monsters and others.

**Some "ghost towns"** are quite literally that, pre or post Rifts ruins infested with ghostly entities, poltergeists, other entities, ghouls, specters, vampires and similar creatures. They are places known to, and avoided by, local inhabitants, Indians and wilderness scouts. The presence of the supernatural at true ghost towns will be immediately sensed by Dog Boys, Psi-Stalkers, psychics and even ordinary dogs and horses, who will whimper, whine, act frightened and want to leave. Most cowboys have learned to respect the "insight" of their animals and flee such places.

Much of the **animal life** is the same as before the Great Cataclysm, however a large variety of alien animals and otherworldly beasts inhabit the prairies and forests. Some are dinosaur-like, others mammals, and others are monstrosities obviously spawned on some alien world. Among the most famous are the *Ostrosaurus*, *Rhinobuffalo*, *Mammoth Brontodon*, *Tri-Top*, *Moss-Back Scuttler*, *Tree Spider*, *Devil Unicorn*, *Panthera-Tereon*, *Oborus-Slitherer*, *Leatherwings*, *Tigerclaw-Raptors* and *Grigleapers*. Another strange creature of the west is the *Great*

*Dream Snake*. These snakes look like normal rattlesnakes, or sidewinders, but possess very high intelligence and strong magical and psionic powers. Some rumors suggest that these beasts are actually harbingers of good fortune and could be the saviors of man. For this reason many cults of snake worshipers have developed (some of whom also worship the Oborus-Slitherer). All of these alien creatures from the Rifts have changed the ecology and landscape of the American west.

**Native Americans.** Many (not all) "Indians" have returned to the ways of their ancestors, seeing the Great Cataclysm and the return of the ancient gods as a sign to return to the land, magic and old traditions. A variety of Indian tribes and clans can be found throughout the **Americas**. Like the hundreds of other wilderness communities, the laws, beliefs and customs of each Indian nation, and sometimes tribes, can vary dramatically. Some are high-tech and modern, others follow the old ways and use magic, animism and spiritualism, while others are a combination of the two. It is interesting to note that the term "Indian" is as popular on Rifts Earth as ever. This is due, in part, to the post Cataclysm romanticism of all things associated with the American Old West, and the people's (D-bees and humans alike) deliberate attempts to recapture the Old West look and ways. See **Rifts® Spirit West** for information about American Indians, O.C.C.s, magic, fetishes and culture.

**The Cyber-Knights** are modern day knights errant who, like the those of old, wander the New West, Lone Star, Mexico, and parts of South America and Canada, righting wrongs, defending the weak, destroying bandits, slaying monsters, and trying to bring peace and order to the land. In many cases, even the local authorities (sheriffs, militias, judges, tribal leaders, etc.) will defer to the requests, decrees, judgement and retribution of the Cyber-Knights. At worst, most tribal chiefs, kings, leaders and lawmen will at least *listen* to, and weigh the **Cyber-Knight's** words. This has led critics (mostly outlaws and scoundrels) to accuse the Cyber-Knights of being above the law, which, in all practicality, they are, in many cases. However, these (mostly) noble knights rarely interfere with the rule, laws and affairs of towns, commerce and kingdoms. According to many rumors and legends, the Cyber-Knights are believed to be headquartered somewhere in the northwestern wilderness — most suggest the Rocky Mountains of Wyoming or Montana, although nobody seems to know for certain, and many believe there are more than one training **camp/headquarters** for these heroic knights.

**Reid's Rangers** is a famous group of heroes known for slaying vampires, as well as acting as lawmen and protectors of the weak, downtrodden and innocent, especially from supernatural menaces and the CS. Doc Reid and his original Rangers are mythic heroes — **living legends** — so most towns will welcome any of Reid's Rangers with open arms. However, some rumors have begun to circulate that suggest Doc Reid is a little bit crazy and some Rangers are corrupt (Note: The vast majority *are* heroes). Members of Reid's Rangers, estimated to number between 2000 and 4000, are usually encountered in the Southwest: *Arizona*, *New Mexico*, *Lone Star* and *Mexico*, but 1-6 are occasionally found further north. See **Rifts® World Book One: Vampire Kingdoms™** for more information about Doc Reid, his Rangers, traveling shows, vampires, the vampire kingdoms of Mexico, key places and the Yucatan.

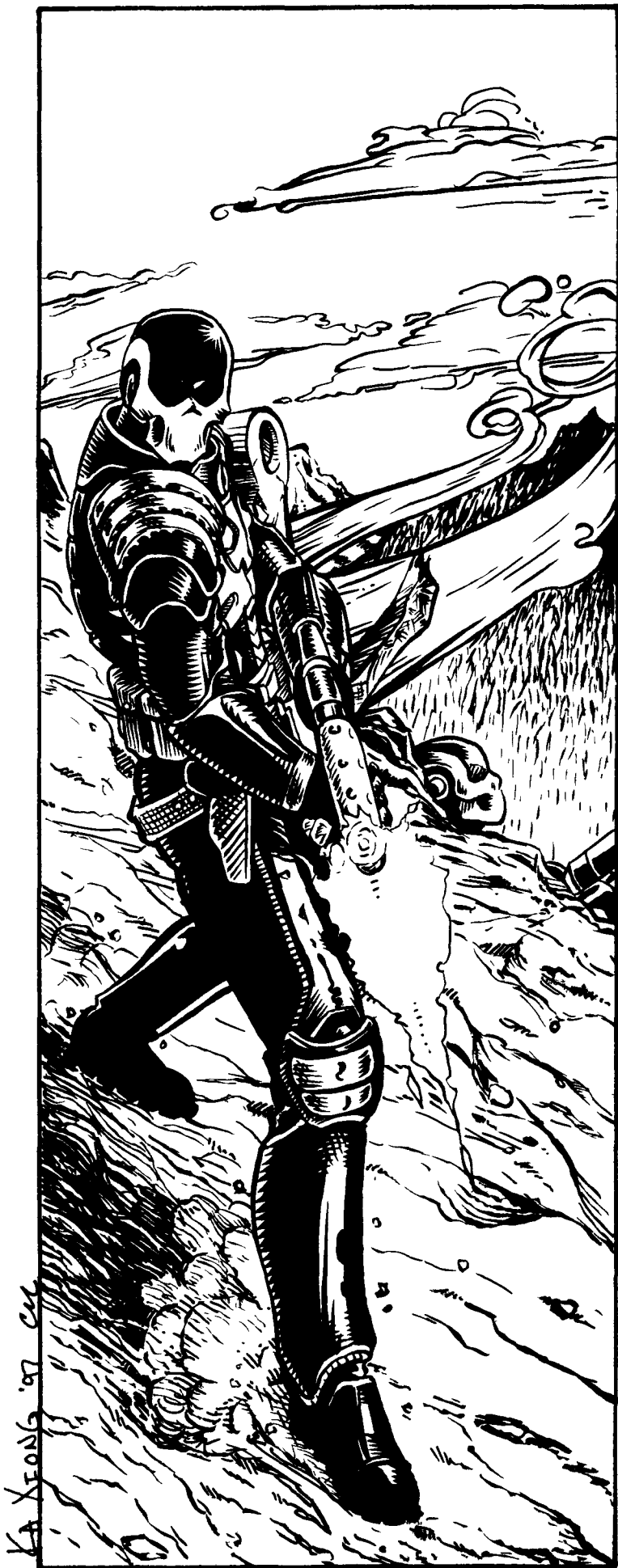

**The Coalition States & the New West.** The West is a wilderness — some would say, a wasteland — of shifting dimensions, roaming monsters, D-bees, magic, mysticism, Indians, spirits and expansive, open, hostile land. Although the Coalition States continues to send Expeditionary Forces, Reconnaissance teams, Vendetta squads, Skelebot destroyers, and spies into the Western Wilderness, they consider the western half of the Old American Empire (and much of the Canadian Empire in the North) to be a hostile and forbidding territory not fit for human habitation. Thus, the Coalition's present plans for continental expansion and conquest ends along the borders of *Minnesota, Iowa, Kansas* and *Oklahoma*. In truth, the CS has limited resources and couldn't possibly conquer and maintain control over such a vast region. Even their current plans are ambitious and will take generations to accomplish. The CS intends to conquer and dominate the Midwest and then turn their efforts to the eastern portions of what was once the old American Empire and north to the Provinces of Manitoba, Ontario, Quebec, New Brunswick and Nova Scotia in the old Canadian Empire. This has led many D-bees, mutants, refugees, freethinkers, scholars, mercenaries, outlaws and anarchists to regard the great wilderness of Western America and southwestern Canada as a potential haven, homeland, hideout, or base of operation. However, only 41% of all settlers manage to survive more than a year or two in this harsh and hostile environment. The remaining 59% either perish or return to from whence they came.

That having been said, the CS does have a sinister and shadowy presence in the New West. Spies, informers and Vendetta Squads can be found operating in many of the towns, fledgling kingdoms, and among gangs of smugglers and bandits. Expeditionary Forces (CS scientists and explorers) and reconnaissance teams, usually numbering 8-20 troops, can be encountered in the wilderness, and are often hostile. Skelebots, Kill Hounds, Kill Cats and other mutants, agents and "death squads" are sent into the Western Territory on missions of murder and destruction (can range from one or two individuals to squads of 6-12). Often these forces have but one goal, to kill or hurt the enemy — which is virtually all nonhumans, practitioners of magic, supernatural beings and people who have rejected life in the Coalition States. Furthermore, the CS often hires Psi-Stalkers, mercenaries, bounty hunters, spies and assassins to hunt down wanted criminals, runaway mutants, and refugees to be destroyed or brought back to the CS for trial and punishment.

Comparatively large military operations (CS platoon to a company of troops) are reserved for surgical strikes against mercenaries, bandits, smugglers, adventurers, rogue scholars, scientists, and Black Market bases, strongholds and troops that fuel illegal activities in the Coalition States, or have, or are feared of having, an impact or influence on CS citizens. Likewise, military bases (Juicers, Cyber-Knights, Black Market, etc.) that the CS considers to be a threat, will be attacked and destroyed (sometimes with the troops disguised as something other than the CS). CS authorities are often satisfied with disrupting enemy operations, the capture of contraband, and sending the rabble-rousers scattering than total decimation.

**Note:** The emptiness, lawlessness and violence of the west has changed little in the past 200 years, and in many ways, harkens back to the Dark Ages that followed the Great Cataclysm.



---

## Some Common Slang and Expressions in the New West

---

**Backstabber or Backshooter:** Somebody who is known to betray friends, colleagues and employers, or somebody who literally shoots his opponents/rivals/enemies in the back without warning. This desperado is considered the worse kind of scum, second only to a man who would cheat in a showdown.

**Bushwacker:** A brigand who attacks from a place of concealment; an ambusher who uses the elements of surprise and concealment.

**Called Out:** Being challenged to a showdown/duel.

**Cold Blooded Killer:** A character who kills without giving his opponent/rival/adversary a *fair* chance to fight back. To "kill in cold blood" is to attack and kill without giving one's would-be opponent a fair chance to draw. While this is considered ruthless and unfair, it is not the same or as bad as shooting somebody in the back or cheating in a showdown.

**Cowpoke:** A cowboy, rancher or somebody who works with cattle.

**Desperado:** A general term for somebody on the run from the law, typically a bandit, highwayman or fugitive.

**Draw:** Pull your guns and shoot.

**Drifter:** A general term for anybody who is just passing through without friends, relatives, business or specific reason for being in the area — a character who, for the moment, has no specific goals, direction or purpose, and is simply wandering, or "drifting," from place to place and job to job. "Drifter" often refers to vagabonds, bums and Saddle Tramps.

**Green Horn or Tender Foot:** Somebody new to the ways of the West and/or who is young and inexperienced.

**Homesteader:** Settlers from other parts of the world (sometimes from other worlds) who make their homes in the western wilderness; also known as "nesters."

**Lawman:** Generally any O.C.C. or individual who is officially recognized or elected as an officer of the law, and who fights to uphold the peace, enforce the law and defend the innocent. Lawmen O.C.C.s include the Sheriff, Sheriff deputies, Justice Rangers and **Cyber-Knights**. Note that not all towns have a sheriff or champion to defend them. In other cases, a lawman may travel a circuit of towns, ranches, farms and homesteads, checking on each every few weeks. This means the nearest law enforcer could be 1-4 day ride away, and is another reason townsfolk may feel it necessary to take the law into their own hands.

**Lynching:** Law and justice in the New West often comes at the end of a rope. **Lynchings/hangings** are commonplace, performed by lawmen, vigilantes and lynch mobs. Drunkenness, banditry, cattle rustling, and violence plague the majority of western towns, often provoking frightened or intolerant citizens to take the law into their own hands. Also see Posse.

**Outlaw:** A general term for any criminal on the run or free from justice.

**Pistols:** In the simplest terms, the main differences between an *automatic pistol* and a revolver is that the pistol will fire

"automatically" as long as the trigger is depressed (until all rounds are spent), can fire short bursts, and has a larger payload/clip (typically 8-15 rounds). However, the revolver has a smoother trigger action and better accuracy (important for sharp-shooting and quick-draw showdowns), which makes it, not the pistol, the most popular weapon in the New West.

An obsessive love for the tradition and the styling/appearance of the classic "six-shooter" and other pre-Rifts Cowboy and Old West weapons, clothing and designs also plays a huge part in the revolver's immense popularity in the Western Wilderness. This has even led to *energy weapons* (lasers, ion blasters, plasma ejectors, particle beam weapons) and magical energy weapons to be made to look like Old West revolvers, derringers, and rifles. High-Tech looking energy pistols and rifles are also common and popular.

**Polecat:** A skunk, or treacherous individual without honor or respect for "The Code."

**Posse:** A posse could be a gathering of men (seldom included women) who serve as *temporary deputies* of the law (i.e. temporary assistants) to help hunt down and bring to (often bloody) justice one or more known criminals — from horse thieves and cattle rustlers to robbers, rapists, arsonists, and murderers. The men of the posse often work with, or under, the direction of the sheriff and his regular deputies, or a **Cyber-Knight**, or whatever passes for the law in that area. However, more often than not, a posse consists of angry citizens banded together as *vigilantes* who track down the culprits they believe responsible for the crime (16% error factor) and deliver justice at the end of a rope. Often their motives are good and just, but high emotions and bloodlust often turn these vigilantes into a lynch mob who hangs those they capture from the nearest tree.

**Quick Draw:** Also known as the "fast draw." The art of pulling a handgun out of its holster, aimed and ready to shoot, with one, amazingly quick, fluid motion.

**Remi or Wilk's-Remi:** Slang for a line of **Wilk's** laser weapons styled to look like old fashion, Remington revolvers and rifles, although they are actually advanced laser weapons; very popular.

**Revolver (the favorite of the New West):** The double-action or self-loading revolver is a handgun design introduced by the Colt Company around 1830. All double-action (modern) revolvers enable the shooter to cock the hammer and rotate the cylinder simultaneously, and then release the hammer with one trigger pull. Most types can also be thumb-locked. If a shell should jam or dud, the operator only needs to pull the trigger to rotate the cylinder to the next shell. Large caliber revolvers can usually fire a variety of similar sized/caliber bullet loads with no appreciable difference. **Note:** Each pull of the trigger counts as a melee **attack/melee** action. It takes a half to a full melee round (4-5 melee actions) to reload by hand, one action to reload a single bullet, or two melee actions when using a quick-loader.

**Rustler:** An outlaw who steals cattle, horses and other livestock.

**Scalawag:** A troublemaker, rascal and morally unprincipled person. Drifters, bums, con artists, Snake-oil salesmen, performers in travelling shows and Saddle Tramps are all generally considered to be "scalawags."

**Shooting Irons:** A slang term for most types of revolvers; often includes pistols too.

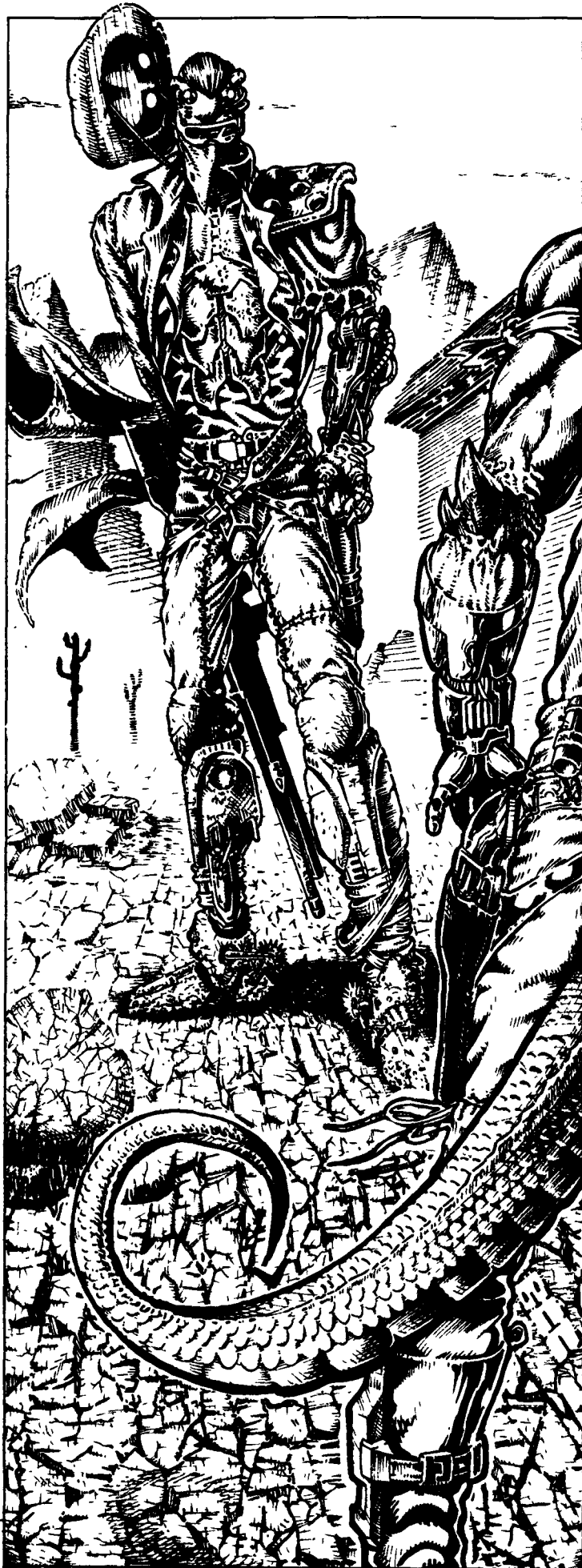

**Shootout:** A gunfight between two or more gunmen, bandits, etc.; often between gangs and groups. Not to be confused with a "showdown."

**Showdown:** A duel to the death, usually at close range with revolvers or pistols.

**Sidewinder:** Another name for rattlesnakes. When used to describe a humanoid, it means that person is treacherous and dangerous. Calling somebody a "snake in the grass" means that person is untrustworthy, sneaky and/or a betrayer. Calling somebody a "low-down snake" usually means they are dishonorable, a liar and a cheat.

**Six-Shooter:** Generally speaking, any revolver. On Rifts Earth, that includes magical, Techno-Wizard revolvers.

**Sodbuster:** Farmers who plow or "bust" up the land to plant crops.

**Snake-Oil Salesman or Snake-Oil Doctor:** Generally refers to con artists and swindlers, whom are commonly part of travelling shows.

**Spitting:** Spitting at someone's feet is a sign of disrespect and/or dislike. Depending on the situation and people involved, spitting on someone's shoe or boot is a sign of disrespect and a slap in the face, or fearlessness ("I ain't afraid of you" without the words being spoken). It can lead to a fist fight, shootout or showdown. Spitting in someone's face is the absolute insult, indicating complete contempt and is often an invitation to a showdown. Spitting often accompanies insults and being "called out."

**Tender Foot, Tin Horn, or Green Horn:** Somebody new to the ways of the West and/or who is young and inexperienced.

**Tycoon:** A wealthy individual who typically has made his fortune in business (legal and illegal), mining, or ranching. Tycoons are usually powerful and influential in their communities and are sometimes the unofficial ruler or leader of a town, or a despot who uses his wealth and the power it brings to do whatever he (or she) desires. A tycoon can be a recluse, or philanthropist, or a good-hearted community leader, or a bully and a villain.

**Yellow-Belly Coward:** Pretty much like it sounds, a character known for one or more acts of cowardice.

---

## The Trouble with Credits

By Kevin Siembieda

---

The currency of the modern, civilized world of Rifts Earth is "credits" — electronic money kept and accounted for by a sophisticated, computerized banking system. Credits can be wire transferred at most CS cities, towns, burbs and outposts, or encoded on "debit cards," small sturdy, plastic cards very similar to pre-Rifts credit cards or telephone cards. Each time the "debit" card is used, the appropriate amount of *credits* is deducted from the card. When all the credits are used up, the card can be thrown away or saved and taken to an appropriate banking institution, money lender, or merchant to have credits in a savings account transferred onto the card for future use. Similarly, many businesses, banks, money lenders and even the Black Market and some travelling merchants can place additional credits into the card by transferring real and existing funds from their account into the card. This can be done as a loan, to

make payments to an employee, to pay a bounty, and commonly when the bank, business or merchant *purchases* goods (gold, silver, furs, guns, magic items, ancient artifacts, etc.).

The government of the Coalition States (representing 73% of all trade on the continent) is the one responsible for creating this system of money exchange and accounting. It prevents counterfeiting and enables the government (who controls the banking) to monitor the flow of money and commerce. For this reason, the Black Market, arms dealers, smugglers and many operating in the sale and purchase of illegal goods and services prefer to "trade" goods for goods rather than issue "credits" as an effective way to pay and trade people "under the table."

"Universal Credits" are the most common and popular form of credits instituted by the Coalition States. Universals credits are good with all merchants, businesses and banks throughout the Coalition States, as well as in the *New German Republic* and many independent kingdoms, nations and businesses including *Northern Gun*, *the Manistique Imperium*, *Wellington Industries*, *Wilk's*, *Iron Heart Armaments*, *Golden Age Weaponsmiths*, *Free Quebec*, *Whykin*, *Lazlo*, *NewLazlo*, and most Midwest and eastern communities, including the *Black Market* (although front companies and cover identities are necessary for the latter). Most mercenaries, adventurers, bandits and people of North America will accept Universal Credits as a viable currency! Universal Credits is the main currency of North America.

Since the Coalition States are strong and stable, there is little danger of the credits becoming devalued or of the banks going out of business. Furthermore, because the system is based on "redeemable" Universal Credits typically available to the "bearer" of the card, it is safe to put thousands, even millions of credits on one or more cards and use the money/credits freely, just about anywhere, without question. In this regard, the CS is unbelievably tolerant in its dealings with questionable businesses. For this system of banking and money exchange to collapse, the Coalition States would have to completely change its banking and monetary system (a monumental and disruptive task), or be destroyed. Ironically, this creates a subtle and bizarre interdependence and symbiotic relationship with both the supporters and enemies of the States!

"Marked" or "Personalized" debit cards in which the funds are available only to one or two specific individuals can also be issued, but each transaction with that card will be recorded, identifying the user, what he or she purchased, and where, giving the Coalition watchdogs potentially incriminating information.

Some independent nations, kingdoms, organizations (like the Black Market) and businesses with numerous outlets throughout the land issue their *own* form of "credits" on debit cards via an independent banking institution. Individuals who despise the Coalition may elect to use these instead of the CS Universal Credits. Likewise, citizens and supporters of that community or institution may also prefer to use their own credit system, however there are problems with this. First, the security of the credits is based entirely on the stability of the kingdom or organization that issued them. Obviously, such places are much more unstable and vulnerable to disaster than the CS. Second, since the CS will not recognize most other nations and never accepts *foreign* credits, these money cards have an extremely limited value. In many cases these independent debit cards are only accepted in the kingdom that issued them and worthless everywhere else

(and another reason the CS Universal Credits are so popular).

Lazlo and New Lazlo, Tolkeen, and a handful of other independent kingdoms and cities have their own form of "credit" system, but only the joint efforts of **Northern Gun** and the **Manistique Imperium** have managed to establish a banking and credits/debit system that is accepted and used at many locations throughout the country. Typically, any seller of Northern Gun (NG) and Imperium (MI) weapons and equipment (both using the same credits system and debit cards) will usually accept NGMI debit cards redeemable for credits that can be used at these Upper Michigan kingdoms and with all NG and MI "authorized" gun shops, merchants and traders, as well as most 'Burbs. Furthermore, a handful of other independent towns, cities, merchants and traveling shows use or accept NGMI cards, including Silvereno, Bandito Arms, Lazlo, New Lazlo, Kingsdale, Ciudad Juarez, and scattered towns in the Pecos Empire, Lone Star, New West and Magic Zone.

The third credits/debit system to rival the NGMI and challenge the CS Universal Credits is that of the **Black Market**. Their debit card is a simple, encoded *black* plastic card. It is good at virtually *all* Black Market operations scattered throughout the world, including the Coalition States, and accepted by all official Black Market agents, operatives and freelancers, as well as by most Juicers, Crazyes, Gunslingers, Bounty Hunters, mercenaries, spies, smugglers, bandits and criminals of all kind. *Black Credits*, as this illegal, underground system of banking and debit cards are known, is welcome at Coalition Burbs, most Body-Chop-Shops, the Pecos Empire, Bandito Arms, and many (not all) merchants and businesses at Tolkeen, New Lazlo, Whykin, Kingsdale, Free Quebec, Lone Star and scattered towns in the New West.

## Trade of Goods & Services

**The problem with the New West** is that it is a vast, hostile wilderness with hundreds of splintered, unrelated communities, most of them tiny, scattered throughout the western *HALF* of the United States and Southwest Canada. Most don't have any ties to larger kingdoms, don't have any type of formal banking, are uncivilized, lawless, unstable, and low-tech (compared to the CS, Tolkeen, and even the Pecos Empire). Unless a merchant is an official agent, or authorized seller of goods from the Black Market, Northern Gun, or Manistique Imperium, most merchants and businesses won't take any kind of credits, not even Universal Credits.

What happens when you don't have credits, or the town doesn't take them? Well you might pay for a meal by chopping wood, digging a ditch, fixing a fence, plowing a field, pitching hay (or manure), etc. Wanna buy that recently broken mare? No problem, just hand over that extra E-clip or energy pistol, language translator, or pouch of gold dust.

A full 88% of all purchases in the New West is done through barter — the trade of goods or services, for goods or services. Many towns have what they call a bank, but is really a trading post where one can sell or trade items for the local currency (coins, paper, checks, credits), or provides a voucher for the traded/purchased goods. The Voucher effectively works as a note or check, from which expenses and purchases are deducted and collected from the bank. Common items used in trade includes animal furs, cattle, horses, other livestock, booze, weapons, E-clips, ammunition, explosives, M.D.C. armor, batteries,

generators, vehicles, electronics, parts, tools, clothing or bolts of fabric, precious stones and ores, land, jewelry, and a host of other things. Services that always seem to be in demand are work as body guards, enforcers/thugs, lawmen, doctors, mechanics/operators, and laborers.

Unskilled labor tends to get paid about half of what it's really worth. This is because there are always a large number of unskilled or desperate people looking for work. Similarly, there are a lot of scouts, cowboys, fighters, and gunmen, so pay is typically low (again about half what the job is really worth), unless

the character(s) are high level (7th+) and/or have a reputation. However, even then, depending on the circumstance and the wealth of the town, pay will vary from excellent to substandard. Those who get the best pay are doctors/healers and operators/mechanics, but pay is usually room and board (for doctors and operators this might include their own house, a servant and an office all free of charge), being lent many (not all) of the basic items and tools needed for the job, and a modest salary in *loca* (i.e. that particular town's) currency, or silver or gold.

---

# New West Overview of Territories

---

## The Western Territories

The majority of the New West is wilderness, from expansive prairies and forest to mountains and deserts of stone, cactus and scrub, to deserts of shifting sand. Native American Indians, and humans in general, can be found virtually throughout the Western Wilderness, from individuals and adventuring groups to small clans, tribes and towns. What was once the States of the old American Empire are generally known as "territories" (i.e. the Wyoming Territory, Colorado Territory, etc.), or lumped together collectively as the Western Wilderness, Western Territories or "New West."

**What about Canada?:** The Coalition States and most Easterners do *not* include *southwestern Canada* as part of the American Western Wilderness, i.e. the New West. These monster infested wilderness lands are considered part of the old Canadian Empire and generally known as the Canadian Territories. However, many of the people (human and D-bee) who live in the American West and Canadian Southwest, *do* consider Southwestern Canada as part of the New West. Thus, those inclined to do so consider the Canadian Provinces of *British Columbia*, *Alberta*, and *Saskatchewan* part of the New West. Remember, many of the old borders and sense of nationality have been obliterated, so there really is no USA/America or Canada, and the people of the Western Wilderness don't consider themselves American, Canadian, Coalition or anything else. They are simply pioneers in a bold new world, collectively called the New West or Western Wilderness.

**What About Mexico?:** Like Canada, Mexico is generally not considered part of the New West, but a separate country. Most of northern Mexico is a wasteland, and the entire country is dominated by vampires. See **Rifts® World Book One: Vampire Kingdoms™**.

**Designer's Note:** After adding an extra 64 pages to this book and deciding to shorten a few sections, I find it is absolutely impossible to provide the descriptions of the various States or Territories as I had planned. Of course, this book provides a ton of information and (I hope) a solid basis for all kinds of adventures and fun in the New West. **Rifts® Spirit West** will also fill in some holes with more world data, information, magic, Native American People and ancient gods. Future sourcebooks and adventures will also flesh out the New West. The following sec-



tions cover the New West in general and makes special note of some key places and regions. Enjoy.

### Some Terms of Note

**Butte:** A hill or rocky outcropping that rises abruptly above the surrounding area and has sloping sides and a flat top.

**Canyon:** A long, often deep chasm with steep cliff walls formed by running water. The Grand Canyon is the largest canyon in the world.

**Deserts:** The American West has three types of deserts. Stony deserts: Parched earth and tiny stones, sometimes packed so

closely together that it forms a sort of desert pavement. This type of desert is found in *Lone Star*, *New Mexico*, parts of *Arizona* and *Nevada*. Rock deserts: Bedrock that has been eroded from millions of years of water, rain and wind to create canyons, gorges, buttes, and pillars of stone. Rock deserts are found in *northern Arizona* (the Grand Canyon, etc.) and *Utah*. Sand desert: An area covered completely by sand that shifts and moves with the wind. Note that deserts, especially stony ones, are far from "dead" zones, and are actually filled with specialized plant life like cactus and small mammals, lizards, and birds — among others.

**Gorge:** A deep, (comparatively) narrow passage with steep rocky sides, enclosed between mountains — usually formed by a river or river valley.

**Mesa:** A flat top elevation with one or more cliff-like sides.

**Plateau:** An elevated but comparatively flat or level expanse of land.

**Prairie:** An extensive expanse of flat or gently rolling grassland — much of Central North America.

**Sagebrush:** A pungent, sweet-smelling, flowering bush that has adapted to arid climates and is eaten by deer, antelope, grouse and other animals. It can be found at the lowest desert altitudes and canyons of Arizona, Utah, New Mexico and Mexico to 10,000 foot (3050 m) mountain ranges. It grows in greater abundance in Wyoming than anywhere else in the West.

**Summit:** The highest point/peak or top of a mountain; also known as a peak, mountain pinnacle or zenith.

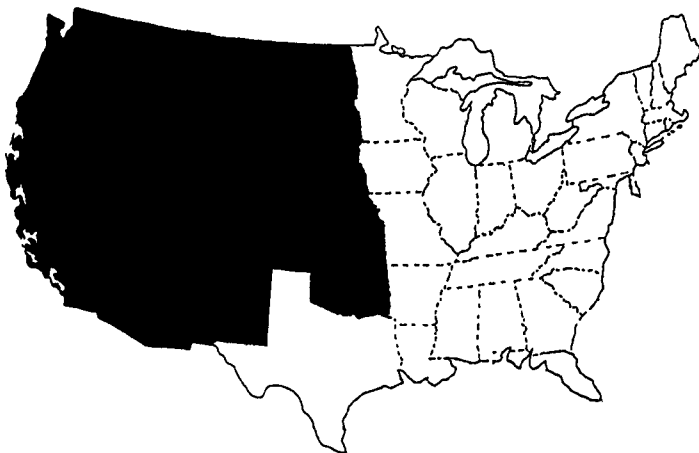

## Synopsis of the New West Territories

**Arizona:** The vast stony desert, majestic canyons, and light forests scattered along the mountains and waterways of Arizona are largely uninhabited and uncivilized. Although the home to small, scattered tribes of *Navajo*, *Hopi* and nomadic *Apache* as well as Simvan, Fennodi, Cactus People and a handful of others, there is probably less than 200,000 people throughout the entire territory. Instead, Arizona has become the home to predatory monsters and dinosaurs. The mammoth *Leatherwings* fill the sky and search the ground for prey, giant worms sun themselves in the canyons, and the dreaded Worm Wraiths ride on to sate their lust for blood. It is a hard, desolate land of subtle beauty and power. Among its champions are the Sky-Knights, Reid's Rangers and Cyber-Knights, the only law for a thousand miles!

**California:** Largely a wilderness with dramatically different regions, from lush forests and subtropical zones to high moun-

tains, plains and terrible deserts (Death Valley is located in the southeast near Nevada). Most of the cities throughout the region were completely obliterated by earthquakes, floods, tidal waves, fires, storms and some of the most devastating plagues to hit the continent. There are pockets of civilization.

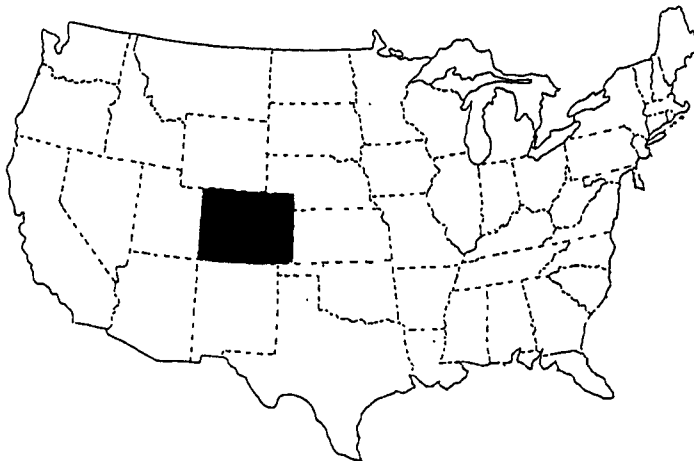

**Colorado:** This territory is another land of mountains (the Rocky Mountains), hills, forests and plains. The Rocky Mountains (and the Continental Divide) practically cut the Territory in half. The northeastern section, home of the *Colorado Baronies*, is predominantly lush prairies ideal for raising livestock (horses, cattle, sheep, etc.) and farming. The southeast is more flat prairies, but rugged scrub prairies with grass being replaced by sagebrush, yucca and pinon and juniper trees (it looks a lot like New Mexico). Although predominantly wilderness, it is one of the territories with clusters of towns and even cities and is one of the places most visited by *Cyber-Knights*.

In many respects, Colorado is the epitome of what most people think of when they think of the New West. Much of it is a wild and untamed land filled with danger in the way of outlaws and monsters. Yet at the same time, it is a land of opportunity, rapid change and a comparatively booming land of settlements, ranches and civilization. That having been said, the entire population of Colorado is probably less than 500,000 and as lawless, violent, wild and woolly as they come.

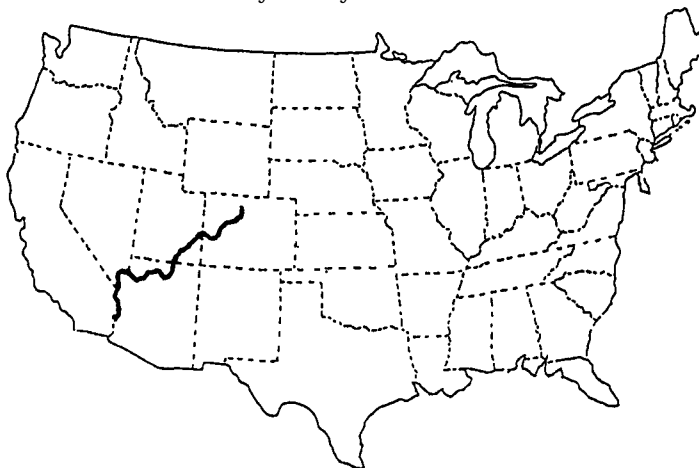

**The Colorado River:** Along the entire length of the Colorado River are spectacular canyons and rock formations caused by millions of years of erosion from water, rain and wind. The Colorado River snakes its way through the States once known as **Colorado, Utah and Arizona**, and includes the *Colorado Plateau* in northern Arizona, the *Grand Canyon* (Arizona), *Chao*



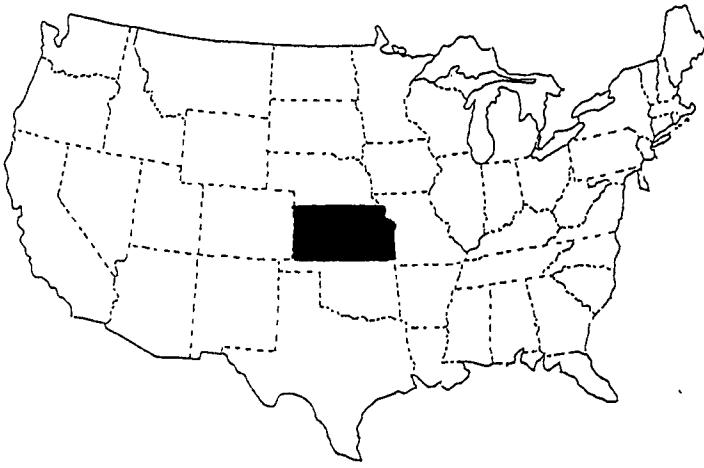

**Kansas:** The northwestern part of this region is an uninhabited wilderness, wild and dangerous — a blend of light forests and vast grassy plains. The eastern third is one of the more civilized, populated and with advanced Territories in the west. It has a number of farms, ranches, law-abiding towns, and several fledgling kingdoms, but it is the Comanche Preserve (the second largest on the continent) that serves as the anchor and leader to these free and peaceful communities. The Comanche of Kansas welcome all peaceful people, including D-bees and practitioners of magic, and govern their lands with compassion and strength. In addition, Cyber-Knights visit the Territory regularly, as do cowboys, traders and adventurers.

Sadly, the current peace and prosperity of Kansas seems destined to be eradicated through violence as the CS plans to seize the Territory as a New Coalition State over the next 20-30 years. Coalition troops, spies, Vendetta Squads and Skelebots (Seek and Destroy squads) have an ever increasing presence. Several new military outposts are under construction in Missouri only a few miles from the Kansas border, and political maneuvering has already pegged the Territory as a dangerous haven for D-bees and undesirables.

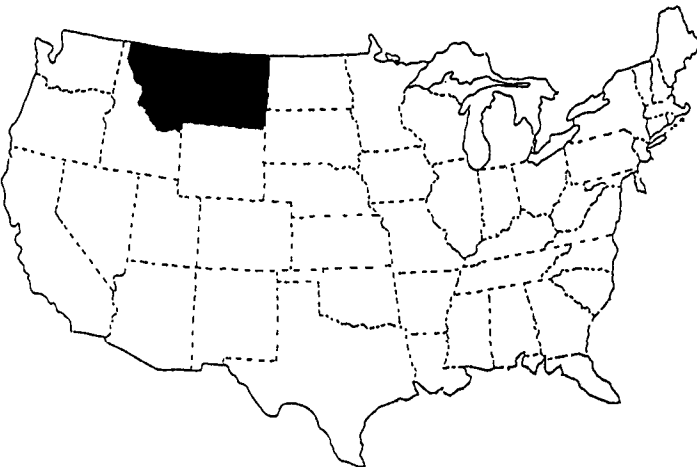

**Montana:** Home to the *Black Feet* (hostile and war-like), *Sioux* and *Shoshone* Nations. The western half of the Montana Territory is a *Magic Zone* rife with ley lines and supernatural activity. *Justice Rangers* and *Cyber-Knights* patrol this Territory.

Montana is mostly an uninhabited expanse of wilderness with shortgrass prairies in the east, scrub, sagebrush and grass prairies in the northeast with scattered forest areas of willow trees, cedar and pine in valleys and along waterways. The Rocky Mountains and coniferous forest wilderness dominate the western half. The

west is also the half crisscrossed with ley lines and infested with inhuman (often supernatural) invaders.

**Nebraska:** The Nebraska Territory is a combination grassy plains, forested wilderness and mountains. Except for tiny, scattered pockets of people, it is largely uninhabited. Its most notable feature in the New West is that it is the center of operations for the 1st Cavalry at Fort Prospect.

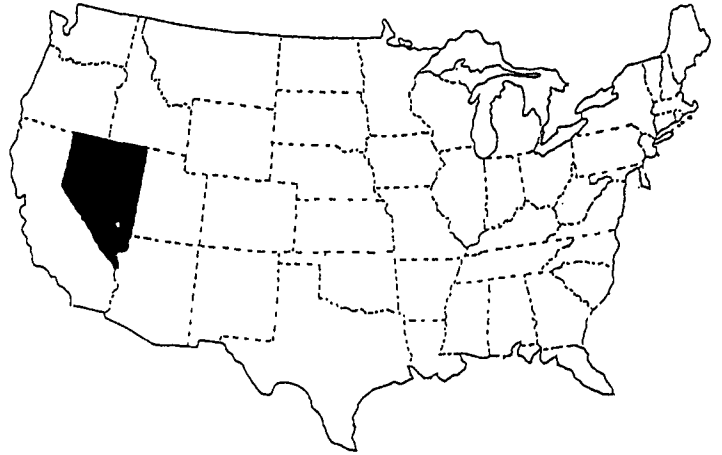

**Nevada (parched earth):** This territory is entirely a vast desert dotted with the ruins of pre-Cataclysm cities and lost civilizations. The southern portion is the sandy Mojave Desert, but 85% of Nevada is the Great Desert Basin, a flat, arid land with cactus, short Joshua trees (15-30 ft/4.6-9 m tall) and sagebrush —lots of sagebrush. This inhospitable terrain is broken by mountains and the occasional river, along them are scattered forests. The steel and concrete remnants of a bygone era attracts squatters, nomads, bandits on the run and animals, but few permanent inhabitants. It also attracts treasure hunters in search of valuable pre-Rifts artifacts, although much has already been plundered over the centuries and those that have not are said to be haunted.

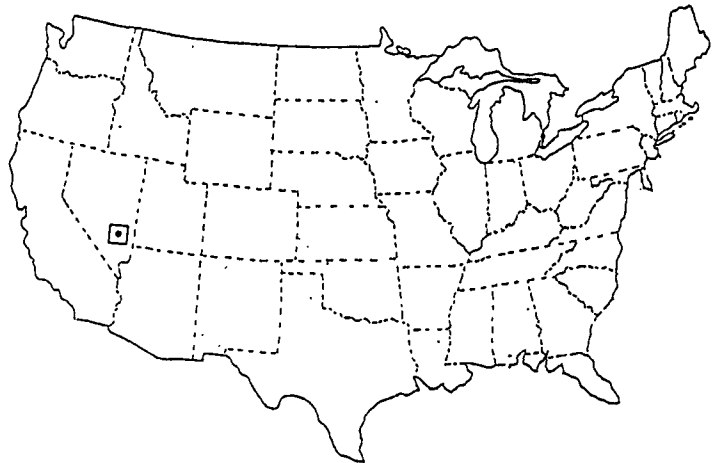

**Bandito Arms: The Legacy of Area 51:** Located in South-eastern Nevada, about 100 miles north of the ruins of Los Vegas is the mysterious American Air Force testing ground once known as *Area 51* and *Groom Lake* (a.k.a. S-4). Around 32 P.A., the Black Market learned about Area 51 from old pre-Rifts television shows and documentaries, and decided to see if it really existed. To their surprise, the ancient military base was mostly intact and hardly looted at all (they were certain the CS or scavengers would have plundered it long ago). Here they found 11 underground hangars with tunnel-like inclines for entering and

exiting them. These hangars are camouflaged and invisible from the sky, unless the hangar doors are open. They also discovered secret tunnels under the lake to release SAMAS style power armor defenders and experimental aircraft. Area 51 also gave them 48 Glitter Boys, SAMAS prototypes and their schematics, various weapons and vehicles, and tremendous insight to the American Empire's Military and history. Best of all, the facility had a small factory that could build four SAMAS-like power armors a month, a dozen hangars with repair and maintenance facilities, two dozen garages, storage facilities, research and development facilities, an armory, six underground bunkers with mini-missile defenses, communications network and troop facilities for an entire army (actually 22,000 troops) — most of which was in good to excellent condition. The Black Market moved in and made itself right at home.

Although this remote desert location is far from the Black Market's main territory of exploitation in the Midwest and East, they decided to make Area 51 the headquarters and chief manufacturing plant for their munitions branch, *Bandito Arms*. Even the Coalition Military would have trouble blasting them out of this underground, ultra-high-tech military compound; that is, if the CS could find them in the first place.

Tons of materials were trucked, flown and magically brought in — nobody hardly noticed as they made their trek through the uninhabited wilderness. Several new factories were built along with other facilities to make Bandito Arms Central all that it could be. This is the most strongly defended and high-tech Black Market base in the entire West. The CS knows it exists somewhere in Nevada or Utah, but doesn't have the exact coordinates and doesn't really care. The Coalition has no idea how expansive or powerful this complex really is. The Black Market looks at this facility as their western office and a fabulous fallback complex where they can dig in if they should ever need to do so. 11,000 workers, techs, agents and defenders live and work at Area 51. To avoid giving away their location, few people live on the surface and the nearest town is 150 miles (240 km) away. **Note:** Also see the section on Bandito Arms Weapons & Equipment. Oh, Bandito Arms also plundered *Nellis Air Force Base*, near Los Vegas, and have a small, secret base located among the ruins there as well (500 agents).

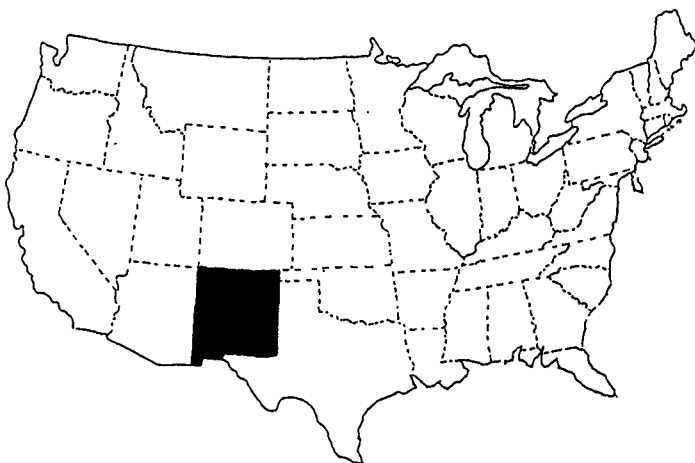

**New Mexico:** The western portion of New Mexico is dominated by the Rocky Mountains. The northwest is desolate badlands with tall, red cliffs, canyons and stony desert with cactus, scrub and sagebrush. Much of New Mexico is stony desert and scrub similar to the plains of Arizona, with patches of green and

light forests along waterways and in the mountains. The southern portion is plagued by vampires. Reid's Rangers, Cyber-Knights, Simvan, Fennodi and Indians are among the notable inhabitants and visitors to the territory.

White Sands Army Missile Range was destroyed in a nuclear holocaust during the Great Cataclysm and is nothing more than a radioactive crater.

**Oklahoma:** Is a vast, mostly unpopulated, wilderness of prairies and scattered forests.

**Oregon:** A wilderness of mountains, rocks, hills, forest and prairie; largely uninhabited. Covered in more detail in *Rifts@ World Book 15: Spirit West*.

**Rocky Mountains:** The Rocky Mountain *chain* runs south from New Mexico up through *Colorado* (where it divides the Territory in half), *Wyoming, Idaho, Montana*, and into *British Columbia*.

**Texas/Lone Star (included for continuity):** Cyber-Knights, Apache, Psi-Stalkers, Simvan, and the bandit nation known as the Pecos Empire (gangs of outlaws the size of barbarian hordes). It is also the site of Coalition operations in the north.

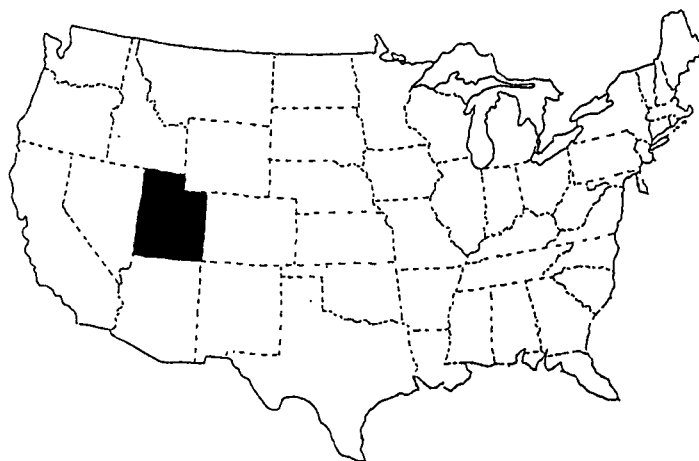

**Utah (the land of Stone & Canyons):** A land of alien looking rock formations, canyons, buttes, plateaus, mountains, desert and the occasional plains and thin forest. The empty ruins of pre-Rifts cities dot the landscape like ghosts from the past. This often lures prospectors and archaeologists who collect and sell ancient artifacts into this desolate land; however, there are few permanent settlements. Utah is largely uninhabited except by otherworldly monsters and alien plant-life. It is one of the regions said to be patrolled by the Cyber-Knights (to keep it free of vampires and other monstrosities). The Knights represent the only law and protection the few settlers and human scavengers in this land have.

*Monument Valley* (Utah), formed on the banks of the Colorado River, is believed to be inhabited by spirits and demons.

*Agathla Peak*, also known as El Capitan, is formed out of unusually tough rock formed out of the magma of an ancient volcano. According to legend, an ancient god made the mountain rise and float in the air where it remained for 50 years, until his death. The legend also claims that under the peak are portals to an alien subterranean world (worlds?).

**Indians:** Southern Utah: Navaho and the occasional Apache nomad; Eastern Utah: Ute.



### Lost Treasures of Utah:

Ancient legends of lost treasures abound in Utah. The following are among the most notable of the pre-Rifts accounts.

**Montezuma's Lost treasure:** According to legend, the leader of the ancient Aztecs stripped his temples and buildings of all precious metal and gems and sent them north rather than let them fall into the hands of invading Spaniards (Cortes and his troops). Although there are (or at least, were, in pre-Rifts times) many variations of the story, most suggest that the treasure was hidden in a *canyon* (Utah has plenty). Some legends suggest that this canyon is somewhere in Arizona, while others hint at New Mexico and many point to *Utah*. One places it near **Kanab**. Estimated value in today's Post Cataclysm market: 1.2 billion credits!! Maybe more!

**Maximillian's Millions:** Emperor **Maximillian** of Mexico had 45 barrels of gold, silver & gems sent north where the convoy was ambushed by Confederate soldiers and the treasure was buried in a safe place. According to legend, it is buried near *Castle Gap* in the *King Mountains*, north of El Paso — it has never been found. Estimated value in today's Post Cataclysm market: 200 million credits!

**Wells Fargo's Legacy of Gold:** A stolen strongbox filled with gold bullion and other valuables was hijacked from a Salt Lake City stagecoach by bandits in 1865. When the outlaws saw a posse closing in on them, they threw the sacks of gold into *Mud Lake* (in Jefferson County, near Idaho Falls, Utah). Only a few bars of gold have ever been (known to be) recovered. According to legend, a fortune in gold still rests at the bottom of the lake. Estimated value in today's Post Cataclysm market: 2-4 million credits!

**Naruni Cache:** When the Coalition States declared war on the Naruni traders, it is said that one group of arms dealers fled to the canyons of Utah where they hid a cache of hundred of weapons, thousands of E-clips, force field generators and even a dozen or so vehicles somewhere in one of the canyons. Unfortunately, on their way back east, the entire group was devoured by a pack of 200 **Grigleapers**. A variation of the story has them travelling to Arizona.

**Washington:** A vast wilderness with a strong Indian (particularly the **Makah**) presence and numerous tiny towns and communities of humans. Washington is one of the most heavily populated territories in the New West. Covered in detail in *Rifts® World Book 15: Spirit West*.

**Wyoming:** Wyoming is a place of extremes. Sagebrush steppes, prairie grasslands, scrub and tall hills in its center and southeast; mountains and canyons, plus hot springs and more prairies, in the southwest corner; mountains, canyons, rivers and forested wilderness of evergreen trees and alpine scrub in the northwest (Yellowstone National Park); scattered patches of flat grasslands broken by hills, peaks and deciduous forests in the southern half and northeast; the Continental Divide slashes diagonally cross the territory.

A small population of Cheyenne and Sioux live in this territory, as well as pockets of people, but one can travel hundreds of miles without encountering a soul. There is a strong presence of *Cyber-Knights* in this territory and the occasional *Justice Ranger*. Up in the *Big Horn Mountains* is the ancient Indian *Medicine Wheel* which sits at the center of three ley lines. It is said to be a gateway to a world of demons. The **Shoshone** insist

the *Wheel* marks the home of "little people" who live in caverns beneath it and feed on wild sheep.

### The most desolate Territories

These are regions where one can travel for days and cover hundreds of miles without encountering intelligent human or D-bee life forms. Wild animals and animal predators abound. What few **humanoid** peopled exist can be found in small bands or pockets of scattered communities (often fewer than 300 people). Typically less than 300,000 people in the entire territory!

* Arizona	Nebraska
Dakota: North	* Nevada
Dakota: South	* Utah
Idaho	Wyoming

\* The three most inhospitable regions and least populated of them all; fewer than 150,000 people (human or D-bee) are known to inhabit the entire territory.

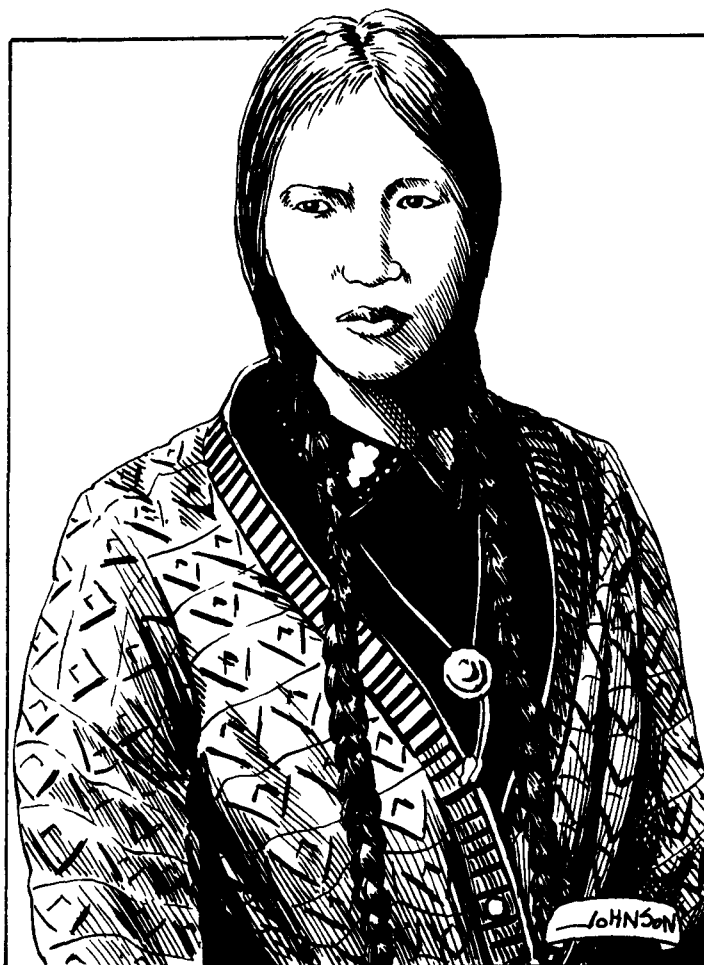

### Indian Population Centers in the New West

**Arizona:** Navajo and Hopi.

**California:** Miwok and Mohave.

**Colorado:** —

**Dakota, North:** Sioux

**Dakota, South:** A few Sioux and Chippewa

**Idaho:** Nez Perce

**Kansas:** Comanche

**Montana:** Blackfeet, Sioux and Shoshone

**Nebraska:** —

**Nevada:** Shoshone

**New Mexico:** Apache, Navajo, and Pueblo.

**Oregon:** —

**Texas:** Small bands of Apache, Commanche and Navajo.

**Utah:** —

**Washington:** Makah

**Wyoming:** Cheyenne, Sioux and Arapaho

**Note:** Those Territories without any listing are places where there is not a notable indian population, although nomadic tribes and bands may pass through or visit and individuals and small family clans may live there. Likewise, Indian adventurers from virtually any tribe or heritage can be found anywhere in the world, especially in the Americas.

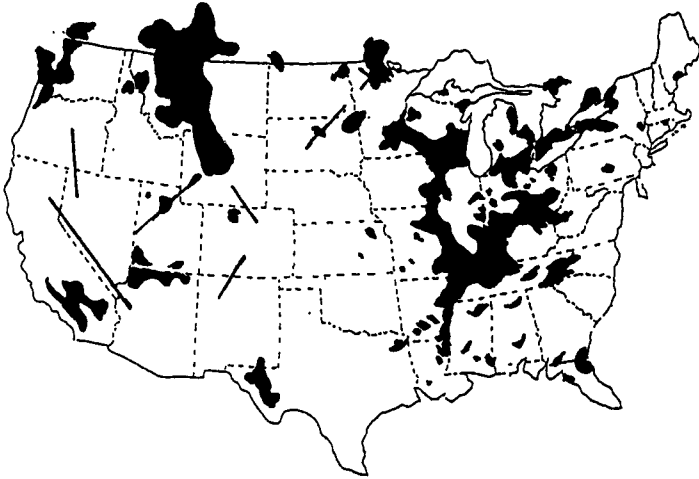

### Western regions strong with magic & ley lines

**Arizona,** only the northern eighth above the Colorado River.

**California,** most notably the southern portion.

**Dakotas,** notably in the northeast corners of both.

**Minnesota,** especially the lower, eastern quarter.

**Montana,** especially the west half.

**Utah,** various small areas, most notably north.

**Washington,** especially the west coast.

**Wyoming,** especially the northwest third.

**S.W. Canada:** West half of Alberta (the infamous Calgary Rift).

**S.W. Canada:** East half of British Columbia.

### Western Regions comparatively weak in magic & ley lines

**Note:** Generally speaking, there are a few hundred ley lines scattered throughout the entire New West, while the Eastern half of the old American Empire, east of the Mississippi (and many places in Canada), is much more active, with literally thousands of ley lines.

By comparison, some might consider the New West, other than Montana and Wyoming, virtually devoid of ley lines, generally making them unattractive (or dangerous) to supernatural beings and practitioners of magic. Also note that in many cases, these territories are largely unexplored and *may* have considerably more ley lines, magic and monsters than is believed.

**Arizona,** virtually everything below the Colorado River is free of ley lines except for places here and there.

**Colorado,** except for places here and there.

**Dakotas,** both have minimal ley line activity other than in the northeast corners of those Territories.

**Idaho:** The belief that Idaho is magic free is a prevailing misconception. True, compared to its neighbor, Montana, its reservoir of magic and ley lines is small, but Idaho has several major ley lines and nexus points.

**Kansas,** one reason the CS wants to seize this Territory.

**Nebraska,** one reason the CS wants to seize this Territory.

**Nevada,** except for a massive ley line that runs diagonally with the Territory's southern border, a few places here and there.

**New Mexico,** except for a handful of select locations.

**Oklahoma,** one reason the CS wants to seize this Territory.

**Oregon:** Unknown.

**Texas/Lone Star,** except the Bend in the southwest corner and a few scattered ley lines here and there.

### Notable Groups and Operations:

**1st Cavalry:** A vigilante army that hunts D-bee cutthroats and bandits. Some call them heroes, others insist they are as bad as the scum they hunt. They can be found throughout the New West, but their main stomping grounds are Nebraska, Kansas and Missouri.

**Cyber-Knights:** These new age knights can be found throughout the New West, Lone Star, Mexico and parts of Canada, but are most commonly encountered in *Calgary, Montana, Wyoming, Idaho, Colorado, Utah, New Mexico, Texas/Lone Star, Oklahoma, Kansas, and Mexico*. Their secret headquarters is believed to be in Montana or Wyoming.

**Justice Rangers:** The main areas of activity of these monster fighting defenders of the weak and innocent include *Washington, Montana, North Dakota, South Dakota, Minnesota* and the *Canadian Southwest* — constantly battling Xiticix and the horrors from the Calgary Rift. See the Justice Ranger O.C.C.

**Native American Indians:** A number of Indian nations survived the Great Cataclysm. Many say the Cataclysm and the return of magic was a sign to return to the old ways. Others combine the old and the *new/high-tech*, while others are as modern as any person from the Coalition States. They are described in detail in *Rifts® World Book 15: Spirit West™*.

**Pecos Bandits:** These infamous bandits, also known as the Pecos Raiders, dominate *southern Texas/Lone Star*, which they call the Pecos Empire. The Pecos Bandits regularly raid and plunder the people of the surrounding territories, most notably *Mexico, New Mexico, Colorado, Wyoming, Kansas, Missouri, and Arkansas*, but can be found throughout much of the New West, lured almost anywhere by news of prosperity and opportunity. They tend to stay west of the Mississippi.

**Sky-Knights:** The new champions of the west are the Lyn-Srial Sky-Knights. See the section on Arizona and the Golden Ones for more detail.

**The Coalition:** Territories earmarked for expansion and conquest by the Coalition States over the next 20 years include: *Minnesota, Iowa, most of Nebraska, Kansas, Oklahoma, Texas, and Arkansas* (as well as Southern Michigan, and the Canadian Provinces of Ontario and Quebec, to the East). Although this is the Coalition's official "20 Year Plan", most military leaders will admit that it is a very optimistic time table and not very realistic. The Tolkeen and Free Quebec campaigns will have a dramatic impact on the rest of the expansion plans. Once they fall, the others *should* fall much more easily. However, neither Tolkeen or Quebec are expected to fall easily, and recent reports

suggest the Federation of Magic may again be on the rise. Realistically, the Coalition's "20 Year Plan" is probably more like a 50 year plan. **Note:** Aside from the obvious troubles with Tolkeen and the Xiticix in Minnesota, and the power of Free Quebec, the conquest of Kansas, the Pecos Empire (in Lone Star), and Ontario will be much harder to take and hold than the CS currently anticipates. Heavy losses in the Minnesota/Tolkeen and Quebec campaigns may delay or completely change their plans for expansion. Currently the CS has a growing presence in *Minnesota, Iowa, Kansas, Texas* and *Arkansas*.

**Vampires:** Vampires dominate Mexico, and invading bands of undead are a constant problem in the southern portions of New Mexico, Arizona, Texas (Lone Star) and California.



## 1st Apocalyptic Cavalry

By Chris Kornmann & Kevin Siembieda

*General Kenneth Sprite walked with confidence toward the waiting podium and microphone. Today he would address his troops. As he climbed onto the small makeshift stage he surveyed the grounds of **Fort Prospect**. Rows of soldiers, mechanical horses, suits of armor, livestock, and various banners made up the legions he came to call the **1st Apocalyptic Cavalry**. It seemed as if centuries had passed since that fateful raid on his village. He had done much good in the years that had followed, but was beginning to feel the burden of leadership and age. Hundreds called him leader, thousands more called him "savior," and just as many called him "enemy." He began his speech by clearing his throat. A hush of quiet fell over the fort as General Sprite began to speak.*

*"Today I address all of you as heroes. All of you who risk your lives to keep the dream of humanity and order alive. We have come to know many enemies over the years and fought many battles. We have won, we have lost, we have bled, and we have died. But we shall not give up! The rise of the 1st Apocalyptic Cavalry brought hope to a land of despair! And we continue to bring hope. Our war for peace has saved thousands of lives. As the Cyber-Knights have let themselves become embroiled in the affairs of the Coalition Conflict at Tolkeen, I have no doubt that the forces of evil shall rise up and take advantage of their absence. We must fill that void and destroy these unholy monsters! We must prepare and be ready."*

# The First Apocalyptic Cavalry

The 1st Apocalyptic Cavalry was organized to bring peace and order back to human civilization under siege from both outlaws and vicious monsters from the Rifts. Ironically, this army for peace and order has grown from the hate and vengeance of one man, Kenneth Sprite, a simple man in a world gone horribly wrong. Most of his early life was spent in the small lumber and farming village of *Connelly, Missouri*. He grew up the son of a lumberjack and spent most of his early years learning to cut down trees, refine the wood and use it for construction and building.

The town of Connelly was a relatively quiet place, isolated from the rest of the world and protected by the watchful eyes of the Coalition States. The occasional band of D-bees or outlaws would ride into the area and rob a town or threaten a few people, but for the most part, life at Connelly was uneventful and the people were caring and law abiding.

The day after Sprite's 19th birthday, a large group of D-bee outlaws came to town. They demanded protection money, or else. The small town did not have very much to give, but despite some protests, they gave the outlaws all they could. Nobody really knows just what happened next, but within hours the town was burned to the ground and hundreds were killed — some by the fire, most by gunfire. Only Kenneth Sprite and six others survived.

This traumatic event turned an innocent young man into a demon of vengeance. He spent the next six years hunting those responsible and killing them — including those he only suspected of being involved, but whom he knew to be brigands. Along the way he was joined by other vigilantes who shared his hatred of D-bees and outlaws. Together they scoured the land for these monsters and killed them where they stood. No trial or judgement other than Sprite's.

Over the years, Kenneth Sprite's rag-tag group of vigilantes became folk heroes and turned into an army. As their numbers grew, Kenneth Sprite soon came to be called "General." As the fame of General Sprite and his army increased, people wanted to know the name of his heroic force. Names like "Kenneth's Riders" and "Sprite's Army" were what they had been called, but his men convinced him that the army needed a more befitting name. Since most rode horses and hovercycles and they were always mobile, somebody suggested the name of "The 1st Apocalyptic Cavalry." The men cheered the suggestion, General Sprite smiled his approval, and the rest is history.

Today the men and women of the 1st Apocalyptic Cavalry are no longer mere vigilantes but an organized, well trained and equipped army. Several "Cavalry Companies" have been assigned regular territories to patrol and protect, while others ride to all corners of North America to bring peace and order to this land. The members of the 1st Apocalyptic Cavalry are regarded as heroes in General Sprite's home State of Missouri and by human townsfolk and people across the Midwest and Central Plains. However, others would call him a destroyer and murderer every bit as savage and heartless as the villains who massacred the people of Connelly.

The 1st Cavalry may hunt and kill human outlaws, but their main targets are D-bee bandits and inhuman marauders. Over the last 20 years, General Sprite and his men have killed thousands

of D-bees accused of crimes against humanity. While many (at least 60%) were truly vile misanthropes who deserved death, others were just two-bit crooks and con men, and others were innocent families, townsfolk or tribesmen who dared to question the "verdict and judgement" of the 1st Cavalry, or simply unable to communicate. Entire towns and tribes have been massacred by members of the 1st Cavalry. While many humans see them as heroes and champions, most D-bees revile and fear them — as well they should, for no D-bee is safe from the zealous retribution of General Sprite and the fanatics of the 1st Cavalry.

Periodically, a squad (10-12 troops), platoon (40), or company (120-160 men) from the self-appointed defenders of humankind can be encountered anywhere in the New West. However, the 1st Cavalry's greatest presences are in the Midwest, particularly *Nebraska, Kansas, Iowa*, and the Coalition State of *Missouri*. Since General Sprite wages wars against D-bees and other nonhumans, the CS Military turns a blind eye to his vigilante activities and has even taken to feeding his troops helpful information through spies and CS sympathizers among his men. General Sprite has refused several invitations from Chitown to join the Coalition Military as a special operative. The General also holds them responsible for the slaughter of his family and the destruction of Connelly. Shortly after the slaughter, Sprite learned that an entire CS division was only a hundred miles away (a 30 minute trip by SAMAS), that they had received a radio message about the massacre, but continued their war games, believing the matter was over and that there was little they could do. The CS never made any attempt to bring those responsible to justice, but did broadcast film footage of the massacre in grisly detail as an example of why all D-bees are inhuman monsters requiring extermination. Worse, Sprite learned that the CS knew these marauders were terrorizing the countryside and did nothing to rout them from the State or even issue a warning. Consequently, General Sprite holds the Coalition States as responsible for the slaughter as he does those involved, and wants nothing to do with them. However, he does not speak or fight against the CS either, because he grudgingly sees them as humankind's salvation.

## General Kenneth Sprite

Note: The Indians call him "Crying Death" because he often weeps after delivering his justice.

**Race:** Human; Age: 40 years old.

**Alignment:** Aberrant evil, the General has his own twisted sense of honor and sees himself as a good person with the courage to do a dirty job.

**Attributes:** I.Q. 11, M.E. 15, M.A. 14, P.S. 14, P.P. 22, P.E. 23, P.B. 20, Spd 24

**Hit Points:** 71; **S.D.C.:** 67

**Horror Factor:** 13

**P.P.E.:** 180

**Level of Experience:** 9th level Gunslinger

**Appearance:** Kenneth Sprite is a big man, with short brown hair and a full yet well trimmed beard. He looks the part of a lumberjack. He has a calming voice and tends to come across as a father figure.

**Psionics:** None

**Alliances:** The entire 1st Apocalyptic Cavalry would follow him into hell. There are dozens of towns and thousands of people who consider him (and his troops) a hero and would do



whatever they could to help him. Some would even give their lives for this great (sic) man. In addition, the Coalition sees General Sprite as an asset and would intercede on his behalf if they could. Furthermore, the CS is secretly using the 1st Cavalry to destroy D-bee gangs and organizations by making incriminating information available to the General and his men.

**Enemies:** Most D-bees have heard the name of General Kenneth Sprite (he's something of a **Boogey-man**) and his soldiers of death! He is hated by many and feared by even more. The **Lyn-Srial**, **Cyber-Knights** and even the **Justice Rangers** (a bit overzealous themselves) have all tried to temper his wrath but to no avail. Failing to dissuade him in his crusade, they have condemned his actions — **Cyber-Knights** and **Justice Rangers** have stood against members of the 1st Cavalry to defend innocent D-bees on many an occasion.

**Combat: Attacks per Melee:** 7: boxing and hand to hand: expert; +8 when using revolvers or pistols; paired weapons and sharpshooting with revolvers and pistols.

**Bonuses:** +5 on a fast draw, +6 to strike, +9 to parry and dodge, +7 to pull punch, +3 to roll with punch, fall or impact, +2 to disarm on a "called" shot, +4 to save vs magic, +2 to save vs possession and mind control, and +7 to save vs Horror Factor.

**Equipment of Note:** Kenneth Sprite is usually seen in the blue and gold garb of a 1st Apocalyptic Cavalry General (an M.D.C. overcoat with light armor underneath) and carries two **Remi** six-shooters, a pair of **Wilk's** laser pistols (3D6 M.D. each), and a **BigBore** sawed-off at all times. He also has an **NG-Particle** beam rifle and a **Wilk's** laser pulse rifle.

**Cybernetics:** Clock calendar implant.

**Money:** The 1st Cavalry typically has access to 57,000 in Universal credits at any given time and millions in weapons, vehicles and equipment. General Sprite isn't interested in money, profit or fame, and those in his command who are, get thrown out.

## Breakdown of the 1st Cavalry

**Note:** Six Companies, 960 men, are typically divided into platoons. Half always patrol the Missouri, Nebraska, and Kansas region and 320 are permanently stationed at Fort Prospect (another 160-200 are usually no more than a few days horse ride away).

- 5% Bandits; supposedly reformed
- 3% Bounty Hunters
- 10% Cowboys
- 9% Sheriff/Lawman (equivalent)
- 10% Sheriff's Deputy (equivalent)
- 20% Gunfighters
- 8% Gunslingers
- 2% Wired Gunslingers
- 1% Psi-Slingers
- 5% Cyborgs
- 5% Headhunters/Mercenaries
- 5% Wilderness Scouts
- 3% Practitioners of magic
- 5% Wild Psi-Stalkers
- 2% Justice Rangers (equivalent)
- 7% Others; including renegade Dog Boys and other mutants.

## Fort Prospect

Fort Prospect is the 1st Cavalry's main base. It is a military fortification built on the site of old Fort **Kearney** near the Platte River in southern Nebraska. Inside its walls is a medium to large town (pop. 1450) that includes a permanent military force of 140 troops (can accommodate 600 comfortably), families of the Cavalry men, support personnel and **1D6x10** transients. Like most towns of the New West, Fort Prospect has a variety of both high and low technologies, as well as a smattering of magic and magic items. Weapons, power armor, and other military equipment are common here and such amenities as electricity, plumbing and heating and cooling can be found in most of the buildings within the fort's walls.

Fort Prospect was the first Cavalry fort to be constructed. Originally it was a small outpost surrounded by a combination of stone and wood walls with some mega-damage alloys to strengthen them. As time went on, Fort Prospect grew into a thriving community with several towns springing up around it. Currently the walls surrounding the Fort are 50 feet (15.2 m) high and constructed completely of mega-damage alloys. Every 10 foot (3 m) section of the wall has 180 M.D.C. General Sprite calls Fort Prospect home and considers it to be the center of the Cavalry high command. He has several reinforced bunkers from which he and his staff are able to conduct meetings and determine cavalry strategies.

**Surrounding Communities.** Immediately around the fort is farmland, but within 60 miles are a series of small towns and farming villages that act as a support network for the Cavalry. The average town around the fort is a low-tech community of 100 to 240 people, the average village has 15-60 people. The 1st Cavalry serves as their protectors.

Currently four comparatively tiny forts (each can accommodate one company of 140 troops and 60 support personnel — most have half that number stationed there) are located in other areas. These forts are always near a cluster of human communities troubled by **D-bees** and/or monsters. **Fort Tanner** is located in eastern Wyoming near what used to be the city of Jackson.

**Fort Defiance** is located near Stockton, Kansas and serves as protection for one of the Ironhorse train routes. **Fort Charles** is built on the ruins of Sidney on the border of Nebraska and Iowa, and the rebuilt **Fort Jericho** (nearly destroyed by D-bee raiders) is the farthest north, located near Norfolk, South Dakota.

---

# Arizona

---

## Indian Tribes of Note

**Northwest Arizona:** Navajo and Hopi, but scattered tribes and nomadic tribes of Navajo can be encountered throughout the territory.

**Southeast Arizona:** The largest concentrations of Apache in Arizona are found in the Southeastern portion, but nomadic tribes and hunting bands can be encountered throughout the territory (as well as parts of Northern Mexico, New Mexico and Lone Star). **Note:** Arizona was the homeland of such great, historical Apache leaders as Cochise, **Nana** and Geronimo.

**Southern Arizona:** The Papago people are nearly extinct. A small tribe can be found in southern Arizona.

**Pre-Rifts Ruins & Ghost Towns** dot the Arizona landscape. Most have been scavenged for valuables, artifacts and building materials years ago, but some are in surprisingly good condition and are sometimes used by nomads, bandits and travelers as a place to rest, hide or pitch camp. The most superstitious people consider *all* ancient ruins to be haunted and avoid them.

## Places of Note in Southern Arizona

### Wormrot

**Wormrot** is the ghost town of *Prescot*, Arizona. Much of the **pre-Rifts**, modern city remains intact, except for shattered windows and damage from wind, rain and age. Wormrot gets its name because there are always (2D4×100) *Worm Wraiths* hiding in the ruins. This is unusual, because these horrid supernatural creatures are rarely encountered in groups larger than a hundred, and often travel alone, in pairs, or in small groups less than two dozen. Furthermore, they seldom stay at any one place for more than a few months, let alone years — Wormrot has been "haunted" by these beings for over a century. This has led many to speculate that the alien intelligence believed responsible for their creation and guidance lives somewhere beneath the city.

Wormrot is also inhabited by Giant Canyon Worms (4D6×10 at any given time), 1D6×10 Haunting Entities, 3D4 Tectonic Entities and is often visited by other demonic beings. The strong presence of the supernatural at Wormrot is due to its sitting on a ley line that intersects with two others — the nexus is only six miles (9.6 km) away and prone to random dimensional Rifting (at least five times a year). Indians, **Simvan** and trappers sometimes come to Wormrot to hunt the Giant Worms, but the place is extremely dangerous and usually avoided like the plague, even by **Psi-Stalkers** and **Cyber-Knights**.

## The Phoenix Area

**Phoenix:** A small community of human settlers (approximately 130) and Cactus People (about 60) have reclaimed some of the city ruins and struggle to build a new life in this forbidding wilderness. Most raise cattle and other livestock and grow modest crops, as well as hunt in the dangerous *Scottsdale forest*.

**Scottsdale:** Once the home of the wealthy and elite, Scottsdale is a crumbling ruin overrun by alien vegetation. This alien forest has claimed all of *Scottsdale* and has spread south-east to the ruins of *Mesa*, and encroaches on the ruins of *Tempe*. It is also the home of a variety of Earth and alien wildlife, the most dangerous of which include **Oborus-Slitherers**, **Panthera Tereon** and a half dozen mated pair of **Leatherwings** that roost in the tallest buildings. Desert Sleepers, **Ostrosaurus**, Tiger-Claw Raptors, and **Tri-Tops** prowl both the forest and the plains.

**Glendale** had been obliterated centuries ago and is nothing but a giant crater! When and how it happened, and who might have been responsible is unknown.

**Laveen** is also a place of crumbling ruins inhabited by several clans of Cactus People (approximately 240).

**Chandler** is the site of a Papago Indian tribe of about 350; suspected to be the last of their race. They are friends with Reid's Rangers, the Sky-Knights and the Cyber-Knights. A dozen **Lyn-Srial** and 50 **Fennodi** live among the people.

## The Tucson Area

**Tucson & the Davis Monthan Air Force Bases** appear to have been sites of some cataclysmic battle that has shattered all standing structures and pockmarked the earth with scores of small craters; the entire area is still covered with low levels of radiation. However, whether this was a battle between technological forces or magic wielding opponents is impossible to say. If there was anything of value at the Air Force Base, it was looted centuries ago.

**Bisbee Vampires:** The ruins of Bisbee are the lair of a powerful and increasingly bold and aggressive vampire clan. The leader is **Carlos Vandenberg**, the master vampire who is responsible for the creation of a legion of 670 Secondary vampires and 120 wild vampires (predominantly humans, **Fennodi**, **Simvan** and **Psi-Stalkers**). Doc Reid and his vampire slaying Rangers have only recently become aware of this undead stronghold and are preparing to launch a raid. The **Lyn-Srial Sky-Knights** have warned the vampires not to stray beyond Bisbee or face their wrath. The vampires also frequently engage Papago warriors, **Cyber-Knights** and vampire hating mortals of all kinds.



**Douglas, Warren, Lowell, Nogales**, and other surrounding communities fell to vampire or other inhuman terrors two centuries ago. Few complete buildings stand, although their fallen walls and girders remain like the skeletal remains of some giant beast. Others are completely gone.

**Southern Arizona in general.** Much of the southern half of the Territory is flat and dry — "cactus country" as some call it — dry earth with scattered varieties of cactus, prickly pear, cholla, mesquite, saltbush, sagebrush and scrub broken by patches of prairie grass and the occasional small tree. Grass, shrubs and trees grow near waterways.

---

## Northern Arizona

### A Land of Stone & Canyons

---

#### The Grand Canyon Region

Most who first lay eyes on the Grand Canyon are shocked or awe-struck. Even in the age of the Rifts, where amazing people, places and sites have become a bit commonplace, the immensity, splendor and alienness of the Canyon is overwhelming to most.

The Grand Canyon Area of Northern Arizona has been called a "Wilderness of Stone" because the ancient Colorado River (millions of years old) and its tributaries have created a maze of canyons, pillars of stone, and rock formations unlike anywhere else in the world.

**The Grand Canyon** itself is 277 miles (443.2 km) long, often over a mile (1.6 km) deep (typically 5000 to 6300 feet/1520 to 1920 m), and as much as 18 miles (29 km) wide — typically about 10-12 miles (16 to 19 km) wide — covering an area of about 2000 square miles! However, some of its highest peaks are 8400 feet (2560 m) tall. In fact, it took decades of exploration, geographic surveys and stereoscopic photography before a *comprehensive* Geological Survey was published in 1971! And even then the best surveys could not possibly include every nook, cranny and butte where a light, agile person (D-bee or supernatural being) or some form of life (plant, animal and insect) can climb, hides and live. With the advent of the Great Cataclysm and the Coming of the Rifts, strange and alien flora and fauna now calls the Grand Canyon and the many neighboring canyons, summits and buttes (typically 5000 to 6000 feet/1520 to 1828 m tall) home. Many are places where no intelligent being, human or otherwise, has set foot in 300 years (in some cases, *ever!*). Thus, the canyons are likely to hold hundreds of strange and obscure life forms no one has ever seen.

There are literally two sides to the great canyon and different zones of climate within the Grand Canyon itself. Generally, the *south side* is always 20-30 degrees Fahrenheit warmer than the north side. Thin forests or pockets of pine and oak trees often run along the river banks of the Colorado River and its tributaries, however, most of the canyon floors are ancient dried river beds, the ancient path of lava, gorges or fissures devoid of anything except dry earth and crumbling stone.

**Inside the Grand Canyon**, climbing up from the bottom (or vice versa), one encounters several strata of climate and environment. At the floor, along the Colorado River, there is usually a light forest. The *lower portion* of the south side starts just above

the surface of the Colorado River and extends up about 2500 feet (762 m). The lower region is typically dry and hot during the day and cold at night (40-65 degrees). It has minimal vegetation (except at the bottom, along the river), with patches of scrub and catsclaw (a crawling shrub that is 10-15 feet /3-4.6 m tall, with sharp, curved thorns). In the summer it can be 120 degrees Fahrenheit in the shade! *The middle region*, starting around 2500 (762 m) to about 4000 feet (1220 m), is usually 20 degrees cooler than the lower region. *The upper region* to the top (generally around 6000 feet/1830 m) is another 10-15 degrees cooler and often shows a greater abundance and variety of plant and wildlife. *The highest peaks* are cold (32-45 degrees Fahrenheit) and are often snow covered. In the winter, as much as 12 feet (3.6 m) of snow can cover the highest peaks and elevations (8000 to 9000 feet/2438 to 2743 m), but snow rarely reaches below 1500 feet (457 m) and never touches the canyon floor.

The **north side** of the canyon is always 20-30 degrees Fahrenheit cooler than the south side and typically has more vegetation. *The lower portion* starts at the floor of the canyon and extends up about 2500 feet (762 m) where it shows more signs of life, notably the Fishhook Cactus, Juniper Pine and Pinon Pine, along with scrub. *The upper portion*, starting at around 2600 feet (792 m) to the top, has the aforementioned vegetation plus prairie grass, scrub, Ponderosa Pine, and a smattering of other trees common to the region.

Perhaps needless to say, the Grand Canyon and the smaller, neighboring canyons, create insurmountable obstacles that are impossible to cross (unless flying or **teleporting**), and require travelers (what few there are) to travel hundreds of miles to go around them. Many of the canyons are deep, stark and inaccessible from above. The best means of travelling the trails that go down into the Canyon, when possible, is on muleback. Mules are sure-footed and *never* slip or jump off the precipices (but the slow, safe journey can take 5-8 hours). Once down on the bottom, one can travel along the river's edge or use canoes or small boats to ride along the river. However, travelling *through* the Arizona canyons is incredibly dangerous.

**The Colorado River** snakes and weaves its way through northern Arizona, Utah and Colorado, and serves as the eastern border of California. In some parts of the Arizona river's length, it is fairly deep and calm, in others shallow, elsewhere, barely more than a few feet of muddy water, while at other locations it turns into violent rapids. Also note that the Colorado and California lengths of river are not surrounded by canyons.

#### Canyon & Mountain Vegetation

Generally speaking, thin forests of pine trees and Gamble Oaks are found only at the lower elevations along the Colorado River, its tributaries and other waterways, as well as along the Rocky Mountains through most of its length. Some patches at the Grand Canyon, like those found at **Wildforss Point**, are unexpectedly dense forests with a greater variety of plants and trees, including the Douglas Fir, White Fir, Apsen tree, Cedar, flowering **Locoweed**, wild strawberries, lichen and others. However, one might consider these forests oases of green in a hot, arid land of stone, cactus, and to the south, parched Earth and desert.

- **The Gamble Oak** is sometimes called the "Dwarf Oak" because it seldom grows taller than 15 feet (4.6 m). This tree has adapted to the arid environment and high altitude by spreading



its roots horizontally. Every now and then, a shoot rises from the roots to grow into a tree. Thus, a scattered grove of 30-60 Gamble Oaks may all be part of a massive network of roots that are really only 1-4 plants!

**Ponderosa Pines** are tall trees with thick, orange trunks, smell of vanilla and can be used as lumber. They grow 100-150 feet (30.5 to 46 m) tall.

**Pinon Pines** are scraggly looking and appear dwarfed and twisted, but the wood is harder than Ponderosa Pine and excellent for canoes, boats and lumber for building. The Native American Indians also use Pinon pitch to dress wounds, as a coating to waterproof baskets and canoes, and as glue. Perhaps more important, is the interesting fact that the pine cones of the Pinon are filled with delicious tasting, and nutritious, brown seeds about the size of small peanuts, commonly known as "pine nuts." These tasty morsels can keep a trapper or traveler from starving if he knows about them (part of the wilderness survival skill and a fact known to all Indians of the West).

**Juniper Pines** are also gnarled trees that usually grow alongside Pinon trees. Their stringy bark can be used to make tinder for lighting fires and torches, and can be woven to make soft sleeping mats. In addition, Juniper berries can be eaten, although they are not particularly good tasting. A type of mistletoe is commonly found in the branches of the Juniper, but this is a parasitical plant that saps and deforms the tree. However, its berries attract birds.

**Catsclaw** is a sprawling shrub, 10-15 feet (3 to 4.6 m) tall, with sharp, curved thorns.

**Locoweed** contains high amounts of alkaloids and selenium which are poisonous to both humans and animals. However, livestock often eat it, becoming addicted, and it eventually cripples and kills them.

**Cactus.** A variety of cactus can be found throughout Arizona, especially south of the Colorado river.

**Alien plant life:** A variety of giant ferns, as well as shrubs, vines, trees and cactuses have been transplanted from alien worlds to Earth. The vast majority (99%) are harmless, although their fruit, leaves, nuts and roots may be poisonous to humans if eaten. These plants simply add to the splendor and alienness of this vast Territory.

## The Presence of the Supernatural

Long before the white man came to this part of the world, the Native Americans recognized the Grand Canyon as the abode of "great spirits" and supernatural forces. White visitors throughout the 16th-21st Centuries reported dogs becoming restless, frightened or even barking and howling for no apparent reason. Even some human visitors reported feeling the presence of the supernatural or spirits. Of course the people of Rifts Earth know canines are especially sensitive to the supernatural, which is what these animals were reacting to.

The Grand Canyon and the entire region of Arizona along and north of the Colorado River is crisscrossed with ley lines and numerous nexus points. Surprisingly, these ley lines are not subject to the dimensional anomaly of random Rifts — random portals to other dimensions and worlds. In fact, less than a half dozen Rifts randomly open annually, a tiny number considering the number of nexus points. However, the Canyon Ley Line Network is likely to play a role in the existence of the terrifying **Shifting Lands** just north, in Utah.

# People & Places of Note in the Grand Canyon Region

Most of this region is desolate wilderness — one can travel for days without ever meeting another person. The strong magic energy in this remote and inhospitable region of Arizona has attracted a variety of supernatural beings, including dragons (an estimated three dozen are said to live in the canyons, with another dozen in Utah), Tectonic Entities (typically constructed of stone and wood), various other entities, demons (including a small tribe of approximately 200 gargoyles), the **Lyn-Srial**, and several small clans (20-60 members) of **Psi-Stalkers** who prey on the supernatural inhabitants and visitors in this land of stone. The most notable of the animal predators include the **Panthera-Tereon** (a giant sabre-toothed lion), **Giant Canyon Worms** and the **Leatherwing** (pterodactyl-like creatures from a Rift) who roost in canyon cliffs and on the peaks and buttes of Arizona and Utah, and hunt animals and humanoids in the canyons, prairies and deserts of Arizona, Utah and Nevada; they may number into the millions!

## Flagstaff

The cities of *Flagstaff*, *Williams* and communities within a 50 mile (80 km) radius of them have been obliterated. Flagstaff is now the site of a large active volcano with a pair of small ones at Williams.

## The Clarkdale Confederacy

The cities of Clarkdale, Jerome, and Cottonwood survived the Great Cataclysm. After seeing Prescott and other neighboring cities fall to riot, despair, disease and monsters, these three small communities joined forces and managed to survive. The level of technology is low (roughly equal to 1920) and all three are largely agricultural communities that raise livestock and farm.

They are God Fearing, honest, simple people who only wish to live a quiet, peaceful existence.

**Approximate Population Breakdown:** 13,260 total, between the three.

7,800 Humans

3,240 Fennodi

960 Cactus People

120 Lyn-Srial

1,140 Others

**Racial Breakdown:** Over the centuries that followed the Great Cataclysm, they have been joined by other human refugees and **D-bees**. Indian mysticism has led to a profound understanding and use of magic.

15% are Ley Line Walkers

6% other practitioners of magic

2% Indian mystics and magic users.

**Foreign Relations:** The community has made contact with **Cyber-Knights**, Reid's Rangers, the **Lyn-Srial/Golden Ones** and agents from Bandito Arms (there is a small **Bandito Arms** outpost in Clarkdale that arranges for trade and sales with the **Black Market**).



Enemies are primarily bandits, Worm Wraiths, vampires and other inhuman menaces and monstrous predators.

Other tiny bands and clans (10-40 people strong; mostly D-bees) are scattered along the Verde River, but don't total more than 800.

## Winslow

The ruins of Winslow have been turned into a Fennodi town. Over 1200 of these gentle aliens inhabit the place, where they raise livestock and farm. Their technology is low.

Near the ruins of Joseph City is a tribe of 500 Hopi and around them are scattered homesteads of other Hopi (typically families with 3D4 members) and tiny communities of Cactus People, ranging in size from 20 to 100. Like the Fennodi, they live off the land, raise cattle and farm.

At a place called *Rivercreek*, near the ruins of Holbrook, is an Apache tribe, 540 members strong. They and the surrounding communities are peaceful and low-tech, roughly equal to 1850's America, except for the occasional high-tech weapon, armor, vehicle or device.

---

## The Golden Ones

### The magic & nobility of the Lyn-Srial

---

By Chris Kornmann & Kevin Siembieda

A tall golden figure, cloaked in regal fashion, walked slowly to the middle of an ornately decorated room. The room was reminiscent of ancient Chinese architecture and filled with thirty kneeling, golden figures who looked very similar. Their four arms were folded in respect and eyes turned to the ground as their master rose in the air above them. Each figure glowed with an energy or light which was almost like a tiny fragment of the sun itself. The standing figure began to speak.

"Greetings, my children. Today, I impart to you a blessing and a reminder of our rich history and our destiny. You, like all **Lyn-Srial**, are the light of the universe. You bring light, hope and goodness to all that cross your path. You are peace-bringers at heart, but alas, have had to become peace-bringers with warrior's souls. A millennia ago, all Lyn-Srial were children of the sky above. We lived in a magical land called **Vir-Riial**. A magical land of clouds and sky that floated far above the prying eyes of the hard earth below and those that crawled upon it. We lived in peace and pursued the mystic arts. We lived for a millennia, harvesting the clouds and following our magical pursuits.

"This golden millennia of peace and harmony came to an end with the Raging Skies when the skies darkened and burned with the fury of a million lightning bolts. **Vir-Riial's** most powerful wizards tried to control the furious skies, but were consumed in the magical maelstrom. The storm engulfed and shredded our skylands, tearing us from the very fabric of reality and hurtling us to the earth below. How many may have perished in the Cataclysm of the Raging Skies, I shudder to think. However, I find comfort in the legends that foretold a day when the sky realm would be torn asunder, and its people cast down from the skies and scattered throughout the universe. Knowing that this is what has happened to us, I pray that the others have survived as we did, taken by the maelstrom to a hundred different worlds where they, like we, must start life anew, and bring wisdom and peace to those who crawl on the face of the planet.

"Shortly after our arrival to this new world, called Earth, we learned that the same maelstrom that swept us from our beloved Sky-lands also devastated it. And turned it into a seething Megaverse Nexus to ten thousand worlds. Our elders convened and decided that it was the **Lyn-Srial's** destiny to bring peace and light to this embattled world, as we have to so many others in the past. We were in need, and so the Great Wind brought us to where we can do the most good. It was then that we **Lyn-Srial** became known as **Sky-Knights**. We would be warriors of truth and peace and rebuild our own society, spreading our wisdom and words of peace to the myriad peoples who have been thrown together here, on the doorstep of the Megaverse.

"Over the years we have built a golden city in this great canyon and we have prospered. We have befriended the ones called the **Cyber-Knights**, the Apache and Navajo. And we have come to learn about many others, like the forces of humanity in the East to the man-eating **Simvan**, the winged **Xiticix** and the terrible vampires to the south. We have grown strong. We have learned the lay of the land. From this place of strength and **hope**, it is time to accept our destiny. You ... all of us, must pick up and carry the banner of peace to this embattled world. You have completed your training as wizards and **peace-bringers**. Go forth and bring peace through wisdom, compassion and mercy."

## The Lyn-Srial

**More commonly known as Sky-Knights or the Golden Ones**

The Lyn-Srial are a race of golden skinned **humanoids** (they actually appear to be made of glistening gold). They have a bird-like appearance with hawk-like heads and beaks, emerald green or golden brown eyes, four arms (one pair with great leather wings, similar to a bat's) and large, **taloned** feet, although they have no feathers. They are slightly bigger than humans and radiate a warm glow when happy or feeling positive.

Originally, the Lyn-Srial were a peace-loving race of magic users who lived in a separate dimension known as the **Skylands**. The Skylands were a series of giant islands that floated in the sky, two miles (3.2 km) above the ground, invisible among the clouds. The Great Cataclysm on Earth sent shockwaves throughout the Megaverse, and rocked the Skylands as hard as the Earth itself. This created the Raging Skies, as foretold in prophecy, and plunged segments of the Lyn-Srial through a dimensional vortex which has indeed scattered them throughout the Megaverse in groups of 1000-100,000 strong. Approximately 3700 appeared on Rifts Earth about 100 years after the Great Cataclysm that tore apart and reshaped both Earth and **Vir-Riial**. The survivors see themselves as the living embodiment of the legend that told how the gentle and noble Lyn-Srial people would rebuild their civilization and bring peace to the pandemonium of their new world. On the darker side, the legend also warns that of the scores of relocated Lyn-Srial, less than a third will be successful in bringing light and peace to their adopted worlds. The rest, though a positive influence and heroes to the end, would perish at the hands of their enemies. Worse, a small handful of Lyn-Srial would forsake the light and freedom of the skies and welcome smothering darkness and evil, turning against their own people. Over the last two centuries, the Lyn-Srial, calling themselves **Sky-Knights** (a suggestion of Lord **Coake**, the leader of their **Cyber-Knight** friends), have carefully studied the geography, culture and people of the **Americas** without their existence

becoming widely known. Thus far, they have only engaged evil in their own backyard, so to speak, in and around Arizona, Utah and Northern Mexico. Consequently, while they have befriended, protected, and helped a number of local communities, tribes and clans, they have only just begun to spread across the country.

## Tryth-Sal, Arizona

### The Cliff City of the Golden Ones

The Lyn-Srial first appeared in the heart of the Grand Canyon, and the elders took it as a sign to live below the earth in the great chasm, a crack in the earth that is itself majestic and beautiful. A place where, though below the surface, there is an expansive world of its own, miles wide and filled with open sky, flowing water and the golden, pink and amber colors of the sun they so love. In the early morning, after a rain, the canyon is often filled with a fog from rim to rim. Even when there is no rain, there is often a faint mist rising from the Colorado river below. As the morning sun pierces the shadows and mist of the canyon, the mist disappears. The dry air within the canyon and above it becomes luminous as light is reflected from the colorful walls of the cliffs. Or as one of the founding elders of Tryth-Sal is often quoted as saying, "It is as if the sky and the clouds come down to visit us in the bosom of the earth before ascending back into the heavens. This place is as grand as any we have seen above or below the earth. I can think of no better place for us to live and prosper."

Tryth-Sal is literally carved into the sheer cliff walls of a section of the Grand Canyon. At the base of the canyon, the Colorado river flows and with it the power of an intersecting ley line. They used both the power of the ley line and the very heavens to create *Tryth-Sal*, which, in their native language means, "the fallen sun." A constant mist or impossibly low-lying clouds magically enshroud the city at all hours of the day and night, making it virtually invisible from above, or the river below. Yet from within the clouds and inside the city, the sun always seems to shine bright. Note: This vibrant and invigorating sunlight will make humans and most mortals feel warm, peaceful and filled with positive power. In fact, most will heal twice as fast as usual, all are +15% to save vs coma and death as well as against depression and sadness, and +10 to save vs possession. Creatures of darkness will feel uneasy and exposed in what others find to be a soothing light (vampires suffer **2D4x10** points of damage for every melee round exposed to the light), while entities and dark spirits stay away from the Tryth-Sal entirely.

**Population:** The city of Tryth-Sal is big enough to house 12,000 inhabitants, but has a current population of approximately 6,580. This is because 2,950 Sky-Knights have left the Golden City and have gone into the world to bring hope and peace to others.

#### **Racial Breakdown:**

3,200 **Lyn-Srial/Sky-Knights/The Golden Ones**

1,210 **Fennodi**

420 **Cactus People**

1,130 **Other D-bees**

280 **Apache**

340 **Other Humans**

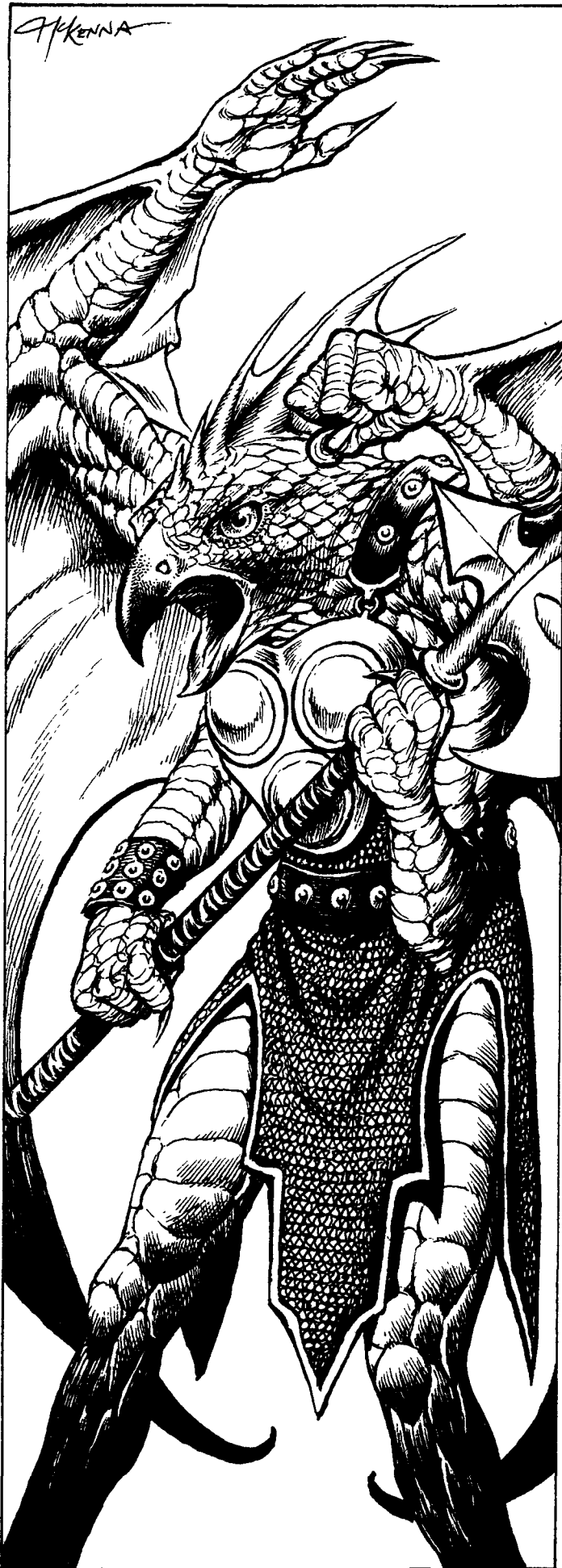

**Transients** represent 2D6×10 people of various races and groups. This number is relatively small because of the remoteness of the region and the fact that the Lyn-Srial keep their city hidden. The likelihood of finding 2D6 Cyber-Knights visiting the city is 01-80%, plus three are permanent residents. One, Lady Sharla Wild Wind (of Navajo heritage), is included among the Council of Elders. Likewise, a number of Lyn-Srial are counted among the Cyber-Knights.

**Surrounding Communities** are nonexistent. The occasional nomadic tribe, clan, outlaw band, trapper, or adventurer group is periodically found in the area, and there are a dozen tiny farms and settlements within 100 miles (160 km), mainly indians and Fennodi (typically a family clan with 4-16 people living there). A handful of Lyn-Srial (under 100) have left Tryth-Sal to start small farms and outposts away from the city.

Note: Remember, 2950 Lyn-Srial Sky-Knights have gone into the world, leaving their families at Tryth-Sal. Consequently, they periodically return to rest and visit family, friends and loved ones, so there are 2D6×10 knights-errant present at any given time, and as many as 1600 may return for the annual Festival of Light.

## Government & The Law

The Lyn-Srial are ruled by a council of elders. These are the oldest and wisest of the population. Once voted into this position, the elder is a member for life or until he steps down. The council is made up of twenty members. Each member sees to a different aspect of Lyn-Srial life. There is an elder of defense, an elder of the economy, an elder of agriculture, an elder of magic, an elder of the arts, etc. These twenty members, both male and female, Lyn-Srial, human, and D-bee, control the destiny of the city and its people. A decree from the council is law and will be obeyed undyingly. This is so ingrained in Lyn-Srial society that any decree is rarely questioned, for the elders are also the spiritual and moral leaders of the people — the greatest thinkers and most pure of spirit.

**The Law in Tryth-Sal.** The Lyn-Srial are by nature a peaceful, caring people. Their high moral standards and ethics are so ingrained and a part of them, that they simply do not commit crimes, the very notion is incomprehensible. In many ways, they are as close to a perfect, open society that the Earth has ever known. For this reason the Lyn-Srial have very few hard and fast laws or punishments. Injury to others, even cheating and lies, are seen as painful and sad events, for the perpetrator is lost and on the road to self-destruction, a danger to himself as much as others. Thus, they try to change these dangerous perspectives and patterns of behavior, rather than cage or destroy those responsible. They believe vengeance is an act of despair or anger that has little to do with mercy or justice.

The Sky-Knights welcome all peace-loving people. They fight only in self defense, to protect others, and to destroy supernatural evil — but even then, they'd rather turn or change evil than destroy it. They tend to give everybody the benefit of the doubt and will spend endless hours discussing philosophy, morals and the quality of mercy. Many of the laws they do have are more for the benefit of outsiders than for their own people. The Lyn-Srial ask that outsiders refrain from any kind of violence within the city and that they respect all Lyn-Srial people and their beliefs. Violence is met quickly and forcefully, but seldom

with lethality. The Lyn-Srial will attempt to capture, lecture and exile the perpetrators but avoid killing. Desecration of their religious shrines or the theft or destruction of personal property is usually met with education and a warning to respect their customs.

They, in turn, try to understand and respect all people. The Golden Ones have a sort of “karmic” outlook of life in which they believe that a person's deeds, life and death can make a difference and affects others in a positive way. That kindness, compassion and goodness begets more of the same. However, they are an ancient and wise race who recognize that there truly are forces of destruction and evil, usually supernatural beings and alien intelligences. Forces which the Sky-Knights readily take a stand against, and the only lives they will take with little compunction. Yet even against these terrors, they prefer to rebuke and repel the evil rather than spill its blood. After all, some day even these craven beings may accept the light, and the mercy shown to them by the Sky-Knights may give them pause to reconsider their lives. The Lyn-Srial also accept that for many of these beings, their wicked ways are part of their nature, such as predator beings who feed on the pain or blood of other life forms.

## Relations with Others

The Lyn-Srial generally welcome all peace-loving people and have begun to go out into the world to teach others by their example. Despite their alien appearance, most are recognized as noble beings who want to help others. Those who come to their city seeking refuge are welcome to stay as long as they like, provided they conduct themselves with nobility, honor and respect for all other beings and their beliefs. The Sky-Knights use their powers to heal, build, inspire, and to bring hope, love and beauty to those who have lost them.

Most people beyond Arizona and Utah, other than the **Cyber-Knights** and certain regional Indian tribes, know nothing about the Lyn-Srial and have never seen a Sky-Knight.

**The Coalition** have never encountered these alien creatures, but when they do, they will regard them as dangerous, subversive alien invaders and masters of an alien magic. Thus, they will be targeted for destruction and, if their location is uncovered, they will attack and try to destroy **Tryth-Sal**.

## Technology

The Architecture of Tryth-Sal is reminiscent of ancient earth's oriental designs, with pagodas, statues and designs built into the sides of the canyon and others that seem to float on the very clouds themselves. The utter beauty of Tryth-Sal is said to be second to none on earth. These things and most of their achievements are accomplished through willpower, unbridled imagination and magic. Everything the Lyn-Srial use is based on magic, ley lines, clouds and light from the sun. For this reason, the only human technological items adopted by these alien people are solar powered devices, laser weapons and tools and **Techno-Wizard** devices. Of course they show respect for the people who use different technology, but most Lyn-Srial disdain the use of these items in favor of the more spiritual and natural (for them) creations of magic and nature.

---

## The Elegant Art of Cloudweaving

---

Lyn-Srial magic and technology is all based on magic involving the air, clouds and light. As compared to other magics known on earth, the Lyn-Srial Art of Cloudweaving is probably one of the most beautiful and graceful forms of magic. Cloudweaving is a discipline that is very difficult to master unless one has lived among the clouds. For this reason, most earth men and women cannot fully comprehend or master Cloudweaving. Only those exceptional individuals with open minds, vivid imaginations and extreme nobility (not to mention an I.Q. and M.E. of 18) may learn the ways of Cloudweaving.

All Lyn-Srial are capable of a limited amount of cloudweaving and are able to cast a certain number of cloud spells, but it is the Lyn-Srial women who are especially adept at the greater mystic arts and become the mystics known as *Cloudweavers*. These women are powerful magic users who are the very lifeblood of Lyn-Srial society and civilization (55% of the council of Elders are female). Cloud magic is broken into *seven disciplines*: Clouds of War, Clouds of Defense, Clouds of Peace, Clouds of the Mind, Clouds of Travel, Clouds of Survival, and Clouds of Creation.

All Lyn-Srial can learn spells from *clouds of defense, travel, and survival*, but only the Cloudweavers and Sky-Knights can learn spells from the other categories.

Cloud magic is a very alien art form to humans and most races and therefore imposes a penalty of -3 to save vs cloud magic, unless one is familiar with its use (a rarity). This means the base saving throw against a cloud spell is 15 or better. This makes cloud magic very effective on Rifts Earth.

In order to learn cloud magic, the Lyn-Srial must open himself to the magical energies of the clouds, winds and sun, and let himself be lifted into the air by a Cloudweaver. At this point the mage is able to impart the spell knowledge to the open vessel that is the recipient. The slightest doubt, fear or hesitation prevents the recipient from receiving the insight and inner peace necessary to cast the magic. Cloudweavers are able to do this to themselves by entering a mental and spiritual plateau in life (represented by experience levels). At each such plateau, the mystic enters into a trance, floats into the air and opens himself to knowledge and the power of the Megaverse.

When casting a cloud spell, a cloud seems to swirl and form around one of the casters' hands, which must be free. The cloud then begins to take shape and form, or a spell effect occurs. This act is beautiful and those seeing it for **the first time** must make a save of 16 or better (Awe Factor) or simply stare at the spell's creation, defenseless for one melee action.

---

## Lyn-Srial R.C.C.s

The specific character stats for the Lyn-Srial, Cloudweavers and Sky-Knight Racial Character Classes (R.C.C.s) are found in the section describing a number of alien and D-bee races, elsewhere in this book.

---

---

# Cloud Magic

By Chris Kornmann & Kevin Siembieda

---

## Clouds of War

Cloud Blast (12)  
Cloud Disc (8)  
Clouds of Imprisonment (25)  
Cloud Lance (5)  
Cloud Sword (6)  
Cloud Whip (8)  
Fiery Cloud (12)  
Poisonous Cloud (20)  
Rolling Thunder (60)  
Storm Cloud (80)  
Storm Cloud Sword (15)  
Wind Hammer (8)  
Wind Spear (6)

## Clouds of Defense

Blinding Flash (1)  
Clouds of Light Deflection (8)  
Cloud of Darkness (12)  
Cloud Rider Armor (15)  
Cloud Shield (6)  
Fog of War (35)  
Storm Rider Armor (30)

## Clouds of Peace

Cloud of Harmony (15)  
Cloud Haven (25)  
Fog of Peace (50)  
Healing Rain (100)  
Winds of Change (15)  
Winds of Regret (15)

## Clouds of Travel

Blink of an Eye (24)  
Cloud of Ascension (1)  
Cloud Portal (550)  
Cloud of Speed (15)  
Cloud Surfing (15)  
Fly Like The Wind (30)  
Portal to the Beyond (700)

## Clouds of Survival

Aerial Navigation (4)  
Breath of Life (100 +1 P.E. point)  
Calm Storms (200)  
Cloud of Healing (15)  
Globe of Daylight (2)  
Hunter's Instinct (15)  
See the Invisible (10)  
See the Light (10)  
Tongues (12)  
Warmth of the Sun (12)

## Clouds of the Mind

Cloud of Insanity (30)  
Clouds of Truth (12)  
Mind Fog (24)  
Mind Over Matter (22)  
Mist of Illusion (24)  
Spirit Mist (15)  
Warrior's Mist (20)

## Clouds of Creation

Cloudweaving (100)  
Cloud Castles (250)  
Create Cloud Figures (50)  
Create Water (10)  
Flying Chariot (80)  
Food from the Heavens (80)  
Globe of Daylight (2)  
Paint the Sky (200)

---

**Character Notes:** Cloud Magic is more akin to Oriental mysticism than magic as understood and practiced by most humans and D-bees. Consequently, it is much more difficult for non-Lyn-Srial to master and grow in the mystic arts of the Cloudweaver or Sky-Knight. This means non-Lyn-Srial must expend 50% more P.P.E. when casting a spell, need an additional 1500 experience points to advance each level (use the Cloudweaver and Sky-Knight E.P. tables), and must have a minimum I.Q. and M.E. of 18 each, as well as an open and imaginative mind. Also note that the Golden Ones will *not* teach their magic to selfish, evil or vengeful people, and requires years of training.

It takes 1D4+4 years before the character advances to first level Sky-Knight and 2D4+14 years to become a Cloudweaver!

Spell strength of Cloud Magic increases one point at levels 5, 10 and 15.

Humans and most non-Lyn-Srial are -3 to save vs cloud magic, unless one is familiar with it's use (i.e. a Cloudweaver or Sky-Knight; a rarity). This means the base saving throw against a cloud spell is 15 or better.

All *cloud* manifestations, weapons, objects and barriers can be dispelled by *negate magic* and/or *dispel magic barrier*. Not applicable to mists, fogs and other affects.

## Clouds of War

The Clouds of War are mystic manifestations that are of an offensive combat nature, yet even many of these fighting spells are designed to incapacitate, repel or capture an opponent rather than kill him.

### Cloud Blast

**Range:** 600 feet (183 m) +100 feet (30.5 m) per level of experience.

**Duration:** One melee round (15 seconds) per level of the spell caster.

**Damage:** 2D6 S.D.C. or M.D. (as desired by the spell caster)

**Saving Throw:** Dodge at -5; a 17 or higher is needed to dodge.

P.P.E.: 12

A grey cloud, pulsing with energy, appears above the head of the spell caster (Sky-Knight), and with each pointing gesture (each counts as one melee action/attack), the cloud fires a blast of ball lightning.

### Cloud Disc

**Range:** 900 feet (270 m) +20 feet (6 m) per level of experience.

**Duration:** One melee round (15 seconds)

**Damage:** 1D6 M.D. plus knock-down regardless of the opponent's size.

**Saving Throw:** Dodge at -3; a 17 or higher is needed to dodge.

P.P.E.: 8

This spell creates a large, swirling, disc shaped cloud or mist the size of a large shield above the Sky-Knight's shoulder. With a throwing gesture (must be aimed at the intended target) the disc hurls at the target at high speed. Once it strikes, it disappears. It inflicts 1D6 M.D. and knocks its opponent off his feet and back 3D4 yards/meters. The victim of the knock-down attack loses initiative and one melee action/attack.

**Note:** One disc can be instantly created and hurled for each melee action the Sky-Knight uses to attack (each magical disc strike counts as one of the knight's melee actions/attacks). This means that if the character has five attacks per melee, he can make as many as five discs. However, if he uses one melee action to dodge or move, then he can only hurl four cloud discs. Cloud discs are often used to keep an opponent unbalanced and constantly on the defensive (falling or dodging) while the Sky-Knight tries to talk him into surrendering, fleeing or discussing a peaceful resolve.

### Clouds of Imprisonment

**Range:** 60 feet (18 m) +10 feet (3 m) per level of experience.

**Duration:** One melee round (15 seconds) per every two levels of experience (2, 4, 6, 8, 10, 12 and 14).

**Saving Throw:** Standard save; success reduces duration by half.  
P.P.E.: 25

A sphere of magical clouds encircle one target for every three levels of the spell caster. While encircled by the clouds, the prisoner cannot see, hear, or smell anything around him. He can only hear the voice of the spell caster (if the spell caster desires to speak to him). If the prisoner tries to escape by stepping into the clouds, it will seem as if he is walking endlessly in a mist of white. Likewise, while imprisoned in the clouds, the character cannot be attacked or injured in any way, not even from magic or psionics. When the spell ends, the clouds instantly vanish and the prisoner finds himself standing exactly where he was when he was imprisoned. A successful save means the duration is halved. A dispel magic barriers or negate magic spell will eliminate the Clouds of Imprisonment. **Note:** The Sky-Knight cannot use this spell on himself, only others.

## Cloud Lance

**Range:** Self

**Duration:** Three minutes per level of experience.

**Saving Throw:** None

P.P.E.: 5

A magical lance made of cloud-like material forms in the spell caster's hands. The lance is a magical weapon that inflicts either 3D6 M.D.C. or 4D6 S.D.C. depending on the opponent (a Sky-Knight will never use a mega-damage weapon or M.D. magic against an opponent armed with S.D.C. weapons). For each 10 mph (16 km) of flying speed in a lance charge, add 1D6 S.D.C. to the overall damage (not applicable to M.D. attacks). +1 to strike and disarm.

## Cloud Sword

**Range:** Self

**Duration:** Two minutes per level of experience.

**Saving Throw:** None; can be parried and dodged as normal.

P.P.E.: 6

A magical sword that appears to be made out of the fluffy substance of clouds forms in the hand of the spell caster. The magical creation is far from soft or insubstantial and inflicts either 2D6 M.D.C. or 4D6 S.D.C., whichever the creator desires. Note that a Sky-Knight will never use a mega-damage weapon or magic against an opponent armed with S.D.C. weapons.

## Cloud Whip

**Range:** Self, to use the weapon; the whip has a range of 60 feet (18.3 m).

**Duration:** 2 minutes per level of experience.

**Saving Throw:** None

P.P.E.: 8

A magical whip that appears to be made of cloud and long, trailing streams of mist forms in the hands of the spell caster. The whip does either 1D6 M.D.C. or 2D6 S.D.C. depending on the desire of the spell caster. The whip is also capable of striking targets 60 feet (18.3 m) away and is +2 to disarm.

## Fiery Cloud

**Range:** 100 feet (30.5 m) +20 feet (6 m) per level of experience.

**Radius:** 20 feet (6 m) +5 (1.5 m) per level of experience.

**Duration:** One melee round (15 seconds) per level of experience.

**Saving Throw:** Standard

P.P.E.: 12

This spell creates a grayish red cloud that burns all engulfed by it! If the target is armored it takes 1D6 M.D. per melee round, but if human (hit points/S.D.C.), it does 1D6 S.D.C. In either case, all heat sensors and infrared optics are temporarily rendered useless.

If the **target(s)** is **unarmored** and/or breathing the air in the cloud, it smells of sulfur and ash, and burns his throat, nose and lungs, causing the character to choke and gasp — reduce all combat bonuses and attacks per melee by half. A successful save will negate the hit point damage and other penalties are half.

## Poisonous Cloud

**Range:** 100 feet (30.5 m) per level of experience.

**Radius:** 20 feet (6 m) +5 feet (1.5 m) per level.

**Duration:** One melee per level of experience.

**Saving:** Standard

P.P.E.: 20

All people without full environmental armor or air filters will take 4D6 S.D.C. and feel dizzy and nauseous — reduce speed, attacks per melee and skill performance by half. A successful save reduces the penalties to one quarter (rather than half).

## Rolling Thunder

**Range:** 20 feet (6 m) plus 10 feet (3 m) per each subsequent level of the spell caster (20 feet at level one, 30 at level two, etc.).

**Size:** About 20 feet (6 m) wide and tall; the length is the full range.

**Duration:** Two melee rounds (30 seconds) per level of the spell caster.

**Damage:** 1D6×10M.D.

**Save:** Living creatures can dodge by dropping to a prone position and letting the thunderhead roll over them, or by leaping out of the way if near the edge of the cloud (roll initiative to see if leaping dodge is successful).

P.P.E.: 60

This creates a large, rolling, thundering, black cloud that is 20 feet (6 m) high. The cloud will seem to roll in the way a thunderstorm does, except low to the ground (3 ft/0.9 m above the ground). The rolling cloud knocks over or pushes away everything in its path. The initial "hit" from the billowing, black cloud does 1D6×10 M.D. and either knocks down and stuns (for 1D4 melee rounds) its victims or pushes them to the limit of the cloud's range. Unless obstructed, the rolling cloud will reach its full **length/range** within one melee round (15 seconds).

If the object is a massive obstacle like a stone wall, building, tree, vehicle, giant robot or similar large, heavy object weighing more than two tons, the cloud will be stopped by it, but continues to *roll* into it with successive waves of devastating power, inflicting 1D6×10 M.D. once every melee round!

In either case, once the rolling cloud reaches the end of its maximum range, it can go no farther, but thick, dark, billowing clouds continue to *roll* along its path, keeping those pinned underneath it trapped (crawling speed with all the wind, dust and thunder is 25% normal speed, no combat bonuses are possible and visibility is terrible). Standing up and into the cloud will inflict 2D4×10 M.D. and knock-down each and every time!

**Note:** The **Lyn-Srial** are careful not to hurt or kill innocent bystanders with this powerful spell, nor to damage property, na-

ture or wildlife recklessly. The spell caster can cancel the spell at any time.

## Storm Cloud

**Range:** 500 feet (152 m) +100 feet (30.5 m) per level of the caster.

**Radius:** 200 feet (61 m) +10 feet (3 m) per level of experience.

**Duration:** Two melee rounds (30 seconds) per level of experience.

**Saving Throw:** None; although lightning bolts can be dodged at -5.

P.P.E.: 80

A massive storm cloud magically appears over the enemy; a menacing thing in and of itself (Horror Factor 10). The storm cloud will act like a summoned creature, attacking the enemies of the Sky-Knight with gusting winds and light rain (the rain, blowing dust and light debris will distract everybody in the area of effect; -3 on initiative and -1 to strike). In addition, the storm cloud can unleash a powerful lightning bolt twice per melee round, inflicting 2D4×10 M.D. (often directed at vehicles and supernatural menaces)! The creator of the storm cloud must control and direct it to fire the lightning bolts, so he cannot cast other magic or take more than one melee action to do something else per melee round. On the other hand, he can release his focus on the storm (so it only rains and wind blows) to other things, and retake control to fire lightning a few melee rounds later. The storm cloud has the following statistics.

The magical storm cloud cannot be damaged by physical means but dispel magic barriers or negate magic can destroy it.

## Storm Cloud Sword

**Range:** Self, to use the sword; lightning: 100 feet (30.5 m) +10 feet (3 m) per level of experience.

**Duration:** 2 minutes per level of experience.

**Saving Throw:** None; can be parried and dodged as normal.

P.P.E.: 15

In this case, the magical cloud sword that appears is made of black storm clouds, and muted flashes of lightning periodically show through its darkness. The magical creation inflicts 3D6 M.D.C. or 6D6 S.D.C., whichever the creator desires. Twice per melee round, the Storm Cloud Sword can fire an electrical blast, like mini-bolts of lightning. The lightning does 4D6 M.D. and has a range of 100 feet (30.5 m) +10 feet (3 m) per level of experience.

## Wind Hammer

**Range:** Self, to use the weapon, but can be thrown 1000 ft (305 m).

**Duration:** Two minutes per level of experience.

**Saving Throw:** None, other than dodge; a parry will cause the opponent to suffer half damage.

P.P.E.: 8

A shimmering, semitransparent hammer that seems to be made out of mist appears in the hand of the Sky-Knight. Despite its insubstantial appearance, the weapon strikes with the force of a tornado, inflicting 2D6 M.D.C. and can be thrown 1000 feet (305 m) and returns to the thrower within three seconds (roughly the equivalent of one melee action).

## Wind Spear

**Range:** Self, to use the weapon; lightning: 100 feet (30.5 m) +10 feet (3 m) per level of experience.

**Duration:** Instant

**Saving Throw:** None, other than dodge; a parry will cause the opponent to suffer half damage.

P.P.E.: 6

A shimmering, semitransparent spear that seems to be made out of mist appears in the hand of the Sky-Knight. Despite its insubstantial appearance, the weapon strikes with the force of a tornado, inflicting 4D6 M.D.C. and can be thrown 100 ft (30.5 m) +10 feet (3 m) per level of experience.

## Clouds of Defense

These spells go hand in hand with the Clouds of War. They are used to create armor, shields and other means of defense for Sky-Knights to use in combat.

### Blinding Flash

**Range:** 10 feet (3 m) radius; up to 60 feet (18.3 m) away.

**Duration:** Instant

**Saving Throw:** Standard

P.P.E.: One

This invocation creates a sudden burst of intense, white light, temporarily blinding everyone in its ten foot (3 m) radius. Victims are blinded for 1D4 melee rounds, with a penalty of -5 to strike, and -10 to parry and dodge. The chance of falling is 1-50% per every 10 feet (3 m) travelled. The saving throw is standard, so those who successfully save vs magic are not blinded. **Note:** Does not affect bionic or cybernetic eyes.

### Clouds of Light Deflection

**Range:** Self or others by touch.

**Duration:** One minute per level of the spell caster.

**Saving Throw:** None

P.P.E.: 8

This spell forms swirling clouds around the character. Particles in the cloud sparkle like gems reflecting the light. These clouds are able to cause lasers to diffract and diffuse them completely (no damage to anything in the cloud). Likewise, those within the cloud are obscured so all attackers shoot at those in the cloud at -5 to strike. Other forms of energy (magic lightning, fire balls, particle beams, plasma, etc.) penetrate the cloud and do full damage, but attackers still suffer the same -5 penalty to strike. Note that those inside the cloud can see out perfectly.

### Cloud of Darkness

**Range:** Self or others up to 60 feet (18.3 m) away.

**Duration:** One minute per level of the spell caster.

**Saving Throw:** None, unless used against an opponent. Standard otherwise.

P.P.E.: 12

A forbidding dark cloud wraps itself around the target, totally obscuring him from all nonmagical forms of detection. In the case of a willing participant, the cloud does obscure the vision of the person within it; -4 to strike and speed is reduced by 33%.

When the spell is used as a means of attack, the individual enveloped in darkness must make a saving throw or he becomes



lost in the blackness (-9 on all combat attacks, reduce speed by half, and the character stumbles around blind; cannot see unless through magical means). The target has a 75% chance of stumbling and falling down for every action (few steps) that he or she makes while in the cloud. Note that the character trapped inside the magical darkness (it clings to him no matter where he goes) is also obscured in the cloud, so attackers are likewise -9 to strike at him. Note: This spell is typically used to hide, make good an escape, slow down or avoid an opponent, or to create a diversion. Dispel magic barrier or negate magic will destroy the cloud instantly. A successful saving throw means the darkness fades away within six seconds.

## Cloud Rider Armor

**Range:** Self or by touch.

**Duration:** Two minutes per level of the spell caster.

**Saving Throw:** None

**P.P.E.:** 15

A swirling mist seems to surround and cling to the spell caster (or other by touch) forming into a suit of body armor reminiscent of ancient chain mail. The armor has 20 M.D.C. +10 M.D.C. per level of the spell caster and all elemental magic, lightning and similar natural forms of energy do half damage while the armor is worn. This armor offers no environmental protection from gases, radiation, heat, disease, etc.

## Cloud Shield

**Range:** Self

**Duration:** Three minutes per level of experience.

**Saving Throw:** None

**P.P.E.:** 6

This creates a white cloud-like shield in one of the hands of the spell caster. The shield is used to block or parry physical attacks leveled at the caster like any physical shield. The shield is hand-held and can be used to parry as normal. The shield has 50 M.D.C. +10 M.D.C. per level, and is +1 to parry. Even energy bolts (laser blasts, plasma, particle beams, magical lightning, fire balls, flaming swords, etc.) can be parried with this magical shield, but at a penalty of -5. **Note:** *Bullets*, arrows, punches and other "kinetic" attacks pass right through the shield!

## Fog of War

**Range:** 500 feet (152 m) +100 feet (30.5 m) per level of the caster.

**Radius:** 100 feet (30.5 m) +10 feet (3 m) per level of experience.

**Duration:** One minute per level of the spell caster.

**Save:** None

**P.P.E.:** 35

Out of the mystical fog appears visions of battle, bloodshed and death. Those reluctant to fight or uncertain will consider retreating or attempt to settle the dispute without bloodshed. If they push forward to attack, they are -3 on initiative and -3 to save vs Horror Factor. However, those driven to fight or destroy (for whatever reasons) will be motivated rather than dissuaded and attack at +1 on initiative and +3 to save vs Horror Factor.

## Storm Rider Armor

**Range:** Self only.

**Duration:** Two minutes per level of the spell caster.

**Save:** None

**P.P.E.:** 30

A white mist crackling with tiny swirls of blue lightning surrounds the spell caster. Like the cloud armor, it provides 20 M.D.C. +10 M.D.C. per level of the spell caster. However, the character is impervious to all elemental magic, lightning, and even the effects of ley line storms! All other types of energy do half damage. In addition, the magic enables the wearer to hover and fly at a speed of 60 mph (96 km); +2 to dodge while airborne and no limit to the altitude as long as there is air to breathe.

## Clouds of Peace

These were some of the first cloud spells to be discovered. They all deal with the calming of the heart and mind to find inner peace. These spells are designed to relax, calm down, and open the minds of the targets of the spell. They will never be used to take advantage of another, only to show them the truth and that the only way to win a war is never to fight it in the first place.

## Cloud of Harmony

**Range:** 100 feet (30.5 m) +10 feet (3m) per level of experience.

**Radius:** 20 feet (6 m) +5 feet (1.5 m) per level.

**Duration:** 4 melees per level

**Save:** Standard

**P.P.E.:** 15

The spell creates a symphony of beautiful music within the radius of effect. All within the radius must make a save or be so enthralled with the music that all they wish to do is listen to it until it ends. At the end of the music, most hostile thoughts and emotions will have been soothed, and they may be willing to reconsider their violent intentions and be open to negotiation.

If any aggressive action is taken against those listening to the music, they will instantly snap out of the trance and immediately attack without penalty.

## Cloud Haven

**Range:** Line of sight up to 100 feet (30.5 m)

**Duration:** One hour per level of experience.

**Limitations:** Two people +1 per each subsequent level of experience. Cannot be used on one's enemies or opponents, it can only be used to rescue and protect.

**Saving Throw:** None, if used on receptive targets, standard otherwise.

**P.P.E.:** 25

A magical mist sweeps in without warning and whisks those willing to be swept away up into the sky where they vanish into a cloud. The cloud haven is warm, peaceful, calming, and time is distorted to seem half as long as it really is. People can be kept in the haven, away from danger, up to one hour per level of the spell caster's experience. Those whisked to safety can be returned whenever the spell caster desires it. If the spell caster is slain, the characters will remain in the haven for the full duration, before being returned to the exact location where they were first whisked away.

## Fog of Peace

**Range:** 100 feet (30.5 m) per level of experience.

**Radius:** 20 feet (6 m) +10 (3 m) per level of experience.

**Duration:** One minute per level of the spell caster.

**Save:** Standard

**P.P.E.:** 50

This spell causes swirling clouds and fog to move around everybody in its radius of effect. The mist distorts the perception of those affected and clouds thoughts of fighting and revenge. This mental and physical distortion makes all affected uncertain about the battle and reconsider their reasons for fighting. All affected are -5 on initiative, -3 to strike and -3 to save vs Horror Factor.

## Healing Rain

**Range:** Up to 200 feet (61 m) +100 feet (30.5 m) per level of experience.

**Radius:** 100 feet (30.5 m) +10 feet (3 m) per level.

**Duration:** Permanent

**Saving Throw:** None

**P.P.E.:** 100

A gentle rain that feels nice to the touch and which washes away the carnage of battle, including blood, acid, disease, and radiation, plus causes vegetation to grow twice as quickly as normal.

## Winds of Change

**Range:** 200 feet (61 m) +100 feet (30.5 m) per level.

**Duration:** Instant

**Save:** None if used on receptive targets, standard otherwise.

**P.P.E.:** 15

The winds of change will allow the target to rethink his next immediate actions (two melee rounds) and offers insight to possible ramifications. For example, if a character plans to disarm a bomb or accept a foolish challenge because others are teasing him or calling him names, he will get a flash of insight that might show him blowing himself up or accidentally hurting others, etc.). This insight *may* change the character's mind, it's up to the player. The G.M. just points out a few negative outcomes and possible side effects the character may not have considered). Whether the character takes the insight to heart is another matter entirely.

## Winds of Regret

**Range:** 100 feet (30.5 m) +50 feet (15.2 m) per level of experience.

**Radius:** One character per every two levels within a 20 foot (6 m) radius.

**Duration:** Instant

**Save:** Standard

**P.P.E.:** 15

A wind will blow across the character and unless a saving throw is made, will cause him or her to hesitate — bums up two of the opponent's/victim's melee actions/attacks. Like the winds of change, it will also show the character the terrible consequences of his actions and make him pause to consider whether he'd live to regret his actions for the rest of his days. **Note:** This spell is only appropriate when a character is planning or about to act on actions that will seriously harm or kill others. It simply won't work in other situations.



## Clouds of Travel

These are cloud spells that allow the Lyn-Srial to travel at great speed, **teleport** and even dimensional shift.

### Blink of an Eye

**Range:** Self or object weighing less than 50 lbs (22.7 kg).

**Duration:** Instant

**Saving Throw:** None

**P.P.E.:** 24

With a flash of light, the spell caster can instantly teleport to any location within eyesight. The spell caster and everything on his person is **teleported**; however, touching or holding onto a table, trunk, bags of gold, extra body armor, another person, etc., does not pull that item(s) with the mage. In the alternative, the character can teleport a single object, weighing less than 50 lbs (22.7 kg) to any location within eyesight.

### Cloud of Ascension

**Range:** Self only.

**Duration:** 10 minutes per level

**Saving Throw:** Not applicable

**P.P.E.:** One

All Lyn-Srial have this spell. Its use is almost second nature to them, enabling the character to levitate up and down at a speed equal to their speed attribute, and hover in mid-air. There is no altitude limit provided there is breathable air. There is also minimal lateral movement at a speed of 3.

### Cloud Portal

**Range:** Appears within 10 feet (3 m) of the spell caster.

**Size:** 6 foot (1.8 m) radius.

**Duration:** One melee round (15 seconds) per level of the caster.

**Saving Throw:** None

**P.P.E.:** 550

Much the same as the Rifts superior teleport spell, in which the white Cloud Portal will allow any who pass through it to teleport anywhere the spell caster has chosen. The location must be well known to the character and within one hundred miles per level of the mage. The base skill for this is 70% +3% per level of

experience. A failed skill check will find those who enter the portal 1D4×100 miles away from their destination. A roll of double zeroes means that all who enter either reappear in a solid object and are dead, or reappear in the midst of their enemy (poor concentration) or 2D4×1000 miles away!

## Cloud of Speed

**Range:** Self or one other person by touch.

**Duration:** One minute per level of experience.

**Saving Throw:** None

P.P.E.: 15

This magic causes wisps of cloud to appear around the person's feet and raises him a foot (0.3 m) off the ground. The recipient can *run* at the superhuman speed of 50 mph (80 km) without tiring, and also gives the character +1 on initiative and +2 to dodge.

## Cloud Surfing

**Range:** Self or one other person by touch.

**Duration:** 10 minutes per level of experience.

**Saving Throw:** None

P.P.E.: 15

The spell allows a high-flying, airborne character to ride a wisp of cloud in the sky at high altitudes (no limit as long as there is breathable air). The character rides on the wind like a surfer on a wave, except he can change directions, go up or dive (double normal speed). The average speed is 15-30 mph (24-48 km), but storm winds are typically 70-150 mph (112 to 240 km). At speeds faster than 50 mph (80 km), the character must roll to maintain his balance (roll under gymnastic or acrobatic skill, whichever is higher, but with a penalty of -20%). A failed roll means the surfer is swept from his magical surf cloud (it instantly disappears) and falls to Earth. The surf cloud also vanishes when the surfer dips below 600 feet (183 m). This isn't a problem for the Lyn-Srial, who are natural flyers, but can spell big trouble for characters who aren't. A fall from 600 feet does 1D4 M.D. and any S.D.C. being inside M.D.C. armor is still likely to be splattered (1D6×100 hit point/S.D.C. damage).

## Fly Like the Wind

**Range:** Self or one other by touch.

**Duration:** Five minutes per level of experience.

**Saving Throw:** None

P.P.E.: 30

This endows the recipient(s) of the magic with the ability to fly like the wind, at the amazing speed of 150 miles (240 km)! There is no altitude limit as long as there is breathable air. +1 on initiative and +4 to dodge while flying.

## Portal to the Beyond

**Range:** Self and up to one other per level of experience.

**Size:** 10 foot (3 m) long, 6 foot (1.8 m) wide opening in the sky.

**Duration:** One melee round (15 seconds) per level of the caster.

**Saving Throw:** None

P.P.E.: 700

This creates a dimensional portal that appears as a tear in the sky, 30 feet (6) above the spell caster. Flying or jumping into it, the character(s) are either teleported to the Astral Plane (the entire physical and spiritual body is transported) or back to Tryth-Sal, regardless of distance.

# Clouds of Survival

These spells are all of a healing or survival nature. They include survival instincts and abilities, healing abilities, attribute modifiers and even a powerful resurrection spell. Many of the Lyn-Srial are dedicated healers and have many of these spells.

## Aerial Navigation

**Range:** Self

**Duration:** 10 minutes per level of experience.

**Saving Throw:** None

P.P.E.: 4

The character has an excellent sense of direction, can follow land patterns and landmarks as seen from the sky, as well as estimate time and direction from the position of the sun, moon and stars, and always has a sense where Tryth-Sal is located. Equal to the navigation and land navigation skills at 90% proficiency.

## Breath of Life

**Range:** Touch only.

**Duration:** Instant

**Saving Throw:** None

P.P.E.: 100 plus the spell caster permanently loses one P.E. point.

The spell caster can heal all wounds and injury, and restore life (2D6 S.D.C. and 2D6 hit points) to the dying or recently deceased (within the hour) by casting the magic and blowing into his/her mouth. A moment later, the dead character is engulfed by a swirling wind that rushes into his mouth and restores life. This magic does not restore severed limbs or missing organs, such victims are beyond its help.

## Calm Storms

**Range:** Immediate area around the mage, affecting one mile (1.6 km) in diameter per level of experience.

**Duration:** One hour per level of experience.

**Saving Throw:** None

P.P.E.: 200

The spell caster can calm the tumultuous tempest of nature with a simple invocation and 200 points of potential psychic energy. As a spell, the mage can slow a downpour to a light rain, reduce wind speed by half, reduce the size of waves by half, and lighten the dark, stormy skies.

Using the magic in a 10 minute ritual, the mystic can turn a torrential rain into a drizzle, reduce winds to a gentle breeze, shrink ocean waves to normal, disperse a tornado in an instant, and get the sun to peek through clearing skies.

**Note:** Calm Storms is effective against natural and magically induced storms. A typical storm rarely lasts more than four hours (roll 2D4 to randomly determine the length of a natural storm). If the magic outlasts the storm, when the magic ends the storm will have vanished. If the magic ends before the storm, then the skies quickly darken and the storm resumes in full force.

## Cloud of Healing

**Range:** Self or Touch

**Duration:** Instant/3 hours per level of experience.

Save: None

P.P.E.: 15 humans, 45 M.D.C. beings.

This is the most basic of the healing spells. It forms a swirling mist that appears over the patient to draw out all pain, infection or disease (01-60% +2% per level of the spell caster to cure the sick or to restore the injured (pain is gone and restores 2D6 hit points). In addition, the character will continue to heal two times faster than the normal rate. When used on mega-damage beings, this spell restores 3D6 M.D.C. but costs 45 P.P.E.

## Globe of Daylight

**Range:** Near self or up to 30 feet (9.1 m) away.

**Duration:** 12 melee rounds (3 minutes) per level of experience.

**Saving Throw:** None

P.P.E.: Two

A small globe or sphere of true daylight is magically created. The light is bright enough to illuminate a 12 ft (3.6 m) area per each level of its creator's experience. Since it is daylight, it can keep vampires at bay just beyond the edge of the light and may frighten subterranean or nocturnal animals. The creator of the globe can mentally move it along with himself, or send it up to 30 feet (9 m) ahead. The maximum speed at which the globe can travel is equal to a speed attribute of 12.

## Hunter's Instinct

**Range:** Self

**Duration:** 30 minutes per level of experience.

**Saving Throw:** None

P.P.E.: 15

Clouds swirl around the spell caster and the baying of wolves can be heard. Upon completion, the character has the following hunting abilities:

Track animals 90%, track humanoids 75%, track by smell 70%, recognize tracks 90%, identify plants and fruits 80%, and climb 80%.

## See the Invisible

**Range:** 200 feet (91 m)

**Duration:** One minute (4 melees) per each level of experience.

**Saving Throw:** None

P.P.E.: 10

The character can see forces, objects and creatures which can magically turn invisible or are naturally invisible. Even if the creature has no form per se, the mystic will be able to discern the vaporous image or energy sphere of the being. This includes ghosts, entities, elementals and the Astral body.

## See the Light

**Range:** Self or one other by touch.

**Duration:** 10 minutes per level of the spell caster.

Save: None

P.P.E.: 10

This spell enables the recipient to see all spectrums of light, including infrared, ultraviolet, and heat radiation (thermo-imaging). It effectively provides nightvision up to 200 feet (61 m) per level of experience and see aura.

## Tongues

**Range:** Self or others by touch.

**Duration:** Five minutes per level of experience.

**Saving Throw:** None

P.P.E.: 12

The magic enables the character to perfectly understand and speak all spoken languages at 98% proficiency, including elemental and alien tongues. An understanding of written languages is not provided by this spell.

## Warmth of the Sun

**Range:** 6 foot (1.8 m) radius or one person by touch.

**Duration:** 30 minutes per level of experience.

**Saving Throw:** None

P.P.E.: 12

A golden energy sphere the size of an orange appears hovering three feet (0.9 m) above the ground. The energy ball radiates a comfortable heat within its radius of effect. Or the spell caster can touch one person to envelop him in an invisible blanket of warmth (double duration when used on one person).

## Clouds of the Mind

These are powerful spells that only cloudweavers may learn. They deal with the mind and inner spirit and of realms not easy to comprehend. These spells were developed to probe the thoughts of man and to see beyond reality. Because of the nature of these spells and their involvement with the mind, a psionic save of 16 or better is required.

## Cloud of Insanity

**Range:** 20 feet (6 m) +10 feet per level.

**Duration:** One minute per level

**Saving Throw:** 16 or better but bonuses to save vs insanity may be added.

P.P.E.: 30

If the target fails to save, he will no longer feel as if he is in the real world. Equipment will seem to melt in his hands, he will seem to be spinning out of control and he will hear voices. This will totally incapacitate him for the duration of the spell.

## Clouds of Truth

**Range:** One individual up to 10 feet (3 m) away.

**Duration:** One minute per level

**Saving Throw:** 16 or better

P.P.E.: 12

The victim is encircled by a wispy, white cloud. When he lies, the cloud turns grey.

## Mind Fog

**Range:** 10 feet (3 m) +2 feet (0.6 m) per subsequent level of experience, or by touch.

**Duration:** One minute per level of the spell caster.

**Saving Throw:** 16 or better but bonuses vs illusions can be added in.

P.P.E.: 24

The victim of this magic suddenly forgets whatever is most important to him, has trouble remembering anything about the spell caster and is confused; -1 on initiative and -20% on the performance of all skills. When the magic ends, the character's memory and skill proficiencies are completely restored.

## Mind Over Matter

**Range:** Self or other up to 20 feet (6 m) away; line of sight.

**Duration:** One melee round (15 seconds) per level of the caster.

**Saving Throw:** None

P.P.E.: 22

This spell will give the recipient of its magic the will to fight well beyond their physical limitations. In game terms, the character's eyes flash like lightning and he enjoys the following bonuses: Lift weight five times greater than normal, carry three times more than normal, can hold breath three times longer than normal, can ignore his own pain or injury to help others (hit points can be reduced below zero double the normal amount), and is impervious to horror factor, possession and mind control!

## Mist of Illusion

**Range:** 100 feet (30.5 m) +10 feet (3 m) per subsequent level of experience.

**Duration:** One melee round per level of the spell caster.

**Saving Throw:** 16 or better but bonuses vs illusions can be added in.

P.P.E.: 24

A powerful spell that seems to turn the skies black and causes an ominous green mist to appear. In the mist are strange shapes, noises and movement (otherwise the surroundings and real adversaries are unchanged). All those affected by the illusion are distracted and frightened by the movement, sounds and shadowy figures, so they are -4 on initiative, all combat bonuses are half and -4 to save vs Horror Factor. The cloud of illusion has a Horror Factor of 10 +1 every melee round the character(s) are stuck in the illusion. Roll to save vs H.F. at the beginning of each new melee round. A failed roll means the victim loses *two* melee actions or tries to run away — must run 300 yards/meters to seem to escape the mist.

## Spirit Mist

**Range:** Within eyesight.

**Duration:** One melee per level of the caster.

**Saving Throw:** 16 or better.

P.P.E.: 15

A magical mist envelops a 30 foot (9 m) radius and gives a mist-like form and shape to all entities, Astral beings and similar spirits, revealing their presence and movement. It also conveys to the spell caster each of the creature's alignments and general intent (helpful, hurtful, vengeful, etc., or that it is confused and looking for help, etc.).

## Warrior's Mist

**Range:** Self or one person by touch.

**Duration:** One minute per level.

**Saving Throw:** None

P.P.E.: 20

An illusionary spell that creates a dark mist to envelop the recipient of the magic. This mist masks the character's true features and creates an ominous, shifting image making the character affected appear larger, more muscular and with dull glowing eyes. The effect is that all who see him (or her) will believe the character to be stronger, more dangerous and 1D4+1 levels higher than is true.

# Clouds of Creation

These are the spells that are the heart of Lyn-Srial society. All Lyn-Srial buildings, equipment, weapons, armor, etc., are all made from clouds. These items are created by cloudweavers and are permanent magical creations once completed. All of these spells are considered to be ritual magic and most take between a day and a month to complete. Without this knowledge, Lyn-Srial society would collapse.

## Cloudweaving

**Range:** Line of sight no farther than 500 feet (152 m), but the spell caster must actually be inside the cloud to shape it.

**Radius:** 400 feet (122 m) +100 feet (30.5 m) per level.

**Duration:** 12 hours per level of the spell caster.

Save: None

P.P.E.: 100

The spell caster can magically move clouds and connect them together, as well as mold them into basic, large geometric shapes, effectively weaving them together. In addition, the character can create tunnels or giant holes or "V" shapes through the clouds. The magic holds the shapes and features, but does not make the clouds solid enough to stand or walk on — one can still fly through the cloud.

## Cloud Castles

**Range:** Line of sight no farther than 500 feet (152 m), but the spell caster must actually be inside the cloud to shape it.

**Radius:** 400 feet (122 m) +50 feet (15.2 m) per level of experience.

**Duration:** One day per level of the spell caster.

Save: None

P.P.E.: 250 (1000 P.P.E. makes it semi-permanent; one year per level of the spell caster).

Using this magic, the Lyn-Srial can literally sculpt, cut and shape real clouds into architectural shapes and structures with walls, floors, windows, cathedral ceilings, corridors, tunnels, mazes, etc. The magic holds the shapes and features, as well as makes them solid enough to stand and walk on — making them literally floating castles in the skies. Note: Three float above the Grand Canyon near the Golden City.

## Create Cloud Figures

**Range:** Up to two miles in the air (3.2 m)

**Duration:** 10 minutes per level of experience.

**Saving Throw:** None

P.P.E.: 50

The spell caster can mentally sculpt a real cloud to look like a particular figure (warrior, indian, demon, etc.), animal, structure (house, castle, mountain, etc.) or symbol (arrow, sphere, star, etc.). The cloud will hold its shape until the magic ends or the spell caster cancels the magic. Details and features are not possible.

## Create Water

**Range:** 6 feet (1.8 m)

**Duration:** Permanent

**Saving Throw:** None

P.P.E.: 10

A mist will come down from the heavens, fill a container (as directed by the spell caster), and turn into fresh drinking water. Maximum size: one gallon or 3.8 liter container.

## Flying Chariot

**Range:** 10 feet (12.2 m); can only be used by the spell caster.

**Duration:** 15 minutes per level of experience.

**Saving Throw:** None

**P.P.E.:** 80

A chariot made from the stuff of clouds magically appears. It can hold up to four people and has 80 M.D.C. (destroying the M.D.C. will destroy the chariot). The chariot flies under its own power and the mental direction of the spell caster, at a speed of 200 mph (321.8 km). This is one of the Lyn-Srial's favorite means of transportation when they need to transport beings who crawl on the planet's surface.

## Food from the Heavens

**Range:** 10 feet (2 m)

**Duration:** Permanent

**Saving Throw:** None

**P.P.E.:** 80

The spell caster can create manna from the heavens, a light, tasty bread with the nourishment and vitamins of a complete meal. Can create up to 10 pounds (4.5 kg) per level of experience.

## Globe of Daylight

Same as the survival spell.

## Paint the Sky

**Range:** The sky

**Radius:** 3000 feet (914 m) +500 feet (152 m) per level of experience.

**Duration:** Six hours per level of the spell caster.

**Save:** None

**P.P.E.:** 200

Using this magic, the Lyn-Srial can color the clouds or the sky itself in beautiful streaks and hues of yellow, orange, reds, pinks, violets, purple, even greens. The colors are usually artistic and awe inspiring, and make people feel good/happy.

---

# Colorado

By Chris Kornman & Kevin Siembieda

---

## Places of Note

---

### Silvereno

**Population:** 34,000

**Racial Breakdown:**

67% Human	4% Mutant animal
12% D-Bees (various)	4% Elven
4% 'Borgs	3% Orc
4% Psi-Stalker	2% Indian

---

**Average Transient Population:** 2D4×1,000 at any given time; various races and groups.

**Technology Level:** High Technology intermixed with low (i.e. hover vehicles, power armor and energy weapons, but most other technology is roughly equal to 1920s or 30s America).

**Education.** Most people are tradesmen (farmers, carpenters, smiths, etc.) or work in the factories or mills. About 55% can read and write American (English), which is extraordinarily high for the New West, and high for the continent in general. This is the result of the people trying hard at making Silvereno a "big city" and the efforts of the Mayor to educate the citizens, especially children.

**Surrounding Communities:** 10,000 occupants in various dwellings and communities. These people generally raise cattle and livestock, manage farms, hunt/trap/skin animals, or work in the timber industry. They are spread out in an area of about 150 miles (240 km) around Silvereno. Most (85%) are illiterate.

**Terrain:** Silvereno is a large (for the Western Wilderness) city located in western Colorado. It grew up in the mountains of Colorado and became a large and powerful silver mining community. The town is built at the base of the mountains, with the mines throughout them. The climate is generally in the 70 to 80 degree range (Fahrenheit) with low humidity. The area is also heavily forested, populated by small clans of Psi-Stalkers, Simvan and Indians.

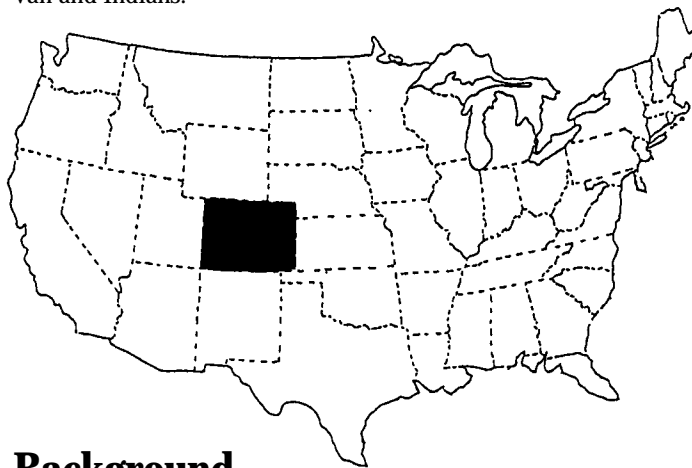

## Background

Silvereno is a large mining town that is the New West's largest supplier of silver. It also has smaller mining operations that extract and process lead, zinc, copper, coal and the occasional, small strike of gold. Mining the silver and minerals is dangerous but profitable. A large group of cyborgs specially designed to do mining work make up a large part of the miners. Much of the trade is with the Colorado River Baronies, Northern Gun, the Manistique Imperium, and Whykin. Silvereno severed all rela-

tions with Tolkeen years ago to avoid any entanglements with the Coalition.

The area around Silvereno is mountain forest, so Silvereno also has a large lumber mill producing timber and wood products. The woodlands also offer excellent game, so there are also hunters, trappers and skimmers who hunt in the forests and visit the town regularly to trade furs and meat, and to enjoy "civilization." These resources have made the community one of the richest, most powerful and heavily defended in the New West. Consequently, technology and the standard of living are generally higher at Silvereno than most other western towns, mainly because the average citizen can afford it. Most houses and businesses have electricity, heating, and indoor plumbing, the hospital is the best in this part of the world, and citizens have reasonable access to electronics (televisions, CD players, language translators, computers, etc.) and appliances (microwaves, ovens, refrigerators, etc.). However, the tech-level of industry is roughly equal to the American Empire of the 1920s and 30s. Factories, smelting plants, and lumber mills are old style, industrial age manufacturers that belch smoke and are a far cry from the ultra-modern, robot operated factories of the Coalition States and Northern Gun. Many citizens are skilled craftsmen, woodworkers, carpenters, smiths, artisans, and other skilled tradespeople.

Life in Silvereno is generally good and attacks from hostile forces tend to occur further to the west and north of Silvereno. For this reason Silvereno is tolerant of most law-abiding people regardless of race, and welcome Indians and human refugees who wish to become a part of the community — the city has a small community of Apache who serve as scouts, craftsmen, healers and lawmen. **D-bees** are generally welcome to visit, trade and even to become citizens, however, they are typically second-class citizens who are viewed with suspicion, fear and sometimes, resentment. The more human looking the **D-bee**, the more likely he/she will be accepted. **Note:** Simvan and Brodkil are viewed as dangerous, man-eating savages and are rarely allowed in town unless accompanied by a group of humans who will "control" their barbaric ally and accept responsibility (pay his debts, damages and accept punishment) for his deeds/crimes. Many a frontiersmen has lost loved ones to these beings, so prejudice and hatred runs high among the settlers in and around Silvereno and many frontier settlements. Keeping company with a Simvan or Brodkil can lead to all kinds of trouble, including hassles from the law, robbery, vandalism, showdowns and gun-fights.

## Government

Silvereno's government is made up of a small council of four people. The mayor who is elected for a four year term, the town sheriff who is elected on a yearly basis, and an elected official from the miners' and lumber mill guilds (four year terms without limits to reelection). These four leaders are expected to see to the day to day administration of the city.

The current mayor of Silvereno is a woman by the name of Gwen Severson. She is a 45 year old, raven haired beauty who doesn't look a day over 30. She has been mayor for the last 12 years and has led the town to prosperity and peace. Gwen is the quintessential politician. She can make everybody happy by skirting the issues and lie to your face while you believe every word of it. That having been said, she doesn't use or abuse her

people and is dedicated to making Silvereno the greatest city in the west. She is a capable administrator as well as stateswoman and silver tongued speaker. Currently, she wants to bring the railroad into Silvereno and turn it into a sort of tourist stop; she has the support of the people on this issue. At the rate Gwen is going, she will be mayor of Silvereno for many years to come.

### Mayor Gwen Severson

**Name:** Gwen Severson

**Race:** Human

**Alignment:** Anarchist with leanings toward unprincipled; she often does the right thing even when she's tempted to do otherwise, but not always.

**Attributes:** I.Q. 18, M.E. 15, M.A. 24, P.S. 12, P.P. 15, P.E. 26, P.B. 24, Spd. 14, Note: Physical Endurance is considered supernatural.

**Hit Points:** 43; **S.D.C.:** 35 (when deprived of the water).

**Mega-damage (Special):** 78 M.D.C., a side effect from her constant use of the water from the healing well of Chichen Itza.

**Horror Factor:** None

**P.P.E.:** 7

**Level of Experience:** 9th level master politician.

**Appearance:** A five foot, 10 inch (1.75 m) tall, beauty with long, flowing black hair, and a trim, shapely figure. Gwen has bright, emerald green eyes that seem to look into one's very soul. She has a very tanned complexion and although not physically strong, is very toned and youthful looking. She always wears a large silver cross, although she isn't particularly religious (she also carries a small silver dagger and a six-shooter with silver bullets).

**Natural Abilities:** Gwen heals very quickly. She can regenerate 4D6 M.D.C. per minute. This ability comes from her constant use of the water of the healing well of Chichen Itza and some sort of magical or dimensional side effect or mutation that has made her a bit more than human.

**Psionics:** Gwen is a major psionic with the powers of sixth sense, total recall, object read, see aura, mind block, empathy, telepathy, and presence sense. I.S.P.: 85

**Alliances:** The vampire group known as "The Lost." Also the entire town of Silvereno and certain high ranking members of the 1st Calvary.

**Combat Stats:**

**Attacks per Melee:** 5; hand to hand: basic

**Bonuses:** +2 to strike, +3 dodge/parry, +2 to S.D.C. damage, +3 to roll with impact or fall, critical strike: 19-20, and Judo style body flip: 1D6+2 S.D.C. and victim loses one action.

**Inside Information:** Gwen is not a warrior, she is a talker, planner and wheeler dealer. She has a sharp mind for details and administration, and can talk her way into and out of almost anything. Mayor Severson has bodyguards and agents who do her fighting for her, however she is well liked and has very few enemies.

The Mayor has made a secret pact with a vampire group known as **The Lost**. These "cooperative" and honorable (!) vampires live in and around the town of Silvereno. They keep a watchful eye on the mining operations, keeping them safe from claim-jumpers and bandits at night, as well as keeping the peace and keeping other vampires and supernatural creatures away (usually by fighting and slaying them). They also supply the Mayor with water from the well of Chichen Itza, which keeps her young and makes her a mega-damage creature.



The *Healing Well of Chichen Itza* is renowned among the people of the Yucatan for its amazing healing properties; a single sip (roughly one tablespoon of water) restores/heals, and being immersed in the water will restore the dead to life. What is not known is that taking a sip of the water every day, will keep a person healthy (impervious to disease and poison) and young (aging slows dramatically). Gwen Severson has also learned that after drinking the water daily for a decade, it also transforms you into a minor mega-damage creature (the hit points and S.D.C. numbers are combined to determine the M.D.C., in this case 78 M.D.C.). As long as she is supplied with the water of Chichen Itza, she will age at a rate of one year for every ten and will continue to be an M.D.C. creature. If for some reason she is stopped from getting the water, she will return to an S.D.C. creature (loses M.D.C. at a rate of 10 points every two days; when all M.D.C. are gone, she is an ordinary human again) and begins to age very quickly (two years every two days till she reaches her current age). At this point she will be much like a drug addict needing a fix. She will do almost anything to keep her supply of water coming to her.

In return for the vampires' protection, and assistance (they are among her most powerful, and secret, "agents"), Mayor Severson helps protect and hide them. To sate their bloodlust, she allows them to feed on outlaws and enemies who invade the area. In fact, the vampires have six *Simvan* chained in a secret place where they feed on them regularly, milking them like cows! Mayor Severson tries not to think about this, although she hates *Simvan*. The vampires are also allowed to feed upon, enslave, and kill cattle rustlers, CS spies, and outlaws. Occasionally, the Mayor calls upon them to hunt down and destroy bandits and criminals, with whom they can do with as they please — her secret, supernatural posse.

For 15 years, this secret alliance with the vampires (mostly Secondary Vampires of aberrant alignment) has served both Severson and the city of Silvereno well. The vampires have proven to be discreet, clever and honorable — living up to their end of the bargain, although they never give the Mayor more than a 30 day supply of the magical water she so desperately depends upon (their insurance policy).

Rumors that vampires exist in the area have persisted for decades, however the Mayor and most inhabitants (99%) insist it's not true. "Maybe there were vampires here once, 40-50 years ago, but not anymore." **Note:** See **Rifts® World Book One: Vampire Kingdoms** for more information about vampires, Mexico, the Yucatan, traveling shows, werepeople and other good stuff.

## The Law in Silvereno

The town of Silvereno has a police force made up of *Sheriff Whispering Wind* and about two hundred deputies. Disputes are usually settled quickly and with as little violence as possible. The deputies are all between 3rd and 6th level, and wear mega-damage body armor. The armor is usually LDA I or II, Huntsman, or Bushman. All deputies are issued a CFT 1886er and a CFT "Double Barrel." The deputies generally get around either by horse or motorcycle.

The rules and laws in Silvereno are pretty much common sense: Keep the peace and don't cause any trouble.



Mega-damage weapons and armor can not be carried on the streets and anybody caught doing so will have their weapons confiscated and spend the next week in jail.

Roughhousing and "friendly fights" are tolerated as a way to blow off steam, but any damage to property or injury to innocent bystanders are not tolerated and will bring the law in to put a quick end to the brawl. The fighters will be forced to pay for any damage and injury. Serious fights and crimes are dealt with quickly and efficiently.

Assaulting a deputy and using lethal weapons/force against an officer of the law can lead to imprisonment or hanging, depending on the intent and circumstances.

Minor crimes such as vandalism, thefts, con-games, loitering, drunkenness/disorderly conduct, and similar have fines of 50 to 500 credits and/or 1-4 weeks in jail. Restitution to the wronged parties is also typically part and parcel with these crimes.

Major crimes such as murder, attempted murder, gun-fights/showdowns in the street, dueling, armed robbery, cattle rustling, horse theft, attacks against the mines, and willful destruction of property (i.e. city property, the mills, mines, homes, and things important to one's livelihood) typically carry 2D4 years of jail and hard labor to the maximum penalty of hanging. Hangings are comparatively rare in Silvereno and most citizens are peaceful and law abiding. The sheriff and his deputies double as a town militia against raiders and bandits, and in times of war. In a pinch, another 2D4×100 townspeople can be armed and brought up as reinforcements/defenders within a matter of hours. An additional 3000 are members of the volunteer army but would take one or two days to mobilize.

**Sheriff Jacob Whispering Wind** is an Apache warrior who became disenchanted with his own clan, became an adventurer, and eventually came to settle down in Silvereno. He soon became a respected member of the community. His courage, strength of character, loyalty to the community and skills as a warrior, hunter, and tracker made him an obvious choice for town sheriff. He accepted the honor and has been sheriff for a little over two years. He is highly respected, trusted and known for his fairness and strict code of honor, by humans and D-bees alike. Whispering Wind would give his life in defense of the town he has grown to love.

Sheriff Whispering Wind does not trust the Mayor, because he has learned she is a mega-damage being (a secret most don't know) and because she rarely gives him a straight answer — he hates double talk and politics. He knows something just isn't right about Mayor Severson, he just can't put a finger on it. However, since the people love and trust the Mayor, and she does seem to be doing good things for the townspeople, the Sheriff focuses his attention on maintaining law and order. **Note:** He also suspects there are one or two vampires in the area, although he finds it curious that they seem to only victimize crooks, low lifes and tramps.

## Sheriff Whispering Wind

**True Name:** Jacob Whispering Wind

**Race:** Human/Indian

**Alignment:** Principled

**Attributes:** I.Q. 15, M.E. 21, M.A. 19, P.S. 24, P.P. 22, P.E. 17, P.B. 14, Spd. 24



**Hit Points: 39, S.D.C.: 49**

**Horror Factor:** None

**P.P.E.:** 125

**Level of Experience:** 7th level Arapaho Spirit Warrior.

**Appearance:** Whispering Wind is a small man who stands only 5 feet, 6 inches tall, although his personality and reputation often makes him seem much larger. He is very stern looking and always seems to be in deep thought. To look into his brown eyes is to look into the eyes of the eagle — sharp, alert, majestic and deep — eyes that seem to look into one's very soul.

**Disposition:** Whispering Wind is known for his intelligence, wisdom and common sense. He is observant, alert, quick to action, and resourceful. He stands strong, courageous and unwavering from his duty and what he knows is right and good. In many ways he is the classic, tough but noble Wild West sheriff, bold, confident and fair.

**Magic Abilities (Special):** Whispering Wind is an Arapaho Spirit Warrior with the animal totem of the eagle. This totem gives him the following innate abilities.

Fly as the eagle (5 P.P.E.)

Speak with birds (10 P.P.E.)

Spirit of the Eagle (10 P.P.E.): This endows him with 50 more S.D.C., a +1 to all combat actions, one additional attack, and +10 S.D.C. points of hand to hand damage.

Eyes of the Eagle (8 P.P.E.): This endows him with superior vision (can see a rabbit 2 miles down the road) and a tracking skill of 75%.

Eagle's Cry (25 P.P.E.) — A cry of anger and vengeance: Those who hear it, will know whether this cry of anguish is directed at them, and that they have been marked for revenge that will be swift in coming (the warrior must strike within the hour). Those so marked are -4 on initiative, -2 on all other combat bonuses and lose two melee attacks, but only when facing the accusing warrior who cried for vengeance. Duration of these penalties lasts until vengeance has been served, but apply only to those marked and only when facing their accuser. The Eagle's Cry can only be used when vengeance is sought against a terrible wrong, like the murder of a loved one, the slaughter of numerous people, a great act of treachery, and so on.

**Psionics:** Whispering Wind is a minor psionic with the powers of clairvoyance and sixth sense. I.S.P.: 66

**Alliances:** The Sheriff is respected and loved by the townspeople who will follow his lead and stand at his side in times of trouble. His deputies will follow him without question and will fight by his side to the end. Whispering Wind also has many Indian and wilderness friends he can call upon if the need arises.

**Attacks Per Melee:** Six; hand to hand: expert.

**Bonuses:** +3 on initiative, +6 to strike, +7 to dodge/parry, +3 to pull punch, +3 to roll with fall or impact, +9 to S.D.C. damage, critical strike on a roll of 18-20, kick attacks do 1D6+9 damage, or 2D4+9 S.D.C. damage from an auto-kick.

**Skills of Note:** Read and write 60%, math 80%, identify plants & fruits 65%, hunt, fish 80%, cook 75%, radio: basic 70%, track (humanoids) 70%, track animals 70%, land navigation 75%, wilderness survival 70%, W.P. archery, W.P. blunt (war club), W.P. energy pistol, W.P. energy rifle, all at 7th level proficiency.

**Equipment of Note:** He carries a Wilk's-Remi laser rifle and a CFT 1886er, neural mace, pocket knife and Apache war club at all times.

**Magic Items:** The only armor he wears is a magical Apache war necklace made from bones, wood and various other materials. This amulet provides Whispering Wind 100 M.D.C. and can be worn by no one else. The M.D.C. of the war necklace/amulet regenerates at a rate of 1D4×10 M.D.C. per hour.

He also has a magical eagle's talon which can inflict 4D6 M.D. as a weapon or with an expenditure of four P.P.E. points per attack, as if it is a ranged weapon for 4D6+5 M.D. — flying out like a missile, clawing or impaling and returning to the Sheriff (counts as one of his melee actions; 200 ft (61 m) range. Whispering Wind also has in his possession various native clothing and other standard equipment.

**Note:** Deputies range from 3rd to 6th level; 70% are human, 30% D-bees. 20% are Indians of varying O.C.C.s, 2% Gunslingers, 4% Gunfighters, 5% Juicers, 10% are partial reconstruction 'Borgs, 5% full conversion 'Borgs, and the rest are various men at arms, mostly cowboys, scouts and basic foot soldiers.

## The Lost

---

For most people in the New West vampires are but a legend and a myth, rumored to exist in Mexico, Texas and New Mexico. These vile creatures could not possibly exist, could they? Unknown to just about everybody in town, a group of vampires has actually made it this far north. This group migrated from demon infested **Chichen Itza** in the Yucatan, to the north many years ago. They have settled in the town of Silvereno for many reasons. First, since a lot of the people simply did not believe vampires exist in Colorado (they are a rarity), and feel safer because of the silver mine, the vampires could hide in plain sight, so to speak. Second, by being extremely careful and preying on villains and people that the settlers didn't like (and usually away from town), nobody should suspect their presence. The vampires are also careful not to leave signs of their presence; i.e. victims with puncture wounds in their necks and other vampire trademarks. Third, the town keeps potential new victims coming to the region (to buy and sell goods, rob the place, spy, raid, etc.), which provides the vampires with more victims who are "outsiders." Fourth, their alliance with Gwendolynn Severson provides even greater protection, although this has been a recent development. Fifth, the vampires' discretion, the location and the people's confidence that there aren't any vampires in town is a wonderful cover for their activities — few Cyber-Knights or vampire hunters come here expecting to find the undead.

The current leader of the vampires is an ancient *Master* Vampire known as **Essai Ramirez**. Ramirez leads his vampires intelligently and keeps his group small and very well hidden. The only people in the area who know of the vampires are either allied with them, under their control, or are killed when they discover them. Ramirez's master is a vampire intelligence that resides thousands of miles south, in Chichen Itza. This intelligence supplies Ramirez with the water from the Healing Well and likes the idea of having a secret foothold in North America. Although the vampire intelligence has considered schemes to invade the north, for the time being, it does nothing, and uses The Lost as a reconnaissance team to gather information.



The vampire's second in command is a secondary vampire simply known as **Katherine**. She is in love with Ramirez and will do anything he asks of her. She will also mercilessly kill anyone who comes between her and her lover. A hundred years ago, Katherine and Ramirez loved each other with all their hearts, but were kept apart by their families. The vampire intelligence of Chichen Itza sensed this and offered Ramirez the chance to love Katherine for all eternity. That very night, Ramirez was transformed into a vampire. Two nights later, Katherine disappeared from her home and was never seen again. They have been together ever since and are devoted to each other in warped and evil ways.

### **Essai Ramirez — The Vampire Lord**

**True Name:** Essai Ramirez

**Race:** Master Vampire

**Alignment:** Aberrant

**Attributes:** I.Q. 18, M.E. 20, M.A. 26, P.S. 36, P.P. 25, P.E. 23, P.B. 20, Spd. 32; note: All attributes are considered supernatural.

**M.D.C./Hit Points:** 200

**Horror Factor:** 14

**P.P.E.:** 40

**Level of Experience:** 8th level Master Vampire.

**Appearance:** Essai is a small, thin vampire, 5 foot, 9 inches tall, and weighing only 140 pounds (63 kg). He is dashing in appearance, but his eyes are a cold, lifeless steel blue in color. He typically wears casual clothes (pants, shirt, boots, gloves, and a Mexican hat), a cloak and an armored breast plate with 50 M.D.C.

**Disposition:** Calm, cold and calculating. He has little regard for life and sees all mortal beings as potential pawns, playthings and food. He is using Mayor Severson for protection as he keeps a foothold for his master in the North. Upon the command of the Vampire Intelligence, Essai will launch a campaign to transform thousands of Silvereno residents into vampires and enslave the rest. Until then, he waits like a festering blister, ready to erupt and spread its puss and venom. Despite his foul, predatory nature, the vampire has his own code of ethics and is a ... er ... man of his word.

**Natural Abilities (vampire):** Impervious to all attacks except wood, silver, holy water, sunlight and magic. Limited metamorphosis (bat, wolf, and mist), super regeneration (2D6 hit points per melee), smell blood up to one mile (1.6 km) away, nightvision 1600 feet (488 m), does not breathe, summon rodents, summon canines, summon fog and supernatural strength. See **Rifts® Vampire Kingdoms** for complete descriptions of these abilities.

**Skills of Note:** Land navigation 65%, wilderness survival 70%, W.P. energy pistol, W.P. energy rifle, and W.P. knife, all at 8th level proficiency.

**Psionics:** Like all vampires, Essai is a master psionic with the abilities of mind control, link with minions, death trance, alter aura, empathy, mind block, presence sense, sense evil, deaden pain, induce sleep, hypnotic suggestion and super hypnotic suggestion.

**I.S.P.:** 165

**Alliances:** Essai is the leader of the vampire group known as the "Lost," therefore he is the lord of all vampires in the area and has an allegiance with Mayor Gwen Severson.

### **Attacks per Melee: 7**

**Bonuses:** +3 on initiative, +9 to strike, +12 to parry and dodge, inflicts M.D. from punches and kicks (supernatural), +6 to roll with impact or punch, critical strike: 18-20, Judo style body flip: 6D6+21 S.D.C or 1D6 M.D.C., victim loses one action; bite: 3D6 M.D., restrained punch: 6D6+21 S.D.C., full strength punch: 7D6 M.D., power punch: 1D6×10, kick: 4D6 M.D.

**Equipment of Note:** Essai frequently wears a 50 M.D.C. breast plate and carries an NG-P7 Particle beam rifle and a TX 500 rail gun.

Magic items include vials of water from the well of Chichen Itza, a ring that can cast the agony spell four times a day at +4 spell strength (Save 16 or higher; equal to a 6th level spell), and a necklace made from snail shells that can cast the spell speed of the snail four times a day at 6th level and +4 to spell strength.

**Note:** Essai rarely enters combat but commands his minions like a general. He is in Silvereno to observe and survive, not to fight. Remember, he and his vampires usually feed on drifters and bandits outside the city so as to not arouse suspicion.

### **Katherine — The Vampire Queen**

Katherine owns and runs a saloon and brothel in Silvereno, known as the **Lucky Lady**. Her unsavory occupation keeps Katherine away from gentle society, allows her to be somewhat wild, helps her (and her minions) pick out drifters and visiting trouble-makers (to rob, kill and feed on), and explains why she is never seen during the day. Katherine is an infamous nightclub personality known to be a party animal and vixen, as well as rumored to be a thief who plunders those foolish enough to sleep with her (little do they know). Essai is known as her mysterious, gambler lover and rumored to be a retired smuggler and gunslinger.

**True Name:** Katherine Delgado

**Race:** Secondary Vampire

**Alignment:** Miscreant

**Attributes:** I.Q. 16, M.E. 18, M.A. 22, P.S. 26, P.P. 22, P.E. 25, P.B. 26, Spd. 21; Note: All attributes are considered supernatural.

**M.D.C./Hit Points:** 110

**Horror Factor:** 12

**P.P.E.:** 30

**Level of Experience:** 6th level Secondary Vampire.

**Appearance:** Katherine is beautiful by any standard. She stands just over 5 feet, 8 inches tall (1.72 m) and is a lithe muscular beauty. Her milky (vampire) pale complexion is usually accentuated with bright red makeup and nail polish, and her long, black hair. The contrast of the red and black on the pale skin makes for a striking appearance. She likes fine clothing, dresses, furs, and jewelry.

**Disposition:** The transition from human to vampire has made Katherine a monster. She sees all humans as puny animals waiting for her kind to enslave and feed on them. She feels superior to all mortal beings, and longs for the day when they can come out of hiding to build a kingdom of vampires in Colorado. Her love for Essai borders on the insane. She is obsessive, protective, and has flown into many jealous rages over the most insignificant incidents. If Essai is slain, she will make it her vendetta to find those responsible and kill them slowly and painfully.



**Natural Abilities (vampire):** Impervious to all attacks except wood, silver, holy water, sunlight and magic. Limited metamorphosis (bat, wolf, and mist), super regeneration (2D6 hit

points per melee), smell blood up to one mile (1.6 km) away, nightvision 1600 feet (488 m), does not breathe, summon rodents, summon canines, summon fog and supernatural strength. See **Rifts® Vampire Kingdoms** for complete descriptions of these abilities.

**Psionics:** Katherine is a major psionic with the abilities of mind control, link with minions, death trance, alter aura, empathy, mind block, presence sense, sense evil, deaden pain, induce sleep, hypnotic suggestion and super hypnotic suggestion. I.S.P.: 120

**Alliances:** Katherine's only true ally is her true love Essai. She would kill for him without question, and has done so on more than one occasion. Otherwise, she recognizes Essai and the Vampire Intelligence as her only masters; all others are pawns and victims.

#### **Attacks per Melee: 6**

**Bonuses:** +3 on initiative, +6 to strike, +8 to parry and dodge, +5 to roll with impact or punch, critical strike on a roll of 20, Judo style body flip: 5D6+11 S.D.C. or 1D4 M.D. plus victim loses one action. Supernatural P.S. does mega-damage, bite does 2D6 M.D.C., restrained punch: 5D6+21 S.D.C., full strength punch: 5D6 M.D., power punch: 1D6×10 and kick: 4D6 M.D.

**Equipment of Note:** Katherine is always seen wearing dresses and expensive clothing. She rarely carries any modern weapons, preferring the brutality of ancient blades, Vibro-Blades and other hand weapons. She does, however, carry a small Remi-Derringer energy pistol. The rings and gem-studded necklaces she wears are easily worth 150,000 credits.

Katherine's prize possession is a magical Indian war spear that inflicts 5D6 S.D.C. to humans, 5D6 M.D. to supernatural creatures and M.D.C. structures, and double damage to vampires! Can be thrown 500 feet (152 m) when 4 P.P.E. or 8 I.S.P. are pumped into it.

Note: Katherine tends to be brutal in combat and enjoys the sight, smell and taste of blood, fear and agony of her prey. She will always attempt to maim and torture before she kills and is a master of intimidation and torture.

#### **Vampire Minions**

Fourteen secondary vampires (two D-bees, one Simvan and the rest human; 70% female) and two wild vampires serve as the Vampire Lord's and Queen's loyal servants and henchmen. Four of the females work at Katherine's brothel/saloon. All are roughly 3-5th level.

### **Places of Note in Silvereno**

**1. The Silver Mines.** Silvereno is a mining town that has grown and prospered because of its vast reserves of silver and other mining operations. As a result, the town of Silvereno is built on and around hundreds of silver mines that descend deep within the earth. These mines, and the men and women who work them, are the lifeblood of Silvereno. Currently there are 12 working mines and about 20 that are no longer in use. This is in addition to 2-4 copper, zinc, coal and other mines.

**2. The Mayor's Mansion.** The Mayor's mansion is where most of the affairs of Silvereno are discussed and handled. Although Silvereno has a town hall and city council building, Mayor Severson prefers to entertain and arrange for pleasant

dinners and quiet meetings to handle much of the town's business. The Mayor's mansion is also the site of lavish parties and lively balls (at least once a month, for any number of possible reasons). This enables the Mayor to better ply her skills of manipulation, negotiation, and diplomacy and gives her home ground advantage.

The Mayor's mansion is a four story, wooden and white brick building that sits upon a twelve acre estate on the edge of town. Visitors must first pass a security building, M.D.C. iron fence, and through a beautifully kept garden (where many summer parties are held). Other buildings on her grounds include the servants' house, and stables with a dozen of the finest quality riding horses, and a small farm. The terrain around the mansion is mostly hilly forest.

The Mayor's security force is made up of 24 Special Deputies, and 8-12 are on duty at all times and patrol the grounds day and night (this is in addition to the regular police force). 24 Triax DV-12 Dyna-Bots supplement the security force. All are armed with T-P7 particle beam rifles or Wilk's-Remi FR557 flechette rifles. The human guards wear full environmental body armor with about 70-80 M.D.C. each.

**3. Silvereno Sheriff's Department.** This is a two story, M.D.C. building that includes administrative offices, a jail, shooting range, armory, and a small barracks for Silvereno's law enforcement officers (can accommodate 30 comfortably). Behind the Sheriff's Department is a garage (with certified operators) and parking lot for hovercycles (typically Northern Gun Speedsters, but also includes a dozen Prowlers and two dozen Turbos, all with 1-3 weapon systems), and a couple dozen robot horses. The garage also holds four suits of Triax X-10 Predator Power armor, a pair of Triax X-500 Forager Battlebots and a pair of NG-V7 Hunter Mobile Gun Robots (see **Rifts® Sourcebook One** for complete stats on these bots).

Sheriff Whispering Wind spends little time at the Department, preferring to "walk the beat" as much as possible. He can usually be found checking on his deputies, and cruising the town and its outskirts in his Big Boss ATV, complete with blue police light bar on top, ever vigilant for signs of trouble.

**4. The Militia HQ & Armory.** Located on the other side of town, away from the Sheriff's Department, is the meeting place of the Silvereno Volunteer Militia. It is a big, convention style, one story, mega-damage building (2000 M.D.C.) surrounded by a barbed wire fence. Weapon stockpiles include 1200 suits of inexpensive Plastic Man body armor (35 M.D.C.), 400 Urban Warrior body armor (50 M.D.C.), 1200 basic energy rifles, a few hundred rail guns and heavy weapons, 4000 fragmentation grenades, 120 Triax DV-12 Dyna-Bots, ten X-10 Predator Power armor, six Triax X-500 Forager Battlebots, a pair of NG-V7 Hunter Mobile Gun Robots and a hundred hovercycles (see **Rifts® Sourcebook One** for complete stats on these bots).

**5. The College of Silvereno for Higher Education.** This is a small campus that offers a number of classes and areas of training. However, it is more like a school for adult education than a true university. It offers classes on learning to read and write, computer operation, computer programming, basic mechanics, basic electronics, and several trade schools in wood and metal working as well as the arts.

**6. Town Hall and City Council Building.** The former is the site of political, civic and public meetings and festivals. The City Council Building is mostly administrative offices.

**7. Silvereno Hospital.** A medium-sized, modern hospital that has 200 beds, and excellent facilities, including Cyber-Docs. It is one of the top medical facilities in the entire New West!

**8. Silvereno Cybernetic Augmentation Center.** A small, privately owned hospital that specializes in the repair, installation and conversion of cybernetic implants, bio-systems (costs twice those in the East), and bionics.

**9. The Silver Palace Dance Hall & Casino** is advertised as a place to bring the entire family. It features old style video arcade games for kids, three different restaurants, an ice cream parlor, 10 bars, a pair of movie theaters (each seats 800 people), six small theaters for live acts (mostly concerts and dance shows), an arena for boxing, wrestling and indoor sports events (seats 7,000), plus an indoor park with fountains, merry-go-rounds, two water slides, cable car ride, and six floors of gambling; everything from cards and dice to slot machines and roulette.

**10. The "Trail's End" Saloon.** The Trail's End is the most popular saloon in town. Like most saloons, it comes complete with a small inn upstairs and has many shows and games to pass the time away. Because of the general caliber of people in Silvereno, the Trail's End tends to be a pretty friendly, laid back bar, with few serious fights or altercations. Prices are a bit higher than elsewhere because it's so safe and popular. Average drinks range from 3-8 gold, and expensive drinks 10 and up. The food is delicious and comes in large portions; average price range is 8-16 credits. A room costs 100 credits a night but comes with hot and cold running water, a bath, shower, lights, TV and videodisc player, and a large, comfy bed. Illegal activities are not allowed and weapons are checked at the door — a big, 9 foot (2.1 m), full conversion 'Borg and a grizzled, old Dog Boy check and guard the weapons (5th and 9th level respectively).

The bartender is an ex-wilderness scout and amateur prospector known only as "Buck." He is a 53 year old human who claims to have "seen it all." If he can be believed, Buck once scouted for the Coalition Army, was partners with a Cyber-Knight named Sir Richard Vandaveer, killed the notorious bandit Black Marvin (he disappeared 25 years ago), lived at Tolkeen (17 years ago), battled Xiticix, rode with the Saber Warriors in the Pecos Empire (when he was a young'en), and has been a scout, mercenary, prospector, trapper, saddle tramp, and now, lives the quiet life of a barkeep. Buck stands six feet (1.8 m) tall, has a bionic right arm (with laser finger and a pair of retractable Vibro-Sabers), and has a weathered look about him. Although a bit gruff, down to earth and a braggart, Buck has a certain charm about him. He is well liked throughout the community and has a soft spot for pretty ladies, mothers, children and Dog Boys. He is usually armed with a single *CFT 86er* and *Neuro-Mace* which he keeps behind the bar. He is always willing to tell stories about his adventures, share local rumors and spin a tall tale or two. Buck Willis: Attributes: I.Q. 10, M.A. 15, M.E. 11, P.S. 17 (20 with the bionic arm), P.P. 14, P.E. 18, P.B. 12, Spd. 13; Unprincipled alignment; 10th level Wilderness Scout. Buck has owned and operated the Trail's End Saloon for 10 years. It has expanded three times since it opened.

**11. The Lucky Lady Saloon.** This is a place of ill repute. It is a saloon, gambling hall and brothel that caters to travelers, cow-pokes, drifters, and outsiders (like player characters). In addition to its games of cards, dice, and chance, it offers hard li-

queer and carnal pleasures for reasonable prices. It is as good a place as any to get the latest gossip, news and rumors about the area, and is said to have connections with smugglers and fences. Both the vampires, Katherine and Essai, are usually found here (Katherine owns and runs the place, see her description earlier). It is a place that tends to attract a rough crowd and criminals, and is excellent for gathering rumors, the current dirt on notable citizens, and for hiring thugs.



**12. The "Shaft" Saloon.** The Shaft is a medium-sized saloon on the outskirts of town, near the entrance to the mines. It is a local hangout with the miners, and is packed around the clock (open 24 hours a day). The drinks are strong and cheap; average price is 1-4 credits, with a special moonshine called "Borg Battery Acid," the house favorite (one shot is the equivalent of 3-4 drinks to a normal human, and local gossip claims that battery acid is one of the ingredients).

The Shaft tends to be a dark, smelly, very rough saloon with frequent brawls and many drunks. Gambling and games include cards (mostly Poker and Black Jack), shooting craps, arm wrestling, boxing and wrestling. It doesn't have an inn above it but does have two rooms that the owner will rent out to any miner who needs them; available on a first come, first served basis. There are also a half dozen, heavy wood benches and picnic tables outside where patrons can enjoy the fresh air or sleep it off.

Outsiders are regarded with suspicion, and the local miners, be they 'Borgs, Juicers and other augmented people, stick together, so outsiders looking for trouble will suddenly find themselves facing 80-300 angry superhumans if they push their luck. The average citizen gives The Shaft a wide berth.

The owner is *T.C. Brennan*, one of the first miners to opt for the Mining-Cyborg augmentations. He worked the mines for 16 years and saved every penny to buy this bar and to send his son and daughter to school in Lazlo. He has owned and operated the Shaft for 4 years now, and is known to always give a miner a break. He is, of course, a full conversion miner 'borg but has replaced the drill on his right arm with a standard, mechanical bionic arm and hand. He keeps his chemical sprayer in his chest filled with knockout gas just in case things get out of hand, and tries not to seriously hurt anybody. Unfortunately, the gas doesn't work on many 'Borgs or Juicers, and things have gotten pretty rough in the past where they are concerned. The Shaft was almost completely destroyed when two Mining 'Borgs got into it and began to throw each other around. T.C. was able to stop the fight by pulling out a heavy plasma grenade that he keeps behind the bar. The 'Borgs stopped when he threatened to fry everybody. T.C. still keeps that same grenade behind the bar ... even though it is a fake.

**13. The Silver Dollar Saloon** is an establishment that falls somewhere between the Trail's End and Lucky Lady. It is a medium-sized place with an inn and show-girls. Prices are average on the low side, drinks and food are good quality and the saloon is reasonably safe. However, there is a group of regulars reputed to have connections with the Black Market and involved in smuggling. The most notorious members of this group includes Dirk Blane, a supposedly retired, 8th level Gunslinger; Willy Sly, a young **Wired-Gunslinger** (3rd level, diabolic) with a hot temper and a joy for killing; and "Ricky the Dragon" Frralla, a 6th level Simvan warrior. The rest of the group are supposedly "honest" businessmen at Silvereno, they include: Randolph McCoy who owns a large general store (he's really a 7th level smuggler and fence); Winston H. Baltone, a wealthy partner in one of the silver mines (8th level forger, with political aspirations), Carlene Baltone, wife to Winston (6th level Ley Line Walker); and Gene **Quartermane**, a world traveler and wealthy gambler (really a liaison to the Black Market). All are anarchist or evil alignments, and opportunists who have high hopes in building a criminal underground at the growing city.

**14. Mine Shaft 8.** A place rumored to be haunted by demons and ghosts. It is closed to the public, and often bad luck and misfortune is blamed on the forces locked inside Shaft Eight.

## The Story of Shaft 8

As the story goes, Simon and Ray descended slowly into the shaft one morning. They made sure all of their gear was in working order and mentally checked all of their cybernetic parts for the days work ahead of them. When they reached the bottom of the shaft, they headed towards the newest part of the mine where they were to extend the tunnel even deeper into the earth below. The low whine of cyborg **thermographic** eyes could be heard in the silence as they adjusted to the lack of visible light. Two shrill motors of high-powered drills screamed to life as Simon and Ray began to drill through the rock, quickly and efficiently. They had done this a hundred times before, so it was just another

day at the office. After about three hours of digging, Simon, or was it Ray, broke through into an open cavern. The two 'Borgs checked maps and attempted to get a feel for their location.

Simon was the first to cross into the cavern to investigate. He quickly realized that they had definitely broken into another mine shaft, but one much older than any of **Silvereno's**. Old tracks and mining equipment were lying everywhere. He was excited that they had unearthed a piece of history, and artifacts that would most certainly bring a high price from collectors. Simon began to collect some of the ancient mining equipment as Ray walked along, exploring the ancient shaft.

Suddenly, Simon heard the screams of his fellow 'Borg from down the shaft. He rushed into the darkness to see a horrible specter standing over Ray's cyborg body, tearing him limb from limb. Simon turned to run and it all went black.

A day later, another mining crew descended into Shaft Eight in search of the two 'Borgs — they had not checked out for the day and never went home. As they came to the opening to the ancient shaft, they found the discarded remains of Ray and Simon's cyborg bodies. The remains were literally embedded into the walls of the mine with the crushed cyborg heads still leaking brain matter. Simon's face plate had been torn off to reveal a crushed face that had the unmistakable look of sheer terror on it. The mining crew ran in terror from the horror they had seen. Nobody has ever descended into shaft 8 ever again and to this day, the shaft remains closed, or so the story goes.

## The Horrible Truth

The horrible creature that killed the two 'borgs was neither a specter or a ghost but something much worse. Something much more dangerous.

When the Great Cataclysm occurred, ley lines swelled with energy, the Rifts came, and magic literally exploded back onto the earth. Cities fell, millions died, and aliens and demonic creatures were unleashed into the world. Worse, doors to other dimensions often appeared to lure foolish adventurers to their doom, or unleashed some nightmarish creatures on Earth. The old mine shaft is the location of one such doorway. A door that opens and closes randomly and unpredictably. Where it leads, nobody knows. Many who have gone to investigate have either been slain and literally torn to pieces, or have disappeared entirely. Since then the shaft has been sealed. Nothing has ever emerged from it, and occasionally, special investigators/adventurers are allowed down to explore the shaft in hopes of unraveling the mystery. Some report finding nothing but the dried blood of those who have come before them, and return without incident. Others disappear. And still others are heard screaming and shooting until they are silenced by death.

G.M. Note: One or more terrible creatures frequently inhabit the ancient mine shaft. They attack and slaughter all interlopers. The dimensional door, from which the demons come, opens to some horrible alien dimension. This can be *Wormwood*, a domain of demons, *Old Ones*, *the Nightlands*, *the Mechanoid Homeworld* or any number of equally terrible places that the Game Master may come up with.

---

# The Colorado Baronies

---

The great cataclysm, so many years ago, was the single most significant event ever to happen to mankind as a whole. Millions died in one instant of nuclear fury. Billions soon perished as mother Earth literally tore herself apart. Mankind quickly and violently became an endangered species. But as mankind struggled for survival in the Dark Ages after the Great Cataclysm, a wondrous thing happened. Great mystical energies were released from the ley lines and encircled the wounded earth to accelerate nature's claim on what was once hers so many millennia ago.

Most of the surviving members of humankind would spend generations simply fighting to survive and to take stock of the mystical changes. Demons and horrible monsters seemingly spawned from the very pits of hell appeared from nowhere to cleanse earth of the pest known as humankind. Even with these horrors and trials put forth on them, a small band of survivors from what was left of *Denver Colorado* headed northeast towards a great, glowing azure light. Most felt that they were making a pilgrimage to heaven or even hell but no one really knew. Upon reaching the **Platte River**, the thousands of survivors were aghast to see a giant flowing wall of sparkling blue energy that seemed to travel the length of the river (at least from their vantage point).

Many feared that radiation was the cause, others demons, still others believed that it was a last sign that the end was near — most could feel power surging through their very bones. Whether it was exhaustion or inspiration, these people knew that this was where they would make their stand. This is where they would rebuild ... live and die. Within a few months, a small village grew on the banks of the Platte near the ruins of *Greely*. They called their new home, **Hope**.

The most amazing thing happened when a massive group of demons seemed to appear from the skies above to rain destruction on the arrogant human settlers. The demons were horrible beasts that fed on the flesh of man. As the Denver survivors defended their small village some of the people felt power surge through them, enabling them to perform strange and wondrous feats, which in the end, drove the monsters back. The tattered and beleaguered people had just discovered magic.

Within a generation, a full third of the people had become natural Mystics — people with an innate understanding and acceptance of both magic and the psychic world. With their abilities to sense danger, heal, and perform many feats of magic, their small village quickly grew. With the growth of Hope, many more magic wielding humans and friendly D-bees immigrated into this bastion of humanity. The city grew at an impressive rate. Utilizing magic, psionics, and a mishmash of old and new technology, Hope flourished when many others across the world floundered and perished. Within thirty years, Hope stood strong as a city of understanding and a beacon of light to mankind.

As the next generation of rulers came into power, the city began to move in a new direction. Under the leadership of **Baron Christopher Von Linden**, an aggressive series of exploration voyages were sent up and down the Platte river as well as the Colorado River and various tributaries. These voyages were to





both map this brave new world and to plant the seeds of humanity elsewhere, so they too could grow. The great river expeditions took 15 years and many lives, but its success was more than any could have dreamed. Where other survivors were discovered, the people of Hope extended their hand in friendship, and helped them to establish their own towns or welcomed them to Hope. In time, they would grow to become the **Colorado Baronies**.

Along the now raging Colorado River (western Colorado, southeast Utah, and northern Arizona), there was only wilderness, monsters and the occasional mountain man, trapper or hostile D-bee. However, the explorers found a cloud city populated by friendly D-bees in the Grand Canyon. The D-bees called themselves the Lyn-Srial, although most humans would come to know them as the Golden Ones or Sky-Knights. They said that they fell to Earth from the clouds, a place they called the Skylands. They came in peace and welcomed the travelers as friends. With time, the Golden Ones would come to the city of Hope and help its people build a peaceful civilization. They would also teach some of its people to become *Sky-Knights* and *Cloudweavers* (Note: Hope is the only kingdom outside of Tryth-Sal to possess the knowledge of Cloudweaving. Only a few hundred people from Hope have proven to be up to the task; all are of good alignment, have studied for a decade or more under the Lyn-Srial, agree with their ethics and laws, and are dedicated to peace. See the sections on Cloud Magic and the Sky-Knight and Cloudweaver R.C.C.s).

## The Colorado Baronies Today

Baron Von Linden's acts of exploration and charity gave birth to the Colorado Baronies located along the **Platte River**. Presently the Baronies have grown into four cities and a collection of towns, villages, farms and ranches that stretch along the snaking river. Magic and ley line activity are a daily routine and magic is used extensively throughout the region. However, many of the towns and communities, especially the newest ones, have few to no practitioners of magic and rely entirely on hard work and simple technology.

Northeastern Colorado is very different than the Rocky Mountains, hills, gorges and forests most people think of when they think about Colorado. Except for the backdrop of mountains to the west, and the occasional hill and scattered forest along the river, most of the land is prairie and with the rise of the Baronies, farms and ranches.

## Technology Level

The technology of the Colorado Baronies varies from place to place. *Hope* and the other large city-Baronies of *Charity*, *Testament*, and *Wilmington* have a technology level roughly equal to the 1970s, while the outlying communities are all generally small farming, ranching, trading or mining towns with tech-levels that range from the 1700s with little or no technology or magic, to the Industrial Revolution of the late 1800s. The river is traveled by steamboats, barges, modern hydrofoils and Techno-Wizard craft.

Magic and **Techno-Wizardry** are commonplace at the cities and big towns, but here again, the level of advancement and availability will vary dramatically from minimal to pervasive like Hope. In many respects, Techno-Wizardry and magic in

general, "is" the technology of the Baronies, although modern technology and science have arrived with a bang in the last 20 years, thanks to the Baronies being discovered by Northern Gun, Manistique and the Black Market (which in turn has made the CS aware of the kingdoms' existence). Sights such as Techno-Wizard trains, stagecoaches, and horses along with exotic animals and dinosaurs ridden by D-bees, plus Ley Line Walkers, Glitter Boys, Cyber-Knights, armor clad adventurers, robot horses, weapon laden gunfighters, lawmen, gunslingers, cowboys, D-bees, the occasional dragon and more, are all commonplace in the baronies.

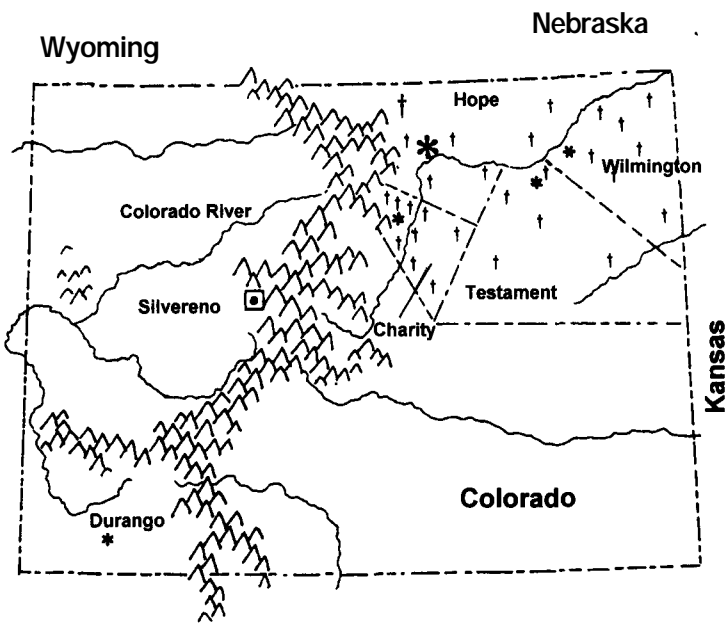
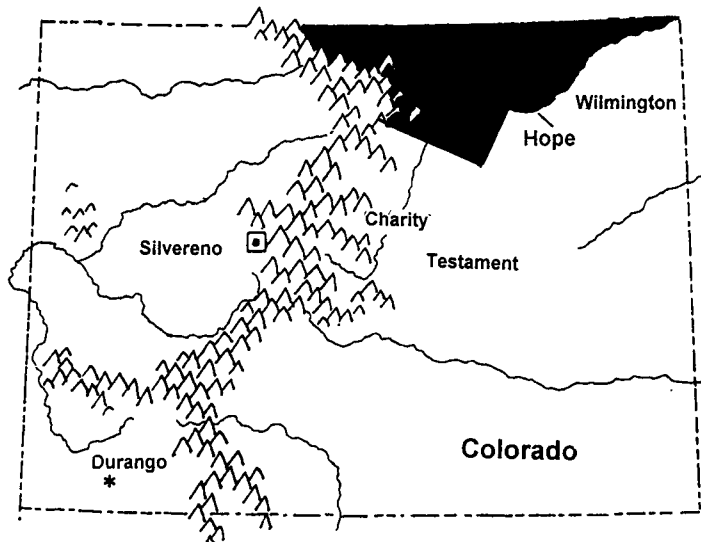

## Communities Around the Cities

The surrounding communities are mostly farms and ranches run by hard working but happy humans and D-bees living a simple life as free men. The occasional high-tech farming community and ranch can be found, but generally the majority of the people use horses, oxen, or magic to plow their fields and make their lives a little bit easier. TW plows, rain storms conjured to water crops, and horses that travel through the air are common everyday sights.

It is at many of the small, scattered towns, often 50-100 miles (80 to 160 km) to its nearest neighbor, that lawlessness and trouble from outlaws, rustlers, hostile D-bees and invading monsters are most common, especially around *Charity*.

## The Barony of Hope

**Population:** A current population of approximately 61,800.

### Racial Breakdown:

77% Human	
5% Psi-Stalkers	1% Mutant animals
2% Fennodi	15% Other D-Bees

**Transients:** 1D6×1000 transient visitors are in the area at any given time.

**Surrounding Communities** that are officially part of the Barony of Hope include hundreds of farms, several large ranches and the towns of Salvation (pop. 3600), Resurrection (pop. 1800), Wheatfield (pop. 970), Carson (430), Petesville (320), and Trinity (240), plus the Pawnee North Plains once known as

the Pawnee National Grassland (pop. 1480 Pawnee, 200 Arapaho, 150 other).

**Note:** All communities in the Barony of Hope are populated by civilized, peaceful and law abiding folk. All towns with fewer than 500 people have a sheriff and a deputy, the big towns have a sheriff and 2D4 deputies, plus the entire range is regularly visited by Cyber-Knights. Techno-Wizardry is commonplace and 1-6% of the towns' population are Mystics and 0.5% are Techno-Wizards. Technology is not shunned but tends to be combined with magic in some way. Techno Wizardry is a revered and popular practice.

**Level of Education:** Fair to good. Most (90%) speak fluent American at 92%, about half (47%) are literate, and most (80%) speak one or two additional languages fluently. About 30% are also well versed in lore about ley lines and magic.

## The City of Hope

**Population:** A current population of approximately 52,000.

### Racial Breakdown:

79% Human
2% Psi-Stalkers
4% Fennodi
14% Other D-Bees: Including Vanguard Brawlers, Quick-Flex Aliens, a small number of Cactus People and others.
1% Others, including a few dragons, a hundred Golden Ones/Lyn-Srial, and a handful of other supernatural beings and creatures of magic.

**Transients:** 6D6×100 transients can be found in the city at any given time. They come to trade goods, seek employment, acquire Techno-Wizard items, gamble, enjoy the sights and pleasures of big city life, and rest and relax.

### O.C.C. Breakdown of the Population:

32% Mystics, many of whom own businesses, run shops, work as lawmen and engage in a variety of enterprises, including healing, counselling, and fortune-telling, as well as simple farmers and laborers.
--

11% Techno-Wizards (but only 10% of those are higher than 8th level; average level is 4-7).
---

10% Operators — builders and mechanics.
---

8% Other professionals: doctors, scholars, scientists, etc.
---

3% Ley Line Walkers
---------------------

1% Other practitioners of magic.
----------------------------------

### 1% Mind Melters

34% Others, including laborers, gamblers, cowboys, etc.

**Level of Education:** Good to excellent. All residents speak American at 98%, most (81%) are literate, and most (89%) speak one or two additional languages fluently. About 60% are well versed in lore about ley lines and magic. Many libraries, museums and schools dot the city. Erin Tarn was so taken by the city and its people that she called it "the Lazlo of the West."

**Hope** is the largest city of the Colorado Baronies and literally a place of magic. It is built directly on a ley line with a nexus on the north edge of town. Hope is located near where the city of *Greely* once stood; Greely was obliterated when the ley lines erupted during the Great Cataclysm. Its buildings stand up to eight stories high (taller structures only attract too much notice and brings trouble) and were built using magic and some technology. The streets are crowded with people, and conventional vehicles ride alongside Techno-Wizard vehicles and horses, both mechanical and real. The skies above Hope are congested with a variety of Wing Boards, TK-Flyers and sorcerers, all of which use the energy of the ley line to fly. The river is full of vessels that use the same magic energy of the ever present ley line to drive them. Huge paddle boats act as floating buildings for gambling, traveling, and even defense. Much of the city (85%) is powered by magic — a testament to the Techno-Wizard masters who helped build (and reside in) the city. Hope also offers a glimpse at the wonders of such mystic communities as Tolkeen, Lazlo and places within the Magic Zone.

Hope is the Techno-Wizard center of the New West. A full 11% of its population are Techno-Wizards and virtually every type of TW device imaginable is built, used and sold there. The presence of magic and practitioners of magic also serves as the City's greatest natural defense. In its nearly 200 years of existence, from small town to a bustling city, Hope has been attacked by an invading army only twice and bandits give the place a wide berth.

## Government & the Law in Hope

Hope is currently ruled by *Baron Joseph Midgard*, a 14th level Mystic who is a scholar at heart. He feels the only way for mankind to survive is to learn history so as to not repeat it. He has adopted a great deal of the philosophies of the Golden Ones and has instituted many education reforms in and around Hope and plans to continue the mapping and exploration of the American continent.

The government of Hope is a simple one. The Baron holds all power and decision making ability but has a Cabinet of Advisors who run the day to day operations of the city and help him oversee the entire Barony and maintain law and order. Half of this cabinet are men, women and **D-bees** selected by the Baron (which currently includes two *Lyn-Srial*, an 8th level Cloud-weaver and a 9th level Sky-Knight). The other half (24 people) are elected by the people. The current administration is seeking to improve and modernize the city with better uses of magic and is seeking to educate all the people within its borders.

The law in Hope is one of tolerance and reform. Because of the number of wizards and powerful psychics that walk the streets, potentially deadly conflicts could very easily erupt, but such battles are a rarity. The people of Hope have always striven for peace, even in its earliest days. Since then, and with the guid-

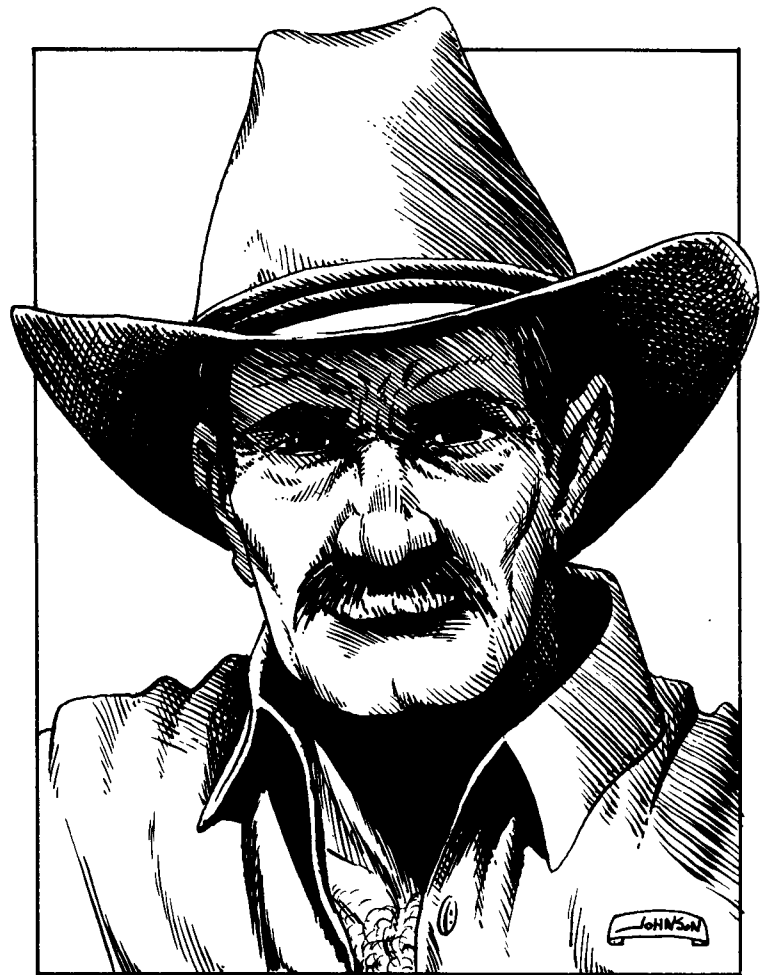

ance of **Cyber-Knights**, **Golden Ones** and **Fennodi**, the city has become a place of law and order where people are encouraged to speak freely and express themselves constructively. Its prosperity and generations of strong, noble leaders have helped to make Hope an oasis of peace and splendor in a wilderness of violence, treachery and the horrific.

Mega-damage body armor and power armor are not permitted in the city, nor are mega-damage weapons of any kind. Cyborgs, Juicers, Crazies, mages, superhuman beings and gunmen of all kinds are expected to leave their weapons with the authorities and to abide by the laws of the Barony or face punishment and banishment from their community. Generally speaking, the laws and punishments of the Barony are roughly equivalent to the 20th Century, with one big difference, there is a very real and effective program to reform criminals (50% success rate); the program is managed by a dozen Golden Ones. Mystics and other psychics use mind probes to interrogate suspected criminals and use their psionic powers to investigate crimes and apprehend criminals with minimal loss of life or injury. Some, including the *Lyn-Srial*, consider such tactics a violation of human rights and as unjust and immoral, but most feel that this is the best way to keep crime to a minimum, and most Cyber-Knights, lawmen and city leaders encourage it.

---

**The police force of Hope.** 50% of the entire force is made up of mystics, psychics, and sorcerers. They tend to wear light body armor and are armed with a mix of high-tech weapons, TW weapons and their innate psionic or magic abilities.

---

Breakdown of the Police Force: Six Precincts with 140 police officers in each.

10% Mind Melters; average levels of experience: 4-8

5% Experienced Mystics; average levels of experience: 7-10

20% Mystics; average levels of experience: 3-6

15% Practitioners of Magic; average levels of experience: 2-6

25% Police Inspectors; equal to 4-9th level Sheriff, Ranger or Gunfighter.

25% Police Officers; equal to 2-6th level Deputy, Cowboy or Merc.

## The Other Baronies

### Barony of Testament

**Population:** A current population of approximately 31,500.

**Racial Breakdown:**

50% Human

10% Psi-Stalkers (work on the many ranches)

3% Fennodi

1% Mutant animals

36% Other D-Bees

**Transients:** 1D6×100 transients are in the area at any given time, mostly drifters.

**Surrounding Communities** that are officially part of the Barony of Testament include dozens of farms and dozens more large ranches, as well as the towns of Morgan (pop. 1100), East Range (pop. 800), Prairie Town (pop. 470), New Lindon (pop. 240), and Brush (180).

**Note:** Most of the communities in the Barony of Testament are populated by peace-loving and law-abiding folk, but things can get a bit wild, boisterous and dicey in the cattle towns and cattle ranges. All towns with fewer than 500 people have a sheriff and a deputy, the big towns have a sheriff and 2D4 deputies, plus the entire range is regularly visited by Cyber-Knights and the occasional Justice-Ranger. Techno-Wizardry is commonplace and 1-4% of the towns' populations are Mystics and 0.2% are Techno-Wizards. Technology is not shunned but tends to be combined with magic in some way.

**Level of Education:** Fair to good. Most (90%) speak fluent American at 92%, about a third (32%) are literate, and most (80%) speak one or two additional languages fluently. About 30% are also well versed in lore about ley lines and magic.

### The City of Testament

**Population:** A current population of approximately 28,700.

**Racial Breakdown:**

52% Human

12% Psi-Stalkers (mostly cowboys and handlers of livestock)

6% Fennodi

30% Other D-Bees

**Transients:** 2D6×100 transients can be found in the city at any given time.

**O.C.C. Breakdown of the Population:**

20% Mystics

5% Techno-Wizards (but only 10% of those are higher than 8th level; average level is 4-7).



6% Operators — builders and mechanics.  
 6% Other professionals: doctors, scholars, scientists, etc.  
 2% Ley Line Walkers  
 1% Other practitioners of magic.  
 1% Mind Melters  
 40% Cowboys and ranch hands, or those who do work related to livestock.  
 19% Others

**Level of Education:** Fair to good. All residents speak American at 96%, over half (56%) are literate, and most (90%) speak one or two additional languages fluently. About 40% are versed in lore about ley lines and magic.

**Testament** was the second barony and major city to sprout up with help from Hope. It is different from Hope in that the Barony is cattle country and the people are a bit more rough and tumble, although law-abiding and generous. Its leader is Baron Salvador Mendoza, a 6th level Mind Melter of scrupulous alignment, but a hard man when it comes to justice. Its government, laws and practices are virtually identical to the City of Hope.

## The Wilmington Barony

**Population:** A current population of approximately 28,700.

### Racial Breakdown:

55% Human  
 2% Psi-Stalkers (work on the many ranches)  
 10% Fennodi  
 1% Mutant animals  
 32% Other D-Bees

**Transients:** 1D4x100 transients are in the area at any given time, mostly drifters.

**Surrounding Communities** that are officially part of the Barony of Wilmington include scores of large to medium farms, and a few ranches, as well as the towns of New Sterling (pop. 2200), Valley City (pop. 960), Yuma (pop. 650), Harvest Town (pop. 570), Greenville (pop. 330), Karlfield (pop. 260), and Goldenfield (210). Note: Most of the communities in the Barony of Wilmington are populated by law-abiding folk who keep to themselves. All towns with fewer than 500 people don't have any resident lawman, while the big towns have a sheriff and 1D4 deputies, plus the entire range is regularly visited by Cyber-Knights and the occasional Justice-Ranger. **Techno-Wizardry** is commonplace and 1-4% of the towns' populations are Mystics and 0.2% are **Techno-Wizards**. Technology is not shunned but tends to be combined with magic in some way.

**Level of Education:** Fair. Most (86%) speak fluent American at 90% efficiency, and most (80%) speak one or two additional languages fluently. Only 25% are literate in any language and about 30% are also well versed in lore about ley lines and magic.

## The City of Wilmington

**Population:** A current population of approximately 23,500.

### Racial Breakdown:

62% Human  
 2% Psi-Stalkers (mostly cowboys and handlers of livestock)  
 6% Fennodi  
 30% Other D-Bees

Transients: 1D6x100 transients can be found in the city at any given time.

## O.C.C. Breakdown of the Population:

16% Mystics  
 2% Techno-Wizards (but only 10% of those are higher than 8th level; average level is 4-7).  
 8% Operators — builders and mechanics.  
 5% Other professionals: doctors, scholars, scientists, etc.  
 3% Other practitioners of magic.  
 1% Mind Melters  
 20% Cowboys, scouts and ranch hands.  
 45% Are farmers or those who do work related to farms and livestock.

**Level of Education:** Fair to good. All residents speak American at 95%, half are literate, and most (90%) speak one or two additional languages fluently. About 30% are versed in lore about ley lines and magic.

**Wilmington** always welcomes strangers and has festivals or community events and celebrations every Saturday night and church on Sunday. Holidays are another time of revelry and rejoicing. The people here are some of the friendliest in the region, a marked contrast to the quiet conservatism of the surrounding towns and farms who tend to keep to themselves and are wary of strangers.

The leader of Wilmington is *Baroness Ariel Spelttwist*. She is a fun loving, 9th level Mystic who wields her magic in fun as much as for any other reason. She is a capable ruler but tends to be slightly impulsive. She is a very visible leader who always makes an appearance at festivals and town meetings, and tries to greet as many new visitors to her city as she can. The Baroness is loved by the city residents and is a master at diplomacy and trade negotiations. However, many of the towns and farms within the Barony fear that her openness to "the outside" and "frivolous parties" could be potentially detrimental to the Barony. The most conservative people point to the lawlessness of *Charity* and suggest they are headed down that way, but so far, nothing bad has come to pass and Wilmington prospers.

Its government, laws and practices are virtually identical to the City of Hope.

## The Barony of Charity

**Population:** A current population of approximately 19,500.

### Racial Breakdown:

55% Human (a quarter of which are innocent workers)  
 15% Psi-Stalkers (mostly mercenaries and bandits)  
 5% Simvan (mostly mercenaries and bandits)  
 1% Mutant animals  
 21% Other D-Bees (mostly peasants)  
 3% Demons and supernatural monsters

**Transients:** 6D6x100 transients are in the area at any given time, mostly outlaws, bandits, mercenaries and scalawags.

**Surrounding Communities** that are officially part of the Barony of Charity include a handful of farms, a dozen mining operations, the Big Max Ranch (pop. 590) and the towns of Deadwood (pop. 2700; built on the ruins of Denver), Hangman's Bluff (pop. 1960), Castle Rock (pop. 1650), Mountain Valley (pop. 670), Pottersville (pop. 390), Tombstone (pop. 350), Forest Glen (pop. 270) and **Kalvin** (140).

**Note:** Total anarchy reigns at most towns in the Barony of Charity. Only *Mountain Valley* and *Kalvin* are law-abiding

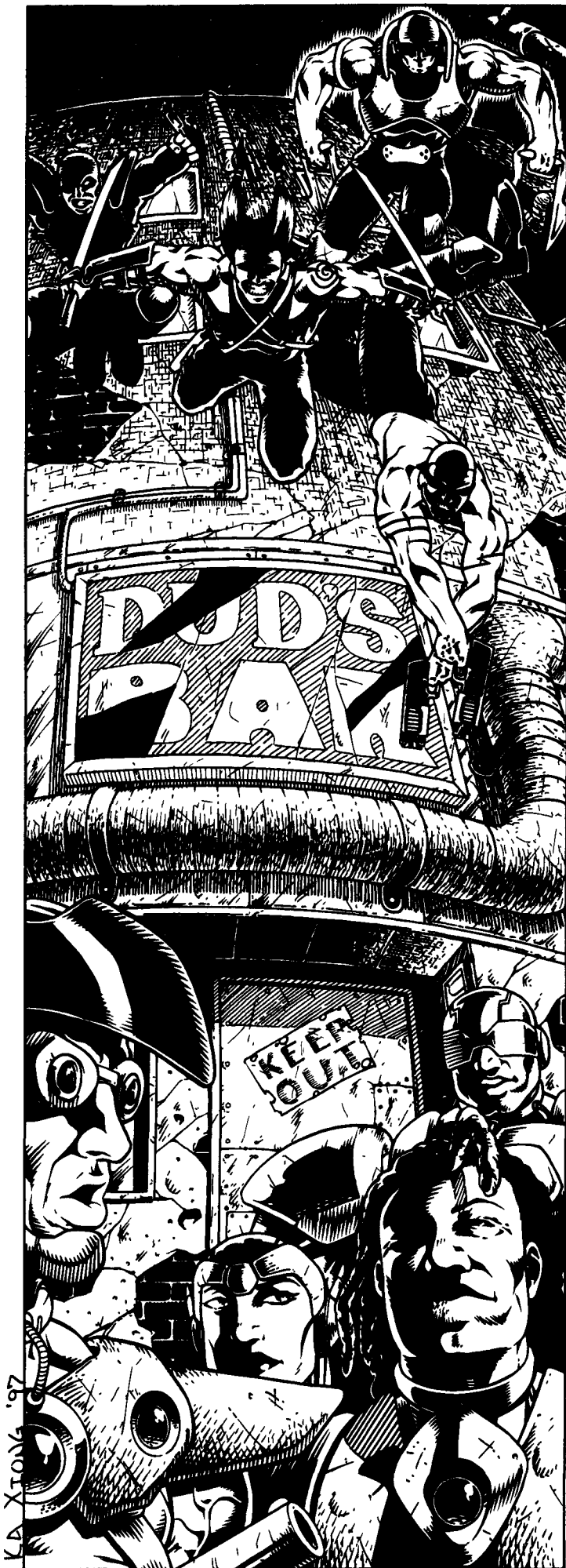

places where visitors are safe. *Deadwood* and *Hangman's Bluff* are complete and total dens of iniquity. All towns and with fewer than 1000 people don't have any resident lawmen, the big towns have two men who call themselves sheriffs (typically 'Slingers) and 1D6+6 deputies each (typically meres, bandits and gunfighters). These so-called "lawmen" are present to prevent the towns from getting completely torn apart and to protect important business establishments like saloons, gambling halls and drug dens.

**Level of Education:** Fair. Most (81%) speak fluent American at 90% efficiency, and most (80%) speak one or two additional languages fluently. Only 15% are literate in any language, and about 20% are versed in lore about ley lines and magic.

## The City of Charity

**Population:** A current population of approximately 10,700.

### Racial Breakdown:

- 60% Human
- 12% Psi-Stalkers (mostly cowboys and handlers of livestock)
- 2% Simvan
- 21% Other D-Bees
- 5% Demons and supernatural monsters.

**Transients:** 1D6×1000 transients can be found in the city at any given time, including outlaws, crooks, mercenaries, adventurers, vagabonds, Saddle Tramps, Professional Gamblers, Gunfighters, Juicers, 'Borgs, Preachers and Bounty Hunters.

### O.C.C. Breakdown of the Population:

- 8% Mystics
- 5% Techno-Wizards (but only 10% of those are higher than 8th level; average level is 4-6).
- 5% Other practitioners of magic (average level: 3-6).
- 1% Mind Melters (average level: 3-6)
- 10% Operators — builders and mechanics (average level: 5-10)
- 5% Professionals: Doctors, Cyber-Docs, Scholars, etc.
- 8% Cowboys & Wilderness Scouts (average level: 2-6)
- 10% Professional Criminals (average level: 3-8)
- 8% 'Slingers: Gunslingers, Psi-Slingers, Wired Slingers and Cyberslingers (average level: 2-5)
- 8% Gunmen: Gunfighters, Headhunters, and mercenaries.
- 5% Juicers
- 5% 'Borgs
- 22% Others: Includes farmers and laborers.

**Level of Education:** Fair to good. All residents speak American at 90%, a third are literate, and most (90%) speak one or two additional languages fluently. About 30% are versed in lore about ley lines and magic.

**The City of Charity** is anything but charitable and has become a mockery of its name. It is the newest of the *Colorado Baronies*, only 76 years old. It was built on the continuing "charity" of the City of Hope, which encouraged a cluster of towns to unite and was given guidance and support. Charity started out as a community patterned after Hope and the other Baronies. It grew up in the foothills of the Rocky Mountains southwest of Denver and engaged in mining, lumber operations, cattle ranching, farming and trade with outsiders. Unlike the other, older baronies, the people of Charity always seemed to play fast and loose with the rules and didn't share the respect for life and accomplishments that the others did. The mentality of the people here is that life is too short and you are dead a long time, so enjoy life. Unfortunately, this has been taken to the extreme, mak-

ing this Barony what most people think of as the "Wild West." One or more showdowns, shootouts and backstabbing occur daily, and brawls and robberies occur constantly somewhere in town. Handguns, **Vibro-Blades** and light weapons, and body armor are all permitted in the city. The city is quickly becoming a haven for drifters, gamblers, saloon bums, outlaws, gunslingers, snake oil salesmen, crooks, and scalawags of all kinds.

The force that represents itself as "the law" in Charity is little more than a private army that protects the interests of the powerful landowners and business tycoons that control the city. Most residents don't even call upon the authorities, except to report murders and arson. Most other crimes committed against them are either quietly endured or left to vigilante justice — a showdown, shooting, hanging in an alley or on the outskirts of town, a beating, tar and feathering, etc. Travelling preachers, Cyber-Knights, Justice-Rangers or compassionate adventurers may stand up for the people and bring some relief and justice, but such "outsiders" must be extremely careful not to start a war or vendetta against the very people they're trying to help. Likewise, such justice and peace is usually short-lived, ending when the visiting stranger(s) leave town — often followed by retribution for their defiance.

The pleas of the other Baronies fall on deaf ears and even the intervention of the Golden Ones have met with failure. For the time being, the other Baronies log their protests, offer suggestions, and provide what little assistance they can to the innocent who suffer at Charity (they are always welcome to leave the city and come live with them). However, there are increasingly few "innocent" people left in the City. Rumors persist that the rulers in power at the City not only allow and promote all manner of illicit behavior (gambling, blood sports and prostitution being the least of them), but are actively involved in cattle rustling, smuggling, fencing stolen goods and providing sanctuary to known desperados. It is said that things have gotten so out of hand that even a Cyber-Knight or Sky-Night is not safe on its streets! The fear is that sooner or later, the other Baronies will have to declare war against Charity to curb its growing evil and increasing danger to the Colorado Baronies as a whole.

**Baron Nathaniel Zane** is a 7th level Ley Line Walker with a black heart (aberrant alignment; I.Q. 17, M.E. 15, M.A. 23, P.E. 21) and a passion for wealth and power. He personally gets a 10% cut off the top of *all* businesses, legal and illegal. He owns the largest gambling Casino (the Golden Eagles), three saloons and a **Techno-Wizard** weapons shop. In addition, he gets a 20% cut from all Bandito Arms and Black Market operations, which include a Body-Chop-Shop, Juicer and Crazy augmentation, and arms dealers, along with many other businesses and services that appeal to the baser side of people.

**Zane's** right-hand man is *LordLamphrey*, a wizened looking elf reputed to be the fastest gun in the West and a retired assassin (I.Q. 15, P.P. 26; 10th level Gunslinger; miscreant alignment). Among **Baron Zane's** hand-picked council are the most powerful and corrupt men in the Barony.

The government is loosely structured after Hope, minus the electorate. Likewise, the laws, when enforced, are basically the same, expect **Baron Zane** and his High Council can choose to forgo a trial and make judgements and assign punishment, from hard labor to immediate execution — hangings are very popular.

## Other Places in Colorado

A handful of other tiny towns, homesteads, clans and tribes can be found in southern Colorado. The only other notable town of size and merit is New **Durango** (Pop. 1400). It is a mining and trade town that can be a bit wild at times and has its troubles with outlaws, but tries to be a fairly law-abiding town.

**Western Colorado and the Rocky Mountains** are monster filled wildernesses.

---

# Rodeos

By **Julius Rosenstein**

---

A very popular pastime in the pre-Rifts American Southwest, Rodeos have made somewhat of a recovery on Rifts Earth, and are especially popular in the Western Wilderness. However, they are not as widespread or as commonplace as circuses, carnivals, and traveling shows. Although rodeos have been held as far north as Canada and as far south as Mexico, they still seem to take place mostly in the Southwest and the areas just east of the Rockies (seldom east of the Mississippi River).

Rodeos serve a dual purpose. Not only are they a form of entertainment for cowboys and noncowboys alike, but they provide an arena for cowboys to hone their skills, test their mettle against their fellows in (usually) nonlethal competition, and maybe win a few extra credits along with some local notoriety (a ribbon, bottle of bourbon and 100-1000 credits are commonly awarded to the winners of such competitions).

Because of the number of different **D-bee** races and superhuman creatures, the rodeos of Rifts Earth can boast a diversity of events that their pre-Rifts counterparts could never have imagined. However, since cowboys are generally a conservative lot, many of the events are those that traditionally appeared in the past. As a general rule, if the event involves horses or bulls, it's probably a holdover from the pre-Rifts era. If it involves **Ostrosaurus** or some other exotic creature, like monster wrestling, then the event came about after the Great Cataclysm.

There are some events that existed in pre-Rifts times but were not connected with rodeos. Horse racing, horse jumping, and steeplechases are some notable contests that were separate sports before the Time of the Rifts and have since become rodeo events.

Although there are a number of different events, most have two criteria that will determine the victor — speed and endurance. In contests of speed, whoever finishes first is the winner. These contests include various racing, roping, and wrestling events. For contests of endurance, the winner is whoever hangs on the longest. These contests usually involve riding an animal like a bucking bronco, wild bull, etc., that does not wish to be ridden. Of course, strength, accuracy and skill are factors in these events as well.

The number and the diversity of the events will vary with the size and the composition of the rodeo. However, the smaller rodeos will tend toward the more traditional events while the larger ones have more diverse events and a carnival feel to them — complete with rodeo clowns, jugglers, acrobats, dancing girls, music, freak shows, traveling zoos, pony rides, trick riding





performances, games of chance (dice, darts, knife throwing, shooting, etc.), and similar attractions and entertainment. As an example, the **Buckaroo Bonanza Rodeo** is the largest in the Pecos Empire, and possibly the largest in North America. It is likely to have the full gamut of events as follows. Those events marked with an asterisk are traditional **pre-Rifts** sports events, although they may not have been a traditional rodeo event:

**A. The Grand Entry Parade** \*: Before the actual contests begin, there is a parade featuring the rodeo participants. This not only gives the spectators a chance to see many of the contestants and all rodeo hands (workers and performers), it also provides the competitors themselves with the opportunity to size up their rivals, but is, for many (particularly those competitors whose performances are less than stellar), the high point of the rodeo.

**B. Riding contests**: These events pit a rider atop of some kind of belligerent animal. The rider attempts to stay on as long as possible, with the winner being whoever stays on the longest (typically 10-20 seconds). There are often different animals and levels of difficulty depending on the race and augmentation of the contestants. For example, Juicers, Crazies, and 'Borgs are not allowed to compete with ordinary humans. Note: **Simvan** and **Psi-Stalkers**, who can psionically control animals, are generally banned from participating in these events. They are not usually offended by the exclusion and find it amusing to watch other beings struggle with animals they could control with ease. **Simvan** and **Psi-Stalkers** are often among the head animal handlers, especially of wild, mean-tempered animals.

1. **Bronc Riding (bareback)** \*: The steed in question is a horse that the rider must ride for a minimum of 8 seconds without benefit of a saddle.

2. **Bronc Riding (saddle)** \*: Nearly the same event as the previous one, except that now the horse is saddled before the rider gets on. A score of from 8 to 10 seconds is fairly standard.

3. **Bull Riding (bareback)** \*: Similar to bronc riding, only now the animal is a bull that must be ridden for a minimum of 8 seconds. For this event, trained rodeo clowns are on hand to distract the bull once the rider is thrown. Unlike broncs, who are usually content just to rid themselves of their rider and then move away, bulls will aggressively seek to attack their former rider.

4. **Ostrosaurus Riding (bareback)**: Essentially the same as trying to ride the other animals, albeit the leaps when the animal bucks are far greater and this animal may try to claw, bite (even when muzzled) and kill its rider.

5. **Rhino-Buffalo Riding**: "No, No, No! Rhino-Buffalo riding is NOT an event! For the past four years, those crazy Simvans have been lobbying to have it entered in the rodeo, but it's too dangerous. Granted, the Buffalo Hunter Simvans have tamed a few of these creatures, but these giant beasts are too ornery and unpredictable." A quote from a Bonanza Rodeo official who wishes to remain anonymous.

When this or similar events are included, it is typically reserved for **Simvan**, **Psi-Stalkers**, **Juicers** and other augmented or superhuman beings.

**C. Roping contests**: These events involve competitors trying to rope and securely tie some animal. The winner is whomever accomplishes this feat the fastest.

1. **Calf Roping** \*: In this event, a calf is released into the arena. A few seconds later, a horseman armed with a lasso pursues the calf. The horseman must lasso the calf and tie three of its legs together to secure it. The usual time required for this is from 8 to 12 seconds.

2. **Team Roping** \*: This event is similar to the previous one, only now instead of a single horseman, the pursuers consist of teams of two men.

3. **Monster Roping**: Essentially the same as the previous two, except a young dinosaur or other alien creature is used.

**D. Animal Wrestling Contests**: These events are somewhat similar to the roping events, except that now instead of using a rope, the competitors must wrestle some animal down to the ground with their bare hands. As in the roping contests, whomever accomplishes this feat the fastest is the winner.

1. **Steer Wrestling ("Bulldogging")** \*: A steer is the animal to be brought down. A cowboy rides alongside the steer and leaps off his horse, tackling the steer and relying on his momentum and physical strength to bring the animal down. Once the steer is down, the cowboy must tie three of its legs together to secure the animal. The usual time required is from 3 to 8 seconds.

2. **Bison Wrestling**: This event is similar to bulldogging, but is generally limited to beings of exceptional strength and/or size (such as **Tokanii** and **Juicers**). Also, because bison are so much larger (and more aggressive) than steers, tying it down is not required. If the animal stays on the ground for two seconds, it is considered as brought down.

3. **Monster Wrestling**: Same as **Bison wrestling**, except a two or four-legged dinosaur or other alien creature is used.

**E. Races**: As in most races, the winner is whoever reaches the finish line first. However, racing in rodeos entails more than simply seeing who is fastest. These contests test both the abilities and skills of the rider and his or her animal. Contests can include:

1. **Horse Racing** \*: A race for speed. It can be conducted along a length of road, cross-country (with check points) or along a racetrack (more than one lap may be required).

2. **Barrel Racing** \*: The competitors must traverse a course set with a row of barrels. Each rider must weave in and out between all of the barrels without knocking any of them over to finally reach the finish line. In **pre-Rift** times, this event was popular with female competitors.

3. **Wild Horse Racing** \*: In this event, a number of horses are released into the arena and teams of three men each will have to rope and saddle these steeds prior to riding the designated course.

4. **Steeplechase** \*: This is another popular **pre-Rifts** contest that was separate from rodeos. This race involves riding on a course set with a number of obstacles, usually things to jump over, duck under, or plow through. The major part of this event was not just to ride swiftly but for the rider to stay on his steed while executing a variety of maneuvers and riding abilities.

**F. Miscellaneous Riding Events**: Although these contests might show up in certain rodeos, they are not considered standard events. 1. **Jumping Contests**: Show jumping was another **pre-Rifts** Equestrian event that was not generally part of a Rodeo. On **Rifts Earth** rodeos, alien and monstrous jumping

animals are sometimes included — **Simvan** competitions riding **Ostrosaurus** are always a crowd pleaser.

2. **Equestrian Events:** Also known as "Dressage," these events were also separate from rodeos in the pre-Rifts era. These events consisted of putting the horse through different paces and maneuvers. Many cowboys considered this to be just a showy display and would not be caught dead in such a "sissified" contest.

3. **Trick Riding:** Consisting of such things as standing on moving horses, leaping from steed to steed, and other stunts. Although trick riding goes way back into history, it has always been considered to be more appropriate in the circus than in a rodeo. When it does appear in a rodeo, it is either as a sideshow or as straight entertainment, not as a competitive event; although, of late, a small movement of some **Crazies** and **Simvan** have been trying to get it instated as a regular event (unsuccessfully, thus far).

**G. Animal Fighting:** This is different than wrestling events in that the animal fighter must usually first taunt and avoid the animal, and then slay it either with his bare hands or a simple weapon (sword, axe, club, etc.). About half of all rodeos include such events, although the **Buckaroo Rodeo** does not. Many people argue this popular event is not humane. All such events are not traditional rodeo events.

1. **Bull Fighting:** The traditional event in which a bullfighter taunts and slays an angry bull with swords.

2. **Monster Fighting:** This is another event where **Juicers**, **Borgs**, **Simvan** and **Psi-Stalkers** are allowed to compete. The monsters are often large and/or aggressive predators, including **Ostrosaurus** and other dinosaurs, **Oborus-Slitherers**, **Devil Unicorns**, **Panthera Teroeons**, and **Grigleapers**.

**H. Shooting Events:** Although marksmanship contests and trick shooting exhibitions were part of the early Wild West shows, they ceased to be an integral part of rodeos in the modern Rifts era. Like trick riding, they may appear as sideshows or as entertainment. Otherwise, such competitions are usually separate from rodeo main events.

---

## Resolving the Events

Typically, most rodeo events are open to any qualifying contestant (must have the appropriate skills and better than average ability). Each contestant typically pays an *entry fee* of 25-100 credits depending on the event and the rodeo management. Winners typically get a ribbon, a bottle of bourbon (sometimes food, like a fresh apple pie, turkey or ham), and a cash award of 100-1000 credits, the amount varying with the difficulty and popularity of the contest.

Since it is likely that some of the player characters may want to participate in the events, here are some guidelines:

---

**Riding contests** — These contests are primarily decided by the horsemanship skill (either general or exotic animals, whichever is appropriate). The player must roll under his skill every second, while battling a skill penalty. A successful roll means that the rider keeps his seat, a failed roll dislodges the rider and sends him flying off his animal. Riders will have to call on more than minimal horsemanship skills when the mount is

panicked, spooked or trying to remove the rider. For these rodeo events, the riders are attempting to ride steeds that are specifically selected for their spirit and ability to throw off their would-be riders. Similarly, penalties of -10 to -25% should apply to jumping over a high fence, trench, or a ravine.

To reflect this, each animal has a riding **Difficulty Factor** (DF). The DF penalty is determined at the initial melee round (see listing below) and subtracted from the rider's horsemanship score. Each subsequent *second* that the rider tries to hang on to a bucking bronco, bull, etc., becomes more difficult — this is a **Time Penalty** (TP) that is cumulative for every second that the rider remains on his mount after the first.

	<u>DF Penalty</u>	<u>Time Penalty</u>
Bucking Horses	-10+3D4%	-2% per second
Bucking Bulls	-10+4D4%	-3% per second
Wild Ostrosaurus	-16+4D4%	-5% per second
Jumping Hurdles	-10+3D4%	N/A
Trick Riding	-10+4D4%	N/A
Sharp or		
Precision Turns	-6+1D4%	N/A
Riding Bareback	-6+2D4%	N/A
Riding & Roping	-6+3D4%	N/A
Riding & Shooting	-10+4D4%	failed roll means a missed shot; not even close. A successful roll means a comparatively good shot, roll to strike (other penalties may apply, typically -8 to strike and strike bonuses do not apply).

**Example:** Bronco Bobby has a horsemanship score of 75%; however, he's riding "Lightning," a wicked bucking bronco. The first roll to determine the Difficulty Factor (DF) is a good one, 5+10% for a skill penalty of only -15% (it could have been as high as -22%). This lowers Bobby's score to 60% for the first second. Every second on the bronc thereafter, Bobby's score will drop another 2%. So for second two, his skill is 58%, the third second 56%, the fourth 54%, and so on; each time requiring a lower and lower chance for success.

Note: Because this event depends greatly upon *skill* and sheer brute strength, P.S., P.P. or Speed have little effect on the rider's ability to stay on the animal, although they may be of importance in trying to avoid injury after being thrown. Since this event only lasts for a matter of seconds (seldom past 12), P.E. is not a factor either. A P.S. of 22 reduces the penalty by 2%, plus 2% for each additional four P.S. points beyond 22. So if Bronco Bobby has a P.S. of 29, the -15% would be adjusted by 4 points to 11%.

**Races** — More so than in any other events, the speed and initiative of the animal are critical in these contests.

Roll for initiative at the start of the race, again in the middle (a surge of energy and speed?) and near the finish line. In each case, the winner surges ahead; the higher the roll the better. The **first roll:** For each initiative point less than the leader, the animal is one horse-length behind. So if the leader rolled a high number of 19 and the player character rolled a 14, his horse is five lengths behind the leader. Ties mean horses running neck and neck.

The **second roll:** Halfway through the race, initiative is rolled again. The leader may keep the lead or fade and lose his place. In this case, each animal falls back or surges ahead one horse-length for each point differential of the first roll. For example,

this time the leader's roll is 13 so it drops back six lengths, while the player character rolls a 17, so he moves up three lengths.

**Third roll:** As the horses near the finish line, roll for initiative again and follow the same adjustments as described under the second roll.

**The Rider:** As for the contestants, their horsemanship skill is of the greatest importance. The players must roll under their characters' horsemanship skill each time initiative is rolled, as well as for each special stunt (if any). Stunts, such as jumps, curving around barrels, etc., (although their mounts are cooperative, the racecourse is tricky) are performed with penalty modifiers (see table above). An unsuccessful roll means that the rider loses momentum and falls behind by 1D4 horse-lengths.

In Wild Horse racing, the rider suffers an additional -6+1D6% skill penalty because his horse is belligerent and uncooperative.

**Speed Bonus:** For each point above the animal's base speed factor, it gets a bonus of +1 on initiative and a *half length* applied to its position; other initiative bonuses do not count. The base speed factor for race horses is 57 (+1D6 for bonuses) and 48 for riding horses (+1D6 for bonuses).

Note: A "horse-length" or "length" is the equivalent of the average length of a horse from nose to its hindquarters; a half length is half that.

**Roping contests** — These events will involve the skill of horsemanship and ability with a lasso. Some calves may be

harder to catch than others, so a -2D4% skill penalty applies.

**Animal Wrestling Contests** — These events will involve the skills of horsemanship and wrestling. Competitors will roll their normal riding score (at no penalties, since their steeds are cooperating fully with them) and then make a leap attack to tackle their target. First roll initiative. If the rider wins, he will automatically strike/tackle his animal prey. If the animal has the higher roll, the player must roll to strike and the animal gets to attempt a dodge. If he misses tackling the animal, he suffers 1D6 S.D.C. damage and can get up to try to continue his wrestling attack, but any chance of a speedy wrestle is lost, so he can quit without (too much) disgrace.

To wrestle the animal down and pin it for two seconds (if a monster) or tie three of its feet, requires another successful roll under the character's roping skill. Each failure means a three second lapse before the player can roll again to wrestle and rope or pin it.

The higher the character's P.P., the faster the wrestling and pinning or roping is done. So the character who has a flawless success and the highest P.P., wins.

**Shooting Contests** — Typically whoever hits the most number of targets on aimed shots is the winner. Roll to strike each target as usual.

## Medicine Shows & Other Travelling Shows

In addition to rodeos, there are a variety of other traveling shows, freak shows, and carnivals. Many offer honest (well mostly) forms of entertainment, while others are travelling con artists and villains whose games of chance are rigged in their favor and who peddle (sometimes pick pockets and rob) moonshine, elixirs, potions, herbs and artifacts that supposedly have healing or protective powers.

A medicine show can be one or two people selling things out of a covered or hard-sided wagon, or a group of people and wagons (nomads like gypsies), but rarely number more than 24 people total. Large groups may offer fortune-telling, exhibitions of amazing abilities or strange artifacts, song and dance, and other forms of entertainment for reasonable fees.

### Dr. Geller's Carnival of Wonders

**Note:** See *Rifts World Book One: Vampire Kingdoms* for complete rules for creating travelling shows.

- A. **Sponsorship:** Secret: Small-Time Bandit 0
- B. **Outfits:** #3 Open Wardrobe 10
- C. **Equipment:** #3 Good Gear 5
- D. **Vehicles:** #3 Company Fleet 10
- E. **Communications:** #4 Full Range 15
- F. **Internal Security:** #3 Tight 10
- G. **Defenses:** #4 Militia 20
- H. **Acts:** #s 2,3,6,9,12,(13),17,19,21,22 155
- I. **Alignment:** #3 Anarchist 2



J. Criminal: #'s 1,2,3,6,7,8 53

K. Reputation: #4 Known 10

L. Salary: #4 Good 10

TOTAL POINTS 300

Dr. Geller's Carnival of Wonders is a travelling carnival. Although smaller and less famous than *Mr. Drak's Travelling Circus* (presented in **Rifts: Vampire Kingdoms**, pages 128-139), the Carnival of Wonders is better known in the Pecos Empire, if for no other reason than their frequent appearances there.

The Carnival spends its winters in the city of Crossroads (where they are on retainer with the city to entertain) but goes on the road the rest of the year. Their tour varies from year to year but generally takes them through the Pecos Empire, Los Alamo, Lone Star City, and Fort El Dorado. The carnival has travelled as far north as Whykin and Kingsdale and has crossed the Rio Grande into Mexico. Also, the carnival nearly always attends the Buckaroo Bonanza Rodeo in Uvalde.

The Carnival of Wonders is more noted for its rides, sideshows, and other amusements than for its live acts, although they do have the *Remarkable Roddy*, aerialist extraordinaire, as their headliner (see separate entry). Also, their summer show, which is the one most commonly seen by the average spectator, is generally inferior to their winter show.

Running games of skill and chance are frequently more profitable for the carnival than many of the acts. During the summer, many of the backup and lesser performers are put to work running these booths. However, in the winter, this tends to conflict with the gambling houses at Crossroads. As a result, these people are taken off the gaming booths to perform their acts, although side bets and fortune-telling are still done.

The Carnival of Wonders is making a determined effort to stay on good terms (or, at least, not get caught breaking the law) with the Crossroads authorities and most large communities. When in Crossroads, the games tend to be more fair than when the carnival is on the road. The house odds of winning are from 55% to 65% in Crossroads and 75% on the road.

Most of the carnival people are basically honest (more or less) except for a handful who are secretly working for Remarkable Roddy. However, even they are usually careful not to get too greedy; not that Roddy cares about the people who get fleeced, he just doesn't want to draw attention to his activities and hurt a good thing.

The Carnival of Wonders is run by *Dr. Thadius Geller*, a self-styled doctor (graduate of "the School of Hard Knocks") and impresario. Geller is essentially a good-hearted flimflam man who is not above a bit of petty larceny, but who honestly believes that his carnival is making a difference in the humdrum lives of the people who come to be entertained by his troupe.

A few years ago, the carnival nearly closed down. The star of the show, the Great Miranda (whom Geller was in love with), was killed in a freak accident and Geller sought solace in alcohol. During this period of drunkenness, several of his other top performers left the carnival. While at his lowest ebb, Geller met the Remarkable Roddy. Roddy managed to get Geller sobered up, on the wagon, and even invested some money in the carnival to get it back on its feet. For this act of "charity," Roddy

has been made the headliner of the show (currently its star attraction) and given a certain amount of autonomy in his own affairs. **Note:** Although it's common knowledge around the carnival that Roddy is an investor, no one (except Geller and Roddy) realizes the extent of Roddy's control within the circus.



## Doctor T. Geller

Thadius Geller was born and raised in one of the small feudal kingdoms of Northern Virginia. However, wanderlust caused him to leave his home with a group of adventurers when he turned 18. Geller's comrades soon discovered that although he was not much of a fighter, he had a natural talent for business and promoting.

Blessed with a gift of gab and a free and easy manner, Geller was soon handling the group's resources and increasing their profits through investing and deal-making with the various people (new friends) they met at each new junction.

Eventually, when his group broke up (some of his fellow adventurers decided to retire; one died), the entrepreneur decided to go into business for himself. Geller borrowed money from several of his friends and tried his hand at a number of enterprises. Most of these were profitable enough to ultimately allow him to pay back his investors but not to allow Geller to retire in affluence (besides, he was having too much fun wheeling and dealing).

Although Geller threw himself into every new endeavor with zeal, there was still something missing. One evening, bored and a bit depressed, he decided to catch a performance at a traveling carnival. After that night's performance, **Thadius** Geller was hooked. He had fallen in love with the carnival (and especially with the carnival's star attraction, the Great Miranda).

Geller had enough funds to buy the carnival from the present owners (who were more than glad to get rid of it at a profit) and soon became the ringmaster and impresario. He felt that the title of "Doctor" would be good for business, so he "gave" it to himself and renamed the carnival, *Doctor Geller's Carnival of Wonders*.

Under his leadership, the Carnival soon expanded and prospered. Although it was not in the same league as *Mr. Drak's Circus* (see **Rifts: Vampire Kingdoms**, pages 128-139), the Carnival of Wonders acquired a good reputation and has become one of the more renowned traveling shows in the West. Meanwhile, Geller continues to love the thrills and public limelight the show brings.

Unfortunately for the good Doctor, and the Carnival, Miranda (who by this time had returned Dr. Geller's love) fell to her death during a performance. Geller was inconsolable and soon started drinking heavily. Without his guiding hand at the helm, the Carnival began to fall apart. Performers quit to seek more gainful employment, crowds became smaller, the cheers lessened, and many of his employees feared that the carnival would be forced to shut down.

It was at this point that the Carnival was given a new lease on life, thanks to the appearance of the *Remarkable Roddy*. Roddy not only signed on as the carnival's new star performer, but he sobered up Geller, provided the much needed funds to get the show rolling, and became Geller's silent partner (it is common knowledge among the **carny** folk that Roddy is an investor in their carnival, but only Geller and Roddy know the extent of the investment).

**O.C.C.** Note: The Stats for Doctor Geller can be used as a template to develop other traveling "Traders" and "Snake-oil Salesmen." However, unlike Geller, 60% tend to be anarchist and miscreant alignments; con artists with foul intentions. An M.A. of 14 and P.E. of 12 are O.C.C. requirements. A high I.Q. and P.B. are helpful but not necessary. Also see *Gypsies* in **Rifts® Triax & The NGR**.

**Real Name:** Thadius Geller

**Species:** Human

**Alignment:** Unprincipled (with tendencies toward scrupulous good)

**Hit Points:** 46; **S.D.C.:** 10

**Height:** 5 feet, 11 inches (1.8 m)

**Weight:** 230lbs. (104kg)

**Attributes:** I.Q. 13, M.E. 12, M.A. 15, **P.S.** 10, P.P. 11, P.E. 13, P.B. 11, Spd. 5

**Disposition:** Geller is essentially a good-hearted **flim flam** man who is not above a bit of petty larceny, but who honestly believes that his carnival is making a difference in the humdrum lives of the people who come to be entertained by his troupe.

**Experience Level:** 10th level Trader

**Skills of Note:** Speaks American and Spanish, literate in American and Spanish, pilot: automobile, mathematics: basic and advanced, computer operation, and computer programming, all at 98%, plus play trombone 85%, dance 75%, horsemanship: general 76%, streetwise 66%, lore: demons/monsters 70%, writing 80%, first aid 90%, and W.P. energy pistol.

**Combat Skills:** Hand to hand: basic

**Number of Attacks:** Six

**Bonuses:** +1 to strike, +2 to parry and dodge, +2 to S.D.C. damage, +4 to pull/roll with punch, fall or impact, kick attack (1D6 damage), critical strike on 19-20, judo-style body throw/flip.

**Magic Knowledge:** None

**Psionic Knowledge:** None

**Weapons and Equipment:** If it gets desperate enough for Geller himself to don armor, he has a suit of NGR-G10 Soldier armor in pristine condition. Geller also has a Triax TX-43 Laser rifle (has three damage settings: 2D6 S.D.C., 2D6 M.D. and 4D6 M.D.; 2000 ft/610m range) for situations where charm and reason will no longer prevail.

However, the carnival guards (especially security chief Byaltur) will usually try to form an escort around Geller and only let him near danger zones when all other courses of action fail.

**Description:** A portly man in his mid to late 40's with a red (florid, not skin color) face, and the hair and a handlebar mustache to match.

**Money:** The bulk of Geller's money is tied up in the Carnival. He does keep an emergency fund of around 40,000 to 60,000 credits (the amount will vary with the day-to-day crises that the carnival encounters) that he is continually dipping into as a petty cash fund.

**Note:** Geller is a recovering alcoholic. Those close to him keep an eye out to make sure he doesn't fall off the wagon.

## The Remarkable Roddy

The Remarkable Roddy was not originally born on Rifts Earth, but instead on a 20th Century Earth (dimension?) with a number of superheroes and **supervillains**. Roderick Warrington III was born to extremely wealthy parents and was raised as an incredibly spoiled and rotten child. He might have gone through life as just another spoiled, mean-spirited wastrel had it not been for two things that occurred when Roddy was 22. First, when he was driving while impaired (drunk as a skunk), Roddy sped through a red light and broadsided another car. The driver of this car (a mother of three) was killed. Roddy had a scratch on his chin.

Roderick the III was not too concerned about the legal repercussions, as he felt that his father's money and influence could buy him out of trouble. Unfortunately for him, before that could happen, a second event occurred. Roderick Warrington II was arrested for illegal activities and all of his assets were frozen while under investigation. Without his father, or his money to buy or bribe his way out of trouble, Roddy Warrington III was sent to prison for manslaughter.

After a couple of years in prison, Roddy was desperate for any means of reducing his sentence, so when the prison officials announced that they needed volunteers for a scientific

experiment and that a reduced sentence or even a pardon might be in the offing, Roddy was the first to volunteer.

Roddy was taken to a high-tech laboratory where he was exposed to a variety of experiments/treatments (Roddy didn't really know or care what they were). One day, as the scientists were working on him, a supervillain and his henchmen burst into the lab to steal some equipment. Before they could pull off their robbery, a superhero who had been on the villain's trail interceded and a fight ensued. Much of the scientific equipment was destroyed and bolts of energy coruscated about. Roddy, who had been attached to a machine under restraints, suddenly felt a surge of power flow through him, and somehow managed to free himself and use the confusion to escape.

Shortly after Roddy escaped the lab and police custody, a new supervillain named *Lightning Rod* appeared on the street scene. Roddy had gained superpowers! The abilities to fly, project electricity, manipulate energy, and blend into his surroundings. AS Lightning Rod, he went on a crime spree the likes of which the city had never seen before. He concentrated on jewelry store heists and collected a number of impressive looking gems. Eventually, the law (and some superheroes) started closing in on him (but he decided it was time to arm himself). From his new found connections with the underworld, Roddy learned about a criminal scientist developing some unique weapons he might find useful.

Roddy (as Lightning Rod) went to see this scientist, taking his bag of gems with him. As the two men were bargaining over prices, a superhero raided the place and attempted to apprehend the pair. Lightning Rod flew at the hero with his electrical charge at full power. However, the hero dodged and Roddy crashed into the scientist's prototype dimensional teleporter.

The energy generated by Lightning Rod overloaded the teleporter, totally destroying it. However, an instant before the machine exploded, it worked. When Roderick Warrington III regained consciousness, he was on Rifts Earth!

Once he pieced together what had happened, Roddy managed to handle the situation surprisingly well. At first, he thought that with his powers, he could become a conquering force in this world that didn't seem to have "super" heroes. However, two of his early encounters (one with a Glitter Boy, the other with an Ice Dragon) soon showed him that there were far greater forces at work on this world. Realizing that this planet could be far more dangerous than the one he had just left, Roddy decided to keep a lower profile and study his surroundings. After almost a year of wandering, Roddy came upon Dr. Geller's traveling carnival, fallen on hard times. Dr. Geller invited the young traveller to join him for dinner and, as the two men talked about their current situations, Roddy saw an opportunity in the making.

After demonstrating some of his powers, Roddy not only convinced Dr. Geller to hire him on as a daring acrobat, but also to accept him as a silent partner. Roddy invested half of his gems (most of which went to paying bills and restoring the show). Roddy has since become *The Remarkable Roddy*, the carnival's headline attraction. He makes sure that the carnival keeps a somewhat clean reputation and that he gets his cut off of any extra revenue. The last few people who held out on Roddy were found dead under mysterious circumstances — they were electrocuted!! Unfortunately, Roddy uses the carnival as a front for his continuing career as a criminal. He encourages a group of

carnival hawkers and performers (thieves) to pickpocket patrons of the show, and he sometimes engages in smuggling (usually goods, not people) and occasionally, assassination, both for the Black Market. On his own, Roddy sometimes engages in the burglary of gems and jewelry (he still has a passion for precious stones) and sometimes uses his powers of silent, wingless flight and chameleon abilities to spy on wealthy and influential townspeople and then blackmails them (never revealing his identity or connection with the travelling show). Doctor Geller and most of the other carnival people are blissfully unaware of Roddy's extracurricular activities.

**Real Name:** Roderick Warrington III

**Species:** Human D-Bee from an Earth-like planet without Rifts.

**Alignment:** Miscreant

**Hit Points:** 40; **S.D.C.:** 70

**Height:** 5 feet, 6 inches (1.6 m)

**Weight:** 145 lbs. (66 kg)

**Attributes:** I.Q. 10, M.E. 10, **M.A. 9, P.S. 8, P.P. 9, P.E. 11, P.B. 9, Spd. 11**

**Disposition:** Roddy has gone from being a spoiled rich kid to a cocky supervillain to a conniving crook. Back when he was Lightning Rod, he kept his alter ego of Roddy Warrington III a secret; now, as the Remarkable Roddy, he keeps his Lightning Rod powers a secret (an irony not lost on Roddy). Roddy still wants to enjoy life in the style that he was raised, and is willing to lie, cheat, and steal to do so. He simply realizes that this world has too many beings who can stand up to him and is willing to work behind the scenes to achieve his goals.

**Experience Level:** 8th level D-Bee Supervillain

**Super Power Category:** Experiment: Radiation

**Major Super Ability:** Chameleon

**Minor Super Abilities:** Energy Expulsion: Electricity, Manipulate Kinetic Energy, and Wingless Flight (which he sometimes uses in his acrobatics act to keep balance, avoid falling, to adjust his trajectory, etc.).

**Unusual Physical Characteristic:** All hair on his head and face has fallen out.

**Skills of Note:** Speaks American at 98%, literate in American 98%, pilot: (automobile 98%, race car 90%, motorcycle 88%, motorboat 88%), mathematics: (basic 98%, advanced 92%), computer operation 98%, computer programming 98%, photography 85%, first aid 85%, dance 82%, sing 75%, write 62% and acrobatics (3rd level).

**Combat Skills:** Hand to Hand: Martial Arts

**Number of Attacks:** Six, plus one extra attack if flying.

**Bonuses:** +2 on initiative, +2 to strike, +3 to parry and dodge, +2 to S.D.C. damage, +3 to pull/roll with punch, fall or impact, leap attack, entangle, kick attack (1D8 damage), critical strike on 18-20, jump kick, judo-style body throw/flip.

**Bonuses from Super Abilities:** Flying speed 340 mph (546 km), and when in flight: +2 to strike, +2 to parry, +4 to dodge at 80 mph or slower, +6 to dodge at 90 mph or faster, +4 to S.D.C. damage for every 20 mph.

Electrical energy bolts: up to 10D6 S.D.C. damage, +1 for wild shooting, +3 for aimed shot.

Kinetic energy attacks only inflict half damage, can mentally parry a single kinetic attack at +4, can redirect thrown objects.

Chameleon: 95% to prowl, can blend into environment (at up to 90%), hold breath for 10 minutes, feign death, and adhere to some sheer surfaces.

**Magic Knowledge:** None

**Psionic Knowledge:** None

**Weapons and Equipment:** Roddy wore a red bodysuit with white trim and a white lightning motif as the supervillain Lightning Rod. He continues to wear the same outfit as the Remarkable Roddy, the incomparable acrobat — he uses his flight powers to make amazing leaps, aerial somersaults and stunts, and effortlessly walks the tightrope.

Despite everything that he has seen since arriving on Rifts Earth, Roddy prefers not to wear body armor or use M.D. weapons, preferring to rely on his own powers if fighting is called for. However, he does have a suit of Maverick body armor and a particle beam rifle in case of emergencies. He also uses the carnival guards (his henchmen) as his first line of defense. Roddy fights only as a last resort, unless he can strike by surprise.

**Description:** A small, dark haired, clean-shaven man in his mid to late 30's. Characters with the disguise skill and who roll under their skill at -15% will notice that the hair is actually a toupee (the accident that gave Roddy his powers removed the hair from his head for good. He cannot regrow it).

**Money:** Roddy usually carries around (or has quick access to) 2D4x10,000 universal credits in cash and 4D4x1000 worth of credits in other items. He also keeps 100,000 worth of gems nearby in the event of a quick getaway. If he needs to tap into the funds he has salted away, he can get another 450,000.

**Henchmen:** Roddy has a number of carnival people who are loyal to him (or, at least, who obey his orders). The most notable include a gang of five pickpockets (all 6-7th level thieves), **Byaltur**, the Security Chief (miscreant; 7th level retired Bounty Hunter, I.Q. 12, P.S. 23, P.P. 19); "**Weasel**" **Wallace**, Byaltur's second in command (8th level professional thief and master pickpocket; P.P. 21; miscreant alignment); **Trader Bob**, in charge of concession stands (a 7th level Smuggler; I.Q. 15, P.P. 14; aberrant alignment), and **Kate "The Knife" Kelly**, performer, knife thrower, and Roddy's current girl friend (6th level Gunslinger whose specialty is the quick draw, sharpshooting and targeting with a pair of knives rather than guns; I.Q. 12, P.S. 20, P.P. 22, P.B. 14; anarchist alignment).

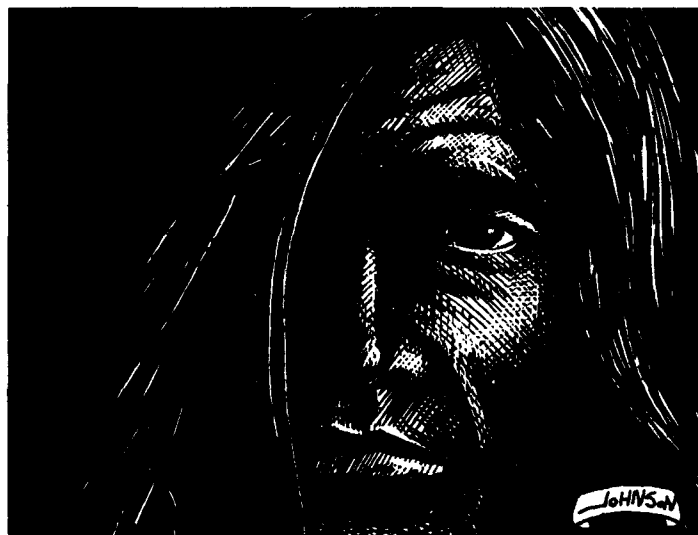

---

# New Skills

---

The following skills are generally specialized areas of training and ability associated with cowboys, gunslingers and outlaws of the New West. Most can be made generally available to most any character class where such skills are appropriate. However, some just aren't going to be common in other societies and parts of the world; for example, a CS grunt has no interest in or need for roping or herding cattle.

## Cowboy Skills

Branding

Breaking/Taming Wild Horses

Herding Cattle

Horsemanship: Cowboy

Horsemanship: Exotic

Lore: Cattle/Animals

Lore: Indians

Roping

Trick Riding

Whittling & Sculpting (see Technical skills)

## Espionage

Imitate Voices & Impersonation

Interrogation Techniques

## Horsemanship Skills

Horsemanship: General/Standard

Horsemanship: Cowboy

Horsemanship: Cyber-Knight

Horsemanship: Exotic Animals

## Medical

Animal Husbandry

Brewing

## Military

Armorer (Field Armorer)

Basic Mechanics

Camouflage

Find Contraband, Weapons & Cybernetics

Military Etiquette

Military Fortification

Nuclear, Biological, & Chemical Warfare

Parachuting

Recognize Weapon Quality

Trap Construction

Trap/Mine Detection

Underwater Demolitions

## Piloting

Hovercycle

Also see Horsemanship.

## Rogue

Cardsharp

Find Contraband, Weapons & Cybernetics

Safecracking    Seduction    Ventriloquism

## Technical

Breed Dogs  
General Repair/Maintenance  
History of the West  
Law  
Lore: Cattle/Animals  
Lore: Indians  
Lore: Religion  
Prospecting  
Whittling & Sculpting

## Weapon Proficiencies

W.P. Bola W.P. Sharpshooting Specialty  
W.P. Whip

## Wilderness (described under military)

Trap Construction  
Trap/Mine Detection

# Skill Descriptions

## Cowboy Skills

**Branding:** The techniques and methods for tethering, controlling and marking, or "branding," animals. A brand is a mark burned on the skin to identify and show ownership of an animal —typically used on horses and cattle, sometimes on humans and D-bee slaves. This skill also includes a basic knowledge of common and notable insignias and emblems. **Base Skill:** 50% +5% per level of experience.

**Breaking/Taming a Wild Horse:** To "break" a horse, first the trainer must get the horse used to being around people, then used to having a saddle on its back (this takes 3D4 days), and then you "bit" train it (get's used to having a bit in its mouth and reins). Finally, the trainer must get the horse used to having a rider on its back. Depending on the horse, this can take a couple weeks (making an attempt every day) or several weeks with moderate success. It takes a lot of skill to stay on a wild horse when he wants you off. Some horses are never completely tame, and some will allow certain people to ride it, while bucking and throwing other riders. During this initial training period the rider must hang on for dear life while the horse does everything in its power to throw him. This battle of wills can last hours and take up to 12 weeks. **Base Skill:** 20% +5% per level of experience.

Also includes riding wild bulls (cannot be broken), wild broncos, and other wild animals, as well as *steer wrestling*, but all at -15%.

**Herding Cattle:** The techniques and methods of leading, directing and controlling cattle in a contained and orderly herd. Also includes keeping animals calm, basic care and feeding, how to tend cattle, recognize disease and illness, give birth to young, how to survive and regain control of a stampede, gather strays, how best to pen and corral livestock, mend fences, etc. **Base Skill:** 30% +5% per level of experience.

**Horsemanship: Cowboy:** See description under horsemanship.

**Horsemanship: Exotic:** See description under horsemanship.

**Lore: Cattle/Animals:** See description under technical.

**Lore: Indians:** See description under technical skills.

**Roping:** The rope is the cowboy's most important and famous tool. Characters with the roping skill can expertly throw a rope to **snare/lasso** a cow's horns, a horse's neck, or the hoofs of either, to enable a 140 pound (63 kg) man to capture and subdue a half ton animal! Hitched around the saddle horn, a lariat can be used to pull a mired animal out of a bog, mud or river, as well as keep a hobbled horse or other animal from straying away in the night or rain, and the rope can even be used to create an instant, make-shift corral, when stretched taut by several men, to contain and hold a herd of animals — and even for quick justice at the end of a hangman's noose.

The roping skill includes knowledge and training in how to use a lariat, lasso, tie knots, expertly handle roped animals after they are snared, bring them to a stop by taking quick turns of the lariat around the saddle horn (known as "dally" or "da la vuelta"), tethering animals, and how to "hog-tie" animals (after the animal has been lassoed, the horse backs up to make the rope taut while the cowboy "tips" over the animal and ties three legs with a half shank; used in separating stubborn animals from the herd, capturing wild animals, and branding). The **rope/lariat** can be used for the roping and tying of animals, including cattle, horses, similar alien animals, and even small dinosaurs and people. This skill with a lariat can be executed standing on the ground, but is designed and intended to be done from horseback (or hovercycle).

A failed roll to tie a knot means that it is loose, sloppy and easy to untie, slip out of, or likely to unravel or snap when strained. A failed roll to lasso an animal or stationary target, means it misses its mark or slips off.

Against human and intelligent opponents, roll to lasso as if it were a combat attack to strike and ensnare. The intended victim can try to dodge; parry is not applicable. A successful strike means the character is caught in the lasso. Ensnaring a foot, leg or hand means the victim can be tripped, knocked down and pulled/dragged by hand or horse. Ensnaring the upper body means one arm is pinned (useless). Two or more lassoes around the upper body means both arms are pinned and attacks requiring the use of one's hands are impossible, and the lassoed individual can be pulled off his feet and dragged. Multiple lassoes can also be used to snare each limb and "spread-eagle" the character. It takes 1D4 melee actions to cut through a lasso, but it is impossible to draw a weapon and cut oneself loose if both arms are pinned or while being dragged. In this combat usage, the roping character is +1 to strike for every 20 points of skill, so a skill of 65% means +3 to strike/ensnare. **Base Skill:** 20% +5% per level of experience.

**Trick Riding:** Riding bareback, standing on the animal's back, hanging from the side, or under its belly (usually for rodeo tricks or to hide from enemies), side saddle, as well as quick mounts and dismounts, mounting a horse by leaping down from above or with a running start, leaping from the back of a horse onto another horse or wagon, and similar. **Skill Requirement:** Must know one of the horsemanship skills, or trick riding cannot be selected. **Base Skill (Special):** The trick riding character can attempt all tricks and stunts without penalty; roll on the **first/greater** of the horsemanship skill percentages for success.

**Note:** Characters without this skill can *try* any of these tricks, but must roll on the second percentage number of their horsemanship skill after reducing it by half. Roll for each



attempt. Likewise, these stunts can be tried while riding mounts other than a horse, but reduce the skill by half, unless the character also has the skill *Horsemanship: Exotic Animals*.

## Espionage

*Reprinted* for your convenience from **Rifts® Coalition War Campaign™**.

**Imitate Voices & Impersonation:** The ability to imitate the voice, accent and expressions of another person or area. This skill is common among CS spies and espionage agents as well as ninja and the occasional assassin or mercenary. The first number indicates the character's ability to change his voice and imitate accents, inflections and expressions from other regions. A successful roll means he has disguised his normal/true speaking voice and accent, and convincingly sounds like he is from another region or part of the world. The second number indicates the character's ability to accurately imitate the voice, inflections and attitude of a *specific* person! This is much more difficult, and the character will either need to know the person being imitated very well or have spent hours studying **him/her**. **Base Skill:** 36%/16% +4% per level of experience.

**Note:** When combined with the disguise and intelligence skills, the character is able to completely impersonate another person or type of occupation (soldier, **ISS** Inspector, operator, priest, etc.). This is likely to include a knowledge of the enemy/subject of impersonation, military procedure, dress, command, rank, and will usually require speaking the language fluently. This means the character can convincingly impersonate a general type of **person/soldier/occupation** by using an accurate disguise, proper action, and language. **Base Skill:** 16% +4% per level of experience to impersonate a *specific* individual; +12% to impersonate *general*/personnel and occupations.

**Interrogation Techniques:** This skill is common among policemen, intelligence officers, and **assassins/spies/bounty** hunters. The character knows the techniques to get information from (typically unwilling) subjects. This includes such old methods as "good cop, bad cop" (one interrogator is threatening and intimidating, the other is sympathetic and friendly), deceiving and misleading the subject into giving away information, and similar. The character can also judge if the subject is lying (the Game Master might assess bonuses and penalties depending on how good a liar the subject is, **and/or** on the victim's M.E., M.A. **and/or** P.B; the higher any or each of these attributes, the more convincing the lies). This skill also includes some basic knowledge on methods of torture, from basic tactics like depriving the subject of sleep, to the use of "medieval" instruments, drugs and psionics. **Note:** Only evil characters will engage in actual torture. **Base Skill:** 20% +5% per level of experience.

## Horsemanship Skills

There are four types of horseback riding skills. General/standard (the typical skill known by most civilized people and CS citizens), Cowboy, **Cyber-Knight**, and Exotic Animals (the ability to ride alien and monstrous animals from other worlds). Unless stated otherwise, a character can only select Horsemanship: General; Cowboy and Cyber-Knight are generally restricted to special O.C.C.s and R.C.C.s.

Trick Riding and Roping skills can augment and compliment one's riding abilities, but are not riding skills in and of themselves. Each "Horsemanship" skill indicates a certain degree of training and expertise in riding and handling horses. Each type of horsemanship has the following skills and areas of knowledge. The higher the skill percentage the better the skill or ability. **Note:** To avoid being thrown from the horse when jumping, charging, kicking or performing some other difficult maneuver, the character must roll under his horsemanship skill percentage to remain in the saddle and in control of his animal. Tricks and stunts (without the Trick Riding skill) are performed at half the rider's normal riding skill.

**Ride & care of horses:** The first percentile number indicates the character's riding ability and a fundamental knowledge of feeding, caring, and grooming of horses.

**Recognize quality/breed:** The first percentile number also indicates the success ratio of recognizing the breed quality, age, strength, speed, health, and general attributes/capabilities (race horse, workhorse, **warhorse**, etc.) of the animal.

**Breed horses:** The second percentile number indicates the knowledge in the raising, breaking, training and breeding of horses. It includes shoeing horses, giving birth, and curing minor ailments and injuries.

**Jumping:** The second percentile number also indicates the success ratio of NOT being thrown from the horse when jumping, charging, kicking or performing some other difficult maneuver or trick. The character must roll under his percentage to remain in the saddle and in control of his animal. Damage from being thrown off a horse is typically 1D6.

**Racing:** The second percentile number also indicates the success ratio of maintaining control and getting maximum speed while racing at full gallop. A failed roll means the horse runs quickly but 10% short of its maximum speed, but the rider can coax that little extra spirit and speed out of the animal. Once every four minutes, the rider can get the horse to kick into overdrive and run at 25% faster than its normal maximum. However, this speed can only be maintained for one minute at a time and cannot be done more than three times in a 15 minute period. Maximum running speed can be maintained for a period of minutes equal to the horse's P.E. attribute. Pushing the horse beyond its endurance will cause it to slow down by 30% and after 4D4 minutes, collapse from exhaustion (requires at least a half hour rest and light activity for another hour).

**Combat:** All bonuses are in addition to other combat skills, weapon proficiencies, or attribute bonuses. Applies to the rider, not the horse. The rider gains a combat advantage from the height and speed of being mounted.

**A general note about horses:** The horse attack skill reference indicates that the rider is skilled enough to remain saddled while he attacks and has his horse rearing or kicking in simultaneous attack (roll under second percentile number).

**Attribute Notes:** Horses have a fairly high animal intelligence, roughly equal to that of a dog, and can generally carry or pull 500 pounds (225 kg). A war or work horse can carry about 600 pounds (270 kg) but pull up to five tons, and a pair of work horses can pull up to 15 tons (but speed of working is a mere 15 mph (24 km)).

**Speed:** Work Horses, Mules & Donkeys: Spd 22 or 15 mph (24 km)



Ponies: Spd 36+3D4 or approx. 25-30 mph (40-48 km)

Riding Horse: Spd 48+1D6 or approx. 35 mph (56 km)

War Horse: Spd 48+1D4 or approx. 35 mph (56 km)

Race Horse: Spd 57+1D6 or approximately 40 mph (64 km) with a short burst (1D4 minutes long) of up to 50 mph (80 km), but cannot handle the hardships of the wilderness (reduce H.P. & S.D.C. by 20% for every month forced to function in the wilderness or as a work horse).

Average P.P.E.: 5D6; sensitive to the supernatural, ley lines and strong magic.

Average Life Span: 7-9 years as a work or strong riding animal, after which the horse is worn out (reduce H.P., S.D.C. and Speed by one third), but can continue to be used for light work, light to medium riding **and/or** put out to stud for several years to follow; total average life span is 12-15 years.

Hit Points & S.D.C.: The typical riding and race horse has 4D6+6 hit points and 5D6+12 S.D.C.

War Horse: 5D6+10 H.P. and 6D6+16 S.D.C.

Work Horses and Mules: 4D6+10 H.P. and 4D6+20 S.D.C.

Pony and Donkey: 4D6 H.P. and 2D6+12 S.D.C.

M.D.C. Horse **Barding**: Light offers 40-50 M.D.C. without penalty, heavy: 110 M.D.C. but reduce the animal's speed by 5%.

Damage from Horse Attacks: The exact damage from a horse's kick will vary with the size and breed of the animal; generally 2D6 S.D.C. from the front legs and 4D6 from the rear legs; +6 damage from war horses.

Attacks per melee round: 2 or 3.

Cost: Donkey: 600-1000 credits

Mule: 800-2000 cr.

Work Horse: 1000-2200cr.

Ponies: 800-2000 cr.

Riding Horse: 2000-4000 cr.

War Horse: 3000-6000 cr. untrained; 15,000-30,000 for a trained animal.

Race Horse (for sport & gambling): 20,000-300,000 cr.

---

## Specific Horsemanship Skills

---

**Horsemanship (general):** All the basic skills as noted above.  
**Base Skill:** 40%/20% +4% per level of experience.

**Combat:** All bonuses are in addition to other combat skills, weapon proficiencies, or attribute bonuses. Applies to the rider, not the horse. The rider gains a combat advantage from the height and speed of being mounted.

+1 to parry or dodge while on horseback.

Inflicts +1D4 S.D.C. damage when on horseback.

Charge attack (running horse) with a pole-arm or spear: +1D6 damage. The attacker must roll under the second percentile number to avoid being dismounted. Charge attacks count as two melee actions/attacks.

Horse attack; see details under stats for horses.

**Horsemanship: Cowboy: Base Skill:** 66%/50% +3% per level of experience. Not available to most O.C.C.s.

**Combat:** All bonuses are in addition to other combat skills, weapon proficiencies, or attribute bonuses. Applies to the rider, not the horse. The rider gains a combat advantage from the height and speed of being mounted.

+1 on initiative when on horseback at levels 2, 5, 10 & 15.

+1 to roll with fall or impact when knocked from a horse.

+2 to parry or dodge while on horseback.

Inflicts +1D4 S.D.C. or M.D. when on horseback, depending on the weapon (M.D. weapons like **Vibro-Blades** get the M.D. bonus; not applicable to ranged weapons like rifles and blasters).

Charge attack (running horse) with a pole-arm or spear: +2D6 S.D.C. damage. The attacker must roll under the second percentile number to avoid being dismounted. Charge attacks count as two melee actions/attacks.

Horse attack; see details under stats for horses.

**Horsemanship: Cyber-Knight: Base Skill:** 70%/50%+3% per level of experience. Exclusive to the Cyber-Knight (and Paladin) O.C.C.

**Combat:** All bonuses are in addition to other combat skills, weapon proficiencies, or attribute bonuses. Applies to the rider, not horse. The rider gains a combat advantage from the height and speed of being mounted.

+1 on initiative when on horseback at levels 1, 5, 9 & 14.

+2 to roll with fall or impact when knocked from a horse.

+2 to parry or dodge while on horseback.

Inflicts +6 S.D.C. or M.D. when on horseback, depending on the weapon (M.D. weapons like **Vibro-Blades** get the M.D. bonus; not applicable to ranged weapons).

Charge attack (running horse) with a lance, pole-arm or spear: +3D6 damage. The attacker must roll under the second percentile number to avoid being dismounted. Charge attacks count as two melee actions/attacks.

Horse attack; see details under stats for horses.

**Horsemanship: Exotic Animals:** Basically the same as the *general horsemanship* skill, except that the character is experienced in riding "tame" animals other than the horse. This can include elephants, camels, llamas, pegasus, gryphons, dinosaurs, giant insects, and other monstrous beasts trained (or willing) to be riding animals. Wild, untamed creatures cannot be ridden, except by **Simvan** and others with special animal skills or powers. **Base Skill:** 30%/20% +5% per level of experience.

**Note:** Characters with the traditional "horsemanship" skill for riding horses and other very horse-like animals can quickly figure out how to ride exotic animals and alien riding beasts, but at a skill penalty of -12% to ride ground/running animals and -16% to ride flying or tree climbing and leaping animals. Similarly, beings from other dimensions not familiar with riding the fast and sleek Earth horse are -10% to ride them.

## Medical

**Animal Husbandry:** This area of study provides the character with a knowledge of the care, feeding, breeding, reproduction, treatment and behavior of domestic animals, as well as very basic veterinary skills for minor illness, setting a broken leg and giving birth. The animals included under this skill are cattle, sheep, goats, horses, mules, donkeys, ducks, chickens, and similar livestock and domesticated animals like dogs (see horsemanship for breeding horses and breeding animals for dogs). The percentile number indicates the degree of knowledge and skill one has about animals and their care. Reduce the skill ability by half when caring for captive or injured *wild* animals. **Base Skill:** 35% +5% per level of experience.

**Brewing:** The understanding and methods of making fermented alcoholic beverages from grains and fruits. This specifically includes wine, mead, ale, beer and moonshine. Stronger alcohol, such as brandy, rum, and whiskey, are not included, nor are champagnes or fine wines. The first percentile number indicates the chance of success (a failed roll means an **undrinkable** batch of booze). The second indicates the quality of the brew — the higher the number rolled the tastier the drink. **Base Skill:** 25%/30%+5% per level of experience.

## Military Skills

*Reprinted* for your convenience from **Rifts® Coalition War Campaign™**.

**Armorer:** This is a somewhat simplistic version of the weapons engineer as it applies to infantry weapons. A competent armorer character can maintain, fix, modify, mount, reload/charge ammunition, and figure out most small arms. The Armorer can repair all types of pistols and rifles, repair minor damage to body armor (20 M.D. maximum), adjust targeting sights, use and repair optical enhancements, reload missiles and ammo drums, recharge **E-clips**, install/mount a rail gun or machinegun on a vehicle, and even fix most simple robot and bionic weapons like forearm blasters and retractable blades, as well as make arrows and arrowheads, sharpen blades/weapons, make horseshoes and basic metal items (including nails, spikes, and chain links). He can also deactivate, reset and fix simple traps (roll for each attempt). **Base Skill:** 40% +5% per level of experience. **Note:** Automatically gets the basic mechanics skill at +20% as part of this package.

**Basic Mechanics:** A general familiarity and understanding of basic mechanics. This character can fix a toaster, repair a bicycle, replace a belt on a motor, repair or replace a switch, handle or a knob, replace a spark plug, change oil, assist in automobile repairs, maintain machinery, read a schematic and similar fundamental tasks. **Base Skill:** 30% +5% per level of experience.

**Camouflage:** The skill of concealing a fixed base position, vehicle, **bot**, equipment or individual, using natural or artificial materials. A fair amount of time is involved in the preparation of a larger position. Large cargo nets, cut branches or underbrush are used most often in camouflage. This skill is also used to conceal traps. **Base Skill:** 20% +5% per level of experience.

**Military Etiquette:** This skill grants a clear understanding of the way the military works, including rules of behavior (when to salute, how to address superiors/subalterns, etc.), military procedures and routines, standard issue of equipment, special ordering procedures, proper display of rank and medals, advancement in rank (and the duties that come with it), proper troop formations, how to deal with military bureaucracy, the chain of command, proper channels, who to contact to get things done, and other useful information in matters of military protocol and bureaucracy. **Base Skill:** 35% +5% per level of experience. **Note:** All soldiers have a fundamental knowledge of military **complete** with a strong knowledge of what is expected, correct and the formal approach (e.g. by the book knowledge).

**Military & Rogue Skill Categories: Find Contraband, Weapons & Cybernetics:** The character with this skill knows where to find arms dealers, smugglers, body chop-shops, cyber-snatchers, M.O.M. and Juicer conversions, criminal cyber-docs

and illegal medical treatment, as well as how to spot them. He is also familiar with their practices, hang-outs, gang or criminal ties, general practices, code of conduct, pricing structures and modes of operation. Likewise, the character has a good idea of what black market weapons and cybernetics should cost and what these people pay for contraband items (typically only 20% of the retail market price). The character also knows the penalty for being caught with an illegal weapon, implant or bionics. In all CS cities and most societies, any M.D. weapons, concealed weapons and sidearms are forbidden inside large population centers.

This skill is especially appropriate in the modern cities of the Coalition States, as well as in the large cities of the NGR, Atlantis, Japan, and other large, urban communities. **Base Skill:** 26% +4% per level of experience. **Note:** This skill *should* be considered separate and apart from streetwise.

**Fortification:** This is the skill of designing and building defensive fortifications suitable for modern mega-damage combat. If provided with the time and materials the character can greatly increase the defensive value of natural terrain with murderous defenses that include obstacles to impede movement and protective structures to shield friendly forces from enemy fire. The character is trained to prepare mine fields, barbed wire, tank obstacles, tanglefoot wire, booby traps, trenches, tank ditches, foxholes/shell scrapes, reinforced concrete or earthen walls, bunker complexes, rail gun/mortar emplacements, tunnel systems and similar defensive constructions. **Base Skill:** 30% +5% per level of experience.

Even with the advent of mega-damage warfare the old standby fortifications listed above have useful applications. Obstacles like ditches and mine fields slow the advance of `bots, infantry and tanks, exposing them for longer periods to defender firepower. Earthen walls and foxholes, made from S.D.C. materials, still afford soldiers some protection and can disperse energy blasts or deflect shrapnel from explosives. If these protective structures are built with mega-damage concrete and alloys they provide defenders with as much protection as any robot vehicle or tank!

**Nuclear, Biological, & Chemical Warfare (NBC):** This is the knowledge of safety precautions to protect oneself and others from the effects of nuclear, biological or chemical warfare, waste and contamination. The character is also knowledgeable in the safe handling and "clean-up" and containment of such hazardous materials. **Base Skill:** 35% +5% per level of experience.

**Parachuting:** Not generally applicable to the New West, so it has not been reprinted.

**Military and Wilderness Skill Categories: Trap Construction (by Nowak & Siembieda):** Training in the design and application of traps and mines used in anti-personnel and defense tactics. With readily available materials and simple tools, including shovels, knives, sticks, wire and rope, the character can build fiendish traps. Any who would scoff at the effectiveness of traps in modern mega-damage combat should reconsider. It is true that traps cannot be made to destroy or even damage M.D. equipment, unless explosives and the demolitions skill are used, but these traps can hamper or disable enemy robots and vehicles, and injure or kill unarmored or lightly armored soldiers! Traps can also be used as an alarm to alert the

trap maker to the presence of intruders or the enemy (fires a flare, activates a video camera and transmission, makes noise, etc.).

The greatest drawback of traps lies in the amount of time required to prepare them — it can take hours to prepare rock slides, large pits and similar traps — but, even this time can be shortened with help from others since only one character needs the skill to successfully direct workers. Ingeniously prepared traps can, and often do, shift the advantage of a battle to the side that prepared the field for combat. **Base Skill:** 20% +4% per level of experience.

**The following** are some examples of traps, complete with their effect, a character can include using the *trap construction* skill. All damage, penalties and considerations are based on a human-sized victim unless stated otherwise.

**Pit, Man-Sized:** Typically a simple pit/hole 7-14 feet (2.1 to 4.2 m) deep and concealed with twigs and leaves. Pits can slow an enemy advance by delaying troop movement (must pause to climb out of pit or to help comrade out), injure the victim (typically twist, pull or bruise and sometimes break a leg or arm), damage light (S.D.C.) equipment, trap unfortunate soldiers and disable robots (at least temporarily).

A person blundering into a pit trap falls, taking 1D6 S.D.C./hit point damage per every seven feet (2.1 m) of depth, even if wearing M.D. body armor (the impact has an effect on the person inside; no damage to power armor or robot pilots)! The same damage is applied to fragile S.D.C. items that tumble into the pit. The character also loses one melee attack/action in that act of falling and 1D4 melee actions gathering his wits and getting back on his feet; stun effect.

To climb out of the hole unassisted requires 1D6 melee actions. An especially deep pit will require a *climbing* skill roll or somebody to give the character a hand. Robot vehicles that step into the hole have a 01-70% likelihood of tripping and falling. Crew members suffer 1D4 S.D.C. damage and must spend 1D4 melee rounds to right the vehicle. While trapped and/or while the victim(s) are attempting to recover, the trap maker and his allies usually launch a vicious attack or surround the victim. The pit trap is very common in the wilds of North America.

**Monster Pit:** In some instances the trap designer will place a small (or large), vicious creature inside the pit. The creature will be terrified and/or angry and attack anything that falls into the pit. These creatures typically fight until slain. Lasae, worms of Taut and M.D. monsters of similar size are often used in this capacity, as well as wild canines, felines, bears and snakes.

**Snake Pit:** A shallow pit, 4 or 5 feet deep (1.2 to 1.5 m), filled with poisonous snakes or small worms of Taut. Characters who fall or stumble into the pit receive 1D4 bites. Regular snake bites inflict 1D4 S.D.C. damage plus 3D6 S.D.C. from poison if the creatures bite unprotected flesh. Creatures like worms of Taut and other alien "crawly things" may inflict mega-damage. The trap is rarely used in North American and Europe, but is frequently used in the jungles of South America and Asia.

**Tank Trap/Giant Pit:** Basically the same as a man-sized pit but dug to a depth of 18 to 30 feet (5.4 to 9 m). Infantry ground troops who blunder into the hole suffer 1D6 S.D.C. for every seven feet (2.1 m) of depth from falling and need 2D4+2 melee

attacks/actions to climb out, unless helped out by people outside the pit with rope and such.

Robot vehicles and tanks can also fall victim to these deep and often wide pits. The crew suffers 2D4 S.D.C. damage from getting jostled around. Humanoid robots and power armor suits can climb or pull themselves out of the pit with relative ease; must spend one or two full melee rounds (15-30 seconds) unless the vehicle or power armor can fly or leap out (counts as one melee action).

Tanks, trucks and other ground vehicles may have part or all of the vehicle stuck or wedged in the pit and require a crane or giant robot(s) or several power armor troops to pull it out. Just how stuck and immobilized the vehicle is will depend on the size and depth of the pit.

**Mined Pit:** A pit with land mines or other explosive device(s) dug into or placed on the floor of the pit. It detonates when one or more victims hit the bottom.

**Punji Stake Pit:** Typically a pit 8-10 feet (2.4 to 3 m) deep, concealed with twigs and leaves. The bottom of the pit is lined with a bed of sharp wooden stakes. Roll 1D6 to see how many stakes the falling character lands on; each inflicts 1D6 S.D.C. damage plus damage and penalties from the fall (see the *man-sized pit* description). **Vibro-blades** and special M.D.C. materials can be used to inflict mega-damage; roll 1D6 to see how many stakes the falling character lands on; each inflicts 1D6 M.D. plus possible damage and penalties from the fall.

Punji pits are extraordinarily effective against vampires and are found throughout Mexico! They are often used (camouflaged and open) as **countermeasures** along defensive perimeters and dug-in fortifications.

**Punji Sticks:** Sharp wooden stakes stuck into the base of trees, in tree branches, or on the ground at strategic locations near settlements, defensive perimeters, off to the sides of paths and so on. People who stray off the path or go where they don't belong may step on, stumble, trip, fall or lean into 1D4 stakes/spikes. Each stake inflicts 1D6 points of S.D.C. damage. Wood and S.D.C. material punji stakes do no damage to characters in M.D. body armor and are rarely used for that reason.

As noted previously, **vibro-blades** and other mega-damage materials may be used, but are not as effective; vibro-blades tend to hum, tipping off their location, and M.D.C. materials scrape but seldom puncture M.D.C. armor unless the victim falls on or drives across them with some force. Punji sticks are a form of guerilla warfare designed for use against **humanoid** enemies. Travelling slowly and carefully, they are easy to detect and avoid, but being reckless or running, the character is likely to run into them headlong.

**Punji-Stick Drop-Fall Trap:** A large weight bristling with sharp, wood stakes is suspended in a tree. It is released by a trip wire and either drops down or swings across the target area. Characters can try to dodge but are -3 to do so. This trap inflicts 6D6 S.D.C. damage to **unarmored** victims. Those wearing M.D. body armor suffer 2D4 S.D.C. damage from the impact and are knocked off their feet; lose initiative and one melee action!

**Swinging Log:** A huge log or piece of debris (cannon barrels and the legs from a giant robot are also used) is suspended in a tree. When released by a trip wire or pressure plate, it swings

across the target area. All characters in the path of its swing are struck and suffer damage unless they successfully dodge at a -3 penalty. Characters wearing M.D. body armor suffer 6D6 S.D.C. damage from impact, unarmored victims suffer 2D6x10 S.D.C. (or one M.D. point)! Individuals struck by the log are knocked out cold by the tremendous impact for 3D4 melee rounds. The trap is a favorite for attacking groups of soldiers walking in single file, as well as against power armor.

Robot vehicles struck by the huge weight have a 01-50% likelihood of being knocked off their feet; vehicles knocked off their path. The vehicle crew suffers 1D4 S.D.C. damage from being thrown around the cockpit.

**Barbed Wire Barrier:** Cords or rolls of barbed wire are laid across a pathway, entrance or particular area (concealed or not) to bar its path. While the wire will not hurt mega-damage body armor, it still hooks and entangles the feet and snags any fabric, thus impairing movement (the wire must be cut or pulled away) and makes noise. Power armor units and bots can often tear right thorough it or stomp it down with no penalties; also their passage will still make some noise.

**Rock Slide/Log Fall:** Rocks or massive logs or debris piled at the top of an incline are released to tumble into the target area. Every foot soldier, bot or vehicle in the area suffers 1D4 M.D. from the impact of rocks or M.D.C. debris or 1D6x10 S.D.C. from logs. Unless the victims make a successful dodge at -8 and are able to dive for cover, they are struck and carried away by the tumbling rocks, logs or debris. Most will become pinned in or trapped beneath the fallen materials until rescued by companions.

Even those individuals who dodged successfully are trapped at the edge of the pile and need 3D4 melee rounds to work themselves free. Robots and vehicles, who are often targeted by this trap, have no chance to dodge and have a 01-90% likelihood of getting knocked down or pushed 1D6x10 feet off the path. Furthermore, they are struck by more of the falling debris, suffer triple damage and are likely (01-75%) to need a crane, giant robot or several power armor troops to pull them free. The crew of the vehicle suffers 2D6 S.D.C. damage. During this time, the designers of the trap typically swarm the helpless vehicles, bots or soldiers, attacking or taking prisoners. In addition, the debris covered **road/area** is more difficult to travel over. This trap is very popular in hilly and mountainous regions.

**Crossbow Trap:** A crossbow attached to a tree or in a pit that shoots when a trip wire is pressed or broken. The bolt strikes the target on a 1D20 roll of 14 or higher. Damage from an ordinary bow and arrow is 2D6 S.D.C., but any of the high-tech types can be used. Often the crossbow will be loaded with an explosive high-tech bolt that inflicts 3D6 M.D. rather than a conventional projectile. Fairly common.

A variation can use an S.D.C. or energy pistol (because of the short range of the trap and typically only fires a single shot) by having the wire depress the trigger on the gun. However, this is a rarity because of the waste and cost of using a more sophisticated and high-tech weapon.

**Trip Snare:** Causes the character to trip. No damage, but the fall is embarrassing, the character loses initiative, two melee actions, and makes a loud noise that will alert nearby enemies and predators to the character's location. Usually the snare is set

as part of an ambush, leaving the fallen character vulnerable to the opening volley of an attack. This type of trap is extremely common.

Variations include trip flares, in which in addition to the above, a rocket flare is shot into the sky and explodes. The flare indicates the exact location of the intrusion and, at night, illuminates the immediate area of the snare.

**Animal Snare:** A simple snare designed to catch or lasso the animal's foot or head. This is typically used to capture small animals.

**Rope Snare:** This is a concealed, lasso-style snare tied to a tree. When the snare is triggered, the lasso snares the foot or feet and whips the character or animal up and suspends it, dangling from a tree, usually 5-10 feet (1.5 to 3 m) above the ground. No damage but the character loses two melee actions and needs another melee action or two to cut himself down. It is most effective in forested areas.

**Net Trap:** Rather than using a lasso-style snare a net can be used in the above rope snare trap. The net is spread on the ground and camouflaged, but wraps around the target when triggered. The character or animal is whipped up and suspended from the tree 10 feet (3 m) above the ground. There is no damage caused by the trap but the character loses two melee actions and needs a further three melee actions to cut himself loose.

**Bear Trap:** A pair of large, clamping metal jaws that snap shut when the prey steps on the pressure plate. The metal jaws are typically chained to a tree or stake and require a combined P.S. of 24 to pry them open; a hand activated release switch will also open and reset the trap. Damage is 4D6 S.D.C., but holds its prey in place until the jaws are opened or the prey literally tears itself free; animals often bleed to death. This trap is effective against animals and **unarmored** humanoid prey. It is sometimes combined with a snare to trigger flares or drop a grenade.

**Naruni Bullet Mine:** A crippling trap design which employs a Naruni plasma cartridge or small explosive. The cartridge is placed in a small hole in the ground atop a nail or firing pin, then covered by a camouflaged wooden slat. When someone steps on the slat, the cartridge is pressed down on the firing pin, triggering a plasma blast that inflicts 1D4×10 M.D. to the victim's foot. Uncommon, due to the generally poor availability of Naruni ammunition. Hand grenades and other explosives are sometimes substituted.

**Grenade Trap:** A regular grenade, with its pin removed, is attached to a trip wire and placed in a can hanging from a tree. When the trip wire is pulled, the grenade falls from the can and explodes on or near the unfortunate victim. The explosion causes regular damage by grenade type, fragmentation (2D6 M.D.) and plasma grenades (5D6 M.D) are typically used. This is a fairly common trap.

Variations include the use of riot control flash/stun grenades, tear gas and smoke grenades.

**Mini-Missile Trap:** Typically a snare that triggers the launch mechanism of a mini-missile! Fairly uncommon; another guerilla tactic.

Fusion blocks, plastique charges and land mines are all frequently used in booby traps throughout the world. However, the character must have the *demolitions skill* to use them.

### **Military and Wilderness Skill Categories: Trap/Mine**

**Detection:** Knowledge of the strategic placement of booby traps and mines, the tell-tale trademarks and indications of traps and mines, how to avoid them, and the use of mine and explosive detection equipment. The character has been trained to watch for suspicious objects, dirt mounds, trip wires and camouflaging materials that may denote the presence of a trap. Simple snare traps and trip wires can be easily disarmed by the character, but the *demolitions disposal* skill is required to disarm mines, explosives or complex traps. **Base Skill:** 20% +5% per level of experience on visuals alone. Add +50% when using special detection equipment to locate mines/explosives or +10% to locate other types of traps with detection equipment.

**Note:** **Psi-hounds/Dog Boys** who are of the Bloodhound and German **Shepherd/Alsatian** breeds have a base skill of 35% +5% per level of experience to literally "sniff-out" explosives, magic traps, and "sense" other types of traps without benefit of special equipment! However, these "Sniffers" must undergo special training, and this special focus reduces their other sensing abilities by -10%. The ordinary Bloodhound or Shepherd Dog Boy does not get any special bonus or ability and must use mechanical equipment and his ordinary senses to locate mines and traps.

**Underwater Demolitions:** Fundamentally the same basic skills and training as demolitions, but with an emphasis on using explosives in an underwater environment, including underwater techniques, area affect, sound wave damage, different types of explosives, as well as arming, disarming and repairing torpedoes and depth charges. **Base skill:** 56% +4% per level of experience. **Note:** Any character with the demolitions skill can use explosives underwater, but is -10%.

**Recognize Weapon Quality:** The ability to accurately determine a weapon's durability, reliability, and quality by physically examining it. This includes knowing which manufacturers are reputed to make the best weapons, the ability to recognize damage or signs of misuse, modifications/customization or wear and tear, whether the weapon can be made as good as new with a little repair work and/or cleaning, whether it is a cheap (or quality) "knock-off (copy/imitation), and so on. The character can also recognize if the weapon is stolen (serial numbers filed away, etc.), new, old, and if it has any other special features or properties as well as know what the fair price should be. **Base Skill:** 25% +5% per level of experience. **Note:** Reduce the skill ability by half if the item is not actually handled (seen but not **touch**ed/**exam**ined).

---

## **Piloting Skills**

**Hovercycle:** Characters who select the *pilot hover vehicles* skill can drive hovercycles, cars, etc., however, those who specifically select the *pilot hovercycle* skill can pilot any type of hovercycle with skill and finesse. They can also perform jumps, stop on a dime, dive-drop (i.e. soaring off the edge of a cliff, keeping control of the hovercycle and keep on going without crashing when they reach the bottom), and tricks without penalty (-20% to piloting rolls if the only skill is the general *pilot hover vehicles*). **Base Skill:** 70% +3% per level of experience.

---

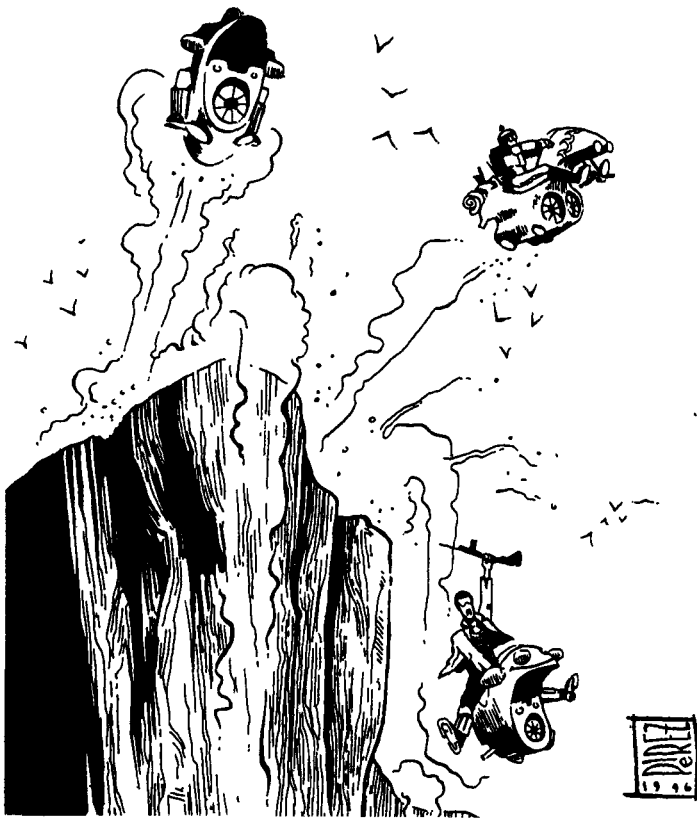

## Rogue Skills

**Cardsharp:** A skill that involves the manual dexterity of hand and finger manipulation to perform tricks, palming, and other gimmicks of sleight of hand with playing cards. This includes dealing from the bottom or middle of the deck, stacking a deck (to the **cardsharp's** favor), hiding cards up the sleeve (and elsewhere), fancy and impressive methods of shuffling and dealing the cards, as well as "marking" cards, card counting and understanding the odds.

Marking cards often includes a complex series of Braille-like indentations, punctures or trimmed edges so that they were slightly concave or convex, all things that the delicate touch of the professional **cardsharp** can feel as he deals the cards. Other types of "marks" include incredibly subtle, almost indiscernible variations of the pattern on the back of cards, typically in the right, upper corner.

A failed roll means the character has fumbled the trick, missed (or misread) one of his secret markings, or was too obvious and is caught cheating! **Base Skill:** 24% +4% per level of experience. Add +4% if the character also has the *palming* skill.

**Safecracking:** This is a specialized skill in which the character studies the strengths, weaknesses, and construction of safes and how to open them without damaging the contents inside. The fingers of the safecracker are so sensitive that they can "feel" the subtle calibration of combination locks and other locking mechanisms. When using explosives, they can use their abilities to such precision that they can "blow" the lock off a safe, security door, safe deposit box and similar without creating a big, area affect explosion or inflicting damage to the contents (a failed **safecracking** skill or demolitions roll means the explosion was too much and the contents are damaged). **Base Skill:** 20+4% per level of experience. **Bonuses:** Adds +5% bonus to the lock picking and demolitions skill. **Penalties:**

Requires focus, concentration and keen hearing, characters with a M.E. under 15 are -10% on this skill.

**Seduction:** This is the ability to make the opposite sex melt with desire. This skill is somewhat similar to the interrogation skill, in that the seducer knows how to ask the right questions to get information without being obvious. The seducer usually seems attentive, sympathetic, and **alluring/sexy**. Men and women, who are seduced, tend to have loose lips — meaning they tend to talk freely, say more than they should, and tell secrets. They also lose track of time, spend big money to impress and please their seducer, and lavish her or him with their affection, time and attention, while oblivious to everything else around them.

Most of all, somebody who is seduced is vulnerable. The person who is *successfully seduced* is distracted, skill performance is half and takes twice as long to perform, the character has *no* initiative, **doesn't** notice people or events around **him/her**, and is easily caught off-guard; no initiative and all bonuses are at half when attacked by a character other than the seducer. Worse, the victim(s) of seduction is completely vulnerable to the seducer! The seducer always gets the first strike/attack/action (any roll above a 4 hits or is successful). The victim has no chance of self-defense against that first attack, plus loses one **attack/action** from surprise or horror. In addition, the seducer is +5% to pick the pockets of, palm, or plant things on **his/her** victim of seduction, as well as +5% to the skills card shark, sing and dance. Research has shown that the more alcohol the intended victim drinks, the easier he/she is to seduce (+5%).

**Base Skill:** 20% +3% per additional level of experience. **Skill Bonuses:** +1% for every *one* M.A. attribute point above 20, and every *two* P.B. above 17. So a character with a P.B. 23 (+3) and M.A. 24 (+4) would be +7% to successfully seduce. The seducer can influence more than one person at a time; one additional per every three levels of experience.

**Ventriloquism:** The practiced ability to throw one's voice. This can be used to create the illusion of not speaking while making a voice or verbal noise appear to be coming from someone or something else, such as a puppet, a tree, box, chair, etc. Maximum range is 10 feet (3 m) away. A failed roll means the voice is not well thrown or the ventriloquist's mouth is seen moving, so the trick does not work. **Base Skill:** 16% +4% per level of experience.

## Technical

**Breed Dogs:** The first percentile number indicates the art of raising, **mating/breeding**, taming and training domestic and wild canines, as well as a knowledge about canines in general.

The second percentile number is used to attempt to tame a wild canine, teach a dog tricks, or to train the animal for a specific task like tracking, retrieving, pointing, herding animals, attack on command, and so on. A failed roll means that the animal refuses to learn that particular trick or specialty. Note: These are trained work animals or pets, not familiars. **Base Skill:** 40%/20% +5% per level of experience.

**General Repair/Maintenance:** Not everyone can be an Operator, blacksmith or a carpenter, but many are good with their hands and capable of doing **satisrepair/maintenance** skill includes: sharpening blades, minor repairs on weapons, packing their own S.D.C. bullets/ammunition, sew tears in clothes (it

may not look pretty, but does the job), replace a wagon wheel, change a tire, shoe a horse, repair furniture, paint, varnish, nail and assist in basic woodworking, and even do minor patchwork on armor (restores 1D6 M.D.C.).

Roll once to see whether the character can figure out what's broken, what must be done to fix it, and whether it's beyond his meager abilities. Roll again to determine success or failure in making the actual repair. If failure, the player may try again, but only twice. **Base Skill:** 35% +5% per level of experience. Reduce skill proficiency by half if the item is extremely damaged, complex, high-tech or alien.

**History of the West:** This is a basic historical knowledge of the myths, legends and (distorted) history of the pre-Rifts West, as well as the post-Rifts New West. The focus of this history is on cowboys, gunslingers, **gunfighters**, Indians, and their weapons, habits and mannerisms, as well as the Code of the New West, Cowboy's Code, and basic information about notable monsters, vampires and famous people and outlaws. The base skill percentage indicates the approximate degree of information the character has learned or can remember accurately. **Base Skill:** 30% +5% per level of experience.

**Law (general):** The study of Law allows the character to know many legal precedents, procedures and punishments *common* throughout the Western Wilderness. It includes the Code of the West, notable Indian, **Simvan** and **Psi-Stalker** laws and customs, and the laws of most major towns, as well as the rudimentaries of Coalition law. This can be an invaluable skill when trying to bargain for one's life in a courtroom. **Base Skill:** 25%+5% per level.

**Lore: Cattle/Animals:** This is a general knowledge about cattle, horses, livestock, and other notable animals of the West. This knowledge includes what they eat, where they live in the wild, means of defense, the value of their meat, fur, hides and horns, and their natural predators, as well as the most notable tales about supernatural animals, spirits, gods and magic attributed to or involving animals (including some Indian spirit and totem lore). **Base Skill:** 30% +5% per level of experience.

**Lore: Indians:** Characters with this skill can recognize the different tribes and nations, warriors and shamans, totems, fetishes and warnings, identify the people by their housing, clothing and weapons, and has a fundamental understanding about the Native Americans' society, beliefs, customs and laws — at least the most notable. They also know about Indian gods, spirits, and magic. **Base Skill:** 25%+5% per level.

**Lore: Religion:** The study of religions, gods and beliefs. This skill provides a comprehensive knowledge of the religions of North and South America, past and present, their beliefs, rituals, holy places, pantheons of deities and supernatural creatures (demons, spirits, angels) and their stories of creation, myths and legends. The skill will help a character recognize specific rituals, their purpose, the deity(s), whether a blood sacrifice is necessary as well as religious fetishes, charms, icons, and similar. The percentile number indicates the degree of knowledge one has about a particular religion and his ability to remember it. Preachers frequently carry bibles and spout out speeches of fire and brimstone before they deal out swift frontier justice. **Base Skill:** 30% +5% per level of experience.

**Prospecting:** The character can recognize and evaluate precious and semi-precious metals (gold, fool's gold, silver,

bronze, copper) in their natural ore appearance and as refined and polished jewelry. In addition, the character has a good idea where to look for such mineral deposits, and the fundamentals of "panning" for gold and the general knowledge of mining and how to use various types of simple mining equipment.

Furthermore, the character can identify and appraise the value of precious metals (silver, gold, etc.) and stones (diamonds, rubies, etc.), and to identify fakes, but at a penalty of -10%. A failed roll means the character cannot tell whether or not the item is fake or real, or he grossly under or overestimates its value. **Base Skill:** 20% +5% per level of experience.

**Whittling & Sculpting:** The art of carving wood, bone and horn into three dimensional figures/statues/toys, designs, and simple objects like wooden stakes, arrows, fishing hooks, walking sticks, staves, bowls, a simple flute or whistle, and similar. Many characters with this skill simply use it to pass time and don't necessarily make anything from their whittling. The percentile number indicates the quality of technique and the quality of the work/appearance. Taking the skill twice indicates a professional quality and gets a bonus of +10%. Selecting it once, indicates a talented amateur. **Base Skill:** 30% +5% per level of experience.

## Weapon Proficiencies

**A note about Weapon Proficiencies (W.P.):** Each W.P. provides combat training with a particular type of weapon. The result is hand to hand combat bonuses to strike and parry whenever that particular weapon is used. All bonuses are cumulative. Each W.P. counts as one skill. The character may select several W.P.s or a few. **Note:** Characters without a W.P. *can* use any weapon, but without benefit of the W.P. bonuses.

**W.P. Bola:** The Bola is an old weapon of the South American Indians who taught its construction and use to the **gauchos**. The classic weapon was three rawhide thongs joined at one end and at the other, three cords tipped with metal or leather covered stones; the length of the cords varied from 3-10 ft (0.9 to 3 m). When thrown accurately, the bola could entangle the legs to bring down a running animal. One or two weighted balls were used for hunting small prey like rabbits and birds.

**Damage:** 2D4 S.D.C. As one might expect, various weapon manufacturers have created **bolos** with 1-3 grenades instead of weights, and Northern Gun has created one that works like a *Neural Mace*, with the stunning charge delivered by remote control once a victim has been ensnared.

**Bonuses:** +1 to strike, disarm and entangle at levels 2, 5, 10 and 15.

**W.P. Whip:** Skill at "whipping" or snapping with long, flexible weapons typically made of leather, rawhide, reeds or M.D.C. cords.

**Damage:** Single cord whip: 1D6 S.D.C., Bull Whip: 2D6 S.D.C., Cat-O-Nine Tails: 2D6 S.D.C.

**Bonuses:** +1 to strike, disarm, or entangle at levels 2, 4, 7, 10, and 13. +1 to damage (special) at levels 2, 4, 8, and 12. This weapon *cannot* be used to parry! An M.D.C. whip still inflicts S.D.C. damage, but is more resistant to damage.

**W.P. Sharpshooting Specialty:** Sharpshooting is a combination of special expertise and trick shooting with a



particular type of weapon, typically revolvers, pistols and energy pistols, but sometimes includes rifles. It was first developed by **Gunfighters** and quickly adopted by the **Gunslingers** and **Lawmen of the New West**. This skill can be developed by any of the **Men at Arms O.C.C.s** but is fairly uncommon among most, except for *Gunfighters*, *Sheriffs* and *Gunslingers*.

W.P. Sharpshooting must be selected for each weapon *type* or category of weapon (revolver, pistol, energy pistol, rifle, etc.) in which the Sharpshooting expertise is desired. This means if the character wants to be a specialist with revolvers, that's one Sharpshooting selection at the cost of two O.C.C. Related skill selections, plus the W.P. selection (Sharpshooting can be applied to O.C.C. weapon skills, but not secondary skills). If Sharpshooting is also desired for W.P. energy pistol, the skill must be selected again (at the cost of two O.C.C. Related skills). This process is repeated for each W.P. that the added benefits of Sharpshooting is desired. Since each Sharpshooting selection costs the equivalent of two O.C.C. Related skill selections, even most Gunslingers and Gunfighters seldom have more than one or two Sharpshooting specialties — most Men at Arms don't have any.

### Restrictions & Conditions:

All bonuses and tricks are only possible with W.P.s to which the Sharpshooting skill has been added. Thus, a character with Sharpshooting: Revolver does *not* get the Sharpshooting bonuses when firing an energy pistol.

The Sharpshooting skill can be added to all *modern guns*, from revolvers (six-shooters) to energy rifles, but does not include W.P. Heavy and W.P. Heavy Energy Weapons; i.e. it cannot be applied to rail guns, rocket launchers, mini-missile

launchers, bazookas, artillery weapons, vehicle or robot weapons, hand grenades, or explosives. Likewise, Sharpshooting cannot be applied to weapons that don't shoot, such as clubs, maces, knives, swords, axes, whips, or even spears, knives, bolas and other weapons that can be thrown.

The Sharpshooting skill can be combined with the *W.P. Archery & Targeting* skill, but is applicable only to the *sling*, *crossbow*, and *bow and arrow*.

Only the *Gunfighter*, *Sheriff* and *Gunslinger O.C.C.s* automatically get a few Sharpshooting skills among their O.C.C. skills, but any additional selections cost them two O.C.C. Related skills like anybody else.

This skill is never available to robots, master psionics, practitioners of magic, dragons, demons or any creatures of magic or supernatural beings.

Juicers, Crazies, and 'Borgs are limited to only one Sharpshooting skill.

Characters cannot trade in Secondary Skills for the Sharpshooting skill.

---

### W.P. Sharpshooting Bonuses:

All bonuses are in addition to the conventional W.P. bonuses.

**The Sharpshooter's "Aimed" Shot (applicable to both the single shot and the aimed burst shot):** +1 to strike with a P.P. 20 and for every additional five P.P. points above 20, but the bonuses are only applicable when the appropriate type of weapon is used. Aimed shots only. No bonuses for shooting wild.

---



**The Sharpshooter's "Called" Shot:** The Sharpshooter's "aimed" shot bonuses are NOT applicable when using this special "Called Shot." Instead the sharpshooter uses the following superior bonuses: +1 to strike with a P.P. 18 and for every additional three (3) P.P. points above 18, but the bonuses are only applicable when the appropriate type of weapon is used and this special called shot counts as two melee attacks/actions. Aimed shots only.

**Quick Draw:** +1 to initiative at a P.P. 18 and for every additional four (4) P.P. addition to other initiative bonuses.

**The Bonus Attack:** +1 melee attack when using that specific weapon for the entire melee round.

### Trick Shooting:

Most Men at Arms can pick one of the following tricks (or roll 1D6 for random determination), but the *Gunfighter*, *Sheriff* and *Gunslinger O.C.s* get ALL six!

1. Can fire a traditional two-handed weapon, like a rifle, one handed without penalty (normally the shooter loses all strike bonuses).

2. Can shoot over his shoulder by holding up a mirror and using the reflection to aim. Reduce the bonus to strike by half, unless a *Gunslinger* or *Gunfighter* who keep full bonuses to strike.

3. Accurately shoot while riding a horse or a moving vehicle (normally a wild shot), but strike bonuses are half and a "called" shot is impossible (-8 to strike and strike bonuses do not apply).

4. Shoot accurately while standing on head or hanging upside down; all bonuses applicable at full.

5. Dodge, roll or somersault and come up shooting (normally a wild shot), no bonuses or penalties to strike; straight roll of the dice.

6. Ricochet shot! The shooter can bounce bullets, arrows, slings, and other fired *projectiles* (depending on the specific W.P.) off of one surface and angle the shot in such a way that the projectile *ricochets/bounces* off and hits a different/second target! Inflicts only one point of damage to the first surface and full damage to the second. Reduce bonuses to strike by half.

This can also be done with laser weapons but the *ricochetting* surface must be mirrored or highly polished. Glitter Boys are excellent reflective surfaces for performing a ricochet laser shot. Particle beams, ion blasters, rail guns, mini-missiles and other types of weapons *cannot* be used.

---

## Combat Notes

---

**Disarm:** In hand to hand combat, the act of disarming is simply getting rid of the opponent's weapon; it does no damage. It can be used as a defensive move in place of a dodge or parry, or can be done as an **attack/strike**. In modern combat, the act of disarming may involve shooting an opponent's weapon out of his hand; it does no damage.

The disarm move with a hand-held weapon like a sword, knife, staff or whip is a strike, and a hold or grappling maneuver that causes an opponent to drop his weapon or whatever he's holding. Using a gun to shoot a weapon out of an opponent's hand requires a called shot and careful aim (only the gunslinger can shoot to disarm on a quick draw). The maneuver counts as

one melee **attack/action**. Disarming an opponent does not mean the weapon falls into the hand of the character making the disarm move. True, the item is forced out of the victim's grasp, but it is either knocked away or falls to the ground.

Typically an opponent is disarmed on a roll of a natural 19 or 20, and is used as a defensive action. A few O.C.s get a bonus to disarm.

To disarm, roll to *strike* as usual — high roll wins. A failed disarming attack does no damage, but means one's opponent remains armed, is probably mad, and ready to strike back.

**Entangle:** A defender can attempt to trap the weapon, arm or foot of an opponent. This is done instead of parrying or dodging, and counts as one melee **attack/action**. An entangle is successful if the defender rolls above the attacker's strike roll. It takes one attack and another roll to entangle to keep an opponent's arm or weapon trapped/pinned every melee round. In order to get free, the entangled opponent must roll a dodge against the entangle roll; high roll wins. The character using the entangle move cannot attack without releasing his entangling hold.

Entangle with a whip or rope is a bit different in that it can be used at a distance to disarm or to ensnare and knock or pull an opponent down. Roll to strike as usual. Also see the Roping skill.

**The Showdown:** The classic Western showdown is a duel usually between two adversaries. However, sometimes one character will face 2-4 opponents, although this is not the traditional or proper way to do things.

A proper showdown: A gun duel between *two* characters, usually with revolvers or pistols (can be S.D.C. or M.D. weapons), but can be with a rifle or even knives.

**First**, one "calls out" (challenges) his opponent. This can be a courteous or angry challenge, and as simple as, "I'm calling you out," or an insult or threat with obvious implications for a showdown, like, "You son of a ..., stand and defend yourself," or "You low down, cowardly polecat! It's time we see which one of us is the fastest gun." and so on.

**Second**, the character being "called out" must accept. If he doesn't, the gunman making the challenge must either convince him to accept (usually through insults and threats), back down, or (try) to shoot him down in cold blood — i.e. in the back or without giving his would-be opponent a fair chance to draw.

**Third**, when the challenge has been accepted, either a time is set in which they will meet for the duel, or, as is more often the case, the showdown occurs then and there. A Showdown can be "called" **anyplace** and done indoors (often inside a saloon or gambling hall) or taken to the street. Courteous, noble and honorable shooters will take the fight to the street, an alley, or nearby field to avoid damaging property and injuring innocent bystanders. Smart bystanders will take cover to avoid getting hit by any stray bullets or blasts.

**Fourth**, the two opponents take their places and face each other. This can be close quarters, 8-15 feet (2.4 to 4.6 m; usually indoors), or a more challenging distance of 20-40 feet (6 to 12.2 m), depending on the Duelists and the situation.

**Fifth**, a showdown is typically a "quick-draw" contest, with the winner being the one who can draw and shoot the fastest. Unlike some movie dramatizations, more than a single shot is usually fired by each of the shooters, and can continue even if one or both Duelists are shot and fall to the ground.

**Sixth**, a showdown is intended to be a *duel to the death*. Consequently, protective body armor, at least helmets and chest plates, are usually removed, and the first shot to actually hit each gunman does double damage. All subsequent shots do normal damage for that weapon.

**Note:** Cheating in a showdown by having snipers waiting outside, or using magic, psionics, or a force field to secretly protect oneself or to negatively affect one's opponent is considered the lowest of the low. Those who cheat will be loathed, even by Gunslingers and Bounty Hunters, as a complete and totally treacherous snake, which also means it's okay to shoot this pig down in cold blood!

Until somebody decides to rid the world of this vermin, all professional gunmen (except for the most evil and vile themselves), including Gunslingers, **Gunfighters**, Juicers, **Headhunters**, scouts, mercenaries, soldiers, cowboys and lawmen, will treat the character like a leper, avoiding polite contact and business with him, snickering and making insults

behind his back (often loud enough to be heard), spitting at his feet (a classic sign of disrespect and disdain in the west), and sometimes worse. The only thing that might ease the insults and foul treatment is challenging some of these people to fair showdowns, but it will not change the character's status of being a despicable killer and "pariah" even among murderers — such is the Code of the West.

Those who earn this reputation (even with one incident) will be despised, looked down upon (feared perhaps but never respected), and so branded for the rest of his life. Work with Men at Arms will be hard (even impossible) to find — "we don't want your kind," and the individual is considered a fair target for all manner of degradation, robbery and murder. Furthermore, word of such treachery will spread throughout the New West with lightning speed. When the misanthrope is finally killed, he is usually spit upon and buried in an unmarked grave or left out on the open plains as food for the buzzards and insects.

---

# O.C.C.S & NPC Villains of the New West

By Kevin Siembieda  
with ideas & additional text by Chris Kornmann

---

The following Occupational Character Classes are typical of **Rifts® New West**. Many are gunmen and fighters, others adventurers and drifters. These characters are generally suitable as *player characters* and *Non-Player Character (NPC) Villains*.

The Bandit, Highwayman, Bounty Hunter, Gunslinger, Wired Gunslinger, **Psi-Slinger**, Saddle Tramp, Saloon Girl and Saloon Bum are perfect as *villains* for any Western setting.

Some of these New West gunmen and adventurers travel to the east and other "civilized" places where a quick gun or strong body can find work, or where they can retire (often in anonymity). However, most prefer the freedom of the wide open spaces and anarchy of the West and other wilderness areas. Most feel out of place and edgy in quiet towns and big cities, even the Burbs. There are just too many people in too small and crowded a place, making these men and women of the plains feel like tigers trapped in a cage. Life in the uncertain wilderness, fighting and adventure are more than their livelihood, it's their life's blood. Consequently, most will die in the saddle with a gun in their hand.

**Men at Arms O.C.C.s**

Bandit (Peasant Thug)	Justice Ranger
Bandit: Highwayman	Psi-Slinger
Bounty Hunter	Saddle Tramp
Gunfighter	<b>Sheriff/Lawman</b>
Gunslinger	Sheriff's Deputy
	Wired Gunslinger

**Adventurers & Others**

Cowboy	Professional Gambler
Mining 'Borg	Saloon Bum/Stoolie
Preacher	Saloon Girl/Barmaid

## Drifters

"Drifter" is a general term for anybody who is just passing through without friends, relatives, business or specific purpose for being in the area. A Drifter can be virtually any O.C.C. from Saddle Tramp, Gunslinger or Mercenary, to a Rogue Scholar or practitioner of magic. Generally speaking, a drifter is a character who, for the moment, has no specific goals, direction or purpose, and is simply wandering, or "drifting," from place to place and job to job. Vagabonds and Saddle Tramps are by their nature, drifters.



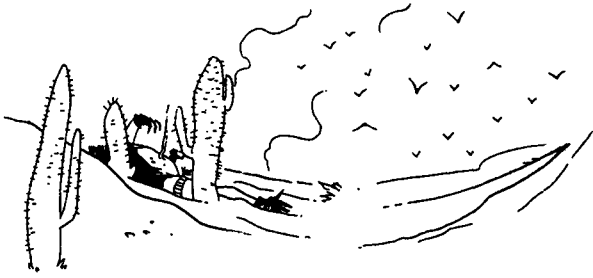

---

## The Code of the New West

---

Most cowboys, lawmen, gunfighters, adventurers, and even some bounty hunters, gunslingers, mercenaries and bandits live by a code of ethics that is known as the "Code of the New West," or simply as, "The Code." It is a simple code of conduct adopted by many of the hard and rough men and women, humans and D-bees, of the American Western Wilderness, particularly among those of principled, scrupulous and aberrant alignments. Those who break, mock or condemn The Code are regarded with contempt or worse.

---

- Never draw your weapon unless you're prepared to use it!
  - Never cheat in a showdown, or expect to live like a snake.
  - Never kill or deliberately hurt women and children.
  - Never kill clergy, 'cept in self-defense.
  - Never kill, injure or steal another man's horse or vehicle, unless he's dead and ain't needin' it no more.
  - Never take another man's woman.
  - Never destroy a church or holy place, unless it is a place of evil — and then beware the wrath of gods and demons.
  - Never take more money than what's owed to you.
  - Never spit in the face of the law. Show respect until its proven that the law in that town ain't genuine.
  - Show women folk respect; remove your hat and avoid cursing.
  - Respect the land and power of nature.
  - Respect (and fear) magic.
  - Respect and honor a worthy opponent.
  - Treat others like you'd like to be treated. Show cowboys and travelers kindness and hospitality unless they ain't worthy of kindness or mercy.
  - If you cheat at cards or break the law, expect to pay the consequences. Just because you don't get caught or punished one time, don't make it right.
  - Keep your sworn word of honor, "because sometimes all a man's got is his honor." A man's word is his contractual bond.
  - Kill only in self-defense and in justice. The latter can include acts of revenge, "eye for an eye," protecting others, using deadly force against those known to be killers, etc. The only exceptions to this rule are vampires or other "hellspawn demons." The only good vampire or demon is a dead one (including Brodkil).
- 

## Bandit O.C.C.

Regardless of what the character may call himself, bandit, **bandito**, Raider (Pecos or otherwise), gangster, gangster, highwayman, bushwhacker, etc., the typical, "bandit" is a vagabond thug. Most are young (under the age of 35) drifters born to, and raised by, peasants. They see a life as bullies, robbers and outlaws as both a viable career and a means to "be somebody." Most (98%) are uneducated and less than 1% are even partially literate. Despite what most people think, the majority are not very good at wilderness survival because they travel in groups, pool their skills and resources, and typically travel from one town, village or camp to another, stealing what they need along the way. A bandit can be human or D-bees, but the vast majority are males (85%).

The most murderous, destructive and frightening bandits get the most notoriety, however, many bandits are robbers and bushwhackers who try not to kill innocent people. There are two main reasons for this, one, is a conscious attempt to avoid a death sentence, and the other is the simple fact that a crook, especially a robber, is not automatically a killer. Don't get the wrong idea, bandits won't usually hesitate to shoot in self-defense against the "law," and will take hostages, beat, maim and kill to save or protect themselves and their fellow gang members. They tend to be a kind of **Jack-Of-All-Trades thief**. They might pick a pocket in a bar, take a drunk's guns while he sleeps, cheat at cards, shoot a man in cold blood because he sassed back, steal a horse, rustle cattle, stage a holdup, and buy and sell stolen goods, all in a week's work. The thing to remember about the outlaw is never turn your back on them.

While it is said "there is no honor among thieves," many bandit gangs are small, close-knit and loyal to each other. Of course, the bond between members of a gang will vary from group to group, but for many, a gang takes the place of family, and in some cases, *is* family! Family clans, especially among D-bees, can represent 25-60% of a gang (brothers, cousins, etc.). The members of close-knit gangs will not only defend themselves but also help and defend other members of their gang. This also means arranging jail breaks, kidnapping and swapping an innocent person(s) for an imprisoned gang member, and acts of retribution, revenge, vendettas and outright war against specific lawmen, towns, tribes, races, families, individuals, and rival gangs.

**Leadership** typically goes to the *strongest*. However, in a *gang* situation, the strongest is likely to be the man or woman who has the respect and support of the largest number of people. Thus, a character who is intelligent and cunning, and/or resourceful and charismatic, is more likely to lead a gang than **Bruno the Terrible** with his P.S. 32, P.P. 20, but an I.Q. of 7 or 8 and the personality of a dead fish.

**Note:** "*Bandit*" is a broad term that can include any selfish or evil character who engages in acts of banditry, i.e. robbery, armed robbery, kidnapping, extortion, murder, and similar crimes. This means any number of O.C.C.s can also be a bandit. The vast majority of "bandits" and "outlaws," are either professional criminals or men of arms — soldiers, mercenaries, Juicers, 'Borgs, etc. — who have turned to armed robbery and/or worse to make a living. The most common O.C.C.s who turn to banditry include the following:

Soldier/Warrior/Fighter (roughly equivalent to a CS Grunt)  
 Glitter Boy Pilot (or pilot of any other type of power armor)  
 Wilderness Scout  
 Headhunter  
 Juicers  
 Crazies  
 'Borgs  
 Vagabonds (wandering thugs and thieves)  
 City Rats (particularly common among organized crime families who control and dominate towns and cities, as well as the Black Market).  
 Bounty Hunter  
 Gunfighter  
 Gunslinger  
 Wired Slinger  
 Psi-Slinger  
 Saloon Bum  
 Saddle Tramp

\* Forger  
 \* Freelance Spy  
 \* Master Assassin  
 \* Safe Cracker  
 \* Smuggler  
 \* Special Forces  
 \* Super-Spy  
 \* Thief, Professional

Additionally, a *bandit* can be virtually any other Men at Arms or Adventurer and Scholar O.C.C.s who engage in a life of crime.

D-bees and mutants also frequently turn to crime. These characters are often limited to skills and abilities of a specific Racial Character Class (R.C.C.), with a majority of *Psi-Stalkers*, *Simvan*, *Tokanii*, *Brodkil* and *feral Dog Boys* found in Lone Star and the New West.

Note: A single asterisk indicates O.C.C.'s found in the dynamic sourcebook, *Rifts® Mercenaries*, plus other appropriate O.C.C.s and R.C.C.s may be found in other world books.

Of course, **psychics**, **practitioners of magic** and **supernatural beings** (dragons, Brodkil, werebeasts, etc.) can also be active members of gangs, clans and tribes, but they represent only 5% of the overall outlaw population of the Pecos Bandits of the New West.

## Bandit NPC Villain or Optional O.C.C.

**Also known as Bandito, Desperado, Rustler, Raider and Pecos Raider.**

**R.C.C. Requirements:** None, although a high P.S. and P.P. is helpful, and those with a high I.Q. are often the leaders of gangs.

**Player Character Note:** Bandits are ideal as NPC villains. Player characters who are bandits, especially those who have ridden with or are recognized members of a notorious gang or gang leader, are likely to be wanted criminals with a price on their heads. This means encounters with Coalition troops, lawmen, and **Cyber-Knights** *may* turn ugly. Likewise, bounty hunters, mercenaries, adventurers, and outlaws may want this character for the reward or revenge. The player character will undoubtedly have many enemies, from the CS and other authorities to townsfolk, and may have a reputation that is exaggerated. Such an outlaw as a member of the player group *may* negatively affect the credibility and perception of the entire group — guilt or fear by association, i.e., if so and so is a friend/comrade, then the entire group must be just as bad (and can't be trusted and may not be wanted).



**Alignments:** The typical bandit is anarchist or evil and does *not* live by the Code of the New West. A quote from one notorious outlaw, pretty much sums up most bandits' regard for the Code; "Fair play is a jewel, but I don't much care for jewelry."

Robin Hood types and those who exclusively victimize the CS, other bandits, or evil forces may be any alignment, including *good*. **O.C.C. Bonuses:** +2D6+10 S.D.C., +1 on initiative, +2 to save vs horror factor.

**O.C.C. Skills:** All new skills start at level one proficiency.

Speaks American and Spanish at 90% efficiency.

Cook (+10%)

Fish (+10%)

Swim (+10%)

Climb (+10%)

General Athletics

Horsemanship: General or Horsemanship: Exotic Animals (+5%)

Pilot Vehicle (+10%)

Pilot one of choice (+5%)

Land Navigation (+12%)

W.P. Energy Pistol

W.P. Energy Rifle

W.P. Two of choice

Hand to Hand: Basic

Hand to hand: basic can be changed to hand to hand expert at

a cost of two O.C.C. related skills, or martial arts or assassin for the cost of three skills.

**O.C.C. Related Skills:** At first level the Bandit can select six "other" skills, plus one skill at levels 3, 6, 9 and 12.

Communications: Radio: Basic and Scrambler only.

Cowboy: None

Domestic: Any (+10%)

Electrical: None

Espionage: Tracking and Wilderness Survival only.

Mechanical: Basic Mechanics and Automotive only (+5%).

Medical: First Aid only.

Military: Camouflage and Recognize Weapon Quality only (+5%).

Physical: Any, except acrobatics.

Pilot: Any, except military vehicles, power armor, and robots (+5%).

Pilot Related: None

Rogue: Any (+10%)

Science: None

Technical: Any, except computer operation & programming.

W.P.: Any

Wilderness: Any (+5%)

**Secondary Skills:** The character gets four secondary skills from the list, excluding those marked "None," at level one, plus two additional at levels 3, 6, 9, and 11. These are additional areas of knowledge that do not get the advantage of the bonus listed in parentheses. All secondary skills start at the base skill level.

**Standard Equipment:** Typically some type of body armor from gladiator and Bushman to modified Coalition Dead Boy and Dog Boy armor (the latter is extremely common). Other common equipment includes tinted goggles or nonenvironmental helmet with or without visor or a cowboy hat, flashlight, cigarette lighter, pack of cigarettes, comb, pocket mirror, 100 ft (30.5 m) of lightweight rope, binoculars, wooden dagger and 2D4 stakes (for fighting vampires), knapsack, backpack, three large sacks, utility belt, air filter, and two canteens or water skins.

Weapons include a survival knife or hatchet, one or two Vibro-Knives, a pistol or revolver (energy or other), a rifle (energy or other), 1D4+1 additional **E-clips/ammo** clips for the weapons.

Starts with a fair to good quality horse *or* a battered looking, standard Speedster or Firefly hovercycle (reduce the usual M.D.C. by 3D4%).

**Additional Equipment:** Hand grenades, flares, magic items, special weapons, souped-up vehicles, better armor, etc., must be acquired later as the character gets booty or steals items.

**Money:** Starts with 3D4×100 credits worth of tradeable goods and 2D4×100 in universal credits.

**Cybernetics:** None, and most can't afford any later.

Note: See Rifts® **Lone Star** for more information about the life of an outlaw, gangs, and the bandits in and around the Pecos Empire; many of whom operate throughout the New West, using the Empire as their home base. **Lone Star** also presents information on the Lone Star Complex, mutants, Simvan, Psi-Stalkers, notable bandit leaders and villains, as well as a variety of common hovercycles, electro-stunners and information about the CS and Texas/Lone Star.

## Bandit: Highwayman O.C.C.

The Highwayman is a specialist in bushwhacking, ambushes and robbery on the road and in the wilderness. They can be lone, armed riders or lead a small group of 4-12 outlaws (bandits, thieves, other Highwaymen, sorcerers, **Psi-Stalkers**, Simvan, etc.).

Most Highwaymen are humans or D-Bees who live by the philosophy of only the strong should survive, and that the weak, foolish and careless are fair game for plunder. "The weak only deserve to be used," "might makes right," and "possession is nine tenths of the law," are all credos of this flamboyant bandit. Most are tough opportunists who will generally stoop to any level in order to further their own personal goals. Highwaymen tend to be very tricky, setting traps and ambushes for travelers and making dramatic (hopefully frightening and intimidating) entrances. Some have military backgrounds, some are extremely educated and others have always been armed robbers. They constantly exploit the element of surprise, carelessness and complacency. Highwaymen are masters at recognizing and exploiting opportunities, large and small. To create surprise, they will often cause diversions using explosives, fire, falling trees, magic, etc., arrange to have an "inside" (i.e. one or two of the seemingly innocent riders on a stagecoach or victims of a bank robbery will be one of their gang), use disguise and pure daring.

What makes Highwaymen different than the average, run of the mill bandit is their daring, risk taking, skill on a horse, and ruthlessness. They are amazing horsemen and/or hovercycle pilots.

### O.C.C. Highwayman Bonuses

+2D6+6 S.D.C.

+3 on initiative

+3 to pull punch

+2 to roll with punch, fall or impact.

+1 to save vs Horror Factor at levels 2, 4, 6, 8, 10, 12, & 14.

### Highwayman NPC Villain or Optional O.C.C.

**Also known as Bushwhacker, Highway Robber, and Highjacker.**

**R.C.C. Requirements:** I.Q. 9, M.E. 10 or higher; a high P.S. and P.P. are also helpful, but not a requirement.

**Player Character Note:** Evil Highwaymen are ideal as NPC villains. Player characters who are bandits, especially those who have earned a reputation, will be wanted criminals with a price on their heads. This means encounters with Coalition troops, lawmen, and-Knights *may* turn ugly. Likewise, bounty hunters, mercenaries, adventurers, and outlaws may want this character for the reward or revenge. The player character will undoubtedly have many enemies. Such an outlaw as a member of the player group *may* negatively affect the credibility and perception of the entire group — guilt or fear by association, i.e., if so and so is a friend/comrade, then the entire group must be just as bad (and can't be trusted and may not be wanted).

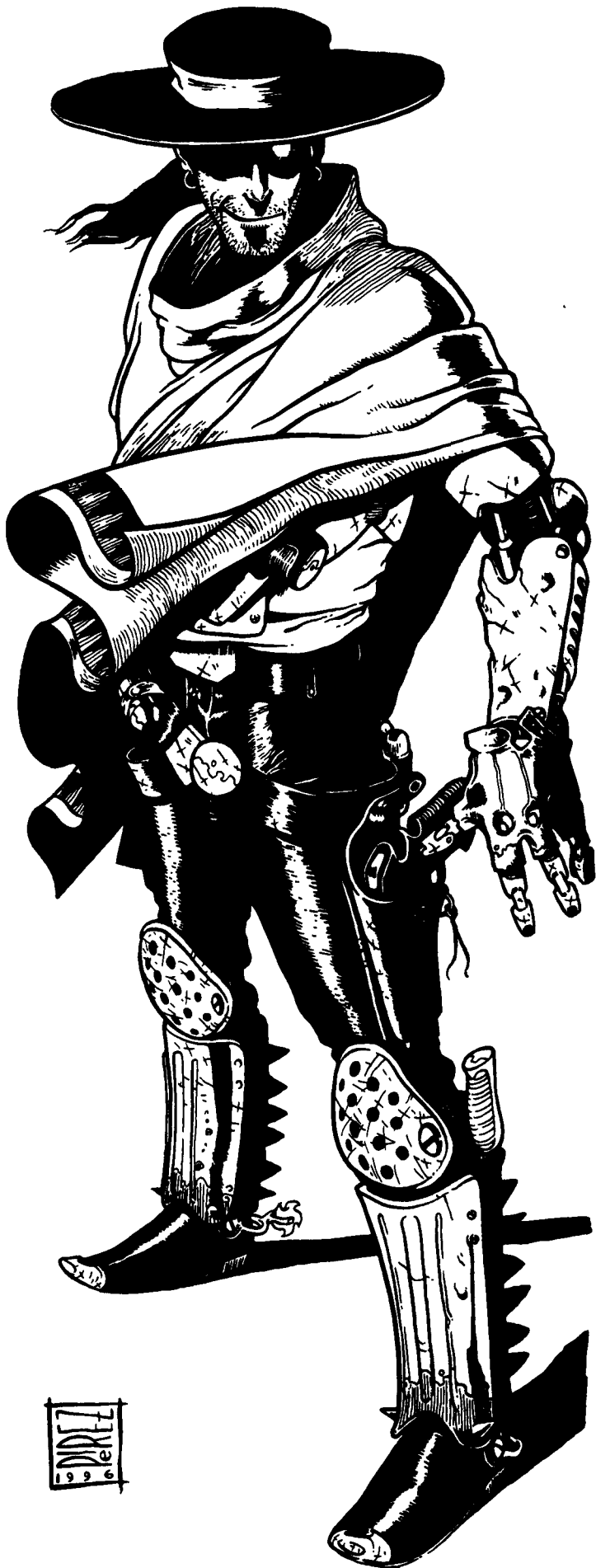

Good characters, Robin Hood types or those who prey on evil, are still likely to have scores of enemies and regarded as dangerous, daring brigands who cannot be trusted.

**Alignments:** Typically anarchist or evil. Robin Hood types and those who exclusively victimize the CS, other bandits, or evil forces may be any alignment, including *good*. Most Highwaymen tend to be loners and distrustful of others.

**O.C.C. Skills:**

- Speak native language 98%
- Speak one other language of choice (+20%)
- Radio: Basic (+10%)
- Camouflage (+20%)
- Detect Ambush (+15%)
- Find Contraband (+14%)
- Pilot Hovercycle or Horsemanship: Exotic (the latter is +10%)
- Trick Riding
- Land Navigation (+15%)
- Streetwise (+10%)
- Trap Construction (+20%)
- Trap/Mine Detection (+10%)
- Demolitions (+15%)
- Horsemanship: Cowboy
- W.P. two of choice
- Hand to Hand: Expert

Hand to hand: expert can be changed to hand to hand: martial arts or assassin for the cost of one O.C.C. Related Skill.

**O.C.C. Related Skills:** At first level the Highwayman can select four other skills, plus two skills at levels 3, 6, 9 and 12. All new skills start at level one proficiency.

- Communications: Any (+5%)
- Cowboy: Any
- Domestic: Any
- Electrical: Basic only (+5%)
- Espionage: Tracking and Wilderness Survival only (+10%).
- Mechanical: Basic Mechanics and Automotive only (+5%).
- Medical: First Aid only.
- Military: Any
- Physical: Any, except acrobatics.
- Pilot: Any
- Pilot Related: Any
- Rogue: Any (+5%), except Seduction and Computer Hacking.
- Science: Math only (+10%)
- Technical: Any
- W.P.: Any
- Wilderness: Any (+5%)

**Secondary Skills:** The character gets four secondary skills from the list, excluding those marked "None," at level one and one additional at levels 3, 6, 8 and 11. These are additional areas of knowledge that do not get the advantage of the bonus listed in parentheses. All secondary skills start at the base skill level.

**Standard Equipment:** M.D.C. body armor, including modified Coalition Dead Boy and Dog Boy armor, passive nightvision goggles, binoculars, tinted goggles or sunglasses, flashlight, cigarette lighter, pack of cigarettes, comb, pocket mirror, 60 ft (18.3 m) of lightweight rope, portable tool kit, 2D4 stakes and a silver cross (for fighting vampires), survival knife or laser scalpel, two pairs of handcuffs, small folding shovel, bedroll, backpack, two saddle-bags, two large sacks, two small sacks, utility belt, air filter, and two canteens.

Weapons include one **Vibro-Blade**, a handgun and rifle of choice, 1D4+2 additional **E-clips/ammo clips** for the weapons.

Starts with a good quality horse *or* a hovercycle of choice (typically the Prowler, see **Rifts® Lone Star** for stats for common hovercycles).

**Additional Equipment:** Hand grenades, flares, magic items, special weapons, souped-up vehicles, etc. must be acquired later as the character gets booty or steals items.

**Money:** Starts with 4D4×100 in tradeable goods and 1D6×1000 in universal credits.

**Cybernetics:** None to start.

## Bounty Hunter O.C.C.

The Bounty Hunter is a combination city rat, spy and wilderness scout who specializes in tracking down wanted criminals, desperados, and fugitives — dead or alive. These manhunters are often cold, unmerciful men and women with some past military or combat experience. They can be members of a group, mercenary company, adventurers' team, or a band of Bounty Hunters or bandits, but most Bounty Hunters work as individuals or in pairs (why split the reward with six or eight others if you can do the job yourself?). However, even these lone wolves frequently ride with, or join forces with, other adventurers, and most have a half dozen favorite "watering holes" where they feel safe or like to visit. The next most common Bounty Hunters are small groups of 4-8, typically with 2-4 professional Bounty Hunters while the other members of the team are various O.C.C.s (often psychics, practitioners of magic and augmented humans — 'Borgs, Juicers, etc.) and R.C.C.s (including Dog Boys, dragons, demons, and other supernatural beings), all of whom enjoy hunting intelligent prey.

The New West is home to some of the toughest criminals in the Americas. Many western towns and law enforcement agencies are not equipped to hunt down these criminals. This is where the Bounty Hunter comes in. For the right price, these men and women will track down, capture and/or kill dangerous outlaws and monsters. They often use disguises and/or pretend to be sheriffs, gunslingers, bandits, preachers, mercenaries, etc. — whatever it takes to get the job done. Good Bounty Hunters never give up and always get their man ... dead or alive.

Some Bounty Hunters think of themselves as heroes and lawmen, and *may* work with officers of the law and within the law. However, most (good, selfish, and evil) frequently see themselves as skating between or bending the laws of the various communities. Some consider themselves to be above the law, and sometimes find themselves working against it. This is especially true in situations where the law is hunting an outlaw(s) in order to bring him (them) in for a fair trial, while the Bounty Hunter is only interested in bringing back the outlaw's head to collect a reward. The reward or "bounty" placed on a criminal's head is frequently offered by one or more wealthy businessmen, rancher, politician, or aggrieved family member(s) looking for *revenge*, rather *than justice*. Worse, many Bounty Hunters are as bad as the slime they hunt, and do whatever it takes to get their man. Many of these lowlifes associate with outlaws, mercenaries and evil forces, and may even ride with bandits when pickings are slim.

One must remember this is the New West, a vast, harsh wilderness with scattered tiny oases of civilization (i.e. towns

and tribes). Outlaws and assassins have tens of thousands of square miles in which to hide, and dozens of oases of evil (bandit hideouts, mercenary camps, D-bee tribes, etc.) where they can take refuge. Furthermore, in a land *without* a uniform or unified set of laws and leadership, what may be a crime at one town is acceptable at another. And all too often, "might" makes "right." Powerful individuals, sorcerers, politicians, businessmen, ranchers, gangs, clans, and tribes, not to mention supernatural beings, often see themselves as above the law, and do as they please, sometimes blatantly and without shame. These powerful men, women and D-bees are frequently the ones who post *bounties* on the heads of outlaws or those they feel have wronged them, and sometimes even on rivals. They can also be the ones with bounties placed on their heads. This means that in the Western Wilderness, a character with a price on his head may *not* necessarily be an outlaw, and could be innocent or even a hero, but most Bounty Hunters (of selfish or evil alignments) don't care.

Unless the Bounty Hunter has some sense of ethics and moral code, most don't try to find out whether the person(s) they hunt are guilty and really don't care. The best these hardened hunters of men will do is make an effort to bring their quarry in "alive," and let whatever passes for justice take its course. Unfortunately, it is often easier to bring back the "dead" when the bounty gives one the option of "Dead or Alive." Likewise, most Bounty Hunters are the worst kinds of mercenaries who will work for anybody, from the Coalition States and criminal Kingpins, to the *Splugorth* and demon lords.

**Bounties.** The higher the bounty and the better it is publicized, the more likely it is to attract Bounty Hunters, Gunslingers, mercenaries and adventurers. It is also likely to create an atmosphere of competition between several groups of manhunters, which can lead to more conflicts and bloodletting.

Bounties are sometimes placed on wildlife (wolves, coyotes, lions, etc.) and monsters, from dangerous predators like *Ostrosaurus* to dragons, *Xiticix*, and demons. The bounties on comparatively less dangerous animals are usually low, 50-200 credits per head. The pelt or carcass may be kept as souvenirs or skinned and used or sold to recoup part of the bounty. For example, *Ostrosaurus* meat is often turned into dog food, and their teeth, horns and bones into jewelry, knitting needles, fishing hooks, flutes, arrows, weapons, and souvenirs.

Bounties on creatures like *Xiticix*, mutant animals, vampires, *Brodkil*, lesser demons and other medium-level threats (sometimes *Simvan* and other D-Bees) can range from 300-1500 credits.

Petty crooks and local thugs rarely have bounties placed on them, and when they are, the reward is typically 200-1000 credits.

Typically, big bounties of 10,000 to 50,000 credits are placed on the most flamboyant, annoying and dangerous criminals; i.e. a constant problem, steals huge amounts of money, cattle or valuables, causes massive amounts of destruction, killed somebody powerful or famous, or is guilty of numerous murders and/or other grievous crimes.

Bounties on powerful beings like greater demons and dragons, or high level (7th and higher) desperadoes like *Cyber-Knights*, *Juicers*, 'Borgs, *Gunslingers*, *Mind Melters* and practitioners of magic, or hated and wanted outlaws and gang



leaders usually range from 20,000-50,000 credits. **Note:** Bounties seldom exceed 100,000 credits on any individual.

**Collecting Bounties.** About one third of the time, there will be some problem collecting a bounty. The two most common problems are positive identification and lack of funds. No positive I.D., no payment is standard operations. So if the manhunter isn't careful, he may engage in battle and risk his life for nothing. Some clients will also use this as an excuse to refuse or reduce payment, even though they may believe or know that the bounty has been fulfilled; "maybe it's him, but we can't be sure. You understand. However, seein' how you have a good reputation an' all, we'll pay half." Video documentation can be faked, so it is *not* usually accepted as reliable proof of a kill. However, reliable witnesses (other than the Bounty Hunter's team or friends) *may* be sufficient, especially if a well known and trusted citizen, business person or a group of trusted and reliable people.

The other common problem with bounty collection is that the person, group or community that offered the bounty/reward *may* not have the full amount promised (1D6x10% less than promised). This is extremely common among small, poor communities and unreliable or unscrupulous individuals or groups. Those who are well intentioned are likely to pay what they can immediately, and either offer a reasonable payment plan (which may still take months or years to pay in full), or, more likely, offer goods in trade. The **trade of goods** is common practice and may include vehicles, horses, cattle, slaves, furs,



supplies, a deed for land, a ranch, or a mine (usually one that hasn't yet struck pay dirt or looks to be played out), to free room and board and special services (medical, vehicle repair, recharge E-clips, etc.). Depending on what is available and the temperament and needs of the Bounty Hunter, this is frequently acceptable and fair restitution.

Other problems for Bounty Hunters include vendettas leveled against them, being accused themselves of the commission of crimes or murder (if they killed people to make their bounty), being robbed when they obviously have a lot of equipment (especially after getting goods in trade), feuds and skirmishes with rivals and outlaws, and a general dislike and disrespect for the profession by just about everybody. Most lawmen and heroes view Bounty Hunters as dangerous, reckless and honorless rogues who cannot be trusted. The life of a Bounty Hunter is often difficult, **unglamorous** and lonely.

### **Bounty Hunter O.C.C. Bonuses:**

- +1D4 to P.E.
- +2D6+12 S.D.C.
- +2 on initiative.
- +3 to pull punch.
- +1 to roll with punch, fall or impact.
- +1 to save vs horror factor at levels 2, 4, 6, 10 and 14.

### **The Bounty Hunter O.C.C. and NPC Villain**

**Also known as Manhunter, Manslayer, Hatchet Man and Punisher.**

**Attribute Requirements:** I.Q. 7, P.S. 12, P.E. 12 or higher; a high physical prowess and speed are helpful but not required.

**Alignment:** Any, but tend to be anarchist and evil alignments. Those with anarchist and evil alignments are not likely to concern themselves with the welfare of others — if bystanders are too stupid or slow to get out of the way, that's their hard luck. Some Bounty Hunters are as evil as the villains they hunt.

Good characters will be far more discriminating about who they hunt, concerned about whether their prey will get a fair trial, and the welfare of innocent bystanders.

**Player Notes:** The profession of Bounty Hunter is generally looked *down* upon by most knights, lawmen, law abiding citizens, and even bandits tend to view them as vermin, largely because they have no loyalty except to the almighty credit. This means player characters, even those with a code of honor and who try to protect the innocent, may be treated with disdain, fear and suspicion. Bounty Hunters make excellent Non-Player Characters and villains.

### **O.C.C. Skills:**

- Speak native language 98%
- Speak one other language of choice (+20%)
- Basic Math (+20%)
- Radio: Basic (+15%)
- Surveillance Systems (+10%)
- Track Humanoids (+15%)
- Find Contraband (+10%)
- Land Navigation (+15%)
- Intelligence (+15%)
- Interrogation (+10%) or Seduction (+10%)
- Detect Ambush (+10%)
- Wilderness Survival (+15%)
- Climbing

Swim (+10%)

W.P. Energy Pistol

W.P. Energy Rifle

**W.P. One of Choice**

Hand to Hand: Expert

Hand to Hand: Expert can be changed to Hand to Hand: Martial Arts at the cost of one "other" skill (or assassin if an evil alignment).

**O.C.C. Related Skills:** Select two piloting skills and five other skills, but at least two must be selected from the espionage or military categories. Plus select two additional skills at levels 3 and 6, and one at levels 9 and 12. All new skills start at level one proficiency.

Communications: Any (+5%)

Cowboy: None

Domestic: Any

Electrical: None

Espionage: Any (+5%)

Mechanical: Basic and Automotive only (+5%)

Medical: Paramedic only.

Military: Any (+10%)

Physical: Any

Pilot: Any (+10%)

Pilot Related: Any (+5%)

Rogue: Any (no bonuses except +8% on streetwise)

Science: Math and chemistry only (+10%)

Technical: Any

W.P.: Any

Wilderness: Any (+10%)

**Secondary Skills:** The character also gets to select four secondary skills from the previous list. These are additional areas of knowledge that do not get the advantage of the bonus listed in parentheses. All secondary skills start at the base skill level. Also, skills are limited (any, only, none) as previously indicated in the list.

**Standard Equipment:** A suit of personalized mega-damage body armor (any kind, including Coalition armor), an extra suit of light M.D. armor, a set of travel clothes, a set of dress clothing, black and/or camouflage fatigues, a gas mask and air filter, tinted goggles or sunglasses, and an NG-S2 Basic Survival Pack, IRMSS robot medical kit, infrared distancing binoculars, portable language translator, 1D4+1 tracer bugs, pocket scrambler, 2D4 sets of handcuffs or manacles (80 S.D.C.), 2 M.D.C. handcuffs (15 M.D.C. each), 50 feet (15.2 m) of strong cord/rope, utility belt, backpack, knapsack, and 1D4 sacks.

Weapons include a **Vibro-Blade**, Neuro-Mace or Electro-Stunner (prod or spear; see **Rifts® Lone Star** for stunners), a conventional six-shooter (plus 96-144 silver bullets), one energy handgun and rifle of choice, three additional weapons of choice, 1D6 grenades, and passive, telescopic **nightsight** scope for rifle, and passive nightvision goggles for general use while manhunting at night.

Starts with a choice of vehicles: Hovercycle, motorcycle, land rover, or a good quality horse.

**Special Equipment:** Pick one (must have appropriate skill)

1. **Armor and Cash:** Black Market Triax T-10 or T-11 Cyclops, or New CS Dead Boy armor (100+ M.D.C.), or other similar excellent armor with a jet pack and 2D6×1000 extra credits.

2. Power Armor Suit: A Titan, T-C20 Terrain Hopper, Predator, Triax T-31 Super Trooper, or a Northern Gun or other similar suit of light to medium power armor. Automatically gets the *basic* pilot robots and Power Armor skill.

3. Magic Armor: One Techno-Wizard or other type of magic armor and one magic weapon (keep the items reasonable, not super-powerful). Or one major bio-wizard parasite, plus 1D4 microbes and a minor magic weapon (see **Rifts® Atlantis** for bio-wizardry).

4. Special Vehicle: A souped-up motorcycle, land rover, jeep, hovercycle, hover vehicle, or small truck with double the usual M.D.C., two M.D. weapons mounted on it, radar and long-range radio. Or a robot horse may be selected.

**Money:** The character starts off with 5D6×100 credits worth of tradeable items, 3D4×100 credits worth of gold or silver, and 3D4×100 in universal credits.

**Cybernetics:** Can have up to 1D4 cybernetic *implants* of the player's choice.

## Gunfighter O.C.C.

Do not confuse the *Gunfighter* with the *Gunslinger*. The latter is a quick-draw shooter who specializes in the use of handguns and murder — in many regards, he is a professional duelist and assassin.

**The Gunfighter** is a combination weapons master, marksman, mechanic (at least when it comes to weapons) and mercenary fighter. An expert in the use, handling, and repair of *all* types of weapons. Most are effectively Wild West mercenaries, although some dabble as gun dealers/smugglers and/or as military *advisors* for hire. Some become renowned heroes and lawmen, others drifters or outlaws. In some ways, the Gunfighter might be considered the New West version of a “Ronin,” a masterless Samurai. A man or woman who is an expert in weapons, war, and fighting, but who has no one master or cause for which he fights, and who travels the vast wilderness in search of conflict where his or her expertise can be put to use. Most follow the Code of the New West as well as their own code of ethics, honor and professionalism, which again harkens back to the samurai or knight.

Generally speaking, Gunfighters are looked upon more favorably than Bounty Hunters, Gunslingers, or even mercenaries. They are often hired by towns, ranchers, wealthy business owners and lawmen as bodyguards, bouncers, town (or business) defenders, militia leaders and sheriffs deputies. Some Gunfighters even become sheriffs or champions/defenders of a particular community. However, most are adventurers always on the prowl in search of action, challenge and profit using their wits and their guns. Many are addicted to excitement and travel. They enjoy new experiences and the thrill of adventure and combat. Unlike Bounty Hunters, most Gunfighters are much more discriminating about their employers and the terms of their employment. Many will not step beyond their own code of ethics, even when faced with death, and even defy or turn against an evil or dishonorable employer.

### Special Gunfighter O.C.C. Abilities & Bonuses

**1. Weapons Master & Bonuses:** Can pick up, figure out, and use most types of handguns and rifles as well as rail guns, rocket launchers, and light artillery, whether they fire projectiles or energy.

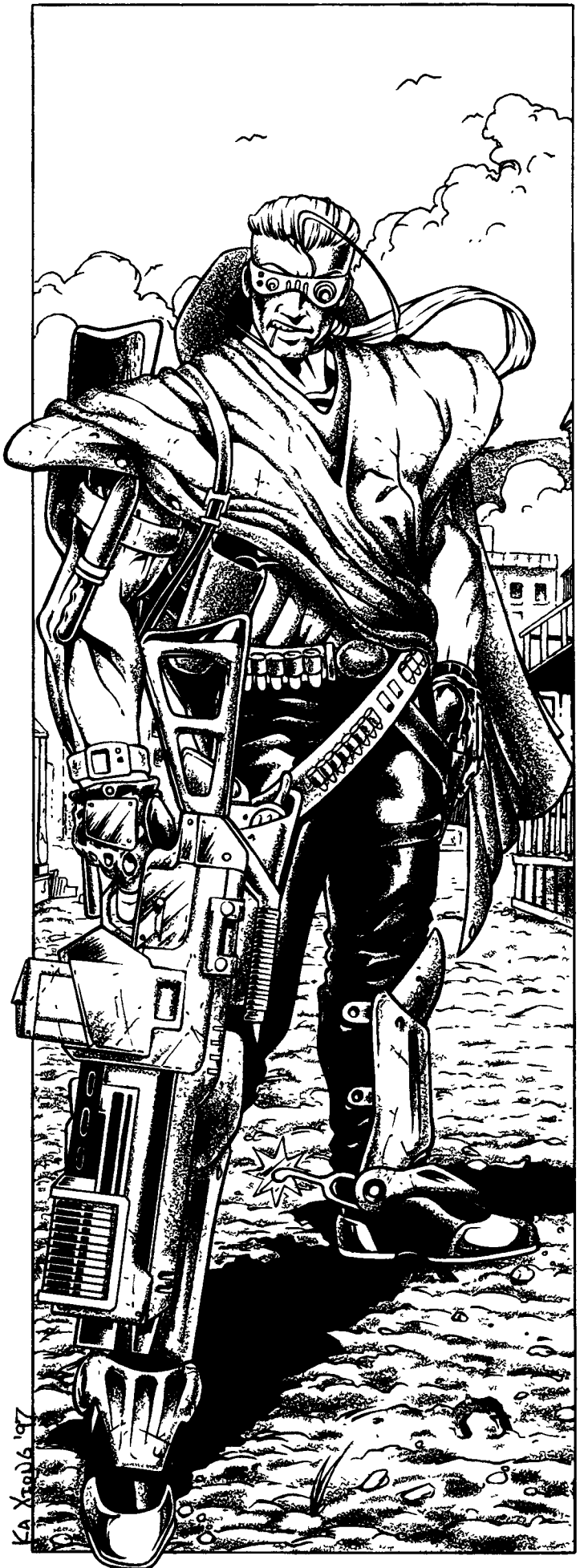

+1 extra attack per melee round when using any type of gun, from old style revolvers or bolt-action rifles to energy pistols, energy rifles and rail guns.

+3 to disarm on a "called" shot (the intent to disarm must be announced).

+1 to save vs horror factor at levels 1, 3, 5, 7, 9, and 12.

**2. Weapon Repairs:** A **Gunfighter** can take apart, clean and put together his favorite types of weapons blindfolded. He can also clear jams, make repairs to weapons, pack his own bullets (a.k.a. "load shells") or make/modify his own special ammunition, jury-rig an **E-Clip recharger** from a vehicle, generator or robot, and similar. **Base skill:** Same as the (Field) Armorer skill. Many also know demolitions and how to make traps (Military Skills)

**3. Quick-Draw Initiative: Handguns & Rifles (special):** This is really a special P.P. bonus exclusive to the Gunfighter O.C.C.: +1 to initiative for every two P.P. points above 16 (maximum P.P. 30; for a bonus of +7). This means a Gunfighter with a P.P. of 24 is +4 on initiative (plus any other initiative bonuses from skills or magic). Remember, the winner of the initiative roll shoots first. This skill combined with W.P. **Sharpshooting**, makes for a deadly combination. **Note:** The full bonus applies only to the use of handguns (i.e. Derringers, revolvers and pistols) and rifles (energy and conventional types). Reduce by half when using shotguns, archery, knife throwing, laser rods, or magic rods and staffs that **firebolts** of energy. Not applicable to the use of rail guns, artillery, explosives, hand grenades, power armor, or weapons built into vehicles. **G.M. Note:** A P.P. above 24 should be extremely uncommon, and 25-28 extremely rare; 29 and 30 virtually unheard of.

**4. Paired Weapons: Revolver & Pistol (special):** The Gunfighter and Gunslinger can draw and shoot two handguns (or throw two knives) simultaneously at the same target, inflicting full damage from both weapons, but counts as one melee attack!

In the alternative, the two-gun attack can be divided between two *different* targets visible to the shooter and within his range of peripheral vision. The divided attack counts as one simultaneous melee action against two different foes. The quick-draw initiative bonus still applies, but the shooter must roll two separate times to hit each target (roll to strike for each) and the bonuses to strike each is reduced by half.

**Note:** Parrying is not possible when two handguns are being used as paired weapons, but the character can dodge (which uses up one of his attacks) and counter by shooting.

### **5. W.P. Sharpshooting Specialties (3):**

Sharpshooting Revolver;

Sharpshooting Energy Pistol;

Sharpshooting Energy Rifle;

A combination of special expertise and trick shooting with a particular type of weapon. Includes +1 melee attack when using that specific weapon for the entire melee round, shooting bonuses, and trick shooting, which includes:

1. Can fire a traditional two-handed weapon, like a rifle, one handed without penalty (normally the shooter loses all strike bonuses).

2. Can shoot over his shoulder by holding up a mirror and using the reflection to aim; no penalties, keep full bonuses to strike.

3. Accurately shoot while riding a horse or a moving vehicle (normally a wild shot), but strike bonuses are half and a "called" shot is impossible.

4. Shoot accurately while standing on head or hanging upside down; all bonuses applicable at full.

5. Dodge, roll or somersault and come up shooting (normally a wild shot), no bonuses or penalties to strike; straight roll of the dice.

6. Ricochet shot! The shooter can bounce bullets, arrows, slings, and other fired *projectiles* (depending on the specific W.P.) off of one surface and angle the shot in such a way that the projectile **ricochets/bounces** off and hits a different/second target! Inflicts only one point of damage to the first surface and full damage to the second. Reduce bonuses to strike by half.

This can also be done with laser weapons but the ricocheting surface must be mirrored or highly polished. Glitter Boys are excellent reflective surfaces for performing a ricochet laser shot. Particle beams, ion blasters, rail guns, mini-missiles and other types of weapons *cannot* be used.

**Note:** See the W.P. Sharpshooting Specialty skill description for full details.

**6. Reputation & Horror Factor:** The occupation comes with a certain stigma and creates an element of fear, particularly among ordinary citizens (+1 to Horror Factor). This aura of fear and violence gives the known Gunfighter a Horror Factor, however, unlike the Gunslinger, this H.F. of 8 doesn't appear until the gunman reaches 6th level. Add +1 to the H.F. at levels 7, 8, 9, 11, 13, and 15. Otherwise the same as the *Gunslinger* ability.

## **Gunfighter O.C.C. & NPC Villain**

**Also known as Gunman, Vigilante, Pistolero and Bravo.**

**Player Character Note:** Like the Bandit O.C.C., the Gunfighter, whether a lawman, mercenary or outlaw, is likely to have (or will build) a reputation and earn his share of enemies. Some communities respect and welcome these professional fighters and honorable guns for hire, while others fear and distrust them (some consider them only a notch above **Gunslingers**, who are lower and more dangerous than the rattlesnake). A Gunfighter is usually pretty obvious by the number of weapons he or she is packing, and how he/she handles and carries himself.

**Alignments:** The typical assassin or unscrupulous gun for hire is anarchist or evil. Those who are honorable and live by The Code may be any alignment, including *good* or *selfish*.

**O.C.C. Requirements:** I.Q. 9, M.E. 10, P.P. 12 or higher.

**O.C.C. Skills:**

Speaks American and Spanish at 95% efficiency.

Land Navigation (+10%)

Detect Ambush (+15%)

Detect Concealment (+10%)

Find Contraband (+12%)

Recognize weapon quality (+20%)

Basic Electronics (10%)

Armorer (+20%)

Sniper

W.P. Revolver

W.P. Energy Pistol

W.P. Energy Rifle

W.P. Two Modern Weapons of choice.  
 W.P. One Ancient Weapon of choice.  
 Piloting Skill: One of choice (+10%)  
 Horsemanship: General  
 Hand to Hand: Expert  
 Hand to hand: expert can be changed to hand to hand: martial arts or assassin for the cost of one O.C.C. Related skill or Commando (see *Rifts® Coalition War Campaign*) for two skills.  
 Horsemanship: General can be changed to Cowboy for the cost of one O.C.C. Related skill.  
 Also see **Sharpshooting Specialties**, above.

**O.C.C. Related Skills:** At first level the character can select four "other" skills, plus one additional skill at levels 2, 4, 6, 8, 10 and 12. All new skills start at level one proficiency.

Communications: Any (+5%)  
 Cowboy: None  
 Domestic: Any  
 Electrical: Any (+5%)  
 Espionage: Any (+5%)  
 Mechanical: Any (+10%)  
 Medical: First Aid or Paramedic only.  
 Military: Any (+10%; +15% to trap and demolitions skills).  
 Physical: Any, except acrobatics.  
 Pilot: Any (+5%)  
 Pilot Related: Any  
 Rogue: Any (+8% to streetwise only)  
 Science: Any  
 Technical: Any (+10%).  
 W.P.: Any  
 Wilderness: Any

**Secondary Skills:** The character gets two secondary skills from the list above, excluding those marked "None," at levels 1, 3, 5, 7, 9, and 11. These are additional areas of knowledge that do not get the advantage of the bonus listed in parentheses. All secondary skills start at the base skill level.

**Standard Equipment:** M.D.C. body armor of choice (**Bandito Arms** and Northern Gun are most popular), tinted goggles or sunglasses, cowboy hat, set of riding clothes, set of fancy town clothes, flashlight, binoculars, laser **distancer**, pocket language translator, pocket magnifying glass, multi-optics band, portable tool kit, cigarette lighter, pocket mirror, small silver cross on a chain, a hand-size wooden cross, 2-4 pairs of handcuffs, a six foot (1.8 m) length of M.D.C. chain (18 M.D.C.) with a heavy-duty lock (5 M.D.C.), 100 ft (30.5 m) of lightweight rope, survival knife or hatchet, utility belt, knapsack, backpack or saddlebags, air filter, and two canteens.

Starts with a fair to good quality horse *or* a battered looking Northern Gun hovercycle (see **Rifts® Lone Star**; reduce the usual M.D.C. by 3D4%).

Weapons include one **Vibro-Blade** or Neuro-Mace, a conventional six-shooter (plus 60-144 silver bullets), energy pistol or **Techno-Wizard** pistol of choice, energy rifle of choice with telescopic scope and **thermo-imaging**, one additional weapon of choice, 1D4+3 additional **E-clips/ammo** clips for each of the weapons, two smoke grenades and 1D4+2 flares. If demolitions is known to the character, he or she can have 1D4+4 hand grenades.

**Additional Equipment:** Hand grenades, flares, magic items, special weapons, souped-up vehicles, etc., must be acquired later.

**Money:** Starts with 4D6×100 credits worth of tradeable goods and 1D6×1000 in universal credits.

**Cybernetics:** None to start. Most Gunfighters acquire a few basic implants like augmented hearing and/or optics, but tend to avoid more extreme bionic enhancement, except for medical purposes.

## Gunslinger O.C.C.

A popular saying in the New West is that "the only thing meaner, deadlier and lower than a rattlesnake is a Gunslinger." That should give players a pretty good idea of how most people view members of this occupation.

Gunslingers are generally feared by most people and regarded as paid assassins and murdering brigands. The Gunslinger's reputation has not been enhanced by those mean-spirited bastards who kill at the slightest provocation, behave like arrogant bullies, and hurt or kill innocent people without any apparent remorse. Indeed, the worst Gunslingers *are* paid assassins —**villains** who enjoy killing and who have little or no regard for life. Many of these vermin like the sense of power killing gives them, and enjoy knowing people respect them out of fear. Others are just monsters who use their guns and **ruthlessness** to take what they want, killing any fool who gets in their way. Still others have grown hardened and cold to the suffering of others and simply see the world as a dark, cruel place where the strong, smart and those not afraid to shed blood survive and prosper. Others dislike or hate their career but don't see any (acceptable) alternative.

That having been said, not all Gunslingers are evil. Some are lawmen, heroes, local champions, manhunters, vigilantes, or renowned adventurers who deal out hard justice through fast thinking and even faster guns. In fact, even many of those who turn into vile or wicked killers start out as bold, brash teenagers who believe themselves to be invulnerable, quicker and smarter than anyone else. These youths, males and females, often select the occupation for one of two reasons: It seems glamorous/powerful/important, or they seek to avenge the death of a loved one(s). In this regard, they are no different than the Gunfighter with dreams of becoming a famous hero or lawman who roots out evil and shoots it dead! Sadly, 75% percent of these overconfident and brazen fools are killed or crippled in their first gunfight (career over before it ever really began). Showdowns against seasoned Gunslingers (5th level and higher) almost always end in the fatal shooting of the young gun. Another 20% are killed within their first year of adventuring (seldom exceeding 3rd level experience). Roughly 5% survive to build something that might be considered a career, and half of them will die violently within seven years. Consequently, "real" Gunslingers who have survived into their 30's or who have earned reputations throughout the west (as opposed to just one localized region), are notorious, deadly, cunning and experienced (7th level and higher); they are also in the minority. Less than 100 truly famous and experienced Gunslingers exist (7th-15th level), with, perhaps, another 1,200 not so famous, but equally dangerous veteran 'Slingsers operating throughout North America (add an-

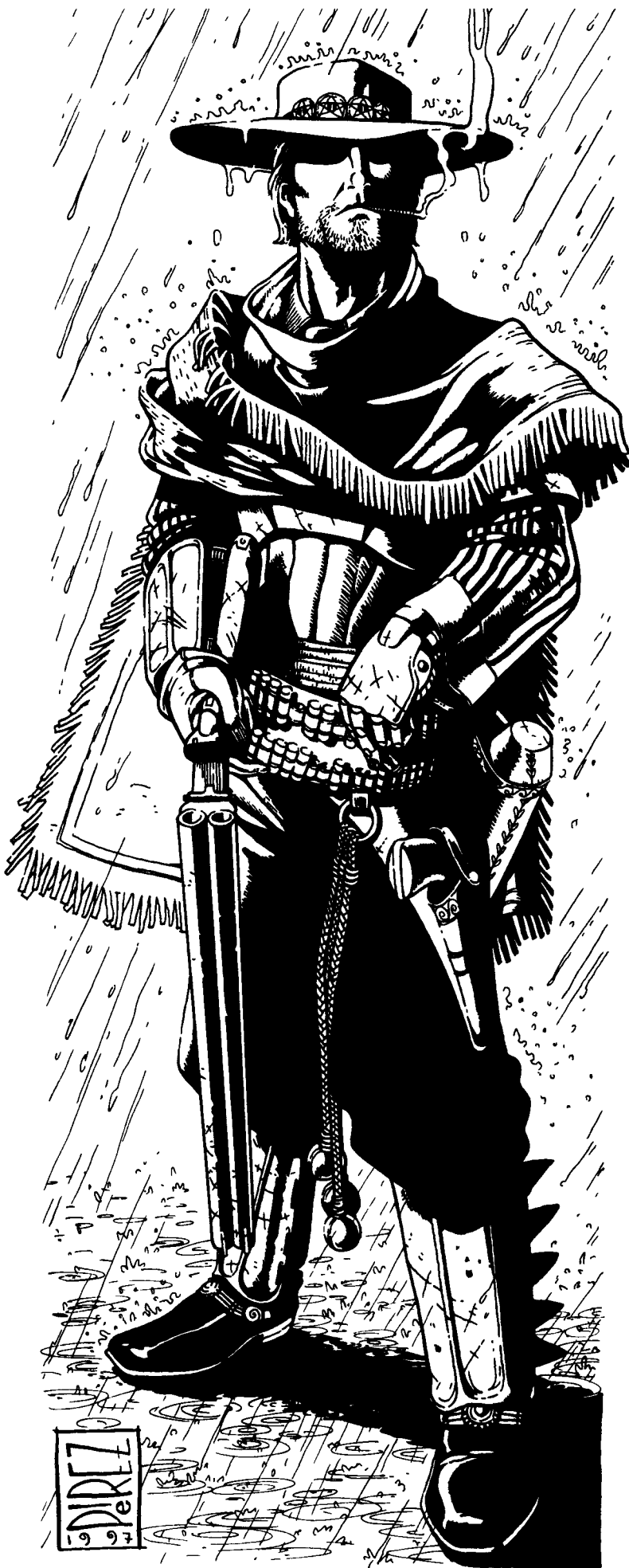

other few hundred in Mexico). Of course, this doesn't include the thousands of young turks (1-4th level) who call themselves Gunslingers and expect to live long enough to become famous throughout the land.

The leading cause of death among these Assassins is still euphemistically called, "lead poisoning," e.g. death by gunfire. A horrifying 97.5% will die at "the business end of a gun." A full third (33%) will be gunned down in an *ambush (usually outnumbered by their opponents), bushwhacked, shot in the back, or killed in their sleep!* The most likely assailants will be another Gunslinger (a rival, an enemy, or young one looking to build his own reputation), Bounty Hunters, Gunfighters, Bandits, adventurers, and even posses, lawmen, or an ordinary vengeful citizen(s). The motivation for the killing can be any number of things: failure to pay a debt, cheating at cards, rivalry, revenge, justice, **reward/bounty**, business, or to build a reputation as the man who killed so and so. The reason for shooting the Gunslinger down in cold blood is typically because the killer or killers are afraid, or know, they couldn't possibly win in a fair fight — and, after all, who mourns for a killer, or concerns himself with how he comes to his end — "it ain't no worse than killin' a mad dog."

Another third are killed in showdowns — quick-draw duels. Many Gunslingers, Gunfighters, Juicers, Crazies and young punks look to make themselves a quick reputation by killing an even regionally famous Gunslinger — or simply have a crazy need to prove who is the best, fastest, etc. The rest are killed in some other form of combat, whether the Gunslinger is (surprisingly) defending a town or innocent people, robbing a bank, or fighting monsters, bandits, mercenaries, the law, etc. It is the rare professional Gunslinger who lives past 40 and, rarer still, the one who manages to retire or die of natural causes (2.5%).

An expert in handguns, **sharpshooting** and the fast-draw, a Gunslinger is effectively a mercenary for hire who specializes in protection, enforcement (of the law or criminal operations through intimidation and killing) and murder. As one Gunslinger said, "Let's jist say, I'll be eliminatin' yer problem permanent like. You understand my meanin'." They are often hired by criminal kingpins, wealthy ranchers and businessmen, and bandit leaders as a hit man/assassin or enforcer. A Gunslinger's *two* greatest weapons are his revolvers and reputation. Thus, the Shootist uses his reputation (real or exaggerated) as much as his guns to frighten away potential opponents, or put an end to a conflict (sometimes his very presence, or a warning, will end a brawl, argument, or threat). He also uses intimidation to enforce his or his employer's will or desires, and to get what he wants. Of course, he isn't afraid to use his guns either.

### **Special Gunslinger O.C.C. Abilities & Bonuses**

**1. Expertise with all handguns:** The Gunslinger has a W.P. in the use of all types of revolvers and pistols, whether they fire bullets or energy bolts.

It is important to note that the Gunslinger is a master of close-range combat with small arms, which makes him perfect for approaching and gunning people down in crowded streets and in confined areas like a saloon. This form of "city" combat gives this character an edge, because rifles and heavy weapons are often illegal and prohibited in most towns, cities, and places of business, while handguns are usually allowed or easily

concealed. Furthermore, rifles and heavy weapons are extremely obvious because of their size, which, in turn, causes a commotion among everybody who sees him with the weapon and warns the assassin's potential target and/or alerts the law of an impending **gunfight**. Handguns, on the other hand, can be easily concealed in the belt, behind the back, under one's **arm**, in an ankle holster or boot, up a sleeve (if a Derringer), under a hat, in a book, in a backpack or satchel, and so on.

**2. Quick-Draw Initiative: Revolvers and Pistols:** This is a special P.P. bonus exclusive to the Gunslinger O.C.C.: +1 to initiative for every P.P. point 18 and above (maximum P.P. 30; for a bonus of +13). This means a Gunslinger with a P.P. of 24 is +7 on initiative (plus any other initiative bonuses from skills or magic). Remember, the winner of the initiative roll shoots first. This skill combined with W.P. **Sharpshooting**, makes for a deadly combination. **Note:** The full bonus applies only to the use of handguns (i.e. Derringers, revolvers and pistols), reduce by half when using rifles (any kind), shotguns, archery, knife throwing, laser rods, or magic rods and staves (round odd numbers down). Not applicable to the use of rail guns, artillery, explosives, hand grenades, power armor, or weapons built into vehicles (no bonus). **G.M. Note:** A P.P. above 24 should be extremely uncommon, and 25-28 extremely rare; 29 and 30 virtually unheard of.

**3. Paired Weapons: Revolvers & Pistols (special):** The Gunslinger can draw and shoot two handguns (or throw two knives) simultaneously at the same target, inflicting full damage from both weapons, but counts as one melee attack!

In the alternative, the two-gun attack can be divided between two *different* targets visible to the shooter, and within his range of peripheral vision. The divided attack counts as one simultaneous melee action directed at two different foes. The quick-draw initiative bonus still applies, but the shooter must roll two separate times to hit each target (roll to strike for each), and the bonus to strike each is reduced by half because the attack is divided.

**Note:** Parrying is not possible when two handguns are being used as paired weapons, but the character can dodge (which uses up one of his attacks) and counter by shooting.

**4. W.P. Sharpshooting Specialty:** Sharpshooting Revolver and Sharpshooting Energy Pistol.

Sharpshooting is a combination of special expertise and trick shooting with a particular type of weapon. Includes +1 melee attack when using that specific weapon for the entire melee round, shooting bonuses, and trick shooting, which includes:

1. Can fire a traditional two-handed weapon, like a rifle, one handed without penalty (normally the shooter loses all strike bonuses).
2. Can shoot over his shoulder by holding up a mirror and using the reflection to aim; no penalties, keep full bonuses to strike.
3. Accurately shoot while riding a horse or a moving vehicle (normally a wild shot), but strike bonuses are half and a "called" shot is impossible.
4. Shoot accurately while standing on head or hanging upside down; all bonuses applicable at full.
5. Dodge, roll or somersault and come up shooting (normally a wild shot), no bonuses or penalties to strike; straight roll of the dice.

6. Ricochet shot! The shooter can bounce bullets, arrows, slings, and other fired *projectiles* (depending on the specific W.P.) off of one surface and angle the shot in such a way that the projectile **ricochets/bounces** off and hits a different/second target! Inflicts only one point of damage to the first surface and full damage to the second. Reduce bonuses to strike by half.

This can also be done with laser weapons but the ricocheting surface must be mirrored or highly polished. Glitter Boys are excellent reflective surfaces for performing a ricochet laser shot. Particle beams, ion blasters, rail guns, mini-missiles and other types of weapons *cannot* be used.

**Note:** See the W.P. Sharpshooting Specialty skill description for full details.

**5. Reputation & Horror Factor:** The mere occupation alone comes with a certain stigma and creates an element of fear, particularly among ordinary citizens (+2 to the Gunslinger's Horror Factor when dealing with common folk). This aura of fear and death gives the Gunslinger a Horror Factor of 8 +1 at levels 2, 4, 5, 6, 8, 10, 11, 13, and 15. Opponents must roll to save vs horror factor whenever the Gunslinger makes a serious threat (stop or else ...) and again if and when he first draws his weapon on a character (How does one react. Beg, dodge, try to shoot first? The latter is usually a bad mistake). Likewise, those who attack a Gunslinger must roll to save vs Horror Factor whenever facing the Shootist in a one-on-one showdown, duel, or shootout, and whenever an opponent makes his first move to attack the Gunslinger, even if the 'Slinger isn't aware the character plans to attack.

A failed roll means the Gunslinger's opponent momentarily hesitates or freezes or fumbles with his weapon (slow-draw). Obviously, losing initiative and one melee attack against a Gunslinger, even for a melee round, is deadly, unless the Shootist retaliates by shooting to disarm or wound (or happens to roll poorly and misses).

This reputation is a two-edged sword. While it may provide an intimidation factor, power, and an edge in combat, on the downside, famous and/or notorious Gunslingers are likely to be noticed whether they want to be or not, usually by other men at arms, outlaws, bounty hunters and lawmen, and sometimes by ordinary citizens. The most famous are modern day "superstars" like Michael Jordan or Michael Jackson, and can not go anywhere without being recognized. This can become a deadly liability, and certainly makes anonymity impossible for those travelling in their company.

**6. +1 Melee Attack** at levels 5, 10, and 15 when using any type of revolver or pistol **only!**

**7. Other Bonuses:** Add 2D6+6 to S.D.C., +2 to pull punch, +2 to disarm on a "called" shot, and +1 to save vs Horror Factor at levels 1, 3, 4, 5, 7, 8, 9, 11, 12, 13, and 15. Most are also strong-willed and mentally driven, so they are +2 to save vs possession and mind control (including psionics, magic and drugs).

## The Gunslinger O.C.C. & NPC Villain

**Also known as 'Slinger (a common slang in the New West, especially for those of a good or unprincipled alignment), Shootist, Duelist, Hired Gun, Killer and Assassin.**

**Alignments:** Any, but often anarchist or evil. Those who are honorable and live by The Code, may be any alignment, including *good*, *unprincipled* or *aberrant*.

**Attribute Requirements:** I.Q. 8, M.E. 14, P.P. 17 or higher; anything less is a "dead man walking" when pitted against Gunslingers with a P.P. of 20 or higher. Lots of thugs and wannabes call themselves Gunslingers, but few have what it takes to really become one. A high I.Q., M.A. and P.S. may also be helpful, but are not required.

**Racial Restrictions:** Dragons and other creatures of magic, master psionics, and supernatural beings (demons, etc.) *cannot* select this specialized O.C.C. nor can partial or full conversion cyborgs, androids, and robots. Furthermore, many optional **D-bee** R.C.C.s will preclude them from selecting this O.C.C.

**Player Character Note:** Like the Bandit O.C.C., the Gunslinger, whether a lawman, mercenary or outlaw, is likely to have (or will build) a reputation and earn his share of enemies. Some communities respect and welcome 'Slingers with a reputation for being lawmen and/or champions of the downtrodden, but most fear, distrust, and hate these paid killers and bullies. A Gunslinger is usually pretty obvious by his *pair* (sometimes more) of handguns, fancy clothing or ornate body armor, and by how he or she carries himself. In addition, since most use their reputation (and the reputation that the Gunslinger occupation brings) as a weapon, they don't usually try to hide who or what they are. Furthermore, characters travelling in a Gunslinger's company may be deemed equally undesirable and untrustworthy.

#### O.C.C. Skills:

Speaks American and one language of choice at 96% efficiency.

Find Contraband (+12%)

Basic Electronics (10%)

Piloting Skill: One of choice (+10%) or Horsemanship: General

Interrogation (+15%)

Streetwise (+12%)

Palming (+10%)

Prowl (+10%)

Recognize weapon quality (+30%)

W.P. Revolvers (includes Derringers)

W.P. Automatic Pistols

W.P. Energy Pistols

W.P. two of choice.

Hand to Hand: Expert

Hand to hand: expert can be changed to hand to hand: martial arts or assassin for the cost of one O.C.C. Related skill, or to Commando (see *Rifts® Coalition War Campaign*) for two skills.

Horsemanship: General can be changed to Cowboy for the cost of one O.C.C. Related skill.

Also see Sharpshooter Specialty skills, above.

**O.C.C. Related Skills:** At first level the character can select six "other" skills, plus one additional skill at levels 2, 4, 6, 8, 10 and 12. All new skills start at level one proficiency.

Communications: Any (+5%)

Cowboy: None

Domestic: Any

Electrical :None

Espionage: Any (+10%)

Mechanical: Basic Mechanics only

Medical: First Aid or Paramedic only

Military: None

Physical: Any, except acrobatics

Pilot: Any

Pilot Related: Any

Rogue: Any (+10%)

Science: Math only (+5%)

Technical: Any (+10%)

W.P.: Any

Wilderness: Wilderness Survival, Track Animals and Hunting only.

**Secondary Skills:** The character gets two secondary skills from the list above, excluding those marked "None," at levels 1, 3, 6, 9, and 11. These are additional areas of knowledge that do not get the advantage of the bonus listed in parentheses. All secondary skills start at the base skill level.

**Standard Equipment:** M.D.C. body armor of choice (Bandito Arms and Northern Gun are most popular), tinted goggles or sunglasses, quality cowboy hat, set of riding clothes, a rich quality suit (fancy and expensive) for town — Gunslingers tend to be very stylish dressers, flashlight, binoculars, multi-optics band, laser distancer, pocket language translator, gun cleaning kit, cigarette lighter, pocket mirror, small silver cross, 2 pairs of handcuffs, 50 ft (15.2 m) of lightweight rope, survival knife, two-holster gun belt, utility belt, knapsack, backpack or saddlebag, air filter, and two canteens.

Starts with a robot horse *or* a brand new hovercycle or landrover of choice (see *Rifts® Lone Star* for hovercycles).

Weapons include one laser scalpel, a Derringer, a pair of fancy silver plated revolvers (plus 60-96 silver bullets), a pair of automatic pistols (often the same caliber as the revolvers), a pair of energy pistols, one additional weapon of choice (including **TW** revolver), 1D4+4 additional E-clips for each weapon that needs one, and 288 rounds of ammunition for each of the weapons.

**Additional Equipment:** Hand grenades, flares, magic items, special weapons, souped-up vehicles, etc., must be acquired later.

**Money:** Starts with 3D6×100 in universal credits; the rest has been spent on fancy clothes, weapons and vehicles.

**Cybernetics:** None to start. Most Gunslingers avoid them except for augmented hearing and/or optics and for medical reasons; then bio-systems will be preferred.





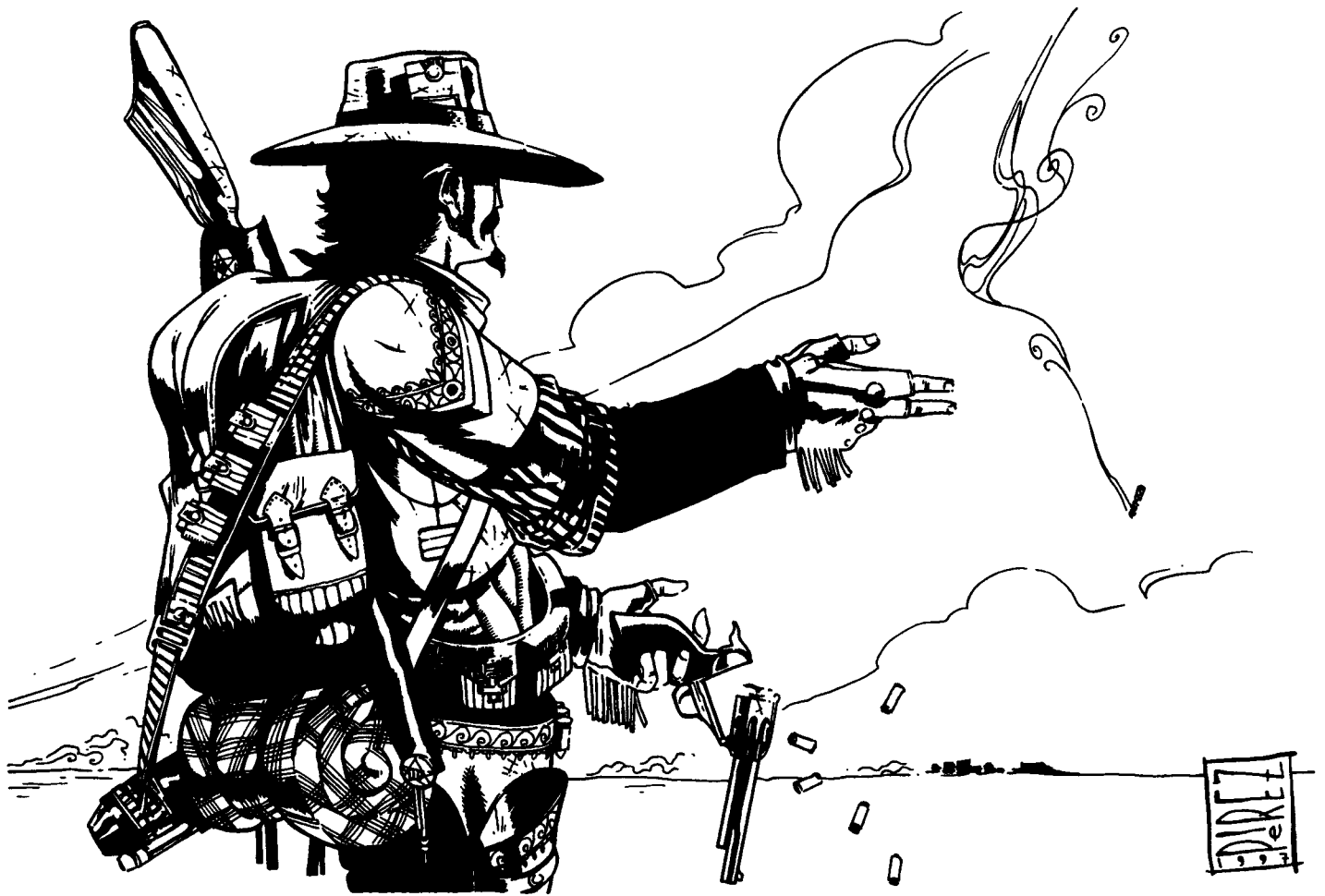

## Justice Ranger O.C.C.

Justice Rangers are similar to the Texas Rangers of old. They roam the land righting wrongs and bringing justice to an untamed frontier. Like the **Cyber-Knights** who also wander the **Americas**, Justice Rangers tend to travel alone, in pairs, or in small groups with other lawmen, **gunfighters** and adventurers. They lead a heroic existence fighting to protect the innocent from those who enslave, abuse, plunder and kill, or to avenge their deaths. They bring hope to the weak, frightened and those who live in isolation in the dangerous wilderness.

Justice Rangers are almost always of good (or aberrant) alignments, live by The Code, and rarely turn their backs on those in need. They are restless souls who seem to thrive on fighting evil, and bringing law, order and justice to a lawless land. However, it is their commitment to "avenge" that makes them different from many other lawmen.

Unlike most sheriffs and lawmen, the Justice Rangers openly act as lawman, **manhunter**, judge, jury and executioner. They often lead posses and stir up townspeople for lynchings and vigilante actions. Justice Rangers seem to have a particular vendetta against supernatural monsters and frequently target Xiticix, **Brodkil**, demons and dragons. They also tend to treat inhuman looking **D-bees** much more harshly than humans and human-looking **D-bees** and mutants, particularly the **Simvan Monster Riders**.

Some people have suggested that they are descended from the Canadian Mounties, because they are most active in *the Canadian Southwest, American Northwest, Montana, Idaho, the Da-*

*kotas, and Minnesota*, and because they have the creed, "Justice Rangers always get their man, come hell or high water." However, it is more likely that they have adopted part of the Mounties' old saying as their own, as well as the ethics, procedures and methods of various law enforcement agencies. Their reputation for relentless pursuit and harsh justice have made them something of a paradox, representing death and vengeance as much as peace and justice. It is said that any man or monster who becomes a target of the Justice Rangers is better off killing himself than to suffer the "vengeance of the innocent." When they catch their quarry, some Justice Rangers are completely merciless and vindictive, sometimes engaging in public humiliation and torture before finally punishing or executing the outlaw. This public display of terror and punishment has earned some the nickname, "Wrath of God." On the other hand, their reputation for being tough, relentless and without mercy often works in their favor by intimidating petty crooks, informers and even ordinary citizens to volunteer information helpful in their investigations. However, the majority of Justice Rangers are well intentioned, hardworking, and courageous lawmen dedicated to protecting and avenging the innocent and downtrodden. Generally speaking, people seem to either love them or hate them.

The exact number of Justice Rangers varies depending on how much they have suffered in their campaign for Justice and battles against the supernatural. One campaign against the monstrous forces at Calgary, 50 years ago, nearly decimated the Justice Rangers, reducing their numbers to less than 200. Likewise, ongoing struggles against the Xiticix and other inhuman invaders in the north takes its toll on the Justice Rangers. An esti-

mated 1000-2000 are believed to exist, and although they are most numerous in the north, they can be found throughout the west and as far south as New Mexico and Lone Star. Average level of experience is 2-6th level; 50% are human, 25% Psi-Stalkers, 5% cyborgs, 2% mutant animals, and the rest are various other races, mostly human-like in appearance. The average Justice Ranger is male, between the ages of 20 and 50. All true Rangers will have been taught their ways by another Justice Ranger. Many other Men at Arms are counted among their ranks, but they are generally considered deputies or junior Rangers, allies and sympathizers, rather than true Rangers. This passing on of Ranger tradition has kept the Justice Rangers alive as an institution, or brotherhood, for more than 70 years.

## Special Justice Ranger O.C.C. Abilities & Bonuses

**1. Weapon Mastery & Bonuses:** Can pick up, figure out, and use most types of energy handguns and rifles.

+2 to disarm on a "called" shot (the intent to disarm must be announced).

+3 to pull punch.

+1 to save vs horror factor at levels 2, 3, 5, 7, 9, 11, 13 and 15.

+2D6+10 to S.D.C.

**2. Quick-Draw Initiative: Handguns or Rifles (special; pick one):** This is a special P.P. bonus exclusive to the professional Lawman, similar to the **Gunfighter**: +1 to initiative for every two P.P. points above 18 (maximum P.P. 30; for a max. bonus of +6). This means a lawman with a P.P. of 24 is +3 on initiative (plus any other initiative bonuses from skills or magic) whenever he uses that particular type of weapon. Remember, the winner of the initiative roll shoots first. This skill combined with W.P. **Sharpshooting**, makes for a deadly combination. **Note:** The full bonus applies only to the use of handguns (i.e. Derringers, revolvers and pistols) or rifles (energy and conventional); the player must pick one. This bonus does not apply to any other type of weapon. **G.M. Note:** A P.P. above 24 should be extremely uncommon, and 25-28 extremely rare; 29 and 30 virtually unheard of.

Note: Parrying is not possible when two handguns are being used as paired weapons, but the character can dodge (which uses up one of his attacks) and counter by shooting.

**3. Reputation & Horror Factor:** The occupation comes with a certain element of power and danger, particularly among ordinary citizens, lowlifes and two-bit bandits (add +2 to the Horror Factor of the Justice Ranger when dealing with these people). This aura of power, justice and violence gives the known Justice Ranger a Horror Factor, however, unlike the **Gun-slinger**, this H.F. of 8 doesn't appear until the character reaches 5th level. Add +1 to the H.F. at levels 6, 7, 8, 9, 11, 13, and 15. Otherwise the same as the *Gunfighter* ability.

## Justice Ranger O.C.C. & NPC

**Also known as the North Rangers, Demon Slayers and the Wrath of God.**

**Player Character Note:** Justice Rangers are generally considered the ruthless and relentless archenemies of notorious outlaws, Highwaymen and evil supernatural monsters. This makes them among the most feared and hated lawmen in the west. Most law abiding townsfolk and other lawmen respect and welcome the Rangers, although some may question their methods and fanatical quest to destroy evil.

**Alignments:** Any, but typically good, unprincipled or aberrant. Most are honorable, courageous, resourceful and live by The Code, but 20% are so extreme, mean and vicious that they aren't much better than the criminals they hunt, 5% are downright evil.

**O.C.C. Requirements:** I.Q. 9, M.E. 12, P.E. 12 or higher.

### O.C.C. Skills:

Speak native language 98%

Speak one other language of choice (+20%)

Basic Math (+20%)

Radio: Basic (+10%)

Track **Humanoids** (+15%)

Track Animals (+10%)

Land Navigation (+20%)

Intelligence (+15%)

Detect Ambush (+10%)

Wilderness Survival (+15%)

Pilot Hovercycles, or Hover Vehicles, or Horsemanship: Cowboy

Climbing

Running

W.P. Energy Pistol

W.P. Energy Rifle

W.P. One of Choice

Hand to Hand: Expert

Hand to Hand: Expert can be changed to Hand to Hand: Martial Arts at the cost of one "other" skill (or assassin if an evil alignment).

**O.C.C. Related Skills:** At first level the character can select six "other" skills, plus one additional skill at levels 2, 4, 6, 8, 10 and 12. All new skills start at level one proficiency.

Communications: Any (+10%)

Cowboy: Any

Domestic: Any

Electrical: None

Espionage: Any (+10%)

Mechanical: Basic and Automotive only (+5%)

Medical: Paramedic, Brewing and Holistic Medicine only.

Military: Any, except Parachuting.

Physical: Any

Pilot: Any (+10%)

Pilot Related: Any (+5%)

Rogue: Streetwise and **Cardsharp** only (+4%)

Science: Math only (+10%)

Technical: Any (+10%)

W.P.: Any

Wilderness: Any (+10%)

**Secondary Skills:** The character also gets to select four secondary skills from the previous list at level one, plus one additional at levels 2, 4, 8, and 12. These are additional areas of knowledge that do not get the advantage of the bonus listed in parentheses. All secondary skills start at the base skill level. Also, skills are limited (any, only, none) as previously indicated in the list.

**Standard Equipment:** A suit of personalized mega-damage body armor (any kind, including Coalition armor), an extra suit of light M.D. armor, a set of traveling clothes, a set of dress clothing, a gas mask and air filter, tinted goggles or sunglasses, and an NG-S2 Basic Survival Pack, **IRMSS** robot medical kit, infrared distancing binoculars, portable language translator, 2D4 sets of handcuffs or manacles (80 S.D.C.), 2

M.D.C. handcuffs (15 M.D.C. each), 50 feet (15.2 m) of strong cord/rope, utility belt, backpack, knapsack, 1D4 small sacks, two canteens and a Justice Ranger badge.

Weapons include a **Vibro-Blade**, a conventional six-shooter (plus 60 silver bullets), one energy handgun and energy rifle of choice, one additional weapon of choice, and passive, telescopic nightsight scope for the rifle, and passive nightvision goggles for general use while manhunting at night.

Starts with a choice of vehicles: Hovercycle, motorcycle, land rover, or a good quality horse.

**Special Equipment:** Pick one (must have appropriate skill)

1. **Magic Weapon:** **Techno-Wizard** weapon of choice, gun, flaming sword, etc. (the G.M. may limit the availability of certain items), plus 1D4×1000extra credits.

2. **Power Armor Suit:** A Titan, T-C20 Terrain Hopper, Predator, Triax T-31 Super Trooper, or other similar suit of light to medium power armor. Automatically gets the *basic* pilot robots and Power Armor skill.

3. **Magic Armor:** One Techno-Wizard or other type of magic armor and one magic weapon (keep the items reasonable, not super-powerful). Or one major bio-wizard parasite, plus 1D4 microbes and a minor magic weapon (see **Rifts® Atlantis** for bio-wizardry).

4. **Special Vehicle:** A souped-up motorcycle, land rover, hovercycle, or hover vehicle with double the usual **M.D.C.**, two M.D. weapons mounted on it, radar and long-range radio. Or a robot horse may be selected.

**Money:** The character starts off with 3D6×100 in credits, and has tradeable item(s) that will garner another 1D4×1000credits.

**Cybernetics:** None to start, but can be acquired later.

## Psi-Slinger P.C.C.

By Kornmann & Siembieda

The Psi-Slinger is a latent psychic with the ability of sixth sense and the ability to power his or her weapons with nothing more than **psychic energy!** These men and women are much like the typical Gunslinger but they tend to be much cockier and more flamboyant. **Psi-Slingers** generally stay to the cities and tend to participate in many of the contests involving firearms, such as the typical western showdown. With their sixth sense and other psionic powers, they are very good at what they do.

Many scientists believe the Psi-Slinger is a variation or mutation of the Burster. They are usually humans (80%) or **Psi-Slalkers** (20%) with the power to create and manipulate energy. Most speculate that the psychic somehow melds telekinesis and the manifestation of energy, but nobody knows for certain. **Psi-Slingers**, whatever they are, have only appeared on the scene in the last decade (the first recorded case was in April of 95 P.A.). These energy generating beings are less common than Bursters and about on par with Mind Melters, which suggests they are master psionics. For one reason or another, **Psi-Slingers** are most common in the New West. Perhaps they are mutants originating in the West, or perhaps they are drawn to the west because it is a place where they can best ply their expertise and powers. One popular rumor suggests they are the hit men and enforcers of the

mythical *Psyscape*, although most Psi-Slingers (99%) deny this and claim they don't know the location to this legendary refuge for psychics.

Except for their unique powers, Psi-Slingers are fundamentally *Gunslingers*, with the same profession, outlook and ethics. However, Psi-Slingers are generally considered superior.

### Psi-Slinger O.C.C. Special Abilities & Bonuses

Psi-Slingers have certain special abilities that can only be used by them. They are experts with firearms and usually specialize in one or more weapons.

1. **Energy Expulsion:** The Psi-Slinger can fire bolts of energy from his fingers or with the touch of a charged hand. Damage & I.S.P. Cost: 1D6 S.D.C. costs 1 I.S.P., 3D6 S.D.C. costs 2 I.S.P., 6D6 S.D.C. costs 3 I.S.P. and 1D4 M.D. costs 6 I.S.P. Range: Touch or 20 feet (6 m) +5 feet (1.5 m) per level of experience.

2. **Psychic Weapons:** These guns are reminiscent of Techno-Wizard guns that fire M.D. energy blasts rather than bullets. In this case, the Psi-Slinger can power or charge the projectiles in any S.D.C. weapon with destructive energy by linking with the weapon! The firearm effectively becomes an extension of the psychic gunslinger. Damage & I.S.P. Cost: This turns conventional ammunition into mega-damage rounds that inflict 1D6 M.D. each with the expenditure of 10 I.S.P.; the projectiles are surrounded by an aura of energy. Limitations: Affects all rounds in the weapon, up to 15 total; there are typically six rounds in a revolver, 8-15 in an automatic pistol, and 30 to 60 in the clip of a sub-machinegun or automatic rifle. Likewise, as many as three arrows can be charged and fired to do M.D.; knives, spears, sling rocks and similar thrown or hurled weapons *cannot* be turned into charged mega-damage weapons. A maximum of three guns can be linked to the Psi-Slinger at any one time. The charged projectiles can only be fired from a gun linked to the Psi-Slinger and cannot be charged and given to a different person — only the Psi-Slinger can use his weapons in such a way. Duration: The charged projectiles in linked guns on the psychic's person remain charged indefinitely, arrows must be used within one minute or they return to normal. Range: Same as the ordinary weapon. Note: The weapon can be loaded with any conventional ammunition for this ability to work, but must be reloaded when the initial payload is spent, and takes two melee actions to focus and charge each new payload held by the weapon (up to 15 rounds). The weapon firing these energy rounds is considered normal and ordinary in every way, for it is the Psi-Slinger creating the effect, not the gun; it is simply the psychic's focal point. In fact, magical, Techno-Wizard, Bio-Wizardry and psionic devices *cannot* be charged and used in this fashion.

Also note that the Psi-Slinger can telekinetically make any psychic weapon linked to them fly into their hands at the cost of one I.S.P., but is limited to a range of 10 feet (3 m) +1 foot (0.3 m) per level of experience.

3. **Energy Conversion:** Psi-Slingers can transform mega-damage energy beams and blasts directed at them into S.D.C./hit point blasts! Even the Psi-Slinger isn't sure how he does this. It could be his unique aura or some unconscious fear response that reaches out and alters the energy a micro-second before it hits him. This is an automatic reflex response beyond the Psi-Slinger's control. Only energy blasts that inflict 30 M.D. or more cannot be affected and will inflict half (M.D.) damage.



Mega-damage projectiles, mini-missiles, hand grenades, explosives, **Vibro-Blades**, psionic blasts and **psi-swords**, and magic weapons, wards, and spells do full damage. So do hit point/S.D.C. projectiles (arrows, bullets, thrown knife, etc.) and weapons like swords, knives, clubs, etc., all do full damage. However, S.D.C. energy attacks, including fire and electricity do half damage. Impervious to the effects of the Neuro-Mace. **Damage Conversion:** M.D. to S.D.C.; i.e. 24 M.D. is turned into 24 H.P./S.D.C. points of damage; an especially handy ability in showdowns and shootouts where one's opponent is armed with an M.D. energy weapon. I.S.P. Cost: None; an automatic and natural response. Note: This power cannot be used on energy weapons fired by the psionic to turn their damage into S.D.C., only on energy that will strike the psychic.

**4. Other Psionic Powers:** All Psi-Slingers possess the powers of sixth sense, mind block, mind bolt, psi-sword, and telekinesis (physical; not super), plus they can sense the amount of energy in an **E-Clip** (number of shots left) or battery (costs 1 I.S.P.). The player can select one additional psionic power per each level of experience (starting with level one) from any category except Super. I.S.P. is the M.E. attribute times two plus 10 per level of experience. Considered a master psionic. Note: The Psi-Slinger often uses his telekinetic power to hurl small objects at his opponents to distract or to inflict even more damage.

**5. Expertise with all handguns:** The Psi-Slinger has a W.P. in the use of all types of revolvers and pistols, whether they fire bullets or energy bolts. Basically the same as the Gunslinger.

**6. Quick-Draw Initiative: Revolvers and Pistols:** This is a P.P. bonus that is fundamentally the same as the Gunslinger, ex-

cept it applies only to weapons the Psi-Slinger is linked to (otherwise reduce by half when using just any gun): +1 to initiative for every P.P. point 18 and above (maximum P.P. 30; for a bonus of +13). This means a character with a P.P. of 24 is +7 on initiative (plus any other initiative bonuses from skills or magic). Remember, the winner of the initiative roll shoots first.

**7. Paired Weapons: Revolvers & Pistols (special):** The psionic Gunslinger can draw and shoot two handguns (or throw two knives) simultaneously at the same target, inflicting full damage from both weapons, but counts as one melee attack!

In the alternative, the two-gun attack can be divided between two *different* targets visible to the shooter, and within his range of peripheral vision. The divided attack counts as one simultaneous melee action directed at two different foes. The quick-draw initiative bonus still applies, but the shooter must roll two separate times to hit each target (roll to strike for each), and the bonus to strike each is reduced by half because the attack is divided.

**Note:** Parrying is not possible when two handguns are being used as paired weapons, but the character can dodge (which uses up one of his attacks) and counter by shooting.

**8. W.P. Sharpshooting Specialty:** The Psi-Slinger automatically gets **Sharpshooting** with revolvers and pistols (projectile types only) to which the character is psionically linked. Not applicable to ordinary handguns which are not psychically bonded to the character or energy pistols, meaning the Psi-Slinger *cannot* pick up just any revolver or energy pistol and use it with **sharpshooting** bonuses.

Sharpshooting is a combination of special expertise and trick shooting with a particular type of weapon. Includes +1 melee at-

tack when using that specific weapon for the entire melee round. Shooting bonuses, and trick shooting which includes:

1. Can fire a traditional two-handed weapon, like a rifle, one handed without penalty (normally the shooter loses all strike bonuses).

2. Can shoot over his shoulder by holding up a mirror and using the reflection to aim; no penalties, keep full bonuses to strike.

3. Accurately shoot while riding a horse or a moving vehicle (normally a wild shot), but strike bonuses are half and a "called" shot is impossible.

4. Shoot accurately while standing on head or hanging upside down; all bonuses applicable at full.

5. Dodge, roll or somersault and come up shooting (normally a wild shot), with no bonuses or penalties to strike; straight roll of the dice.

6. Ricochet shot! The shooter can bounce bullets, arrows, slings, and other fired *projectiles* (depending on the specific W.P.) off of one surface and angle the shot in such a way that the projectile **ricochets/bounces** off and hits a different/second **target!** Inflicts only one point of damage to the first surface and full damage to the second. Reduce bonuses to strike by half.

This can also be done with laser weapons but the ricocheting surface must be mirrored or highly polished. Glitter Boys are excellent reflective surfaces for performing a rocochet laser shot. Particle beams, ion blasters, rail guns, mini-missiles and other types of weapons *cannot* be used.

Note: See the W.P. **Sharpshooting** Specialty skill description for full details.

**9. Reputation & Horror Factor:** Basically the same as the Gunslinger: Horror Factor of 8; +1 at levels 2, 4, 5, 6, 8, 10, 11, 13, and 15.

**10. Other Bonuses:** Add 2D6+4 to S.D.C., +2 to pull punch, +2 to disarm on a "called" shot, +2 to save vs possession, and +1 to save vs Horror Factor at levels 1, 3, 4, 5, 7, 8, 9, 11, 12, 13, and 15.

## The Psi-Slinger O.C.C. and NPC Villain Also known as Psi-Assassin and Energy Killer.

**Alignments:** Any, but often anarchist or evil. Those who are honorable and live by The Code may be any alignment, including *good, unprincipled* or *aberrant*.

**Attribute Requirements:** I.Q. 8, M.E. 14, P.P. 17 or higher; anything less is a "dead man walking" when pitted against Gunslingers with a P.P. of 20 or higher. A high I.Q., M.A. and P.S. may also be helpful, but are not required.

**Racial Restrictions:** Humans and Psi-Stalkers only.

**Player Character Note:** Same as the Gunslinger O.C.C., only most people are even more leery and frightened of Psi-Slingers than the run of the mill Gunslinger.

### O.C.C. Skills:

Speaks American and one language of choice at 96% efficiency.

Find Contraband (+10%)

Basic Electronics (+20%)

Piloting Skill: One of choice (+10%) or Horsemanship: General

Interrogation (+10%)

Streetwise (+10%)

Palming (+10%)

Prowl (+10%)

Recognize weapon quality (+20%)

W.P. Revolvers (includes Derringers)

W.P. Automatic Pistols

W.P. Energy Pistols

W.P. **One** of choice.

Hand to Hand: Expert

Hand to hand: expert can be changed to hand to hand: martial arts or assassin for the cost of one O.C.C. Related skill, or to Commando (see *Rifts® Coalition War Campaign*) for two skills.

Horsemanship: General can be changed to Cowboy for the cost of one O.C.C. Related skill.

Also see Sharpshooter Specialty skills, above.

**O.C.C. Related Skills:** At first level the character can select five "other" skills, plus one additional skill at levels 4, 7, 10, and 13. All new skills start at level one proficiency.

Communications: Any (+5%)

Cowboy: None

Domestic: Any

Electrical: Any (+10%)

Espionage: Any (+5%)

Mechanical: Basic Mechanics and Automotive only.

Medical: First Aid or Paramedic only.

Military: None

Physical: Any, except acrobatics.

Pilot: Any

Pilot Related: Any

Rogue: Any (+5%)

Science: Math only (+10%)

Technical: Any (+10%)

W.P.: Any

Wilderness: Wilderness Survival, Track Animals and Hunting only.

**Secondary Skills:** The character gets two secondary skills from the list above, excluding those marked "None," at levels 1, 3, 6, 9, and 11. These are additional areas of knowledge that do not get the advantage of the bonus listed in parentheses. All secondary skills start at the base skill level.

**Standard Equipment:** M.D.C. body armor of choice (**Bandito** Arms and Northern Gun are most popular), tinted goggles or sunglasses, quality cowboy hat, set of riding clothes, a rich quality suit (fancy and expensive) for town — **Psi-Slingers** tend to be very stylish dressers, flashlight, binoculars, multi-optics band, laser **distancer**, pocket language translator, gun cleaning kit, cigarette lighter, pocket mirror, small silver cross, 2 pairs of handcuffs, 50 ft (15.2 m) of lightweight rope, survival knife, two-holster gun-belt, utility belt, knapsack, backpack or saddlebag, air filter, and two canteens.

Starts with a robot horse *or* a brand new hovercycle or **landrover** of choice (see *Rifts® Lone Star* for hovercycles).

Weapons include one **Vibro-Blade**, a Derringer, a pair of fancy silver plated revolvers (plus 60-96 silver bullets), a pair of automatic pistols (often the same caliber as the revolvers), a pair of energy pistols, one additional weapon of choice (including **TW** revolver), 1D4+4 additional **E-clips** for each weapon that needs one, 288 rounds of ammunition for each of the weapons.

**Additional Equipment:** Hand grenades, flares, magic items, special weapons, souped-up vehicles, etc., must be acquired later.

**Money:** Starts with 3D6×100 in universal credits; the rest has been spent on fancy clothes, weapons and vehicles.

**Cybernetics:** None to start. Most Psi-Slingers avoid them except for bio-systems necessary for medical reasons.

## Saddle Tramp O.C.C.

The Saddle Tramp is the nomadic vagabond of the New West. These characters like to think of themselves as free-spirited Jacks-of-All-Trades who ride wherever the wind blows them and stop (for a while) whenever they please. In reality, most are uneducated drifters born of peasants or bandits with little to no formal education and minimal training in any profession. Most are self-serving opportunists who have no use for "The Code," live by the seat of their pants, cheat at cards and do whatever they need to do to survive. The only things that separate them from bandits are that most don't actively engage in robbery or the commission of other crimes, most don't deliberately hurt people, and they're too lazy to work at being an outlaw. Most Saddle Tramps dislike hard work for any length of time and are always looking for the quick and easy way to riches, or that one big deal that will make them rich for the rest of their lives.

These characters like adventure and travel, and don't mind (too much) sleeping in a barn or under the stars when down on their luck (which is usually). However, they love the good life and spend money like water whenever they have it. The Saddle Tramp's dream is to have enough money to wear fine clothes, sleep in the finest hotels, drink the best booze, gamble regularly, and not have to work or worry. Most Saddle Tramps are gamblers, drinkers, braggarts and storytellers (some are con artists and petty crooks), but they are also usually very even tempered and laid back. They are usually honest about their profession as wandering tramps, and don't take offense from those who look down at them or verbally belittle them — most are thick skinned and friendly. Getting handouts (mainly food and drinks) and smooth talking somebody into giving them cash, booze or easy work is considered an accomplishment to be proud of. Saddle Tramps are attracted to gold rushes, towns, saloons, gambling halls and places where they think they can find easy money, scam people, or get easy work.

Of course not all are lazy, shiftless, or skirt the edge of the law, but the majority are, and that's how most people treat them all. Saddle Tramps love gossip, rumor and tall tales even more than cowboys and can usually embellish any story, especially if their efforts will earn them a free drink or handout. The idea of settling down at any one place for more than a few years (and then only if the good life is possible) is inconceivable to most Saddle Tramps. Using a gun is one of the things a Saddle Tramp is usually fairly good at, so he often finds himself in the company of lawmen, adventurers, mercenaries, and bandits; typically as a second string gunman, deputy, native guide or simply an amusing companion.

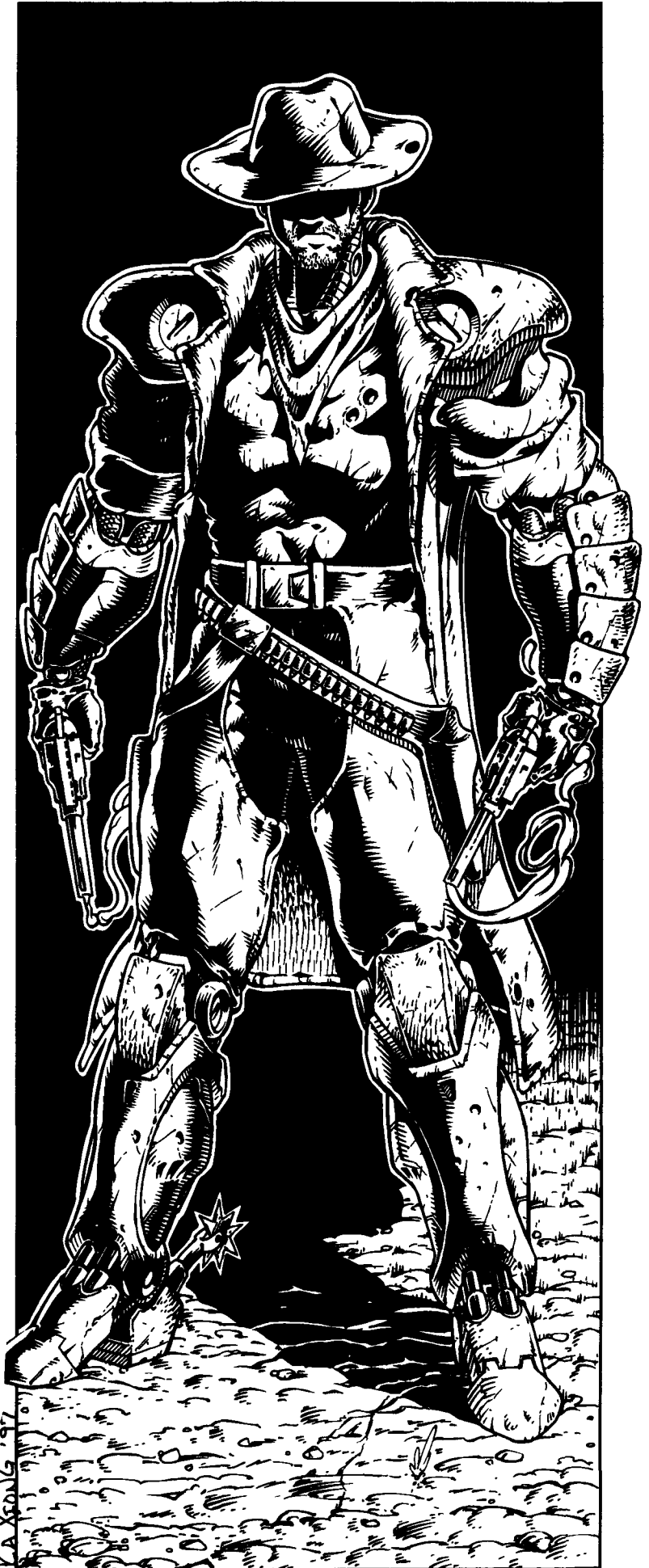

- O.C.C. Bonuses** +1 on initiative.  
 +1D4 to M.A. +2 to pull punch.  
 +2D6+6 S.D.C. +2 to roll with punch, fall or impact.  
 +1 to save vs horror factor at levels 2, 6, and 12.

## Saddle Tramp O.C.C. & NPC

### Also known as Drifter and Scalawag.

Alignment: Any, but the vast majority tend to be selfish.

**Attribute Requirements:** None, although a high M.A. and P.E. is suggested. A high P.B. can't hurt either.

### O.C.C. Skills

- Speak native language (98%)
- Speak one additional language of choice (+20%)
- Radio Basic (+10%)
- Land Navigation (+20%)
- Lore: Two of choice (+20%)
- Horsemanship: General
- Wilderness survival (+10%)
- Swim (+10%)
- Dance (+20%)
- Play Musical Instrument of choice (professional quality; +10%).
- W.P. Revolver
- W.P. Two of choice
- Hand to Hand: Basic
- Hand to hand: basic can be changed to hand to hand: expert at a cost of two O.C.C. related skills, or to martial arts or assassin for the cost of three skills.

**O.C.C. Related Skills:** At first level the character can select five "other" skills, plus one additional skill at levels 3, 6, 10 and 13.

- Communications: Any
- Cowboy: Any (+5%)
- Domestic: Any (+10%)
- Electrical: Basic only.
- Espionage: Tracking, Detect Ambush, and Intelligence only.
- Mechanical: Basic and Automotive only (+5%)
- Medical: First aid, brewing, and Animal Husbandry (+5%)
- Military: None
- Physical: Any, except acrobatics and gymnastics.
- Pilot: Any (+5%), except military vehicles, Bots & Power Armor.
- Pilot Related: None
- Rogue: Any (but +10% to **Cardsharp**, **Palming** and **Street-wise**).
- Science: Astronomy and Math only (+10%)
- Technical: Any (+10%; only **Prospecting** is +15%)
- W.P.: Any
- Wilderness: Any (+10%)

**Secondary Skills:** The character gets four secondary skills from the list, excluding those marked "None," at level one, plus two additional at levels 2, 4, 6, 9 and 12. These are additional areas of knowledge that do not get the advantage of the bonus listed in parentheses. All secondary skills start at the base skill level.

**Standard Equipment:** A suit of M.D.C. body armor, a set of riding/work clothing, a set of fancy "town clothes," a pair of leather cowboy work boots, a quality cowboy hat (lasts for years), a good to excellent quality saddle, saddlebags, spurs,

40 foot (12.2 m) length of rope, a holster, 2-3 canteens, sunglasses, a small hatchet, a survival knife (1D6 S.D.C.), utility belt, backpack, bedroll/sleeping bag, two blankets, binoculars, old style book of matches, cigarette lighter, flashlight or lantern, and a *few* personal items. The Saddle Tramp's horse is of fair to good quality; some prefer modern vehicles.

Weapons include an S.D.C. six shooter (revolver; most will have 24-48 silver bullets in their pack), an M.D. or TW revolver or energy pistol, and an M.D. rifle (Big Bore shotguns are extremely popular among cowboys), plus a reasonable amount of ammunition (bullets and E-clips).

**Money:** Starts with 3D6×100 in universal credits and 1D6×100 in trade goods.

**Cybernetics:** None to start, but may be acquired in the future.

## Sheriff/Lawman O.C.C.

The town sheriff of the New West is the embodiment of the law. He or she performs the everyday duties of a police officer or detective, plus, in many cases, the added responsibility of being in charge of the well-being of the entire town! In addition, the lawman is often the voice of reason when it comes to matters of justice and law, as well as an advisor, confidant and friend. In some instances, usually with the smallest towns, a sheriff must split his time among several communities, farms and ranches spread over a larger area. He may also act as judge, jury and executioner. The Sheriff is the man or woman who everyone looks to in times of trouble, when a group of outlaws rides into town, and when the town is under siege. The sheriff, and his deputies, breaks up brawls and the threat of showdowns, tries to settle disputes over property and claims of cheating, handles drunks and scalawags, investigates robberies, murders and other crimes, attempts to bring criminals to justice, and generally keeps the peace and enforces the law. In addition, the very presence of a sheriff is generally a signal to bandits, lowlives and troublemakers that this town will not abide their mischief.

Sadly, lawmen are a luxury at most small towns. Only about 40% of the average towns (100-600 inhabitants) have a resident sheriff. Even 30% of the large towns (typically 700-3000 people) don't have a resident sheriff or champion/defender. In some cases, a Sheriff or group of official or unofficial lawmen, like Reid's Rangers, the Justice Rangers, and Cyber-Knights, patrol a wide territory where they make regular visits (sometimes weekly, monthly or once every several months) to the towns, villages, farms, ranches and outposts to make sure everything is okay and to settle disputes and rout criminals. This means the lawman could be several days journey away from trouble and may have to stay at one place for several weeks or months to resolve serious problems. During his absence, the other communities on his or her circuit are left unprotected or in their own hands. This is where deputies become a valuable addition to the town, because they can handle most, if not all, of the average responsibilities and trouble of the sheriff. Of course, since deputies are usually less experienced and charismatic than the sheriff, they are sometimes overwhelmed or incapable of handling certain situations and people. **Note:** Only a few western cities have one or more Sheriff's departments and a police force.

To be a sheriff in these trying times one must have a very strong will and the courage to stand alone against the odds.



Sometimes, lawmen find themselves standing against the very people they have sworn to protect when an indignant lynch mob, vigilantes or Justice Ranger insists on bloody justice without a fair trail. Likewise, lawmen often find themselves in competition with, or at odds with, Bounty Hunters, Gunslingers, Gunfighters and powerful (perhaps corrupt or evil) ranchers and business owners. The life of the sheriff is difficult and can be a very short one, indeed.

Technically, anybody with a sense of justice, fair play, a willingness to take a stand, and the ability to handle himself in a fight, can become a sheriff or sheriff's deputy. Throughout history, gunfighters, gunslingers, cowboys, mercenaries, Juicers, sorcerers, and adventurers have worn the badge of the lawman. However, there is a special breed of people, male and female, human and nonhuman, whose sense of justice is so strong that they dedicate their lives to protecting the innocent, bringing law and order over anarchy, and fighting evil in all its forms. They are the *professional lawmen*, whether Sheriff, Ranger, Cyber-Knight or mysterious do-gooder. The following O.C.C. abilities, skills and ethics apply to these champions of justice.

### Special Sheriff/Lawman O.C.C.

#### Abilities & Bonuses

**1. Weapon Mastery & Bonuses:** Can pick up, figure out, and use most types of handguns and rifles.

+1 extra attack per melee round when using a favorite *type* of weapon, pick one from the following: old style revolver and energy pistols, shotguns of all kind, rifles of all kind, *archery/bow* weapons of all kind, or *Vibro-Blades* of all kind.

+3 to disarm on a "called" shot (the intent to disarm must be announced).

+3 to pull punch.

+1 to save vs horror factor at levels 2, 3, 5, 7, 9, 11, 13 and 15.

+2D6+10 to S.D.C.

**2. Quick-Draw Initiative: Handguns *or* Rifles (special; pick one):** This is a special P.P. bonus exclusive to the professional Lawman/Sheriff O.C.C., similar to the **Gunfighter**: +1 to initiative for every two P.P. points above 16 (maximum P.P. 30; for a max. bonus of +7). This means a lawman with a P.P. of 24 is +4 on initiative (plus any other initiative bonuses from skills or magic) whenever he uses that particular type of weapon. Remember, the winner of the initiative roll shoots first. This skill combined with W.P. **Sharpshooting**, makes for a deadly combination. Note: The full bonus applies only to the use of handguns (i.e. Derringers, revolvers and pistols) *or* rifles (energy and conventional); the player must pick one. This bonus does not apply to any other type of weapon. **G.M. Note:** A P.P. above 24 should be extremely uncommon, and 25-28 extremely rare; 29 and 30 virtually unheard of.

Note: Parrying is not possible when two handguns are being used as paired weapons, but the character can dodge (which uses up one of his attacks) and counter by shooting.

**3. Reputation & Horror Factor:** The occupation comes with a certain element of power and danger, particularly among ordinary citizens and two-bit bandits (+1 to Horror Factor). This aura of power, justice and violence gives the known lawman a Horror Factor, however, unlike the Gunslinger, the H.F. of 8 doesn't appear until the character reaches 6th level. Add +1 to



the H.F. at levels 7, 8, 9, 11, 13, and 15. Otherwise the same as the *Gunfighter* ability.

## Sheriff O.C.C. and NPC

**Also known as Lawman, Law Dog, Tin Star and Marshall.** In the days of the pre-Rifts Old West, "Marshall" was reserved for Federal Peace Officers appointed by the Governor or Federal Agencies, but in the New West, it's just another name for a sheriff or lawman.

**Player Character Note:** Like some of the less savory O.C.C.s, the lawman is likely to have (or will build) a reputation and earn his share of enemies. Although most law abiding communities respect and welcome these professional peacekeepers, some may question the character's ethics based on his reputation or that of the town. Many lawless places will look at the **lawman/sheriff** as a potential troublemaker and Gunslinger! Likewise, many tribes of Indians, **Psi-Stalkers** and D-bees have little regard for the character, his position as lawman or "his people's" laws. Criminal gangs, bandits, rustlers, outlaws, and criminals may seize any opportunity to harass, belittle, hurt or kill the lawman and his companions. A professional lawman is frequently pretty obvious even without his badge of office, or may be mistaken for a Gunfighter or Bounty Hunter.

**Alignments:** Any, but typically good or unprincipled. Most are honorable, courageous, resourceful and live by The Code.

**O.C.C. Requirements:** I.Q. 9, M.A. 10, M.E. 12, or higher. A high P.S. and P.P. are helpful, but not mandatory.

### O.C.C. Skills:

Speaks American at 95% efficiency.

Speaks two languages of choice (+20%)

Literacy: American (+30%)

Basic Math (+20%)

Law (+30%)

Interrogation (+10%)

Surveillance Systems (+10%)

Land Navigation (+15%)

Piloting Skill: One of choice (+10%)

Horsemanship General

Recognize weapon quality (+15%)

Find Contraband (+12%)

Streetwise (+12%)

W.P. Revolver

W.P. Energy Pistol

W.P. Energy Rifle

W.P. One Modern Weapon of choice.

Hand to Hand: Expert

Notes: Hand to hand: expert can be changed to hand to hand: martial arts or assassin for the cost of two O.C.C. Related skill or Commando (see *Rifts® Coalition War Campaign*) for three skills.

Horsemanship: General can be changed to Cowboy for the cost of one O.C.C. Related skill.

**Sharpshooting** Specialties count as two skill selections.

Paired Weapons: Revolvers and Pistols, the same as the Gunslinger and Gunfighter, can be selected but at the cost of two O.C.C. Related skills and is not available as a Secondary Skill.

**O.C.C. Related Skills:** At first level the character can select six "other" skills, plus one additional skill at levels 2, 4, 6, 8, 10 and 12. All new skills start at level one proficiency.

Communications: Any (+10%)

Cowboy: Roping and Trick Riding only (+5%)

Domestic: Any

Electrical: Basic only

Espionage: Any (+5%)

Mechanical: Basic and Automotive only (+10%)

Medical: First Aid or Paramedic only (+5%).

Military: Any (+5%)

Physical: Any, except acrobatics.

Pilot: Any (+5%)

Pilot Related: Any

Rogue: **Cardsharp** (+5%) only, unless evil. Evil characters can select any (+5%)

Science: Math and Astronomy only (+5%)

Technical: Any (+5; +10% to language, lore & history skills).

W.P.: Any

Wilderness: Any

**Secondary Skills:** The character gets two secondary skills from the list above, excluding those marked "None," at levels 1, 3, 5, 7, 9, and 11. These are additional areas of knowledge that do not get the advantage of the bonus listed in parentheses. All secondary skills start at the base skill level.

**Standard Equipment:** M.D.C. body armor of choice (**Bandito** Arms and Northern Gun are most popular), tinted goggles or sunglasses, cowboy hat, set of riding clothes, set of fancy town clothes, pen flashlight, regular sized flashlight, binoculars, laser **distancer**, pocket language translator, pocket magnifying glass, passive nightvision goggles, portable tool kit, cigarette lighter, pocket mirror, small silver cross, 4-6 pairs of handcuffs, a six foot (1.8 m) length of M.D.C. chain (18 M.D.C.) with a heavy-duty lock (5 M.D.C.), 100 ft (30.5 m) of lightweight rope, survival knife or hatchet, utility belt, knapsack, backpack or saddlebags, air filter, and two canteens, plus a **Sheriff's** badge if an official lawman.

Starts with a fair to good quality horse or a battered looking Northern Gun hovercycle (see *Rifts® Lone Star*; reduce the usual M.D.C. by 3D4%).

Weapons include one Neuro-Mace, a conventional six-shooter (plus 60-144 silver bullets), energy pistol or **Techno-Wizard** pistol of choice, energy rifle of choice with telescopic scope and **thermo-imaging**, one additional weapon of choice, 1D4+3 additional **E-clips/ammo** clips for each of the weapons, two smoke grenades and a dozen flares.

**Additional Equipment:** Magic items, special weapons, power armor, souped-up vehicles, etc., must be acquired later.

**Money:** Starts with 2D6×100 credits worth of tradeable goods and 1D6×1000 in universal credits. The typical sheriff's salary includes free room and board at a nice place (sometimes a house, more likely a room at the hotel or one of the saloons), use of a horse and/or vehicle, free medical care (if available), ammunition and basic supplies, along with a salary of 150-300 credits a week. Of course, big towns and cities can often pay two or three times more, and famous lawmen can often get twice as much even at small towns, and 8-10 times as much at wealthy communities and big cities. However, more often than not, the lawman is more concerned with the welfare of the people and justice than big pay, and may work for free (at least for awhile) to rid the community of some truly foul desperados, monsters or dangerous villains if they honestly can't afford it. Thus, lawmen typically adjust their price

to what is fair and equitable for the community.

On the other hand, there are tales of lawmen who have gone on rampages, seizing property and killing town bosses, after risking their lives for little pay to protect a town that lied about its true resources/wealth. Most lawmen cannot abide liars and cheats of any kind, and will extract "justice" and revenge from anybody who tries to cheat or use them. Worse, towns, politicians and business tycoons who earn a reputation as tightwads and cheats soon find honest lawmen, mercenaries and adventurers turning against them, leaving them at the mercy of less scrupulous gunmen for hire.

**Cybernetics:** None to start; left solely up to the player. Some lawmen acquire a few basic implants like augmented hearing and/or optics, but tend to avoid more extreme bionic enhancement, except for medical purposes.

**Note:** The lawman's "sidekick," helper and associate is his deputy, although lawmen may also ride with and hire other sheriffs, **gunfighters**, gunslingers, and other trustworthy fighters and adventures. Also see the Saloon Bum and Barmaid as another pair of likely sidekicks or informers.

## Sheriff's Deputy O.C.C.

*Sheriff Tom marched into the saloon with both of his Peacemakers slung low. He walked with confidence and had an air of power about him. Everybody knew why he had come. "I need a couple a good men, seems we got ourselves a situation outside of town. Any volunteers?" I volunteered first. I don't know why, it*

*just seemed right. Besides, I'd always wanted to be one of the law."*

**Deputy Sheriffs**, also known simply as "deputies," are the sheriff's **handpicked** police officers and makes up the majority of large western police forces. They are expected to be as loyal and trustworthy as the sheriff, although they are rarely as skilled. Since deputies are always volunteers, these men and women tend to be very heroic and very loyal to the sheriff and/or their community, sometimes to the point of fanaticism. There is many a story where a sheriff and 5-10 good deputies held a D-bee horde or an outlaw band at bay when the town depended on it.

Other times, deputies can be family members (brother, cousin, etc.), or old friends and acquaintances of the sheriff who the lawman trusts and knows can handle themselves in a fight. In the worst of situations, the sheriff's deputies may be Saloon Bums, Saddle Tramps, petty crooks, farmers, or any able body willing to stand at his side. The situation and quality of the law will vary dramatically from town to town.

Most towns that have a sheriff will also have 1-6 deputies, and some large and/or prosperous towns and cities will have an entire Sheriff's Department with 2-8 sheriffs and 10-30 deputies. However, most western towns can barely afford to keep a sheriff (60% don't have one), and will only have deputies if they can afford them, or the deputies are willing to work for a pittance. The job typically offers a low pay (50-100 credits a week) along with room and board. Sometimes, the Sheriff will pay or subsidize these deputies and hired gunmen out of his own salary or savings, and pay can be augmented with rewards from bounties.

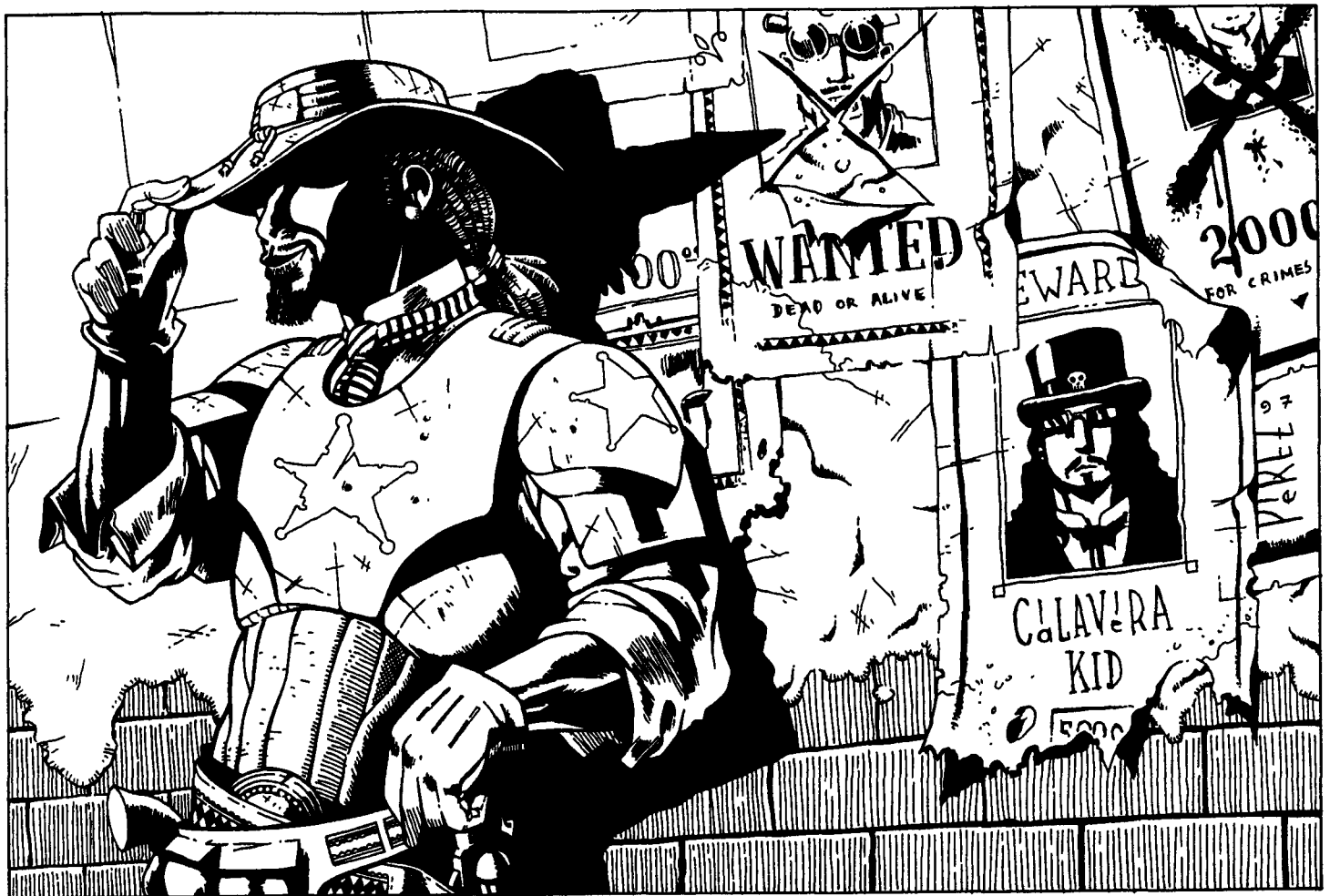

## Deputy Sheriff O.C.C. Bonuses:

- +1 to M.E.
- +2D6 S.D.C.
- +1 on initiative.
- +2 to pull punch.
- +1 to roll with punch, fall or impact.
- +1 to save vs horror factor at levels 2, 5, 9, and 12.

## Deputy Sheriff O.C.C. and NPC

**Also known as Deputy, Law Officer, Lapdog of the Law, or Little Tin Star.**

**Player Character Note:** Deputies are less likely to develop their own reputations, other than as being the henchmen or lackeys of the lawman they serve, or as wannabe sheriffs (which some go on to become). Consequently, they do not evoke the same amount of respect or fear that their boss commands, and are sometimes mocked by outlaws and troublemakers. On the other hand, they may share the sheriff's reputation for being tough, mean, murderous, corrupt, or whatever the case may be. Yet even under these circumstances, the deputy rarely carries the same weight of authority as his superior. Most are dedicated to serving their leader (the lawman) and the law and proudly display their tin star as a badge of honor.

**Alignments:** Any, but typically good or unprincipled. Most are honorable, diligent, loyal to the sheriff and live by The Code.

**O.C.C. Requirements:** M.E. 9, P.P. 9 or higher; a high P.S. and I.Q. are also helpful, but not mandatory.

### O.C.C. Skills:

- Speaks American at 95% efficiency.
- Speaks one language of choice (+20%)
- Literacy: American (+15%)
- Basic Math (+20%)
- Law (+20%)
- Surveillance Systems (+10%)
- Land Navigation (+10%)
- Piloting Skill: One of choice (+10%)
- Horsemanship: General or Pilot Hover Vehicle
- Recognize weapon quality (+10%)
- Find Contraband (+8%)
- Streetwise (+6%)
- Paramedic (+10%)
- Lore: Two of choice (+15%)
- W.P. Revolver
- W.P. Energy Pistol
- W.P. One Modern Weapon of choice.
- Hand to Hand: Basic

**Skill Notes:** Hand to hand: basic can be changed to hand to hand: expert for the cost of one O.C.C. Related skill or to martial arts (or assassin, if evil) for two skills.

**Sharpshooting Specialties** count as two skill selections.

**Paired Weapons:** Revolvers and Pistols, the same as the Gunslinger and Gunfighter, can be selected but at the cost of three O.C.C. Related skills and is not available as a Secondary Skill.

**O.C.C. Related Skills:** At first level the character can select six "other" skills, plus one additional skill at levels 3, 5, 8, and 12. All new skills start at level one proficiency.

- Communications: Any (+10%)
- Cowboy: Trick Riding only.
- Domestic: Any

Electrical: Basic only.

Espionage: Tracking, Disguise, Intelligence, and Wilderness Survival only (+5%).

Mechanical: Basic and Automotive only (+10%).

Medical: Brewing and Holistic Medicine only (+5%).

Military: Etiquette and Trap Construction & Detection only.

Physical: Any, except acrobatics.

Pilot: Any (+5%)

Pilot Related: Any

Rogue: None, unless evil. Evil characters can select any (+5%).

Science: Math only (+10%)

Technical: Any (+10; +15% to language, lore & history skills).

W.P.: Any, except Heavy Weapons.

Wilderness: Any

**Secondary Skills:** At level one, the character gets four secondary skills from the list above, excluding those marked "None," plus two additional at levels 4, 8, and 12. These are additional areas of knowledge that do not get the advantage of the bonuses listed in parentheses. All secondary skills start at the base skill level.

**Standard Equipment:** Basically the same as the sheriff, plus a first-aid medical kit, IRMSS, and RMK Knitters.

Starts with a fair to good quality horse *or* a battered looking hover vehicle.

Weapons include one Neuro-Mace, a conventional six-shooter (plus 40-60 silver bullets), energy pistol of choice, and one additional weapon of choice with 1D4+1 additional E-clips/ammo clips for each of the weapons, two smoke grenades and a dozen flares.

**Additional Equipment:** Magic items, special weapons, power armor, souped-up vehicles, etc., must be acquired later.

**Money:** Starts with 1D6x100 credits worth of tradeable goods and 1D4x1000 in universal credits. The typical deputy's salary includes free room and board at a fair to nice place (often has family and a place to live in the town; 55% are natives of the town they serve), use of a horse and/or vehicle, free medical care (if available), ammunition and basic supplies, along with a salary of 50-100 credits a week; 150-250 at big or wealthy towns and cities. However, frequently, the lawman they serve will supplement their salary at least a little, and in some cases, the sheriff pays his deputies out of his own pocket!

**Cybernetics:** None to start; left solely up to the player. Some lawmen acquire a few basic implants like augmented hearing and/or optics, but tend to avoid more extreme bionic enhancement, except for medical purposes.

**Note:** Deputies sometimes have connections and informers among relatives, friends, and businesses in the town, particularly if it is the place of their birth.

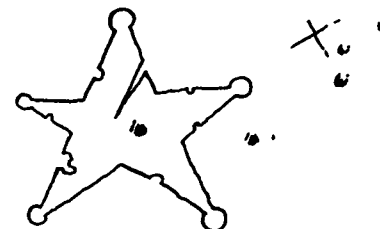

# Wired Gunslinger O.C.C.

The Wired Gunslinger is a character who has been mechanically hardwired for greater reflexes, reaction time and response movement. Basically the character is programmed to respond to movement, quickly identify an enemy or hostile action, and respond by targeting, quick draw, and shooting him dead!

The original concept was to use modified and limited M.O.M. brain and optic implants similar to those used in Crazies, but without the full range of the Crazies' powers and hopefully without the side-effect. Unfortunately, the side-effects and mental problems that plague the Crazy are also prevalent in the Wired Gunslinger, although in some ways, not as extreme. Wired Gunslingers tend to be jumpy, fidgety, and quickly become paranoid, because the slightest motion catches their eye and gets the adrenaline flowing. This also makes sleep and concentration difficult, nor can the Wired Gunslinger ever truly relax. Most suffer from mild paranoia ("People are out to get you, watch out! What was that? Is somebody sneaking behind you?"), delusions of power ("I'm the fastest and deadliest there ever was! What was that?!"), always looking around, have trouble concentrating on other skills and other subjects (no or low skill bonuses), are easily distracted, and like to kill — really like to kill. To the Wired Gunslinger, the thrill of combat is like a drug high. It feels great, better than anything else in the world! Most Wired Gunslingers embrace and love it. The best become daring heroes, the worst, cold-blooded killers who fight and kill at the slightest provocation.

## Special Wired Gunslinger O.C.C.

### Abilities & Bonuses

**1. Danger Response (special):** Automatically notices and reacts to movement, especially movement seen out of the corner of the eye. It is an instinctive and reflex response to draw and point his gun at anything that moves because it could be an enemy or it startles him — just pray he doesn't shoot first and ask questions later (many do). In many situations, the character's reflex reaction to even overwhelming odds is to shoot, dodge and keep shooting until the danger is gone. This causes the deaths of many Wired Gunslingers, but 25% kill themselves after 10+2D4 years (unless miscreant or diabolic evil alignments) because of the stress from the constant anxiety of thinking an enemy is lurking behind every shadow, or because they accidentally injure or kill an innocent person (often a child or woman) as a result of the danger response.

**2. Crazies Augmentation Bonuses:** Attributes: Increases P.S. 1D4, P.P. to 17+1D6, +2D6 to speed.

+1 to save vs horror factor at level 1, 3, 4, 5, 6, 8, 10, 12, 14 and 15.

+1 extra attack per melee round (regardless of weapon being use, as well as in hand to hand combat).

+3+1D4 to initiative with any weapon and in hand to hand combat.

Automatic dodge, which means he can choose to dodge any type of attack instead of parrying, without losing a melee attack/action.

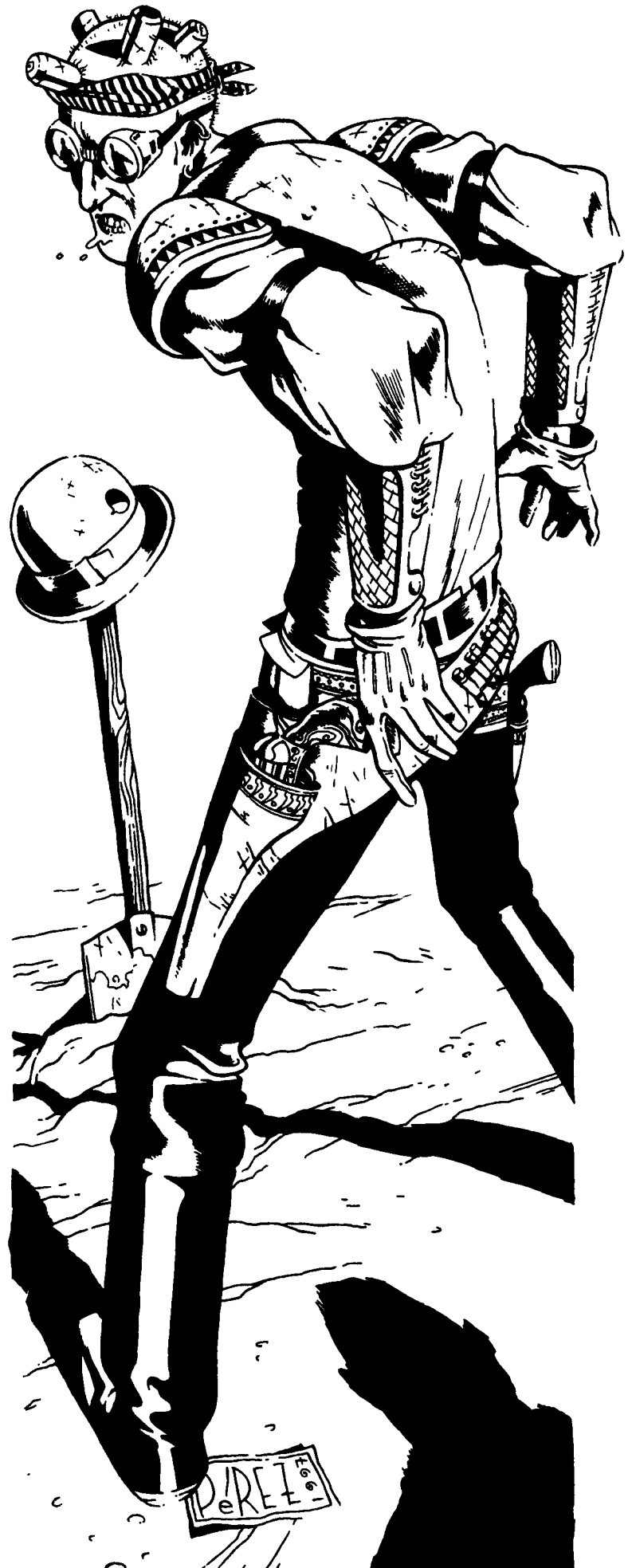

+2D6+16 S.D.C.

**3. Expertise with all handguns:** The use of all types of revolvers and pistols, whether they fire bullets or energy bolts; effectively the same as the Gunslinger O.C.C.

**4. Quick-Draw Initiative:** This special P.P. bonus is not quite the same as other fast-draw artists; see initiative bonus in number two above.

**5. Paired Weapons: Revolvers & Pistols (special):** The Gunslinger can draw and shoot two handguns (or throw two knives) simultaneously at the same target, inflicting full damage from both weapons, but counts as one melee attack!

In the alternative, the two-gun attack can be divided between two *different* targets visible to the shooter, and within his range of peripheral vision. The divided attack counts as one simultaneous melee action directed at two different foes. The quick-draw initiative bonus still applies, but the shooter must roll two separate times to hit each target (roll to strike for each), and the bonus to strike each is reduced by half because the attack is divided.

**Note:** Parrying is not possible when two handguns are being used as paired weapons, but the character can dodge (which uses up one of his attacks) and counter by shooting.

**6. W.P. Sharpshooting Specialty: Sharpshooting:** Revolver and Sharpshooting: Energy Pistol.

Sharpshooting is a combination of special expertise and trick shooting with a particular type of weapon. Includes +1 melee attack when using that specific weapon for the entire melee round, shooting bonuses, and trick shooting, which includes:

1. Can fire a traditional two-handed weapon, like a rifle, one handed without penalty (normally the shooter loses all strike bonuses).

2. Can shoot over his shoulder by holding up a mirror and using the reflection to aim; no penalties, keeps full bonuses to strike.

3. Accurately shoot while riding a horse or a moving vehicle (normally a wild shot), but strike bonuses are half and a "called" shot is impossible.

4. Shoot accurately while standing on head or hanging upside down; all bonuses applicable at full.

5. Dodge, roll or somersault and come up shooting (normally a wild shot), no bonuses or penalties to strike; straight roll of the dice.

6. Ricochet shot! The shooter can bounce bullets, arrows, slings, and other fired *projectiles* (depending on the specific W.P.) off of one surface and angle the shot in such a way that the projectile **ricochets/bounces** off and hits a **different/second** target! Inflicts only one point of damage to the first surface and full damage to the second. Reduce bonuses to strike by half.

This can also be done with laser weapons but the ricocheting surface must be mirrored or highly polished. Glitter Boys are excellent reflective surfaces for performing a **rocochet** laser shot. Particle beams, ion blasters, rail guns, mini-missiles and other types of weapons *cannot* be used.

**Note:** See the W.P. Sharpshooting Specialty skill description for full details.

**7. Reputation & Horror Factor:** The mere occupation alone comes with a certain stigma and creates an element of fear, par-

ticularly among ordinary citizens (+2 to Horror Factor for the Wired Gunslingers when ordinary folk try to save vs H.F.). Wired Gunslingers are known to be crazed killers which provides them with a Horror Factor of 8 +1 at levels 2, 4, 5, 6, 8, 10, 11, 13, and 15. Opponents must roll to save vs Horror Factor whenever the Wired Gunslinger makes a serious threat ("stop or else" ... etc.) and again if and when he first draws his weapon on a character (How does one react? Beg, dodge, try to shoot first? The latter is usually a bad mistake). Likewise, those who attack a Wired Gunslinger must roll to save vs Horror Factor whenever facing the Shootist in a one-on-one showdown, duel, or shootout, and whenever an opponent makes his first move to attack the Wired Gunslinger, even if the Wired Slinger isn't aware the character plans to attack.

A failed roll means the Wired Gunslinger's opponent momentarily hesitates or freezes or fumbles with his weapon (slow-draw). Obviously losing initiative and one melee attack against a Wired Gunslinger, even for a melee round, is deadly, unless the **'Slinger** retaliates by shooting to disarm or wound (or happens to roll poorly and misses).

This reputation is a two-edged sword. While it may provide an intimidation factor, power, and an edge in combat, on the downside, famous and/or notorious Gunslingers are likely to be noticed whether they want to be or not, usually by other men at arms, outlaws, bounty hunters and lawmen, but sometimes by ordinary citizens. The most famous are modern day "superstars" like Michael Jordan or Michael Jackson, and can not go anywhere without being recognized. This can become a deadly liability, and certainly makes anonymity impossible for those travelling in their company.

**8. +1 Melee Attack** at levels 5, 10, and 15 when using any type of revolver or pistol **only!**

---

## Insanities of the Wired Gunslinger

---

In addition to the anxiety, fidgeting, mild paranoia and other things mentioned in the description, roll on the following table at levels 3, 5, 7, 10, and 13.

**01-15 Phobia:** Fears other Gunslingers, rival Brain Fry and Crazies. He knows they're out to get him, so he tries to avoid their company, and will usually accept their mocking him, back down from their challenges, and avoid showdowns and fights against them. Fights them only when backed into a corner.

**16-30 Paranoia: "They're *all* out to get me!":** The character believes that most people hate him out of jealousy because he's better than they are, or dislike him because they fear him. As a result, he believes "they" are out to get him in some way: kill, imprison, cheat, rob, charge him higher prices, give him smaller portions, give him a substandard **product/room** or service, discredit his reputation, lie to and about him, etc. The character blames all of his misfortunes on the ill will of others and sees conspiracies in everything. He is especially leery of other professional gunmen, lawmen and bounty hunters.

**31-40 Ordinary laws are meant for "ordinary" men:** The Wired Slinger's sense of superiority is such that he ignores the laws of any place he visits. The character isn't necessarily mean about it, but he blatantly and deliberately breaks and ignores the

law (often little things). He just does as he pleases and refuses to pay the consequences when accused of breaking laws.

**41-45 Bold daredevil — "I can do anything:"** The character is usually a friendly, cheerful braggart who accepts any challenge, takes stupid risks, and fights at the drop of the hat to defend his honor or the honor of his friends and allies (even if they ask him not too). His antics often get him in trouble and endangers those around him.

**46-50 Manic depressive:** Alternates between severe depression one week (nobody loves him, he's a loser, and he's going to die in the street; -10% on all skills, and reduce all combat bonuses by half), with manic episodes the next week (**every thing** is great, he's the best there is, life is grand! +5% on all skills and +2 on initiative).

**51-55 Compulsive Liar;** even to good alignments.

**56-60 Obsession: Cleanliness:** Always keeps himself as clean as possible, washes hands a dozen times a day, bathes and washes his clothes frequently, and always cleans up after himself. Furthermore, he tries to avoid getting dirty and finds those who don't follow his regimen of cleanliness to be foul, dirty people and may not even shake their hands. In addition, he has three dozen disposable, plastic surgical gloves, a box of 144 Wet Wipes, plus six bars of soap, a washcloth, and box of detergent for clothing, as part of his equipment.

**61-65 Kleptomaniac:** A compulsion to steal, often little and insignificant things, as well as expensive or important items, even if a good alignment.

**66-70 Phobia: Fear of Heights:** The character will *not* willingly climb to higher than 10 feet (3 m) and will either fight and run away or freeze in terror (no initiative or attacks) if forced. This also means the character hates to fly.

**71-75 Obsessive hatred** for a particular monster or D-bee race. Hates them, will not trust or associate with them for any reason, treats them with disdain, and will beat or kill them at the tiniest provocation, including things as petty as the offending party accidentally bumping him, a mean or disapproving look, snoring, etc.

**76-80 Obsessive disdain for the law and lawmen.** Ignores all laws, deliberately breaks them (often with great fanfare), openly belittles, defies and challenges lawmen, and loves show-downs with lawmen.

**81-85 Obsession: Random Roll:** See *Rifts® RPG*, page 20.

**86-90 Phobia: Random Roll:** See *Rifts® RPG*, page 20.

**91-95 Frenzy:** See *Crazies in the Rifts® RPG*, page 57.

**96-00 Multiple Personality:** See *Crazies in the Rifts® RPG*, page 59.

## Wired Gunslinger O.C.C. & NPC Villain

**Also known as Brain Fry, Wired Killer, Wired Slinger and Slinger.**

**Alignments:** Any, but often anarchist or evil. Those who are honorable and live by The Code, may be any alignment, including *good, unprincipled* or *aberrant*.

**Attribute Requirements:** None, just a willingness to be augmented and the money to get it done (150,000-200,000 credits). Wired Slingers can often make arrangements to get "wired" by agreeing to work for the body-chop-shop proprietor or a sponsor, typically a wealthy rancher, business tycoon, or the Black Mar-

ket (sometimes a town or gang) who has need of a Wired Killer or enforcer. Typically, 3-4 years of servitude will usually pay for the augmentation. Those who renege on the deal are usually considered low-down polecats and often hunted down and killed.

**Racial Restrictions:** Humans and very human-like **D-bees** (including Elves, Ogres, and True **Atlanteans** who don't have magical tattoos, etc.).

**Player Character Note:** Same as the Gunslinger, only the Wired Slinger is considered to be even more violent and unpredictable.

### O.C.C. Skills:

Speaks American and one language of choice at 95% efficiency.

Find Contraband (+6%)

Piloting Skill: One of choice (+10%) or Horsemanship: General. W.P. Revolvers (includes Derringers)

Interrogation (+15%) W.P. Automatic Pistols

Streetwise (+10%) W.P. Energy Pistols

Palming (+10%) W.P. two of choice.

Prowl (+5%)

Recognize weapon quality (+15%)

Hand to Hand: Expert

Hand to hand: expert can be changed to hand to hand: martial arts or assassin for the cost of one O.C.C. Related skill, or to Commando (see *Rifts® Coalition War Campaign*) for two skills.

Horsemanship: General can be changed to Cowboy for the cost of one O.C.C. Related skill.

Also see Sharpshooter Specialty skills, above.

**O.C.C. Related Skills:** At first level the character can select five "other" skills, plus one additional skill at levels 2, 4, 6, 8, 10 and 12. All new skills start at level one proficiency.

Communications: Any (+5%)

Cowboy: None

Domestic: Any

Electrical: Basic Electronics only.

Espionage: Any (+5%)

Mechanical: Basic Mechanics and Automotive only.

Medical: First Aid or Paramedic only.

Military: None

Physical: Any, except acrobatics.

Pilot: Any (+5%)

Pilot Related: Any

Rogue: Any (+5%), except Computer Hacking and Seduction.

Science: Math only (+5%)

Technical: Any (+10%)

W.P.: Any

Wilderness: Any (+10% to land navigation only).

**Secondary Skills:** The character gets two secondary skills from the list above, excluding those marked "None," at levels 1, 3, 6, 9, and 11. These are additional areas of knowledge that do not get the advantage of bonuses listed in parentheses. All secondary skills start at the base skill level.

**Standard Equipment:** M.D.C. body armor of choice (Bandito Arms and Northern Gun are most popular), tinted goggles or sunglasses, quality cowboy hat, set of riding clothes, a rich quality suit (fancy and expensive) for town — Wired Slingers tend to be very stylish dressers, flashlight, binoculars, multi-optics band, laser distancer, pocket language trans-

lator, gun cleaning kit, cigarette lighter, pocket mirror, small silver cross, 2 pairs of handcuffs, 50 ft (15.2 m) of light-weight rope, survival knife, two-holster gun belt, utility belt, knapsack, backpack or satchel, air filter, and two canteens.

Starts with a robot horse or a brand new hover vehicle.

Weapons include one Derringer, a pair of fancy, silver plated revolvers (plus 60-96 silver bullets), a pair of automatic pistols (often the same caliber as the revolvers), a pair of energy pistols, one additional weapon of choice (including TW revolver), 1D4+4 additional E-clips for each weapon that needs one, and 288 rounds of ammunition for each of the weapons.

**Additional Equipment:** Hand grenades, flares, magic items, special weapons, souped-up vehicles, etc., must be acquired later.

**Money:** Starts with 4D6×100 in universal credits; the rest has been spent on fancy clothes, weapons and vehicles.

**Cybernetics:** Starts with clock calendar and one multi-optic eye (see **Rifts® RPG**, page 231), in addition to the M.O.M. implants. Any additional augmentation must be acquired later, but most Wired Slingers tend to avoid them except for medical reasons; after all, "How can one improve on perfection?"

---

# Adventurers

---

## Adventurers of the New West

Cowboy O.C.C.

Professional Gambler O.C.C.

Mining 'Borg O.C.C.

Saloon Bum/Stoolie O.C.C.

Preacher O.C.C.

Saloon Girl/Barmaid O.C.C.

## Cowboy O.C.C.

What would the West be without cowboys? The cowboys of Rifts Earth have been as romanticized, especially by Easterners and citizens of the Coalition States, as they were in the pre-Rifts cinema, myths and legends. In fact, many of the pre-Rifts myths and wild extrapolations perpetuated in films, books and other fictional or semi-factual works have been accepted by the survivors of the Great Cataclysm as historical fact! Thus, these glamorous portrayals, weapons, clothing, stylings, icons, ethics, mannerisms and lifestyles have been adapted by the cowboys of *Rifts New West*.

Most legends and works of fiction portray the cowboy as a hard-riding, hard-drinking, gunslinging, rough and tumble, free spirit of the plains, with a basic, homespun sense of honor and justice — both hero and noble laborer, who isn't shy about saying his peace and standing up for what he knows is right — the backbone of Western society. Of course, some of this is true, and many Rifts Cowboys follow the *Code of the New West* religiously, but the hard reality is that the average cowboy is a sweaty, hard working hombre who is often overworked, ill-fed and underpaid to fry his brains mending fences, building corrals, recovering lost animals, roping, branding, and riding the prairies to herd cattle and horses under the baking sun. The open plains and forests of the west are swept by blowing winds, cold rain, and stalked by the hungry eyes of predatory monsters, Coalition scouts and **Skelebots**, bandits, cannibalistic **Simvan**, strange (and often deadly) **D-bees** and other hostile forces. Most human cowboys are in their twenty's or thirty's and retire or settle down by the time they are forty: worn out or crippled.

The cowboys of the New West are a wildly mixed lot in temperament, goals, conduct and race. One in four is a Psi-Stalker, one in six a **D-bee**, one in eight a Mexican or Indian, one in ten a partial or full conversion cyborg, and one in a hundred a supernatural being or practitioner of magic (typically low to mid-level); only 10% are female.

The average cowboy is an expert in roping, riding and driving cattle, horses and similar livestock, including buffalo,

**Rhinobuffalo** and various dinosaurs, as well as alien animals from the Rifts who have melded into the ecology of the American West (**Duckbill** dinosaurs, **Tri-Tops** and **Desert Sleepers** are all good eating, and not much more difficult than herding cattle). Most cowpokes see themselves as pragmatic, simple, honest, hard-working men and women. They pride themselves on their cunning, resourcefulness, skills and mastery of horseback riding. Some consider their horse as much a travelling companion, partner and/or a part of the family as their real kith and kin. Few self-respecting cowboys (5%) ride hovercycles and only 7% ride robot horses, preferring the real, living and breathing animal over a machine — robot horses and hovercycles are favored by many men at arms, bandits and adventurers. Most cowboys feel a sense of majesty and power when sitting high in the saddle upon the noble horse.

The average cowboy does not own the cattle he tends, but works for a wealthy rancher who typically owns a large parcel of land with a well or stream, in addition to the animals. Most cowboys know how to use a gun but are not mercenaries, bandits, **killers**, or guns for hire. When not tending to livestock or herding cattle, cowboys busy themselves with branding, birthing animals, cutting the sick and ailing from the herd, breaking horses, chopping firewood, mending fences, building new fences and corrals, patrolling the grazing range, chasing away squatters (typically **D-bees**) and outlaws, watching out for rustlers, tracking down and returning strays, making firebreaks by furrowing stretches of ground, hunting and killing predators and **maneaters**, protecting the herd, defending the ranch, protecting his employer (and the employer's family), and working as an enforcer for the autocratic and powerful rancher.

**Note:** Many times (60%), ranchers are so powerful, independent and influential that they are like kings or barons who make the laws of the region, or can ignore them with impunity. Many do as they please, and often have great influence on the neighboring towns, communities and people living around them. In some cases, the rancher is the true power (whether noble, corrupt, misguided or evil), behind one or more towns, especially if the town has grown around the ranch and relies on it to survive. This means the rancher's men — cowboys, hands, **gunfighters**, and enforcers — may also serve as a small private army, henchmen or minions.

When a cowboy can't find work handling cattle, or wants a break, he may undertake work as a wilderness scout,

trapper/skinner, adventurer, bouncer, barkeep, bounty hunter, lawman (usually a deputy), and just about any sort of honest work he can find, other than farming and education. Those of an evil alignment may turn to crime and engage in cattle rustling, banditry, work as a bodyguard, gun for hire, gunslinger/killer or enforcer/thug.

Most cowboys love gossip, rumor and tall tales. They love to hear and tell stories, especially heroic adventures, so they have a fondness for rogue scholars and storytellers of all kinds — plus they can weave pretty good yarns themselves.

### The Code of the Cowboy

**Note:** Most cowboys (95%) of a good, selfish and aberrant alignment devotedly follow the *Code of the New West*; it's part of their code. Even some evil cowpokes will try to follow a good portion of the "The Code" as best they can. In addition, most cowboys observe the following:

Consider a fellow cowboy a friend, until he proves otherwise.

Greet a fellow cowboy with a friendly word and hospitality. Never wave a greeting; it is bad form and may spook the horse or cattle.

If one rider dismounts, you (and all others) should too.

Grabbing the bridle of a mounted man's horse is an act of aggression and intrusion over the rider's control of his horse. Expect trouble!

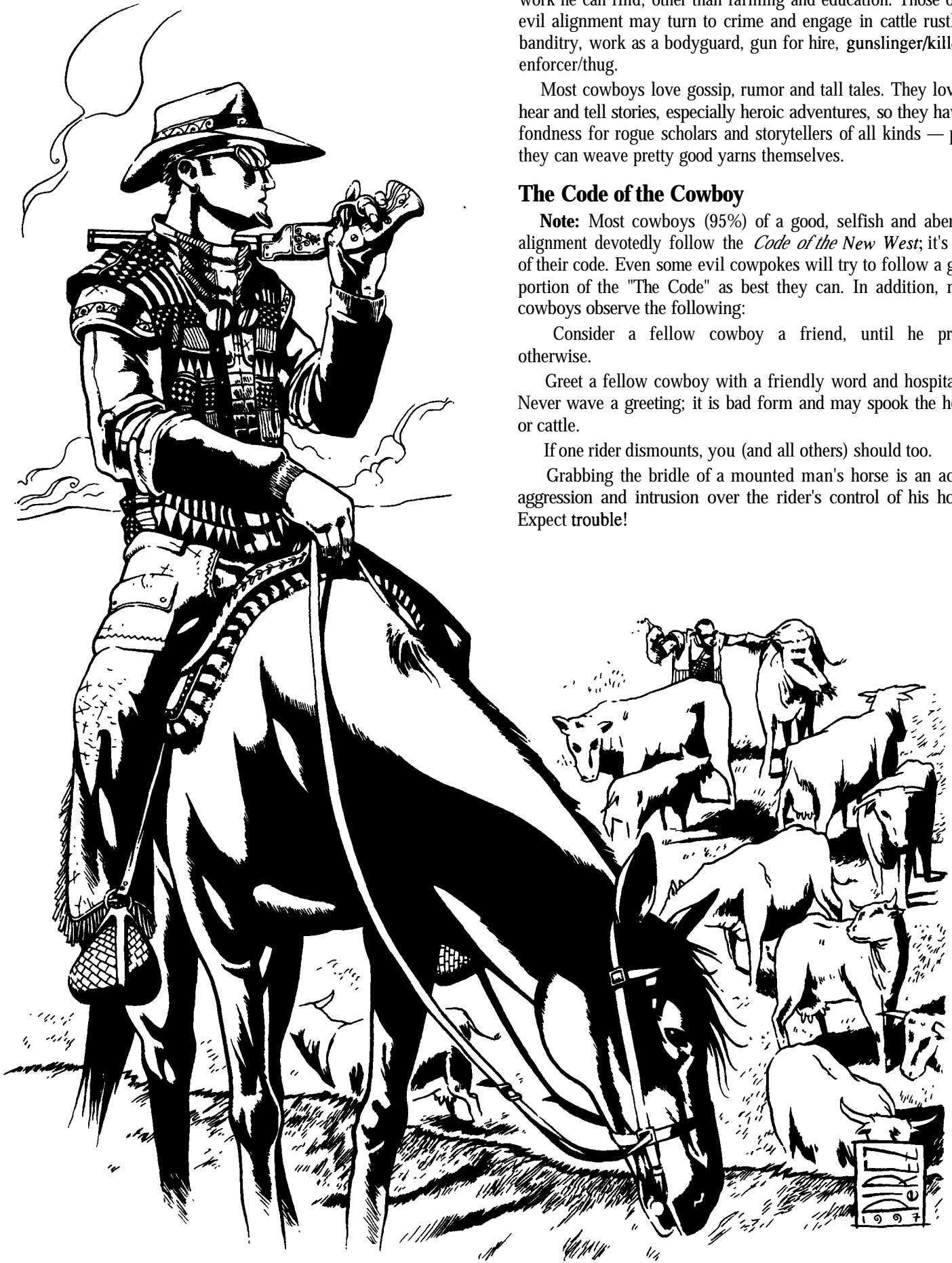



It's a cowboy's sacred obligation to show hospitality to visiting cowboys, including sharing food and information.

**Deadbeats**, loafers, tramps, saloon bums, outlaws, gamblers, and gunslingers ain't cowboys and ain't particularly welcome, especially at the ranch or on cattle drives and roundups. Watch your back around these fellas.

### **Cowboy O.C.C. Bonuses:**

- +3D6+6 S.D.C.
- +2 to pull punch
- +1 to disarm
- +1 to strike/ensnare with a lasso at levels 2, 6 and 11.
- +1 to save vs horror factor at levels 2, 4, 8, and 12.

### **Cowboy O.C.C.**

**Also known as Cowhand, Cowpoke, Wrangler, and Buckaroo.**

**Alignment:** Any.

**Attribute Requirements:** P.P. 10 and P.E. 12 or higher, plus an independent spirit and a willingness to work hard.

#### O.C.C. Skills

- Speak native language (98%)
- Basic Math (+15%)
- Radio Basic (+10%)
- Branding (+20%)
- Herding Cattle (+20%)
- Roping (+30%)
- Land Navigation (+20%)
- Lore: Cattle/Animals (+20%)
- Horsemanship: Cowboy
- Climbing (+10%)
- General Athletics
- Play Musical Instrument of choice (professional quality).
- W.P. Revolver
- W.P. Energy Pistol
- W.P. of choice
- Hand to Hand: Basic
- Hand to hand: basic can be changed to hand to hand: expert at a cost of one O.C.C. related skill, or to martial arts or assassin for the cost of two skills.

**O.C.C. Related Skills:** At first level the cowboy can select five "other" skills, plus one additional skill at levels 3, 7, 11 and 15.

- Communications: Any
- Cowboy: Any (+20%)
- Domestic: Any (+5%)
- Electrical: Basic only.
- Espionage: Tracking, Detect Ambush, Intelligence, and Wilderness survival only (+5%).
- Mechanical: Basic and Automotive only (+5%)
- Medical: First aid, brewing, and Animal Husbandry (+10%)
- Military: Any
- Physical: Any
- Pilot: Any (+5%), except military vehicles, Bots & Power Armor.
- Pilot Related: None
- Rogue: **Cardsharp** and Streetwise only (+5%).
- Science: Math only (+10%)
- Technical: Any (+10% to Art, Language and Lores)

W.P.: Any; including *Quick-Draw Initiative: handguns or Rifles (special)*, the same as the Sheriff/Lawman O.C.C. This is not an automatic skill and must be selected as one of the character's O.C.C. Related Skills; it is not available as a Secondary Skill.

Wilderness: Any (+10%)

**Secondary Skills:** The character gets four secondary skills from the list, excluding those marked "None," at level one, plus two additional at levels 3, 5, 7, and 11. These are additional areas of knowledge that do not get the advantage of the bonus listed in parentheses. All secondary skills start at the base skill level.

**Standard Equipment:** A suit of light M.D.C. body armor (30-50 M.D.C.), a set of riding/work clothing, a set of fancy "town clothes," two pairs of soft leather work gloves, a pair of leather cowboy work boots (fancy), a pair of (even fancier) dress boots, a high quality cowboy hat (lasts for years), a high quality saddle, saddlebags, spurs, 60 foot (18.3 m) length of rope (made of hemp, rawhide or modern materials), a holster, 2-4 canteens, sunglasses, a small hatchet, a survival knife (1D6 S.D.C.), a **Vibro-Blade** (1D6 M.D.), utility belt, backpack, bedroll/sleeping bag, blanket or two (more likely for the horse than for the man), binoculars, laser distancer, old style book of matches, cigarette lighter, flashlight or lantern, and a *few* personal items.

**The cowboy's horse** is always of very good to excellent quality and well trained. In real life, the cowboy's horse was often lent to him by his employer. However, in Rifts, most cowboys, especially those who travel from job to job and engage in adventuring, own their own horse. 5% may own a hovercycle instead, and 7% may have a robot horse, but most prefer a real horse. As one pre-Rifts cowboy named Jo Mora said, "a man afoot is no man at all ... indeed, a dismounted cowboy is just a plain bowlegged human who smells very horsey at times, sleeps in his underwear, and is subject to boils and dyspepsia."

**Weapons include** an S.D.C. six shooter (revolver) used for herding cattle (making noise), shooting snakes, lame animals, target practice and shooting vampires (most cowboys have 18-48 silver bullets in their pack); an M.D. or TW revolver or energy pistol, and an M.D. rifle (Big Bore shotguns are extremely popular among cowboys), and a reasonable amount of ammunition (bullets and E-clips).

**Money:** Starts with 2D6x1000 in universal credits and 3D6x100 in trade goods.

**Cybernetics:** Many cowboys can't afford cybernetics, but most pride themselves on being tough and resourceful humans who don't need "machine parts" to prove themselves. In fact, many cowboys look down upon partial and full conversion cyborgs, and don't consider them "real" men. Cowboys generally get cybernetics only for medical reasons; bio-systems whenever possible.

**Note:** Cowboys are found where ranches and cattle trails are most numerous, which includes the territories that were once known as the States of Texas, Oklahoma, Kansas, Nebraska, New Mexico, Colorado, Wyoming, Montana, and South Dakota, as well as the CS State of Missouri and Arkansas.

# Mining

## 'Borg/Prospector O.C.C.

Mining is a dangerous business. Cave-ins, land slides, explosions and poison gases are but a few of the hazards faced when mining for the treasures of gold, silver, copper, iron, coal, and other valuable minerals deep below the earth. Nobody quite knows who first came up with the idea to use bionics for mining, but such augmentation and full conversions are common in the Western Territories. Bionic conversions are often provided and paid for by wealthy (and hopeful) landowners, mining tycoons, mining unions or large towns and cities (like Silvereno where more than 60% of the miners are 'Borgs) in exchange for 8-10 years of service (plus room and board, and a tiny salary). After those years of service, the Mining 'Borg can become "freelance" or "independent" and go prospecting on his own. Many people find this to be a cheap and easy way to attain the power only a mechanical body can offer them.

Mining 'Borgs are specifically designed for strength and mining, so hands and forearms are equipped with various types of interchangeable drills, lasers and torches for cutting through rock and digging. See the weapons and equipment section for details on specific types of bionics.

Those who get tired of prospecting and mining or have nothing but bad luck, may quit mining and either become a builder or an adventurer, but always with an eye out for precious metals and stones, and the possibility of a big strike.

### Mining 'Borg O.C.C. Abilities and Bonuses

**1. Underground Tunneling (Special):** Knows how to dig and build solid, strong tunnels (no fear of a cave-in) with amazing speed and dexterity. He can also excavate ruins and the sites of cave-ins with the same prowess. In addition, the character can usually tell if an existing tunnel or chamber is a natural formation or whether it was built by humans or others. The character can also tell if it's new, old, or ancient. **Base Skill:** 40% +5% per level of experience.

**2. Underground Architecture:** The character is an excellent underground architect, able to build small and large rooms, ornate archways, staircases, and great chambers, as well as a labyrinth of tunnels, passageways, and underground traps (most common are pit and cave-in type traps). Likewise, the character can recognize the styles of human construction. The Mining 'Borg who is travelling slowly and cautiously while looking for underground traps can locate them, and avoid or deactivate them. **Base Skill:** 30% +5% per level of experience; detection and deactivation of traps is done at half his normal architecture skill level.

**3. Underground Sense of Direction:** The character has an innate ability to tell direction when underground, even in total darkness (not applicable on the surface). Thus, the cyborg can tell whether he is travelling up, down or straight, the approximate angle of decline or ascent, approximately how far below the surface he is, and the approximate direction (north, south, east, west). **Base Skill:** 40% +5% per level of experience.

This skill also enables him to judge the approximate locations to surface structures (natural and artificial), but *only* if the character is familiar with the area. The character will also

recognize traits and aspects of the underground tunnel or construct that serve as landmarks for him. **Base Skill:** 20% +5% per level of experience; -25% if in an unfamiliar area.

**4. Metal Working:** A basic understanding of the methods and craft of the blacksmith, smith techniques and procedures, and working with metal, particularly in the area of making simple weapons, horseshoes, nails, and jewelry. **Base Skill:** 40% +5% per level of experience.

**5. Other Bonuses:** +2 to roll with punch, fall or impact, +1 on initiative, +2 to pull punch, resistant to heat and cold, and +3 to save vs horror factor.

### Typical Bionic Features

**Note:** Other features and attachments can be added but at a later date and the character must have the money to get them.

**1. Partial Reconstruction Mining Cyborg:** Emphasis is on strength, construction and mining. As heavy as possible with reinforced spine, neck and shoulders, bionic hands and arms, bionic legs, plus optics and internal implants. Size is 6.6 to 7 feet (1.95 to 2.1 m) with a P.S. 20, P.P. 18, Spd 44 (30 mph/48 km) and can leap 10 feet (3 m) high or lengthwise from a standing position or 3 times that distance with a running start.

M.D.C. by Location: Main Body: 130 M.D.C. +120 bionic body armor, hands (2) 25, arms (2) 75 each, legs (2) 110each.

#### Typical Bionic Features:

Universal headjack: Amplified hearing with sound filtration system.

Optics: Passive night vision system and thermal eye for one, the other eye is normal.

Hands and Arms: Modular design to fit and use a variety of hand and forearm attachments. Comes standard with one hand with a laser finger and sensor hand, and one hand and arm replaced with a heavy drill.

Cybernetic Lung Implants: Toxic filter, oxygen storage cell and molecular analyzer (see **Rifts® RPG**, page 232).

Left leg: Concealed large and small compartments for flashlight, flares and tools.

Right leg: Concealed large and small compartments for rope and first-aid kit.

Cost: 5-6 years of service.

**2. Full Construction Mining Cyborg:** Emphasis is on strength, construction and mining. As heavy as possible with reinforced spine, neck and shoulders and full bionic conversion. Size is 7.6 to 9 feet (2.25 to 2.7 m) with a P.S. 28-30, P.P. 22, Spd 66 (45 mph/72 km) and can leap 12 feet (3.6 m) high or lengthwise from a standing position or 3 times that distance with a running start.

M.D.C. by Location: Main Body: 200 M.D.C. +150 bionic body armor, hands (2) 30, arms (2) 100 each, legs (2) 180 each, head 90. Typical Bionic Features for Full Conversion 'Borgs:

Universal headjack: Amplified hearing with sound filtration system.

Optics: Multi-Optic System (see **Rifts® RPG**, page 231).

Hands and Arms: Modular design to fit and use a variety of hand and forearm attachments. Comes standard with one *shovel hand* with a laser finger and sensor hand features, and one hand and arm replaced with a heavy drill or plasma torch. See the *cybernetic equipment section* of this book for details.



**Bionic Lung:** All Features! Bionic lung with gas filter, oxygen storage cell, molecular analyzer, radio, loudspeaker, language translator and voice synthesizer (see **Rifts® RPG** page 242).

**Left leg:** Concealed large and small compartments for flashlight, flares, tools and a concealed ion or laser rod.

**Right leg:** Concealed large and small compartment for rope, first-aid kit, and other equipment.

33% have an extra appendage (prehensile tail or pair of extra arms) which provides one extra attack per melee round; costs an additional one year of service.

**Cost:** 8-10 years of service. Additional bionic features and arm attachments that belong to the miner may add an additional 1-4 years depending on how extensive he wants to go.

### **Mining 'Borg O.C.C. & NPCs**

**Also known as Prospector, Dirt Digger, & Tunnel Rats.**

**Alignment:** Any

**Attribute Requirements:** M.E. 12 or higher, and independent spirit and/or a willingness to work hard. A good I.Q. and P.E. are desirable but not necessary.

#### **O.C.C. skills for all Mining Cyborgs:**

Language: American 98% (see built-in language translator)

Math: Basic (+10%)

Radio: Basic (+10%)

Land Navigation (+15%)

Demolitions (+20%)

Prospecting (+30%)

General Repair & Maintenance (+15%)

Basic Mechanics (+10%)

Pilot skill of choice (+20%)

Whittling and Sculpting (+10%)

W.P. Knife

W.P. Energy Rifle

W.P. One of choice.

Hand to Hand: Expert

Hand to hand: expert can be changed to martial arts or assassin at the cost of one "O.C.C. Related Skill."

**O.C.C. Related Skills:** Select six "other" skills, plus select one additional skill at levels four, eight, and twelve. All new skills start at level one proficiency.

Communications: Any (+10%)

Cowboy: None

Domestic: Any

Electrical: Basic Electronics only (+10%).

Espionage: Intelligence and detect concealment only.

Mechanical: Any (+5%).

Medical: First Aid and Brewing only (+5%)

Military: Demolitions (any) and Traps (any).

Physical: Any that are still appropriate.

Pilot: Any (+5%), except robot, power armor, and military.

Pilot Related: Any

Rogue: Any (+2%), except seduction and cardsharp.

Science: Math only

Technical: Any (+10%)

W.P.: Any

Wilderness: Any

**Secondary Skills:** The character also gets to select four secondary skills from the list, excluding those marked

"None," at level one and one additional skill at levels 2, 4, 8, 10, and 12. These are additional areas of knowledge that do not get the advantage of the bonus listed in parentheses. All secondary skills start at the base skill level.

**Standard Equipment:** Light to medium M.D.C. body armor as noted under M.D.C. by location, quality cowboy hat, poncho or cloak, tinted goggles, air filter, flashlight, large wooden cross (just in case), cigarette lighter, pocket magnifying glass, pocket mirror, 150 feet (15.2 m) of heavy cord or cable, pick axe, shovel, sledgehammer, mallet, tool kit, two utility belts, knapsack, backpack, four small sacks, 1D4 large sacks, and three canteens.

Weapons, survival knife and two of choice — should be reflective of W.P. skills or basic needs, and 3 additional E-clips/ammo clips for each. Plus one type one fusion block, 48 blasting cartridges (each is equal to a fragmentation grenade; 2D6 M.D.), and 36 flares.

No vehicle to start.

**Additional Equipment:** Additional bionics, specials items, tools, weapons, explosives, vehicle, etc. must be acquired later.

**Money:** Those who are working as payment for their augmentation make 100 credits a week and get free room and board. Veteran miners who are "freelance" expert laborers and consultants can get paid 400 to 1000 credits a week plus free room and board. "Independents" are self-employed prospectors who often turn to freelance work in mining, construction, smithing, heavy labor and appraising gems, jewelry and precious metals when times are tough — few prospectors ever strike it rich.

Those who turn to adventuring (prospecting only occasionally as a hobby) start with 3D4×100 credits worth of tradeable goods and 2D4×100 in universal credits.

**Cybernetics:** Additional bionics and implants may be acquired.

## Preacher O.C.C.

The New West, like the West of old, can be a lawless land of violence and conflict. In the old days, traveling judges would go from town to town dealing frontier justice to those who broke the law. With the coming of the Rifts, the New West is an even tougher, more violent frontier where the law usually comes from those with the biggest muscles and most powerful guns. A new breed of traveling judge walks the land during these tumultuous times, the *Preacher*.

Preachers are men and women who counsel wilderness people on what is right and wrong, help settle disputes, speak on a person's or group's behalf, and acts as a judge, drawing on both the laws of man and god. Whether a judgement is made by the Preacher in a closed hearing, publicly, and with or without a jury trial (often without) depends on the crime, the circumstance, the history of the perpetrator, and the Preacher. Travelling Preachers are tough, clever, observant, and self-reliant. In many cases, they are either loved and revered or hated, depending on where one stands on the law (and on the temperament and philosophy of the Preacher).

There are two main types of Preacher, the fire and brimstone, eye for an eye type, and the ones who preach tolerance, moderation and love.



**The Fire and Brimstone Preacher** tends to deal out harsh punishments and lynchings accompanied by long, bombastic sermons about evil, penance and changing one's ways before one finds himself following these lost souls down the road to

damnation! Other punishments are likely to include floggings, beatings, tarring and feathering, and hard labor. This type of preacher is also likely to carry a gun (typically the Big Bore sawed-off shotgun and/or an ion blaster) and has no compunction about "rooting out evil" using physical violence, guns and bloodshed. The Fire and Brimstone Preacher will "smite down the wicked" with his fists, a kick in the pants, a stick, sword or a gun. Such characters are hard men (and occasionally women; 15%) for hard times. Most have grown intolerant of the lawlessness, cruelty and injustice they see around them, and have become militant in their crusade to crush (or at least drive) evil and wickedness from the land. Most are good people who sincerely care about the weak, innocent and downtrodden, especially women and children. However, the Fire and Brimstone Preacher is also more likely to harbor resentment and bigotry toward D-bees and even encourage their extermination; Simvan and Mountain Giants are often on the top of their list. They also have little kindness or respect for "heathens" such as Native American Indians and Psi-Stalkers, or any people who worship ancient "pagan" spirits and alien gods. As for the supernatural, these preachers often lead crusades against the demonic, and actively promote the destruction of all supernatural beings. "As the Lord drove the serpent out of paradise, so must we drive the demons and monsters of the Rifts from our world." This usually includes dragons, **shapechangers**, (supernatural or not), and all monstrous and reptilian beings regardless of their alignments and intent.

The other type of preacher is the **Peacemaker**, who tends to be a more gentle and philosophical servant of god. Most teach healing, compassion, tolerance and understanding. They make stirring appeals to people's compassion, hope and brotherhood between all of god's creatures, including D-bees and alien creatures. They too stand tall and serve as judges against wrongdoers and issue punishments. Although they will sentence murderers and cutthroats to death, for other crimes they consider all the circumstances of a situation, whether the perpetrator seems truly repentant, and whether or not the punishment fits the crime. Thus, their punishments are more likely to include making restitution to the person or people wronged, community service, public admonishment, rehabilitation and prison time. Although many Fire and Brimstone Preachers consider the Peacemaker to be misguided and soft, the Peacemakers are not cowards or fools. They courageously stand against evil and will fight to protect the innocent when faced with no other recourse. Many have died defending others or standing up for what they believe.

Most Preachers are nomadic by nature and travel the New West from town to town, hearing cases, levying judgements and offering advice and prayers. Large towns and cities usually have one or more churches with one or two resident Preachers (and, perhaps an assistant or two) at each.

## Special Preacher O.C.C. Abilities & Bonuses

### 1. O.C.C. Bonuses: +1D4+2 to M.A.

+2 to disarm on a "called" shot or in hand to hand combat (in each case, the intent to disarm must be announced).

+4 to pull punch.

+2D6 to S.D.C. (another +10 to the F & B Preacher).

+1 to save vs mind control of any kind.

+4 to save vs possession of any kind.

+1 to save vs horror factor at levels 1, 3, 5, 6, 7, 9, 11, 13 and 15.

**2. Tolerance to Alcohol:** Applicable only to the Fire and Brimstone Preacher. Can drink twice as much as the average person; see "Drinking others under the table" described under the *Saloon Bum O.C.C.* for details.

**3. Religion Note:** Most western Preachers tend to be Judeo-Christian type preachers and are predominately human, although nonhumans may be allowed into the ministry as well. Most ministries are regional or local, making for scores of similar but divergent teachings, morals, tolerance, church laws and practices.

## Preacher O.C.C. and NPC

**Also known as Reverend, Minister, Brother, Sister, Sermonizer and Bible Thumper.**

**Player Character & G.M Note:** If playing a religious character feels awkward, uncomfortable or somehow wrong, then don't include it in your games. Also please try to understand and respect the religious faith and sensibility of other players. Even if one player feels seriously uncomfortable, the Preacher character should be tossed out. Please note that the Preacher character is *NOT* intended to disparage any religious faith. It is a broad representation of the Judeo-Christian traveling preachers of the Old West, modified and refitted into the fictional world of **Rifts**®.

That having been said, in the context of the game, remember that even men of god and good intentions suffer from human frailty, emotions, experience and judgement. Not all are fanatics nor saintly and good. While some are misguided or lost (typically the result of tragedy and trauma), others are bold champions of light and bringers of hope and peace to a lawless land — including many of those who preach fire and brimstone. However, some *are* overzealous fanatics, power hungry opportunists, frauds, or downright evil. They are in the minority, but they do exist.

**Alignments:** Any, but generally good or selfish. Most are well-meaning, honorable and live by The Code.

**O.C.C. Requirements:** I.Q. 9, M.A. 10 or higher. The higher the M.A. the better. A high P.S. and/or P.E. are helpful, but not mandatory.

### O.C.C. Skills:

Speaks American and Spanish at 98%

Speaks one language of choice (+20%)

Literacy: American 98%

Math: Basic 98%

Law (+30%)

Lore: Religion (+30%)

Lore: Two of choice (+15%)

Animal Husbandry (+10%)

Paramedic (+10%)

Piloting Skill: One of choice (+10%)

Land Navigation (+10%)

W.P. One Modern Weapon of choice.

**Note:** Hand to hand: basic can be changed to hand to hand: expert for the cost of one O.C.C. Related skill, or to martial arts for the cost of two.

The Fire and Brimstone Preacher automatically starts with hand to hand: basic and one additional W.P. of choice.

**O.C.C. Related Skills:** At first level the character can select seven "other" skills, plus two additional skill at levels 3, 6, 9 and 12. All new skills start at level one proficiency.

Communications: Any (+10%)

Cowboy: None

Domestic: Any (+10%)

Electrical: Basic only.

Espionage: Interrogation only (+5%).

Mechanical: Basic and Automotive only

Medical: Any (+10%).

Military: None

Physical: Any, except Acrobatics and Wrestling.

Pilot: Any (+5%), except power armor and military vehicles.

Pilot Related: Any

Rogue: Computer Hacking and Streetwise only (+2%)

Science: Any (+10%)

Technical: Any (+10%; +15% to language, history and lores).

W.P.: Any

Wilderness: Any

**Secondary Skills:** The character gets four secondary skills from the list above, excluding those marked "None," at level one, and two additional at levels 4, 8, and 12. These are additional areas of knowledge that do not get the advantage of the bonus listed in parentheses. All secondary skills start at the base skill level.

**Standard Equipment:** Light to medium M.D.C. body armor of choice, hooded robe for traveling, two sets of white and/or gray silk robes for sermons, quality cowboy hat, boots, sunglasses, tinted goggles, air filter, a megaphone (for sermons), flashlight, notepad and pens or markers, a post-Rifts printing of the Bible (pre-Rifts relics are the most valued), large wooden cross, small silver cross on a chain, six wooden stakes and a small mallet, pocket magnifying glass, pocket language translator, first-aid medical kit, RMKS Robot Medical Kit, a bottle or skin of wine, box of matches or cigarette lighter, pocket mirror, a pair of handcuffs, 50 feet (15.2 m) of lightweight rope, utility belt, knapsack, backpack, and three canteens.

Weapons, survival knife and two of choice — should be reflective of W.P. skills or basic needs, and 3 additional E-clips/ammo clips for each. **Note:** Some preachers use electric stunners to control and contain criminals, especially fire and brimstone preachers (see Lone Star for details on stunners).

No vehicle to start.

**Additional Equipment:** A pre-Rifts Bible, special items, weapons, a horse or vehicle, etc., must be acquired later.

**Money:** Starts with 3D4×100 credits worth of tradeable goods and 1D4×1000 in universal credits. Often spends money to help the needy (buys them clothes, food, a Bible, etc.). However, there is no self-respecting town that won't find the Preacher (even those known to be evil or spiteful) a room with a bed, desk and bath, and provide for all the character's basic needs (meals, wine for mass and ceremonies, wash and mend his clothes, and similar).

**Cybernetics:** None to start, and usually avoid any, except for medical purposes, as unnatural.

**Note:** A Preacher may have an assistant who helps as a servant, secretary and to spread the word. Such characters are not usually another player character (but can be) and are most likely the acolytes or devoted followers of NPC Preachers. They can be virtually any O.C.C. but tend to be low level rogue scholars, vagabonds, Saddle Tramps, Saloon Bums and ordinary townsfolk.

## Professional Gambler O.C.C.

The stereotype of the Professional Gambler is typically a slick dresser with a certain air of sophistication and a polished manner. While this is often the case, the Professional Gambler or **Cardsharp**, can look and act rich or poor, suave and confident or rough around the edges and uncertain, sophisticated or bawdy. However, one thing is true of them all, they are risk takers in the high-stakes game of adventure and life. Daring and bold, they are people willing to risk everything, including their own lives, if the reward is great enough. For some, that reward is money or fame, for others it is to cheat death by escaping its clutches themselves, or by saving the lives of others.

In many regards the Professional Gambler is a combination con artist, trickster, and secret agent. They often use concealed weapons, derringers and magic, as well as disguises, forgeries, misdirection, subterfuge, secret accomplices and their wits. 20% are minor or major psionics.

Although infamous for taking risks in everything, most Professional Gamblers like to play the odds — which is the safer way to go. They also like to secretly stack the odds in their favor, making their accomplishments look more impressive than they may really be. This applies to all things, including their dealings with people. Thus, Professional Gamblers often investigate and research their opponents, and get a feel for their personalities, quirks, likes and dislikes. This gives the gambler an edge, because he or she can then recognize the meanings of certain responses, emotions and the likelihood of violence. It also tells the gambler just how far he can push his luck against his opponent(s). Some old tricks in stacking the odds in one's favor include polite and cheerful conversation, especially flattery (it is distracting); a cheerful disposition even when losing (this often drives the competition crazy and is, again, distracting) — all such tactics give the opponents a penalty of -5% (cumulative) on their **cardsharp** and playing skills, although all professional gamblers are immune to such tactics. And then there is that old standby: alcohol. Most people, particularly men with something to prove, refuse to acknowledge that alcohol impairs their abilities. In fact, most will insist that they play better with a little "buzz," but nothing could be further from the truth (see the Saloon Bum for details and penalties). Consequently, most Professional Gamblers nurse their drinks after the first two, or even switch tea or apple juice for bourbon and other types of booze, while they encourage others to drink, often buying rounds for everybody. Hustlers, especially those of evil or anarchist alignments, may also use a secret partner or friend to send coded signals or perform a variety of other tricks and scams.

Blane "Bullet" McCoy, a professional Cardsharp and con man, once said, "There's really not much to being a successful gambler, quick hands, nerves of steel, a little inside information, playing the odds, and knowing when to fold. Those who don't know when to fold or how to loose graciously, are destined to failure and an early grave."

### Special Gambler O.C.C. Abilities & Bonuses

**1. Mastery of Card Sharking:** Fundamentally, the Cardsharp's skill, but expanded a bit. The Professional Gambler has soft, sensitive fingers and hands with the touch (and nerve) of a surgeon and the speed of a viper. The hands are so sensitive and trained to notice and feel variations and marks on the cards that the Hustler has the equivalent skill of reading Braille.

As for speed, the character can stack a deck, palm key cards, and deal from the top, middle and bottom of the deck with lightning speed, or as one professional of the Old West quipped, "They'd just flutter them (cards) up like a flock of quail," and usually put whatever cards they wanted wherever they wanted them.

Recognize cheating and marked cards; equal to the Cardsharp skill -10%.

+2 extra melee actions per round involving the palming, concealment, stacking and dealing of cards.

Generally, cool under fire.

**2. Quick-Draw Initiative: Handguns or Throwing Knives (special; pick one):** This is a special P.P. bonus exclusive to the Professional Gambler O.C.C., similar to the **Gunfighter**: +1 to initiative for every two P.P. points above 16 (maximum P.P. 30; for a max. bonus of +7). This means a Gambler with a P.P. of 24 is +4 on initiative (plus any other initiative bonuses from skills or magic) whenever he uses that particular type of weapon. Remember, the winner of the initiative roll strikes first. **Note:** The full bonus applies only to the use of handguns (i.e. derringers, revolvers and pistols) or throwing knives (including Vibro-Knives) of which the player must pick one. This bonus does not apply to any other type of weapon. In the case of knives, the gambler can use his quick hands and keen eyes to inflict either normal damage or *double* damage by going for a vital spot (called shot). **G.M. Note:** A P.P. above 24 should be extremely uncommon, and 25-28 extremely rare; 29 and 30 virtually unheard of.

**3. Tolerance to Alcohol:** Can drink twice as much as the average person — see "Drinking others under the table" described under the *Saloon Bum O.C.C.* for details.

**4. Reputation:** Going up against a Professional Gambler can be unnerving (while the pro seems cavalier and unfazed). This means average characters playing against a notorious professional are -10% in their card playing skills. Likewise, pick pockets and those trying to palm or conceal something from the professional Gambler are also -10% to do so.

**5. Other O.C.C. Bonuses:** +4 on initiative when palming, picking a pocket, or cheating at cards, otherwise +2 on combat initiative.

+1 to disarm on a "called" shot (the intent to disarm must be announced).

+2 to pull punch.

+1 to save vs horror factor at levels 3, 5, 6, 7, 9, 11, 13 and 15.

+2D6+6 to S.D.C.



## Professional Gambler O.C.C. and NPC

Also known as **Cardsharp, Card Shark, Maverick, Rook and Hustler.**

**Player Character & G.M. Notes:** Gamblers are usually regarded as scalawags and troublemakers, but their money and daring are usually welcome at most gambling halls and saloons. These characters make great NPC scoundrels, con artists and villains, as well as likeable rogue player characters.

**Alignments:** Any, but often unprincipled and anarchist. Some are even honorable and live by The Code.

**O.C.C. Requirements: I.Q.** 10, **M.A.** 10, **M.E.** 12, **P.P.** 12 or higher. A high **P.S.** (and **P.P.**) are helpful, but not mandatory.

### O.C.C. Skills:

Speaks American at 98%

Speaks one language of choice (+20%)

Literacy: American 97%      Concealment (+15%)

Math: Basic 98%              Pick Pockets (+15%)

Dance (+20%)                  Disguise (+20%)

Law (+20%)                    Escape Artist (+15%)

Cardsharp (+20%)            Seduction (+12%)

Palming (+20%)              Streetwise (+10%)

Piloting Skill: One of choice (+10%)

Recognize weapon quality (+10%)

W.P. Revolver (includes Derringer)

W.P. Energy Pistol

W.P. One Modern Weapon of choice.

Hand to Hand: Expert

Notes: Hand to hand: expert can be changed to hand to hand: martial arts or assassin for the cost of two O.C.C. Related skills.

Sharpshooting Specialties count as two skill selections.

Paired Weapons: Revolvers and Pistols, the same as the **Gunslinger** and **Gunfighter**, can be selected but at the cost of two O.C.C. Related skills and is not available as a Secondary Skill.

**O.C.C. Related Skills:** At first level the character can select six "other" skills, plus two additional skills at levels 2, 5, 10 and 14. All new skills start at level one proficiency.

Communications: Any (+10%)

Cowboy: None

Domestic: Any (+5%; but +15% to sing and play instruments) Electrical: Basic only.

Espionage: Any

Mechanical: Basic, Locksmith and Automotive only (+10%)

Medical: Brewing and Paramedic only (+5%).

Military: Find Contraband and Traps (both) only (+5%)

Physical: Any, except acrobatics.

Pilot: Any (+5%)

Pilot Related: Any

Rogue: Any (+10%)

Science: Any (+5%)

Technical: Any (+10%).

W.P.: Any

Wilderness: Any

**Secondary Skills:** The character gets two secondary skills from the list above, excluding those marked "None," at levels 1, 3, 5, 7, 9, and 11. These are additional areas of knowledge that do not get the advantage of the bonus listed in parentheses. All secondary skills start at the base skill level.

**Standard Equipment:** Light to medium M.D.C. body armor of choice, mirrored sunglasses, quality cowboy hat, set of traveling clothes, set of fancy "business" clothes, pen flashlight, notepad and pens or markers, a used deck of playing cards, a deck of playing cards still sealed in their wrapper, a deck of marked cards, a pair of loaded dice, pocket magnifying glass, laser **distancer**, pocket language translator, portable tool kit (for palming and escaping), a dozen quality cigars (whether the character smokes or not; they make nice gifts and bribes), a bottle of fine bourbon, a bourbon bottle (with the label) filled with tea (the same color as the genuine McCoy), cigarette lighter, pocket mirror, a pair of handcuffs, 50 ft (15.2 m) of lightweight rope, utility belt, knapsack, backpack or saddlebags, air filter, and canteen.

Weapons include laser scalpel, straight-edge razor (2D4 S.D.C. damage), 1 or 2 folding pocket knives (easy to hide in a boot or palm and conceal), a Derringer (also easy to conceal), a conventional six-shooter (plus 60 silver bullets), energy pistol of choice, one additional weapon of choice, 1D4+1 additional **E-clips/ammo clips** for each of the weapons, five smoke grenades and six flares (for distractions).

No vehicle to start (probably gambled it away).

**Additional Equipment:** Professional Gamblers often have one or more fake **I.D.s** and disguises, but they and magic items, special weapons, power armor, souped-up vehicles, etc., must be acquired later.

**Money:** Starts with 3D4×100 credits worth of tradeable goods and 3D6×1000 in universal credits.

**Cybernetics:** None to start; left solely up to the player. Some acquire a few basic implants like augmented hearing and/or optics, but tend to avoid more extreme bionic enhancement, except for medical purposes.

**Note:** Professional Hustlers often enlist the aid of a "sidekick," helper or partner to cheat at cards and to serve as a general assistant. This lackey is usually a cheat or scalawag who pretends to be either an affable fellow or an innocent half-wit who stands near the table to spy on the hands held by other card players. He or she then puffs on a cigarette or cigar to send up Indian-like smoke signals, folds the arms in different positions, uses innocent looking hand signals (scratches his nose or eyebrow, etc.), hums a tune or sings a song, or plays snatches of songs on a musical instrument, and so forth, ALL as coded signals to send information about the **Cardsharp's** opponent's hand. The sidekick might also sit in on a few hands of cards in which the Cardsharp deliberately deals him a series of winning hands before he calls it a night with his winnings (this also throws suspicion off the Hustler because he has lost those hands too, not that he wagered an excessive amount). Typical sidekicks and partners most commonly include the *Saloon Girl*, *Saloon Bum*, *Saddle Tramp*, *Vagabonds*, *low level Gamblers (1-4th level)*, and occasionally, *Gunslingers* and *psychics*. The latter can be incredibly helpful if he or she possesses telepathy to transmit a complete picture of each player's hand or empathic transmission (can make a person with a winning hand feel insecure and fold, or somebody with a losing hand feel overconfident and continue to bet when he should fold).



# Saloon Bum O.C.C.

## The Western Saloon

The center of activity for most visitors, cowboys, drifters and adventurers in the typical New Western city and town is the district with saloons, gambling casinos and dance halls. The saloon is generally a cross between bar, restaurant, nightclub, and hotel. It can be a rough and tumble place with nightly brawls and shootouts, or a friendly, violence free watering hole. Many saloons are bright, cheerful places where people meet, eat, drink, party, play and have fun. Such establishments are usually run by law abiding citizens who do not offer or encourage illicit pleasures, con games, crime, criminals or foul play. In fact, the owners of such "honest" saloons are likely to throw out troublemakers and known outlaws, con men and cheats; they may not even allow gambling.

Other saloons are dangerous places that attract ruffians, drifters, smugglers, drug dealers, thieves, gamblers, gunslingers, prostitutes, crooks and lowlifes of all kinds. Often the clientele will depend on the town and the owner. In some cases, the saloon may even be a front for the local criminal gang, outlaws, thieves or smugglers' guild. So all saloons are not equal, good or evil, they vary as dramatically as the people who visit them.

**The Bar Area:** The bar is typically a long, narrow counter with a polished top (45% are M.D.C. structures with 3D4x10 M.D.C.). They can typically seat 16-24 customers comfortably. All the best booze is kept behind the bar on shelves underneath the long counter. Tables and chairs are usually available away from, but near the counter and bartenders (can seat another 24-50).

**Drinks:** Most offer an extensive range of alcoholic beverages, from beer and bourbon (the two most popular drinks) to wine, whiskey, and homemade brews with names like *Redeye*, *Skull Bender*, *Gut Rot*, *Snake Bite*, and *Tarantula Juice*. Some of these potent alcohol concoctions are *elixirs* reputed to have healing properties. Of course, only one out of a hundred provides any real medicinal benefit, although most contain an exotic array of juices, herbs, drugs and harmless components, giving the brew an interesting flavor (sometimes delicious, other times terrible). Saloon Elixirs have names like *Rheumatism Medicine*, *Cough Medicine*, *Pain Killer*, *Sleeping Elixir* (because one or two drinks will knock most people unconscious) and *The Cure*. Elixirs are also available from travelling Medicine Shows. Many of these home brewed moonshines are regional favorites, and typically half the cost of a bottle of bourbon, although the most popular can cost twice as much.

**Average Costs:** 1-2 credits a glass or shot for the "cheap stuff," 3-6 credits a drink for the good stuff; a bottle of beer is 1-2 credits, a bottle of cheap whiskey, rum, or moonshine: 5-8 credits; a bottle of good to excellent bourbon, whiskey, rum, or liquor: 10-20 credits.

Coffee, tea, juice and soda are typically 1-2 credits a cup, glass or bottle.

**Saloon Food:** A typical range of simple, but hearty meals includes:

Pancakes and sausage or bacon: 2-4 credits;

2-4 eggs and bacon or ham: 3-6 credits;

bowl of beans or rice (spicy or plain): 1-2 credits;

bowl of stew (beef, buffalo, deer, rabbit, or chicken): 3-5 credits;

steak and potatoes: 7-15 credits;

whole chicken or duck: 6-10 credits;

slice of pie: 2 credits (6-8 for a whole pie)

loaf of bread: 1-2 credits



**Lounge/dining area:** Simple wood tables and chairs for sitting and drinking, eating and talking. Drinkers can also be seated here.

**Stage & Entertainment:** Typically a large room with a small to medium raised platform for a stage (with or without curtains). A piano or organ is located on or near the stage. Amplifiers, speakers and microphones are also located around the stage. The room often has no chairs (standing room only) because the customers usually dance and sing along with the music — the room is also used as a small dance hall.

Entertainment is typically musical bands, singers (from country music, ballads and folk songs to jazz, rock, rap and alternative), burlesque shows, dancing girls, and strip-tease. Comedians, acrobats, and others may also perform at a saloon from time to time. Only occasionally are plays or skits performed here. Such entertainment is usually *free* (it attracts customers) or has a small "cover-fee" of 2-5 credits. However, special name performers may pack the house and command 10-50 credits per person. The more high-tech saloons have video screens and TV monitors scattered throughout the place so that those in the bar and lounge can also see and hear the performance (some may even have them in private rooms). Likewise, some saloon owners prefer "canned" music, juke boxes, and film/video broadcast instead of live (costly and unpredictable) entertainment.

On slow nights, many saloons will *rent* this room to politicians, businesses and community groups for special gatherings and parties.

**Gambling:** Most saloons allow "friendly" games of cards, dice, and darts. Saloons that specialize in games and cater to gamblers will usually offer two or more gambling rooms, often instead of an entertainment/dance hall area. These places are likely to have a main gambling room with craps/dice tables, roulette, blackjack, faro, keno, three-card monte, shell games, slot machines, video arcade games (one can place bets on the score, outcome, and/or winner), and other games of chance. In addition, they are likely to have a pool room (darts too), a poker room with 6-10 tables, and 1-4 private rooms for serious card games (big money games). An area for playing horseshoes may be out back, as might a small pit for wrestling, boxing, cock or dog fights and other blood sports. Some use the stage area as an indoor arena, mainly for boxing, wrestling and dog fights.

Whether the games are "fixed" (i.e. the house cheats to put the odds greatly in their favor) or honest, will depend on the owner and people who run the establishment. Note that even in honest games of cards and chance, the odds are *always* in the favor of the house or dealer (for example, the Blackjack dealer wins 65% of the time without cheating). **Note:** Gambling halls/casinos are also present at many western towns.

**Room & Board:** Many (not all) saloons also offer room and board. These small rooms typically offer a bed, bath and breakfast for the price of a night's stay. Cost can vary dramatically, 20-60 credits a night, but are typically 20-30% less than the local hotel. However, they are rarely as safe as a hotel.

A saloon may have as few as four rooms available to as many as 24. Those hiding outlaws and contraband are likely to have 1-4 secret rooms and compartments, but charge 2-5 times the usual rate per person (not per room) to hide people on the run (and

will feign shock and claim ignorance if their clients are discovered).

**Dens of Iniquity.** Some saloons (depends on the town, owner, and clientele) are places of ill repute where one can find call girls, drugs, and contraband as well as fence stolen goods or hide out (for a price).

### **The Saloon Bum NPC Villain & Optional O.C.C.**

The Saloon Bum is typically a spineless coward, and/or a two-bit thug, or alcoholic. Unlike the Saddle Tramp, there is rarely anything good or likeable about this character (a great NPC villain).

Virtually without fail, **evil Saloon Bums** are backstabbing cowards who don't have the physical abilities or the mental attributes to be anything but the sludge at the bottom of the barrel. Although most covet power and wealth, they *settle* for being the lowlife servants of greater evil forces. They are usually *wannabe* outlaws who bum drinks and eke out a living as stoolies, gofers, lackeys and henchmen of the criminal element, or some other power in the area (politician, rancher, supernatural being, etc.). Many are disillusioned, bitter and mean. They are the weasels who hang out at saloons, gambling halls and other seedy establishments with an ear open for trouble and opportunity. They spy on visiting lawmen, gunslingers and adventurers, and then scurry off into the night to tell their masters what they have learned. Evil Saloon Bums are also likely to deliver messages, warnings and packages, as well as engage in lies, deception, snickering, name calling, instigating fights, leading the unsuspecting into traps and ambushes, stealing, blackmail, conducting interrogations, and torture. As one might suspect, they are only bold and aggressive against victims who are incapacitated, outnumbered, helpless, or weaker than they — including the elderly, sickly, women and children.

**Saloon Bums of a good** or unprincipled alignment are typically individuals who have had their bodies and/or spirits crippled in some way — old and infirm, physically weak or crippled, dull witted (and *innocent?*), homely and insecure, emotionally scarred or traumatized (family, friend or sheriff was slaughtered while he stood frozen in terror, or while he was beaten and held down, or he was the only survivor, etc.) and so on. These characters are usually (mostly) harmless people who serve the sheriff, or politician, or the saloon keeper or owner, or other force in town (probably a business person or hero). Like his evil counterpart, the character serves as messenger, spy, gofer and helper.

It is interesting to note that while most Saloon Bums are heavy drinkers, and some are alcoholics, others simply "hang out" at and around saloons and similar places. In either case, they know their way around a saloon, dance hall and the gambling casino, are streetwise and can spot outsiders, gunslingers, **gunfighters**, knights, lawmen and professional gamblers with ease (same as Streetwise skill).

### **Saloon Bum O.C.C. Bonuses:**

**1. Drink others under the table:** The average character starts to notice the effects of alcohol after three drinks and most are pretty drunk after six drinks (especially if drunken in less than two hours) — note a typical bottle of alcohol contains 16-20 shots/ounces. The effects of alcohol impairs the character's motor skills, sense of balance, and general perception of things.



#### Typical Characters (not heavy drinkers):

After three drinks: -6% on all skills.

After six drinks: -12% on all skills; initiative and all combat bonuses are -2, and reduce speed by 20%.

After nine drinks: -24% on all skills and reduce speed, initiative, attacks per melee round, and all combat bonuses by half.

After 12 or more drinks (falling down drunk): -40% on all skills, reduce speed to 20% of normal, and reduce initiative, attacks per melee and all combat bonuses to two!

Modifiers: The typical *Saloon Girl*, *Bounty Hunter*, *Gunslinger*, *Wired Slinger*, *Crazy Juicer*, *True Atlantean*, *Simvan*, and *heavy drinkers* can drink twice as much before feeling the negative effects (penalties).

*The Saloon Bum* (and dwarves) can drink two and a half times as much before feeling the negative effects (penalties), but runs the risk of becoming an alcoholic if he drinks like this regularly.

*The average dragon*, *Brodkil*, and *lesser demons and supernatural creatures* can drink three times as much before feeling the effects (penalties); greater supernatural beings four times.

#### **2. Other O.C.C. bonuses:**

+1D4 to P.E.

+1D6 S.D.C.

+1 on initiative.

+2 to roll with punch, fall or impact.

+1 to save vs horror factor at levels 3, 7, and 12.

### **Also known as Bar Fly, Drunk, Stoolie, and Stool Pigeon**

**An excellent NPC villain or sympathetic sidekick (NPC or Player)**

**Note:** These same basic stats can be used to make a *barkeep* NPC, except add two lores (+10%) and all rogue skills are available at +2%.

**Alignment:** Any

**Attribute Requirements:** None

#### **O.C.C. Skills**

Speak native language (98%)

Speak one additional language of choice (+20%)

Basic Math (+15%)

Radio Basic (+15%)

Surveillance Systems (+10%)

Interrogation (+5% for good characters, +10% for evil ones)

Horsemanship: General or Pilot Hover Vehicle (+5%)

Dance (+20%)

Sing or Dance (+10%; pick one)

Streetwise (+20%)

W.P. Energy Pistol

W.P. Two of choice

Hand to Hand: Basic

Hand to hand: basic can be changed to hand to hand: expert at a cost of two O.C.C. related skills, or to martial arts or assassin for the cost of three skills.

**O.C.C. Related Skills:** At first level the character can select seven "other" skills, plus one additional skill at levels 3, 6, 9, and 12.

Communications: Any (+10%)

Cowboy: None

Domestic: Any (+10%)

Electrical: Basic only.

Espionage: Any

Mechanical: Basic and Automotive only (+5%)

Medical: Brewing and First Aid only (+10%)

Military: Find Contraband, Recog. Weapon Quality only (+10%)

Physical: Any, except acrobatics, gymnastics, and boxing.

Pilot: Any, except military vehicles, Bots & Power Armor.

Pilot Related: None

Rogue: Any, except seduction (+10% to Pick Pockets and **Cardsharp** only)

Science: Math only (+10%)

Technical: Any (+10%)

W.P.: Any

Wilderness: None

**Secondary Skills:** The character gets two secondary skills from the list, excluding those marked "None," at levels 1, 3, 6, 10 and 15. These are additional areas of knowledge that do not get the advantage of the bonus listed in parentheses. All secondary skills start at the base skill level.

**Standard Equipment:** A suit of M.D.C. body armor (usually light or half suit), a set of clothes, boots, a cowboy hat, a saddle bag, a holster, a canteen, 1D4 bottles of moonshine, one bottle of excellent bourbon, sunglasses or goggles, a

survival knife (1D6 S.D.C.), pair of handcuffs, utility belt, backpack, sleeping bag, language **translato-Blade**, plus two **E-Clips** for each weapon, **vibro-blade**, energy pistol, and energy rifle. No vehicle to start.

**Money:** Starts with 4D4×100 in universal credits and 3D4×100 worth of credits in tradeable goods. Typically gets paid 10-15 drinks a night, free room and board (usually at a shabby flat or apartment), and a small stipend of 50-75 credits a week, plus bonuses of 50-300 credits (or equivalent trade) for especially juicy and helpful information.

**Cybernetics:** None to start, but may be acquired in the future.

## Saloon Girl/Barmaid O.C.C.

Heads of state and outlaws alike come to the saloon to drink, eat, meet with people, and partake of some of the entertainment and pleasures the bar has to offer. Typically, barmmaids/saloon girls and show girls are part of the attraction (not that sex or nudity are necessarily part of the package; often it is *not*). These women function as waitresses, hostesses, and confidantes, and sometimes as show girls and singers, but are always sympathetic listeners and flirts. It is their job to not only wait on tables, serving drinks and food, but dance and sing with patrons, offer gambling tips (in the house's favor), and to encourage the customers to stay and buy drinks (keep that hard liquor flowing like water), and spend money, especially at the gaming tables, as well as on cigars, food, and entertainment. These friendly, pretty faces know how to smile, wink, flirt, engage in polite or bawdy conversation (depending on the woman) and charm men to keep them at the saloon (spending) and to come back to spend more time (and money) with them, as well as to get a nice tip. Most Saloon Girls/barmmaids are *not* call girls! Of course, the more seedy and illicit places will also function as a brothel selling sex, but even barmmaids at such foul establishments are not necessarily prostitutes themselves (flirts, thieves and cheats maybe, but not call girls).

Saloon girls can make charming (and often deceptively resourceful and knowledgeable) companions. Some are hard working and pleasant women who like people and the festival atmosphere of the saloon — and have a heart of gold. Others are gold-diggers who know how to play the innocent girl very believably to get big tips, handouts and favors. Still others are call girls (proceeds of their work is split 50/50 with the saloon owner), or spies, stoolies, thieves, con artists, and scalawags out for themselves.

As superb listeners, sympathetic ears, and angelic faces, they often hear and know more about what's going on in and around town, who is flush with money and who is down and out, who's sleeping with who, whether the sheriff is in town, and all manner of gossip, rumors, lore, and secrets — a walking **treasure-trove** of local information.

Saloon Girls who embark on a life as an adventurer enjoy travel and action. They handle the hardships of the wilderness (and handguns) as well as most men and enjoy manipulating foolish men, learning secrets, and tricking scoundrels. Those of an evil alignment are likely to be spies and informers who sell their information to Bounty Hunters, bandits, outlaws and



anybody willing to pay for what they know (even the CS). Or they may function as petty thieves who roll drunks, or even as opportunists who engage in a little bounty hunting, smuggling or assassination on the side! If you stop and think about the character, the possibilities are endless and can be loads of fun. **Game Masters**, this character is a fantastic Non-Player Character (NPC) — especially evil, two-timing cheats, informers, spies, thieves and assassins.

### Saloon Girl O.C.C. Abilities and Bonuses

**1. Tolerance to Alcohol:** Can drink twice as much as the average character — see "Drinking others under the table" described under the *Saloon Bum* for details.

**2. Other O.C.C. bonuses:**

- +1D4+1 to M.A.; +10% to charm and impress if P.B. is over 20.
- +2D6 S.D.C.
- +2 on initiative
- +2 to roll with punch, fall or impact.
- +1 to save vs horror factor at levels 2, 4, 6, 8, 10, and 12.

### Saloon Girl O.C.C.

**Also known as Barmaid, Gold-digger, Tease, and Seductress.**

**Attribute Requirements:** I.Q. 9, M.A. 10, and P.B. 12, or higher. The higher the M.A. and P.B., the better.

**Alignment:** Any, but often selfish or evil.

**O.C.C. Skills:**

- Speak native language at 98%
- Speak two other languages (+20%)
- Cooking or Brewing (+15%)
- Singing (+15%; professional quality)
- Dancing (+20%; professional quality)
- Seduction (+23%)
- Horsemanship: General or Pilot Hover Vehicles (+10%)
- Lore Skill: Two of choice. (+15%)
- Streetwise (+14%)
- W.P. Energy Pistol
- W.P. One of choice
- Hand to Hand: Basic
- Hand to hand: can be changed to expert for the cost of one O.C.C. related skill, or martial arts or assassin for the cost of two.

**O.C.C. Related Skills:** At first level the character selects two rogue skills plus six "other" skills. Select one additional skill at levels 3, 6, 9, and 12.

Communications: Any (+5%)

Cowboy: Trick Riding and Whittling only.

Domestic: Any (+15%)

Electrical: Basic only.

Espionage: Any

Mechanical: Basic and Automotive only.

Medical: Brewing, Paramedic, or Holistic Medicine (+5%)

Military: None

Physical: Any

Pilot: Any non-military

Pilot Related: None

Rogue: Any (+10%)

Science: Math only (+10%)

Technical: Any (+5%; +15% to Language and Lore skills)

W.P.: Any

Wilderness: Preserve Food, I.D. Plants, & Land Navigation only (+5%).

**Secondary Skills:** Select three secondary skills from the list at levels 1, 3, 6, 10, and 14. These are additional areas of knowledge that do not get the benefit of the bonuses listed in parentheses. All secondary skills start at the base skill level and are limited (any, only, none) as previously indicated in the list.

**Standard Equipment:** Work and casual clothing/dresses, riding boots, dress shoes, hat, gloves, stockings, cosmetics/make-up, purse, pocket mirror, 1D4 bottles of whiskey, a bottle of excellent quality bourbon, a bottle of excellent wine, silver cross on a chain, a pair of sunglasses, a pair of handcuffs, backpack, sleeping bag, language translator, pocket audio disk recorder (and a dozen disks), cigarette lighter, pen flashlight, and a few personal items.

Weapons typically include an S.D.C. six shooter (revolver), an M.D. pistol, an M.D. derringer (concealed) and a folding straight razor (2D4 S.D.C.), holster (may be concealed), plus two E-Clips for each weapon.

No vehicle to start.

**Money:** 1D4×1000 in credits and 3D6×1000 in jewelry. The typical Saloon Girl's salary is 50-75 credits a week, plus tips (usually another 3D4×10 credits a week) and may include free room and board at the saloon or nearby. Those who are extremely skilled at getting customers to spend a lot of money, especially at the gambling tables, are likely to get a small cut, typically about 2D4×100 credits a week at saloons that cater to gambling.

**Cybernetics:** None to start. Avoids unsightly cybernetics except for concealed implants and bio-systems necessary for medical reasons. They need to look soft, pretty and nice.

# Racial Character Classes Common to the New West

## A few comments about D-Bees

Player and Game Masters should realize that there are hundreds of different intelligent life forms from other worlds who have come to Earth through the Rifts. Some have come as willing explorers, settlers, traders, or conquerors. Others are refugees, so desperate that they are willing to flee their own world and risk everything on a one-way trip to a strange new world. Others are victims of dimensional anomalies that tear them, kicking and screaming, from their plane of existence and plunge them into an alien dimension. Since Rifts Earth has become a sort of dimensional hub with hundreds of random and permanent Rifts, victims of dimensional anomalies, magic or super-science gone wrong, often find themselves as castaways on Rifts Earth. Those familiar with dimensional travel via magic, ley lines and Rifts, may use Earth as a nexus to other worlds, or as a way station — a place to stop, rest, restock supplies, or visit before stepping through another Rift to a different part of the Megaverse.

Sometimes as few as one to a dozen people are all that represents their race. Other times, hundreds or thousands, like the Xiticix, Simvan, and Fennodi, appear. Some of these people adapt and prosper, others perish.

Only the "most notable" and numerous of these alien races, dubbed "Dimensional Beings" or, more commonly, "D-bees," are described in the **Rifts® World Books** and **Sourcebooks**. Often the "most notable" means the most aggressive, mean, dangerous, bizarre, or numerous, but they are by no means, all inclusive. Many are humanoids with the same fundamental attributes as humans (3D6 each), and have two arms, two legs, a head and human shape but look different than humans — alien features that may include strange or extra eyes, fur, a tail, strange skin texture and/or color, horns, and so on.

Likewise, the names given to these people (animals and monsters) often reflect the mind set and/or education of the person or people who first encounter them and explains names like "Cactus People, Worm Wraith, Desert Keepers, Xiticix Killer and Vanguard Brawler." It is comparatively unusual (only about 10%) for the aliens to provide a name for themselves (like the Lyn-Srial) and most scientific names are overshadowed by "popular" names and slang. Most names reflect some physical or behavioral aspect of the being.

**Creation Notes for the Average "human-like" D-Bee:** First, remember that the term "D-bee" typically refers only to humanoid/bipedal beings from other worlds, it does not include creatures of magic, supernatural monsters or extremely alien life forms (no human shape). All attributes are typically 3D6 each, but the G.M. may add 1D6 to one attribute, reduce one attribute by 1D6 (typically P.B.) and add 2D6 to the base P.P.E.; only 25% are mega-damage beings, the rest need body armor just like any human. Most can select any O.C.C.s available to humans. Second, third or more generations born on Rifts Earth probably consider Earth their home, are familiar only, or mainly, with regional customs, languages and cultures, and may know little to

nothing about their ancestors and original language, culture and world of origin.

**R.C.C. Notes:** Descriptions and R.C.C. stats for *Simvan*, *Brodkil*, and *Wild and Socialized Psi-Stalkers*, as well as a variety of *mutant animals and the Tokanii* D-bee race, can be found in **Rifts® World Book 13: Lone Star**. *Vampires* and a variety of other races are described in **Rifts® World Book One: Vampire Kingdoms**. *Quick Flex Aliens*, *Vanguard Brawlers*, and some other D-Bees common to North America are presented in **Rifts® World Book 11: Coalition War Campaign**. *American Indians* and the return of many of their gods and spirits are presented in detail in **Rifts® Spirit West™**.

## Notable R.C.C.s of the New West

Cactus People

Fennodi

Keepers of the Desert

Lyn-Srial: Average Citizen

Lyn-Srial: Cloudweaver

Lyn-Srial: Sky-Knight

Mountain Giants

## Cactus People

The Cactus People (their real name is impossible for most humans to pronounce; **Clszymllxbrrxyfwr**) get their name from the fact that they are cactus-green and have a number of lumps and thorny protrusions that resemble Earth Cactus. Some of the lumpy protrusions on the head are eyes (typically 3-4 in the front), while those with thorns are decorative features similar to human hair. Females are the most ... well ... lumpy, while the males have long leafy stands on the side and back of their heads, creating the illusion of hair. Full grown adult males also develop a sort of ribbing that resembles a large smiling mouth with large teeth. Cactus people have two arms, hands, legs and feet, although they have only three long fingers and a thumb, each with suction cups on the end.

Cactus People need lots of sunshine to live and edible greens to survive — in this case they feed on ultraviolet radiation as well as various gases, fresh green vegetables and cactus. Consequently, the Southwest is ideal for these strange beings. Most live off the land or grow farms of cactus and green vegetables such as varieties of lettuce, cabbage, spinach, tobacco (they eat the leaves), green beans, peas and similar crops. They derive water from the fresh plants they eat (cooked greens have only 25% the nutrients and water the aliens need, frozen greens 50%, and dried only 5%; they cannot eat grass or the leaves of trees). They never eat the flesh of animals and rarely keep them around, even as pets. These vegetarians try to avoid trouble and tend to be quiet, reserved and unassuming. They have little regard for money and valuables, although they will inevitably have a hand-



ful of favorite possessions, including a favorite gun, toys, clothes and other odds and ends. As one might suspect, Cactus People don't have much need for buildings or shelter, except to take refuge from animal and monster predators and bad storms (they enjoy a nice rain). Consequently, they often live near the ruins of a pre-Rifts city, an abandoned vehicle, cave, or canyon. Some build a shack or live in a mobile home, typically a covered wagon, truck or similar large, cheap vehicle.

It is humanoid predators that represent the greatest danger. Cactus People are often victimized by bandits, mean spirited drifters, the occasional good old boy or villain who likes to kill D-bees for sport, and from hunters/slavers. Unfortunately for Cactus People, their blood tastes good, is nutritious and an excellent substitute for water. Many a foul person lost in the desert have slain a Cactus Person to drink their blood. Their blood also has properties that makes it ideal for magic healing potions and elixirs, and spoils very slowly (stays fresh for months). This has made them targets for villains who don't consider the aliens to be human or don't care about taking a life, such as **Splugorth Slavers**, and diabolic practitioners of magic, dragons and demons. Those in the market for such commodities will pay 1000 credits per gallon of blood (the typical Cactus person has about one gallon of life fluid).

Although vegetarians who keep to themselves, Cactus People will use technology in limited ways, particularly weapons, armor and tools. And while many a slaver or brigand thinks of them as pacifists, the feisty little D-bees will fight bravely to defend their lives, families, homes and crops. Cactus People can only wear body armor for short periods because they need the life giving sun (clothing doesn't block the UV rays like M.D.C. body armor).

## Cactus People —

### Optional Player Character & NPC

**Also known as Greenies and Cactus Heads.**

**Alignment:** Any, but generally good or selfish.

**Horror Factor:** 9+1D4; their appearance can be disturbing.

**Average Size:** 5 feet (1.5 m)

**Weight:** 150(90 kg)

**Average Life Span:** 60 years; give birth to one or two young as often as once every 18 months.

**Attributes:** I.Q. 2D6+4, M.E. 2D6+8, M.A. 2D6+2, P.S. 2D6+6, P.P. 2D6+6, P.E. 2D6+6, P.B. 2D6+2, Spd. 2D6+2

**P.P.E.:** 4D6

**Hit Points:** P.E. attribute number plus 1D6 per level of experience. S.D.C.: 4D6+6 plus those from skills; half for young.

**Natural Abilities:** Keen vision, see ultraviolet spectrum of light, +3 to save vs disease, can heal 2D6 hit points or S.D.C. per day of sunlight (1D4 if cloudy or in darkness), and can function without food or water for up to a week without ill effect.

**Psionics:** All Cactus People are born with minor psionics. Base I.S.P.: M.E. attribute number plus 1D6 per level of experience. Empathy, see aura, see invisible and special telepathy (no I.S.P. cost; basically the same as telepathy except they can communicate with other species at up to 200 feet/61 m away and members of their own race up to 600 feet/183 m away +50 feet/15.2 m per level of experience).

**Combat:** Typically hand to hand: basic, if any. Those without combat training have two attacks per melee round.

### R.C.C. Skills:

Communicate via telepathy and empathy.

Basic Math (+20%)

Botany (+15%)

Lore: Two of choice (+15%)

Holistic Medicine (+15%, but for Cactus People only)

Identify Fruit and Plants (+20%)

Wilderness Survival (+15%)

Land Navigation (+15%)

Two Physical skills of choice.

Hand to Hand: Basic

W.P.: two of choice

Hand to hand: basic can be changed to expert for the cost of two R.C.C. Related Skills.

**R.C.C. Related Skills:** At first level the character can select six "other" skills. Rarely study new skills later, other than secondary.

Communications: Any (+5%)

Cowboy: None

Domestic: Any (+10%)

Electrical: Basic only(+5%)

Espionage: None

Mechanical: Basic and automotive only (+5%)

Medical: Any (+5%)

Military: None

Physical: Any, except acrobatics.

Pilot: Any

Pilot Related: Any (+5%).

Rogue: None

Science: Any(+5%)

Technical: Any (+10%)

W.P.: Any

Wilderness: Any (+5%)

**Secondary Skills:** The character gets two secondary skills from the list above, excluding those marked "None," at levels 1, 4, 8, 10, and 12. These are additional areas of knowledge that do not get the advantage of the bonus listed in parentheses. All secondary skills start at the base skill level.

**Standard Equipment:** Set or two of clothing, light body armor for combat situations, portable tool kit, survival knife, cigarette lighter, pocket mirror, 50 ft (15.2 m) of lightweight rope, utility belt, knapsack, backpack or saddlebags, shoulder bag for carrying fresh food/plants, two medium-sized Tupperware containers (to keep food fresh), box of 100 zip-lock sandwich bags (for that locked in freshness) and a canteen or water skin.

Weapons: A **Vibro-Blade** and two weapons of choice.

**Allies:** Cactus People recognize the Fennodi, Lyn-Srial and Cyber-Knights as friends and allies, all others are viewed with suspicion until they prove otherwise.

**Enemies:** Other humanoids and slavers.







## Fennodi R.C.C.

In the world of Rifts Earth, it is the monstrous and terrible that seems to get the most notoriety. This is largely because they are the most frightening and dangerous, but not all **D-bees** are devouring or conquering terrors from another world. The Fen-

nodi are an example of the peaceful D-bees who have made Earth their new home. These aliens are a quiet, gentle people who abhor violence and wander the prairies and deserts of the west tending small herds of cattle and other livestock. The

*Shoshone Indians* call them "The Quiet Walkers" because the tall, thin aliens move silently, "like the summer breeze." They are a pale grey color with light tan accents. Their eyes are tiny black dots on the sides of their heads and mounted on small fins or flaps that many people mistake for their ears. These fin-like eye appendages can fold flat against the head, fan forward, and tilt up or down, effectively providing the Fennodi with a 280 degree field of vision. Slits behind the eye fins are their ears. Along both sides of their face, near the jaw, is a flap of skin with three whisker-like fins. Behind each skin flap are three holes which represent the sensitive *nose* of the D-bee. The mouth is a tiny slit just above the chin while the Fennodi's large, ridged cranium gives the aliens a long head with minimal (human) features and what some have called a Catfish appearance. The body of these gentle D-bees is tall and slender, typically about seven feet (2.1 m) tall with long, thin fingers, arms and legs.

Most Fennodi, males and females, are nomads who like to wander, love the land, tend livestock, and mind their own business. They are the friends of all cowboys, most Indians, Lyn-Srial and welcome all people who come in peace, even Wild Psi-Stalkers (who frequently prey upon Fennodi because of their high P.P.E.). Just as humans often have dogs for pets, the Fennodi are often accompanied by **Whisker Coyotes**, small, psionic dog-like creatures from the Rifts which have adapted well to the deserts and plains of the southwest (*Nevada, Utah, Arizona, New Mexico, Lone Star, and Northern Mexico*). The Fennodi's other constant companions are the sacred, crescent-shaped *Nymbu staff* (a sign of peace and travel) and a smoking pipe. They love to smoke, prefer pipes, and are immune to cancer and carcinogens. They are also fond of horses, cowboy hats, boots, vests and the general appearance of the cowboy.

## Fennodi — Optional Player Character & NPC

**Pronounced "Fen no dee"**

**Also known as the "Cowboy Alien" and "Quiet Walkers."**

**Alignment:** Any, but predominately good (80%) or aberrant (10%).

**Horror Factor:** 9; their appearance can be disturbing, despite their gentle disposition.

**Average Size:** 7 feet (2.1 m)

**Weight:** 150 to 200 pounds (67 to 90 kg)

**Attributes:** The number of six sided dice are indicated as follows. I.Q. 3D6+2, M.E. 2D6+8, M.A. 2D6+10, P.S. 2D6+10, P.P. 2D6+8, P.E. 2D6+8, P.B. 2D6+2, Spd. 2D6+8  
P.P.E.: 4D6+12

**Hit Points:** P.E. attribute number plus 2D4 per level of experience. S.D.C.: 4D6 plus those from O.C.C.s and skills.

**Natural Abilities:** Keen vision, see infrared spectrum of light, +2 to save vs disease and toxins, impervious to carcinogens, and they are psionic.

**Psionic Powers: Males:** Base I.S.P.: M.E. attribute times two plus 2D6 per level of experience. Empathy, telepathy, sixth sense, mind block, empathic transmission plus three healing abilities as well as a psychic affinity with the Whisker Coyote and the two powers below. Also select one additional psionic healing power at levels 2, 4, 6, 8, 10, and 12.

**Protective Energy Aura (special):** This is a natural psionic defense mechanism that engages the instant an attack or danger is sensed by the Fennodi. Many believe it is a vari-

ation of the telekinetic force field. Whatever it is, the protective energy field offers limited protection: 16 M.D.C. +1D4 per level of experience — enough to survive the average pistol or rifle blast. The energy aura automatically engages as a reflex response (like an adrenaline surge in humans) and regenerates 2D6 M.D.C. per melee round. This often gives the Quiet Walkers the opportunity to take cover or use other abilities to save themselves.

**Ghost Walk (special):** The Fennodi can partially phase out of current space and time. Many believe that they physically straddle the Astral Plane and physical plane, turning them into semi-transparent, ghostly apparitions. While in this phase, the Fennodi *cannot* be hurt by heat, cold, fire, punches, arrows, bullets, energy blasts, explosions, psionics (cannot be touched by telepathy or empathy) or magic — they all pass harmlessly through them. At the same time, the Fennodi *cannot* use their psionic powers or communicate except by hand signals and body gestures. Nor can they touch or affect the physical plane in any way. Thus, all movement is done as if in slow motion, melee actions are reduced to two, and walking is completely silent but walking speed is reduced to 20% of normal. However, they are impervious to all attacks from the physical plane (but *can* be attacked from the Astral Plane). The Fennodi use the ability to "walk away" from attackers and danger. Range: Self only; including clothing,



walking stick, hat, and backpack. Duration: Five minutes per level of experience. I.S.P.: 10.

**Psionic Powers: Females:** Base I.S.P.: M.E. attribute times three plus 2D6 per level of experience. Empathy, telepathy, sixth sense, mind block, and bio-manipulation plus three physical abilities, as well as a psychic affinity with the Whisker Coyote and the two powers above. Also select one additional *physical* psionic ability at levels 2, 4, 6, 8, 10, and 12.

**Combat (Special):** The Fennodi *Art of Nodox* (Avoidance and Defense). +1 on initiative, +4 to disarm, +6 to pull punch, +1 to parry at levels 1, 3, 6, 9, 12, and 15. +1 to dodge at levels 1, 2, 4, 6, 8, 10, 12, and 14. Pin/incapacitate on a roll of 17-20 (must announce that this is the character's intention), body flip, +2 to roll with punch, fall or impact, and +1 to save vs Horror Factor at levels 1, 3, 6, 9, 12, and 15.

**Actions/Attacks per melee round:** Two at first level +1 at levels 2, 4, 6, 8, 10, 12, and 14. Generally, fight only to escape or restrain their opponent; rarely kill for any reason.

**Available O.C.C.S:** Most Fennodi (50%) are 3rd to 6th level Cowboys or Saddle Tramps (1D4+2), but can also be a vagabond, rogue scholar, rogue scientist, Body-Fixer, Operator, preacher, or saloon bum. They don't care for gambling and

risk taking, and although they find magic fascinating, and use magic items, they never pursue the study of the mystic arts. Likewise, while they find towns and cities interesting places for short visits, the aliens love the wilderness, hot or cold, forests, grasslands, prairies, canyons and deserts; they are found throughout the West, but are far less plentiful in the Canadian Wilderness.

**R.C.C. Skills (in addition to O.C.C.):** Wilderness survival (+25%), land navigation (+20%), prowl (+15%) and W.P. blunt/staff.

**Standard Equipment:** Nymbu staff, smoking pipe, tobacco pouch, small knife and cowboy hat, in addition to items common to their chosen profession/O.C.C. Often have a Whisker Coyote as a pet (ask the G.M. if this is okay for player characters). Most Fennodi don't mind getting a ride on a vehicle, but most don't have any piloting skills, other than horsemanship, and they like to walk.

**Allies:** The Fennodi are generally perceived as gentle, kind-hearted and friendly by most people and are generally the friends of cowboys, Saddle Tramps, Indians, Cyber-Knights and Sky-Knights.

**Enemies:** None per se, although they are frequently victimized by bandits, Psi-Stalkers and supernatural menaces.

---

## Keepers of the Desert R.C.C.

By Chris Kornmann & Kevin Siembieda

---

The Keepers of the Desert are a group of nomads who are considered outcasts by all civilized humans and feared as the enemy of man. According to legend, after the coming of the great apocalypse and the Rifts that followed, the people of **Salt Lake City, Utah**, were subjected to horrible levels of alien radiation and magical energies from a dimensional anomaly. Tens of thousands of people in and around Salt Lake City died, but those who survived the energy bombardment became sick and deformed — all body hair fell out, open sores covered their bodies and their very bones seemed to twist and distort. Those not affected slaughtered thousands more of the withered and ailing people for fear that they carried an alien sickness and death. The rest were driven into the *Salt Lake Desert* where it was hoped that they would die. As the years passed, many of these outcasts died as hoped, but hundreds survived, and within a few generations, began to exhibit strange powers and abilities. Over the course of three centuries, these deformed and mutated outcasts have grown both in number and inhuman power, each exhibiting unique abilities.

All are human in **origin**, general shape and appearance, but their bodies are usually (though not always) hairless, their skin discolored and blotchy, and often covered with lumps, blisters and red or brown sores. Frequently the limbs and hands are deformed (2-3 fingered hands plus a thumb, or a stump in place of a hand, etc.), their faces are typically long (horse head), and their bellies disproportionately extended or swollen-looking, like people suffering from malnutrition. Many have spindly arms and legs, while others have one arm that is longer or larger than the other, or huge, muscled limbs. Spinal deformity is also commonplace, creating hunchbacks and strangely twisted shoulders and torsos.

The Keepers of the Desert are feared more than ever. According to legend, the people who slaughtered thousands of their ancestors in fear and bigotry, and drove the rest into the desert, were besieged first by mysterious assailants who killed hundreds while they slept, then by one natural (or unnatural) disaster after another, then by demons and finally, by a plague until *all* perished. Legend tells that all these terrible occurrences were at the hands of the Desert Outcasts using their newfound powers to extract just, but bloody vengeance. In reality, the Desert Keepers had nothing to do with their demise — their mutant powers didn't even begin to manifest themselves regularly or with any impressive magnitude until two generations after they had been driven away, and some 30 years after the last of their tormentors had died. The truth is, their tormentors died the same way millions of others who survived the Great Cataclysm perished. Ironically, the people who drove the Outcasts into the desert saved their lives.

Thanks to the legends, most people (human and D-bees) assume that the Keepers of the Desert hate all humans and loathe all beautiful things. Nothing could be farther from the truth, but the Desert Outcasts' isolation, frightening appearances, strange powers, and stranger beliefs make for a combination that leads to fear, misunderstanding and bloodshed. Over the years, the Desert Keepers, believed to be a murderous band of misanthropes, no longer human, have been killed on sight, in fear, and in loathing. This *has* evoked terrifying acts of retribution and magic, which contribute to the continuing myths and legends about them. This has also convinced the Desert Keepers to avoid contact with other intelligent life forms and to keep to themselves. Thus, they usually frighten away wayward travelers and intruders, and kill any who injure or slay their people. Less than a hundred Keepers of the Desert have gone forth into "the world of

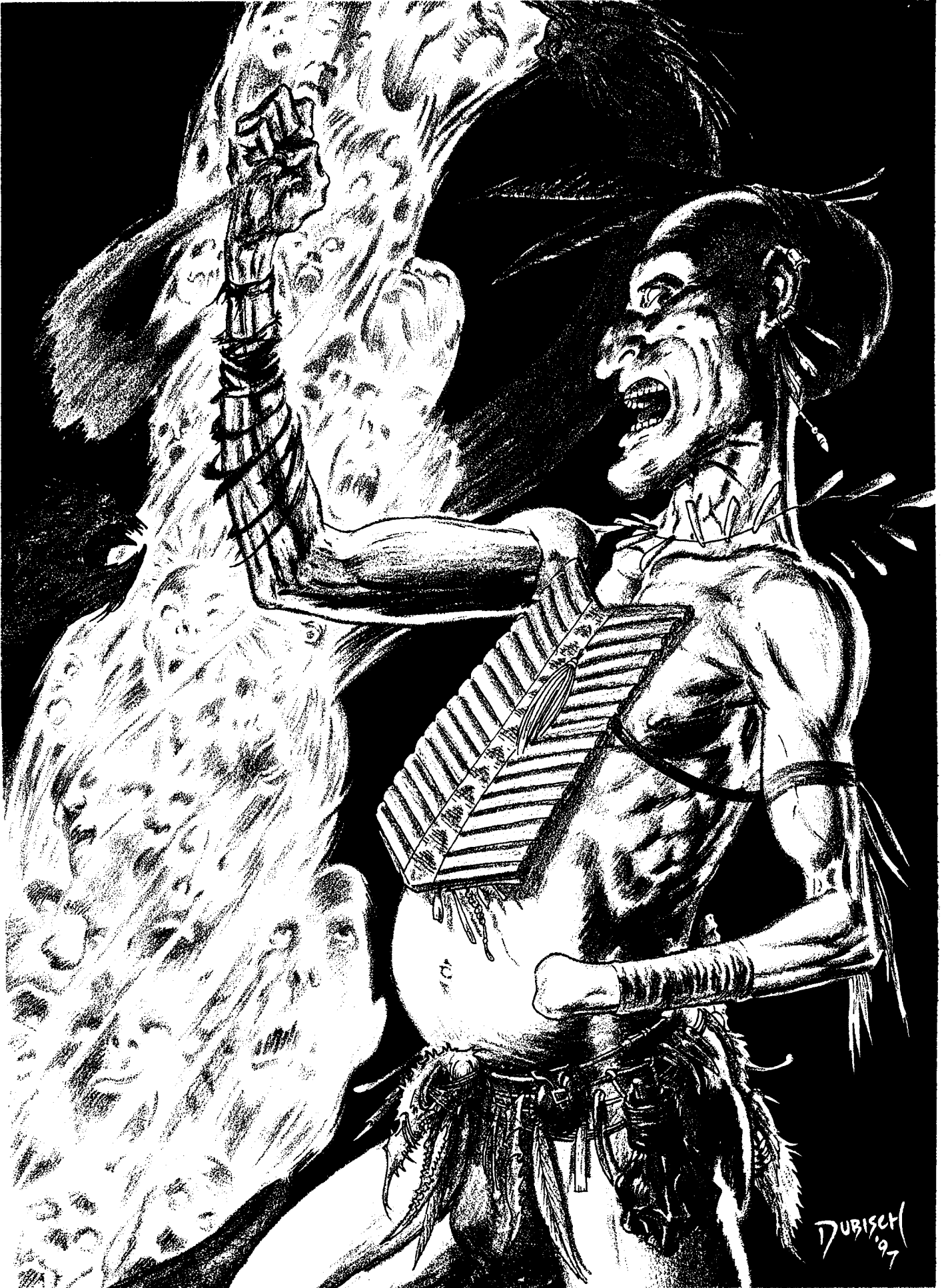

DUBISCH  
'97

men" and an estimated 4000 are believed to live in scattered, nomadic tribes (2D4×100 each) in the Salt Lake Desert.

Despite these tall tales and horror stories, there are also tales of prospectors, mercenaries and adventurers who, lost in the desert or dying of exposure, have been rescued and magically restored by mysterious saviors. A few of those rescued swear they were saved by the Keepers of the Desert and were shown great kindness, but few believe them.

The typical Keeper of the Desert wears a hooded robe or poncho, hat and scarf that covers the face. Most are close to nature, respect its power, and worship its forces. They have learned to survive in the desert and love its harsh beauty. They also protect all life in "their" desert, even humans and D-bees travelling through it, especially from wickedness, cruelty and pointless destruction. In this respect, they are somewhat like **druids**. However, their view of justice and punishment is hard, and those found to be "wicked" or "destroyers" are themselves destroyed by the Keepers of the Desert.

Although most people believe all Keepers of the Desert are ugly in both appearance and soul, the majority are not hateful of humans (fearful of them, but not hateful), do not seek vengeance for any ancient wrongs, and appreciate things of beauty.

## Keeper of the Desert NPC or Optional Player Character

**Also known as Desert Keeper, Desert Outcast and Outcast.**

**Alignment:** Any

**Attributes:** I.Q. 3D6, M.E. 3D6, M.A. 3D6, P.S. 4D6, P.P. 3D6, P.E. 3D6+6, P.B. 2D4, Spd. 3D6

**M.D.C.:** Not necessarily applicable. See random mutation chart.

**Hit Points:** Physical endurance plus 2D6 per level.

**S.D.C.:** 1D6×10 in addition to skill and O.C.C. bonuses.

**Horror Factor:** 10+1D4

**P.P.E.:** 3D4×10 +1D6 per level of experience.

**Natural Abilities:** Nightvision 600 feet (183 m), impervious to radiation, resistant to heat and fire (does half damage), sense the location of water (surface and underground) at 52% +4% per level of experience, +4 to save vs horror factor, and +5 to save vs possession. Gives off low levels of radiation that can be dangerous to others if exposed for more than a few weeks. A radiation suit or environmental body armor can contain the radiation, making the mutant safe to be around others. Also see random mutation tables.

**Combat:** As per hand to hand combat skills.

**Bonuses:** None

**Magic:** See random mutation tables for natural magic and spell casting abilities. Otherwise, Desert Keepers don't study magic.

**Psionics:** See random mutation tables.

**Vulnerabilities:** Their radioactivity means that as a rule, they cannot coexist with most races, and may accidentally cause sickness and death, just as the legends warn!

**R.C.C. Skills:** All Desert Keepers have the following skills: Wilderness survival (+40%), land navigation (+20%), astronomy (+15%), botany (desert plants only; +15%), basic math (+20%), speak American at 96%, hunting, track animals (20%), skin and prepare animal hides (+15%), preserve food (+15%), and Holistic medicine +20%, plus two W.P.s of choice and a total of five additional skills selected from the

categories of Domestic, Physical, Technical, W.P. and wilderness. **Note:** They do not ride animals or pilot vehicles.

**Habitat:** The Salt Lake Desert, but they feel comfortable in any desert.

**Average Life Span:** 40-50 years; those above 35 are considered elders.

**Enemies:** They fear most other **humanoids**, and most humans and many D-bees of the New West kill the Keepers of the Desert out of fear.

**Powers & Abilities:** The Keepers of the Desert have endured generations of magical energies and alien radiation that have altered the fiber of their being. They have become deformed and inhuman looking but have also become stronger and magically empowered. In fact, they may be considered creatures of magic. The following is a random table designed to create a Keeper of the Desert. Roll once at first level and again at levels 6 and 12. If preferred, and allowed by the G.M., a power category or two may be selected. **Note:** Whenever magic powers are available, the character has the same limitations as most sorcerers and must expend the usual amount of P.P.E. unless stated otherwise — intuitively knows the spells.

## Random Powers and Deformities

**01-07 Super Psionics.** The character has M.E. x10 in I.S.P., plus 2D4 per level of experience. Select one power from the super psionics category at levels 1, 3, 4, 6, 9, 12, and 15, and six skills of choice from the sensitive or physical category. The character's head seems to be larger and slightly bumpy or the skin and bone of the cranium is transparent so the brain can be seen; +2 to H.F.

**08-12 No Psionics but ...** for some reason or another, this character is totally devoid of psionic powers, but is strangely immune to all psionic attacks, magic illusions and possession.

**13-18 Indestructible Beauty!** The Desert Keeper is physically beautiful; add 1D6+12 to the character's **P.B.**, plus he or she is a mega-damage being with 1D6×10 M.D.C. +2D6 M.D.C. per level of experience, instead of the usual hit points and S.D.C.; H.F. does not apply, except perhaps as awe of beauty.

**19-22 Possess all fire magic spells** usually available to the Ley Line Walker. Plus the character is impervious to fire and heat, even magical and M.D. fire and plasma.

**23-26 Metamorph.** Possesses all metamorphosis spells usually available to the Ley Line Walker but at double the usual duration.

**27-30 Supernatural Speed and Reflexes.** This character has become as fast as a Juicer. He or she needs to eat 10 times the normal amount of food and drink 20 times the amount of water. The speed attribute is increased ten times and +1 attack per melee round, +2 to initiative, +1D6 to P.P. and also receives an automatic dodge.

**31-35 Teleporter.** Possesses the spell knowledge of **teleport:** lesser, **teleport:** superior and **mystic portal;** casts them at half the usual P.P.E. cost.

**36-40 Supernatural Strength.** This character is bigger and bulkier than normal: add one foot (0.3 m) to height, 2D4×10 pounds and P.S. is supernatural — punches and kicks inflict mega-damage and he can lift and carry incredible weight. Addi-

tionally the character is a minor mega-damage creature with 1D4×10 M.D.C. +1D6 M.D.C. per level of experience.

**41-45 Summoner of Nature.** Possesses all the following summoning spells: Summon and control canines, rodents, animals, fog and rain; plus cast wind rush, call lightning, float in air, and breathe without air; all at half the usual P.P.E. cost.

**46-55 Supernatural Endurance & M.D.C.** The character's skin is lumpy and leathery to the touch. All hit points and S.D.C. become M.D.C., the character never fatigues, only needs 3-4 hours of sleep a night, and is impervious to disease and radiation. Movement is impaired slightly: -2 to speed and -1 to strike, parry and dodge.

56-60 Despoiler. Can cast the following spells: Fool's gold, befuddle, energy disruption, repel animals, sickness, spoil, blind, and negate magic.

**61-65 Holy One.** Can cast the following spells: Sense evil, sense magic, exorcism, turn dead, heal wounds, cure minor disorders, cure illness, water to wine, tongues and dispel magic barriers.

**66-70 Mystic Hunter:** Has the skills: track (humanoids), intelligence, climb and prowl, all at +10%, plus the magic abilities of chameleon, levitation, magic net, swim as a fish, see the invisible, and armor of Ithan.

71-77 **Extremely Radioactive.** This character radiates extreme levels of radiation out to about 10 feet (3 m). Anybody caught within that 10 foot (3 m) radius will take 1D6 hit points of damage per hour of exposure. The character can see infrared and ultraviolet light, and can sense radioactive materials and fusion reactors, engines, etc., including those used in power armor, bots and vehicles! Sensing range is 600 feet (183 m) +100 feet (30.5 m) per level of experience.

78-83 **Camouflage and Escape.** This character is horribly disfigured and has a beauty of only 1D4 (add 2 to the H.F.). Magic abilities include the power to change color like a chameleon at will (no P.P.E. cost), to contort the body, dislocate joints without pain or injury, and is double-jointed and ambidextrous. These abilities give the character the skills of prowl (+10%) and escape (+20%), plus the ability to cast the magic spells: chameleon, shadow meld, escape, multiple image, mask of deceit, and reduce self.

**84-90 Energy Expulsion.** The character is able to shoot beams of radiation based energy from his hands and eyes. These beams are +1 to strike, combined with the character's P.P. and/or combat bonuses. Each beam does 2D6 M.D. (or 4D6 M.D. for two simultaneous beams from both hands or both eyes) and has a range of 300 feet (91 m) +100 feet (30.5 m) per level. Each single blast or dual simultaneous blast counts as one melee attack/action.

**91-95 Mega-Damage Being:** Turn hit points and S.D.C. into M.D.C. and add another 1D4×100 M.D.C.!

**96-00 Impervious to magic!** The character cannot be harmed by most types of magic, including spells, magic illusions, circles, wards, and curses. Even magic weapons and TW weapons do half damage. However, this also means beneficial magic has no effect. Also reduce the character's P.P.E. to 6D6.

# Lyn-Srial R.C.C.

By Chris Kornmann & Kevin Siembieda

The Lyn-Srial, also known as the Golden Ones, Cloudweavers and Sky-Knights, are a race of bird-like, golden skinned humanoid from a dimension far beyond the Earth — a dimension of mountains, towering bluffs, cloud cities and endless blue-green skies. They are a peaceful people who have dedicated their lives to helping others end violence and find peace as they have. **Note:** See the section on *Arizona and the Golden Ones* for more details about the Lyn-Srial people, society, goals, magic and hidden city.

Not all Lyn-Srial are Sky-Knights, Cloudweavers or adventurers, but most share the same ethics, philosophy of life and goals. Many are artists of some type and all are very creative and imaginative. Most Lyn-Srial have dedicated themselves to helping others and the pursuit of knowledge, art, beauty, and peace of mind and spirit.

## Average Lyn-Srial NPC or Optional Player Character

**Also known as Golden Ones**

**Alignment:** Any, but 80% are principled or scrupulous, 10% aberrant and 10% other. Very few Lyn-Srial ever turn to a selfish alignment and a diabolic or miscreant evil Lyn-Srial is almost unheard of.

**Attributes:** I.Q. 3D6+4, M.E. 3D6+10, M.A. 3D6+10, P.S. 3D6+6, P.P. 3D6, P.E. 3D6+4, P.B. 3D6+8, Spd 3D6+4 on the ground but 3D6+20 flying.

M.D.C.: P.E. x10 plus 1D6 per level of experience.

**Awe Factor:** 9+1D4

P.P.E.: 1D6×10+15 per level of experience.

**Height:** 7-8 feet (2.1 to 2.4 m) tall.

**Weight:** 200-320 lbs (90 to 144 kg)

**Average Life Span:** Approximately 150-200 years, although some have lived to be 350; most elders are 160 and up.

**Habitat:** Can be found anywhere in the Americas, but are most numerous in the Southwest and have a hidden city in the Grand Canyon (Arizona). They feel most at home among canyons, buttes, mountains and among the clouds up in the sky.

**Natural Abilities:** Supernatural strength and endurance, glow with the light of the sun when happy or angry, bio-regenerate 1D6 M.D.C. per hour and can regenerate lost limbs in four months time (an eye or tongue in one year), excellent hawk-like vision (can see a prairie dog up to 3 miles/4.8 km away!), nightvision 1000 feet (305 m), excellent hearing, four arms, bat-like membrane between one pair of arms provides the ability to fly and glide (glides at half flying speed), plus unique cloud magic powers (see section on *Arizona*).

**Psionics:** None.

**Magic:** All ordinary Lyn-Srial know the following spells: cloud of ascension, cloud surfing, aerial navigation, globe of daylight, and may choose one additional spell for every 3 points of I.Q. from the categories of *Clouds of Defense*, *Travel*, and *Survival*.

**Combat:** The average Lyn-Srial is not trained for combat and will shy away from violence, but has three attacks per melee round, plus those gained from optional hand to hand: basic.

**R.C.C. Bonuses:** +1 on initiative, +1 to parry, +2 to dodge when in flight, +2 to pull punch, +3 to roll with impact or fall, and +4 vs horror factor.

**R.C.C. Skills:**

History of their People at 90%  
Speak and read native language at 98%  
Speak three Earth languages (+30%)  
Literate in two Earth languages (+10%)  
Lore: Ley Lines & Magic (+10%)  
Law (+20%)  
Basic Math (+30%)  
Holistic Medicine (+10%)  
Identify Fruit and Plants (+20%)  
Wilderness Survival (+15%)  
Land Navigation (+10%)  
Sing & Whistle (professional quality; beautiful; +20%)  
Dance (professional quality; +20%)  
Art (professional quality; +20%)  
Whittle/Sculpt (+15%)

**R.C.C. Related Skills:** At first level the character can select six "other" skills, plus two additional skills at levels 3, 6, 9, and 12. All new skills start at level one proficiency.

Communications: Any (+5%)  
Cowboy: None  
Domestic: Any (+10%)  
Electrical: Any (+5%)  
Espionage: None  
Mechanical: Any (+5%)  
Medical: Any (+10%)  
Military: None  
Physical: Any, except boxing, and only Hand to Hand: Basic can be selected from the combat skills.  
Pilot: None  
Pilot Related: Read Sensory Equipment and Navigation only.  
Rogue: Ventriloquism and Computer Hacking only.  
Science: Any (+15%)  
Technical: Any (+15%)  
W.P.: Any W.P. Ancient, and W.P. Energy Pistol and Rifle only.  
Wilderness: Any (+5%)

**Secondary Skills:** The character gets two secondary skills from the list above, excluding those marked "None," at levels 1, 4, 8, 10, and 12. These are additional areas of knowledge that do not get the advantage of the bonus listed in parentheses. All secondary skills start at the base skill level.

**Standard Equipment:** Personal jewelry (arm bands, bracelets, necklaces, mantles, and similar), loin cloth, pocket mirror, sculpting tools, whittling knife, utility belt, backpack, purse, air filter, and canteen or water skin. Weapons: None.

**Additional Equipment:** Must be acquired later; never use a vehicle or riding animal.

**Money:** Starts with 2D6x100 credits worth of tradeable goods; has no need for Universal credits.

**Cybernetics:** Avoids them; can bio-regenerate.

**Note:** 55% of all Lyn-Srial females become Cloudweavers.



## Lyn-Srial Sky-Knight R.C.C.

The Sky-Knight is the Lyn-Srial warrior for peace. These noble fighters battle only to protect others, destroy evil (and the supernatural) and to bring justice and wisdom to the people of the world in the pursuit of peace. In many ways they are philosopher knights who try to instill values and morals in all they meet, and strive to be living examples of what can be achieved through friendship, brotherhood, and love. They are often seen as avenging angels or warriors of light who fight for the innocent and the underdog. They stand against evil in all its forms, and thus, while they try to show respect and understanding to all people, religions and nations, will stand against any if they know them to be evil or crush the people's spirits.

All Sky-Knights are accomplished magic users and will use magic to avoid or dissuade combat before using force to finish a fight. They are courageous in battle and tender in life. They truly are the personification of the ideal represented by the word "knight."

### Sky-Knight NPC and Optional Player Character

**Also known as the Philosopher Knight, Golden One and Hope Bringer.**

**Attribute Requirements:** I.Q. and M.E. of at least 18.

**Alignment, attributes and all basic stats** are the same as the "Average" Golden One. Magic, skills, bonuses, and equipment are as follows.

**Magic:** The Sky-Knight knows cloud of ascension, cloud surfing, aerial navigation, globe of daylight, Storm Rider Armor

and *all* Clouds of War and Clouds of Peace. In addition, the Sky Knight can choose one additional spell every level of experience, starting with level one, from any category except *Clouds of Creation*.

**Combat:** Four attacks per melee round, plus those gained from hand to hand combat.

**R.C.C. Bonuses (in addition to skill and attribute bonuses):**

+1D6 to P.S., +2D6 to M.D.C., +1D4×10 to P.P.E., +3 on initiative, +1 to parry, +2 to dodge when in flight, +4 to roll with impact or fall, +4 to pull punch, +3 to disarm on a "called" shot, and +1 to save vs Horror Factor at levels 1, 3, 4, 5, 7, 8, 9, 11, 12, 13, and 15. **R.C.C. Skills:**

History of their People at 90%

Speak and read native language at 98%

Speak three Earth languages (+30%)

Literate in two Earth languages (+10%)

Lore: One of Choice (+10%)

Law (+20%)

Basic Math (+30%)

Wilderness Survival (+15%)

Land Navigation (+20%)

Sing & Whistle (professional quality; beautiful; +15%)

Dance (professional quality; +20%)

Art (professional quality; +15%)

Whittle/Sculpt (+15%)

W.P. Blunt

W.P. Paired Weapons

W.P. Ancient Weapon of choice

W.P. Energy Weapon of choice.

Hand to Hand: Expert

Hand to hand: expert can be changed to hand to hand: martial arts for the cost of one R.C.C. Related Skill.

**R.C.C. Related Skills:** At first level the character can select five "other" skills, plus two additional skills at levels 3, 6, 9, and 12. All new skills start at level one proficiency.

Communications: Any (+10%)

Cowboy: None

Domestic: Any (+10%)

Electrical: Basic only (+5%)

Espionage: Intelligence and Tracking only (+10%).

Mechanical: Basic only (+5%)

Medical: Any (+10%)

Military: Any (+5%), except Trap skills, Parachuting, and Nuclear, etc., Warfare.

Physical: Any, except boxing.

Pilot: None

Pilot Related: Read Sensory Equipment & Navigation only (+10%) Rogue: Ventriloquism, Streetwise, and Computer Hacking only.

Science: Any (+10%)

Technical: Any (+15%)

W.P.: Any

Wilderness: Any (+10%)

**Secondary Skills:** The character gets two secondary skills from the list above, excluding those marked "None," at levels 1, 4, 8, 10, and 12. These are additional areas of knowledge that do not get the advantage of the bonus listed in parentheses. All secondary skills start at the base skill level.

**Standard Equipment:** Personal jewelry (arm bands, vambraces, bracelets, necklaces, mantles, and similar), the Sky-Knight's

golden chest plate (25 M.D.C.; more symbolic than functional), chain mail loin cloth, pocket mirror, whittling knife, large wooden cross, 12 wooden stakes, utility belt, backpack, air filter, and two canteens.

Weapons should reflect the character's W.P.; one for each, plus a pair of one type (typically blunt or other ancient weapon).

**Additional Equipment:** Must be acquired later; rarely use a vehicle or riding animal.

**Money:** Starts with 3D6×100 credits worth of tradeable goods; has no need for Universal credits.

**Cybernetics:** Avoids them; can bio-regenerate.

## Lyn-Srial Cloudweaver R.C.C.

Cloudweavers are Lyn-Srial women (55%) and men who have become very adept at the casting and understanding of Cloud Magic. They are highly prized members of the Golden Ones' society and are treated like nobility or high priests. Most Cloudweavers spend decades developing their skills and learning the theories and history of magic and Cloudweaving. The average Cloudweaver is not a warrior and tends to stay close to the city of Tryth-Sal. They serve as historians, philosophers, healers, diplomats and wise men (half the members on the Council of Elders are Cloudweavers). Occasionally, Cloudweavers may be sent into the wilderness to accompany a group of Sky-Knights or to advise or help others in need.

### Lyn-Srial Cloudweaver NPC or

#### Optional Player Character

**Also known as the Wise One and Golden Creator.**

**Attribute Requirements:** I.Q., M.A. and M.E. of at least 18.

**Alignment, attributes and all basic stats** are the same as the "Average" Golden One. Magic, skills, bonuses, and equipment are as follows.

**Combat:** The Cloudweaver is not trained for combat and will shy away from violence, but has three attacks per melee round, plus those gained from optional hand to hand (if any).

**Magic:** The Cloudweaver knows *all* Clouds of Defense, Travel and Creation. In addition, the Wise One selects two additional Cloud spells for every level of experience, starting with level one, from any category except *Clouds of War*.

**R.C.C. Bonuses:** +2D4×10 P.P.E., +2 on initiative, +1 to parry, +2 to dodge when in flight, +3 to pull punch, +2 to roll with impact or fall, impervious to horror factor and possession.

**R.C.C. Skills:**

History of their People at 98%

Speak and read native language at 98%

Speak three Earth languages at 98%

Literate in the same Earth languages (+20%)

Lore: Ley Lines & Magic (+15%)

Lore: Two of choice (+15%)

Law (+20%)

Basic Math (+30%)

Holistic Medicine (+20%)

Identify Fruit and Plants (+20%)

Wilderness Survival (+15%)

Land Navigation (+10%)

Sing & Whistle (professional quality; beautiful; +15%)

Dance (professional quality; +15%)

Art (professional quality; +20%)



Write (professional quality; +20%)

**R.C.C. Related Skills:** At first level the character can select six "other" skills, plus two additional skills at levels 3, 6, 9, and 12. All new skills start at level one proficiency.

Communications: Any (+5%)

Cowboy: None

Domestic: Any (+10%)

Electrical: Any (+5%)

Espionage: None

Mechanical: Any (+5%)

Medical: Any (+15%)

Military: None

Physical: Any, except boxing and wrestling, and only Hand to Hand: Basic can be selected from the combat skills.

Pilot: None

Pilot Related: Read Sensory Equipment and Navigation only.

Rogue: None

Science: Any (+20%)

Technical: Any (+15%)

W.P.: Any W.P. Ancient only.

Wilderness: Any (+5%)

**Secondary Skills:** The character gets two secondary skills from the list above, excluding those marked "None," at levels 1, 4, 8, 10, and 12. These are additional areas of knowledge that do not get the advantage of the bonus listed in parentheses. All secondary skills start at the base skill level.

**Standard Equipment:** Personal jewelry (arm bands, bracelets, necklaces, mantles, and similar), loin cloth, pocket mirror, utility belt, backpack, purse, air filter, and a canteen. Weapons: None.

**Additional Equipment:** Must be acquired later; never uses a vehicle or riding animal.

**Money:** Starts with 2D6×100 credits worth of tradeable goods; has no need for Universal credits unless an adventurer.

---

## Mountain Giants

---

Mountain Giants are hulking, musclebound behemoths that, according to some rumors and speculation, are the creation of Doctor Desmond Bradford at the Lone Star Genetics Complex in an attempt to bring out humankind's primal instincts and power. If this is true, the experiment was a success on some level, because Mountain Giants are savage, primal hunters — "a cross between a raging bull and an insane lion," reported one onlooker of a battle involving three of the giants against nine CS soldiers.

Mountain Giants are easily provoked and always fight with unrestrained ferocity. They enjoy conflict and are utterly ruthless in combat. Most matters are black and white for these human(?) mutants: kill or be killed, hunt or starve, etc. They have been known to literally tear a person apart, limb from limb, for startling them or for walking in on their lair — these brutes regard any intrusion of their lair (including a temporary refuge and even prison cell) as an act of aggression and respond accordingly. If they are (or were) human, they are also cannibals, because most Mountain Giants eat whatever they kill, whether it be an animal or a human. On the field of combat, where satisfying one's hunger is not the issue, the brutes will eat part of their opponents, a symbolic gesture of devouring one's foes.

Despite their aggressive and merciless nature, the terrifying giants are astonishingly gentle and protective of children, not only their own young, but any child, as well as baby animals. Stories of Mountain Giants appearing out of nowhere or fighting to their own death to save a child from a bear, wolves, monsters, bandits, mud slide, drowning, etc., are surprisingly numerous. The giants also love canines and often breed dogs with wolves and use them as hunting companions and pets. This affection for dogs extends to mutant "Dog Boys," one of the very few intelligent beings that Mountain Giants don't attack on sight, and often befriend (and another reason some believe the giants are the creation of Lone Star).

According to Indians, Mountain Giants are also said to see spirits and will not hurt Indian Shamans, Indian Mystics or the mentally retarded. The giants sometimes associate with Brodkill and like Simvan (probably because they can control animals). Mountain Giants have only appeared in the last 15 years. There are less than 100 believed to inhabit the Rocky Mountains and perhaps another 200-300 inhabiting the mountains and bluffs of The Bend in Lone Star. They are occasionally found elsewhere, but are usually found in the mountains, hence their name.

### Mountain Giant —

#### Optional Player Character & NPC

**Also known as the "Man Mountain" or "Mountain Behemoth."**

**Alignment:** Any

**Horror Factor:** 10+1D4.

**Average Size:** 10-12 feet (3 to 3.6 m)

**Weight:** 600 to 800 pounds (270 to 360 kg)

**Attributes:** I.Q. 2D6+2, M.E. 2D6+4, M.A. 2D6+4, P.S. 4D6+20, P.P. 2D6+8, P.E. 2D6+10, P.B. 3D4, Spd. 2D6+10; supernatural P.S. and P.E.

**P.P.E.:** 2D6

**Mega-Damage:** P.E. attribute number times two, plus 2D6 per level of experience, starting at level one.

**Natural Abilities:** Keen vision, see infrared spectrum of light, +2 to save vs disease and toxins, and impervious to carcinogens.

**Psionics:** Major psionic: Base I.S.P.: M.E. +2D6 per level of experience. Powers are limited to see aura, see the invisible, impervious to fire, impervious to cold, impervious to poison and nightvision.

**R.C.C. Bonuses:** +2 on initiative, +2 to strike, pin/incapacitate on a roll of 17-20 (must announce that this is the character's intention), critical strike from behind/surprise attack, body flip, +3 to roll with punch, fall or impact, and +5 to save vs Horror Factor. Bite does 2D6 M.D.

**Combat: Attacks per melee round:** Three at first level and +1 at levels 4, 7, 9, 12, and 15.

**R.C.C. Skills:**

Speak American and Gobblely at 70%

Wilderness Survival (+15%)

Land Navigation (+15%)

Track Animals (+20%)

Track Humanoids (+10%)

Skin & Prepare Animal (and Humanoid)Hides (+10%)

General Athletics

Wrestling

Climb (+15%)



Swim (+15%)  
 Prowl (+5%)  
 Hand to Hand: See combat above  
 W.P.: Blunt  
 W.P.: Ancient, two of choice

**R.C.C. Related Skills:** At first level the character can select four "other" skills. Rarely study new skills later, other than secondary.

Communications: Radio: Basic only.  
 Cowboy: None  
 Domestic: Any  
 Electrical: None  
 Espionage: Detect Ambush and Concealment only.  
 Mechanical: None  
 Medical: Brewing only (+5%)  
 Military: None  
 Physical: Any, except Boxing, Acrobatics & Hand to Hand Combat  
 Pilot: None  
 Pilot Related: None

Rogue: None  
 Science: None  
 Technical: Any  
 W.P.: Any  
 Wilderness: Any (+5%)

**Secondary Skills:** The character gets one secondary skill from the list above, excluding those marked "None," at levels 1, 4, 8, 10, and 12. These are additional areas of knowledge that do not get the advantage of the bonus listed in parentheses. All secondary skills start at the base skill level.

**Standard Equipment:** War Club 1D6 M.D. plus supernatural P.S. damage, lion cloth, fur cloak, necklace and/or belt made of skulls, teeth, or claws, knife, 50 feet (15.2 m) of rope, a large sack, a small sack, belt, and water skin. They love Vibro-Blades and giant-sized hand weapons.

**Allies:** Associate with Brodkil, Simvan and Dog Boys, sometimes with other powerful beings, provided they don't try to (obviously) control or enslave the giants.

**Enemies:** Don't trust or like humans and most other life forms.

# Monsters Common to the New West

By Kevin Siembieda & Chris Kornmann

Desert Sleepers	Great Plains Buffalo	Moss-Back Scuttler	Psi-Ponies	Tree Spiders
Devil Unicorn	Grigleapers	Oborus-Slithers	Rhino-Buffero	Tri-Tops
Duckbilled Honkers	Gwylack	Ostrosaurus	Silonar	Tyrannosaurus Rex
Giant Canyon Worms	Leatherwing	Panthera-Tereon	Scorpions & Snakes	Whisker Coyote
Great Dream Snakes	Mammoth Brontodon	Phantasm	Tiger Claw Raptor	Worm Wraith

**A note about dinosaurs.** The American continents have been repopulated with a variety of dinosaurs or alien equivalents. True dinosaurs have been Rifted through time into the modern day, while dinosaur-like creatures from other worlds have arrived through dimensional Rifts, sometimes random openings and other times by the deliberate attempts of Shifters and other sorcerers to summon a terrible monster. Predators are among the most common, because there are a number of large and varied prey to feed on, including humanoids! Many of the most notable dinosaurs and dinosaur-like creatures are described in the following pages, and include:

Desert Sleepers	Panthera-Tereon
Duckbilled Honkers	Rhino-Buffero
Leatherwing	Silonar
Mammoth Brontodon	Tiger Claw Raptor
Moss-Back Scuttler	Tri-Tops
Ostrosaurus	Tyrannosaurus Rex

## Desert Sleepers

The Desert Sleepers get their name from the fact that they bury themselves under the sand at night and when hiding from predators. They are two-legged, warm-blooded, theropod dinosaur-like creatures about twice the size of a human with powerful ostrich-like legs for running and leaping, small arms and two-fingered claws for picking up and carrying eggs and scraps of meat, as well as to help dig in the sand. The tops of their heads are armor plated as is their entire spine. This armor plating offers additional protection while sleeping and, if they cannot escape a foe by outrunning him, the Desert Sleeper will curl up in a ball like an armadillo and hope that his attacker will grow frustrated and leave when it cannot penetrate its armor. This defense tactic is effective against most animal predators, but makes it easy for humanoids to hunt and kill them. The animal's skin is sand colored, with the top body plates being a darker shade of brown or grayish brown.



Desert Sleepers prey on small animals, including snakes, lizards, rodents and birds, as well as reptile and birds' eggs and carrion. Although they may eat the carcass of a dead humanoid, they *never* attack them, even when humanoids attack them first — the animals try to run away and fight only to escape.

### Desert Sleeper NPC Animal/Monster

**Alignment:** Considered anarchist.

**Attributes:** Animal attributes are very consistent and offer a smaller range of attribute aptitude. I.Q. Low animal intelligence, M.E. 1D6, M.A. 2D6, P.S. 20+1D6, P.P. 15+1D6, P.E. 18+1D6, P.B. 2D6+3, Spd 34+4D6; a minimum speed of 38 (26 mph/41.6 km), most have a speed of 44 to 55.

#### Mega-Damage by Location:

- \* Plated Head — 100
- \* Small Arms (2) — 15 each
- \* Hind Legs (2) — 50 each
- \* Underbelly — 80

Main Body: Spine/Back or when curled into a ball — 100+2D6×10 M.D.C. on Rifts Earth (2D4×10 Hit Points/H.P. and 2D6×10 S.D.C. with an A.R. 16 on S.D.C. worlds).

\* A single astensk means a small or difficult target to hit and requires a "called shot" at -2 to strike.

**Horror Factor:** None

**Size:** 10 to 11 feet (3 to 3.3 m) from head to tail, about 6 feet (1.8 m) at the shoulders.

**Weight:** 600-800 pounds (270 to 360 kg)

**Average Life Span:** 50 years.

P.P.E.: 2D6

O.C.C.: None; animal.

**Natural Abilities:** Excellent speed, can run without pause and without exhaustion for six hours, and leap up to 20 ft (6 m) lengthwise and 12 ft (3.6 m) high. Can go without food or water for eight weeks without ill effect (lives off the fat and water stored in their tail), eats small animals and carrion, and can track the scent of decay 55%.

**R.C.C. Combat: Attacks/Actions Per Melee:** Four

**Damage:** Clawed hind legs do 2D4 M.D., bite does 2D6 S.D.C., tail slash 2D6 S.D.C. plus P.S. bonus, small fore claws 2D6 S.D.C. plus P.S. bonus, head butt 2D6 S.D.C. and running head butt/ram 1D6×10 S.D.C. plus human-sized opponents are knocked 2D8 yards.

**R.C.C. Bonuses:** +2 on initiative, +1 to strike, +2 to dodge, +4 leaping dodge, +3 to roll with impact or fall, +6 to save vs disease and poison and +2 to save vs horror factor. These are all in addition to any possible attribute bonuses.

**Magic:** None

**Psionics:** None

**Enemies:** Large predators, pack hunters (including Silonar) and humanoids.

**Allies:** None

**Value:** 300-600 credits per animal. The meat of Desert Sleepers is good tasting and their natural armor plating can be used to make (nonenvironmental) body armor. They make poor riding animals (-20% to riding skill) and only Simvan and Psi-Stalkers can ride them.

**Habitat:** Deserts and grasslands of all kind. The dinosaur-like animal cannot survive in climates cooler than 40 degrees Fahrenheit. They are insulated during cold desert nights by curling into a ball and burying themselves; 3D4 days of *con-*

stant cold temperatures will kill the beast. On Rifts Earth, Desert Sleepers are most commonly found west of the Rocky Mountains: Nevada, Utah, Arizona, the deserts of California, and Northern Mexico, as well as southwestern Texas/Lone Star.



## Devil Unicorn

Many consider it a demon, but whether or not it is a true demon or a powerful, vicious and cruel animal is unclear. The abomination gets its name from its long, single horn, demonic looks and hellish laugh. Devil Unicorns have a deep, rasping and maniacal laugh that is often heard in the distance as the fiend stalks his prey, as well as during combat (as long as it thinks it can win) and when it tortures captives. The horn is used to butt and stab and is especially lethal against large prey, but the monster's wicked claws and slashing tail are what humanoidshave to worry about.

The Devil Unicorn is a hideous and terrifying supernatural monster from the Rifts. Its body is thick with muscles, and the top of its head, its spine and tail are protected by thick ridges of bone. The Devil Unicorn has a low human intelligence and can actually speak broken American in a low, guttural voice and rasping whisper — usually accompanied by raspy growls, heavy breathing and its demonic laugh. As a predator, it is incredibly cunning, tricky and kills for pleasure as well as for food. In fact, a Devil Unicorn looks to maim and hold 1D6 prey captive in its

lair where it engages in mental and physical torture. Mental torture includes intimidation, pretense to torture or kill, pretending to let a captive escape (only to be pounced upon or hunted down and returned), and similar. Physical torture includes being pricked, stabbed and lacerated by its mandibles or claw, nips and bites, battery, broken bones, and maiming. Devil Unicorns love to abduct and torture their captives, slaughter cattle, and torment people (often terrorizing an entire town or region), almost as much as they love to fight and kill. Black hearted in the extreme, these Devilish beasts will deliberately slaughter animals, from pets to livestock, without taking a bite to eat; kidnap women and children, kill children, women, preachers and so-called protectors and leave them gutted and displayed for all to see (spread-eagle, impaled on a tree or fence, or hung from a pole, tree or rafters), and steal or destroy things people hold of value, including shrines, churches, hospitals, generators, important vehicles and equipment, etc. Fortunately, Devil Unicorns usually live and hunt alone or in small groups of 2-4; they don't care for their own kind, see each other as rivals and constantly fight amongst themselves.

## Devil Unicorn

**Alignment:** Always miscreant or diabolic.

**Attributes:** I.Q. Low human intelligence and a cunning predator: 1D4+4, M.E. 18 +1D6, M.A. 1D6, P.S. 30+3D6, P.P. 18+1D6, P.E. 20+2D6, P.B. 1D4, Spd 14+4D6; a minimum speed of 22 (15 mph/24 km); supernatural P.S. and P.E.

**M.D.C. by Location:**

Horn (1) — 100

Head — 100

Front Legs (2) — 140 each

Rear Legs (2) — 190 each

Tail (1) — 220

Main Body — 200 +1D6×100 on Rifts Earth (1D4×100 H.P. and 1D4×100 S.D.C. with an A.R. 17 on S.D.C. worlds).

**Horror Factor:** 15

**Size:** 5 feet (1.5 m) at the shoulders, 12-14 feet (3.6 to 4.3 m) long from the point of its muzzle to its hindquarters, plus another 10-12 feet (3 to 3.6 m) for its tail.

**Weight:** 1.4 to 2 tons!

**Average Life Span:** 150 years.

P.P.E.: 6D6

O.C.C.: None; animal; see natural abilities.

**Natural Abilities:** Fair speed, can run without pause and without exhaustion for two hours, leap up to 30 ft (9 m) lengthwise and 20 ft (6 m) high, loves to swim (swim skill equivalent 90%), can hold its breath for 6+1D6 minutes, survive depths of up to 400 feet (122 m), climb 90%/80%, prowl 60%, track humanoids (using sense of smell and vision) 78% (60% to track animals), land navigation 80%, and wilderness survival 95%.

**R.C.C. Skills:** Can learn to speak three languages at the base skill level plus 6D6%, and knows a total of 1D4+2 skills limited to selections from rogue, technical, and wilderness. Does not advance in experience.

**R.C.C. Combat: Attacks Per Melee:** Five

**Damage:** Tiny mandibles 1D6 to 4D6 S.D.C. depending on the amount of damage it desires to inflict, a biting nip 6D6 S.D.C. to 1D4 M.D., bite 2D4 M.D., restrained strike 5D6 S.D.C., full strength clawed strike 4D6 M.D. (minimum), power strike 1D4×10 M.D. (minimum), tail slash 1D4×10 M.D., horn/head butt 1D6 M.D., horn stab 3D6 M.D., pounce attack 2D4 M.D. plus a 01-74% likelihood of prey being pinned and helpless. After a successful pounce attack, the Devil Unicorn can claw with all four legs, inflicting a massive 2D4×10 M.D.!

**R.C.C. Bonuses:** +3 on initiative, +3 to strike, +1 to parry, +3 to dodge, +6 to pull punch, +4 to roll with impact or fall, +3 to save vs psionic attack and possession, +12 to save vs horror factor—fearless. These are all in addition to any possible attribute bonuses.

**Magic:** None

**Psionics:** None

**Enemies:** Large predators and humanoids.

**Allies:** Occasionally allies itself with others of its kind, powerful practitioners of magic, and other powerful beings with agendas that involve mass murder, torture and mayhem.

**Value:** None

**Habitat:** Only a few hundred to a thousand are believed to exist on the American continents but can be found in any environment. They prefer wooded areas with lakes and waterways

near a people they can torment, and enjoy mountains. Devil Unicorns are most commonly reported in the Canadian Southwest, the American Northwest, Wyoming, Colorado, Wisconsin, Michigan and the Magic Zone.

---

## Duckbilled Honkers

---

Whether these are Duckbilled (*Hypacrosaurus*?) dinosaurs from Earth's past or similar creatures from another world is unknown. They are large, herbivores with a large flat, bill-like muzzle with large, flat teeth in the lower jaw for grinding and chewing vegetation; namely the conifer trees, pine cones, acorns, oak tree leaves, berries, ferns and various other plants found in mixed forests. The Duckbills travel in herds of 20-80 to 100-600 animals. They are preyed upon by large predators of all kinds and have come to be herded like cattle by some Indians and ranchers in the west.

Duckbills rarely fight unless panicked, backed into a corner and attacked, or to defend its nest or young. Generally they ignore small, unmounted humanoids, and run away from danger whenever they can. They are called "honkers" because they make loud honking sounds like geese with a loudspeaker.

### Duckbilled Honker NPC Animal/Monster

**Alignment:** Considered anarchist.

**Attributes:** Animal attributes are very consistent and offer a smaller range of attribute aptitude. I.Q. Low animal intelligence, M.E. 1D6, M.A. 2D6, P.S. 20+1D6, P.P. 14+1D6, P.E. 18+1D6, P.B. 2D6+3, Spd 34+3D6; a minimum speed of 38 (26 mph/41.6 km), most have a speed of 40 to 44 (about 30 mph/48 km).

**Mega-Damage by Location:**

\* Head — 100

\* Small Arms (2) — 20 each

\* Hind Legs (2) — 130 each

\* Underbelly — 120

Main Body — 100+1D4×100 (6D6×10 H.P. and 4D6×10 S.D.C. with an A.R. 13 on S.D.C. worlds).

\* A single asterisk means a small or difficult target to hit and requires a "called shot" at -1 to strike.

**Horror Factor:** None

**Size:** 20-30 feet (6 to 9 m) from head to tail, about 18-20 feet (5.4 to 6 m) standing erect.

**Weight:** 2-3.2 tons

**Average Life Span:** 30 years.

P.P.E.: 4D6

O.C.C.: None; animal.

**Natural Abilities:** Excellent speed, can run without pause and without exhaustion for four hours, leap up to 8 ft (2.4 m) long or high, like water (can swim equal to the swim skill at 70%), hold breath underwater for 1D4+3 minutes, and although constantly eating, can go without food or water for up to six weeks without ill effect.

**R.C.C. Combat: Attacks/Actions Per Melee:** Three

**Damage:** Clawed hind legs do 2D6 M.D., tail slash 2D6 M.D., bite does 4D6 S.D.C., small fore claws 3D6 S.D.C. plus P.S. bonus, head or beak butt 3D6 S.D.C.

**R.C.C. Bonuses:** +1 to strike, +2 to dodge, +4 leaping dodge,



+3 to roll with impact or fall, +6 to save vs disease and poison and +2 to save vs horror factor. These are all in addition to any possible attribute bonuses.

**Magic:** None

**Psionics:** None

**Enemies:** Large predators, pack hunters (including *Silonar* and *Raptors*) and humanoids.

**Allies:** None

**Value:** 900-2000 credits per animal. The meat of the Duckbill is good tasting, although fatty, and oil extracted from the animal is used in a variety of products, including lamp oil, and the hide can be used to make a light M.D.C. fabric (poncho or overcoat has 8 M.D.C., overcoat with extra armor padding 12-16 M.D.C., or tent with 15 M.D.C.). They are impossible (and uncomfortable) to ride or domesticate except by *Simvan* and *Psi-Stalkers* (-10% on riding skill).

**Habitat:** Woodlands and scrub plains. Over a million are believed to be scattered between the Rocky Mountains and the Mississippi River in the Central states, including parts of Texas/Lone Star. Since they like water, they have slipped over the river and can also be found in the east (mainly the southern territories), but in much fewer numbers. It is mostly the cold and snowy winters that keep them out of Canada and the northeast, although small herds will migrate to the northern forests in the summer and to the south in the winter. In the west, Duckbills are found in greatest numbers in Oregon, eastern Wyoming, Nebraska, Missouri, Kansas, Oklahoma, and Arkansas.

---

## Giant Canyon Worms

---

Giant Canyon Worms are huge worm-like creatures from an alien world. They inhabit the canyons, buttes and plateaus of *Arizona*, *Utah*, and the deserts of *Mexico*, and are occasionally found in *New Mexico* and *Nevada*. These giants are scavengers who feed on the carcasses of the dead. When pickings are slim, they will eat garbage and may attack wounded, crippled or sick animals and *humanoids* — sometimes even attacking people in their sleep! The front of the Giant Canyon Worm's head is thicker than its tapered tail, and opens to reveal a comparatively small mouth. The mouth resembles the large, wide saw-teeth of a Jack-O-Lantern and clamps down on its prey like a steel trap. The giant worm-thing then rears its head and shakes its prey in an attempt to tear off big hunks or an appendage, and swallow it. Failing that, the worm will pound its prize into the ground until it knocks pieces loose — remember, the worm is used to feeding on carrion which usually falls apart or spills forth gore with a few shakes or slams into the ground. If by chance, the Giant Worm has (often inadvertently) latched on to live prey, it will shake and pound the prey into the ground in an attempt to kill it and then feed on it after it stops moving by tearing and ripping out large chunks. These carrion feeders have an astonishing sense of smell and can detect the odor of blood, gore or rotting flesh up to four miles (6.4 km) away. They can also smell the chemical slobber released by other Giant Canyon Worms when they feed. Smelling the slobber of another worm(s) tells the giant that others are feeding and will send him running (well, crawling) to join in. This means 1D4+2 other Giant Canyon Worms are likely to join in a feast in a matter of 2D4 minutes.

Once feeding has begun, the worms fall into a feeding frenzy and become oblivious to everything around them. They can afford to be oblivious to danger because their hides are tough, thick and lined with as much as a foot (0.3 m) of blubber which stores water and fluids for survival in the baking plains, canyons and deserts they inhabit. In addition, their hides are covered in interlocking cylinders of natural mega-damage armor. These elements combined with their large size (and foul taste), make them undesirable prey for most predators (just too much trouble for lousy tasting food). They have no eyes and rely almost entirely on the sense of smell and the ability to sense/feel vibration and sound.

At night, in cold weather, or when threatened by a persistent antagonist, the Giant Canyon Worms burrow underground. Yet despite their ability to burrow, the creatures prefer to crawl on the surface and bask in the hot sun.

**Note:** Giant Canyon Worms have become a favorite at rodeos as monstrous bucking and slamming broncos!



### Giant Canyon Worm NPC Monster

**Alignment:** Considered anarchist or miscreant.

**Attributes:** Animal attributes are very consistent and offer a smaller range of attribute variation. I.Q. Very low animal intelligence, M.E. 1D6, M.A. 1D6, P.S. 24+1D6, P.P. 12+1D6, P.E. 20+1D6, P.B. 1D6, Spd 12+12; digging speed is half.

M.D.C.: Main Body: 3D6x10+30 (2D6x10 H.P. and 1D6x10 S.D.C. with an A.R. 16 on S.D.C. worlds).

**Horror Factor:** 13

**P.P.E.:** 1D6

**Size:** 25 to 40 feet (7.6 to 12.2 m) long.

**Weight:** 4-12 tons!

**Average Life Span:** Estimated to be 20 years.

O.C.C.: None; animal.



**Natural Abilities:** Can detect the odor of blood, gore or rotting flesh up to four miles (6.4 km) away, track by smell 90%, track by sound 70%, **track/follow** vibrations 70%, good crawling speed, dig, live without water or food (live on their blubber) for up to eight months, and hibernate for up to eight months. The worms can eat just about anything from carrion and weeks old garbage to fresh fruit, vegetables, grain and just about any organic substance, including human flesh. Heat and fire does half damage; needs a hot, arid climate to live. Cold does double damage.

**Attacks Per Melee:** Three

**Damage:** Bite does 1D6 M.D., tail slash 3D6 M.D., head butt 2D6 M.D., body slam 2D6 M.D., shaking attack 1D4 M.D.; pounding attack 2D4 M.D.

**Bonuses:** +2 to strike, +1 to parry and dodge, +3 to save vs psionic attack, +6 to save vs disease, +6 to save vs horror factor and impervious to poison. These are all in addition to any possible attribute bonuses.

**Magic:** None

**Psionics:** None

**Enemies:** Huge predators and humanoids.

**Allies:** None

**Value:** None to most people, although Indians, Simvan and a few others use their armored hides to make M.D.C. body armor (60 M.D.C. for plate armor) and use the blubber to make lamp oil. The meat is sometimes used to make dog food.

**Habitat:** Hot, dry deserts and arid land; primarily Arizona, Utah and Mexico. An estimated 250,000 of these worms are believed to inhabit these territories, especially in the canyons, but the numbers could be two or three times higher!

---

## Great Dream Snakes

By Chris Kornmann & Kevin Siembieda

---

All across the New West there are stories of powerful, god-like creatures known as the Great Dream Snakes. The legends say that the Dream Snakes are rattlesnake gods with immense magical power, and that whoever is able to capture one will be able to force it to return the world to the way it should be. To this day, no one has ever captured a Dream Snake, although there are those who claim to have seen them. Those who make such claims tell of feats of great magic or endless hours of conversation on all manner of subjects. Others tell of the creature's violent wrath when angered or challenged. The only thing the legends have in common is that the Dream Snake is always an intelligent, magical rattlesnake as thick as a man and 100 feet (30.5 m) long.

One of the most famous stories tells how an Indian Shaman, four braves, an elder Lyn-Srial Cloudweaver, a powerful Cyber-Knight and a Preacher — philosophers, heroes and wise men all — spent years searching for the Great Dream Snake in hopes of convincing it to use its powers to restore the world. When they finally found him on a mountain top in New Mexico, they implored the serpent to return the world to the way it was before the Great Cataclysm. This led to a philosophical discussion regarding the pros and cons of such an action and how it would impact the Megaverse. After four days of discussion without

sleep, food or pause, the Preacher jumped to his feet and accused the Great Dream Snake of being a liar and the embodiment of Lucifer himself! The Snake reared up angrily to strike the man of god dead. Only the knight standing in his defense gave the snake pause. The Indian shaman explained in a calm and respectful voice that they were all hot, hungry, tired, and frustrated. He begged for the Great Dream Snake to put away his anger and forgive these words spoken in exhaustion. The serpent smiled and coiled itself around the group, saying that it often forgets the "frailty of men." The shaman nodded and the Preacher, now humbled, asked, "It is beyond our reasoning O' Great Serpent, that if it is in your power to put right all that has happened, why then don't you?" The snake's smile widened, "Because, O' frail man, I like what I see;" and with those words the snake began to devour them all, starting with the knight. One of the Indian warriors leapt on the serpent's head in an effort to save his companions and struck it in the eye with his totem weapon. With but one fling of its head, the great serpent shook him off like a dog would a flea. It was only fate that the warrior was hurled to a nearby river, whose rapids grabbed and carried him from the monster's wrath. It was he who first recounted the terrible saga, 150 years ago.

Throughout the New West the legend of the Great Dream Snakes has cultivated a following of snake chasers, worshipers and cults. Thousands of desperate people seek out or worship the snake for salvation. Thousands more seek its power. For this reason it is not uncommon for entire communities to be centered around snake worshiping, constantly hunting and capturing rattlesnakes in the hopes of finding a Great Dream Snake, who is said to hide among the rattlers to conceal their divinity and to spy on the ways of men.

Exactly what these so-called Great Dream Snakes are remains a mystery. Most shamans and sorcerers agree that the serpent is a greater demon, or a forgotten and ancient race (or sub-race) of dragon, or even an evil and mischievous dragon-godling that likes to torment mortals with lies of salvation, restoration and power. Most also agree that there are fewer than a dozen in the world, perhaps as few as three. One is known to wander Western Canada and is said to look very old, one frequents the Arizona and New Mexico region and a third has been reported in the regions of northwestern Nevada and Northern California.

### The Great Dream Snake NPC Villain

**Alignment:** Generally anarchist or miscreant.

**Attributes:** I.Q. 3D6+10, M.E. 3D6+10, M.A. 3D6+10, P.S. 3D6+12, P.P. 3D6+6, P.E. 3D6+10, P.B. 2D6+8, Spd. 3D6+18  
M.D.C.: Young Snake: P.E. attribute number x100 plus 1D4x10 per level of experience (P.E.x100 for Hit Points and 1D4x10 S.D.C. per level of E.P. with an A.R. 15 on S.D.C. worlds).

Adult Snake (2000 years or older): P.E. attribute number x1000 plus 2D6x10 per level of experience (P.E.x1000 H.P. and 2D4x10 S.D.C. per level of E.P. with an A.R. 17 on S.D.C. worlds).

**Horror/Awe Factor:** Young: 14; Adult: 17

P.P.E.: Young: 1D6x100 plus 4D6 per level of experience.

Adult: 1D6x1000 plus 1D6x10 per level of experience.

**Size:** Varies from 3-100 feet (0.9 to 30.5 m) long.

**Weight:** Varies with size; 10 pounds (4.5 kg) to one ton when giant!

**Average Life Span:** Unknown. Lives to at least 100,000 years; may be immortal!

**Natural Abilities:** Nightvision up to 2000 feet (610 m) and all other abilities and powers common to dragons (see the *Dragons & Gods sourcebook* for both the *Palladium Fantasy RPG*® and *Rifts*® for comprehensive information about dragons and gods).

**Shadow Meld at Will (Special):** As a natural ability, no P.P.E. is spent, and the wily serpent can perform a meld as often as once per melee round.

**Poisonous Bite (Special):** 1D6×10 direct to hit points or 1D6×10 M.D. to mega-damage creatures. A successful save vs lethal poison reduces damage by half.

**Unlimited Metamorphosis (Special):** into any creature with unlimited duration; identical to the ability of the Chiang-Ku dragon.

**Size Metamorphosis (Special):** The snake can grow as large as 100 feet (30.5 m) long and 3-4 feet (0.9 to 12.2 m) in diameter, to the size of an ordinary rattlesnake. This is only possible in rattlesnake form — its *primal manifestation*. At maximum size, the snake inflicts triple its normal damage and M.D.C. increases by 20%.

**Grant Wishes Without Limit!** This is a power that the Great Dream Snake is *reputed* to have through myth and legend. However, like so many other things about this creature, it is a deception. The Great Dream Snake cleverly uses psionics, magic illusions, and other magic to make the recipient of the wish *believe* that he or she *received/lived* it, but always manipulates the events of the illusions *and/or* mind control in such a way that the character *loses* whatever it is (or it is a temporary reward, or a glimpse of the reward that awaits him, and so on).

Note: And so too, we see the true meaning behind the Great Dream Snake's name — it uses and offers a creature its "dreams." It can make one's dreams, hopes, desires, and fantasies seem real or within one's grasp, or even momentarily attained. Yet, inevitably, like the stuff of dreams, they are always fleeting and never truly attainable. So it is, the Great

Dream Snake uses a person's dreams as a cruel deception and a tool for temptation, betrayal, worship, intimidation, torture, and (momentary) reward.

**R.C.C. Combat:** Four attacks per melee (+2 for adults). The creature tends to rely on magic and psionics and prefers powers that manipulate or control the mind and/or body of others, including illusions, curses and illness. May also use magic items (collects magic).

**Damage:** Damage has become supernatural and uses the chart in the *Rifts Conversion Book 1*. A tail whip is equivalent to a tentacle strike or punch, and a bite does 5D6 mega-damage.

**Bonuses (in addition to attributes):** +5 on initiative, +3 to strike and dodge, +3 to pull punch, +5 to save vs **illusionary** magic, +2 to save vs all other types of magic, +8 to save vs possession and mind control, +10 to save vs Horror Factor, impervious to poison and disease.

**Average level of experience:** Young 1D4+3; Adult: 1D4+8; use the same experience table as the dragon.

**Magic:** Knows all *illusionary spells* plus spells level 1-5, call lightning, fire ball, wind rush, commune with spirits, memory bank, transferal, negate magic, dispel magic barrier, spoil, sickness, constrain being, banishment, summon shadow beast, time slip, mystic portal, anti-magic cloud, time hole, close Rift, dimensional portal and **teleport superior**.

**Psionics:** Knows all psionics at 10th level proficiency.

**I.S.P:** 1D6×100+20 per level of experience.

**Vulnerabilities:** On the Astral Plane, a place they like to visit, their M.D.C. is half and all attacks against them while in the Astral Plane inflict double damage to the snakes.

**Skills:** Basic math at 98%, speak and read American and Dragonese at 98%, and land navigation 90%. Has little use for human skills but can learn any skills it sets its mind to (as many as 1D4 per level of experience; no category limitations; +10% skill bonus to all). Tends to rely on magic for everything.

**Habitat:** On Rifts Earth the Great Dream Snake is only known to exist in the American New West and Canadian Southwest.

**Allies:** Other than foolish worshipers and dupes, none are known. They rarely associate with their own kind, dragons or other supernatural beings.

**Enemies:** Unknown.

---

## Great Plains Buffalo

---

In a time many moons ago, buffalo numbered in the thousands and roamed free across the plains of the American West. These majestic animals were the lifeblood of the American Plains Indians and greatly respected by these peoples. When civilized men came with their rifles and war-like ways, the buffalo were slaughtered by the thousands almost into extinction. These majestic beasts each held a magical spirit and these spirits could not be allowed to be decimated. Through the use of ritual magic and prayers, the Plains Indians were able to send the remaining buffalo into a world beyond our own. This place of unending plains would be the home of the buffalo for generations. With the Coming of the Rifts, many worlds and dimensions were rocked with the surging magical energies. It was this event that

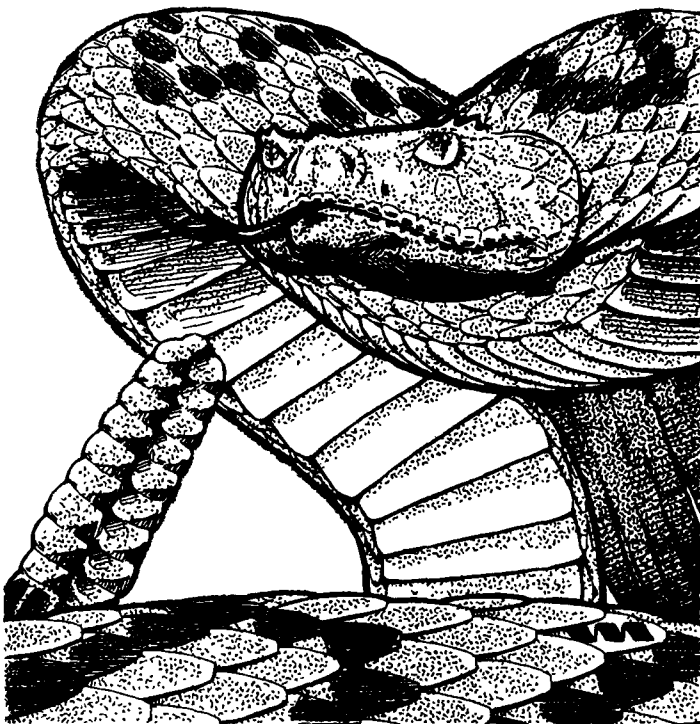

seemed to call the buffalo home. With a flash of azure blue light and sound of thunder, millions of buffalo came stampeding from a giant Rift, back onto the plains of the New West.

### Great Plains Buffalo NPC Animal

**Alignment:** Animals; generally considered to be selfish alignment.

**Attributes:** Animal attributes are very consistent and offer a smaller range of attribute aptitude. I.Q. Low animal intelligence (1D4), M.E. 1D6, M.A. 1D6, P.S. 20+1D6, P.P. 10+1D6, P.E. 14+1D6, P.B. 2D6+2, Spd 20+2D4; a minimum speed of 22 (15 mph/24 km).

**Hit Points:** 6D6+30

S.D.C.: 2D4x10

**Horror Factor:** None per se; 10 when charging an opponent only.

**Size:** 8-9 feet (2.4 to 2.7 m) long; about 5 feet (1.5 m) at the shoulders.

**Weight:** 800-1200 pounds (360 to 540 kg)

**Average Life Span:** 25 years.

P.P.E.: 4D6

O.C.C.: None; animal.

**Natural Abilities:** Fair speed, can run without pause and without exhaustion for three hours, poor vision, keen sense of smell

**R.C.C. Combat: Attacks/Actions Per Melee:** Three

**Damage:** Kick with hind legs does 4D6 S.D.C., kick/stomp with front legs 2D6 S.D.C., head butt 2D4, bite does 1D4 S.D.C., running ram with horns: 1D6x10 S.D.C. plus human-sized opponents are knocked 2D4 yards.

**R.C.C. Bonuses:** +1 to strike, +1 to dodge, and +2 to save vs horror factor.

**Magic:** None

**Psionics:** None

**Enemies:** Large predators, pack hunters (including Silonar and wolves), and humanoids.

**Allies:** None

**Value:** 300-600 credits per animal, used for their meat, fur and horns.

**Habitat:** Plains and prairies of the West. Typical herd numbers 4D6x100.

---

## Grigleapers

---

Grigleapers are named after the man who first discovered them, Bartholamew P. Griggs. They are found primarily in the mountains and hills of the Rocky Mountains, and the canyons and buttes of Arizona and Utah, but can be found in most mountainous and rocky areas throughout the West, including Idaho, Wyoming, Montana and Colorado. They may also inhabit the ruins of ancient cities with tall, empty buildings (typically what was once the downtown area)

They are alien predators that prey on large animals. Humans and cattle are amongst the easiest prey, and Grigleapers near population centers will regularly stalk humans, D-bees and their penned or corralled livestock. However, Grigleapers are without fear: a pair will challenge a Devil Unicorn, and a pack of seven or more will attack the largest dinosaur and even a T-Rex or a dragon!



All the more horrifying is that **Grigleapers** typically hunt in packs of 4-16 (roll 4D4) and larger nesting areas in the mountains or ancient skyscrapers can number into the hundreds (the ruins of Denver, Colorado, are infested with at least 400).

Grigleapers have both an insect and animal-like appearance, with large, grasshopper-like hind legs, a whipping tail, four arms, an exoskeleton with barbs and spines, and an inhuman head crowned with a thick, protective plate of bone. The mouth is reminiscent of an insect's mandibles. The color of its exoskeleton varies from light grey to grayish-green. The hands of the four arms have long, segmented fingers and a thumb, with sharp, strong claws at the ends. The fingers are powerful enough to dig into stone and most mega-damage materials, enabling the monsters to swarm mega-damage buildings and robot vehicles and climb up them like monstrous bugs. Slime dripping tentacles shoot out of the palms to ensnare or strangle prey, as well as to provide extra grip when climbing. The tail is long and flexible like a whip, and has a sharp, blade-like spike used for slashing and stabbing, as well as for balance and climbing.

### **Grigleaper NPC Animal/Monster**

**Alignment:** Considered miscreant or diabolic.

**Attributes:** I.Q. High animal intelligence and a cunning predator: 1D4+4, M.E. 20 +1D4, M.A. 1D6, P.S. 20+2D4, P.P. 20+1D4, P.E. 20+2D4, P.B. 1D4, Spd 30+3D4; a minimum speed of 33 (22.5 mph/36 km); supernatural P.S. and P.E.

M.D.C.: Main Body: 20 +P.E. attribute x2 on Rifts Earth (2D4x10 H.P. and 5D6 S.D.C., with an A.R. 15 on S.D.C. worlds).

**Horror Factor:** 15 — 18 from a pack of 10 or more.

**Size:** 5 feet (1.5 m) long plus 7-9 foot (2.1 to 2.7 m) long tail.

**Weight:** 200 pounds (90 kg)

**Average Life Span:** 25-30 years; give birth to litters of 1D4+1.

P.P.E.: 6D6

O.C.C.: None; animal; see natural abilities.

**Natural Abilities:** Good running speed, can run without pause and without exhaustion for two hours, leap up to 30 ft (9 m) high and 60 feet long (increase by 30% with a fast running start), dislike water but are good swimmers (swim skill equivalent 75%), climb 98%/95%, prowl 50%, track humanoids (using sense of smell and vision) 80%, hunt/track animals 86%, land navigation 90%, detect ambush 80%, detect concealment 70% and wilderness survival 98%.

**R.C.C. Skills:** Not applicable.

**R.C.C. Combat: Attacks Per Melee:** Six

**Damage:** Biting nip 6D6 S.D.C., bite 1D4 M.D., restrained claw strike 1D4 M.D., full strength claw strike 3D6 M.D., power claw strike 6D6 M.D., punch or kick 2D6 M.D., power punch 4D6, tail slash 2D6 M.D., head butt 6D6 S.D.C., and pounce attack 2D6 M.D. plus a 01-72% likelihood of prey being knocked down (loses initiative and one melee attack). After a successful pounce attack, the leaper can claw with two arms (4D6 M.D.), four arms (1D4x10+4 M.D.) or all six limbs, inflicting a massive 1D6x10+8 M.D.!

**R.C.C. Bonuses:** +4 on initiative, +3 to strike, +3 to parry, +4 to dodge, +6 leaping dodge, +4 to roll with punch, impact or fall, impervious to poison, +12 to save vs horror factor — fearless. These are all in addition to any possible attribute bonuses.

**Magic:** None

**Psionics:** None

**Enemies:** Large predators and humanoids.

**Allies:** None; fearless predatory monster.

**Value:** None

**Habitat:** Rocky Mountains and the ruins of skyscrapers and tall buildings throughout the West, but especially in Colorado, Idaho, Wyoming, Montana, Oregon, and Alberta, as well as in the canyons and mountains of Arizona and Utah. Most estimates place their numbers in the hundreds of thousands, but nobody knows for certain.

---

## **Gwylack**

By Chris Kornmann

---

The Gwylack may be a strange mutation brought about by the high radiation from the wars fought so long ago, or the product of genetic experimentation, or a creature from another world. It is a hideous cross between a giant tarantula and a giant scorpion. It has eight legs, a hairy spider-like body and a hairy scorpion's tail. The poison it secretes is one of the deadliest in the Americas. One of the more interesting things about the Gwylack is the fact that many of the Indians and D-Bees hunt them for food. It is said that they taste very similar to chicken. Gwylack are not intelligent creatures, tend to see everything as food and will attack when hungry or provoked. They are very numerous in the New West. They are sometimes ridden by **Simvan Monster Riders**.

### **Gwylack NPC Animal/Monster**

**Alignment:** Animal predator, generally considered anarchist.

**Attributes:** I.Q. 1D4+4, M.E. 1D6, M.A. 1D6, P.S. 4D6+20, P.P. 3D6+6, P.E. 2D6+10, P.B. 1D6, Spd 1D6x10+20.

M.D.C.: 3D4x10 (2D4x10 Hit Points and 1D4x10 S.D.C. with an A.R. 12 on S.D.C. worlds).

**Horror Factor:** 16

**Size:** 5 feet (1.5 m) tall, 8 feet (2.4 m) long plus 5-7 foot (1.5 to 2.1 m) long tail.

**Weight:** 300-400 pounds (135 to 180 kg)

**Average Life Span:** 6-8 years; lays 1D4x10 eggs once a year.

P.P.E.: 1D4

O.C.C.: None; animal; see natural abilities.

**Natural Abilities:** Nightvision 2,500 feet (762 m), prowl 80%, leap up to 20 feet (6 m) high and 60 feet (18.3 m) long, compound eyes with polarized vision (no sun glare), 320 degree arc of vision and cannot be surprised, spin web (each strand is as thick as a rope and requires 16 S.D.C. points of damage to cut it) and poisonous sting and bite. Climb sheer walls and ceilings.

Gwylack's poison does 2D4x10 damage direct to hit points or 6D6 M.D. to mega-damage creatures. A successful save vs lethal poison means the character takes one third damage.

**Vulnerabilities:** Cannot swim; sinks like a rock and drowns. If turned on their back they have a very difficult time turning back over. It will take them 1D4 melee rounds to rock themselves back onto their legs; while on their back they cannot attack.

**R.C.C. Combat:** Three attacks per melee.

**Damage:** Bite (no poison) 2D4 M.D., sting (no poison) 2D6 M.D., leg strike 1D4 M.D.

**Bonuses:** +1 to strike, +2 to strike with tail, +2 to dodge, +3 to leap auto-dodge, +4 to roll with impact or fall, +8 to save vs horror factor, and impervious to poison.

**Magic:** None

**Psionics:** None

**Allies:** None, animal predator.

**Enemies:** Humanoids, Leatherwings and various large predators.

Value: 100-300 credits as food, and the poison is used in a variety of anti-poison serums.

**Habitat:** Gwylacks are generally found in the dry desert regions of the New West, most notably Lone Star, New Mexico, Arizona, Utah and Nevada, as well as Mexico.

---

## Leatherwing

---

The Leatherwing is a massive pterodactyl type flying dinosaur, probably from another dimension. They roost in canyon cliffs and on the peaks and buttes of *Arizona* and *Utah*, but can also be found in the Rocky Mountains and may fly hundreds of miles to hunt. Prey includes humans, D-bees, horses, cattle, Gwylack and even buffalo and buffalo-sized (and smaller) dinosaurs, as well as carrion. The winged behemoths typically swoop down from a cliff or the heavens and snatch up their **earthbound** prey in their taloned feet or large beak, lined with crooked teeth like a crocodile. Their arms are part of their gigantic wings, like those of a bat, and like the bat, their fingers are quite articulated and used to climb, scale cliff walls, and tear apart their prey. The head and beak is a vibrant sky blue while their body and wings are a soft, warm tanish pink that actually blends into the hues and tones of the sky amazingly well, not to mention the colors of the canyons and desert.

The main hunting grounds of the Leatherwing are the canyons, prairies and deserts of the New West. These lords of the sky have adapted so well to the American Western Wilderness that they may number in the millions!

Some tribes of **Simvan Monster Riders** (and the occasional **Psi-Stalker**) love using Leatherwings as flying mounts in order to launch raids and attacks from the air — gliding on wind, the great, winged monsters swoop in without a sound. In fact, their shadow is more likely to give their arrival away than any sound.

### Leatherwing NPC Animal/Monster

**Alignment:** Animal predator generally considered anarchist or evil.

**Attributes:** Animal attributes are very consistent and offer a smaller range of attribute aptitude. **I.Q.** Low animal intelligence, **M.E.** 2D6, **M.A.** 3D4, **P.S.** 28+2D6, **P.P.** 20+1D6, **P.E.** 18+1D6, **P.B.** 1D4, **Spd** 3D6+6 on the ground or when climbing, but 50+3D6 when flying; a minimum speed of 55 (37.5 mph/60 km). **Supernatural P.S. & P.E.**

### Mega-Damage by Location:

\* **Head/Beak** — 100

\* **Wing Arms (2)** — 120 each

\* **Hind Legs (2)** — 130 each

**Wing Membrane (2)** — 130 each

**Main Body** — 1D4×100 (5D6×10 H.P. and 4D6×10 S.D.C. with an A.R. 12 on S.D.C. worlds).



\* A single asterisk means a small or difficult target to hit and requires a "called shot" at -2 to strike.

**Horror Factor:** 14

**Size:** Stands 17-20 feet (5 to 6 m) from head to toe, with a reach of 15 feet (4.6 m) and a wingspan of 60 feet (18.3 m)!

**Weight:** 1000 pounds (450 kg)

**Average Life Span:** 30-50 years

**P.P.E.:** 3D6

**O.C.C.:** None; animal.

**Natural Abilities:** Good ground and flying speed, can fly without pause and without exhaustion for five hours, prowl (silent flight and dive attack) 70%, track by smell 70%, keen hawk-like vision (can see a rabbit two miles/3.2 km away) and superb hearing.

**R.C.C. Combat: Attacks/Actions Per Melee:** Three

**Damage:** Talon strike with lower legs does 6D6 M.D., wing claws 3D6 M.D., wing slash 2D6 M.D., bite does 1D6×10 M.D., stomp 1D4 M.D., and a diving attack with talons (effectively a power strike that counts as all three melee attacks) 4D4×10 M.D.! It takes one full melee round of flying to set up another diving attack.

**R.C.C. Bonuses:** +2 on initiative on the ground, +5 if flying and when a successful prowl has been made, +1 to strike on the ground, +3 flying, +2 to dodge when flying, +1 to roll with impact or fall, +6 to save vs disease and poison, and +4 to save vs horror factor. These are all in addition to any possible attribute bonuses.

**Magic:** None

**Psionics:** None

**Enemies:** They are preyed upon by humans, D-bees, Grigleapers, Panthera-Tereon, and pack dinosaurs, but are so large and ferocious that they don't have too many natural predators, at least not on Rifts Earth (which is why they thrive here).

**Allies:** None

**Value:** 100-300 credits per animal. The meat is very tough, like chewing old leather, and has a stale taste, so they have little value for their meat. The teeth are used in jewelry and the hide can be made into a light M.D.C. fabric (poncho or overcoat has 8 M.D.C., overcoat with extra armor padding 12-16 M.D.C., or tent with 15 M.D.C.). They are difficult to ride and impossible to domesticate except by Simvan and Psi-Stalkers (-10% on riding skill for them, -30 for others).

**Habitat:** Mountain and canyon cliffs, the tops of buttes and summits. It is estimated that at least 1.5 million Leatherwings dominate the skies of Arizona, Utah, Nevada and New Mexico, with another 500,000 to one million believed to be scattered along the Rocky Mountains, and can be found in most warm to hot mountain regions, including Lone Star, California and Mexico. The largest flocks can contain as many as 50,000 and blot the sun from the sky when they take flight. Fortunately, Leatherwings are solitary hunters, although 3D6 will flock to partake in devouring a fellow Leatherwing's kill or find of carrion.

---

# Mammoth Brontodon

---

The Mammoth Brontodon is the largest of the alien, dinosaur-like creatures to successfully adapt to Rifts Earth. They are scattered throughout the Western Wilderness and parts of Canada. The Brontodon towers 20 feet (6 m) tall on all fours and about 70 feet (21.3 m) long. The head is wide and flat, crowned with six lumps that look like tiny volcanos — these are the animal's noses which gives the Brontodon its superior olfactory sense. A pair of large horns curve slightly from the side of the head, and behind them are a pair of tiny ears. A large blue eye is located on each side of the head where one would expect them, but a second pair of tiny eyes are located in the center of the forehead. The large pair are used for scanning the beast's surroundings while the small pair are used for close range work, particularly focusing on food and scraps. The spine is covered in a thick, tough hide similar to that of the Earth rhinoceros, but five times thicker. The tial is a strange, thick appendage that ends in a large fan-shaped clump lined with claw-like spines. The tail is prehensile, and like the Earth Stegosaurs of old, is used as a slapping spiked club against predators. The forearms are small, with two large, thick fingers and a thumb, ideal for ripping apart carrion and prey. The hind legs are huge and thickly muscled. The Brontodon walks on all fours, standing on two legs to better survey its surroundings or to reach high branches; the large horns on its head are also used to snare and pull down branches. The massive creature rears up and bellows to frighten attackers and sometimes runs using only its two hind legs and other times switching to all fours in a loping gallop.

The Brontodon is unique in that it is an omnivore that grazes on the leaves of trees, berries, nuts and pine cones as well as small to medium-sized animals, bones and carrion — they also love crops of wheat, barley, and corn, which means they sometimes invade and devour farm crops and may even break into storage silos, buildings and trucks to eat the grain. Their mouth is huge, big enough to bite a man in half or gobble him up whole, although they rarely attack humanoids (only if attacked first, cornered or defending the herd). The lower jaw is double jointed and can move side to side as well as up and down. The teeth are jagged with large teeth intermixed with smaller ones, and function more as a "saw" to cut chunks of carrion, bones and tree branches than fangs to bite. The menacing looking "mouth finger-claws" are used to help cut and tear apart carrion, dig up edible roots and shovel food into its mouth.

The Brontodon is a favorite riding animal of the Simvan, second only to the fast and nimble one-rider Ostrosaurus. Its massive size and smooth movement allows the Simvan to build a large riding platform on the Brontodon's back, reminiscent of those once mounted on the elephants of India. These riding platforms can accommodate six to ten people, depending on its size, and usually have a canopy. The actual rider who directs the beast sits behind its head, and an additional 4-6 riders can line the neck and upper shoulder area and another 6-10 can ride on the large, flat tail; although these extra riders may fall off if the animal is made to run. The nomadic Simvan also use the Brontodon to haul tons of supplies and the materials for their tents and huts — a Brontodon can carry up to 40 tons on its back (reduce speed

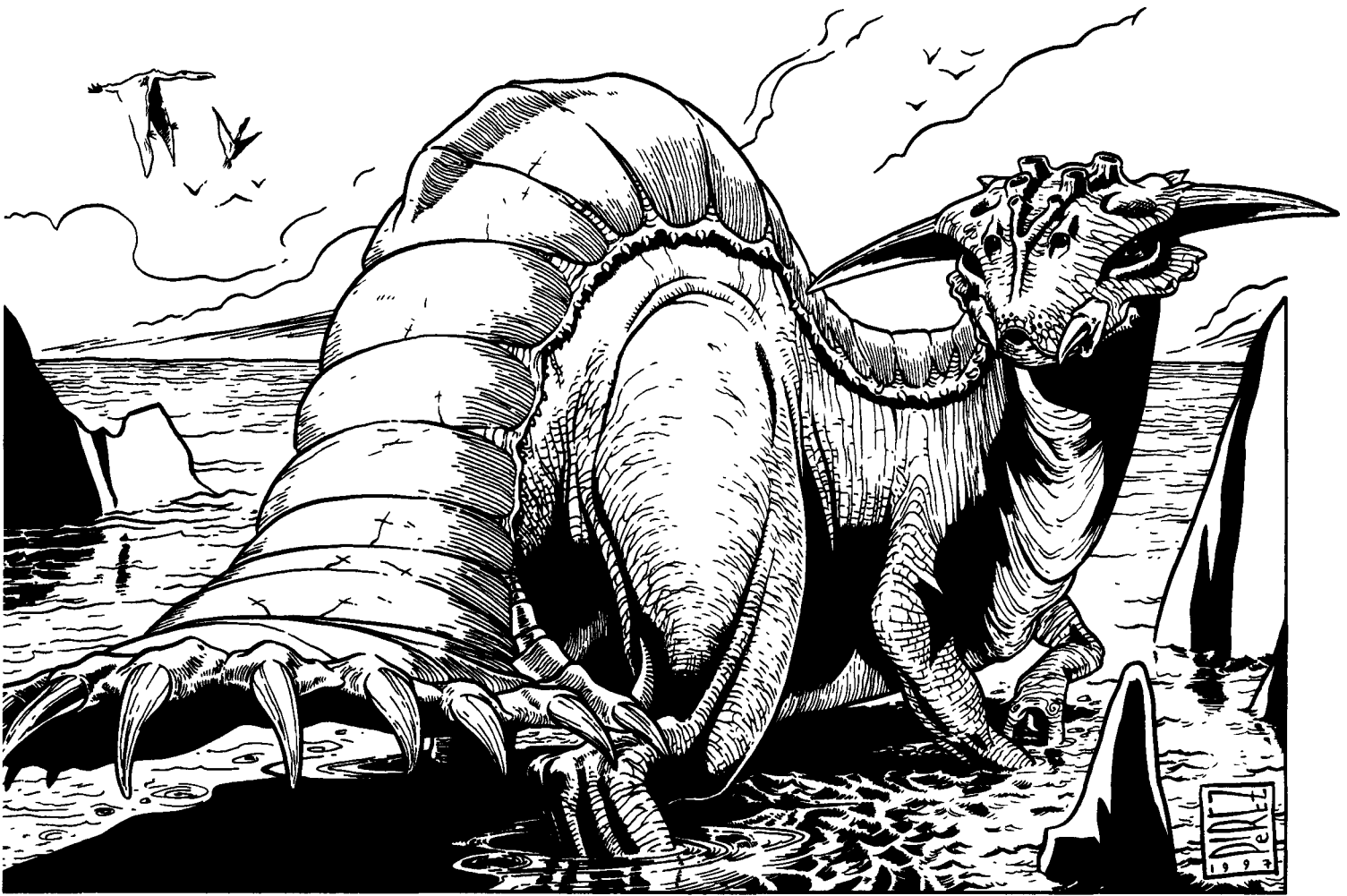

by 25%), but refuse to pull the tiniest cart, smashing it with the tail (even Simvan can't break them of this).

### **Mammoth Brontodon NPC Animal/Monster**

**Alignment:** Animal scavenger generally considered anarchist.

**Attributes:** Animal attributes are very consistent and offer a smaller range of attribute aptitude. I.Q. Medium animal intelligence, M.E. 2D6+5, M.A. 2D6+5, P.S. 50+2D6, P.P. 2D6+5, P.E. 20+1D6, P.B. 2D6, Spd 12+3D6; supernatural P.S. & P.E.

#### **Mega-Damage by Location:**

\* Horns (2) — 100 each

Head — 200

\* Mouth Claw-Fingers (2) — 35 each

\* Forearms (2) — 130 each

Hind Legs (2) — 200 each

Tail — 300

Main Body — 350+1D6×100 (1D4×100 H.P. and 6D6×10 S.D.C. with an A.R. 14 on S.D.C. worlds).

\* A single asterisk means a small or difficult target to hit and requires a "called shot" at -2 to strike.

**Horror Factor:** 13

**Size:** Stands 20 feet (6 m) tall on all fours, 50 feet (15.2 m) erect and is 70 to 75 feet (21.3 to 22.9 m) long from head to tail tip.

**Weight:** 10-14 tons (can carry three times its own weight).

**Average Life Span:** 30-50 years

P.P.E.: 6D6

O.C.C.: None; animal.

**Natural Abilities:** Slow speed, can travel without pause and without exhaustion for eight hours, good vision, poor hearing, swim 55%, climb 50%/0%, land navigation 95%.

**Superior Sense of Smell (special):** Identify scents 90%, including humanoids, vehicles, enemies, carrion, edible plants, poison, etc. — can smell roots, buried bones or food 10 feet (3 m) underground or inside a truck or building that is not airtight, and can smell humanoids and vehicles approaching from 1.5 miles (2.4 km) away (and usually move to avoid them or to defend themselves). Track by smell 90%. Another reason the Simvan like these animals so much.

#### **R.C.C. Combat: Attacks/Actions Per Melee:** Four

**Damage:** Tail strike 1D6×10 M.D., tail power strike 2D6×10 M.D., front claws do 1D4×10 M.D., bite 1D4×10 M.D., head butt or horn strike 1D4×10 M.D., impale with horns 1D6×10 M.D., and mouth finger-claws do 3D6 M.D.

**A running head/horn ram (counts as two melee attacks):** 2D6×10 and knocks human to Ostrosaurus-sized opponents 4D4 yards. For "small" opponents (including characters in M.D.C. body armor or power armor, cyborgs, Crazies and Juicers), be certain to attempt to roll with impact to reduce damage. Many small opponents are killed by this attack, although it is typically reserved for larger foes and for dispersing packs and groups of enemies. Humans in body or power armor must roll to save vs coma/death even if their armor holds. A failed save means 6D6 damage direct to hit points and S.D.C., 1D6 ribs are broken (reduce speed and all combat bonuses by half for 2 weeks) and the character is knocked out for 1D6×10minutes!

**R.C.C. Bonuses:** +3 on initiative (olfactory bonus), +4 to strike with tail, +2 to strike with claws, horn or bite, +2 to parry, no dodge, +3 to pull punch, +1 to roll with punch, fall or impact,

+4 to save vs poison and disease, +5 to save vs horror factor. These are all in addition to any possible attribute bonuses.

**Magic:** None

**Psionics:** None

**Enemies:** The T-Rex is the most obvious predator because it can match the Brontodon in sheer size and power, but this gentle giant's greatest enemies are small, fast dinosaurs that hunt in packs, like Silonars, Ostrosaurus and Tiger-Claw Raptors, as well as humanoids.

**Allies:** None per se; a favorite of Simvanas riding animals.

**Value:** 100-300 credits per animal. The meat is very tough, stringy and poor tasting, so they have little value for their meat. The teeth and horns are used in jewelry or in weapons, and the hide can be used to make a light M.D.C. fabric (poncho or overcoat has 10 M.D.C., overcoat with extra armor padding 15-18 M.D.C., or tent with 18 M.D.C.; but twice as heavy as other similar items). They are difficult to ride and impossible to domesticate except by Simvan and the occasional Psi-Stalker (no riding skill penalty for them, -25% for others).

**Habitat:** Light to dense forested regions, as well as scrub and prairie grasslands. Seldom found south of Colorado or Kansas, and avoids deserts and canyons. Typically gather and travel in small herds of 4D6+10.

---

## Moss-Back Scuttler

---

The Moss-Back Scuttler is a giant, prehistoric-looking land turtle from another world. It has a hard M.D.C. shell, rimmed with sharp horns, six short legs, and a thick, battering tail. The head has a sharp, pointed shell covering to protect it from predators, plus it can completely retract its head and legs into its shell. The giant creature has a long, sticky tongue, like a toad, which it uses to snare its prey. The Moss-Back Scuttler preys on insects, small animals (including lizards, snakes, toads, mice, rabbits, and birds), carrion and fruits and vegetables. Typically, the Scuttler will find a suitable place with abundant food, park itself like a rock, and sit motionless. When an insect or small animal wanders by, unaware that the big rock or mound is a predator, the Moss-Back Scuttler quickly whips out its head to gobble it up, or shoots out its long, sticky tongue to ensnare the animal and pulls it into its mouth (usually biting several times to kill it, before swallowing it whole). They attack humanoids only if attacked first, startled, or if an individual is sick or seriously injured.

If the creature finds a good spot, it may sit there for years, moving only periodically and then seldom more than a hundred yards. Lichen, moss, grass and even shrubs and small trees often grow on the backs of these giants, adding to their camouflage. In climates where snow covers the ground, the Moss-Back Scuttler hibernates. They can live off a storage of fat for up to six months without food.

### Moss-Backed Scuttler NPC Animal/Monster

**Alignment:** Animal predator generally considered anarchist.

**Attributes:** Animal attributes are very consistent and offer a smaller range of attribute aptitude. I.Q. Low animal intelligence,





M.E. 2D6, M.A. 2D6, P.S. 22+2D6, P.P. 2D6+4, P.E. 20+1D6, P.B. 1D6, Spd 2D6+2; supernatural P.S. & P.E.

**Mega-Damage by Location:**

\* Head — 50

\* Legs (6) — 40 each

Tail — 110

\* Underbelly (bottom shell) — 100

Main Body (top) — 250+1D4×100 (6D6×10 H.P. and 4D6×10 S.D.C. with an A.R. 18 on S.D.C. worlds).

\* A single asterisk means a small or difficult target to hit and requires a "called shot" at -3 to strike.

**Horror Factor:** 10

Size: 4 feet (1.2 m) tall on all fours, 12 feet (3.6 m) long, plus an 8 foot (3 m) long tail (2.4 m).

**Weight:** 1-2 tons (can carry twice its own weight).

**Average Life Span:** 150-300 years

P.P.E.: 3D6

O.C.C.: None; animal.

**Natural Abilities:** Hard protective shell, slow speed, good vision and hearing, toad like prehensile tongue (4 ft/1.2 m reach), the head and neck can also extend four feet (1.2 m), prehensile battering tail, swim 50%, climb 40%/0%, land navigation 70%, and prowl 70%.

**R.C.C. Combat: Attacks/Actions Per Melee:** Three

**Damage:** Tail strike 4D6 M.D., tail power stake 1D6×10, bite 3D6

S.D.C., head butt or body bump 3D6 S.D.C.

**R.C.C. Bonuses:** +2 on initiative with tongue strike and tail attack, +4 to strike with tail, +2 to strike with bite, +4 to save vs poison and disease, +6 to save vs horror factor. These are all in addition to any possible attribute bonuses.

Magic: None

**Psionics:** None

Enemies: The T-Rex is the most obvious predator because it can match the Scuttler in sheer size and power, but this gentle giant's greatest enemies are small, fast dinosaurs that hunt in packs like Silonars, Ostrosaurus and Tiger-Claw Raptors, as well as humanoids.

**Allies:** None per se.

**Value:** 100-300 credits for the animal's shell.

**Habitat:** Light to dense forested regions in the West, East and Canada. Rarely more than 2D4 in the same general region.

---

## Oborus-Slitherer

---

The Oborus-Slitherer is often accused of being a monstrosity created at Lone Star, but is more likely to be a supernatural predator, demon or creature of magic from another world. The horrid monster appears to be part hairless gorilla, part snake, part slug and all evil. They like to kill and torture for pleasure and two or more often try to enslave an entire town or tribe of lesser beings. Slitherers sometimes associate with Devil Unicorns and dragons, but more often join forces with bloodthirsty bandits and mercenaries, tyrant lords, evil sorcerers (especially necromancers) and demons. Rumors have suggested that one faction of the Tolkeen defenders (a fringe group of desperate and vengeful fanatics) have allied themselves to a group of six Oborus-Slitherers and

their companions, a Melech, Goqua and Dimension Ghoul (see **Rifts® Conversion Book One** for these fiends and many others).

### Oborus-Slitherer NPC Villain

**Alignment:** Always miscreant or diabolic.

**Attributes:** I.Q. Human intelligence and a cunning predator: 3D4+4, M.E. 14+1D6, M.A. 6+1D6, P.S. 27+2D6, P.P. 16+1D6, P.E. 16+1D6, P.B. 1D4, Spd 20+2D6; a minimum speed of 22 (15 mph/24 km); supernatural P.S. and P.E.

**Mega-Damage by Location:**

\* Arms (2; huge) — 120 each

Slug Portion of Body (center third) — 200

\* Snake Portion of Body (last third) — 180

Main Body (head & torso) — 300 on Rifts Earth (the entire creature would have 260 hit points and 6D6×10 S.D.C., with an A.R. 12 on S.D.C. worlds).

**Horror Factor:** 15

**Size:** 8-10 feet (2.4 to 3 m) for its main body, including the upper torso, plus another 30 feet (6 to 9 m) for its long slug (10-12 ft/3-3.6 m section) and snake portion (approx. 20 ft/6 m); has an 8 foot (2.4 m) reach!

**Weight:** One ton!

**Average Life Span:** 200+ years.

P.P.E.: P.E. attribute number ×10

O.C.C.: None; animal; see natural abilities.

**Natural Abilities:** Excellent climber 95%/90%, natural swimmer 86%, can hold its breath for 12+1D6 minutes, survive depths of up to 1000 feet (305 m), impervious to heat and



cold, fire does half damage, and bio-regenerate 4D6 M.D.C. every minute.

**Stick to Walls and Ceilings (special):** The slug portion of the **Oborus-Slitherer** can climb and cling to the sides of walls and ceilings, but at half normal speed. A favorite ploy is to cling to the ceiling in hiding and strike opponents or prey on the ground with its claws or tail, often entangling and grabbing one with its tail and striking another with its massive claws or magic.

**Prehensile Tail (special):** The monster's long, serpentine tail can be used as a whip to lash out at foes (5D6 M.D.), to entangle and pin a foe and/or crush (constriction 4D6 M.D. per melee squeeze; each squeeze counts as one melee attack), strangle (same as constriction attack), trip a foe (if character falls, he loses initiative and one melee action), or to disarm or grab an object or weapon.

**R.C.C. Skills:** Prowl 60%, track humanoids (using sense of smell and vision) 70%, track animals 50%, land navigation 80%, and wilderness survival 95%, two W.P. ancient and one Modern W.P. of choice, can learn to speak three languages at the base skill level +30%, and knows a total of 1D4+4 skills limited to selections from Communications, Military, Rogue, Technical, and Wilderness (all are +20%). Does not advance in experience levels.

**R.C.C. Combat: Attacks Per Melee:** Six hand to hand or two by magic.

**Damage:** A retrained punch or claw strike 5D6 S.D.C., full strength punch or tail strike 5D6 M.D., power punch 1D4×10 M.D. full strength clawed strike 5D6 M.D., bite or head butt 1D6 M.D.; see prehensile tail above.

**R.C.C. Bonuses:** +3 on initiative (+4 with tail attack), +2 to strike, +4 to strike with tail, +3 to parry, +2 on an automatic dodge (meaning the creature can bob and weave like a snake to dodge without it using up a melee action; roll to strike him as usual), +3 to disarm, +4 to pull punch, +5 to roll with punch, fall or impact, +5 to save vs possession, +9 to save vs horror factor. These are all in addition to any possible attribute bonuses.

**Magic:** The innate ability to cast the following spells: Chameleon, fear, turn dead, paralysis: lesser, blind, agony, trance, calling, domination, fool's gold, escape, tongues, and fire ball; all equal to a 5th level sorcerer.

**Psionics:** Limited to presence sense and mind block. I.S.P.: M.E. x2; considered a minor psionic.

**Enemies:** Large predators and creatures of good alignment.

**Allies:** Other **Oborus-Slitherers** (often gather in small groups of 3-6) and other evil forces.

**Value:** None

**Habitat:** They can be found anywhere in the **Americas**, but are most common in the Northwest, Magic Zone, and Canada — only a thousand or two are believed to exist. They like to raid, subjugate and torment lesser beings, so they are usually found in or near populated areas.

---

# Ostrosaurus

---

The **Ostrosaurus** is the favorite riding animal of **Simvan** warriors, with **Leatherwings** and **Panthera-Tereons** next in line. They are warm-blooded, predatory dinosaur-like creatures that roam **Rifts Earth**. They are found mostly in the west where they prey on herds of buffalo, horses, deer, and other dinosaurs. The animals tend to run in loose-knit packs of 3-12, but are as likely to be aggressive solitary hunters. The **Ostrosaurus** typically preys on herd animals so they tend to be migratory, following the herds. This is especially true of **Ostrosaurus** packs. However, they find domesticated livestock and humanoids to be tempting and easy prey. Pairs of **Ostrosaurus** are known to attack a rider on horseback and packs will attack small groups (under 10 people) on foot.

The monsters bear young once every year. The female lays 1D4 eggs and nests with them until they hatch. The eggs hatch at the end of eight weeks. During this time, the male will stay near and bring food back to the female. Once the eggs hatch, the male leaves; **ostrosaurus'** do not mate for life. The mother stays with the young for 2D6 weeks, then runs off, leaving the young to fend for themselves. An **Ostrosaurus** reaches full maturity within five months.

## Ostrosaurus NPC Animal/Monster

**Alignment:** Animal predator, considered anarchist or miscreant.

**Typical Attributes:** High animal intelligence and instincts. M.E. 2D6+8, M.A. 2D6+8, P.S. 22+2D4, P.P. 14+1D6, P.E. 18+1D6, P.B. 1D6, Spd. consistently 88 (60 mph/96 km). Super-natural P.S. & P.E.

### M.D.C. by Location

\* Head — 40

\* Front Legs (2) — 30 each

Hind Legs (2) — 50 each

Tail — 40

Main Body — 90+5D6 on **Rifts Earth** (2D4×10 H.P. and 1D4×10 S.D.C. with an A.R. 12 on S.D.C. worlds).

\* A single asterisk means a small or difficult target to his and requires a "called shot" at -3 to strike.

**Horror Factor:** 12

**Size:** Approximately 12 to 15 feet (3.6 to 4.6 m) long from buttock to nose tip. The thick tail adds another six feet (1.8 m) to the overall length. Standing erect, the beast measures about 15 feet tall (4.6 m).

**Weight:** 1600 lbs (720 kg) average.

**Average Life Span:** 40 years.

**P.P.E.:** 3D6

**O.C.C.:** None; animal.

**Natural Abilities:** Terrible swimmers 20%, excellent climbers 80%, track by scent 35%, recognize the scent of human blood 60%, superior vision: can see a rabbit a mile away. A carnivorous predator that preys on smaller, slower dinosaurs and animals, including humanoids.

Running: 60 mph (96 km) maximum; runs loping on all fours. Leaping: The animal's legs are strong and capable of great leaps. Leaps are approximately 15 feet (4.6 m) high and 40 feet (12 m) lengthwise. A running leap at speeds in excess of 40 mph (64 km) will enable the monster to leap an addi-

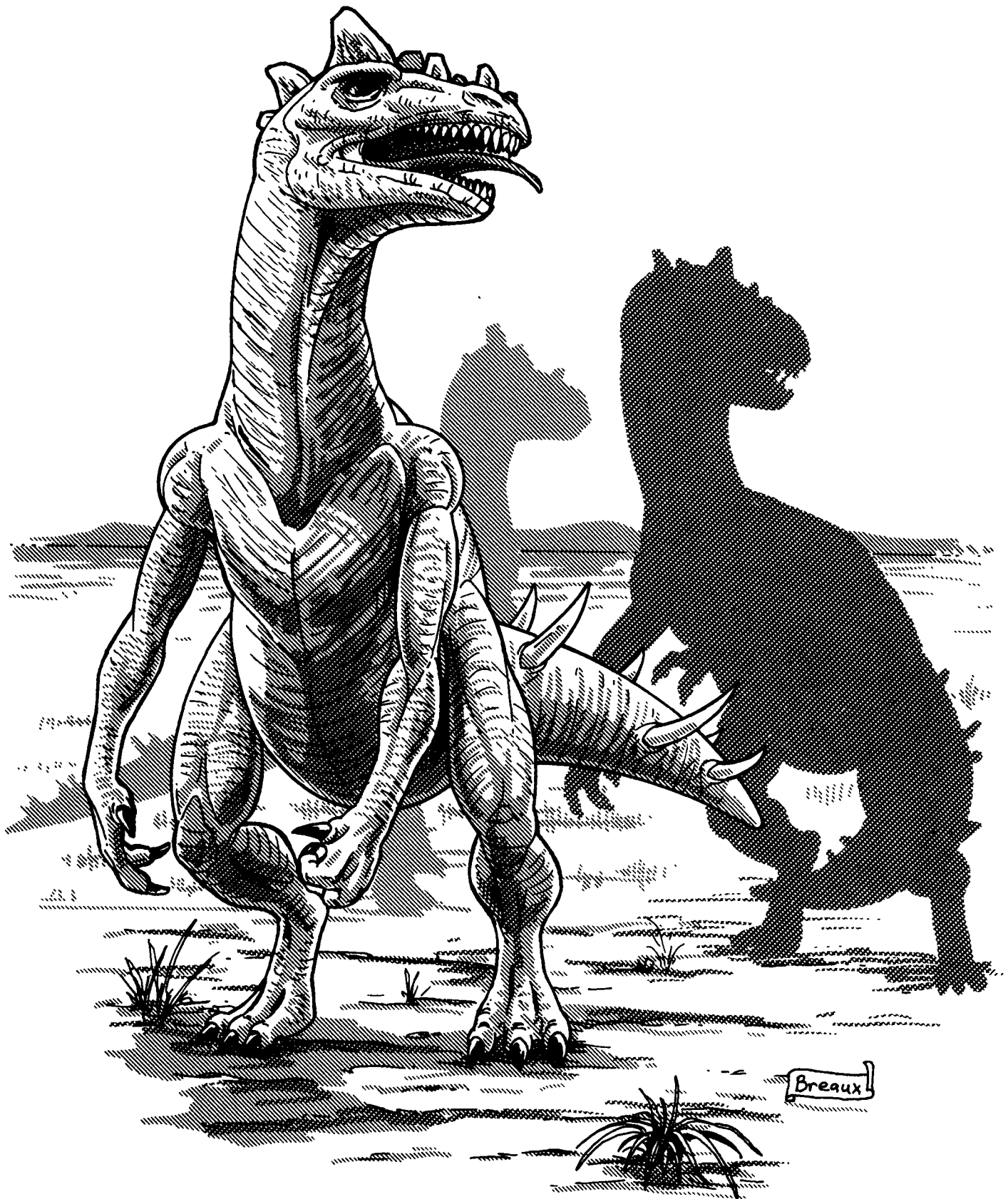

tional 30 feet (9 m). Can run without pause and without exhaustion for six hours.

**Combat: Attacks per Melee:** Four attacks per melee. The creature's standard method of attack is by bite and powerful rear legs/claws.

**Damage:** Front claws do 1D6 M.D., rear claws 3D6 M.D., bite 2D6 M.D., slap with tail 6D6 S.D.C. plus a 01-70% likelihood that the victim is knocked down and/or hurled 12 feet (3.6 m); loses initiative and one melee attack.

Leap attack with claws: 4D6 M.D., but counts as two attacks. Opponents who are 10 feet (3 m) or smaller are likely to be knocked down (80% chance), losing initiative and one melee attack, and may be pinned and unable to move/attack/dodge (01-40% chance). The monster can bite or slice its pinned victim with its teeth and claws until it is forcibly removed or distracted by a different target.

**R.C.C. Bonuses:** The front claws are used for dissecting its prey and cutting meat. +3 on initiative, +4 to strike, +4 to parry, +3

to dodge, +8 leaping dodge, +3 to roll with impact or fall, +4 to save vs disease and poison and +6 to save vs horror factor. These are all in addition to any possible attribute bonuses.

**Magic:** None

**Psionics:** None

**Enemies:** Large predators, pack hunters (including *Silonar*) and humanoids.

**Allies:** Commonly domesticated by *Simvan*.

**Value:** 800-1200 credits per animal as a riding beast; -15% to riding skill and only *Simvan* and *Psi-Stalkers* can ride them without penalty.

**Habitat:** *Ostrosaurus* prefer light forests, hills and open grasslands, but are also found in the hot, arid steppes and savannahs of New Mexico and Central America (but not as common as in the northern parts of the country). The animal is common along the Rocky mountains and the old American States of Montana, Wyoming, Colorado, Nebraska, the Dakotas and into the southern parts of Canada's Alberta (most believe the creature originated from the Calgary Rift). They are occasionally found as far southeast as Kansas, Oklahoma, and Missouri. However, the domesticated creatures are found wherever their masters take them. Do not do well in winter climates. Generally, prefer temperatures between 50 and 100 degrees Fahrenheit.

## Panthera-Tereon

The Panthera-Tereon is a huge, black maned, sabertoothed lion from another world. Most prefer mountains and forests as their habitat, but may travel miles in search of prey. This saber-

toothed lion stalks and eats just about anything it can catch, from rabbits to pheasants, but its favorite prey are deer, horses, buffalo, other large grazing animals, *Leatherwings* and *Grigleapers*, including dinosaurs, but finds domesticated livestock and humanoids to be tempting and easy prey. Thus, the Panthera-Tereon frequently attack livestock, stray cattle, tethered horses, and even horses and riders, and small groups of humanoids (under 6).

Fortunately, these great lions only hunt to eat, so once a kill is made the other animals are safe. Smart people travelling through the wilderness will leave a Panthera-Tereon who has just attacked a horse or mule alone. It's better to let the lion kill and drag his kill away than to fight it. Panthera-Tereon will fight to the death when cornered, frightened, attacked first or injured. Actually, Panthera-Tereon do hunt and kill one animal for pleasure, the *Grigleaper*. For some reason (rival predators?), the great lions hate these creatures and often chase and kill them whenever they can. A smart predator, the sabertooth will not stand against overwhelming odds and will flee a pack of *Grigleapers* or any foe who proves to be more dangerous than expected. Typically solitary hunters or mated pairs, they occasionally gather in small prides of 1D6+4.

### Panthera-Tereon NPC Animal/Monster

**Alignment:** Considered anarchist or aberrant.

**Attributes:** I.Q. High animal intelligence and a cunning predator: 1D4+5, M.E. 20+1D4, M.A. 1D6+8, P.S. 24+2D4, P.P. 20+1D4, P.E. 20+1D4, P.B. 2D6+10, Spd 20+3D6; a minimum speed of 23 (15 mph/24 km); supernatural P.S. and P.E.



M.D.C.: Main Body: 58 +P.E. attribute x2 on Rifts Earth (2D4x10 H.P. and 1D4x10 S.D.C., with an A.R. 11 on S.D.C. worlds).

**Horror Factor:** 13

**Size:** 15 feet (4.6 m) long plus 7 foot (2.1 m) long tail.

**Weight:** 1200 pounds (540 kg)

**Average Life Span:** 30-40 years; give birth to litters of 1D4+1.

**P.P.E.:** 1D6x10

**O.C.C.:** None; animal; see natural abilities.

**Natural Abilities:** Good running speed, can run in brief spurts of 1D4 minutes at double its normal speed before needing to slow down; leap up to 50 ft high (15.2 m, increase by 30% with a fast running start) and 60 feet long, dislike water but are excellent swimmers (swim skill equivalent 85%), climb 98%/80%, prowl 80%, track animals and/or humanoids 80% (+10% to hunt **Grigleapers**), land navigation 90%, detect ambush 55%, and wilderness survival 98%.

**R.C.C. Skills:** Not applicable.

**R.C.C. Combat: Attacks Per Melee:** Six

**Damage:** Biting nip 6D6 S.D.C., bite 3D6 M.D., restrained claw strike 1D4 M.D., full strength claw strike 4D6 M.D., power claw strike 1D4x10+8M.D., or pounce attack 2D6 M.D. plus a 01-84% likelihood of prey being pinned and helpless. After any successful pounce attack, the **sabertooth** can either hold its prey pinned (no attacks) while it continues to attack by biting, or claw with all four legs, inflicting 1D6x10 M.D.!

**R.C.C. Bonuses:** +4 on initiative, +3 to strike, +1 to parry, +1 to dodge, +3 leaping dodge, +3 to roll with punch, impact or fall, +5 to save vs poison, +9 to save vs horror factor. These are all in addition to any possible attribute bonuses.

**Magic:** None

**Psionics:** None

**Enemies:** Large predators and humanoids; loathes **Grigleapers**.

**Allies:** None; predatory monster.

**Value:** None

**Habitat:** Rocky Mountains and the ruins of skyscrapers and tall buildings throughout the West, but especially in Colorado, Idaho, Wyoming, Montana, Oregon, Washington, Montana, and Alberta, as well as in the canyons and mountains of Arizona and Utah.

---

## Psi-Ponies R.C.C.

By Chris Kornmann & Kevin Siembieda

---

Whether Psi-Ponies are a mutation caused by the magic energies of the ley lines or the energy and radiation that flooded the Earth during the Great Cataclysm, or a horse-like creature from another world, may never be known. These unique animals look very much like an ordinary Palomino with a beautiful, even colored coat of gold and a blond mane and tail. However, these animals are more intelligent than a horse, can run faster than most horses and possess psionic powers! This also means they have strong and unique personalities and tend to have a childlike understanding of things. Psi-Ponies value their freedom among all else and refuse to be imprisoned or enslaved. Many will even lead would-be enslavers into the jaws of a dangerous predator, quicksand, hostile natives, and so forth, to escape or punish

them. Psi-Ponies who befriend a person can make a marvelous friend, partner and tame riding animal (bareback and no bit or harness).

### Psi-Ponies NPC Animals

**Note:** A Psi-Pony can also make a very unique player character for players who can stay in character and love a challenge.

**Alignment:** Any, but tend to be anarchist, unprincipled and scrupulous.

**Attributes:** High animal/low human, roughly equal to a child with an I.Q. of 2D6+4, M.E. 2D6+12, M.A. 3D6+4, P.S. 6D6, P.P. 3D6+4, P.E. 2D6+12, P.B. 1D6+12, Spd 3D6+60; typically 66 (45 mph/72 km).

**Hit Points:** 5D6+6

**S.D.C.:** 5D6+12

**Horror Factor:** None

**Size:** 14 to 16 hands (or 4.6 to 5.4 feet/1.4 to 1.48 m) at the shoulders.

**Weight:** 800 to 1000 pounds (360 to 450 kg)

**Average Life Span:** 16-24 (10-15 for an ordinary horse).

**P.P.E.:** 6D6

**O.C.C.:** None; animal.

**Natural Abilities:** Swim 50%, jump 5-6 feet (1.5 to 1.8 m) high and 12 feet (3.6 m) long, can carry up to 500 pounds (225 kg) and pull 800 to 1200 pounds (360 to 540 kg), keen hearing, sensitive to the supernatural, plus psionic powers!

**Combat: Attacks per Melee:** Three physical or three psionic attacks.

**Damage:** Kicks: 2D6 S.D.C. from front legs, 4D6 S.D.C. from hind legs, bite does 1D4, or via psionics.

**Bonuses:** +3 on initiative, +2 to strike, +3 to dodge, +3 to roll with impact, +5 to save vs mind control and illusionary magic, +5 to save vs possession.

**Magic:** None

**Psionics:** Major psionic with the following abilities: Starts with empathy, bio-regeneration (self), mind block, sixth sense, and telepathy between their own race only.

*Females* also have the powers of healing touch, psychic purification and telekinetic force field, plus two of choice from healing or sensitive **categories!**

*Males* have the power of Psi-sword which appears as a long unicorn-like energy blade on the top of their head, plus two of the powers of choice from the physical category.

**I.S.P.:** Mental endurance +1D4x10 +2D6 per level of experience. Average level of experience is 1D4+3 for adults (4+ years old).

**Vulnerabilities:** As per a normal horse the Psi-Ponies do not have hands although some can overcome this with the psionic power of telekinesis or ectoplasm.

**R.C.C. Skills:** Land navigation (+20%), wilderness survival (+20%), astronomy (+15%), identify plants & fruit (+15%), herd cattle (+20%), track animals (+10%), basic math (+10%), plus understands 1D4 languages of choice (+20%). As a loyal friend that always a **humanoid** to ride it, the rider enjoys +5% on all riding skills (-15% if the creature doesn't want to be ridden).

**Enemies:** Psi-Ponies are herbivores and do not prey on any other animals. Large predators are among their natural enemies, including **Panthera-Tereon**, **Leatherwings**, lions and pack dinosaurs. Humanoids are also danger because they

often try to capture and force Psi-Ponies into slavery but are frequently hunted by man in an attempt to tame them. The Coalition is the only real enemy the Psi-Ponies fear and will attack them on sight.

**Allies:** Often work with Cyber-Knights and may become partners with or help compassionate lawmen and other good (or aberrant) characters who don't try to enslave, imprison or make them do things they does want to do or be party to. Many Psi-Ponies also dislike violence and wanton bloodshed.

**Habitat:** Scattered throughout the New West and Southwest Canada; there may be as many as half a million.

---

## Phantasm

---

Phantasms are creatures of magic and insanity. According to legend, to even look at one is to court insanity. Thankfully, this is not quite true, but close to it. The strange little creatures have the power to inflict magical (temporary) insanity on those who anger, upset, annoy or startle them. Their very appearance looks like something akin to the fanciful Jabberwocky from Lewis Carroll's imagination (is it possible Mr. Carroll had seen a Phantasm?). The creature is a twisted conglomeration of a dozen different animals, its head resembles both a duck and a reptile, atop its head are the horns of a ram, but in front of them is a pair of tiny goat's horns. Its head is crowned with a scraggly mane of black hair that runs down a long neck like a giraffe's. The eyes are huge and round, reminiscent of a crab's. Its forked tongue is long and thin like a snake and flails around like a cracking whip when the Phantasm speaks. The right scrawny arm is vaguely human, although it has only two fingers and an oversized thumb, the hand on the other arm has a deformed crab's claw. Behind its shoulders are a pair of tiny, deformed wings with white feathers but incapable of flight, although the Phantasm can fly! The legs are twisted, making only a slow, waddling walk possible, the feet are those of a lion or similar predator and from its bottom snakes a dragon-like tail.

When the Phantasm speaks, it is typically in a quick, excited voice, interrupting its own words with mumbled asides and sudden changes of subject — Phantasms easily forget what they were talking about, and rather than pause and try to collect their thoughts, they segue onto a different thought or new subject entirely. They also tend to ramble on and on, even when answering what should be a simple yes or no question — it is said yes and no are not in its vocabulary. This rambling, nonstop mania is often what provokes people to scream or lash out at these annoying creatures, and that's when trouble starts. A Phantasm will defend itself with magic or psionics that bedazzles the mind or punishes the body. Likewise, they'll hurt and torment others when angry, embarrassed or to get something the Phantasm wants. They are expert at playing the witless fool and bumbling cripple, but in reality, they are cunning, resourceful, selfish and far from helpless.

Phantasms love magic items and high quality gems, and spend much of their time searching for them. Once found, the strange little creature steals them, using magic and psionics as necessary. Once in a Phantasm's possession, it takes nothing short of an act of god to get them back. Getting something from

a Phantasm usually requires bribing it with something much more amazing, powerful, rare or worth 20-100 times more (and one better be certain the item can't be stolen, otherwise the Phantasm will just take it too). If one is powerful and dangerous enough, threats and torture may also suffice and get the thieving critter to relinquish one or more of its possessions. Like most dragons, the Phantasm keeps its treasure hoard locked safely away in a pocket dimension that only it can access, however, it cannot flee to this dimension as long as it is touching the physical world (standing on the ground, chained or tied, held, etc.).



Even when it can access the pocket dimension, it can only stay for 2D4 minutes before popping back at the exact location from which it disappeared. Ironically, because the Phantasm is a "collector," once in his collection, these items are *never* used for fear of damaging or losing them.

### Phantasm NPC and/or Villain

**Alignment:** Generally anarchist or miscreant.

**Attributes:** I.Q. 2D6+8, M.E. 2D6+6, M.A. 2D6+4, P.S. 1D6+4, P.P. 2D6+6, P.E. 2D6+8, P.B. 1D4, Spd. 1D6 walking, 11 flying (7.5 mph/12 km). A supernatural creature.

M.D.C.: 6D6 +P.E. attribute number +1D6 per level of experience (P.E.+6 H.P. and 5D6 S.D.C. with an A.R. 10 on S.D.G. worlds). **Horror/Awe Factor:** 11

P.P.E.: P.E. attribute number x10 plus 3D6 per level of experience.

Size: 4 feet (1.2 m)

**Weight:** 30-50 pounds (13.6 to 22.6 kg)

**Average Life Span:** Unknown. Lives thousands of years.

**Natural Abilities:** Nightvision up to 2000 feet (610 m), see the invisible, keen vision, good hearing, fly at will (maximum altitude is 200 feet/61 m), and bio-regenerates at a rate of 3D6 M.D. per melee round!

**Induce Insanity (special):** A magic power that counts as a curse spell and costs 20 I.S.P.; duration: 1D4 hours but can be cancelled by the Phantasm at any time. This magic induces one of the following, as desired by the Phantasm:

**Paranoia:** Victim can't sleep, nervous, doesn't trust anybody (except the Phantasm), not even friends — they're out to get him!

**Obsession:** The Phantasm can make the character obsessive about a particular object (usually to trick the person into stealing something he wants) or person.

**Phobia:** Terrified of a particular item (avoids it), person, creature or the Phantasm — screams in horror and tries to flee. If flight is not possible, cringes in a corner, whimpering and crying.

**Panic Attack:** The victim can't catch his breath or think clearly; **panicky:** Reduce all combat bonuses, attacks per melee, and skills by half. These attacks always have a trigger: a particular word spoken by the Phantasm, a specific person/creature or specific event like combat.

**Schizo:** Hears voices that encourage the character to do things contrary to his or her alignment.

**R.C.C. Combat:** Three hand to hand or psionic attacks per melee, or two by magic.

**Damage:** Bite 4D6 S.D.C., punch or peck 1D6 S.D.C. or by magic or psionics.

**Bonuses (in addition to attributes):** +1 on initiative, +3 to save vs illusionary magic, +1 to save vs all other types of magic, +8 to save vs possession and mind control, +7 to save vs Horror Factor, and impervious to poison and disease.

**Average level of experience:** 1D4+4; use the same experience table as the dragon.

**Magic:** Blinding flash, globe of daylight, cloud of smoke, ignite fire, armor of Ithan, befuddle, wisps of confusion, carpet of adhesion, blind, mute, agony, trance, calling, compulsion, luck curse, minor curse, curse: phobia, remove curse, memory bank, tongues, time slip, **teleport:** lesser, mystic portal, and dimensional portal.

**Psionics:** Master psionic, with the powers of bio-manipulation, mind bolt, mind wipe, mentally possess others, mind block auto-defense, group mind block, hypnotic suggestion, levitation, ectoplasm (handy for picking pockets and stealing), telekinesis (lesser) and astral projection.

I.S.P. M.E. x3 plus 2D6 per level of experience.

**Vulnerabilities:** Rune weapons and those made from the Millennium Tree do double damage.

**Skills:** Basic math at 98%, speak and read American and Dragonese at 98%, brewing (+10%), cooking (+10%), palm-reading (+10%), pick pockets (+15%), pick locks (+10%), street-wise (+10%), **cardsharp** (+15%) and ventriloquism (+20%). Has little use for human skills.

**Allies:** May ally with (or con) anybody if the creature takes a liking to that person or to trick and use a character(s) to get what it wants. Tends to avoid practitioners of magic because they are bad sports and vengeful.

**Enemies:** Does the average Phantasm really have any friends?

**Value:** Absolutely none! Best to be avoided.

**Habitat:** Can appear just about anywhere, but seems to like the New West.

---

## Rhino-Buffalo

---

The Rhino-Buffalo is a powerful and feared monster from a Rift. It has adapted well to the Earth's altered environment and inhabits the plains, low mountains and light forests where other giant animals are found. The horrendous predatory beast preys on dinosaurs and other large mammals like buffalo, elephants, and even **Leatherwings** and Brontodons. Occasionally, an old, sick or wounded Rhino-Buffalo will attack humanoid travelers and even raid urban communities, but such attacks are not common. However, they will attack adventurers travelling in giant robot vehicles! The beasts are not particularly intelligent and often mistake giant robots as potential dinner or rivals. Because the animals tend to become frenzied when locked in combat, they will frequently fight to the death (01-70%).

Although the name would suggest that the animals travel in large herds like buffalo, the Rhino-Buffalo is an aggressive and solitary hunter. One must remember that both the rhinoceros and the buffalo are grass eating, grazing animals, while the Rhino-Buffalo is exclusively a meat-eating predator and has nothing more than superficial physical features in common with the two animals whose names it bears. The Rhino-Buffalo will always hunt alone unless it is mated (they mate for life), in which case the two will travel in pairs or a small family group of four; mated pairs sometimes hunt together with other mated pairs. The monster can bear young once every two years. The young usually stay with the parents for the first three years, before moving off on their own.

### Rhino-Buffalo NPC Animal/Monster

**Alignment:** Animal predator, considered anarchist or miscreant.

**Typical Attributes:** I.Q. Medium to low animal intelligence with a certain amount of cunning and tremendous ferocity, M.E. 2D6, M.A. 2D4, P.S.: 28+1D6, P.P. 16+1D6, P.E. 26+1D4, P.B. 1D4+1, Spd. 100+6D6 (typically around 110 or 75 mph/120 km). Supernatural P.S. and P.E.



**M.D.C. by Location**

\* Head — 60

\* Horn (1) — 30

Front Legs (2) — 90 each

Hind Legs (2) — 80 each

Main Body — 150 (2D4x10 H.P. and 2D6x10 S.D.C. with an A.R. 14 on S.D.C. worlds).

\* A single asterisk means a small or difficult target to hit and requires a "called shot" at -1 to strike.

**Horror Factor:** 16

**Size:** 25 feet (7.6 m) tall and 40 feet (12 m) long.

**Weight:** 5 tons

**Average Life Span:** 30-40 years.

P.P.E.: 1D4x10

**Natural Abilities:** Poor swimmers 35%, excellent climbers 85%, track by blood scent 66%, recognize the scent of human blood 66%, carnivorous (only eats meat, preferably human). The animal's legs are strong and adapted for leaping on top of its prey. Leaps are approximately 30 feet (9 m) high and 60 feet (18 m) lengthwise. A running leap at speeds in excess of

40 mph (64 km) will enable the monster to leap an additional 30 feet (9 m).

**Combat: Attacks per Melee:** Four

**Damage:** Claws: 4D6 M.D., bite: 2D6 M.D., stomp: 1D6 M.D., jab with horn: 2D6 M.D., ram with horn: 1D6x10M.D., but counts as two attacks; 01-88% likelihood that the victim is knocked down, or hurled 20 feet (6 m), and loses one melee attack.

Ram with body: 1D4x10M.D., but counts as two attacks; 88% likelihood that the victim is knocked down, or hurled 20 feet (6 m), and loses one melee attack.

Leap attack with claws: 1D4x10 M.D., but counts as two attacks. Opponents who are 20 feet (6 m) or smaller are likely to be knocked down (01-80% chance), losing one melee attack and may be pinned and unable to move/attack/dodge (01-55% chance). The monster can bite or jab its pinned victim with its horn until it gets off, is forcibly removed, or attracted by a different target.



**R.C.C. Bonuses:** +2 on initiative, +4 to strike, +4 to parry and dodge, +3 to roll with punch, fall or impact, +6 to save vs poison and disease, +9 to save vs horror factor.

**Allies:** None; animal predator.

**Enemies:** Favorite prey include **Leatherwings**, Duckbilled Honkers, Giant Canyon Worms, Mammoth Brontodons, Tri-Tops, buffalo and other large herd animals.

**Value:** None per se.

**Habitat:** Likes mountains, hills and rocky terrain with light forests and open grasslands, but are also found in the hot arid plains of New Mexico, Arizona, Lone Star and Central America (but not as common as in the northern part of the country). The Rhino-Buffalo is common along the Rocky mountains and the old American States of Montana, Wyoming, Colorado, Nebraska, the **Dakotas** and into Canadian Alberta and Saskatchewan (most believe the creature originated from the Calgary Rift). However, the monsters have travelled as far east as Ontario and the old American States of Pennsylvania, Maryland, the Virginias, and even into the **Carolinas**, Georgia, and upper Florida, although their numbers are comparatively small in these areas.

**Note:** Simvan warriors sometimes use the Rhino-Buffalo as a ferocious riding animal or as a giant watchdog.

---

## Silonar

---

The Silonar is a theropod dinosaur-like, warm-blooded animal with massive, powerful hind legs and tiny front arms. They are indigenous to the Palladium world where they are used as riding animals and watchdogs by a race of beings known as the Eandroth. Male **Silonars** are covered in small gold scales with brown and reddish-brown markings and the occasional hint of green or blue. The underbelly is a creamy tan or whitish grey color. Females are roughly the same size but have light, dull green, or grey-green, scales with gold and brown markings. Both have dark red (almost black) eyes. The males also have a tiny pair of bony horns on the tip of their nose while the females have a similar bony outcropping on the top of their head (3-6 small horns forming a ridge down the center of the head). These **theropods** are extremely hardy and can survive up to three weeks without water and will travel, without rest, for up to 10 hours in a single day.

The major problem with anybody using the Silonar as a riding animal, other than Eandroth and Simvan, is the beast's incredible stupidity and mean nature. They are nearly as dumb as a rock and cannot be domesticated very well. They accept nobody as their master and are seldom submissive. They have to be "reminded" who's the boss virtually every time they are mounted. To do so, the Eandroth riders punch the Silonar between the eyes 2-6 times to stun the beast and to show him who is the master. Controlling the beast is often a matter of grabbing the head and twisting it in the desired direction. Likewise, to get the creature to stop or to stay, it is again necessary to punctuate the command by pounding on his rock hard skull to get the message across. Even Simvan are -20% on their exotic riding skill with these animals (others are -50%), and tend to consider them worthless.

Silonars are nasty, smelly, short-tempered creatures that will take a bite out of a rider any time the opportunity presents itself — males are only slightly more aggressive and cantankerous than females. In combat, the smell of blood will transform the Silonar into a seething, uncontrollable beast hungry for a fight and the taste of flesh and blood. The Eandroth like this, and are known to set their riding beasts loose to attack particularly stubborn or numerous enemies. Surprisingly, a Silonar can become very attracted, loyal and affectionate to its Eandroth rider after a few years, not that such affection will prevent the beast from biting its master when aggravated.

### Silonar NPC Animal/Monster

**Alignment:** Considered anarchist or miscreant.

**Attributes:** Animal attributes are very consistent and offer a smaller range of attribute aptitude. I.Q. Low animal intelligence, M.E. 1D6, M.A. 2D6, P.S. 22+1D6, P.P. 18+1D6, P.E. 20+2D6, P.B. 2D6, Spd 34+4D6; a minimum speed of 38 (26 mph/41.6 km), most have a speed of 44 to 55.

**Mega-Damage Creature:** 3D6x10 on Rifts Earth (6D6+14 H.P. and 4D6+40 S.D.C. with an A.R. 10 in S.D.C. worlds)

**Horror Factor:** 13

**Size:** 8 to 9 feet (2.4 to 2.7 m) at the shoulders.

**Weight:** 400 to 800 pounds (180 to 360 kg)

**Average Life Span:** 50 years.

P.P.E.: 2D6

O.C.C.: None; animal.

**Natural Abilities:** Excellent speed, can run without pause and without exhaustion for 10 hours, leap up to 20 ft (6 m) lengthwise and 10 ft (3 m) high. Can go without food or water for a week without ill effect; eats just about anything from carrion and shrubs to fresh kills of animals, large and small — humans included. Smell blood up to one mile (1.6 km) away, can track blood scent 55%. The smell of blood and the sight of combat sends the creature into a killing frenzy; unless restrained, it will attack.

**Attacks Per Melee:** Four

**Damage:** Bite does 1D6 M.D., clawed feet 2D6 M.D., tail slash 2D6 S.D.C. plus P.S. bonus, small fore claws 4D6 S.D.C. plus P.S. bonus, and head butt 2D4 S.D.C.

**Bonuses:** +1 on initiative, +1 to strike and parry, +3 to dodge, +6 to save vs psionic attack (too stupid) and +12 to save vs horror factor — fearless (and stupid). These are all in addition to any possible attribute bonuses.

**Magic:** None

**Psionics:** None

**Enemies:** Large predators and humanoids.

**Allies:** None

**Value:** On Rifts Earth, most people consider them a worthless and dangerous predator, particularly of children and livestock. The Silonar are so stupid, aggressive, mean and unpredictable that they make poor riding animals and worthless pets.

**Habitat:** Deserts and grasslands of all kind. The dinosaur-like Silonar cannot survive in climates cooler than 40 degrees Fahrenheit. Cold desert nights followed by hot days are easily tolerated, especially if the animal is covered or otherwise sheltered; 3D4 days of *constant* cold temperatures will kill the beast. On Rifts Earth, Silonar are found west of the Rocky Mountains: Nevada, Utah, Arizona, western Colorado, Idaho, Northern Mexico, and parts of California.

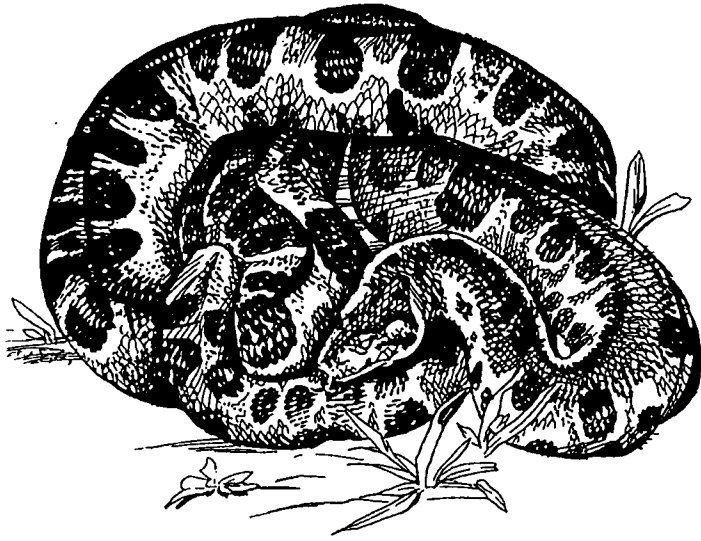

## Scorpions & Snakes

Ordinary Earth scorpions are common throughout the American Southwest and Mexico. Although most Easterners believe the scorpion's poisoned sting is deadly, but is so only if a person has an allergic reaction (which can be deadly). The sting from any of the 20 species of scorpions that inhabit Arizona and New Mexico is not lethal to most adults, but does cause nausea and headache: -2 on all combat bonuses, -10% on skill performance and reduce speed by 10% for 1D4 hours.

Five or more stings can be lethal and at best, causes extreme nausea, fever and migraine: no combat bonuses, only one attack/action per melee, and reduce speed and all skill performance to 20% for 1D4×10 hours. Roll once every four hours to see if the victim of these multiple stings lapses into a coma. If so, the character's player must roll to save vs coma and death. A failed roll means death. Also note that one or two bites on a child will have the serious effects noted here and is much more likely to cause a child's death. Four or more is usually lethal. Scorpions are extremely common along the bottom of the Grand Canyon, southwest Arizona, New Mexico and Northern Mexico.

Note the same is true of rattlesnake bites, but the snake's venom is much stronger so three bites put the character in danger of coma and death (as above). **Note:** The bite of a Tarantula spider causes swelling, itching and a rash, but is not deadly.

### Scorpion

**Size:** up to 5 inches.

**Weight:** A few ounces.

**A.R.:** 6

**Hit Points & S.D.C. Combined:** 2

**Attacks Per Melee:** 2

**Damage:** Stinger does one point of damage, plus venom causes 1D6 points of additional damage direct to hit points each melee round for 1D4 melees, unless a save vs poison (14 or higher) is made. Reduce poison damage by 75% if save is good.

**Bonuses:** +2 to strike and +3 to dodge.

**Natural Abilities:** Prowl 95%, climb 80%, and swim 30%.

**Speed:** 4

**Average Life Span:** 1-2 years

**Value:** None

**Habitat:** Varied; arid land and semi-tropical to tropical forest.

**Behavior:** These creatures generally live under and in refuse where they hunt their prey.

### Rattlesnake: COTTONMOUTH

**Size:** 1½-6 feet (0.4 to 1.8 m)

**Weight:** 2-8 pounds (1 to 4 kg)

**A.R.:** Not applicable.

**Hit Points:** 2D6

**S.D.C.:** 1D6

**P.P.E.:** One point

**Horror Factor:** 12

**Attacks Per Melee:** 1

**Damage:** Bite does 1D4 points of H.P./S.D.C. damage, plus 1D6 additional points of damage direct to hit points per each 1D4+2 melee rounds unless a successful save vs lethal poison (14 or higher) is made *each* melee. Reduce damage by 75% if save is a success.

**Bonuses:** +2 on initiative, +4 to strike, +1 to dodge.

**Natural Abilities:** Prowl 80%, swim 80%, climb trees 40%, nightvision 30 feet (9 m), heat sensor in its "pit" organs enables the snake to see the heat signature of its prey (+2 to strike) even in total darkness.

**Speed:** 7 on land, 5 in water.

**Average Life Span:** 10-15 years.

**Value:** 15-20 for meat (tastes like chicken), skin and medical purposes.

**Habitat:** Marshes, streams, lakes, and swamps.

**Behavior:** These snakes spend most of their time in or around water. The venom destroys red blood cells and coagulates the blood around the bite. Its venom is used medically for its coagulating properties.

### Rattle Snake: DIAMONDBACK

**Size:** 3-8 feet (0.9 to 2.4 m)

**Weight:** 3-12 pounds (1 to 5 kg)

**A.R.:** Not applicable.

**Hit Points:** 2D6

**S.D.C.:** 1D6

**P.P.E.:** One point

**Horror Factor:** 12

**Attacks Per Melee:** 1

**Damage:** Bite does 1D4 points of H.P./S.D.C. damage. Venom does 1D6+1 points of additional damage direct to hit points for every melee for 2D4 melees, unless a successful save vs poison is made *each* melee round. Reduce damage by 75% if the save is a success.

**Natural Abilities:** Prowl 80%, swim 40%, climb 70%, nightvision 30 feet (9 m), heat sensor in its "pit" organs enables the snake to see the heat signature of its prey (+2 to strike) even in total darkness.

**Speed:** 8

**Average Life Span:** 8-16 years

**Value:** 5-15 credit for the skin.

**Habitat:** Woodlands and farmlands.

**Behavior:** This dangerous rattler preys on rabbits and birds. The characteristic rattle is a warning it uses whenever the snake feels threatened. The rattle can be heard up to a distance of 60 feet (18.3 m).



## Tiger Claw Raptor

Tiger Claw Raptors are small, man-sized theropod carnivores that hunt alone and in packs of 6-16. As is typical of this breed of animal, they have powerful hind legs designed for running and leaping, with small, clawed front arms for tearing apart the carcass of their prey. The Tiger Claw Raptor gets its name from the color of its hide, which is an orange to light reddish tan color accented with black stripes. Although a single human clad in good body armor and a pair of **Vibro-Blades** is a match for one Raptor, he will be torn to shreds by a group as few as three or four. The cunning pack animals use group tactics, with 2-3 striking simultaneously from different sides, and/or taking turns, tag team style. Against large prey like **Tri-Tops** and **Duckbilled** dinosaurs, 3-6 will leap on the back while one or two will strike at the legs, throat and underbelly. A pack of 10-16 have been known to bring down a **Duckbill** in less than two minutes, a buffalo, horse, or **Desert Sleeper** in 30 seconds, and even take down a **Rhino-Buffalo** or **Tri-Tops** within 8-10 minutes! These bold tactical studies groups are known to even attack the **Mammoth Brontodon**, **Leatherwings** who stay on the ground too long or fly too low, and even challenge groups of **Grigleapers**, **Silonar** and **Ostrosaurus**. A lone horseman is seen as easy pickings and a pack of T.C. Raptors will eye adventurer groups and **Mountain Giants** as potential targets.

They are referred to as tactical study groups because the predators typically track and observe their prey for as long as five hours, studying their formation (if a group or herd), picking out the easiest targets (typically the smallest, sick/injured and

stragglers), waiting for the most advantageous place and moment to strike, and often test the prey with mock runs to see how it or they react and to make adjustments for the real battle. They even use simple combat tactics like ambush, flanking, surprise and divide and conquer.

The bigger the pack, the more daring and deadly the creatures become. For example, a pack of 4-6 are likely to back down for an equal number of **humanoids**, but a pack of 8-10 will make aggressive gestures and runs at their human opponents to test their strength; any sign of weakness will incite a full-scale attack. Meanwhile, a pack of 12-16 are generally willing to take on any living creature, dragons included, and any group of **humanoids** of a dozen or less. The rare group of 20-30 **Tiger Claw Raptors** will challenge a platoon of **CS troops**. The large groups are uncommon because there are too many challenges for leadership and the development of subgroups that challenge the dominant pack members. The leader and second in command of every pack will be the two largest females. **Note:** Females are 20% larger than males and have 20 more M.D.C. than described below. They lay 2D4 eggs once a year.

### Tiger Claw Raptor NPC Animal/Monster

**Alignment:** Considered miscreant or diabolic.

**Attributes:** Animal attributes are very consistent and offer a smaller range of attribute aptitude. I.Q. High animal intelligence, M.E. 10+1D6, M.A. 2D6, P.S. 19+1D6, P.P. 19+1D6, P.E. 19+1D6, P.B. 2D6+4, Spd 44+2D6; an average speed of 50 (35 mph/56 km).

**Mega-Damage Creature:** 6D6+34 on Rifts Earth (4D6+20 H.P. and 3D6+12 S.D.C. with an A.R. 9 on S.D.C. worlds).

**Horror Factor:** 9 for one, 12 for a pack of 4-8, H.F. 14 for 10+. Size: 5 to 6 feet (1.5 to 1.8 m) tall, plus a thin tail the same length as the body.

**Weight:** 120 to 180 pounds (54 to 81 kg).

**Average Life Span:** 35 years.

**P.P.E.:** 2D6

**O.C.C.:** None; animal.

**Natural Abilities:** Excellent speed, can run without pause and without exhaustion for 8 hours, leap up to 15 ft (4.6 m) high and 20 feet (6 m) long (increase by 30% when running at maximum speed). Can go without food or water for two weeks without ill effect; eats live prey and carrion (frequently takes the kill of other lone predators or small groups). Smell blood one mile (1.6 km) away, can track blood scent 65%, track animals and humanoids by scent and vision 65%, prowl 86%, detect ambush 76%, and climb 75%/25%.

**Vulnerability:** Cannot swim and tends to underestimate humanoid opponents.

**Attacks Per Melee:** Four

**Damage:** Bite does 2D6 M.D., clawed feet 2D6 M.D., tail slash 2D6 S.D.C. plus P.S. bonus, small fore claws 4D6 S.D.C. plus P.S. bonus, and head butt 2D4 S.D.C.

**Poison Spit (Special):** A sack under the T.C. Raptor's jaw can regurgitate a poison to be spit in the face/eyes of prey. This foul smelling liquid has the same basic effect as mace, causing the eyes to burn and blinding victims until the spittle is washed away (rubbing the eyes only makes matters worse, double duration). Spitting range: 20 feet (6 m), duration of blindness: 16+2D4 minutes or until washed away, whichever comes first.

**Bonuses:** +4 on initiative, +2 to strike and parry, +3 to dodge, +6 to save vs horror factor — fearless in large packs. These are all in addition to any possible attribute bonuses.

**Magic:** None

**Psionics:** None

**Enemies:** Other predators and humanoids.

**Allies:** None, other members of their own species.

**Value:** None, although Simvan sometimes use them as hunting animals, retrievers and guard animals.

**Habitat:** Deserts and grasslands to forest and city ruins. Dislike cold climates and often migrate with the herds and weather. Also dislike mountainous terrain. Most common in Arizona, New Mexico, Lone Star, Oklahoma, Colorado, Kansas and Nebraska, as well as the southeastern territories (Arkansas, Louisiana, Florida, etc.).

**Note:** T.C. Raptors are terrified of magic and will either flee the moment magic spells are used against them or attack the one casting the magic (if he is too elusive or powerful, they flee). Likewise, they can sense a ley line storm 3D4 minutes before it arrives and flee from its fury.

## Tree Spiders

Tree Spiders get their name not because they live in trees, but because they are as *tall* as trees! They walk on strong stilt legs that are 150 feet (46 m) tall. At the top is the green or pale gray body of the alien spider. Two large eyes with six small ones are on the front-top with another two large and four small eyes on

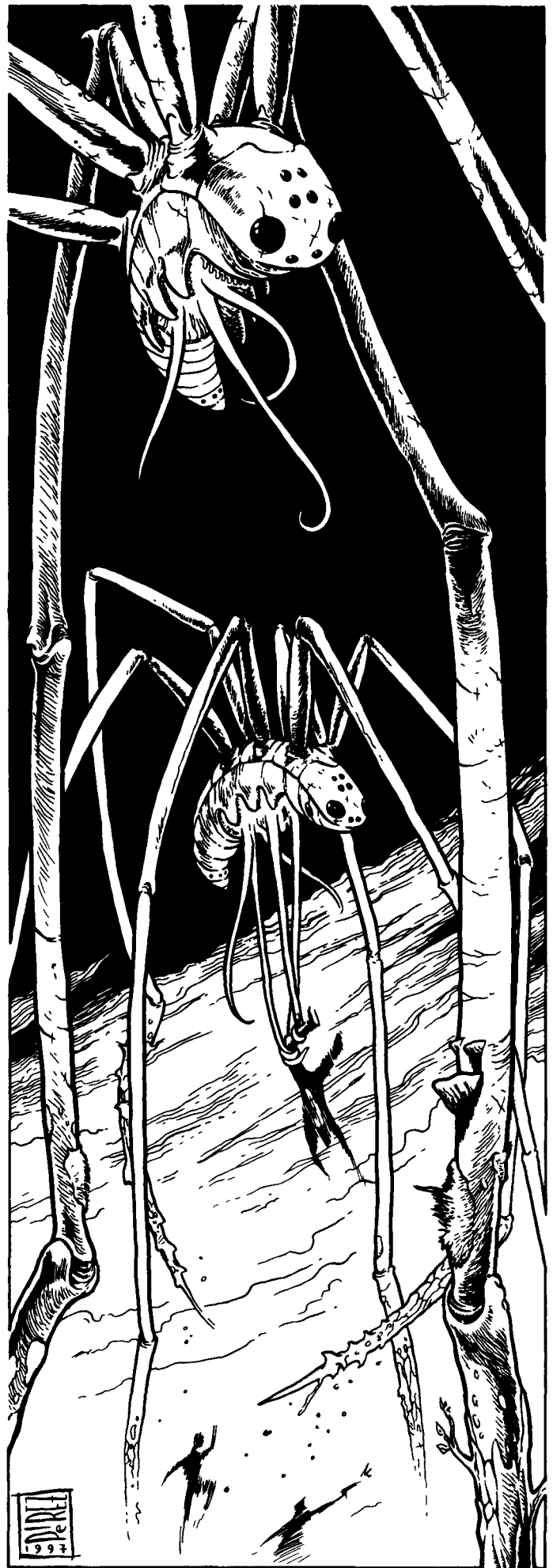

the bottom (looking down), allowing the creature to monitor both the sky and the ground.

These creatures are not spiders at all, but some sort of alien predator that resembles giant, stilt-legged spiders. Unlike true spiders, these giant predators only have six legs and retractable tentacles that extend from their abdomen; females have four tentacles, males six. The tentacles can reach 150 feet (46 m) and are lightning fast and used to snare prey and pull them back up to the abdomen where a concealed, devouring mouth is located! Because these entangling attacks come from above, prey are usually caught by surprise. A common ploy is for the Tree Spiders to stand motionless (some times in the same location for days), waiting for prey to wander into their reach. Prey includes birds, squirrels, deer, wild horses, pigs, cattle, and mammals of all kinds, including humans. Humans and D-bees are among the Tree Spiders' favorite. They also move slowly and quietly, and sometimes sneak up on sleeping cowboys driving a herd and snatch them from their sleeping place — the Spiders have learned to recognize the sounds cattle make and know that easy food awaits them. If the cowboys should escape, the giant predators lurch on cattle, an acceptable alternative to human prey. In fact, many Tree Spiders have learned cattle trails and stalk them — sometimes they are so bold as to raid ranches! They snatch Saddle Tramps, Indians and adventurers in a similar fashion.

The Tree Spiders tend to avoid targeting predators, large and small, so dogs, wolves, lions, etc., are generally safe from them. The Spiders typically hunt in threes, but sometimes gather in groups of 6-12. Tree Spiders lay clutches of 4D4 eggs high in the mountains or in the ruins of skyscrapers — they may also inhabit ancient ruins.

### Tree Spider NPC Animal/Monster

**Alignment:** Alien predator generally considered Diabolic.

**Attributes:** Animal attributes are very consistent and offer a smaller range of attribute aptitude. I.Q. Low animal intelligence, M.E. 1D6, M.A. 1D4, P.S. 25+1D6, P.P. 19+2D4, P.E. 18+1D6, P.B. 1D4, Spd 3D6+6; supernatural P.S. and P.E.

#### Mega-Damage by Location:

\* Eyes (10) — 10

\* Tentacles (4 or 6) — 42 each

Legs (6) — 175 each

Main Body — 200 +3D4x10 (150 H.P. and 4D4x10 S.D.C. with an A.R. 14 on S.D.C. worlds).

\* A single asterisk means a small or difficult target to hit and requires a "called shot" at -3 to strike.

**Horror Factor:** 15

**Size:** Stand 150 feet (46 m) from head to toe. Tentacle can reach 150 feet (46 m).

**Weight:** 1000pounds (450 kg)

**Average Life Span:** 30-50 years

P.P.E.: 1D6x10

O.C.C.: None; animal.

**Natural Abilities:** Prowl 70%, track by smell 70%; silent until it attacks with the tentacles and then makes a slobbering sound. Keen hawk-like vision (can see a human two miles/3.2 km away), resistant to heat and cold (half damage), impervious to poison, bio-regenerates at a rate of 1D6x10 M.D.C. per 24 hours and can regrow tentacles in a matter of 3D6 days. Eyes cannot be regenerated but legs can be regrown in a few months. Can go without food or water for eight weeks with-

out ill effect. Their legs are segmented and can bend at six junctions, enabling the Tree Spider to lower itself to ground level if so desired (usually to hide).

**R.C.C. Combat: Attacks/Actions Per Melee:** Females: 5; Males: 7

**Damage:** Tentacle strike 3D6 M.D., power punch 6D6 M.D., stomp or leg strike 3D6 M.D., bite from the giant concealed mouth (big enough to bite a man in half) does 6D6 M.D.

**R.C.C. Bonuses:** +1 on initiative, +5 on initiative from a silent tentacle attack (successful prow), +3 to parry with tentacles, the tentacles can dodge at +4, and +7 to save vs horror factor. These are all in addition to any possible attribute bonuses.

**Magic:** None

**Psionics:** None

**Enemies:** Few natural enemies on Rifts Earth; Grigleapers, T-Rex, and Leatherwings sometimes attack them, and vice versa.

**Allies:** None

**Value:** None; their meat is poisonous to humans and most D-bees.

**Habitat:** These other-worldly visitors are likely to have emerged from the Calgary Rift because they are found throughout the forests of lower Canada and the Northern States of the old American Empire.

In the West, they are common to Nebraska, the Dakotas, Colorado, Wyoming, Montana, Idaho, Washington and Oregon, as well as Minnesota, Michigan, and the southern half of Canada.

---

## Tri-Tops

---

Whether these are ceratopid dinosaurs from Earth's past or similar creatures from another world is unknown. They are large, rhinoceros-like herbivores with a large protective shield of bone and spikes covering its neck and shoulders, and three wicked horns (3-4 ft/0.9 to 1.2 m long) to fight off predators. They eat grass, weeds, pine cones, nuts, berries, ferns and various other plants found on the Western plains and in mixed forests. Tri-Tops travel in herds as small as 30-80 to as many as 1000 animals — they are often seen grazing with buffalo and other grazing animals. They are preyed upon by large predators of all kinds, as well as pack hunters like the Tiger Claw Raptor, Ostrosaurus and Grigleapers. Truth be told, they have their best chance against the large predators than the pack hunters. Simvan and some Indians, Psi-Stalkers and even human ranchers have come to herd these behemoths like cattle; their meat is delicious and females can produce gallons of milk a day!

Tri-Tops rarely fight unless panicked, backed into a corner, attacked, or defending its nest or young. Generally they ignore small, unmounted humanoids, and back away from danger whenever they can. However, they are not cowards and will stand their ground and even fight to the death when necessary.

### Tri-Tops NPC Animal/Monster

**Alignment:** Considered anarchist.

**Attributes:** Animal attributes are very consistent and offer a smaller range of attribute aptitude. I.Q. Medium animal intelligence, M.E. 1D6+6, M.A. 2D6+6, P.S. 28+2D6, P.P. 14+1D6,



P.E. 18+1D6, P.B. 3D6, Spd 34+3D6; a minimum speed of 38 (26 mph/41.6 km), most have a speed of 40 to 44 (about 30 mph/48 km).

**Mega-Damage by Location:**

Head — 200

\* Horns (3) — 60 each

\* Front Legs (2) — 110 each

Hind Legs (2) — 160 each

\* Underbelly — 120

Main Body — 200+1D4×100 (100+3D6×10 H.P. and 4D6×10 S.D.C. with an A.R. 13 on S.D.C. worlds).

\* A single asterisk means a small or difficult target to hit and requires a "called shot" at -3 to strike.

**Horror Factor:** None

**Size:** 6 feet (1.8 m) tall at the shoulders, 25-30 feet (7.6 to 9 m) long

**Weight:** 4-5 tons

**Average Life Span:** 50 years

P.P.E.: 5D6

O.C.C.: None; animal.

**Natural Abilities:** Excellent speed, can run without pause and without exhaustion for four hours, likes to wade in water and can swim at 55%, hold breath underwater for 1D4+1 minutes, and although constantly eating, can go without food or water for up to three months without noticeable effect.

**R.C.C. Combat: Attacks/Actions Per Melee:** Three

**Damage:** Head Butt 1D6 M.D., jab with horns 2D6 M.D. (typically a warning), stab with horns 4D6 M.D., power stab

1D4×10+8, stomp 1D6 M.D., tail slash 2D4 M.D., and bite does 4D6 S.D.C.

A running head/horn ram (counts as two melee attacks): 2D4×10 and knocks human to Ostrosaurus-sized opponents 4D4 yards. With "small" opponents (including characters in M.D.C. body armor or power armor, cyborgs, Crazies and Juicers), be certain to attempt to roll with impact to reduce damage. Many small opponents are killed by this attack, although it is typically reserved for larger foes and for dispersing packs and groups of enemies. Humans in body or power armor must roll to save vs coma/death even if their armor holds. A failed save means 5D6 damage direct to hit points and S.D.C., 1D4 ribs are broken (reduce speed and all combat bonuses by half for 2 weeks) and the character is knocked out for 1D4×10 minutes!

**R.C.C. Bonuses:** +1 on initiative, +3 to strike and parry, +2 to dodge, +3 to roll with impact or fall, +2 to save vs disease and poison, and +5 to save vs horror factor. These are all in addition to any possible attribute bonuses.

**Magic:** None

**Psionics:** None

**Enemies:** Large predators, pack hunters (including Silonar and Raptors) and humanoids.

**Allies:** None

**Value:** 2000-4000 credits per animal. The meat is delicious, the protective plate collar can be used in armor, the horns for weapons and jewelry, and the hide can be used to make a light M.D.C. fabric (poncho or overcoat has 8 M.D.C., overcoat with extra armor padding 12-16 M.D.C., or tent with 15

M.D.C.). The **Simvan** and **Psi-Stalkers** ride them (they make fairly good, even-tempered mounts), and Simvan use them like cattle.

**Habitat:** Woodlands and scrub plains. Over a million are believed to be scattered between the Rocky Mountains and the Mississippi River, particularly in Washington, Oregon, Montana, Idaho, Wyoming, Colorado, the Dakotas, Minnesota, Nebraska, Kansas, and parts of Canada.

---

## Tyrannosaurus Rex

---

The Tyrannosaurus Rex is perhaps the most famous of all the dinosaurs and has captured the imaginations of people for centuries. That being the case, there isn't much to be said about the towering carnasaur. The T-Rex is both a hunter and a scavenger. Its favored prey are large animals that offer little or no danger to it, including buffalo, horses, deer and cattle. **Humanoids** can be easy prey too, except they often spit fire (energy weapons) and have tough shells (body and power armor). The Tyrannosaurus Rex also feeds on Duckbills, Leatherwings, and, although dangerous, cannot resist the sweet taste of Tn-Tops flesh.

Besides the gaping mouth filled with serrated teeth the length of daggers, one must beware of the beast's slashing tail and the claws of the hind legs.

### Tyrannosaurus Rex NPC Animal/Monster

**Alignment:** Considered Miscreant or Diabolic.

**Attributes:** Animal attributes are very consistent and offer a smaller range of attribute aptitude. I.Q. Medium to low animal intelligence, M.E. 1D6+6, M.A. 2D6, P.S. 50+2D6, P.P. 14+1D6, P.E. 23+1D6, P.B. 3D6, Spd 34+3D6; a minimum speed of 38 (26 mph/41.6 km), most have a speed of 40 to 44 (about 30 mph/48 km).

### Mega-Damage by Location:

Head — 280

Forearms (2; useless) — 40 each

Hind Legs (2) — 300 each

\* Tail — 220

\* Underbelly — 300

Mam Body — 400+1D4×100 (200+4D6×10 H.P. and 1D4×100 S.D.C. with an A.R. 12 on S.D.C. worlds).

\* A single asterisk means a small or difficult target to hit and requires a "called shot" at -3 to strike.

**Horror Factor:** 18

**Size:** 30 feet (9 m) tall and 50 feet (15.2 m) long!

**Weight:** 5-6 tons

**Average Life Span:** 25 years

P.P.E.: 5D6

O.C.C.: None; animal.

**Natural Abilities:** Good speed but can only run at full speed without exhaustion for 15 minutes, typically moves along at about half maximum speed. Can go without food or water for up to two months without noticeable effect (lives off the fat stored in its tail). The Tyrannosaurus has excellent hearing and an outstanding sense of smell: can smell blood and decaying flesh up to 1.5 miles (2.4 km) away, track by smell 80%, recognize scents 80% and is surprisingly fast and responsive for a creature its size.





**Vulnerabilities:** Soft underbelly, useless forearms, hates water and cannot swim.

**R.C.C. Combat: Attacks/Actions Per Melee:** Four

**Damage:** Head Butt 3D6 M.D., bite 2D4×10 M.D., claw attack with hind leg 1D6×10 M.D., kick 6D6 M.D. slashing tail 1D4×10M.D.

**R.C.C. Bonuses:** +3 on initiative, +2 to strike, +2 to roll with impact or fall, +5 to save vs disease and poison, and +10 to save vs horror factor. These are all in addition to any possible attribute bonuses.

**Magic:** None

**Psionics:** None

**Enemies:** Large predators, pack hunters (including Silonar and Raptors) and humanoids.

**Allies:** None; tends to be a solitary hunter or hunts in small groups of 2-4.

**Value:** Some owners of gladiatorial arenas will pay as much as 40,000 credits for a live and uninjured T-Rex (half for a juvenile); otherwise one can get 1000-2500credits per carcass for its teeth, skull, bones and skin. The meat of the T-Rex is chewy, fatty and bland, but edible.

**Habitat:** Can be encountered throughout the New West and southwestern Canada, but seems to be most numerous in Montana, Idaho, and Wyoming.

---

## Whisker Coyote

---

The Whisker Coyote is not a coyote at all, but a small dog-like creature from another world. Like most of the alien creatures transplanted through the Rifts, nobody knows where the Whisker Coyote comes from. The most likely culprits are the Shifting Lands, The Bend in the Pecos Empire, and/or the Calgary Rift, but honestly, they could have appeared through a dimensional portal from almost anywhere.

The general body shape and bulk of a Whisker Coyote is similar to a *Bull Terrier* with a long, stout body, four powerful but short legs, a short tail, long head and short fur. However, any impression at first glance that the Whisker Coyote is a Bull Terrier (or even a canine) vanishes when one gets a good look at the alien dog's(!?) head. The eyes are an eerie, translucent green, far back in its head, its nose is more like a bump with two holes in it, and the mouth — well, the snout ends in a quartet of prehensile tentacles that resemble whiskers, hence its name. The fur covered tentacles at the end of its snout are used to snatch, hold and shove small prey (rodents, snakes, lizards) into its mouth, but also function as feelers when navigating through pitch-black burrows and prowling around at night.

A Whisker Coyote, like most Earth canines, is both a predator and scavenger. As a predator it feeds on small animals (rodents, lizards, snakes, tortoises, birds, eggs, etc.), as a scavenger, it will eat just about anything — animal bones, rotting animal carcasses, human (and Fennodi) leftovers, garbage, fruit, nuts, and even certain varieties of cactus. Some people call them "walking garbage cans," but undoubtedly their willingness to eat almost anything combined with their cast iron constitution has helped them to survive and flourish in some of the most harsh and arid land in the country.



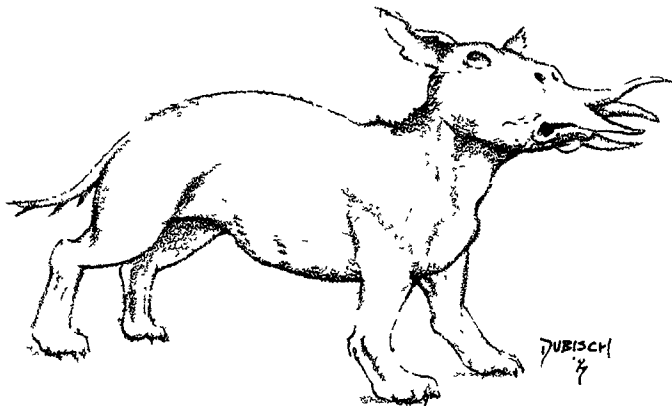

### Whisker Coyote NPC and/or Animal Companion

**Alignment:** Considered anarchist, unprincipled and scrupulous.

**Attributes:** Animal attributes are very consistent and offer a smaller range of attribute aptitude. I.Q. High animal intelligence, M.E. 1D6+12, M.A. 2D6+10, P.S. 1D6+10, P.P. 1D6+12, P.E. 2D6+12, P.B. 2D6+6, Spd 2D6+34; extremely smart for an animal and exhibits almost human intelligence, understanding, kindness and loyalty (roughly equal to a child). Usually protective of its humanoid companion(s), especially against the supernatural.

**Hit Points:** 5D6+6

**S.D.C.:** 4D6+6

**Natural A.R.:** 10

**Horror Factor:** 9

**P.P.E.:** 5D6

**O.C.C.:** None; animal.

**Size:** 3 feet (0.9 m) at the shoulders, 4 feet (1.2 m) long.

**Weight:** 40-55 pounds (18 to 24.7 kg)

**Average Life Span:** 25 years.

**Natural Abilities:** Excellent speed, can run without pause and without exhaustion for four hours, leap up to 8 ft (2.4 m) lengthwise and 4 ft (1.2 m) high. Can go without food or water for three days without ill effect; eats just about anything from carrion and shrubs to fresh kills of animals. Keen vision and sense of smell, track by scent 80%, swim 60%, prowl 55%, climb 65%, dig (live in burrows) at one quarter their running speed, and can see the invisible, including Astral beings, plus psionics. Whisker Coyotes growl, whimper, huff and puff when unhappy, grumble when curious or want attention, and unleash an ear-splitting, high pitched howl in warning or sorrow.

**Attacks Per Melee:** Three

**Damage:** Bite does 2D6 points of hit point/S.D.C. damage, small fore claws 1D6 damage.

**Bonuses:** +2 on initiative, +2 to strike and parry, +3 to dodge, +6 to save vs poison and disease, +1 to save vs psionic attack, +4 to save vs mind control and possession, and +3 to save vs horror factor. These are all in addition to any possible attribute bonuses.

**Magic:** None

**Psionics:** Whisker Coyotes are major psionics with the powers of sense evil, sense magic (both at triple the normal range), see aura, mind block and empathy. Plus, Whisker Coyotes are keenly aware of and sensitive to magic energy, ley lines and supernatural creatures; can sense them up to 1000 feet (305 m) away, can sense a ley line storm or dimensional anomaly

(including a Rift) up to a mile (1.6 km) away, can tell if they are getting closer, and whether they are weak, strong or extremely powerful creatures or forces. The Whisker Coyote can also see the invisible, entities, ghosts and spirits, and air elementals.

These alien canines also have a strange and inexplicable rapport with the Fennodi. The animal and the D-bee always take an instant liking to each other, the animal is obedient and loyal, learns things quickly and can sense when its "friend" or companion (rather than master) is frightened, sick, injured or needs them; 3000 foot (914 m) range — and vice versa! Ironically, the Whisker Coyote is *immune* to the psionic empathy and control of Simvan Monster Riders and Psi-Stalkers. Furthermore, the animal takes an instant dislike to them, avoids them and never willingly serves as their pet, servant or companion.

**I.S.P.:** M.E. x2 +1D4 per level of experience.

**Enemies:** Large predators and humanoids.

**Allies:** A strange attraction and friendship to Fennodi, and they also like humans and many types of D-bees, but dislike and fear Simvan, Psi-Stalkers, the Minions of Splugorth and all supernatural beings.

**Value:** 200-500 credits as watchdogs, herding animals and intelligent (for an animal) companions.

**Habitat:** Prefer prairies, grasslands and deserts but can flourish in just about any environment, including forests, modern cities and the Burbs. Not well suited for tropical or arctic climates (they even avoid Canada).

**Note:** There is an estimated 1-3 million Whisker Coyotes throughout the New West, south of the northern Territories, and perhaps another million in Mexico, but less than 100,000 east of the Mississippi which is too cold and/or forested for their taste.

---

## Worm Wraith

---

The Worm Wraith is a bizarre, sentient being many westerners consider a horrible demon. The strange creature derives its name from the fact that it appears to be composed of dozens of worms, the size of snakes, interwoven to create an undulating mass. Each "worm" is 8-12 feet (2.4 to 3.6 m) long and entangles and intertwines themselves with each other to form a humanoid body! Each worm is just one part of a much larger whole. Kill one or thirty and the body is somewhat diminished (for awhile), but it continues to function. Destroy all but a single worm, and that one creature will undergo a process in which it divides in two, and those two divide into four, and so on and so on. Within a period of 2D4 days, the Worm Wraith will have *re-grown* itself back into its human form. As if that isn't bizarre enough, many scientists and sorcerers have speculated that the humanoid embodiment of these worms are the creation and physical aspect of a single *alien intelligence*.

Others argue that as many as a dozen different alien intelligences may be responsible, but any way one looks at it, the hundreds (thousands?) of Worm Wraiths that wander the forests and plains of the New West are likely to be the product of 1-12 supernatural intelligences! If this is true, then these masses of alien worms pressed into humanoid form are actually the manifesta-



DUBISCH  
97

tion or extensions of a much greater, supernatural force. Whether this force is some sort of entity or flesh and blood embodiment of an alien intelligence like the ones that create vampires, is unknown. Whatever this creature may be, it has *never* been seen! In fact, it is very possible that the alien intelligence (or whatever it may be) exists or co-exists in another dimension.

The big question then becomes: "What is this intelligence's purpose? Why create a legion of human-like bodies and ride the range? What do they want? Why do they assume the bipedal human shape (they clearly aren't human)? Why do they do anything? For example, if the worms can divide and duplicate themselves so rapidly as to recreate a damaged body, why **not** continue the process and create millions of Worm Wraiths? Presumably it's because each individual worm is somehow connected to a specific Worm Wraith body. For example, not only don't the worms duplicate to make an endless legion, but worms from one body *never* join the worms of another. This would suggest some level of individual identity or some degree of physical or mental limitation. These are just a handful of the questions surrounding the Worm Wraiths. Unfortunately, the answers to these questions, and many more, may never be answered.

Of greater concern is the Worm Wraiths' agenda. They are enigmatic harbingers of destruction who seem to have only one purpose, to kill humans and human-like D-bees, including Psi-Stalkers, Dog Boys, Simvan and Fennodi. Why? Another unanswerable question. Nobody can remember any dispute or battle involving these creatures at any time in history — they just began to appear one day, killing. Although the Worm Wraiths feed on **humanoids** (as well as animals and carrion) they often murder without feeding and often slaughter large groups and besiege entire towns for no apparent reason. Worm Wraiths also exhibit a certain instinctual cunning and wickedness. They attack from the shadows, use the element of surprise, and hit and run tactics. They often strike when a traveler is alone, asleep, injured or distracted. They use ambushes and crossfires well and exhibit a fair to good sense of strategy and tactics. For example, Worm Wraiths will often stampede cattle and livestock to cause confusion, destruction and death, but also ride in with them or behind them or from another direction, and begin shooting and killing. Similarly, they will set a building or entire town on fire to "flush out" their prey. One famous story recounts how a gang of 30 or so, set the town church on fire during mass and stood silently in the street and behind buildings waiting for those inside to come running out. The only sound the Wraiths made were blasts from their guns — 133 people died that day. As usual, the murdering monsters didn't take any loot other than ammunition, E-clips, some additional weapons and a few extra horses.

In the northwest, Worm Wraiths are comparatively scarce and tend to hunt and murder as lone individuals, in pairs, or small groups of 1D4+3. Occasionally they associate with other supernatural beings or powerful sorcerers. They are rarely encountered east of Colorado.

In the Southwest, Worm Wraiths are an increasing problem. While they may strike as a lone individual, pair, or small group, they more often strike as a band of 12-36 on a bloody rampage of murder and destruction. They kill men, women, and children without hesitation or mercy, and strike at humans and D-bees alike, although humans and Psi-Stalkers seem to be their primary targets.

Worm Wraiths are quiet, stealthy and rarely make a loud sound — not in pain, not in fear, not in anger. Most believe this is because the worms are not capable of vocalization. However, when angry or cornered, the worms that compose their bodies vibrate and make a low hissing sound.

As a humanoid collective, the creatures almost always wear some sort of large covering, typically an overcoat (often the padded, armored one) or a poncho, along with a cowboy hat and boots. Occasionally, the Worm Wraiths will wear partial body armor too (chest plate and arm coverings). Whether they wear these things for protection (not likely), to look human, or as a mockery of humans is unknown. They also love conventional and energy handguns and rifles, as well as TWweapons.

### **Worm Wraiths NPC Monster & Villain** **Also Known as Worm Riders and Diablo Wraiths.**

**Alignment:** Diabolic

**Horror Factor:** 11+1D4.

**Average Size:** 6 feet (1.8 m)

**Weight:** 300 pounds (135 kg)

**Attributes:** I.Q. 2D6+4, M.E. 2D6+6, M.A. 1D6, P.S. 4D6+20, P.P. 2D6+10, P.E. 2D6+10, P.B. 1D4, Spd. 2D6+6; supernatural P.S. and P.E.

**Mega-Damage:** 4D4x10; roughly 3 M.D.C. per worm, with 40 to 60 worms per Worm Wraith.

**P.P.E.:** 4D6x10; roughly 1D4 per worm.

**Natural Abilities:** Good sense of hearing and keen vision and sense of smell, although nobody knows how they see or hear anything since they don't have any apparent sensory organs other than a scent mechanism. **Nightvision** 1000 feet (305 m), track by scent 60%, track blood or scent of decay 80%, impervious to disease and poisons, impervious to heat and cold, resistant to fire (half damage), bio-regenerate (each worm can regenerate one M.D.C. per hour plus full regeneration via physical division and multiplication), and they are psionic.

**Pair of Spies (Special):** The Worm Wraith can unravel and dispatch 2 or 4 of its worm-like body parts to silently scout ahead and spy on potential targets. The worms are silent (prowl at 90%), can climb (90%/70%) and are very patient. They can be called to their main body (how is anybody's guess) at will or follow a specific agenda (map out the lay of the land and return, etc.). Everything the worms see is known to the main body as soon as the worms reunite with the rest of the body. Thus, if these crawling spies are destroyed before they reach the body, the Wraith learns nothing. Note that the individual worms have no formidable attacks; slapping tail 4D6 S.D.C., head butt: 2D6 S.D.C., and entangle and constrict like a python (2D6 H.P./S.D.C. per melee round, but those completely entangled/wrapped cannot attack; a combined P.S. of 50 is necessary to pull the worm off its prey). Two or four worms are always dispatched, never less, and they always travel in a group; only one needs to return to impart their knowledge.

**Total Regeneration (Special):** As long as one worm survives it can undergo a process in which it divides in two, and those two divide into four, and so on and so on. Within a period of 2D4 days, the Worm Wraith will have *regrown* itself back into its full human form.

**Psionics:** A minor psionic with one I.S.P. per worm that composes its body (average 2D6+40). Powers include: Empathy,

object read, sixth sense, and mind block auto-defense, plus can telepathically communicate with the alien intelligence that created it (unlimited range) and other Worm Wraiths (500 ft/152 m radius).

**Magic:** Turn dead, repel animals, breathe without air, and shadow meld.

**Combat: Attacks per melee round:** Three at first level and +1 at levels 2, 4, 8, 12, and 15.

**R.C.C. Bonuses:** +1 to strike, +8 to save vs horror factor, impervious to all forms of possession; also see natural abilities.

**R.C.C. Skills:**

Prowl 80%

Land Navigate 90%

Wilderness Survival 90%

Intelligence 80%

Track humanoid 60%

Detect Ambush 60%

Climb 70%/60%

Swim 70%

Basic Math 80%

Horsemanship General

Horsemanship: Exotic

Paired Weapons, the same as the **Gunfighter**.

Quick Draw, the same as the **Gunfighter**.

W.P. Revolvers

W.P. Pistols

W.P. Two modern of choice.

Plus can select two Secondary Skills at levels 1, 3, 6, 9, and 12 from the skill categories of Rogue, Technical, W.P. and Wilderness.

**Standard Equipment:** Overcoat or poncho, cowboy hat, boots, 50 feet (15.2 m) of rope, a large sack, a small sack, knife, pair of revolvers, energy pistol, one energy rifle or BigBore shotgun, and one weapon for each of the other W.P.s; may include **TW** weapons.

Worm Wraiths will take weapons, ammunition, magic items and riding animals from those they murder, but never steal credits, gold, gems, jewelry or other items. They never ride vehicles.

**Allies:** Sometimes associate with necromancers, evil practitioners of magic, **Brodkil** and other lesser demons.

**Enemies:** All intelligent mortal beings, particularly humans and **Psi-Stalkers**, and anybody who gets in their way.

---

# Bandito Arms

---

Bandito Arms is a division of the **Black Market**, not that most of its clientele care. In fact, Bandito Arms represents 30% of all weapons, armor, vehicles and equipment sold in the *Western Wilderness* and 42% of all sales in the *State of Lone Star*; particularly in the *Pecos Empire*. **Northern Gun** represents a third of the market in both the New West and the State of Lone Star. The remaining sales in the arms market are divided between Wilk's, Manistique Imperium, Iron Heart, Golden Age Armaments and a dozen other manufacturers, smugglers and traders.

It is interesting to note that the Coalition Military actively interferes with the operations of *Bandito Arms* and other *Black Market* operations, smugglers and independent weapons dealers in the West, especially targeting those based in or near CS territories, but rarely even scolds Northern Gun and other arms dealers. The Coalition Army and occasionally, the **ISS**, often intercept shipments, breakup smuggling operations, attack suspected gun-runners and supply-lines/transport, and raid the outposts, camps and manufacturing plants of arms dealers, bandits, smugglers and agents of the Black Market. One reason for this attention is the Market's relentless efforts in the manufacture and sale of "knock-offs" (copies) based on CS weapons and equipment, and the fencing and resale of stolen goods from the Coalition Army. Such knock-offs and stolen weapons are routinely confiscated from adventurers and fighters travelling in CS States and Territories, especially in the Burbs. The possession of knock-offs and stolen CS equipment is a crime, even if the character "bought" the goods (didn't steal them himself). Those caught with contraband are fined, their weapons seized (sometimes including legitimate items not of CS

origin), and the owners interrogated to reveal the name and location of the seller(s). Those who cooperate are usually released — frightened, perhaps beaten or tortured, but alive and free. Those suspected of terrorism, crimes against the States, the sale and distribution of illegal arms, or who fail to cooperate, are executed!

**Bandito Arms'** primary base of operations in the New West is located at a town called El Diablo S-4, near the Devil's Lake, once known as Groome Lake or the infamous **Area 51** (the ultra-secret US Military Base where secret United States weapons and vehicles were tested). Bandito Arms also has branches and outposts in Lone Star, including *El Paso*, *Laredo*, *Los Alamos*, *Crossroads*, and the *Kingdom of Worth*. *San Antonio*, under the control of Black Market Kingpin, Warlord Don Marcos, is the main center of operations in that State. *Ciudad Juarez* in Northern Mexico, *New Mexico*, *Colorado*, *Oklahoma*, and *Kansas* (an unofficial CS Territory) also have Bandito Arms dealers.

In addition to the weapons and equipment described in this section, Bandito Arms also sells most standard items and services offered by the Black Market, including the fencing of goods, false I.D.'s and documents, illegal bionics and cybernetics, the purchase and sale of pre-Rifts artifacts, CS weapon knock-offs and a fairly good range of weapons, armor, power armor, equipment and vehicles manufactured by (and bought in bulk from) *Northern Gun*, *Manistique Imperium*, and *Golden Age Weaponsmiths*. The Black Market dealers also offer select items from *Wellington Industries*, *Triax* (the latter at premium prices; 200%-300% the normal price), and even the



occasional *Techno-Wizard* items, *Glitter Boys*, stolen *CS equipment* (weapons, body armor, power armor, or vehicles) and *Naruni Enterprises* items (300%-600% higher than the standard price, now that the CS has declared Naruni items highly illegal). Black Market "knock-offs" (cheap copies) of Coalition weapons include all old style weapons, a few of the new style ones, and variations of (or repainted, slightly modified and reconditioned, scavenged or stolen) Dead Boy armor. **Note:** Some of the Black Market's weapons and equipment are based on pre-Rifts designs uncovered through archeological digs, purchases of technology, and stolen technology. See the Rifts® RPG for a list of basic services, fees and purchasing rates.

## Bandito Arms Weapons

A few Weapon Notes by Siembieda:

I'd like to address (again) a few burning questions which I'm asked by **Rifts®** and **Mechanoids®** fans all the time.

**1. All laser weapons**, from pistols to cannons, have *no* "kick," unlike projectile weapons which *always* have some amount of recoil and sound. Likewise, heavy energy weapons (ion blasters, particle beams and plasma ejectors) also have some amount of recoil and/or reverberate with energy, and make some sound.

**2. Lasers are completely silent!** The beams don't make any noise except for the click of the trigger, the soft hum of the energy clip and the sizzling "sssswhack" sound it makes when it hits (and sears through or into) its target. This is one reason lasers are preferred by assassins and snipers. The sounds we, as players, imagine are the result of a lifetime of hearing *movie* and *cartoon* special effects. From **Star Wars** and **Star Trek** to **Lost in Space** and **Robotech**, energy and laser-type weapons have always made cool sounds. Of course, explosions in space also have sound, but in real life, there would be no sound in space. The reason sound is added to these fictional works is because the audience expects it! And let's admit it, we all love these special sound effects. That having been said, I must admit that when I play *Rifts*, *The Mechanoids*, *Robotech* or any game where energy weapons are used, I make sounds for them (I also do voices for characters, but that's me). Consequently, the manufacturers of laser weapons *may* take into consideration the expectations of humans (and similar D-bees) and actually build in cool sound generators for enhanced (psychological) effect and bigger sales. Marketing research by Wilk's and Northern Gun have shown that energy weapons that make sounds sell better by 15-33% (a substantial difference). In most cases, weapons with sound generators, particularly all sniper laser rifles, have an on and off switch for sound.

**3. Most laser weapons fire a short light beam** or blast, rather than one long, continuous beam; mainly to conserve on energy and to prevent the weapon from overheating.

**4. Rapid-fire "pulse" lasers** are the latest in laser technology and typically fire two or three super fast, high-powered laser beams in a matter of a half a second or less with each pull of the trigger. This quick, multi-blast often appears as one, and does greater damage than the more conventional single blast. Pulse lasers are limited to rifles and cannons.

**5. Lasers (amplified light)** have the longest range of all energy weapons, which is another reason warriors are attracted

to them. Particle beams and ion blasts generally do more damage, but have significantly shorter range and often burn up more energy than the efficient and silent laser.

**6. Rail guns kick** like a mule, sound like a machinegun (along with a high-pitched whine the moment they are turned on), and weigh 5-10 times more than the average rifle. Some, like the Glitter Boy's big, cannon-like gun, make a booming or exploding sound each time they are fired.

**7. Particle beam weapons**, ion blasters and other types of energy weapons have a slight recoil and make sounds when they are fired, typically a high-pitched whistle or whine of energy through the air, or a low thrum, or a short crack of energy as it erupts from the weapon.

### **8. Black Market Prices for E-Clips:**

Cost of standard E-Clip (20 shot): 5,000-7,000 credits for a new, fully charged clip; 1500 credits to recharge.

Cost of a Long E-Clip (30 shots): 9,000-12,000 credits for a new, fully charged clip; 2000 credits to recharge.

Cost of a CS Weapon Canister (or E-Canister): 10-30 shots depending on weapon type. Typically suitable only for old style CS weapons and **knock-offs:** 10,000 to 15,000 credits; 2000 credits to recharge.

Cost of a Mini-Power Pack: A CS hip or backpack canister (new CS weapons): Approximately 60 shots, but is likely to require modification of the weapon in order to use it, at a cost of 5,000 cr. The canister costs 20,000-30,000 credits and 4,000 to recharge.

## **Bandit IP-10 Ion Pistol** Also known as the "Eye-Pie Ten"

Bandito arms realized that there was a large market for high damage yielding weaponry and attempted to meet this demand with the introduction of a heavy damage ion pistol. The range on the IP-10 is relatively short, but the damage is impressive. As an added selling point, the IP-10 is designed to look like a revolver of the Old West, with an E-Clip designed to fit into the handle of the weapon.

Weight: 3 lbs (1.4kg)

Mega-Damage: 3D6 M.D.

Rate of Fire: Standard

Effective Range: 400 feet (122 m)

Payload: 10 shots from a standard short E-Clip, 20 shots with a long E-Clip.

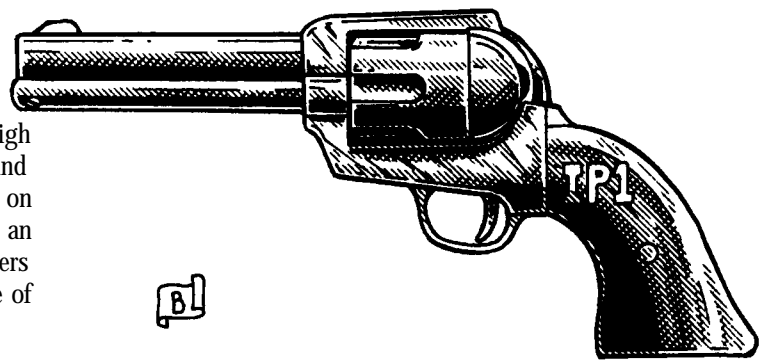

Bonuses: Well balanced and +1 to strike.  
Cost: 12,000 credits.

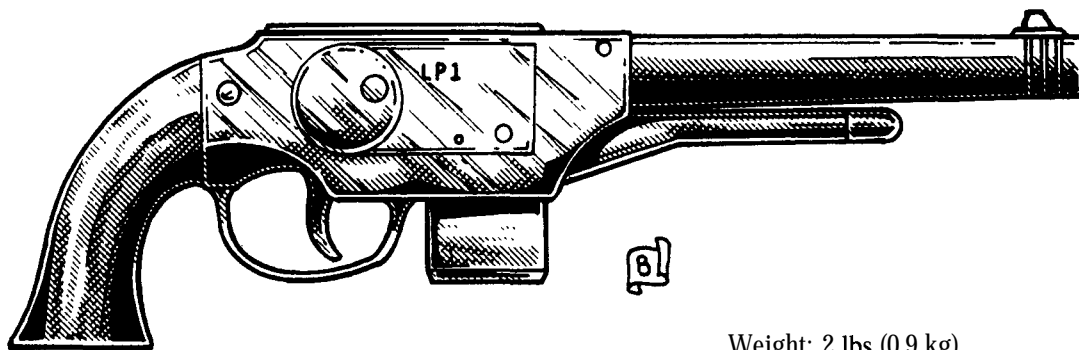

## **Bandit LP1 Laser Pistol** Also Known as the "No Lip" Pistol

The Bandit LP1 is a lightweight, highly accurate laser pistol with good range. Damage yield could be higher, but the accuracy of the weapon and its large payload more than offset this disadvantage.

Weight: 2 lbs (0.9 kg)

Mega-Damage: 2D4 (or 1D8 if one prefers) M.D.

Rate of Fire: Standard

Effective Range: 1000 feet (305 m)

Payload: 20 shots from a standard short E-Clip, 40 shots with a long E-Clip!

Bonuses: Due to this weapon's superior laser focusing optics, light weight and handling, it has a bonus of +1 to strike.

Cost: 20,000 credits for the gun. 2000 credits per magazine.

# The BigBore Series

The BigBore series is a new line of old style S.D.C. guns that fire heavy explosive rounds. They have been met with wild enthusiasm among gunfighters and bandits in the New West.

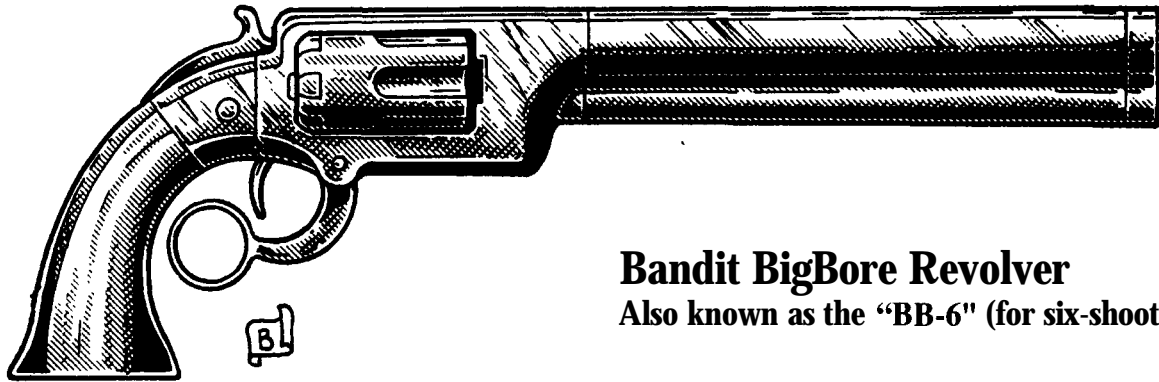

## Bandit BigBore Revolver

Also known as the "BB-6" (for six-shooter)

The BigBore is a large revolver that fires high explosive shells. The "bullets" could be considered small grenades. The advantages to the BigBore handgun is its *knock down* power, damage yield, and intimidation factor. It is just plain scary to look down the business end of the BigBore. The BB-6 is an intimidating weapon, and has a horror factor of 10 when pointed in someone's face. A strength of 14 or better is required to shoot the BB-6 (those with a weaker P.S. are -2 to strike even with an aimed shot, and -6 when shooting wild); a P.S. 17 is needed to fire it one handed.

Weight: 4 lbs (1.8kg)

Mega-Damage: 1D6 M.D. per round/bullet, plus human and human-sized D-bees who are shot must roll a 20 sided die to maintain their footing. This balance roll must equal or surpass the attacker's roll to strike. A successful roll means the character

feels like he's been kicked by a mule, but remains standing and suffers no penalties, except he loses initiative if he had it.

A failed roll means the victim is knocked off his feet, falls back onto the ground (fall back 1D4 feet), loses initiative (if he had it) and loses one melee attack/action! Even characters in M.D.C. body armor will be knocked down, however, those in power armor, full conversion cyborgs, robots, giants, supernatural beings and creatures of magic (demons, metamorphed dragons, etc.) are not.

Rate of Fire: Single shot, each shot counts as a melee action, unless shooting wild.

Effective Range: 200 feet (91 m)

Payload: Six; revolver style cylinder weapon.

Cost: 6,500 credits for the gun, 80 credits per round/bullet or 10,000 credits for a gross (box of 144 rounds).

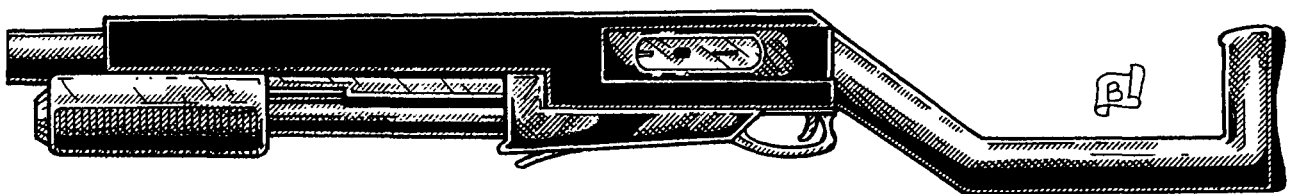

## Bandit BigBore Sawed-Off

Also known as the

"BB Sawed-Off" and the "Mule"

The BigBore Sawed-Off looks like a sawed-off shotgun and fires a large, high explosive shell and has even greater knock down power. This is another *intimidating* weapon that has a horror factor of 12 when pointed at most mortal opponents. A strength of 18 or better is required to shoot the BB Sawed-Off (those with less P.S. will be knocked on their butt, and lose one melee attack/action); P.S. 22 is required to fire it one handed. It is also known as "the Mule" because it has a kick like one. A single barrel and double-barrelled variety are available — the double-barrel is most popular.

Weight: 6 lbs (2.7 kg)

Mega-Damage: 2D4 M.D. per single round/bullet or 4D4 per double-barrel blast. Human and human-sized D-bees must roll a 20 sided die, -6 to stay standing. The roll must equal or surpass the attacker's roll to strike. A successful roll means the character is staggered, knocked to his knees and loses initiative (if he had it).

A failed roll means the victim is knocked off his feet and flung 8-10 feet (2.4 to 3 m) before hitting the ground! The victim loses initiative (if he had it), is momentarily dazed (reduce all combat bonuses by half for one melee round per each blast he endures), and loses one melee attack/action! Even characters in M.D.C. body armor will be knocked down and suffer the penalties above. Those in power armor, and full conversion cyborgs, robots, giants, supernatural beings and creatures of

magic (demons, metamorphed dragons, etc.) are not likely to be knocked down (+6 to save vs knock down), but will lose initiative and are staggered with each shot.

Rate of Fire: Each shot, single or double barrel, counts as one melee action/attack.

Effective Range: 150 feet (46 m)

Payload: Two or 12 with an ammo drum.

Cost: 15,000 credits for the gun, 120 credits per round/bullet or 16,000 credits for a gross (box of 144 rounds).

## Bandit BigBore Shotgun

Also known as the "BB Long-Barrel"

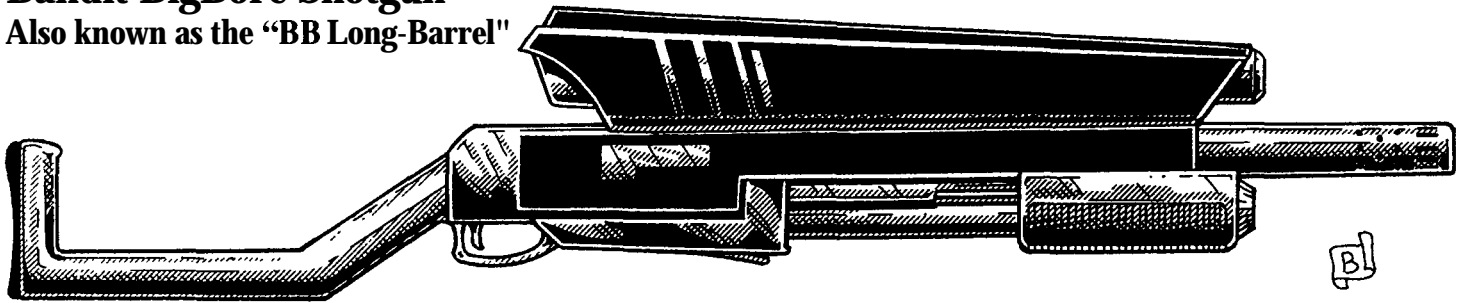

The BB Long-Barrel looks like a heavy shotgun and fires the same high explosive shell as the BB Sawed-Off; H.F. 12. A strength of 18 or better is required to shoot it (those with less P.S. will be knocked off their feet, and lose one melee attack/action); P.S. 22 to fire it one handed. The advantage of this rifle is its greater range. A single barrel and double-barrelled variety are available.

Weight: 8 lbs (3.6 kg)

Mega-Damage: 2D4 M.D. per single round/bullet or 4D4 per double-barrel blast. Same knock down as the sawed-off.

Rate of Fire: Each shot, single or double barrel, counts as one melee action/attack.

Effective Range: 300 feet (122 m)

Payload: Four or 12 with an ammo clip.

Cost: 18,000 credits for the gun, 120 credits per round/bullet or 16,000 credits for a gross (box of 144 rounds).

## Light Rail Guns

The Black Market has produced a popular, man-portable rail gun infantry weapon. This weapon is light enough for a single soldier (with a P.S. of 20 or more) to use comfortably but still delivers the firepower of a rail gun. The 5000 series rail guns are effectively high-tech, lightweight machineguns (some argue that they are heavy assault rifles) that fire either explosive rounds (same as the BigBore) or flechette rounds (much like a mini-version of the Glitter Boy's boom gun). The basic design and technology to make these weapons was uncovered by Bandito arms at Area 51! They also produce the Bandit 5000 series as well as knock-offs of CS, Northern Gun and other types of rail guns.

The main advantage of the Bandit 5000 series is that the comparatively light, manageable weapons deliver the same punch as the average rail gun, but are easily used by a two-man team of normal humans, or by a single individual with a P.S. of 20 or greater, making them ideal for Juicers, Crazies, and cyborgs, as well as many mutants and D-bees. This also works to the weapons' disadvantage, because they have a tiny payload compared to conventional rail guns, and a reduced range.

## Bandit 5000 BigBore Rail Gun

Also known as the "Big Bear"

Can fire single, aimed shots (each pull of the trigger is one melee attack/action) or in short bursts. A P.S. of 20 or higher is necessary to use the weapon without penalty, otherwise -3 to strike.

Weight: Gun: 25 lbs (11.3 kg), including the weight of an E-Clip and standard ammunition drum (60 rounds).

Mega-Damage: 1D6 M.D. per single round/bullet or 2D6 M.D. per short burst of six rounds. Same knock down as the sawed-off BB-Mule.

Rate of Fire: One at a time or in bursts; each counts as one melee action/attack, but the burst is less controlled and less accurate (all rounds fired do not hit the intended target).

Effective Range: 2000 feet (610 m); the E-Clip provides the extra "zip."

Payload: Standard Drum: 60 rounds or 10 bursts. It takes one melee round (15 seconds) to reload (30 if the user doesn't have the W.P. heavy weapons skill). A large, backpack ammo drum can be substituted. It holds 240 rounds (40 bursts), but weighs an additional 22 pounds (10 kg). The E-Clip can fire 960 rounds (160 bursts) before needing to be replaced.

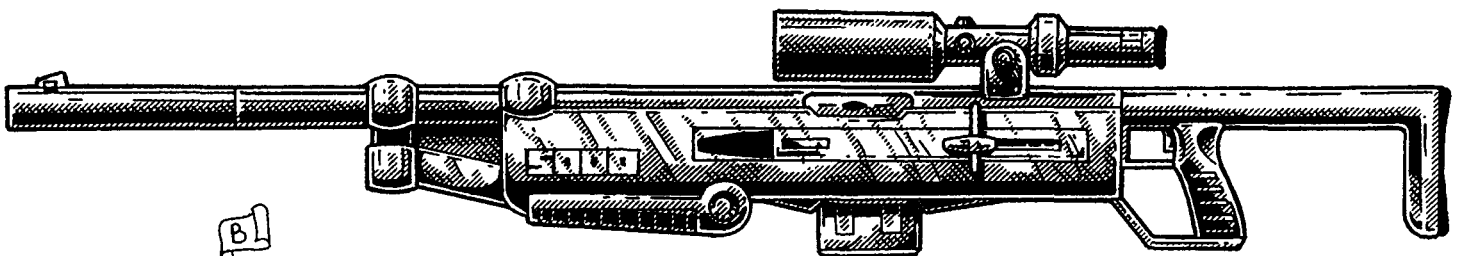



Bonus: Laser targeting standard; +1 to strike on aimed shots.

Cost: 50,000-55,000 credits for the gun, 80 credits per round/bullet or 10,000 credits for a gross (box of 144 rounds).

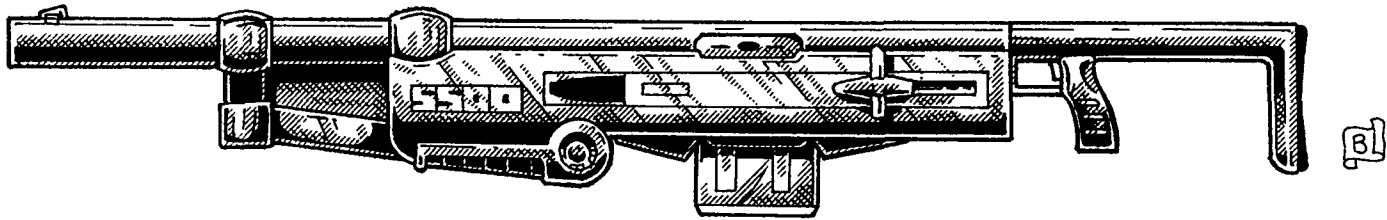

## Bandit 5500 Flechette Rail Gun

Also known as the "Cactus Juicer."

A slightly heavier version of the Big Bear 5000, but instead of explosive rounds it fires flechette rounds. This weapon is extremely popular among cyborgs and power armor pilots, who typically use it with the backpack ammo-drum capable of 30 bursts.

It got its nickname, Cactus Juicer, because when used to shoot cactus for target practice, all it leaves behind is juice where the cactus once stood. A P.S. of 20 or higher is necessary to use the weapon without penalty, otherwise -3 to strike.

Weight: Gun: 30 lbs (13.6 kg), including the weight of the E-Clip power supply and standard ammunition drum (42 rounds).

Mega-Damage: 1D4 M.D. per single round/bullet or 3D6 M.D. per short burst of six rounds. No knock down feature.

Rate of Fire: One at a time or in bursts; either one counts as one melee action/attack, but the burst is less controlled and less accurate (all rounds fired do not hit the intended target).

Effective Range: 2000 feet (610 m); the energy clip provides the extra "zip."

Payload: Standard Drum: 42 rounds or 7 bursts. It takes one melee round (15 seconds) to reload (30 if the user doesn't have the W.P. heavy weapons skill). A large, backpack ammo drum can be substituted. It holds 180 rounds (30 bursts), but weighs an additional 30 pounds (13.6 kg). The E-Clip can fire 960 rounds (160 bursts) before needing to be replaced.

Bonus: Laser targeting standard; +1 to strike on aimed shots.

Cost: 52,000-58,000 credits for the gun, 80 credits per flechette round or 10,000 credits for a gross (box of 144 rounds).

## Bandit 6000 Grenade Launcher

Also known as the "Big Bang" Assault Rifle

The Bandit 6000 is a rapid-fire grenade launcher! Its size and shape is somewhat reminiscent of Bandito Arms' rail guns, but the payload unleashed by this heavy weapon is literally explosive. The drum canister holds the main payload of grenades (50), but an additional 12 grenades can be held in the gun itself. A folding bi-pod stand is located in the front of the weapon for use in a prone position and for extra support. It is designed for use by power armor pilots, Juicers, Crazies and cyborgs; a P.S. of 24 or higher is necessary to use the weapon without penalty (otherwise -4 to strike). Like the rail guns, the Big Bang is based on technology uncovered at Area 51, so it is nothing more than a knock-off of a forgotten (experimental?) weapon designed for the US Army or Air Force. Probably a weapon originally intended for the SAMAS.

Weight: Gun: 40 lbs (18 kg), plus the grenade drum, 20 (9 kg) —can be used with or without the drum (grenades must be hand loaded).

Mega-Damage: 2D6 M.D. per single round/grenade or 4D6 M.D. per rapid-fire burst of two grenades fired one microsecond after the other. The damage is inflicted to everything in a 12 foot (3.6 m) radius.

Rate of Fire: One at a time or two simultaneous at the same target (counts as one melee action/attack).

Effective Range: 2000 feet (610 m)!

Payload: 12; an additional 50 grenades are packed into the ammo-drum. It takes one melee round (15 seconds) to reload the weapon by hand with 12 grenades (or one melee action to load two).

Bonus: Laser targeting and telescopic scope optional (6000 cr.).

Cost: 80,000-100,000 credits for the gun, 500 credits per grenade. Fair to poor availability. This weapon is outlawed in the Coalition States (who by the way, are considering knocking it off and adding it to their arsenal).

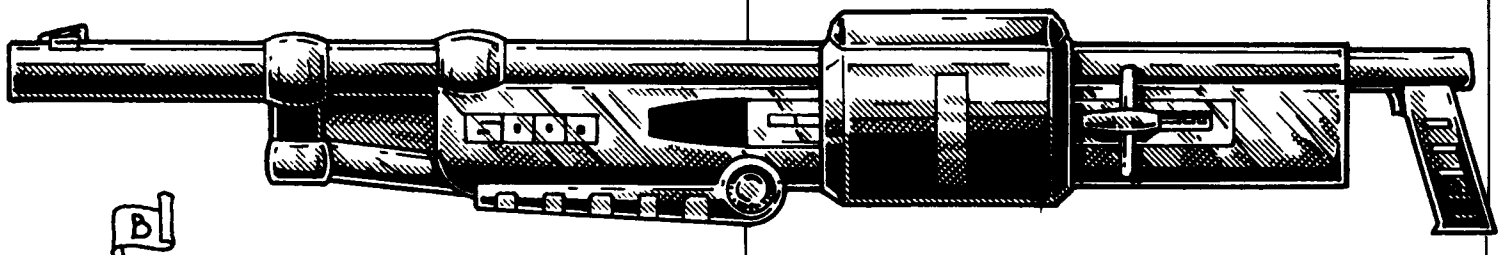

# Bandito Body Armor

Bandito Arms sells *five* suits of armor that the Black Market actually manufactures and distributes, the *Bandito*, *Branaghan*, and knock-offs of the old style light and heavy *Coalition "Dead Boy"* body armor and *DPM Dog Boy riot armor*. The latter three are rarely touched by other arms dealers for fear of reprisal from the Coalition Military (and is one of the reasons the CS is so focused on destroying Black Market operations, especially arms dealers). The Black Market and Bandito Arms also sell a variety of Northern Gun armor, including the *Bushman*, *Huntsman*, *Urban Warrior*, *Gladiator*, and *Juicer armor*, as well as *used armor* (don't forget about the hundreds of pawnshops the Black Market owns or controls), and *patchwork armor*.

## Standard features of fully sealed, *environmental/body armor*:

Complete environmental battle armor suitable for use in all hostile environments, including space.

Computer controlled life support system that monitors and displays bio-data of the wearer as well as the capacity and failure of life support systems and damage to the armor. The wearer will know *approximately* how much M.D.C. is remaining and whether or not the armor has been breached.

Computer controlled, independent oxygen supply and purge system that automatically engages in low oxygen or contaminated air environments. Five hour oxygen supply.

Internal cooling and temperature control.

Artificial air circulation systems, gas filtration, humidifier.

Insulated, high-temperature resistant shielding for up to 300 degrees centigrade. Normal fires do no damage. Nuclear, plasma, magic fires and mega-damage fire and heat do full damage.

Radiation shielded.

Polarized and light-sensitive visor with a tint that automatically adjusts to the level of available light.

Built-in loudspeaker; 80 decibels.

The helmet can be completely removed, and some allow for the removal of the protective face plate without having to take off the entire helmet.

## Typical Options:

Directional, short-range radio built into the helmet. Range is five miles (8 km). Cost: 1000 credits.

Loudspeaker: 300 credits.

Built-in Language Translator: 12,000 credits.

Passive night sight goggles/visor: 1500 credits.

Multi-Optic Helmet in place of conventional one: 5000 credits. Additional M.D.C. armor padding or plating can be added to most medium to heavy suits for the cost of 1000 credits per two points of M.D.C. (up to 20 points **maximum**)! Add -5% penalty to movement.

## The Bandito

The Bandito is a very light suit designed to be worn with power armor or used by vehicle crews. It combines lightweight plates with M.D.C. padded armor to provide maximum protection with no movement penalties. It is similar in style to the Huntsman padded armor, only a little more form fitting and flexible. As the name suggests, it is very popular among bandits, but also with cowboys and anybody who rides a horse or pilots a

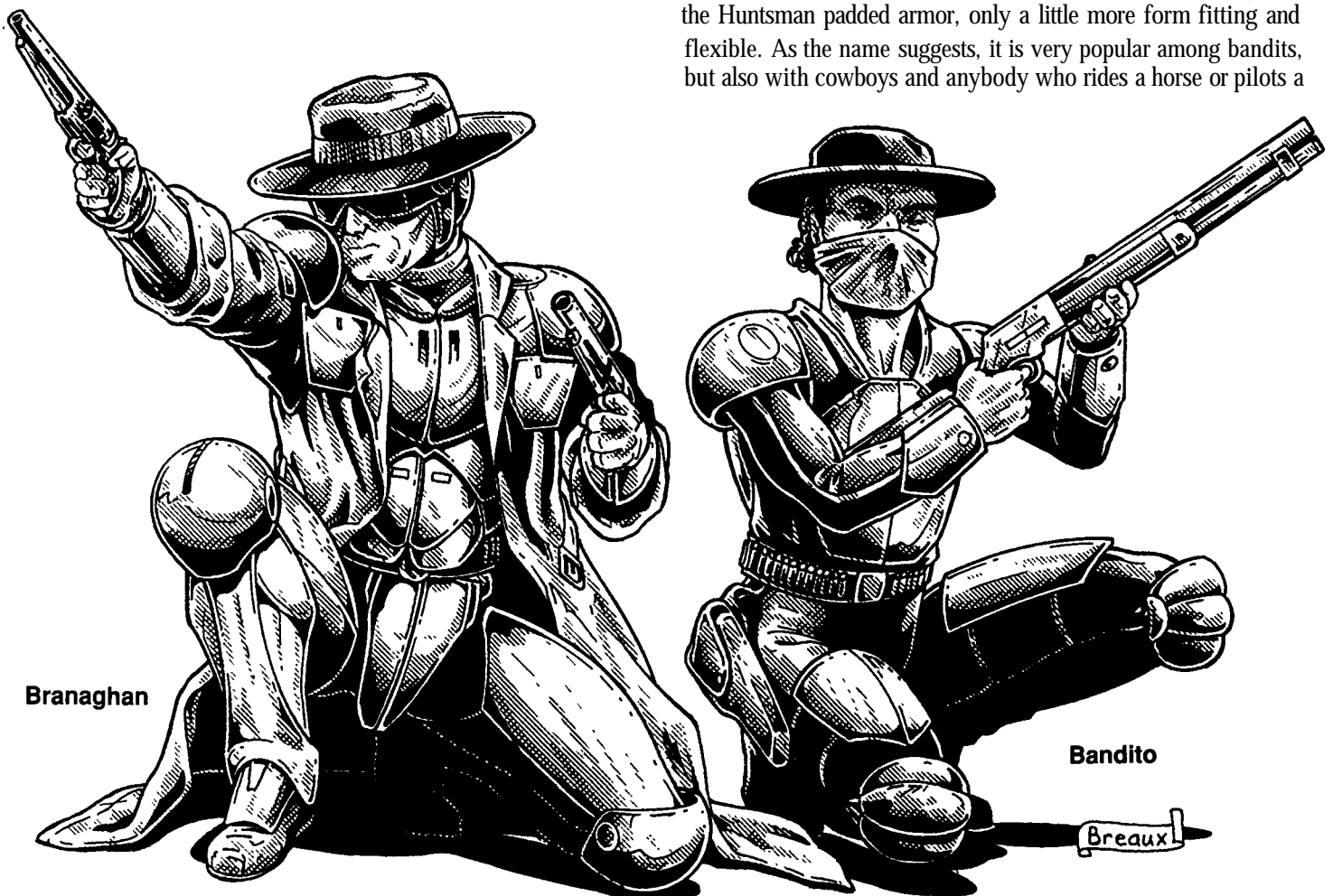

Branaghan

Bandito

light vehicle and is looking for maximum movement and comfort. The price also has a lot to do with the popularity of this armor.

**Type:** Light personal body armor.

**Size:** Human equivalents are most common, but comes in a variety of sizes and slightly different shapes.

**Weight:** 12 lbs (5.4 kg)

**Mobility:** Excellent mobility, no movement penalties.

**M.D.C. By Location:**

Head/Helmet — 30

Arms — 18 each

Legs — 24 each

Main Body — 38

**Market Price:** 10,000 credits; good to excellent availability.

**Note:** This is *not* full environmental armor and does not have a cooling system.

## Branaghan Armor

**Branaghan** armor is named after "Jessie Branaghan," an infamous outlaw for whom the suit was custom designed. It is a heavy suit of environmental combat armor designed to be worn under a padded and armored M.D.C. overcoat. Even though Jessie Branaghan was shot to death wearing his, both the main environmental armor and the M.D.C. overcoat are considered stylish and extremely popular in the west.

The main armor is more a Bushman style suit of environmental plate body armor. The helmet is light and snug with a removable face plate. Many wear the armor without the helmet unless they know they are headed for a major battle or dangerous environment.

The overcoat or long-coat — also known as a duster — is a favorite among cowboys, gunfighters and sheriffs because it is both stylish and offers a surprising amount of protection, as well as making an excellent raincoat (waterproof and a good article of clothing in which to hide a shotgun or rifle under). The entire coat is lined with (relatively) lightweight mega-damage padding with plates over the shoulders and chest (sometimes concealed under the fabric).

**Type:** Two piece unit with medium-heavy, environmental body armor and a light augmenting overcoat that serves as light personal armor.

**Size:** Human equivalents are most common, but comes in a variety of sizes and slightly different shapes.

**Weight:** Main armor: 15 lbs (6.8 kg); Overcoat: 6 lbs (2.7 kg).

**Mobility:** Heavy plate armor: Fair mobility; -10% to climb, -20% to prowl, swim, perform acrobatics and similar physical skills. Add another -5% to each when the overcoat is worn with the armor.

If only the overcoat is worn (as is popular among Outlaws, Cowboys, Gunslingers and Saddle Tramps) the movement penalty is only -5%, but -10% to swim.

**M.D.C. By Location:**

Head/Helmet — 40

Arms — 28 each +8 with overcoat.

Legs — 38 each +12 with overcoat.

Main Body — 75 +28 with overcoat.

**Market Price:** 38,000 credits for the main armor, +12,000 for the overcoat or for the coat alone. Excellent availability. The cost of the Branaghan, armored overcoat is a bit pricey because it is in such high demand and people are willing to pay it.

## Old Style CS "Dead Boy" Armor

The Black Market is famous for having the nerve to produce knock-offs of the old style, light and heavy Coalition "Dead Boy" armor, which are much more popular among bandits and adventurers than the new CS Skeletal armor (the Black Market only sells stolen and used new style CS armor). The Black Market "editions" of the Dead Boy armor are identical to the old CS body armor in every way, except the standard colors are matte silver/grey and matte black (as opposed to the traditional blue-black of the CS). **Note:** Most Black Market outlets provide low cost customizing of the "standard" Dead Boy armor and most other types of armor.

### Dead Boy Body Armor

**Class:** CA-1 heavy and CA-2 light environmental body armor.

**Size:** Human equivalent.

**Weight:** Heavy: 18 pounds (8.1 kg) or light: 9 pounds (4 kg).

**Mobility:** Heavy: fair; -10% to climb and -25% to prowl, swim, acrobatics and similar physical skills/performance; -10% to speed. Light: Very good; -5% to climb and -10% to prowl, swim, acrobatics and similar physical skills/performance.

**M.D.C. by Location:**

Head/Helmet — 50

Arms — 35 each

Legs — 50 each

Main Body — 80 heavy or 50 for light

**Special Weapon Systems or Features:** None

**Black Market Price:** Light: 40,000; Heavy: 50,000 credits. Fair to poor availability, especially in the West (popular in the Pecos Empire).

### Dog Pack DPM Light Riot Armor

The DPM armor offers none of the environmental systems of the full Dead Boy suits and serves mostly as protection against gunfire.

**Weight:** 10 pounds (4.5 kg)

**Mobility:** Full; no prowl or movement penalties.

**M.D.C. by Location:**

Head — None unless a helmet is also purchased (15-35 M.D.C.)

Arms — 10 +3 for heavy

Legs — 15 +5 for heavy

Main Body — 50 heavy or 35 for light.

**Black Market Price:** Light: 12,000; Heavy: 18,000 credits. Fair to poor availability, especially in the West.

## Customized & Modified Armor

Most Black Market outlets and many arms dealers provide low cost customizing of body armor. This means the helmet can be changed or modified (200 credits), the armor can be custom painted (600 cr.; one or two colors), insignias or special designs can be painted or etched into the armor (1000-2000 cr.), and body styling can be done (change the vambraces/forearms, shoulder plates, knee and leg plates, chest plates, face plate, add spikes, horns or blades, etc.; prices vary — small changes can cost 200-600 cr. while a complete overhaul could cost 3000 to 6000 plus the paint job).

Additional M.D.C. armor padding or plating can be added to most medium to heavy suits for the cost of 1000 credits per two

points of M.D.C. (up to 20 points maximum)! Add -5% penalty to movement.

**Note:** Northern Gun, Manistique Imperium, Golden Age Weaponsmiths and other arms dealers offer similar customizing services for body armor, power armor, vehicles and even cyborg armor and external cyborg components. Adventurers who don't have the money, but who have some artistic ability (or a friend with some), also engage in cosmetic alterations and personalization of armor; mostly painted insignias, designs and slogans to bolting on extra belts, spikes and such, or combining pieces of one or more types of armor to make *patchwork* suits of armor.

## Patchwork & Used Armor

**Patchwork creations** provide effective mega-damage protection, and can appear very striking, but are not usually full environmental suits, so gases, fumes, radiation and disease will seep in and affect the wearer. Furthermore, most patchwork suits have 15-20% less M.D.C. than a professional quality, full environmental suit. On the other hand, patchwork armor typically costs 40% less than a comparable full environmental suit, so many will take their chances with the armor and a gas mask or air filter. Those with environmental protection only sell for 20% more than normal, while creations that are artistic, frightening or striking in some way (may have 10-20 additional M.D.C. too) will sell for 20-50% more!

**Used Armor:** The cost of used armor can vary dramatically. Armor that's "like new" will have all standard features, have full environmental protection, full M.D.C., and sells for full price (sometimes sold as new). Typically, used armor will have 40% less M.D.C. than new, with a proportional discount off the usual price; sometimes an additional 5% discount if paid for in universal credits.

Used armor that has been patched and repaired will have 20-30% less M.D.C. than new, but full environmental protection and sells for 30% less than the price of new.

Used armor that is battered or has been patched, has 30% less M.D.C. and *no* environmental system, but will sell for 50% less than the price for new, perfect armor.

**Note:** Customization and patchwork armor are two reasons there are so many variations of armor seen throughout the country.

---

## Northern Gun Armor

The Black Market and Bandito Arms dealers purchase body armor, wholesale, from Northern Gun and the Manistique Imperium for resale. These purchases include *Bushman*, *Huntsman*, *Urban Warrior*, *Gladiator*, and *Juicer armor*; as well as the four types of armor depicted and described as follows. Each of these suits have been designed specifically for Cowboys, adventurers, mercenaries, and freebooters (a polite term for bandits and outlaws) of the Western Wilderness. Consequently, they have a western or Spanish look to them.

---

## NG "Maverick" Riding Armor

A light body armor designed specifically for cowboys and other horsemen in mind. The entire body, arms and legs are covered in a light padded armor, with light polycarbonate and ceramic plates protecting the shoulders, chest, forearms, thighs and lower legs (the latter usually concealed by leather leggings or "chaps" that come standard with the armor). Comes standard with an M.D.C. Cowboy hat, felt or leather, with a mega-damage polycarbonate cap/top section. A full helmet (typically Bushman or Vaqueros helmet) is optional for an extra 6000 credits (35 or 45 M.D.C. respectively).

**Type:** Light personal body armor.

**Size:** Human equivalents are most common, but comes in a variety of sizes and slightly different shapes.

**Weight:** 10 lbs (4.5 kg)

**Mobility:** Excellent mobility, no movement penalties.

**M.D.C. By Location:**

Head/Hat — 10 (optional helmet 35)

Arms — 12 each

Legs — 16 each

Main Body — 36

**Market Price:** 14,000 credits; good to excellent availability. Extremely popular among Cowboys, Highwaymen, Saddle Tramps and Gunmen.

**Note:** This is *not* full environmental armor and does not have a cooling system.

## MI "Vaqueros" Armor

The Vaqueros (pronounced van qwer ohs) is a heavy, environmental combat armor with a Mexican/Spanish styling, produced by the *Manistique Imperium*. The helmet comes with a light mesh covering for the lower face to give it an exotic cowboy or bandit look. The boots are designed with pockets that can hold a survival knife, blackjack, small to medium sized revolver or pistol or personal item (chewing tobacco, cigarette lighter, playing cards, etc.); one per boot. It also comes standard with a pair of holsters and gun belt.

**Type:** Heavy, environmental body armor.

**Size:** Human equivalents are most common, but comes in a variety of sizes and slightly different shapes.

**Weight:** 20 lbs (9 kg)

**Mobility:** Poor mobility; -20% to climb, prowl, swim, or perform acrobatics and similar physical skills.

**M.D.C. By Location:**

Head/Helmet — 45

Arms — 32 each

Legs — 45 each

Main Body — 90

**Market Price:** 40,000 credits. Good to excellent availability.

## NG "Range Rider" Riding Armor

Another light body armor designed specifically with western females and riders in mind. Like the Maverick armor, the entire body, arms and legs are covered in a light padded armor, with the lower body designed as "pants" for greater maneuverability on horseback. For a touch of the feminine, a leather skirt, opened in the front, hangs from the waist, and the upper body is tapered and fitted to show the waist and bosom. The upper chest and shoulders are covered by light polycarbonate and ceramic plates,

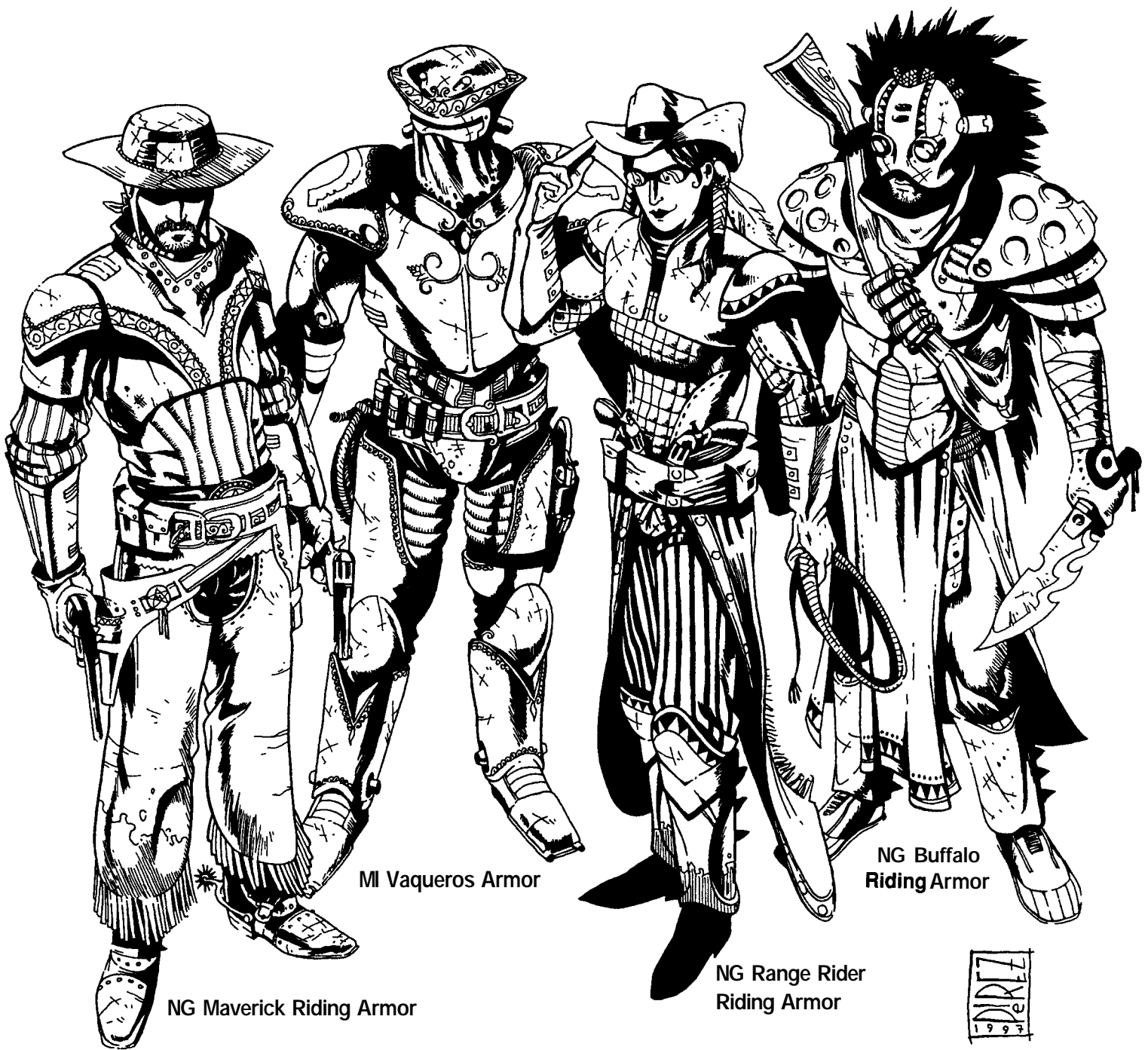

NG Maverick Riding Armor

MI Vaqueros Armor

NG Range Rider Riding Armor

NG Buffalo Riding Armor

with reinforced ceramic scale plates to protect the abdomen. The boots are reinforced with mega-damage plating that protects both the lower legs and knees, and concealed plates also protect the thighs. Comes standard with an M.D.C. Cowboy hat, felt or leather, with a mega-damage polycarbonate cap/top section. A full helmet (typically Bushman or Vaqueros helmet) is optional for an extra 6000 credits (35 or 45 M.D.C. respectively).

**Type:** Light personal body armor.

**Size:** Human equivalents are most common, but comes in a variety of sizes and slightly different shapes.

**Weight:** 10 lbs (4.5 kg)

**Mobility:** Excellent mobility, no movement penalties.

**M.D.C. By Location:**

Head/Hat — 10 (optional helmet 35)

Arms — 12 each

Legs — 15 each

Main Body — 30

**Market Price:** 15,000 credits (a bit higher priced than the Maverick, because one is paying for style); good to excellent availability. Extremely popular.

**Note:** This is *not* full environmental armor and does not have a cooling system.

## NG "Buffalo" Riding Armor

A heavy environmental body armor designed specifically with gunmen and adventurers (and bandits) in mind. It has a padded groin area, with a front plate to protect the privates, which makes for easy and comfortable horseback riding. The entire upper body, abdomen, chest, and shoulders are covered in heavy plates, while the forearms are protected by light polycarbonate vambraces that imitate a "wrapped" rawhide look. The lower legs are covered with heavy padded armor, and small, concealed thigh plates, underneath Indian style rawhide pants.

The armor gets its name from the helmet, which has large, round tinted lenses for seeing (rather than a visor) and a big, shaggy black mane like a buffalo. The lower mouth and chin portion of the suit can be removed and replaced as desired.

**Type:** Heavy, environmental body armor.

**Size:** Human equivalents are most common, but it comes in a variety of sizes and slightly different shapes.

**Weight:** 18 lbs (8 kg)

**Mobility:** Fair to good mobility, -5% to climb and -10% to prowl, swim, acrobatics and similar physical skills/performance.

**M.D.C. By Location:**

Head/Helmet — 40

Arms — 30 each

Legs — 28 each

Main Body — 65

**Market Price:** 32,000 credits; good to excellent availability. Extremely popular among Bandits, Highwaymen, Saddle Tramps and adventurers.

## Cavalry Armor (Barding)

Cavalry armor is effectively high-tech “barding” for horses. Like many of the human suits, this barding is made from lightweight polycarbonates and ceramics that are tougher than

steel. Cavalry Armor is not an environmental suit, so the animal is not protected from toxic fumes, gases, or radiation. Although it comes with padded leggings with plating for the upper leg, these components can be removed to leave the legs uncovered (the legs of a horse are difficult targets to shoot, requiring a “called shot” with a penalty of -4 to strike). The armor that covers most of the leg are separate pieces that fold around the leg and attach at the back and at the top with Velcro and/or laces. The **thigh/upper** leg is covered in light M.D.C. plates (so is the chest).

**Type:** Light body armor for horses.

**Size:** Fits most horses from 14 to 16 hands tall.

**Weight:** 30lbs (13.6 kg)

**Mobility:** Very good mobility, no movement penalties without the armored leggings; reduce speed by 5% with the leggings.

**M.D.C. By Location:**

Head — 50

Front Legs — 18 each

Hind Legs — 25 each

Main Body — 90

**Market Price:** 20,000 credits; good availability from Bandito Arms.

**Note:** This is *not* full environmental armor and does not have a cooling system.

---

# Bandito Arms Power Armor

---

## Sidewinder Power Armor

*The morning winds blew hot with the coming of the morning sun. The desert was quiet, as it was every morning. A pair of desert sidewinders slithered away as the sun began to beat down hard. The rattlesnakes were the first to feel the approach, heralding the arrival with a warning rattle.*

*A cloud of dust was the first telltale sign of its presence; vortexes of sand and dust being drawn into the air from above. The high pitched, mechanical scream of engines were to be heard next. Within seconds it had passed overhead. It flew only a few feet above the ground and moved side to side as it roared passed. The body of the power armor was painted desert brown and yellow with wisps of black. It stood only slightly taller than a man but was much bulkier. Two large engine jets protruded from its back and two tiny thruster jets, on the lower legs, rotated and hissed to maintain equilibrium. On the shoulders were mounted two rectangular boxes which could only have held rockets and in the hand was a light rail gun.*

*As quickly as it had appeared, it was gone, leaving only the billowing clouds of dust as the only evidence of its passage through the silent desert.*

When Bandito Arms raided the ancient American Military base known as Area 51, they were shocked to find eight prototype power armor suits that were effectively *Coalition SAMAS!!!* Like most people in the world, the Black Market

assumed that the CS had invented the famous flying power armor known as SAMs or SAMAS. They were stunned to discover that it was really ancient pre-Rifts technology. The facility had been hardened against nuclear attack and therefore survived the majority of the cataclysmic effects of the Coming of the Rifts. The Black Market has sat on this secret for decades. First, because it took them years to study the technology and then to copy it in order to make the power armor. However, even then, the Black Market sat on the knowledge, afraid to mass produce the SAMs for fear it would set the CS upon them with a terrible vengeance. Thus, for another 15 years, the Black Market kept the secret of their SAMs to themselves, using them as a secret force to protect and defend the Bandito Arms center at Area 51 (Nevada) and other wilderness outposts.

It has only been in the last year that Bandito Arms has publically unveiled their two versions of the famous Coalition SAMAS power armor. Since they are notorious for stealing technology and “knocking it off (copying it) — particularly CS weapons and armor — the recent release of SAMAS-like power armor is presumed to be a knock-off of Coalition technology. This is a reasonable presumption, and one that Bandito Arms does *not* try to dispute. Emperor Prosek and other CS leaders love their secrets, so revealing that the CS is utilizing pre-Rifts technology would only serve to create a firestorm of denial and retribution. Thus, Bandito Arms and its Black Market masters are content to let people believe what they will. A wise decision, since the simple release of the SAMAS power armor (a secret technology that the CS considers their exclusive property) has incensed the Coalition who has responded with both political and military attacks against the Black Market, ten fold greater



Breaux

than any past actions against them. The CS has declared the possession, let alone use, of a **Bandito Sidewinder** or **Wild Weasel SAM**, a crime against the States punishable by immediate execution, without trial! Furthermore, the CS Police and Military are actively engaged in campaigns to rout all Black Market activity from their States, including the Burbs. This is a virtually impossible goal, and will never happen, but it has made life and business in the Burbs difficult and increasingly deadly — forcing most Black Market agents and operations to go further underground.

The Coalition's public condemnation of the SAMAS "knock-offs" and campaign of vengeance to shut the Black Market down (with nearly 100 executions in three months in and around Chi-Town alone!), has made the two SAMAS *undesirable* commodities, regardless of price. "Nobody with half a brain will touch 'em," bemoaned one mid-west arms dealer, "and I don't blame 'em one bit." However, this is a bit different story out west. Many people in the New West don't know anything about the SAMAS controversy, or much about the CS, or don't care. Consequently, modest sales of the Sidewinder and Wild Weasel are ongoing in the West, Mexico and the Pecos Empire, although fewer than 600 total have been sold — 96 of which were on route to Tolkeen when they were intercepted, seized and destroyed by Coalition forces. In Kansas (not an official CS territory), a mercenary company sometimes hired by the CS were cut down by Coalition troops, killing every last man (72), because they had acquired eight Wild Weasel SAMs.

The main reasons sales are so low in the Western Wilderness is because most people don't know how to pilot power armor, can't afford the armor even if they could pilot them, and because the majority of people are into the retro-look and technology of the Old American West — the SAMAS are too "new fangled" or "Eastern flyin' junkpiles, you should try sellin' em to the Coalition States. I betcha they'd love em." This means the two Bandito SAMAS are most appealing to mercenary companies or wealthy adventurers, towns and ranchers (except they scare the cattle). It is the rare New West bandit who can afford a SAMAS.

### **Bandito "Sidewinder" SAMAS**

Inside the Area 51 facility were volumes of information on an experimental US Air Force armored unit called the Strategic Armored Military Assault Suit or SAMAS for short. The data that was collected spoke of an advanced series II version called the VT-SAMAS or Vectored Thrust SAMAS. The official Air Force code name for this experimental, secret weapon was *Project Sidewinder*.

Project Sidewinder was an attempt to upgrade the original SAMAS into an even more versatile combat unit by using a vectored thrust propulsion system. The Sidewinder would also be the test vehicle for a series of upgraded combat systems like the "Big Bang" grenade launcher. In the end, the armored suit was to be the ultimate infantry assault vehicle, something the Coalition States, some 300 years later, would tweak, develop and unleash with perfection. At the time the ley lines erupted, only eight units had been created. Four were assault units and four were designed for "Wild Weasel" roles as anti-electronics and SAM target designation.

**Model Type:** PA-09-AVT — The Sidewinder

**Class:** Vectored Thrust Strategic Armor Military Assault Suit

**Crew:** One pilot

### **M.D.C. by Location:**

Shoulder Wings (2) — 50 each

Shoulder/Wing Mini-Missile Launchers (2) — 60 each

\* Main Turbines (2; rear) — 100 each

\* Lower Maneuvering Jets (4; rear) — 25 each

\* Leg Maneuvering Jets (1 per leg; lower) — 12 each

\* Waist Maneuvering Jets (4) — 10each

\* **Head** — 100

\* Hands (2) — 25 each

Arms (2) — 60 each

Legs (2) — 100 each

\* Forearm Guns (2) — 12 each

\* Bandit 6000 Grenade Launcher (1) — 80

\*\* Main Body — 230

\* A single asterisk indicates extremely small targets to hit and require a called shot at -4 to strike. Hits by missiles will generally damage the main body.

Destruction of the head will most likely kill or blind the pilot and will knock out all forms of communications, sensors, targeting, etc. The pilot must rely on his own human vision and senses; no power armor combat bonuses apply.

Destruction of even one of the main wings will force the unit to crash-land.

Destruction of the maneuvering wings will impart a -1 to dodge penalty for each wing destroyed and reduce speed by 10%.

\*\* Destruction of the main body will destroy the power armor and leave the pilot inside vulnerable — assuming he survived the destruction of the suit.

### **Speed:**

Running: 100 mph (160 km) maximum. This is partly due to the multiple maneuvering jets assisting in the running process. The act of running does tire out its operator, but at 10% of the usual fatigue rate thanks to the robot exoskeleton.

Leaping: The powerful robot legs can leap up to 15 feet (4.6 m) high or across unassisted by the thrusters. A jet thruster assisted leap can propel the unit up to 110 feet (36.5 m) high and 200 feet (61 m) across without actually attaining flight.

Flying: The turbine propulsion system enables the Sidewinder to hover stationary up to 300 feet (91.5 m) or fly. The maximum speed is 250 mph (400 km), with a maximum altitude of 6000 feet (1829 m). Higher than this, strong winds and rough weather make flight both erratic and dangerous. The SAMAS is just too small and light, it was designed to be a low altitude power armor suit that could hug the ground and slip under enemy radar, as well as engage in urban assaults and surgical strikes.

Flying Range: Maximum range is unlimited due to the nuclear power system but the engines need a cool-down period after ten hours of use.

Underwater Capabilities: Swimming: The SAMAS can *swim* using the same types of paddling leg and arm movements as a human at a maximum speed of roughly four mph (6.4 km/3.4 knots). It can also walk along the bottom of the sea at about 25% its normal running speed. Using the jet thrusters, the SAMAS can travel on the surface of water at 50 mph (80 km/42.5 knots), underwater at 40 mph (64 km/34 knots) or fly above the water's surface at normal speeds.

Maximum Ocean Depth: 800 feet (224 m).



## Statistical Data

Height: 8 feet at the head, 10 feet at the shoulders.

Width: Wings down: 4.3 feet

Wings extended: 10 feet (3 m)

Length: 4 feet, 6 inches (1.4 m)

Weight: 490 lbs (220.5 kg) without a rail gun.

Physical Strength: Equal to a robot strength of 30.

Cargo: None

Power System: Nuclear; average life of a Sidewinder is 10 years.

Cost: 3.6 million credits for a new or almost new suit with full weapons load. **Note:** Stolen (and used) CS SAMAS sell for around 1.6 million credits, but are rarely available.

## Weapon Systems

**1. MML 12 Mini-Missile Launchers:** The two boxes on the shoulders are the mini-missile launchers, nicknamed the "Toasters," because they look like four-slice toasters turned sideways and because they "toast" an opponent. Each holds 12 mini-missiles and gives the Sidewinder its punch against hardened positions and armored units. The missiles are guided by the armor's targeting system and gain an additional +3 to strike. This gives the missiles a total of +6 to strike, making them a very accurate and deadly weapon system.

Primary Purpose: Assault and Anti-Armor.

Secondary Purpose: Air defense and Anti-Missile.

Missile Types: Any type of mini-missile can be used.

Mega-Damage: Varies with missile used.

Rate of Fire: One at a time, or in volleys of 2 or 4.

Maximum Effective Range: Varies with missile used. Usually about a mile (1.6 km).

Payload: 12 missiles in each "toaster" for a total of 24 missiles.

**2. Arm Mounted Short-Range Lasers (2):** Mounted on each forearm is a small laser, primarily used as anti-personnel weapons.

Primary Purpose: Anti-Personnel

Secondary Purpose: Defense

Mega-Damage: 2D6 M.D. per single blast or 4D6 per simultaneous dual blast from both arm weapons (part of the Sidewinder's special combat system).

Rate of Fire: Equal to the combined number of attacks of the pilot. Each single or simultaneous double blast at the same target counts as one melee attack.

Maximum Effective Range: 1,200 feet (366 m)

Bonuses: Computer targeting, and synchronized firing (for dual, simultaneous blasts from both arm weapons at the same target); +1 to strike.

Payload: Effectively unlimited.

**3. Hand-Held Weapons:** Any hand-held weapon can be used by the Sidewinder power armor, but the Bandit 6000 Grenade Launcher or C-40R rail gun were intended to be standard issue.

**4. Hand to Hand Combat:** The Sidewinder is very adept in hand to hand combat. Its quick reflexes and high strength give it all of the same damage and bonus capabilities as the standard, old-style "Death's Head" SAMAS, plus +1 on initiative, +1 to parry and +2 to dodge in addition to those normally available to the SAMAS. Power Armor Combat Training: Basic and Elite applies to the Sidewinder and Wild Weasel; see **Rifts® RPG**, page 45.

**5. Sensor Systems of Note:** The Sidewinder SAMAS has all the standard sensors of power armors and the Coalition SAMAS.

**6. Vectored Thrust System:** The Sidewinder's claim to fame is its vectored thrust system which provides greater maneuverability, control, thrust and speed (see bonuses and speed).

**7. Penalties:** The Sidewinder is a very demanding power armor to fly and control. The abrupt movements and high mobility tend to place many G-forces on the pilot. For this reason the pilot must have a physical endurance of at least 16 and a physical prowess of at least 15 in order to fly the Sidewinder. The pilot should also be specifically trained in SAMAS Elite piloting skill. Those who are not, don't get the benefit of the special bonuses attributed by this armor, and are -3 to roll with punch, fall or impact.

---

# Wild Weasel SAMAS

---

The Wild Weasel version of the Sidewinder was designed to be a one-man infantry electronic-countermeasure and communications unit. Its mission is to work alongside the standard SAMAS (in this case, the Sidewinder) to provide support, battlefield intelligence, anti-missile capabilities and forward observation and targeting. The Sidewinder is slightly faster than the Wild Weasel, but is also slightly less heavily armored. The Wild Weasel has the heavier armor, because it is more likely to be a target. Keeping in mind its role of information gathering and transmission, the Wild Weasel has (comparatively) short-range, plasma ejector forearm blasters with greater damage capability to destroy any missiles that may evade its jamming defense. It also counts on other units to come to its defense, while the Weasel continues to gather and transmit vital combat data and communications.

## Bandito "Wild Weasel" SAMAS

**Model Type:** PA-09-AVT

**Class:** Vectored Thrust Strategic Armor Military Assault Suit

**Crew:** One pilot

### M.D.C. by Location:

Shoulder Wings (2) — 95 each

Shoulder/Wing "Black Boxes" (2) — 75 each

\* Main Turbines (2; rear) — 120 each

\* Lower Maneuvering Jets (4; rear) — 30 each

\* Leg Maneuvering Jets (1 per leg; lower) — 12 each

\* Waist Maneuvering Jets (4) — 15 each

\* Head — 110

\* Hands (2) — 30 each

Arms (2) — 90 each

Legs (2) — 150 each

\* Forearm Guns (2) — 18 each

\* Bandit 6000 Grenade Launcher or Rail Gun (1) — 80

\*\* Main Body - 320

\* A single asterisk indicates extremely small targets to hit and require a called shot at -4 to strike. Hits by missiles will generally damage the main body.

Destruction of the head will most likely kill or blind the pilot and will knock out all forms of communications, sensors,

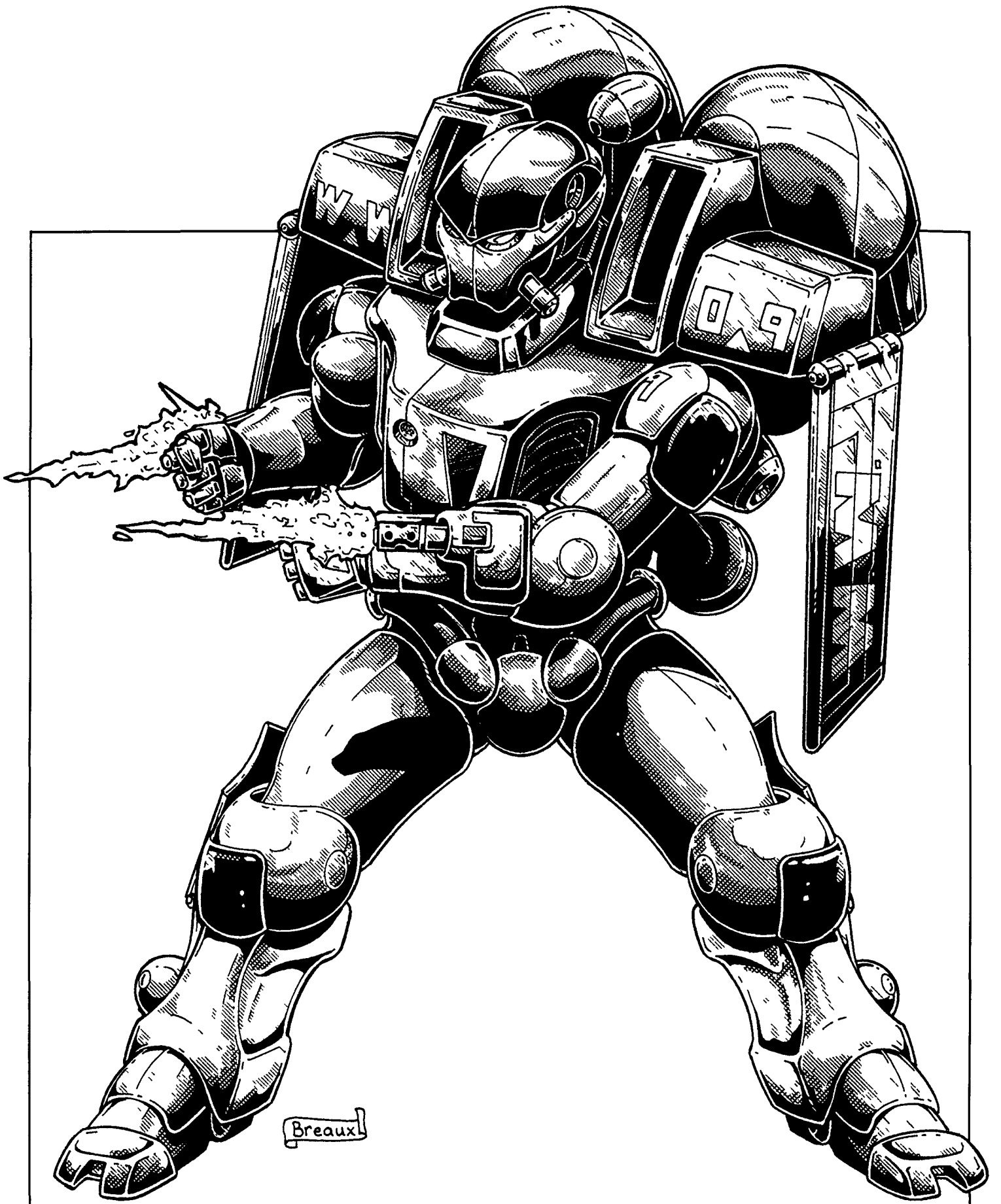

targeting etc., The pilot must rely on his own human vision and senses; no power armor combat bonuses apply.

Destruction of even one of the main wings will force the unit to crash-land.

Destruction of the maneuvering wings will impart a -1 to dodge penalty for each wing destroyed and reduce speed by 10%.

\*\* Destruction of the main body will destroy the power armor and leave the pilot inside vulnerable — assuming he survived the destruction of the suit.

### **Speed:**

Running: 60 mph (96 km) maximum. This is partly due to the multiple maneuvering jets assisting in the running process. The act of running does tire out its operator, but at 10% of the usual fatigue rate thanks to the robot exoskeleton.

Leaping: The powerful robot legs can leap up to 15 feet (4.6 m) high or across unassisted by the **thrusters**. A jet **thruster** assisted leap can propel the unit up to 100 feet (30.5 m) high and 200 feet (61 m) across without actually attaining flight.

Flying: The turbine propulsion system enables the Wild Weasel to hover stationary up to 1000 feet (305 m) or fly. The maximum speed is 220 mph (352 km), with a maximum altitude of 6000 feet (1829 m). Higher than this, strong winds and rough weather make flight both erratic and dangerous. The SAMAS is just too small and light. It was designed to be a low altitude power armor suit that could hug the ground and slip under enemy radar, as well as engage in urban assaults and surgical strikes.

Flying Range: Maximum range is unlimited due to the nuclear power system but the engines need a cool-down period after ten hours of use.

Underwater Capabilities: Swimming: The SAMAS can *swim* using the same types of paddling leg and arm movements as a human at a maximum speed of roughly four mph (6.4 km/3.4 knots). It can also walk along the bottom of the sea at about 25% its normal running speed. Using the jet thrusters, the SAMAS can travel on the surface of water at 50 mph (80 km/42.5 knots), underwater at 40 mph (64 km/34 knots) or fly above the water's surface at normal speeds.

Maximum Ocean Depth: 1000 feet (305 m).

### **Statistical Data**

Height: 9 feet (2.7 m) from head to toe. The top mounted air foil adds another two feet (0.6 m) for an overall height of 11 feet (3.3 m).

Width: Wings down: 5.6 feet (1.7 m).

Wings extended: 11 feet (3.3 m)

Length: 5 feet (1.5 m)

Weight: 540 lbs (243 kg) without a rail gun.

Physical Strength: Equal to a robot strength of 30.

Cargo: None

Power System: Nuclear; average life of a Wild Weasel is 10 years.

Cost: 4.8 million credits for a new or almost new suit with full weapon systems.

### **Weapon Systems**

**1. WWECM 6 Black Boxes:** These are the boxes located on the shoulders of the Wild Weasel. The designation stands for Wild Weasel Electronic **Counter-Measure** Suite 6, nicknamed

the "Black Boxes." They hold a variety of communications, scrambling, jamming, radar, and targeting gear that allows the Wild Weasel to act as a very advanced forward reconnaissance, tracking, targeting and communications relay unit in the field. The system also has a very advanced and unique anti-missile system that can jam and scramble the sensors of incoming enemy missiles to cause them to miss!

Primary Purpose: Electronic Counter-Measures.

Secondary Purpose: Air defense and Anti-Missile.

Mega Damage: None

Maximum Effective Range: 100 mile (160km) radius.

### **Black Box Abilities:**

Radar & Computer Tracking System: Range of 100mile (160 km) radius when above the tree line or 100 feet (30.5 m) in the air, whichever is greater. Can identify and track 144 different targets simultaneously. Sonar for underwater use is limited to 30 mile (48 km) range.

Directional, narrow and wide band radio & laser communication: Can send and receive messages on broad or narrow bands of frequencies and send precision laser beam communications.

Radio Scrambler and Encryption System: Scrambles and unscrambles incoming and outgoing messages, decodes encrypted messages, as well as records and stores transmissions of other frequencies/channels and unscrambles them (and respond or transmit) at a later time.

Targeting Uplink: The Wild Weasel can uplink data to as many as 24 Sidewinder SAMAS or aircraft or ground troops within 50 miles (80 km). In this capacity, the Wild Weasel can be used as *a forward observer* and/or communications/data relay unit. All units receiving this data are +1 on initiative and +1 to dodge.

Full Jamming Suite: The Jammers can interfere with and garble any enemy communication transmissions with a 01-65% success rate. Successful jamming means the enemy transmission is nothing but white noise; completely unintelligible. A failed roll, 66-00, means the transmission successfully escapes the interference of the Wild Weasel, but while it is discernable, it is not the cleanest message and is still filled with interference.

In order to jam incoming missiles, the pilot must roll under his *weapon systems* skill (or *electronic countermeasures*). A successful roll means the targeting system (and/or radio control signals and scanners) of all missiles directed at him, or in his path, are scrambled, causing the missiles to veer off target; effectively -7 to strike. Roll for each missile in the volley. In the alternative, the Wild Weasel can send a direct, laser signal to one or two missiles within a 2000 foot (610 m) range, whether directed at him or another target entirely, and scramble their targeting to make them veer off target: -9 to hit their intended target. Note that this jamming ability applies to "smart bombs" as well as mini-missiles and other types of guided missiles. The jamming defense disables the missile's tracking, guidance and motor systems, it does not enable the Wild Weasel to seize control and direct the missiles to a new or different target.

Special Bonuses for the Wild Weasel: +3 on initiative, +1 to strike and parry, +2 to dodge, +1 to roll with punch, fall or impact, and +1 to pull punch. All are in addition to other bonuses and power armor combat training.

**Skill Note:** In order to operate the WW jamming systems the pilot must have the skills: basic electronics, weapon systems, read: sensory instruments and radio scrambler or electronic countermeasures. Whenever the system is used, an applicable roll must be made. Usually at -10% because of the hectic nature of combat.

**Story Note:** The Coalition States and most weapon manufacturers would kill for this advanced jamming technology, but none are aware that the Wild Weasel has this capacity. Only about 200 WWs are on the market and these are located in the New West and other wilderness areas, away from civilization. Furthermore, the fear of Coalition retribution keeps most manufacturers, especially their new allies, Northern Gun and the Manistique Imperium, from having anything to do with the supposedly stolen and bootlegged technology of the CS SAMAS.

**2. Chaff-Flare Decoy:** The Wild Weasel can also fire flares with packets that release clouds of smoke and floating particles to lure missiles to them.

Payload: Chaff-flare dispenser: 24

Note: Each chaff-flare dispenser has a 15% chance per packet fired to decoy incoming enemy missiles, with cumulative effect (i.e. 3 chaff-flares equals 45% chance of decoying missiles, 6 = 90%, etc.)

**3. Arm Mounted Short-Range Plasma Ejectors (2):** Mounted on each forearm is a small laser, primarily used as anti-personnel weapons.

Primary Purpose: Anti-Missile and Anti-Armor

Secondary Purpose: Anti-Personnel

Mega-Damage: 4D6 M.D. per single blast or 8D6 per simultaneous dual blast from both arm weapons (part of the Wild Weasel's special combat system allows for synchronized targeting).

Rate of Fire: Equal to the combined number of attacks of the pilot. Each single or simultaneous double blast at the same target counts as one melee attack.

Maximum Effective Range: 1,000 feet (305 m).

Bonuses: Computer targeting, and synchronized firing (for dual, simultaneous blasts from both arm weapons at the same target); +1 to strike.

Payload: Effectively unlimited.

**4. Hand-Held Weapons:** Any hand-held weapon can be used by the Wild Weasel, but the Bandit 6000 Grenade Launcher or C-40R rail gun were intended to be standard issue.

**5. Hand to Hand Combat:** The Wild Weasel is very adept in hand to hand combat. Its quick reflexes and high strength give it all the same damage and bonus capabilities as the standard, old-style "Death's Head" SAMAS, plus +1 on initiative and +1 to dodge in addition to those normally available to the SAMAS. Power Armor Combat Training: Basic and Elite applies to the Sidewinder and Wild Weasel; see Rifts® RPG, page 45.

**6. Sensor Systems of Note:** The Wild Weasel SAMAS has all the standard sensors of power armors and the Coalition SAMAS, plus those mentioned previously.

**7. Vectored Thrust System:** The Wild Weasel has vectored thrust which provides greater maneuverability, control, thrust and speed (see bonuses and speed).

**8. Penalties:** The Wild Weasel is a very demanding power armor to fly and control. The abrupt movements and high

mobility tend to place many G-forces on the pilot. For this reason, the pilot must have a physical endurance of at least 16 and a physical prowess of at least 15 in order to fly it. The pilot should also be specifically trained in SAMAS Elite piloting skill. Those who are not, don't get the benefit of the special bonuses attributed by this armor, and are -3 to roll with punch, fall or impact.

---

# Bionics

By Chris Kornmann & Siembieda

The following are cybernetics, bionic reconstruction, robots and equipment that are generally offered by *Bandito Arms/The Black Market, Northern Gun* and *Manistique Imperium*. These items are most popular in the West, but are occasionally found (or can be special ordered for 10% more) just about anywhere. Availability for most items is fair to good.

---

## New Cybernetics

### Mining 'Borg Attachments

**Note:** In most cases, the tool draws on the power supply of the cyborg, so they have an effectively unlimited payload and lifetime of use. Although they can be used as hand to hand weapons, they are not intended for combat. They are tools.

**Chemical Spray:** Typically an acid doing 4D6 S.D.C. used for cleaning metal ores, but can also include other chemicals such as foam for putting out fires, etc. Can be built into the hand, chest or mouth of a full conversion 'Borg.

**Forearm Attachment: High-Powered Flashlight:** The light beam can be adjusted to be a narrow beam or wide (20 ft/6 m arc). **Range:** 600 feet (183 m) as a narrow beam, or 60 feet (18.3 m) as a wide beam. This flashlight can also be mounted on the cyborg's head and can be conventional light or infrared. **Cost:** 1,000 credits.

**Modular Hand Housing:** A bionic housing that enables the cyborg to use a variety of interchangeable hands. **Cost:** 5,000 credits.

**Modular Arm Housing:** A bionic housing that enables the cyborg to use a variety of interchangeable forearms. **Cost:** 8,000 credits.

**Modular Hand: Laser Hand:** The first two fingers of the hand are precision cutting lasers similar to the laser scalpel. They are used for repairs, welding and cutting. M.D.C.: 35 per hand; **Damage:** Four settings: 6D6 S.D.C., 1D4 M.D., 1D6 M.D. and 2D6 M.D. **Range:** 8 feet (2.4 m). **Cost:** 36,000 credits each.

**Modular Hand: Shovel Hand:** Large hands with thick, strong fingers that taper at the fingertips. When the hand is open, flat, with the fingers pressed against one another, the hand can be used as both a shovel and a chisel. M.D.C.: 50 per hand; **Damage:** Does 1D4 M.D. as a digging, stabbing or chopping weapon/attack. **Penalties:** Skills requiring precision use of the hands and the use of small tools are -15%. **Cost:** 35,000 credits each.

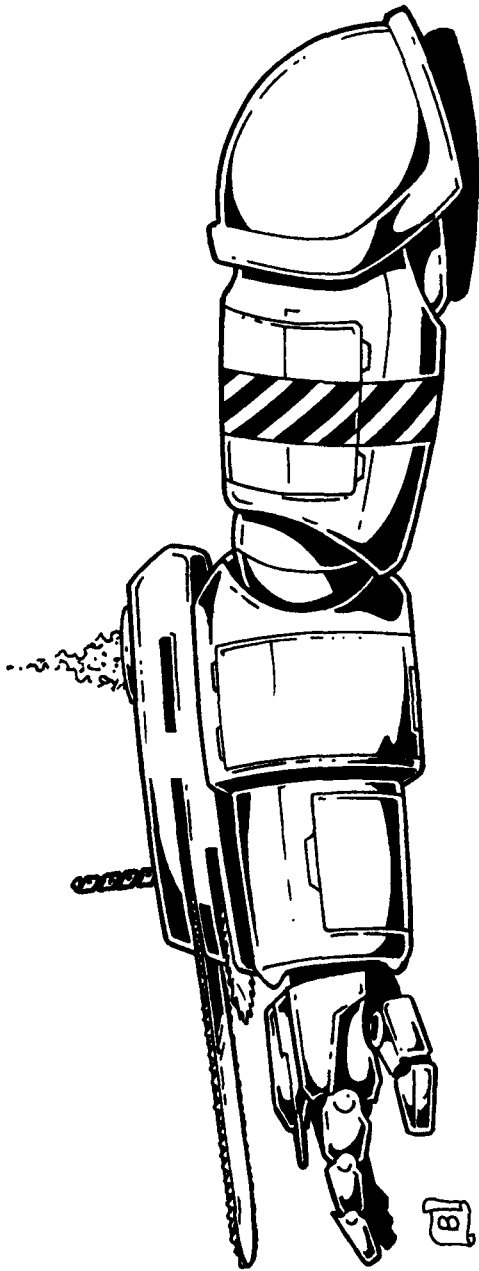

**Modular Hand: Vibro-Monster Claw Hand:** An oversized hand with three thick fingers and a thumb, with the last digit being a large, hooked claw that resembles a mechanical talon. It is used for crushing, clawing and digging through packed earth, clay and rock. **Damage:** Does 3D6 M.D. as a weapon. **Penalties:** This is not a good hand for precision work or even picking up objects; -20% on all skills. **Cost:** 45,000 credits per each hand.

**Modular Forearm Attachment: Air Blaster:** A high-powered air gun with several nibs and nozzles for a variety of work, from a gentle puff of air to clean delicate electronics, machine mechanisms, bones or artifacts to stronger blasts of air used to blow away rock and debris, and finally to hammering blasts used in breaking fractured rock and to sandblast. **M.D.C.:** 40 per arm. **Damage:** From zero to 1D6 S.D.C. to one M.D. as a sand blaster and rock splitter. This blast also has a 01-60% chance of knocking human-sized opponents off their feet (victims are knocked down, lose initiative and one melee action). **Range:** One foot (0.3 m). **Cost:** 66,000 credits.

**Modular Forearm Attachment: Jackhammer:** Instead of hand and forearm there is a heavy-duty Jackhammer designed to break rock into small pieces, typically used on rock that has already been drilled, or for construction or demolition of buildings. **M.D.C.:** 50 per Jackhammer arm. **Damage:** Does 2D6 M.D. as a hammering weapon/attack, but does not have the same focused penetrating power of a drill. **Cost:** 60,000 credits.

**Modular Forearm Attachment: Multi-Tool:** This is a light work/utility arm and hand. The hand (25 M.D.C.) has four fingers and a thumb, but one finger is a flashlight (20 ft/6 m effective range), one finger is a utility laser (1D4, 1D6 or 3D6 S.D.C. damage; range 10 ft/3 m), and on top of the hand is a sensor unit equal to *sensor hand*.

Mounted on the forearm is a retractable chain saw (1D6×10 S.D.C., or 1D4 to 2D4 M.D.), a circular saw (1D4×10 S.D.C. or one M.D.), a retractable drill (small; 1D6, 2D6 or 3D6 S.D.C.), and a retractable welding torch (rod-style; 1D6 to 2D6 S.D.C.).

Plus E-Clip arm port, concealed retractable laser rod (1D6 M.D., 800 ft/224 m range) and concealed retractable power nailer (shooting nails do 1D4 S.D.C. damage and have a range of 20 ft/6 m). **Cost:** 88,000 credits each.

**Modular Forearm Attachment: Heavy Mining Drill:** In place of a hand and forearm is a huge, powerful looking drill for making large holes (a man can fit his arm through these holes and still have room) in rock and metal and drilling away rock. A handful of detachable drill bits in a variety of large sizes are available. **M.D.C.:** 50 per drill arm. **Damage:** Does 3D6 M.D. as a drill weapon/attack. **Cost:** 66,000 credits.

**Modular Forearm Attachment: Precision Mining Drill:** In place of a hand and forearm is a thin, narrow, high-powered drill for making small holes and precision drilling; detachable drill bits come in a variety of sizes. Can be used for mining and building/construction. **M.D.C.:** 30 per drill arm. **Damage:** Has three settings: 4D6 S.D.C., 1D4 M.D. and 2D4 M.D. as a drill weapon/attack. **Cost:** 60,000 credits.

**Modular Forearm Attachment: Plasma Torch:** In place of an arm and hand is a versatile plasma torch used for repairs, welding and cutting. **M.D.C.:** 45 per unit. **Damage:** Four settings: 1D6×10 S.D.C., 1D6 M.D., 2D6 M.D. and 4D6 M.D. **Range:** 3 feet (0.9 m). **Cost:** 75,000 credits each.

**Modular Forearm & Hand Attachment: Sonic.** A sonic pulse and scanner system for reading images of what lies underground. **Damage:** None. **Range:** 1000 feet (305 m). Also has a built-in metal-detector. **Damage:** None. **Range:** 3 feet (0.9 m). **Cost:** 52,000 credits.

**Modular Forearm Attachment: Vibro-Pick:** In place of a hand is a classic pickaxe. **M.D.C.:** 35 per hand. **Damage:** Does 2D6 M.D. as a digging or chopping weapon/attack. **Cost:** 24,000 credits.

## Other Bionic Items & Features

**Bandito Arms, Northern Gun** and others often offer a wide variety of cybernetic and/or robot upgrades, options, and weapons systems. This can range from a rail gun mounting to added armor plating or a nice, new paint job. The following is a list of some of the cybernetics and robot options frequently offered.

**Boosters and Maneuvering Jets:** Built into the feet, lower legs, back and shoulders of full conversion 'Borgs, these small

jets are used to help the cyborg maintain balance, as well as buoyancy in water (can actually propel the character underwater at a sluggish speed of three knots per hour. **Cost:** 18,000 credits.

**Combat Computer:** This is a marvel of computer miniaturization and human/machine integration. The combat computer, using whatever sensors and sensory abilities of the 'Borg, gathers and analyzes data and sends it to the brain of the cyborg where it is translated to enhance the character's reflexes and response time. **Bonuses:** +1 on initiative, +1 to dodge, +1 to disarm, +2 to pull punch, and +2 to roll with punch, fall or impact. **Cost:** 150,000 credits.

**Customized Paint Job:** Basically the same as customizing body armor with special colors, designs, insignias, and so forth. **Cost:** 800-3000 credits.

**Customized Face or Armored Plate:** Handsome, beautiful, monstrous, robotic, ornate, or whatever the purchaser may desire. **Cost:** 2,000 to 20,000 credits, depending on the complexity.

**Extra Appendage/Arms:** Prehensile tail: 30-50 M.D.C., adds one extra attack. Extra pair of arms and hands (human-like or tentacles): 40-80 M.D.C. per arm, adds one extra attack per melee round. **Cost:** 200,000-220,000 for a prehensile tail, 250,000 for an extra pair of hands and arms. See Rifts® RPG, pages 239 and 240, for details.

**Extra Armor Plating:** This can be added to any full conversion cyborg and most robots. Small robots about the size of a dog can have as much as 30 M.D.C. added, man-sized 80 M.D.C., horse-sized robots can have as much as 150 M.D.C. added, and anything larger than horse-sized can generally have 200 M.D.C. added (this includes most large vehicles). **Cost:** Varies; typically about 1,500 credits per two points of extra M.D.C. (75,000 credits for 100 M.D.C.).

**Quick Draw Holsters:** These are basically compartments built into the legs of the cyborg that serve as holsters and holders of handguns, knives or sawed-off shotguns. Upon mental command, they literally spring into the waiting hands of the cyborg. This gives the character an initiative bonus of +1 with these weapons. **Cost:** 10,000 credits.

**Stabilizing Anchors:** Like the Glitter Boy, small spikes, about 8 inches (0.4 m) long shoot out of the lower legs and into the ground to anchor the cyborg in place. These are sometimes used in construction and climbing. **Cost:** 5,000 credits.

**Western Wilderness Survival Kit:** This is a survival kit that is packed into a cyborg's or robot's secret compartment(s). This survival kit is said to have everything one could possibly need to survive. **Cost:** 75,000 credits

Pocket tool kit

20 feet (6 m) of wire

12 Rubber Bands

6 Safety Pins

6 Sewing Needles and a spool of thread

Fishing line and hooks

Pocket Mirror

6 hand flares

Pocket Knife

Laser Scalpel

Cigarette Lighter

Small Flashlight

Small Silver Cross

Bottle of Aspirin (50 tablets)

1 IRMSS kit

1 RMK kit

Compass

One week's dried food rations.

# New West Cyborgs

## CyberSlinger

### Series of Cyborgs

*As the large clock in the town square began the first of the chimes heralding the arrival of "high noon," a tall man walked confidently into the center of main street. His overcoat blew lazily in the breeze as he walked. His eyes, all but covered by the brim of the hat that hung low on his brow, looked up the street to see his opponent standing before him. His rival in this showdown stood over nine feet (2.7+ m) tall and glinted in the sun. The cyborg wore a sombrero on his monstrous head, and had an ornate Mexican shawl draped over him. The 'Borg smiled as the man pushed aside his overcoat, revealing the pair of Magnum revolvers with which he had intimate relations. The machine-man's arms hung low at his side, looking almost as if he were bored. The man knew the time had come to finish what had been started so many days earlier. All too aware of his human frailty, he mustered all of his energy and went for his guns with the lightning speed capable only of a professional Gunslinger — in this case, a **Psi-Slinger**.*

*He let loose a flurry of psionic charged blasts from his twin guns that ripped into the cyborg only a second quicker than his quarry could fire. Against a normal man, this would have been enough to win the day, but against a CyberSlinger ...*

*The cyborg staggered from the Psi-Slinger's onslaught (the repairs to his armor and some internal mechanisms would cost him dearly). Even as he fell backwards, he unleashed his guns with frightening accuracy. As the Psi-Slinger's chest exploded, his last thoughts were the satisfaction of knowing that he had beaten the damn 'Borg to the draw. Unfortunately, in the New West, sometimes that isn't enough.*

*Before the dust had settled, a small man ran up to the 'Borg who had holstered his "shooting irons" and was packing his tattered poncho into the opening in his chest to stop the flow of vital fluids. The small man brandished a camera and took the CyberSlinger's picture (with his permission, of course). Later that day, after the 'Borg had undergone some much needed patch work, the same man, a saloon owner, took another picture of the CyberSlinger standing next to the pine box that held the remains of his victim, a notorious rogue with a bad attitude and a penchant for trouble. It was only a matter of time before somebody sent him to his maker. Hell, it was a wonder that he had lasted the five and a half years that he had. Nobody would cry over his grave.*

*Just another day in the badlands of the New West.*

The following are a few cyborg body designs popular in the New West. All are available from both Northern Gun and Bandito Arms (both accuse the other of "knocking off their products).

Anyone open to cyborg augmentation and willing to pay the price of their humanity can become a CyberSlinger. Most are outlaws and mercenaries who want the skill and power of the gunslinger without the years of training and natural aptitude necessary. Many more are simply men and women of the New West who find that the durability and power of the cyborg body is

much more befitting the violent new world of Rifts Earth. In any event, the CyberSlinger series of augmentation packages is very popular and becoming more and more common across the landscape of the New West.

The CyberSlinger package is a full conversion cyborg process that will turn an average man into a lightning quick, bionic Gunslinger. Like Mining 'Borgs and other types of augmentation, the recipient can often make arrangements with a town or wealthy individual to get the bionic conversion in trade for 10-15 years of service as lawman, protector, or henchman.

**Note:** These are different types of cyborg bodies, but all fall into the 'Borg O.C.C. category.

## "The Kid"

### CSLNGR Mark I

The first in the CyberSlinger series is the Mark I or the "Kid." The Kid gets its name from the slang of the American Old West, frequently used as a nickname or part of a nickname for gunslingers and outlaws, and also because this particular cyborg body is extremely human in proportion, size and shape.

The Kid is a basic cyborg body with enhanced reflexes. The unit is not much bigger than a standard human and is relatively easy to conceal or pass off as body armor. The Kid retains the original face of the person who is augmented and a natural looking artificial skin can make the individual seem completely human. This makes it very popular among those who cherish their humanity and/or like to disguise their true nature. Of course, this means the Kid doesn't come with any built-in weapon systems, arm mounts, or any other telltale cybernetic appliances. Another advantage to this model of cyborg is that it is relatively inexpensive.

### CSLNGR Mark I "Kid"

**Model Type:** CSLNGR Mark I

**Class:** Full Conversion Cyborg

#### M.D.C. by Location

\* Head (1) — 35 (reinforced)

\* Hands (2) — 15 each

Arms (2) — 45 each

Legs (2) — 100 each

\*\* Main Body — 150

\* The head, although retaining the original face and brain (often the eyes, tongue, voice and other features of the human head), is reinforced in order to provide the 35 M.D.C. Targeting the head and hands requires a "called shot" and even then the shooter is -4 to strike.

\*\* Reducing the main body to zero M.D.C. means it is shattered, riddled with holes, leaking vital fluids and incapable of movement or speech. However, the internal life support systems will keep the 'Borg's brain alive for 4D6 hours before it fails and the brain dies.

**Note:** The human shape and proportions means the Kid cyborg can wear conventional body armor like any normal human.

#### Speed

**Running:** Speed Factor 132, or 90 mph (148 km).

**Leaping:** 20 feet (6 m) high or lengthwise; double with a running start.

**Flying:** The Kid is not capable of flight, but is suitable for use with a jet pack.

#### Statistical Data

**Size:** Human

**Height:** Usually about 6 feet, 4 inches (roughly 1.9m).

**Weight:** 400 lbs. (180 kg)

**Bionic Physical Attributes:** Robot P.S.: 20, P.P.: 22, Spd: 132.

**Power System:** Nuclear, average life of 25 years.

**Cost:** 3.6 million to 3.9 million credits. Add 100,000 credits for human-looking skin covering.

#### Standard Bionic Features:

Bionic Lung

Amplified hearing: +1 to parry, +2 to dodge, +3 to initiative.

Sound filtration system

Clock/calendar/computer/gyro compass

Multi-optic eyes: +1 to strike.

Quick draw holsters in legs (2); +1 on initiative.



Headjack

Climbing Cord

Combat Computer: +1 on initiative, +1 to dodge, +1 to disarm, +2 to pull punch, and +2 to roll with punch, fall or impact.

**Weapon Systems:** The Kid has no built-in weapon systems.

**Special Bonuses:** Any skills that require a high dexterity or reflexes, such as piloting, lock picking, palming, etc., gain a bonus of +2%.

## "Super Slinger" Cyborg

### CSLNGR Mark II

The Super Slinger is another, predominately human-sized, human-looking cyborg, except that it is designed for quick draws and has four lightning fast arms. This deadly cyborg can be quite deadly, because the extra pair of arms gives it an extra melee attack and the combat computer enables the 'Borg to draw and fire four (light) weapons simultaneously. However, unlike a true Gunslinger O.C.C., the cyborg cannot split its attacks between two different targets and the firing of each *pair* of weapons counts as one melee attack/action each (i.e. four weapons drawn — one with each hand — counts as two melee attacks/actions). This CyberSlinger cyborg package is more costly, but larger and slightly more armored. When a Super Slinger comes to town, one word comes to mind...Duck!

### CSLNGR Mark II "Super Slinger"

**Model Type:** CSLNGR Mark II

**Class:** Full Conversion Cyborg

#### M.D.C. by Location

\* Head (1) — 45 (reinforced)

\* Hands (4) — 15 each

Arms (4) — 60 each

Vibro-Blades (2; retractable) — 50 each

Legs (2) — 120 each

\*\* Main Body — 190

\* The head, although retaining the original face and brain (often the eyes, tongue, voice and other features of the human head), is reinforced in order to provide the 45 M.D.C. Targeting the head and hands requires a "called shot" and even then the shooter is -4 to strike.

\*\* Reducing the main body to zero M.D.C. means it is shattered, riddled with holes, leaking vital fluids and incapable of movement or speech. However, the internal life support systems will keep the 'Borg's brain alive for 4D6 hours before it fails and the brain dies.

**Note:** The close to human shape and proportions means the Super Slinger can wear body armor designed for large humans and D-bees, and modified for its four arms.

Speed

Running: Speed Factor 132, or 90 mph (148km).

Leaping: 20 feet (6 m) high or lengthwise; double with a running start.

Flying: The Super Slinger is not capable of flight, but is suitable for use with a jet pack.

#### Statistical Data

Size: Large, tall human.

Height: Usually about 6 feet, 8 inches to 7 feet (roughly 2.1 m).

Weight: 600 lbs. (270 kg)

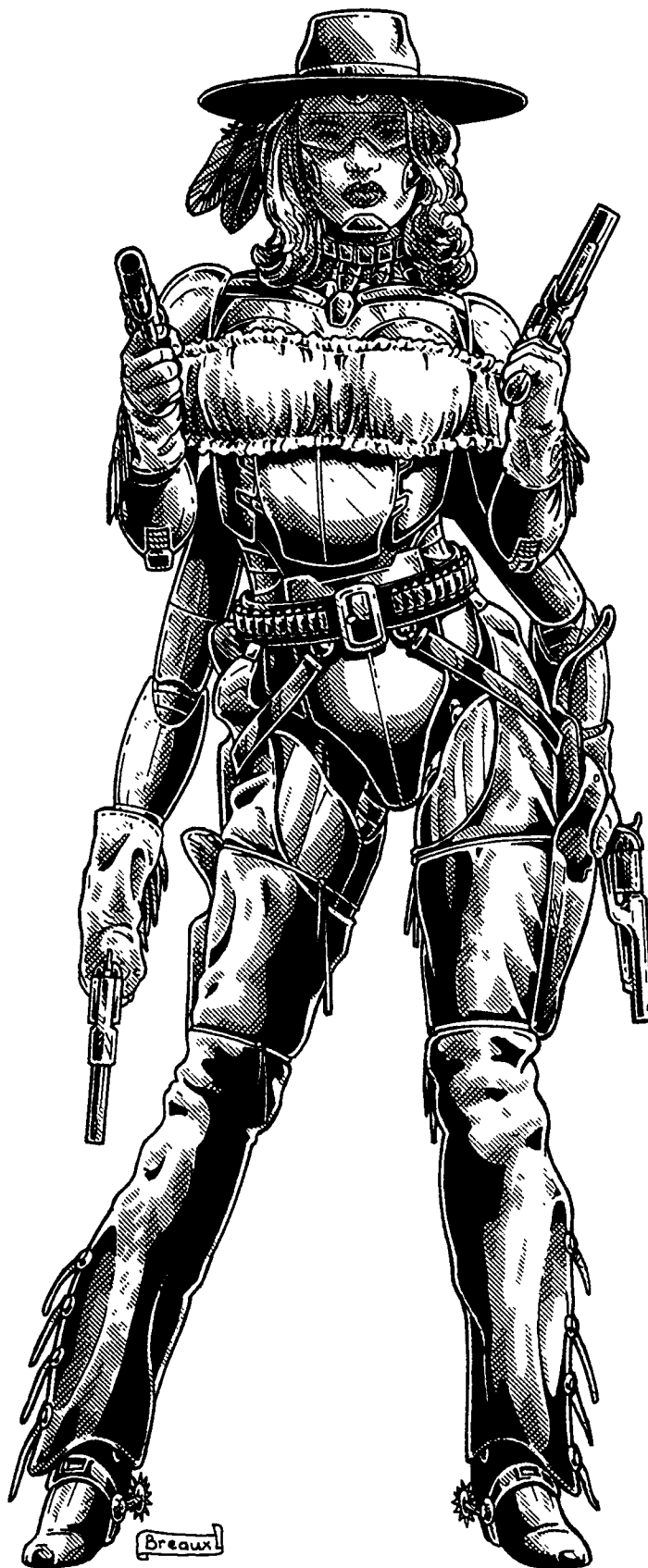

**Bionic Physical Attributes:** P.S.: 22, P.P.: 24, Spd: 132.

**Power System:** Nuclear, average life of 25 years.

**Cost:** 5.6 million to 6 million credits. Add 130,000 credits for human-looking skin covering.

#### Standard Bionic Features:

Four bionic arms (+1 attack per melee)

Bionic Lung



Amplified hearing: +1 to parry, +2 to dodge, +3 to initiative.

Sound filtration system

Clock calendar/computer/gyro compass

Multi-optic eyes: +1 to strike.

Quick draw holsters in legs (2); +1 on initiative.

Fingerjack in one hand.

Laser finger (1D6 M.D.; 300 ft/91.5m range) on one hand.

Energy-Clip arm port (1) on one arm.

Headjack

Climbing Cord

Retractable Vibro-Sabres in the forearms of one pair of arms.

Combat Computer: +1 on initiative, +1 to dodge, +1 to disarm, +2 to pull punch, and +2 to roll with punch, fall or impact.

**Weapon Systems:** Vibro-Sabres (2; inflict 2D6 M.D. each).

**Special Bonuses:** Any skills that require a high dexterity or reflexes, such as piloting, lock picking, palming, etc., gain a bonus of +2%, and +1 on initiative and +2 to parry.

## "Gringo" Cyborg

### CSLNGR Mark III

The Gringo is more of a traditional, heavy 'borg design. It is big, strong, and very well armored. The Gringo lacks some of the speed and agility possessed by the Mark I and II, but makes up for this with its size and armor. The Gringo, like the other two models, has the integral combat computer for use with its weapons. Unlike the other two models, it also has a chest mounted ion cannon and a six pack mini-missile launcher above each shoulder. Whereas the Kid and the Super Slinger have the elegance of lightning reflexes and speed, the Gringo has brute strength and firepower.

### CSLNGR Mark III "Gringo"; also known as the Rock.

**Model Type:** CSLNGR Mark III

**Class:** Full Conversion Cyborg

#### M.D.C. by Location

\* Head (1) — 80

\* Hands (2) — 25 each

Arms (2) — 100 each

Vibro-Blades (2; retractable; inflict 2D6 M.D. ea.) — 50 each

Missile Launchers (2) — 40 each

Legs (2) — 160 each

\*\* Main Body — 220

\* The head, although retaining the original face and brain (often the eyes, tongue, voice and other features of the human head), is reinforced in order to provide the 80 M.D.C. Targeting the head and hands requires a "called shot" and even then the shooter is -4 to strike.

\*\* Reducing the main body to zero M.D.C. means it is shattered, riddled with holes, leaking vital fluids and incapable of movement or speech. However, the internal life support systems will keep the 'Borg's brain alive for 4D6 hours before it fails and the brain dies.

**Note:** Human-sized body armor cannot be worn by the Gringo, but cyborg armor can be (typically 200 M.D.C.).

#### Speed

Running: Speed Factor 88, or 60 mph (96 km).

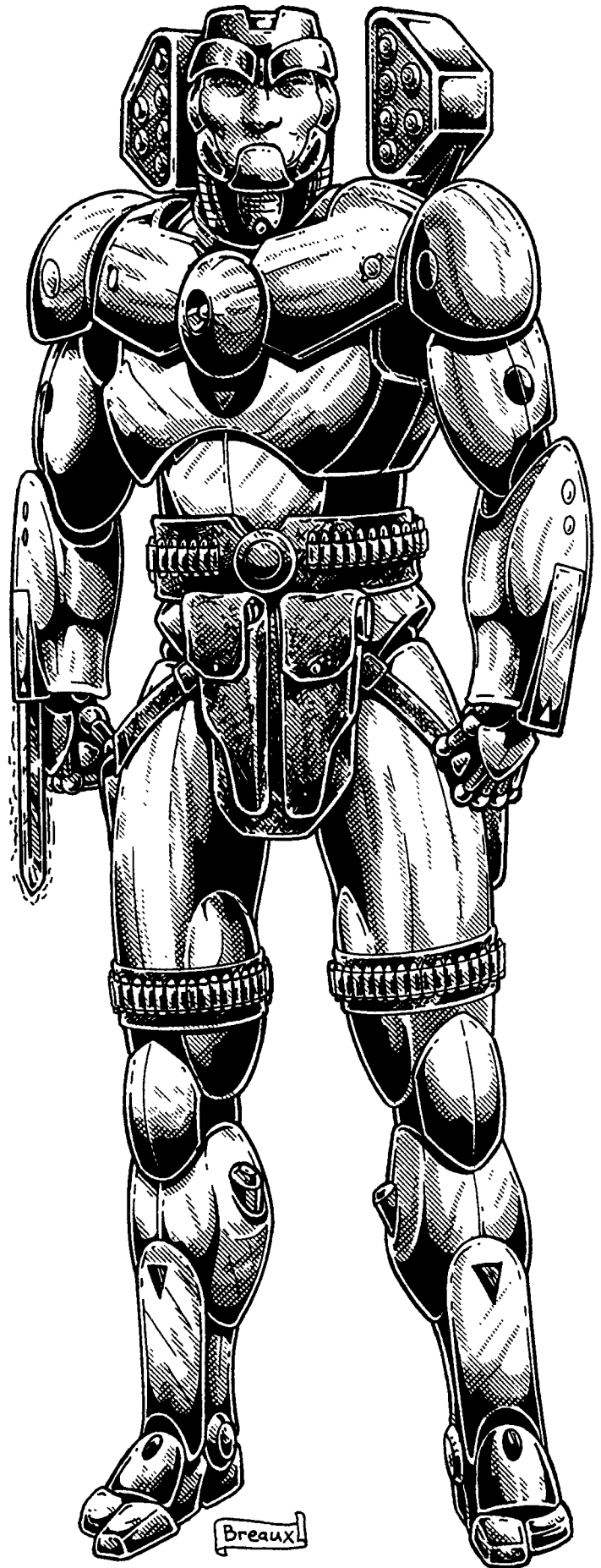

Leaping: 20 feet (6 m) high or lengthwise; double with a running start.

Flying: The Gringo is not capable of flight, but is suitable for use with a jet pack.

### Statistical Data

Size: Giant humanoid.

Height: Usually about 9-10 feet (2.7 to 3 m).

Weight: 1200 lbs. (540 kg)

Bionic Physical Attributes: P.S.: 30, P.P: 24, Spd: 88.

Power System: Nuclear, average life of 25 years.

Cost: 6.1 million to 6.4 million credits.

### Standard Bionic Features:

Bionic lung and toxic filter.

Loudspeaker

Voice Modulator

Amplified hearing: +1 to parry, +2 to dodge, +3 to initiative.

Sound filtration system

Clock calendar/computer/gyro compass

Multi-optic eyes: +1 to strike.

Quick draw holsters in legs (2); +1 on initiative.

Laser finger (1D6 M.D.; 300 ft/91.5 m range) on one hand.

Energy-Clip arm port (1) on one arm.

Headjack

Climbing Cord

Chest mounted Ion blaster

Six pack mini-missile launchers (2), one on each shoulder.

Retractable Vibro-Blades in the forearms.

Combat Computer: +1 on initiative, +1 to dodge, +1 to disarm, +2 to pull punch, and +2 to roll with punch, fall or impact.

**Special Bonuses:** +1 to disarm, +1 to parry with Vibro-Blades, +3 to pull punch, and +2 to roll with punch, fall or impact.

### Weapon Systems

**1. Retractable Vibro-Blades:** Located in the forearms of the Gringo are Vibro-Sabres. Each has 50 M.D.C.

Primary Purpose: Defense

Secondary Purpose: Anti-Personnel Hand to Hand Combat

Mega Damage: 2D6 each

**2. Chest Mounted Ion Blaster:** A high-powered ion blaster capable of a very high damage yield, built into the chest.

Primary Purpose: Assault

Secondary Purpose: Defense

Mega-Damage: 4D6 M.D. per blast

Range: 800 feet (244 m)

Payload: Effectively unlimited.

Bonuses: +1 on initiative.

**3. Shoulder Mounted Mini-Missile Launchers:** These two launching systems are used for heavy support.

Primary Purpose: Assault

Secondary Purpose: Anti-Missile

Mega-Damage: 1D4×10M.D. each

Range: One mile (1.6 km).

Rate of Fire: One at a time, or in volleys of 2, 4, 6 or 12.

Payload: 12 total; six in each launcher.

**4. Optional Use of Hand-Held Weapons:** Any hand-held weapon can be used, from rail guns to laser rifles.

---

# Robots & Vehicles

---

## The Tarantula ATV

### Who's Afraid of Spiders?

*Major Amanda Marie Nadra scanned the desert horizon as the sun said its goodnight to the day. She instinctively switched to infrared and her thermo-imager in order to see any ambient heat signatures that just might be out of place in the cooling desert. All was quiet, as it had been every night this week. This job was getting boring, she thought to herself. She had joined the 1st Cavalry ten years ago with visions of glory and the promise of adventure. She rose quickly through the ranks and fought in many of the largest battles with the outlaws to the south. She was a good soldier and she knew it. As she continued to scan the desert around the Calvary outpost she was suddenly knocked backward at the sight of a massive heat signature that belonged to a giant, eight-legged spider.*

*She rolled away from a blast of rail gun fire which seemed to come from the creature before her. Instinctively, she drew her sidearm and began to fire blindly into the spider. How it had managed to sneak past her watchful eye was not an issue she had time to deal with at the moment. As her first blasts struck the creature dead center, she noticed a peculiar flash of sparks. Suddenly, a change in wind direction carried to her the smell of hydraulic fluid and other odors common to power armor and bots. She wasn't fighting a creature from the Rifts but a beast of another kind indeed, a mechanical behemoth created by man.*

*Major Nadra leapt to her feet, dodging another blast of rail gun fire. She struggled to put some distance between her and the metal beast. Without warning, she was lifted into the air by the blast of the mini-missiles which exploded near her. The hard earth slapped her in the face and for a moment, she nearly lost consciousness. As she turned to face her approaching opponent, she pulled the pin on one of the armor piercing grenades she always kept handy. She tried to concentrate and shake off the blurred vision, but could not. She threw the grenade just as she fell into the blackness of unconsciousness.*

*Amanda's eyes opened to an assault of sunlight. Her nose burned with the distinctive aroma of smelling salts. She was greeted by Tommy Scotch's voice telling her that everything was going to be alright. As she came to her senses, she sat forward to survey the situation. Through blurred vision and impaired senses she could see the fires of war blazing throughout her small cavalry outpost. Directly in front of her was the wreckage of the mechanical beast that nearly killed her. Tommy explained that the grenade would barely have dented the thing, but that he and other members of the Cavalry tore into it in time to save her. Others at the Cavalry Outpost weren't so lucky. Tommy administered a sedative that began to take immediate effect. "You'll be okay, kid."*

*As the warm comfort of sleep began to embrace her, she smiled. The tattered yellow banner of an owl wearing nightvision goggles still flapped in the wind. Her unit, **The NightOwls**, had given as good as they had received, and their colors still flew in the morning breeze. "Who's afraid of spiders anyway?"*

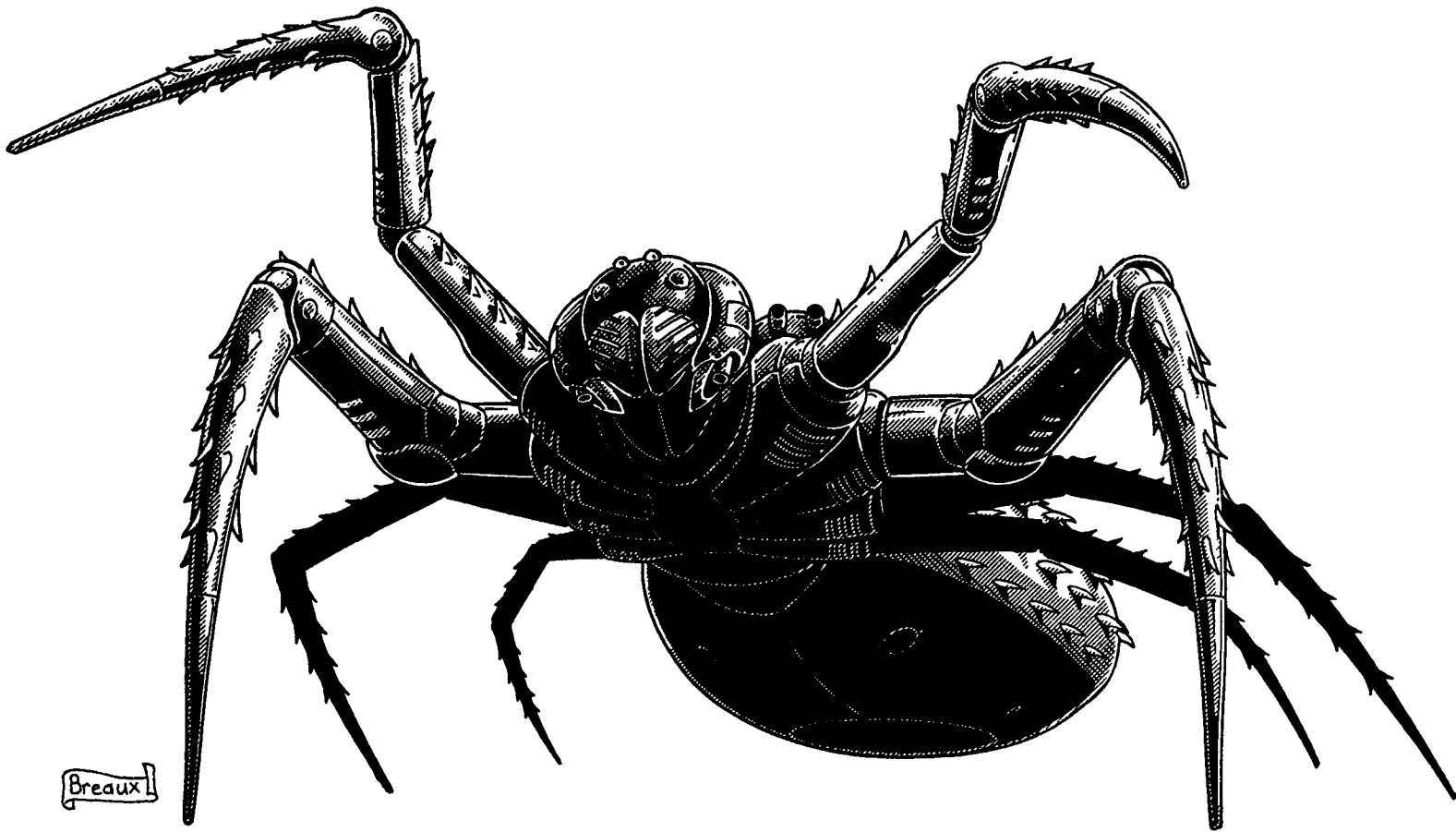

The Tarantula is a unique, eight-legged, all-terrain, robot vehicle first manufactured by Bandito Arms (based upon vehicle designs found at Area 51) and, in the last six years, knocked off by both Northern Gun and the **Manistique Imperium**. The vehicle is deliberately made to resemble a giant spider to frighten potential **humanoid** and animal antagonists — plus it looks cool (and cool always sells). Originally a hot item sold by Bandito Arms in the Western and Southwestern wilderness and badlands, Northern Gun and the Imperium have introduced The Spider (as they call it) to the eastern half of the continent, where it is growing in popularity among adventurers, explorers and mercenaries alike.

### The Bandito Tarantula (a.k.a. NG Spider)

**Model Type:** R-100

**Class:** All-Terrain Robot Stealth Vehicle

**Crew:** One pilot, a co-pilot or gunner, and can accommodate 3 passengers comfortably.

#### M.D.C. by Location:

- \* Legs (8) — 100 each
- \* Mandible Rail Guns (2) — 35 each
- \* Ion Turret (1) — 100
- \* Concealed Mini-Missile Launchers (2) — 50 each
- \* Escape Hatch (1; underbelly) — 100
- \* Hatch (1; main, top) — 100
- \* Spines/Quills (many) — 1 each

Head (with sensors and optics) — 100

Headlights (4) — 5 each

Reinforced Pilot Compartment (Fore section) — 75

Reinforced **Crew/Passenger** Area (Abdomen) — 75

\*\* Fore Section: Main Body — 200

**Abdomen/Rear** Section: Main Body — 300

\* All areas marked with a single asterisk are small or difficult targets to hit. An attacker must make a "called shot" to hit, and is -3 to strike. The mini-missile launchers are only revealed when firing and is the only time they can be struck.

\*\* Depleting the M.D.C. of the main body will destroy it. Destroying the head knocks out most sensors, optics, radar, and targeting, as well as destroying the mandible rail guns. The robot can lose a leg on each side without impairing its speed or balance. However, losing two legs on one side or two on one side and one on the other will reduce speed by 20%.

#### Speed:

Running: 100 mph (160 km) maximum. The act of running does not tire the operator because the legs of the Tarantula are completely **robotic**.

Leaping: Much like the real spider, the Tarantula can leap up to 30 feet (9 m) across and 10 feet (3 m) high.

Flying: Not possible.

Underwater Capabilities: The Tarantula is adequately suited for underwater operations. It can walk along the bottom of the sea at about 25% its normal running speed, or swim at a ponderous speed of 5 mph (8 km or 4.2 knots). Maximum Depth is 500 feet (152.4m).

#### Statistical Data

Height: 6 feet (1.8 m) low to the ground or 11 feet (3.3 m) fully erect.

Width: Overall: 15 feet (4.6 m); Main body: 6 feet (1.8 m).

Length: 14 feet (4.2 m)

Weight: 9 tons

Physical Strength: Robot strength of 30.

Cargo: Minimal; but has a 50 gallon water cooler, first-aid kit,

weapon rack for six rifles and two dozen energy clips, and storage space to accommodate 5-6 duffle bags/backpacks, eight canteens, and a few odds and ends.

Power System: Nuclear; average life of a Tarantula is 15 years.

Cost: 18 million credits for a new bot vehicle with full weapon systems. 14 million without weapons.

## Weapon Systems

**1. Mandible Rail Guns (2):** This is the standard weapon of the Tarantula and can be very deadly in combat. The weapon is capable of devastating bursts of fire. It is aimed by turning and tilting the head; can turn 360 degrees and has a 180 degree tilt up and down, forward. It can be fired by the pilot (typically) or gunner.

Primary Purpose: Assault

Secondary Purpose: Defense

Mega-Damage: A burst is 40 rounds and does 1D4×10 M.D. from a single barrel or 2D4×10 M.D. from a double-barrel attack (80 rounds). Typically fires flechette rounds.

Rate of Fire: Equal to the number of combined hand to hand attacks of the pilot (typically 4-6).

Maximum Effective Range: 4,000 feet (1220m)

Payload: 2400 per gun (60 single gun bursts each).

**2. Bandito I88 Dual Ion Cannon (1):** This is the turret mounted on the back of the vehicle. It is a double-barreled gun turret capable of 360 degree rotation and 80 degree elevation or declination. This gun is primarily used to attack targets to the rear or sides. Typically fired by the gunner.

Mega-Damage: 4D6 per single shot or 8D6 per simultaneous dual blast at the same target.

Rate of Fire: Equal to the combined hand to hand attacks of the pilot or gunner.

Maximum Effective Range: 1000 feet (305 m)

Payload: Effectively unlimited.

**3. MML24 Mini-Missile System (2):** This is the main anti-armor weapon for the Tarantula. The rear abdomen houses two 12 pack mini-missile launchers that fire from the sides (near the top) of the vehicle. These weapons are concealed unless activated to fire.

Primary Purpose: Anti-Armor

Secondary Purpose: Defense

Mega-Damage: As per mini-missile. The typical missile load is a mix of 12 plasma/napalm (1D6×10 M.D.) and 12 armor piercing (1D4×10 M.D.), but any type of mini-missile can be used.

Maximum Effective Range: About one mile (1.6 km).

Payload: 24 mini-missiles; 12 per launcher.

Rate of Fire: Volley of 2, 4, or 8 missiles.

**4. Hand-Held Weapons:** Not applicable.

**5. Hand to Hand Combat:** The Tarantula was not designed for hand to hand combat but can use its front legs to punch, swat, poke and stomp opponents. A punch or jab does 2D4 M.D., a swat 1D4 M.D., butt with head or body 1D6 M.D., while a stomp does 2D6 M.D.

**6. Sensor Systems of Note:** The Tarantula has all of the standard sensors and options common to most robot vehicles, with the addition of its silent movement (equal to a prowl of 60%) and stealth coating and IR dampening gear. With its low profile and stealth system the Tarantula is not likely to register on radar or be detected by heat sensors. Its sand color or prairie camouflage coloring also makes it difficult to spot visually

and from the air, especially when motionless with legs tucked close to the body, or when slowly (10% normal speed) prowling.

## Robot Horses

Bandito Arms, Northern Gun and other manufacturers produce a wide variety of robots that fulfill many rolls. While most are used for riding or labor (pulling wagons, carts, carrying heavy loads, etc.), some are also equipped with light weapon systems, usually built into the head or shoulders. *Robot animals* such as horses and dogs are hugely popular in the New West, although not affordable by the average person. All robot horses can be covered in a realistic looking hide to make them look like a normal horse, but 40% of all purchases are without this cosmetic feature.

The RH 1000 series of robot horses from Bandito Arms (Northern Gun offers identical horses for 10% more) was developed with the adventurer, gunslinger and lawman in mind. Not only are the robot horses stronger and faster than their living counterparts but they can be programmed to be much more intelligent. The average robot horse can follow complex commands, recognize its owner and up to 96 of its owner's friends, associates and enemies, is programmed to warn the rider about the approach of enemies, as well as identify and wing snakes, lions, alien predators, and others, without being afraid itself. The robot horse responds completely to the physical and voice commands of the rider (can be programmed to respond to and obey 6 others of the owner's choice). This means the robot will not allow unauthorized people to ride or command it. Most robot horses are programmed to act like the genuine animal (without the fear response), but for an extra 100,000 credits it can be given voice recognition and response (talks) capabilities!

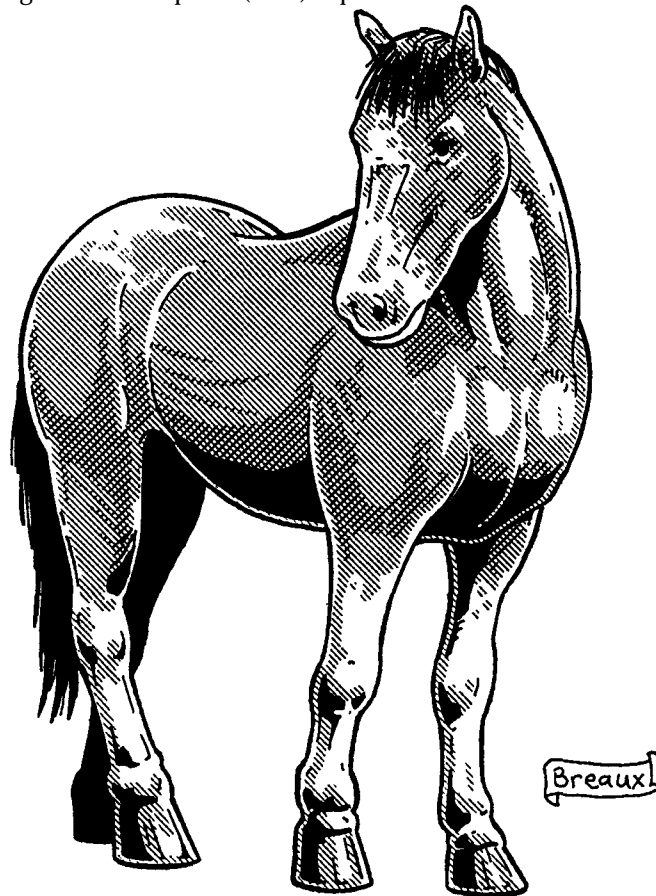

Robot horses are a favorite of Cyber-Knights, Gunslingers, and heavy or oversized D-bees and cyborgs because of the robots can carry much more weight without fatigue or developing back problems.

## Special Robot Features

Items listed below are "extras" that can be purchased for one's robot horse. All prices listed are for the "basic," robot-looking horse.

Extra armor: Add 30% to all M.D.C. for the deluxe, armored model, but also add 30% to the cost.

Life-like fur covering with padding and fake musculature, tail, mane and hoof coverings: 14,000 credits.

Voice recognition and response (talks): 100,000 credits.

Secret compartments can be built into the upper legs and body of the robot. The largest possible is approximately 12 inches (0.3 m) long and six inches (0.15 m) deep. As many as eight large compartments can be installed. Small compartments are half the size of a cigar box or roughly the size of a videocassette box. Two small compartments can be installed in place of a large one. Cost: 1200 for each small one, 4000 for each large. Locks cost an additional 200 credits for each. Not applicable for bots with fur. Excellent for holding small valuables, pistols, grenades, flares, an extra canteen, and so on.

**Weapon Options**: Weapon extras are *rarely* part of the basic package and always cost extra. Full price applies even during sales. All weapons tend to be small and unobtrusive to avoid obstructing the rider (or looking too obvious).

Chemical Spray: Built into the mouth. Basically the same as the cyborg unit, only with double the payload. Cost: 45,000 credits plus cost of the chemicals.

Concealed Weapon Rod (shoulder): Concealed in the robot's shoulder. Damage and ranger are the same as the light laser or ion blaster, depending on which is selected.

Ion Blaster (head): 3D6 M.D. or 6D6 from a dual system. Range is 800 feet (243.8 m), payload is effectively unlimited. Cost: 32,000 credits each. Typically built into the eyes (reduce range by 20%) or along the muzzle. As many as two, one on each side of the muzzle, can be installed.

Light Laser (head): 1D6 M.D. or 2D6 from a dual system. Range is 1200 feet (366 m); payload is effectively unlimited. Cost: 15,000 credits each. Typically built into the eyes (reduce range by 20%) or along the muzzle. As many as two, one on each side of the muzzle (or in each eye socket), can be installed.

Heavy laser (head): 2D6 M.D. or 4D6 from a dual system. Range is 2000 feet (610 m), payload is effectively unlimited. Cost: 30,000 credits each. Typically built into the eyes (reduce range by 20%) or along the muzzle. As many as two, one on each side of the muzzle, can be installed.

Double-Barrel Heavy Laser (Shoulder): 2D6 M.D. per single shot or 4D6 damage per simultaneous double shot. Range is 2000 feet (610 m), payload is effectively unlimited. Cost: 60,000 credits. A double-barrel unit that can be built into each shoulder. They are low profile and can be fixed forward or have an arc of fire of 30 degrees in all directions.

Light Machinegun (head or shoulders): 1D4 M.D. per burst of 50 rounds, range: 2000 feet (610 m), payload is 600 rounds (12 bursts). Cost: 10,000 credits. Typically built into the eyes (re-

duce range by 20%) or along the muzzle. As many as two, one on each side of the muzzle, can be installed. The feed runs up through the neck.

Mini-Missile Launchers (shoulders): As many as two small, dual system launchers can be added; one on each side. The small launchers fire two mini-missiles each; payload is two each with manual reloading (not possible while moving). Cost: 60,000 credits.

## Appaloosa or Pony

The Appaloosa is a light robot horse that is smaller than the other robots (although true Appaloosas are 14-15.2 hands tall). They are tough and reliable, with good speed and carrying capacity. The Appaloosa is designed for female riders, children and small D-bees.

### Bandito Arms Appaloosa, Light Robot Horse

**Model Type**: RH-1001A

**Class**: Robot Horse

**Crew**: One humanoid rider with one additional rider possible in emergencies.

#### M.D.C. by Location

Head — 80

Legs (4) — 80 each

\*Main Body — 200

\* Destruction of the main body will destroy the bot. Destruction of the head shuts it down. Destroying one leg will hobble the robot and reduce speed and leaping distance and height by 33%.

#### Speed

Running: Maximum speed of 75 mph (120 km).

Leaping: 10 feet (3 m) high and 20 feet (9 m) lengthwise, with a running start.

Flying: Not applicable.

Underwater Capabilities: The robot can function in/under water, able to walk along the bottom of the sea at about 25% its normal running speed, or swim at a speed of 3 mph (4.8 km or 2.6 knots). Maximum Depth is 500 feet (152.4 m).

#### Statistical Data

Height: Usually about 13.2 hands (or 4 feet, 4 inches/1.34 m) at the shoulders.

Width: 2.6 feet (0.8 m)

Length: Approximately 6.6 feet (roughly 2 m).

Weight: 800 lbs. (360 kg)

Color of Hide: Leopard (white over the loins and hips with dark, oval shaped spots), Snowflake (spotted all over the body), Marble (mottled colors all over body), and Frosted (white specks with a dark grey or brown background). Generally, colors include grey, white and a variety of browns.

Attributes of Note: Robot P.S. 26, P.P. 20, P.B. 10 (15 with hide), Spd 110; equivalent I.Q. 9.

Power System: Nuclear, average life of 15 years.

Cargo: Can carry one rider and one companion (if both are roughly human-size, otherwise space may be tight for the companion rider, and this second seat is never comfortable for long periods; an hour or more), up to 1000 pounds (450 kg). The robot horse can *pull* up to two tons!

Cost: 2.5 million; sometimes on sale for 10-20% less.

**Weapon Systems**: None to start.

**Combat Notes:**

Attacks per Melee Round: Three

Bonuses: +2 on initiative, +1 to strike, +3 to dodge when running, and +2 to roll with punch, fall or impact.

Damage:

Restrained Hoof Strike: 2D4x10 S.D.C.

Full Hoof Strike: 1D6 M.D.

Rear Kick/Power Kick: 2D6 M.D.

Stomp: 1D4 M.D.

Running Body Block: 1D4M.D.

Head Butt: 5D6 S.D.C.

Bite: 5D6 S.D.C.

**Crew:** One humanoid rider with one additional rider possible in emergencies.

**M.D.C. by Location**

Head — 100

Legs (4) — 100 each

\*Main Body — 250

\* Destruction of the main body will destroy the bot. Destruction of the head shuts it down. Destroying one leg will hobble the robot and reduce speed and leaping distance and height by 33%.

**Speed**

Running: Maximum speed of 100 mph (160 km).

Leaping: 15 feet (4.6 m) high and 40 feet (12.2 m) lengthwise, with a running start.

Flying: Not applicable.

## The Mustang or Pinto

The Mustang is a robot horse with the same basic shape and size of the wild Mustang. They are tough and reliable, with good speed and cargo capacity. The only difference between the Mustang and the Pinto is the color of its fake hide.

**Bandito Arms Medium Robot Horse**

**Model Type:** RH-1002B

**Class:** Robot Horse

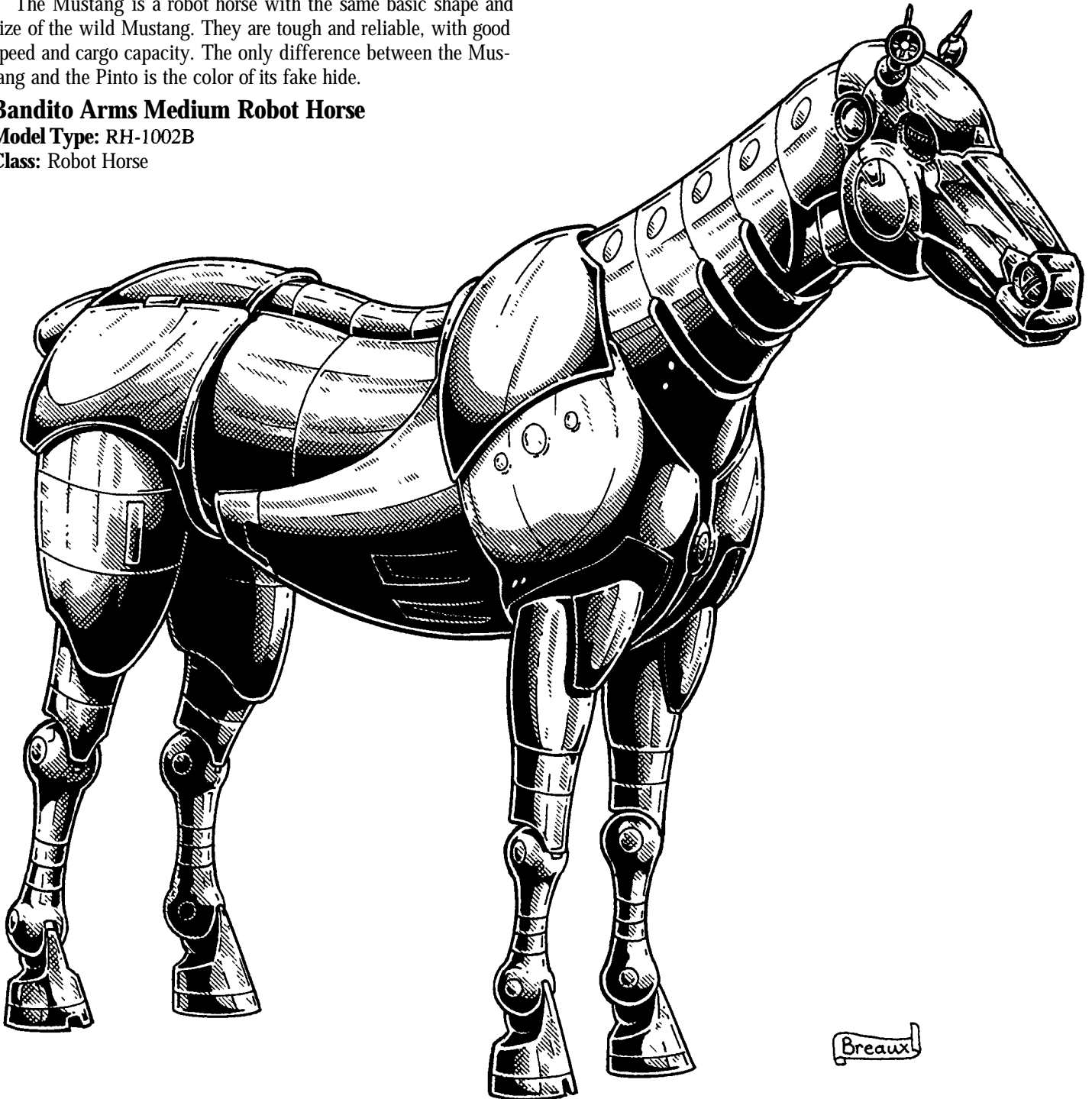

Breaux

**Underwater Capabilities:** The robot can function **in/under**water, able to walk along the bottom of the sea at about 25% its normal running speed, or swim at a speed of 3 **mph** (4.8 km or 2.6 knots). Maximum Depth is 500 feet (152.4 m).

#### **Statistical Data**

**Height:** Usually about 15 hands (or 5 feet/1.5 m) at the shoulders.

**Width:** 3 feet (0.9 m)

**Length:** Approximately 8 feet (2.4 m).

**Weight:** 1200lbs. (540 kg)

**Color of Hide:** Mustang: various shades of brown and grey; solid color with highlights on lower legs. Pinto: Also known as the Paint Horse or Calico, it is distinguished by its "blotches" of color, typically **Ovaro** (one basic, solid color brown or grey with large splashes of white) or **Tobiano** (white overall color with small splashes or blotches of brown or grey).

**Attributes of Note:** Robot P.S. 28, P.P. 20, P.B. 9 (14 with hide), Spd 148; equivalent I.Q. 9.

**Power System:** Nuclear, average life of 15 years.

**Cargo:** Can carry one rider and one companion (if both are roughly human-size, otherwise space may be tight for the companion rider, and this second seat is never comfortable for long periods; an hour or more), up to 1400 pounds (630 kg). The robot horse can *pull* up to five tons!

**Cost:** 5.2 million; sometimes on sale for 10-20% less.

**Weapon Systems:** None to start.

#### **Combat Notes:**

**Attacks per Melee Round:** Three

**Bonuses:** +2 on initiative, +2 to strike, +4 to dodge when running, and +2 to roll with punch, fall or impact.

#### **Damage:**

**Restrained Hoof Strike:** 1D4 M.D.

**Full Hoof Strike:** 1D6 M.D.

**Rear Kick/Power Kick:** 2D6 M.D.

**Stomp:** 1D4 M.D.

**Running Body Block:** 1D4 M.D.

**Head Butt:** 1D4×10 S.D.C.

**Bite:** 6D6 S.D.C.

## The Arabian

The Arabian robot horse is as beautiful as the real breed, tall, sleek, and graceful, with long, thin (but powerful) legs. This robot has been treated with synthetic skin and musculature which gives it the look of a jet black real horse. The Arabians also have an upgraded skill program and are slightly more intelligent than the Calico. The Arabians claim to fame is its ability to jump. It comes standard with jets to assist in leaps.

### **Bandito Arms Arabian Robot Horse**

**Model Type:** RH-1003C

**Class:** Robot Horse

**Crew:** One humanoid rider with one additional rider possible in emergencies.

#### **M.D.C. by Location**

Head — 100

Legs (4) — 90 each

\*Main Body — 240

\* Destruction of the main body will destroy the bot. Destruction of the head shuts it down. Destroying one leg will hobble

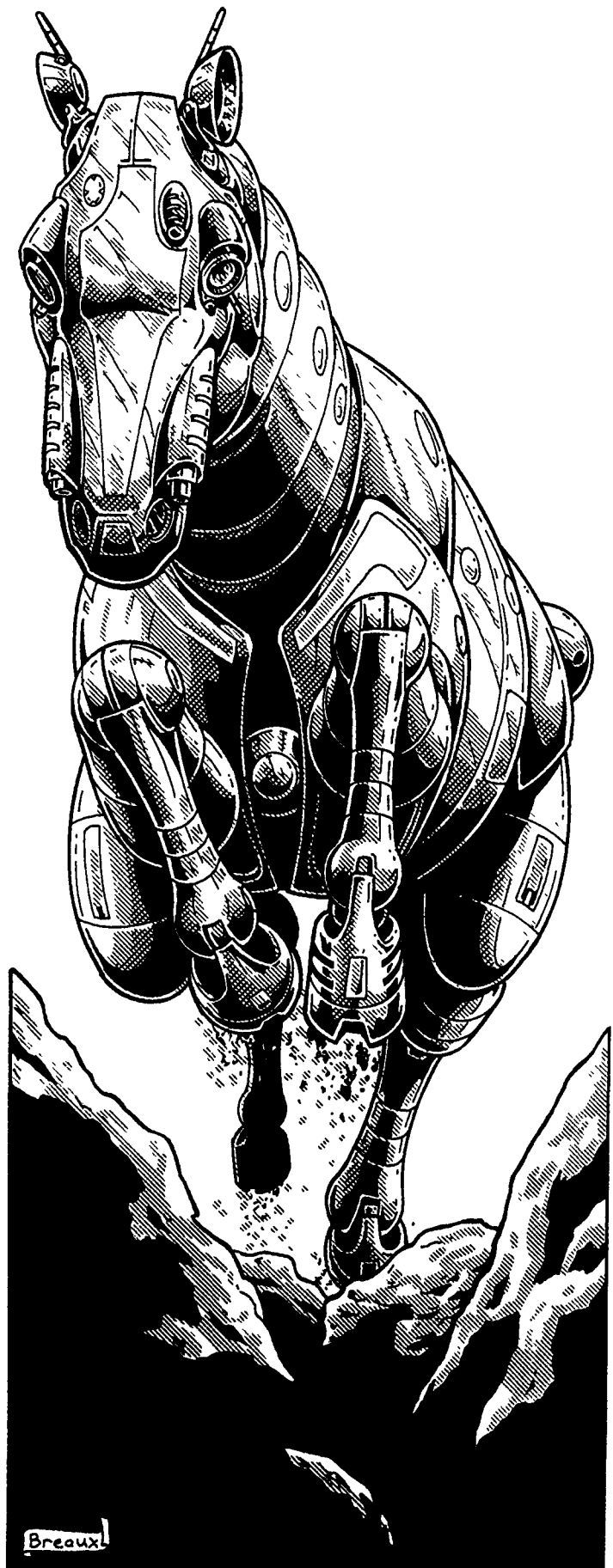

the robot and reduce speed and leaping distance and height by 33%.

### **Speed**

Running: Maximum speed of 120 mph (192 km).

Leaping: 20 feet (9 m) high and 50 feet (15.2 m) lengthwise, with a running start.

Flying: Not applicable.

Underwater Capabilities: The robot can function in/under water, able to walk along the bottom of the sea at about 25% its normal running speed, or swim at a speed of 3 mph (4.8 km or 2.6 knots). Maximum Depth is 500 feet (152.4 m).

### **Statistical Data**

Height: Usually about 15 hands (or 5 feet/1.5 m) at the shoulders.

Width: 3 feet (0.9 m).

Length: Approximately 9 feet (2.7 m).

Weight: 1400 lbs. (630 kg)

Color of Hide: A solid body color, often with "stockings," a different color, on the lower legs, and a color marking (usually white) on the top of the muzzle.

Attributes of Note: Robot P.S. 28, P.P. 22, P.B. 11 (17 with hide), Spd 180; equivalent I.Q. 9.

Power System: Nuclear, average life of 15 years.

Cargo: Can carry one rider and one companion (if both are roughly human-size, otherwise space may be tight for the companion rider, and this second seat is never comfortable for long periods; an hour or more), up to 1200 pounds (540 kg). The robot horse can *pull*/up to four tons!

Cost: 6 million; sometimes on sale for 10-20% less.

Weapon Systems: None to start.

### **Combat Notes:**

Attacks per Melee Round: Three

Bonuses: +3 on initiative, +2 to strike, +5 to dodge when running, and +1 to roll with punch, fall or impact.

Damage:

Restrained Hoof Strike: 1D4 M.D.

Full Hoof Strike: 1D6 M.D.

Rear Kick/Power Kick: 2D6 M.D.

Stomp: 1D4 M.D.

Running Body Block: 1D4 M.D.

Head Butt: 6D6 S.D.C.

Bite: 6D6 S.D.C.

## **The War Horse**

The War Horse is a robot with a stocky build, thick legs, extra armor and a basic shape that the average, nonhorse person would consider a Clydesdale. It is designed for hard work and combat. It is especially popular among Cyber-Knights and the 1st Cavalry.

### **Bandito Arms Heavy Robot Horse**

**Model Type:** RH-1004D

**Class:** Robot Horse

**Crew:** One humanoid rider with one additional rider possible in emergencies.

### **M.D.C. by Location**

Head — 150

Legs (4) — 150 each

\*Main Body — 350

\* Destruction of the main body will destroy the bot. Destruction of the head shuts it down. Destroying one leg will hobble the robot and reduce speed and leaping distance and height by 33%.

### **Speed**

Running: Maximum speed of 75 mph (120 km).

Leaping: 15 feet (4.6 m) high and 40 feet (12.2 m) lengthwise, with a running start.

Flying: Not applicable.

Underwater Capabilities: The robot can function in/under water, able to walk along the bottom of the sea at about 25% its normal running speed, or swim at a speed of 3 mph (4.8 km or 2.6 knots). Maximum Depth is 500 feet (152.4 m).

### **Statistical Data**

Height: Usually about 16 hands (or 5.4 feet/1.58m) at the shoulders.

Width: 3.8 feet (1.1 m)

Length: Approximately 10 feet (3 m).

Weight: 2000 lbs. (900 kg)

Color of Hide: Various shades of brown, grey and white; may be speckled.

Attributes of Note: Robot P.S. 38, P.P. 20, P.B. 9 (14 with hide), Spd 110; equivalent I.Q. 9.

Power System: Nuclear, average life of 15 years.

Cargo: Can carry one rider and one companion (if both are roughly human-size, otherwise space may be tight for the companion rider, and this second seat is never comfortable for long periods; an hour or more), up to 2000 pounds (900 kg). The robot horse can *pull*/up to eight tons!

Cost: 6.1 million; sometimes on sale for 10-20% less.

Weapon Systems: None to start.

### **Combat Notes:**

Attacks per Melee Round: Four

Bonuses: +2 on initiative, +1 to strike, +3 to dodge when running, and +2 to roll with punch, fall or impact.

Damage:

Restrained Hoof Strike: 1D4 M.D.

Full Hoof Strike: 2D6 M.D.

Rear Kick/Power Kick: 4D6 M.D.

Stomp: 1D6 M.D.

Running Body Block: 1D6 M.D.

Head Butt: 1D4×10 S.D.C.

Bite: 1D4×10 S.D.C.

## **Bandit K-9 Companion**

A robot dog designed to be both a companion and helper. Most are programmed to behave like a real dog; bark, growl or snarl when the bot detects danger, and bark or howl in warning. Unlike the robot horse, the artificial dog typically comes with a life-like covering of fur, padding and musculature. The companion can perform a variety of combat and noncombat duties, ranging from hunting/tracking, fetching, herding animals (a big attraction in the west), guarding/warning and attack. Fairly intelligent, it can follow relatively complex orders and recognizes its owner and up to 64 of its owner's friends, associates and enemies. The K-9 Companion is also programmed to warn about the approach of enemies, as well as identify and warn its master about the presence of 300 hostile life forms, including snakes, scorpions, lions, alien predators, and others, without being afraid



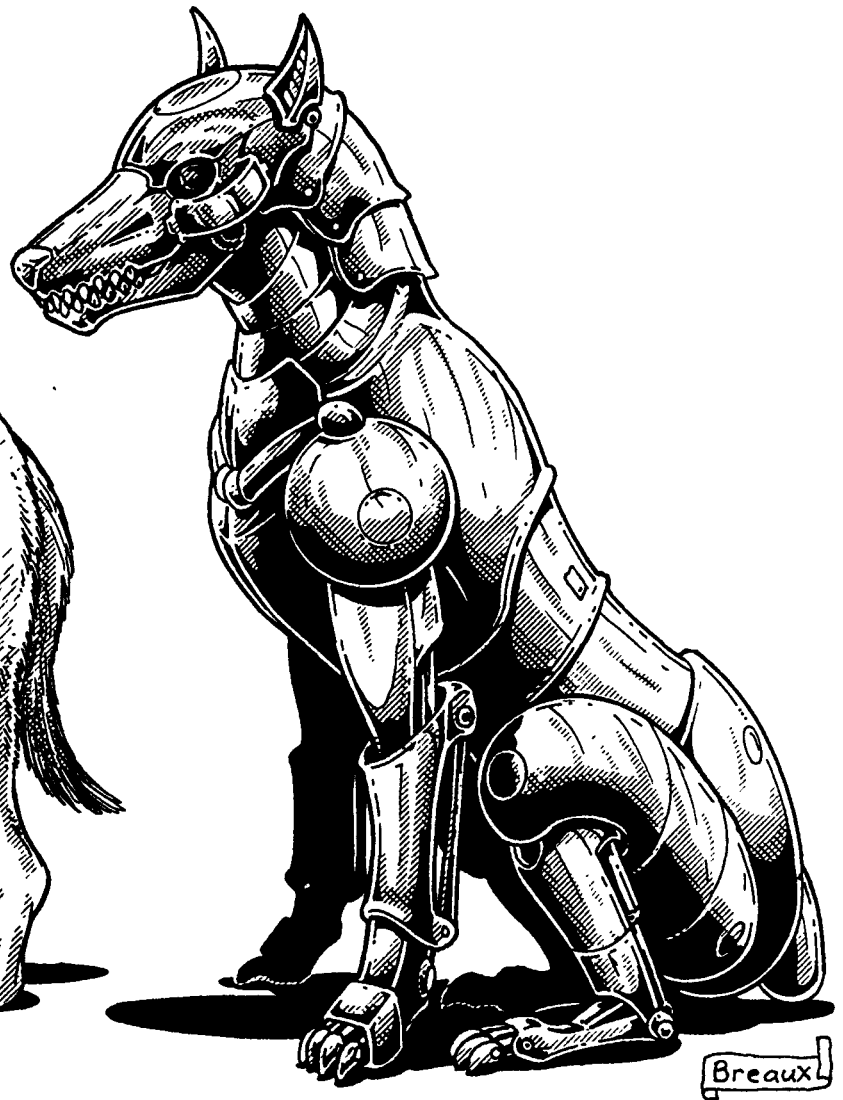

itself. The robot dog responds completely to the hand signs (pointing, waving, finger snapping, etc.) and voice commands of its owner and can be programmed to respond to and *obey* six other people of the owner's choice (if so desired). This means the robot will not allow unauthorized people to command it and will bark or growl a warning to all intruders. For an extra 100,000 credits, it can be given voice recognition and response (talks) capabilities!

The companion can be made to look like any type of medium to large dog, but the standard styles are German Shepherd and Retriever. Companions can be found all over the New West; for some reason they are not as popular in the East and most "civilized" areas.

**K-9 Special Features:** Extra armor: Add 30% to all M.D.C. for the deluxe, armored model, but also add 30% to the cost.

Voice recognition and response (talks): 100,000 credits.

Two small secret compartments can be built into the robot dog. Small compartments are half the size of a cigar box or roughly the size of a videocassette box. Cost: 1200 for each. Excellent for holding small valuables, pistols, grenades, flares, an extra canteen, and so on.

**K-9 Weapon Options:** Weapon extras are *rarely* part of the basic package and always cost extra. Full price applies even during sales. All weapons tend to be small and unobtrusive to avoid looking too obvious.

**Chemical Spray:** Built into the mouth. Basically the same as the cyborg unit, only with double the payload. Cost: 45,000 credits plus cost of the chemicals.

**Ion Blaster (head):** 2D6 M.D. or 4D6 from a dual system. Range is 600 feet (183 m), payload is effectively unlimited. Cost: 32,000 credits each. Typically built into the eyes or along the muzzle. As many as two, one on each side of the muzzle or in the eyes, can be installed.

**Light Laser (head):** 1D6 M.D. or 2D6 from a dual system. Range is 1200 feet (366 m); payload is effectively unlimited. Cost: 15,000 credits each. Typically built into the eyes (reduce range by 20%) or along the muzzle. As many as two, one on each side of the muzzle (or in each eye socket), can be installed.

**Model Type:** K-9R-1100

**Class:** Robot Dog

**Crew:** None

**M.D.C. by Location**

Head — 50

Legs (4) — 50 each

\*Main Body — 120

\* Destruction of the main body will destroy the bot. Destruction of the head shuts it down. Destroying one leg will hobble the robot and reduce speed and leaping distance and height by 33%.

## Speed

**Running:** Maximum speed of 40 mph (64 km).

**Leaping:** 12 (3.6 m) high and 25 feet (7.6 m) lengthwise, with a running start.

**Flying:** Not applicable.

**Underwater Capabilities:** The robot can function in/under water, able to walk along the bottom of the sea at about 25% its normal running speed, or swim at a speed of 3 mph (4.8 km or 2.6 knots). Maximum Depth is 500 feet (152.4 m).

## Statistical Data

**Height:** Usually about 3 feet (0.9 m) at the top of the head.

**Width:** 1.6 feet (0.5 m)

**Length:** Approximately 3-4 feet (0.9 to 1.2m).

**Weight:** 300 lbs. (135 kg)

**Color:** Varies with the breed.

**Attributes of Note:** Robot P.S. 22, P.P. 20, P.B. 10 (15 with hide), Spd 59; equivalent I.Q. 9.

**Power System:** Nuclear, average life of 15 years.

**Cargo:** Can carry up to 500 pounds (225 kg) and can pull up to 1000 pounds (450 kg).

**Cost:** 2.5 million; sometimes on sale for 10-20% less.

**Special Sensors:** Keen polarized color vision, passive night sight (1600 ft/488 m range), plus amplified hearing, ultra ear, and molecular analyzer in nose, all basically the same as the bionic counterparts.

**K-9 Companion Skill Program:** Land navigation, track animals, herd cattle, and swim, all at 90%; plus track humanoids 75%, climb 70%/0%, and prowl 70%.

**Weapon Systems:** None to start.

## Combat Notes:

**Attacks per Melee Round:** Three

**Bonuses:** +2 on initiative, +3 to strike, +1 to parry, +3 to dodge when running, and +2 to roll with punch, fall or impact.

**Damage:**

Restrained Bite Strike: 6D6 S.D.C.

Full Strength Bite: 2D4 M.D.

Power Bite: 3D6 M.D. but counts as two melee attacks.

Claw Strike: 1D4 M.D.

Running Body Block/Leaping Tackle: 1D4 M.D.

Head Butt: 2D6 S.D.C.

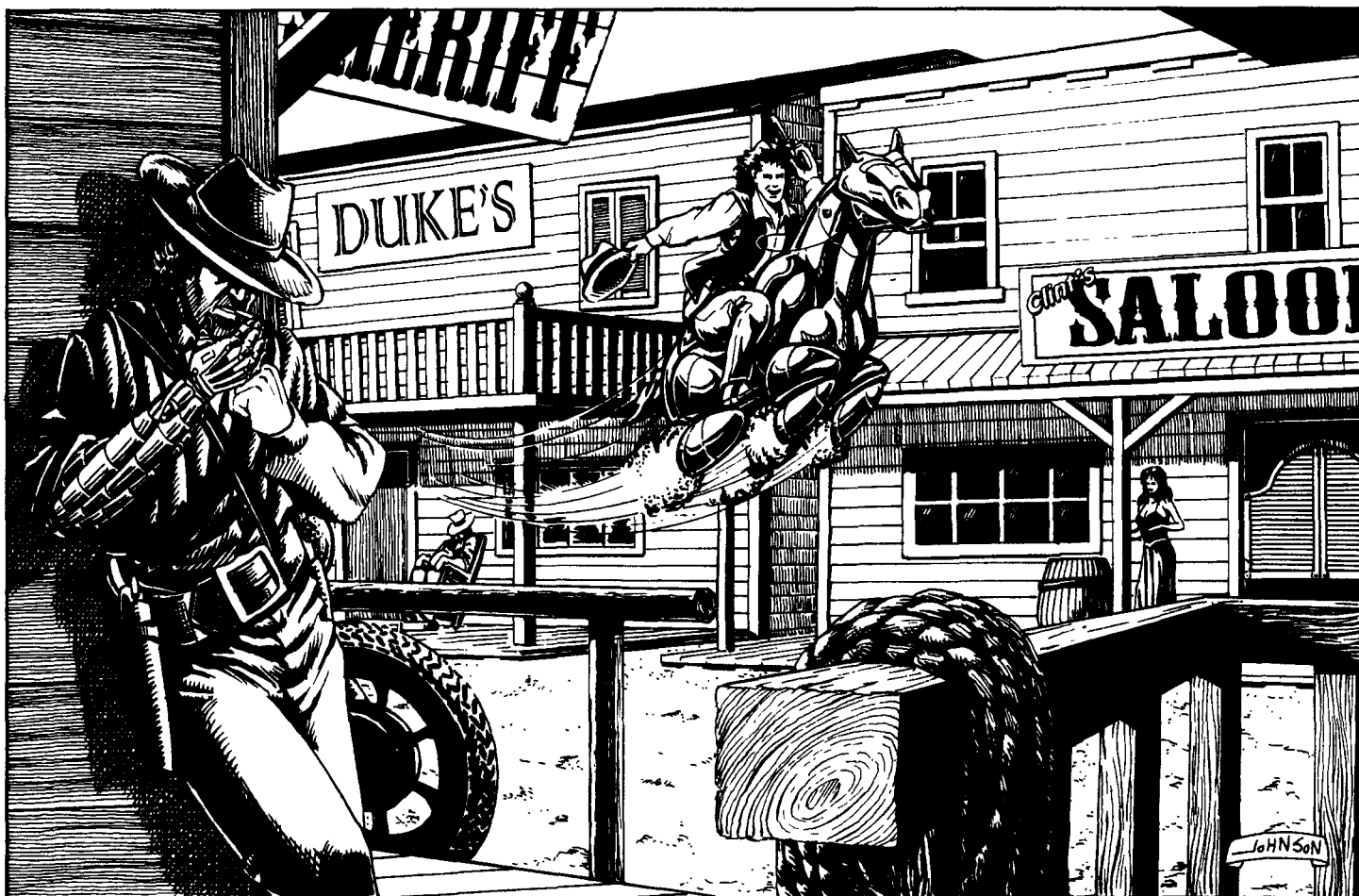

## Bronco Scooter

One of the stranger (and surprisingly popular) vehicles to come from any manufacturer is Bandito Arms' horse shaped hovercycle — also known as the "Hobby Horse" by those who find it silly or unbecoming a real cowboy. Despite this, the Bronco Scooter is incredibly popular, especially among Greenhorns, City Slickers and would-be cowboys. Its popularity is due, in part, to its low cost.

**Vehicle Type:** Hovercycle

**Crew:** One rider; no room for a passenger.

**Special Bonuses:** +1 to dodge.

**Maximum Speed:** 190 mph (304 km)

**Maximum Altitude:** 60 feet (18.3 m) and handle drops of up to 400 feet (122 m).

**Maximum Range:** 800 miles (1280 km)

**Engine:** Combustion or electric engine.

Length: 6 feet (1.8 m)

**Weight:** 350 lbs (157.5 kg)

**M.D.C. by Location:**

- \* Lower "Hoof Jets (4) — 40
- \* Forward Directional Jets (4; concealed) — 4 each
- \* Forward Headlights (2; eyes) — 2 each

Main Body — 110

Add 30% to all M.D.C. for the deluxe, armored model, but also add 30% to the cost.

A single asterisk indicates small and/or difficult targets to hit and requires the attacker to make a "called shot," but even then the attacker is -4 to strike. The driver, hunched down, low to the body of the hovercycle, is equally difficult to hit.

**Cost:** 146,000 credits for gasoline combustion engine or 162,000 for electric. Nuclear not available.

**Weapons:** Any standard hovercycle weapons can be added; lasers are usually built into the mouth or under the eyes/headlights.

## Cavalry War Wagon

The Cavalry War Wagon is supposed to be the answer to an armored assault vehicle. The basic body design and propulsion system is a knock-off of the Coalition "Scarab" Officer's Car, not that one would recognize it as such. The front "Death's Head" design has been replaced with a large ram prow like the "cow catchers" on old style trains and the vehicle is more heavily armored. A pair of headlights are mounted on the roof. The top/roof is flat, with a rail gun mounted on it (operated by the co-pilot or a passenger). The rail gun can turn 360 degrees and has a 45 degree arc of fire. The concealed mini-missile launchers have been kept, along with the forward laser ball turrets, but the rear laser turrets have been replaced with additional jets.

Typically the War Wagon is used as a town, fort or outpost defender but it is not uncommon to see one or two traveling with a 1st Cavalry column. This combination of firepower and armor makes the War Wagon an excellent, light combat hover vehicle. It is popular among the 1st Cavalry Justice Rangers, wealthy Ranchers and Towns as a means of defense, but is also used by some mercenary companies and bandit gangs, especially large gangs and those who hold-up trains.

**Model Type:** BAWW-120

**Class:** Military Transport

**Crew:** Two, a pilot and gunner. Can accommodate four passengers comfortably; a fifth can be squeezed in, but makes for cramped, uncomfortable conditions.

**M.D.C. by Location:**

- \* Light Rail Gun (1; roof top) — 70
- \* Laser Turrets (2; bottom) — 50 each
- \* Mini-Missile Launchers (2) — 50 each
- Front Windshield (1) — 40
- Rear Windshield (1) — 40
- Side Windows (4) — 20 each
- Doors (4) — 70 each
- Headlights (2) — 15 each
- \* Bottom Hover Jets (5) — 50 each
- Rear Ball Jets (2; in place of rear ball lasers) — 50 each
- Rear Jets (3) — 50 each
- Ram Prow (1; large) — 130
- \*\* Main Body — 290

\* Every item marked by a single asterisk is small and/or difficult to strike. An attacker must make a "called shot" to hit and even then he is -3 to strike.

Destroying one of the bottom hover jets reduces speed by 10%. Destroying one of the rear jets reduces speed by 20%.

\*\* Depleting the M.D.C. of the main body completely destroys the vehicle.

**Speed**

Flying: 200 mph (321.8 km), but cruising speed is considered to range between 80 and 150 mph (128 and 240 km). VTOL capable, can hover stationary; retractable landing gear. Maximum altitude is limited to about 2000 feet (610 m).

Water: The War Wagon can also skim across the surface of water at a speed of 110 mph (160 km/93.5 knots). It is submersible, with an underwater speed of 50 mph (80.4 km/42.5 knots), but a maximum ocean depth of only 300 feet (91.5 m).

Flying Range: The nuclear power give the vehicle decades of life. The War Wagon can be flown continuously for 48 hours without fear of overheating.

**Statistical Data**

Height: 7 feet (2.1 m) not including the rail gun which adds another two feet (0.6 m) for an overall height of 9 feet (2.7 m).

Width: 5 feet, 6 inches (1.7 m)

Length: 23 feet (7 m) including the heavy ram prow.

Weight: 3.1 tons.

Cargo: Minimal storage space, about three feet (0.9 m) behind seats for extra clothing, weapons, and personal items.

Power System: Nuclear, average cycle's energy life is 20 years.

CS Cost: 2.3 million credits; fair availability.

Note: The Black Market and Northern Gun sell knock-offs of the "Scarab" Officer's Car, complete with weapon systems for 2.1 million credits; 1.3 million for a rebuilt; fair availability. See *Rifts® World Book 11: Coalition War Campaign* for other knock-offs.

### Weapon Systems

1. **C-40BT Laser Turrets (2):** Two double barrel lasers built into ball turret are located in the front corners of the car where the wheel would be on a normal car. Each is capable of 180 degree rotation and arc of fire.

Primary Purpose: Anti-personnel

Secondary Purpose: Defense

Mega-Damage: 4D6 per double blast from one turret, or 8D6 M.D. per simultaneous dual blasts from two turrets. All four turrets cannot fire in tandem.

Range: 2000 feet (610 m)

Rate of Fire: Equal to the number of hand to hand attacks per melee round of the pilot or gunner (usually 4 to 6).

Payload: Effectively unlimited.

2. **CR-10 Concealed Mini-Missile Launcher (2):** A pair of mini-missile launchers are mounted on the sides of the vehicle. Each contains a total of ten mini-missiles.

Primary Purpose: Anti-Personnel

Secondary Purpose: Anti-Armor

Missile Type: Any type of mini-missile can be used, but standard issue is fragmentation (anti-personnel, 5D6 M.D.) and plasma (1D6×10).

Mega-Damage: Varies with missile type.

Range: About one mile,

Rate of Fire: One at a time or in volleys of two, three, four, or five.

Payload: Twenty, ten missiles in each launcher.

**3. Light Rail Gun:** Located on the roof of the vehicle; 360 degree rotation, 45 degree arc of fire.

Primary Purpose: Anti-Personnel

Secondary Purpose: Defense

Weight: 90 lbs (40.8 kg; ammo compartment inside vehicle.

Mega-Damage: A Burst is 30 rounds and inflicts 6D6 M.D.; one round does 1D4 M.D.

Rate of Fire: Equal to number of combined hand to hand attacks (usually 4-6).

Maximum Effective Range: 4000 feet (1220 m).

Payload: 2400 rounds, that's 80 bursts.

**4. Sensors:** Long and short range radio, infrared optics, and short range radar.

---

# Wilk's Laser Technologies

By Kevin Siembieda with ideas  
and additional text by Chris Kornmann

---

Wilk's Laser Technologies was born early during the Golden Age of Science, before the Great Cataclysm. With advances in laser technology making leaps and bounds, the time was right for a young entrepreneur by the name of *John Harrington Wilk* to start a fledgling company specializing in laser technologies. His company grew slowly at first, catering to the needs of the various civilian users of the laser, primarily in the medical community. Wilk's laser scalpel was revolutionary and sent company stock soaring. Gradually, Wilk's expanded into the areas of precise laser distancing mechanisms for geographic surveying and construction, security systems and even acquired a small contract with the ancient American Empire's Armed Forces to build a small number of advanced laser guidance systems. Wilk's Laser Technologies would quickly become a leader in civilian laser manufacturing and number two in the military application of lasers. Within 10 years the company was worth trillions and John Harrington Wilk was heralded as a genius billionaire.

When the ley lines erupted and the Cataclysm came, the Wilk's South Dakota factory complex, near **Ellsworth** Air Force Base, was spared total destruction. As fate would have it, Wallace John Wilk, a rogue scientist and an actual descendant of John Harrington Wilk, discovered the old factory while he and a team of other scientists and scholars were scavenging for ancient relics from Earth's past at old military bases. It took 15 years and a financing deal with the fledgling kingdom of Tolkeen, but by 36 P.A., Wallace Wilk and his associates had the factory up and running. By 59 P.A. Wilk's Laser Industries (its exact location successfully kept secret until 84 P.A.) had become a major manufacture and arms dealer in North America. It was able to keep a low profile and its location secret for years because Wilk's wholesaled its products to arms dealers including the Black Market/Bandito Arms and Northern Gun.

Around 79 P.A., Wilk's began to actively sell weapons directly to the consumer and opened several gun shops in the West and some of the Eastern 'Burbs. Northern Gun immediately reduced its purchases of Wilk's weapons by 80% and other laser items by 20% (it has also turned to creating cheap copies of Wilk's-Remi laser weapons, but hasn't dared to knock-off the

distinctive styling of modern Wilk's laser pistols and rifles). Wilk's move into the direct market has not affected its relationship with the Black Market/Bandito Arms in the least. Furthermore, Northern Gun and the Manistique Imperium's recent alliance with the Coalition States has increased sales for Wilk's and Bandito Arms products in Minnesota and with numerous other independent kingdoms and cities who don't wish to support the Coalition States or its allies in any way. This has caused NG and MI to see sales to such clients drop 37%, although the increased business with the CS will guarantee record profits for both.

Initially, Wallace wisely focused on what the Wilk's company had always done best, lasers, and not just guns, but laser **distancers**, scalpels and medical equipment, optics, communications and other areas where WLT had always made tremendous profits. However, for the last 18 years, Wilk's Laser Technologies has focused on weapon systems and particularly on the burgeoning market in the New West. A move that has made Wilk's number one in the sales of energy handguns and laser rifles. The precision and superior range of Wilk's rifles make them ideal in the wilderness and Wilk's brilliant move to produce laser pistols styled after Old West Remingtons and Colts have made them the most popular weapons in the west, especially among lawmen, cowboys, **gunfighters** and 'Slingers. **Note:** Northern Gun has since followed their lead with several cheap knock-offs, although the range of NG energy six-shooters is typically 15% to 20% shorter, 10% heavier, the damage often 1D6 less, and only 10% cheaper.

## Wilk's Laser Weapons

### Wilk's 210 "Pocket Pistol"

A truly unique and revolutionary design for any of the weapon manufacturers, the 210 Pocket Pistol is inspired by the Derringer. Its small size (it can fit in the palm of the hand) meant that the weapon could not use the traditional E-Clip, so the Wilk's engineers designed a tiny gun with a permanent built-in energy cell. A special "plug in" hookup allows for the use of an

ordinary E-clip recharger to power up the empty weapon. The 210 has become popular among City Rats, saloon bums, barmaids, gamblers, spies, and thieves because it is easily palmed and concealed (in a garter belt, boot, hat, hand, etc.).



Weight: 8 ounces ( 0.26 kg)

Mega-Damage: 1D6 M.D.

Rate of Fire: Single shot, each shot counts as a melee action.

Effective Range: 400 feet (122 m)

Payload: 3 shots.

Cost: 8,000 credits.



## Wilk's 320 Laser Pistol

The 320 is the "classic" Wilk's laser pistol known for its durability, range, accuracy and light weight. It is a sleek black plastic and ceramic weapon popular among most mercenaries, adventurers. Headhunters and city rats are especially fond of the Wilk's series of laser weapons.

Weight: 2 lbs ( 0.9 kg)

Mega-Damage: 1D6 M.D.

Rate of Fire: Standard, aimed, burst, wild.

Effective Range: 1000 feet (305 m)

Payload: 20 shots with a standard short E-Clip, 40 shots with a long E-Clip.

Bonus to Strike: +2 bonus to strike on an aimed shot because of the light weight and superior balance.

Cost: 11,000 credits.

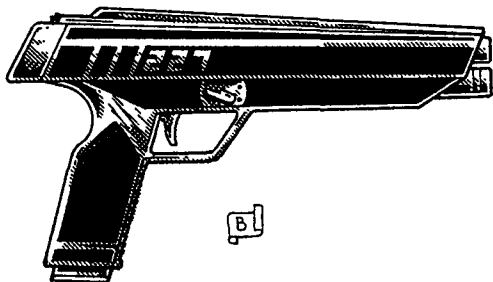

## Wilk's 227 Pulse Pistol

The 227 is a small, double-barreled pistol designed for maximum distance and firepower in a small laser handgun. This new weapon has become an instant favorite of mercenaries, soldiers, gunfighters, lawmen, 'Slingers and Juicers. **Note:** Only Wilk's has managed to build a pulse pistol. The 227 and other pulse or dual weapons have only been placed on the market in the last year to year and a half. The sacrifice of range for firepower is minimal.

Weight: 2.5 lbs (1.09 kg)

Mega-Damage: 2D6 M.D. per single blast, or 4D6 per double blast.

Rate of Fire: Standard

Effective Range: 900 feet (274.3 m)

Payload: 12 double pulse shots with a standard short E-Clip, 24 shots with a long E-Clip.

Bonus to Strike: +2 bonus to strike on an aimed shot because of the light weight and superior balance.

Cost: 18,000 credits.

## Wilk's 330 Sniper Laser Pistol

A heavier version of the 320 with a retractable folding stock for precision shooting. A favorite among bounty hunters, gun-slingers, gunfighters, assassins, Juicers and some lawmen.

Weight: 2.5 lbs (1.09 kg)

Mega-Damage: 2D6 M.D.

Rate of Fire: Standard

Effective Range: 1000 feet (305 m)

Payload: 12 shots with a standard short E-Clip, 24 shots with a long E-Clip.

Bonus to Strike: +3 bonus to strike on an aimed shot because of the light weight, superior balance and support from the shoulder stock.

Cost: 15,000 credits.

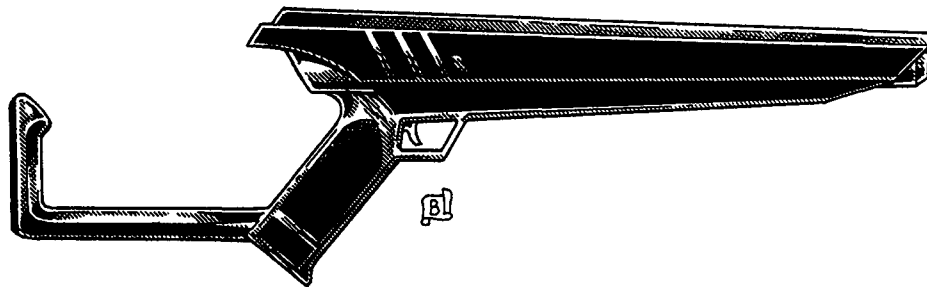

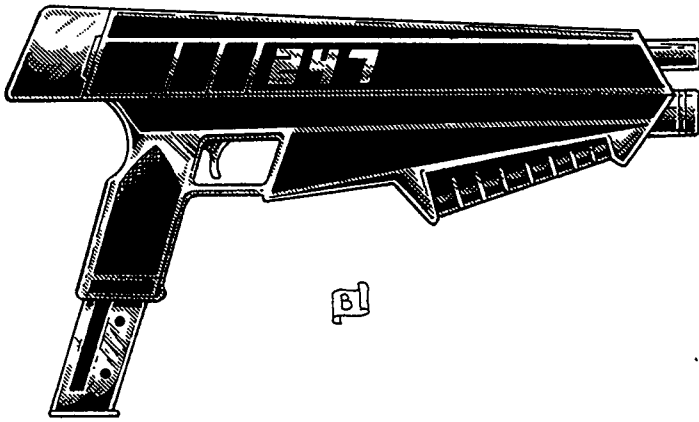

## Wilk's 247 "Hero" Dual Pistol

The Hero is a dual, over and under laser pistol designed on the principles of the old, automatic sub-machineguns. It is designed to pack as much firepower and versatility as possible into a relatively small package. The top barrel is a medium, long-range laser with its own standard E-Clip loaded in the back of the weapon. The lower barrel is a heavy short-range laser with a separate long E-Clip. **Note:** It has only been on the market for six months.

Weight: 5 lbs (2.3 kg)

Mega-Damage: Medium Laser: 2D6 M.D.; Heavy Laser 3D6 M.D.

Rate of Fire: Standard

Effective Range: Medium Laser: 1000 feet (305 m). Heavy Laser: 500 feet (152 m).

Payload: Light laser: 20 shots. Heavy laser: 32 shots with a long E-Clip — standard (16 with a short clip).

Bonus to Strike: +2 bonus to strike on an aimed shot when used with two hands; no bonus if fired with one hand or wild.

Cost: 25,000 credits.

## Wilk's 237 "Backup"

The 237 is Wilk's first heavy laser pistol sacrificing range for firepower. It has become an instant hit with bounty hunters, lawmen, gamblers, 'Slingsers, Juicers and bandits.

Weight: 3 lbs (1.4 kg)

Mega-Damage: 3D6 M.D. per single blast or 6D6 per double blast.

Rate of Fire: Standard

Effective Range: 500 feet (152 m)

Payload: 8 double pulse shots with a standard short E-Clip, 16 shots with a long E-Clip.

Bonus to Strike: +2 bonus to strike on an aimed shot because of the light weight and superior balance.

Cost: 24,000 credits.

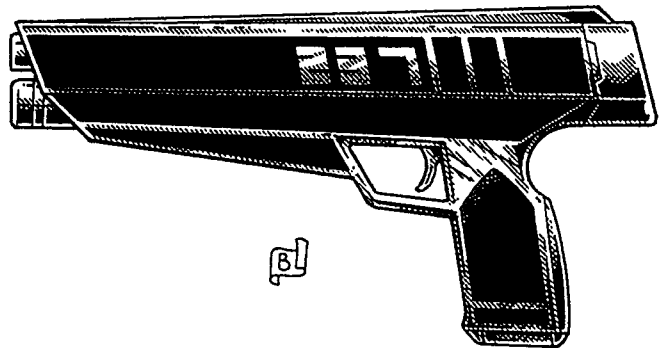

## Wilk's 447 Traditional Laser Rifle

The sleek, lightweight "classic" Wilk's laser rifle made from Wilk's famous black plastic and ceramic with all the usual features of a Wilk's product.

Weight: 5 lbs (2.25 kg)

Mega-Damage: 3D6 M.D.

Rate of Fire: Standard, see Modern Weapon Proficiency Section.

Effective Range: 2000 feet (610 m)

Payload: 20 shots standard clip, can not use a long E-Clip.

Bonus to Strike: +1 to strike on an aimed shot.

Black Market Cost: 18,000 credits.

## Wilk's 457 Laser Pulse Rifle

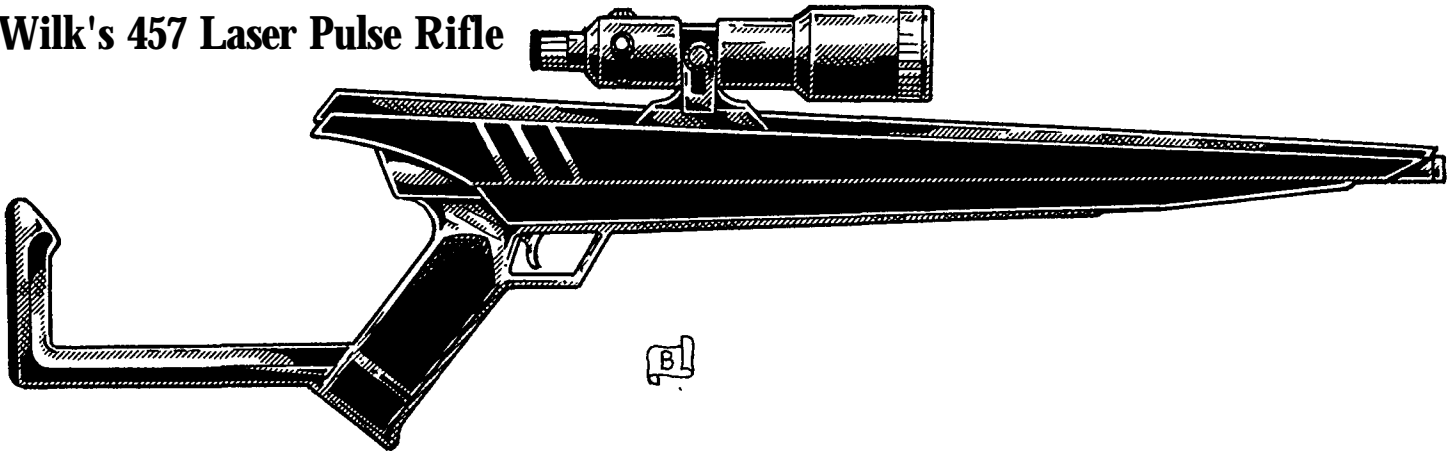

One of the newer designs from the wizards at *Wilk's Laser Industries Inc.* is a rapid-fire pulse rifle that has the trademark features of all of Wilk's high quality weapons; sleek, lightweight, black plastic and ceramic construction, long distance firing range, and reliability in the field. This weapon was released four years ago and became an instant classic.

Weight: 6 lbs (2.7 kg)

Mega-Damage: 3D6+2 M.D. per single shot, or 1D6x10 per multiple pulse burst (three simultaneous shots).

Rate of Fire: Standard, see Modern Weapon Proficiency Section.

Effective Range: 2000 feet (610 m)

Payload: 30 single shots per standard long E-Clip or 10 pulse.

Bonus to Strike: +1 to strike on an aimed shot.

Cost: 40,000 credits.

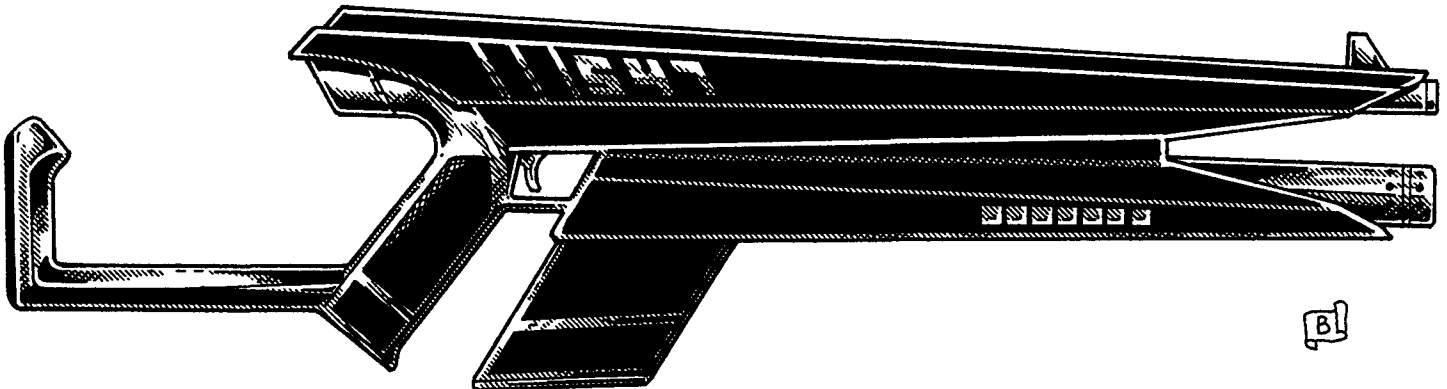

## Wilk's 547 "Double Dealer"

The 547 has become a very popular weapon throughout the west simply because it takes an already fine weapon and makes it better. Wilk's has taken the popular 447 laser rifle and added a light automatic grenade launcher. The laser provides range and accuracy, the grenade launcher provides area effect firepower. The laser E-Clip fits in the handle (takes standard or long clips), but also has the added feature of a second E-Clip housing in the top, butt end of the weapon which can also take a short or long clip. The grenade magazine fits into the lower housing in front of the trigger. A folding stock provides additional stability.

Weight: 6.5 lbs (2.9 kg)

Mega-Damage: Laser: 3D6 M.D. per single shot. Grenade: 3D6 M.D. to a 12 foot (3.6 m) radius.

Rate of Fire: Laser: Standard (single shot, burst or wild). Grenade launcher: Each shot counts as a melee action.

Effective Range: Laser: 2000 feet (610 m). Grenade Launcher: 500 feet (152 m).

Payload: Laser: 40 shots with a long E-Clip which comes standard with the weapon; 80 with two long clips. Grenade Launcher: Eight; two in the chamber and a six grenade magazine.

Bonus to Strike: +1 to strike on an aimed shot.

Cost: 32,000 credits.

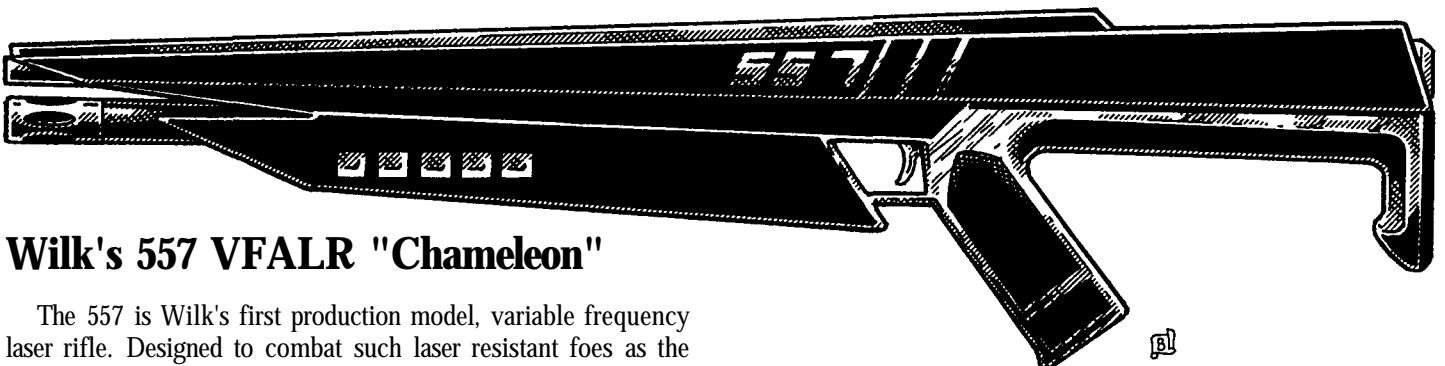

## Wilk's 557 VFALR "Chameleon"

The 557 is Wilk's first production model, variable frequency laser rifle. Designed to combat such laser resistant foes as the Glitter Boy. The VFALR designation stands for Variable Fre-

quency Advanced Laser Rifle. This weapon is a marvel of weapons technology. The variable frequency laser has 24 different light frequencies in its memory and will automatically reset itself after one attack if the target proves to be impervious to that frequency.

Weight: 6 lbs (2.7 kg)

Mega-Damage: 2D6 M.D. per single shot or 6D6 per triple pulse burst.

Rate of Fire: Standard, see Modern Weapon Proficiency Section.

Effective Range: 2000 feet (610 m)

Payload: 51 single shots per standard long E-Clip or 17 pulse shots.

Bonus to Strike: +1 to strike on an aimed shot.

Cost: 36,000 credits.

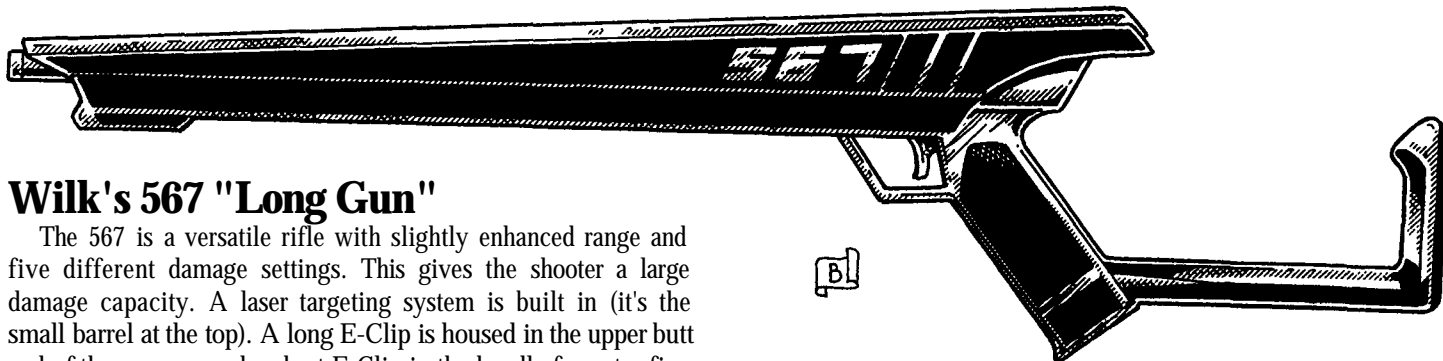

## Wilk's 567 "Long Gun"

The 567 is a versatile rifle with slightly enhanced range and five different damage settings. This gives the shooter a large damage capacity. A laser targeting system is built in (it's the small barrel at the top). A long E-Clip is housed in the upper butt end of the weapon and a short E-Clip in the handle for extra fire-power.

Weight: 6.5 lbs (2.9 kg)

Mega-Damage: A single blast does 1D6 M.D., a double pulse does 2D6 M.D., a triple pulse does 3D6 M.D., a quadruple pulse 4D6 M.D. or maximum, doing 5D6 M.D.

Rate of Fire: Standard

Effective Range: 2200 feet (670.5 m)

Payload: 50 shots for 1-3 dice damage blasts (two E-Clips), or 25 4-5 dice pulse shots (two E-Clips), reduce payload 25% without the short clip.

Bonus to Strike: +1 to strike on an aimed shot.

Cost: 38,000 credits.

## Wilk's-Remi Firearms

### High-Tech Laser Weapons with Old West Styling

In a brilliant marketing move, Wilk's has produced a series of weapons that "look" like the revolvers and rifles of the Old West, but are really laser pistols. In most cases they are the rough equivalent to the sleek black ceramic pistol except made out of ceramics and steel, weigh heavier (which is what gunmen and gunslingers want), have a shorter range, but heavy damage.

### Wilk's-Remi 104 Derringer

A classic looking Derringer similar in design concept to the "pocket pistol." The palm gun is a small, easily concealed weapon designed to fire *two* simultaneous shots for greater damage. This weapon is usually used as either a backup weapon or a purse gun. Like all Wilk's Remi products, it is very well made. Available with a walnut, ivory or pearl handle. A special "plug in" hookup allows for the use of an ordinary E-clip recharger to power up the empty weapon.

Weight: 10 ounces (0.27 kg)

Mega-Damage: 2D4 M.D.

Rate of Fire: Two simultaneous shots.

Effective Range: 300 feet (91.5 m)

Payload: 4 shots.

Cost: 9,000 credits.

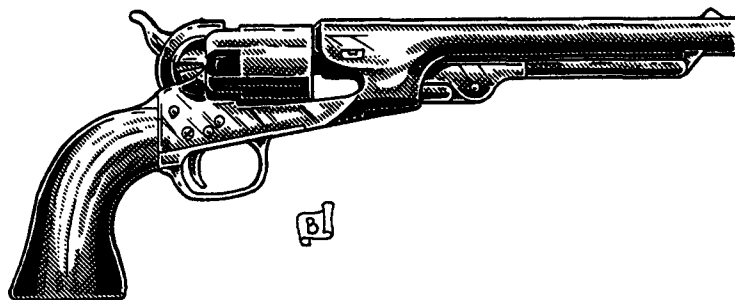
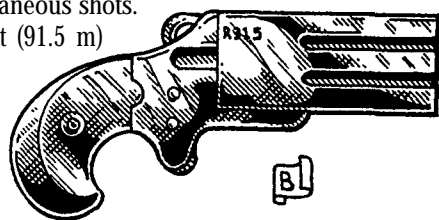

### Wilk's-Remi 130 "Six Shooter"

This is a beautiful revolver that has the look of a Pre-Rifts artifact from the late 1800s — a Remington New Model Army 1863, .45 caliber revolver. This weapon is extremely well balanced and a common sight across the New West.

Weight: 2.5 lbs (1.2 kg)

Mega-Damage: 2D6 M.D.

Rate of Fire: Standard, aimed, burst, wild.

Effective Range: 1000 feet (305 m)

Payload: 20 shots with a standard short E-Clip, 40 shots with a long E-Clip.

Bonus to Strike: +1 bonus to strike on an aimed shot because of the light weight and superior balance.

Cost: 12,000 credits.



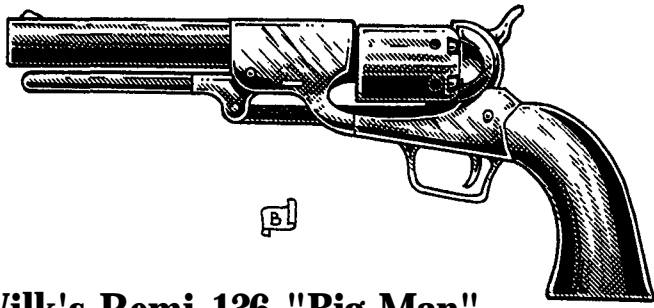

### Wilk's-Remi 136 "Big Man"

This heavy laser pulse pistol is designed to look like the massive Walker Colt .44 caliber revolver, manufactured around 1847. It has become an instant hit with gunslingers, bounty hunters, lawmen, gamblers, 'Slingers, Juicers and bandits.

Weight: 3 lbs (1.4 kg)

Mega-Damage: 3D6 M.D.

Rate of Fire: Standard, aimed, burst, wild.

Effective Range: 600 feet (183 m)

Payload: 15 shots with a standard short E-Clip, 30 shots with a long E-Clip.

Cost: 15,000 credits.

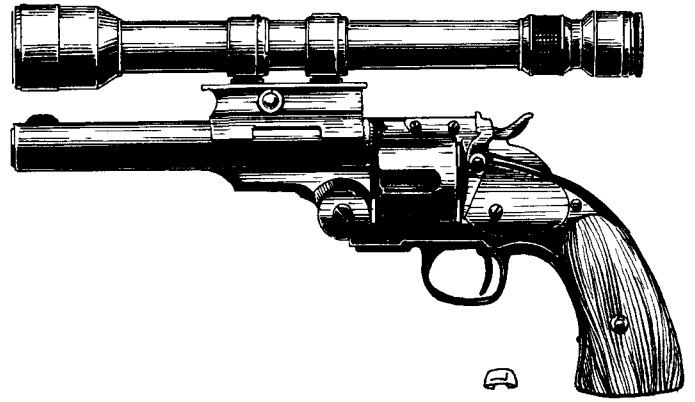

### Wilk's-Remi 137 "Kingdom Come"

A heavy, pulse laser pistol designed to look like an 1874 Smith & Wesson .45 caliber revolver — comes standard with a telescopic scope. It has become an instant hit with bounty hunters, lawmen, gamblers, 'Slingers, Juicers and bandits.

Weight: 3.2 lbs (1.5 kg); the scope adds 6 ounces.

Mega-Damage: 3D6 M.D. per single blast or 6D6 per double blast.

Rate of Fire: Standard

Effective Range: 500 feet (152 m)

Payload: 8 double pulse shots with a standard short E-Clip, 16 shots with a long E-Clip.

Cost: 27,000 credits.

## Old West Rifles

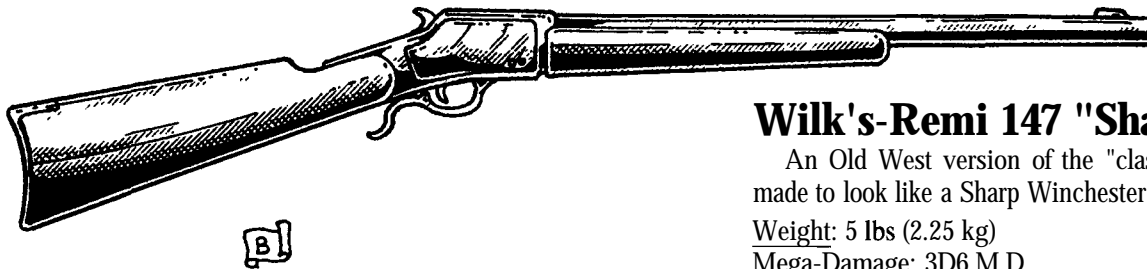

### Wilk's-Remi 147 "Sharp Shooter"

An Old West version of the "classic" Wilk's 447 laser rifle made to look like a Sharp Winchester .50 caliber rifle.

Weight: 5 lbs (2.25 kg)

Mega-Damage: 3D6 M.D.

Rate of Fire: Standard

Effective Range: 2000 feet (610 m)

Payload: 20 shots standard clip, can not use a long E-Clip.

Bonus to Strike: +1 to strike on an aimed shot.

Cost: 18,000 credits.

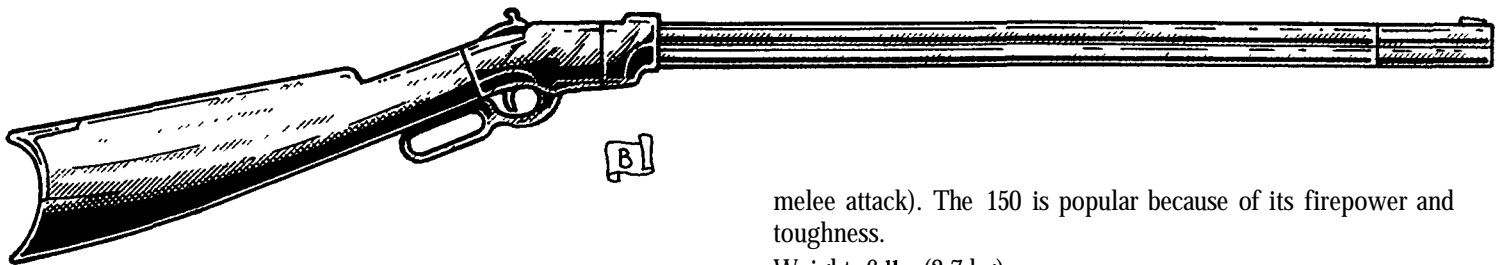

### Wilk's Remi 150 "Volcanic"

This laser rifle is reminiscent of the old Volcanic manufactured around 1850. The old rifles had the hoop cocking mechanism behind the trigger. In the Wilk's-Remi laser version, it is used to release the spent E-clip which is concealed in the rifle stock. The weapon has two long barrels that can be fired individually (one shot) or simultaneously (two shots; counts as one

melee attack). The 150 is popular because of its firepower and toughness.

Weight: 6 lbs (2.7 kg)

Mega-Damage: 3D6 M.D. per single shot or 6D6 simultaneous double blast.

Rate of Fire: Standard, see Modern Weapon Proficiency Section.

Effective Range: 2000 feet (610 m)

Payload: 34 single shots per standard long E-Clip or 17 double blasts.

Cost: 34,000 credits.

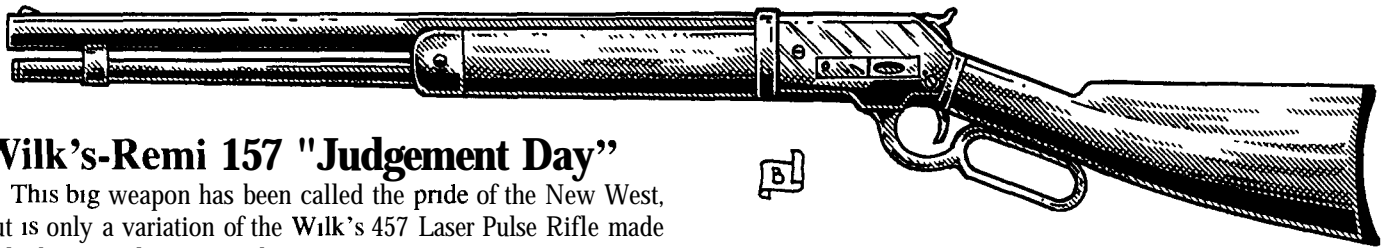

## Wilk's-Remi 157 "Judgement Day"

This big weapon has been called the pride of the New West, but is only a variation of the Wilk's 457 Laser Pulse Rifle made to look like a classic Winchester 40-82.

Weight: 6 lbs (2.7 kg)

Mega-Damage: 3D6+2 M.D. per single shot, or 1D6x10 per multiple pulse burst (three simultaneous shots).

Rate of Fire: Standard, see Modern Weapon Proficiency Section.

Effective Range: 1800 feet (548.6 m)

Payload: 30 single shots per standard long E-Clip or 10 pulse shots.

Cost: 38,000 credits.

## Other Wilk's Products of Note

### Wilk's Beehive & Blinder Laser Grenades

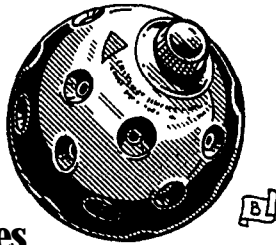

The Beehive and Blinder are "electronic" grenades that are designed to use laser technology instead of standard chemical explosive technology. The Beehive is designed as an offensive grenade that fires 40 single laser beams out to a 30 foot (9 m) radius from the detonation point. The Blinder is intended for riot control, anti-terrorism and as a means to incapacitate or distract an opponent.

Weight: 12 ounces (0.35 kg)

S.D.C. of the Grenade: 20 points; A.R. 10

Mega-Damage: *Beehive Grenade.* Every individual caught in the blast takes 3D6 M.D. Giant-sized individuals take 5D6 M.D. and vehicles the size of a car or bigger take 1D6x10 M.D. Cost: 1200 credits each (sometimes a 10% bulk discount is available if one orders 72 or more).

*The Blinder Grenade* is designed not to injure, but to blind both men and electronics. The high intensity light beams blind anybody without protective eye covering and happens so fast

that it circumvents light adjusting goggles and visors. Victims are blinded for 1D4 melee rounds, -8 to strike, parry and dodge, no initiative and lose two melee attacks, after which the vision is obscured with a dot of light for an additional 2D4 melee rounds, -1 on initiative, -4 to strike, parry and dodge, and lose one melee attack/action. Even those in power armor or vehicles with special light shielding should be momentarily distracted for 1D6 seconds, lose initiative and one melee action. All cameras and optics are also blinded by the sudden intense light (temporarily don't work) but come back on line in 1D4 melee rounds (15-60 Seconds).

Cost: 400 credits. Note: Lyn-Srial are not affected even by blinding light.

Radius of Effect: 30 feet (9 m). The entire blast lasts about 1.5 seconds.

Rate of Fire: One can be thrown at a time; each tossing of a grenade counts as one melee action.

Effective Range: 120 feet (122 m); double with supernatural P.S.

Payload: One charge/effect per grenade, although if it can be recovered, Beehive grenades can be recharged at a cost of 800 credits and the Blinder for 200 credits.

**Note:** See **Rifts® World Book 11: Coalition War Campaign** for other types of hand grenades, flares and pyrotechnics.

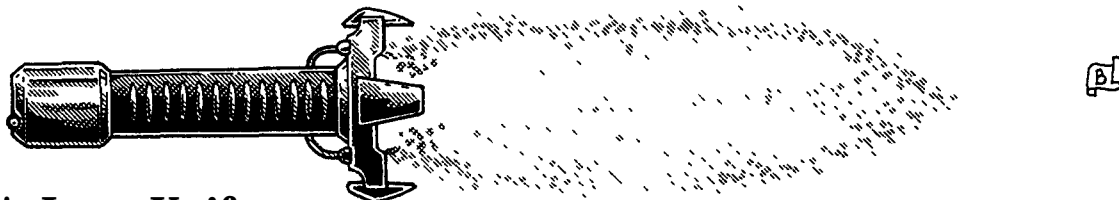

### Wilk's Laser Knife

The laser knife grew out of the technology used for the laser scalpel. Adventurers wanted a hand to hand weapon that was more powerful than the average Vibro-Blade. The laser knife was the first attempt at this. The laser knife projects a stable laser field eight inches (0.21 m) from the generator hilt. The laser is projected in the visible light spectrum and resembles a magic energy blade or psi-sword. It is still considered experimental and sold with no warranty and a warning about safety.

Weight: 1 lb (0.45 kg)

Mega-Damage: 3D6 M.D. per strike of the weapon.

Rate of Fire: As per hand to hand attacks.

Effective Range: Hand-held like any knife; cannot be thrown (automatic shut off feature).

Note: The laser knife cannot be used to parry any type of attack; it cuts everything it touches.

Payload: 30+1D4x10 minutes per standard E-Clip; unpredictable duration. Cost: 18,000 credits.

## Wilk's Laser Cane

Effectively a *laser rod* disguised as walking sticks/canes in a variety of styles, from simple to the ornate, to the garish and outrageous with silver or gold plating, inset gems, sculpted features and so on.

Weight: 1-2 lb (0.45 to 9 kg)

Mega-Damage: 2D4 M.D. or 2D6 M.D. per blast (add 20% to the cost for 2D6 M.D.).

M.D.C. of the Cane: 25

Rate of Fire: As per hand to hand attacks.

Effective Range: 800 feet (224 m).

Note: The cane can be used to parry physical attacks from fists to swords,

Payload: 20 shots for a standard E-Clip; cannot take a long clip.

Cost: 10,000 credits. Artistic additions can add as little as 500 credits to 30,000 depending on exactly what is done and the materials used, especially when it comes to gems.

## Wilk's Portable Laser Torch (tool)

A wonderful tool for cutting and welding. The laser welding gun has the familiar Wilk's black, lightweight plastic and ceramic construction. A power cord connects the gun to its portable power pack that can be hooked to a belt or fit in a backpack, tool case, or duffle bag. The power pack is charged by two standard weapon E-clips. The torch has a variety of mega-damage and S.D.C. settings. It is designed to be a tool, not a weapon. Welding is normally done only a few feet from the object of the work, but the torch beam can be increased up to ten feet.

The torch can cut through an S.D.C. structure like butter. Remember, one M.D. point is about one hundred S.D.C., thus the torch can slice all around a 600 S.D.C. point metal door in 15 seconds on setting number 1D6 M.D. (1D4 M.D. setting to weld); a higher setting might shoot past the door and **hit/hurt** someone/thing of value.

Weight: 1 lbs (0.45 kg)

Mega-Damage: 1D4, 1D6, 2D4, 3D6, and 4D6 M.D.

S.D.C. Damage: 1D6, 3D6, 6D6, 1D6x10 S.D.C.

Rate of Fire: Standard, see Modern Weapon Proficiency Section.

Maximum Effective Range: 10 feet (3 m)

Payload: 100 shots or about two hours of continuous use per pair of E-Clips.

Black Market Cost: 7000 credits.

## Wilk's Laser Wand (tool)

A small pen or pocket flashlight size item about 6 inches long. It is designed for detail laser work on electronics. The handy little device has one mega-damage setting and four S.D.C. settings. It is designed for close work, one to three feet, and not meant to be a weapon.

Weight: two ounces

Mega-Damage: One M.D. point.

S.D.C. Damage: 1D4, 1D6, 2D6, or 3D6 S.D.C.

Rate of Fire: Standard, see Modern Weapon Proficiency Section.

Maximum Effective Range: 10 feet (3 m)

Payload: 50 shots.

Black Market Cost: 2000 credits. Mini-Energy clip costs 200 credits.

## Wilk's Laser Scalpel

This is a laser tool designed for delicate surgery. The scalpel has several settings for under one S.D.C. point of damage and can inflict as much as 1D6 S.D.C. points. It is not meant to be used as a weapon. Range is six inches.

Cost: 2500 credits.

## Wilk's PC-2020 Field Identifier

### Laser Holographic

### Portable Computer

This is a multi-purpose computer about the size of a briefcase. The case is padded with a mega-damage protective housing for field use. Dual drive system with a 150 gigabyte hard drive with 132 megabytes of Random Access Memory (RAM). Uses one inch disks. Weight: 5 lbs (2.3 kg). M.D.C.: 10.

The most unique features are its holographic projector screen (has a hard plasma screen as back-up) and its "Identifier program." The identifier program can recognize and identify 6000 vehicles and robots, 21,000 animal species (indigenous and known D-Bee life forms), 40,000 insects, and 50,000 plants and fruits. Data focuses on dangerous and friendly life forms and poisonous and edible plant life. The identification can be done by typing in data/features of note (1-72% success ratio and accuracy), by inputting a visual image (optic scan; 94% accuracy/success ratio); scans video, photographs, or drawings. The computer then creates a rotating three-dimensional image of the subject, along with the corresponding data available. Many species are unknown; limited to the Americas and minimal knowledge of Atlantis and the Euro and Asian continents (12%).

If the computer cannot identify the subject, it will report: "Insufficient data: Appears of be an indigenous form," meaning it cannot identify, but available data seems to indicate the subject *is* native to Earth. Or, "Insufficient data: Alien," meaning the subject appears to be a previously unknown species not native to Earth. A complete lack of information on the part of the inputter will result in, "Insufficient data. Please elaborate," meaning that the computer simply does not have enough information to make an identification of any kind based on the minimal information it has received. **Cost:** 19,000 credits. Good availability around cities.

---

## Conventional Revolvers

---

Wilk's, Northern Gun, **Bandito Arms** and a handful of other weapons manufacturers produce a handful of conventional revolvers and automatic pistols, sub-machineguns, assault rifles and machineguns (check out the Palladium Books' **Compendium of Contemporary Weapons** for hundreds of different weapons).

The following are some of the most popular "Old West" styled weapons commonly available in the New West and used by Gunslingers, Gunfighters and Lawmen.

---

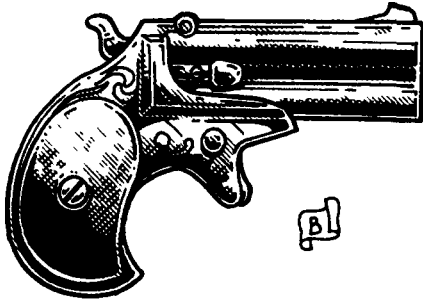

## Two-Shot Derringer .38/.40 Caliber

A two shot Derringer that is easy to conceal.

Approx. Weight: 10 ounces (0.25 kg)

H.P./S.D.C. Damage: 3D6 or 3D6+3 per round depending on the caliber of the round.

Rate of Fire: Each shot — pull of the trigger — counts as one melee action/attack.

Effective Range: 50 feet (15.2 m)

Payload: 2 rounds; it takes three melee actions (10 seconds) to reload, unless the character is one of the Gunslinger O.C.C.s, Lawman, Gunfighter, or Bounty Hunter O.C.C.s, in which case it take two melee actions.

Cost: 400-700 credits.

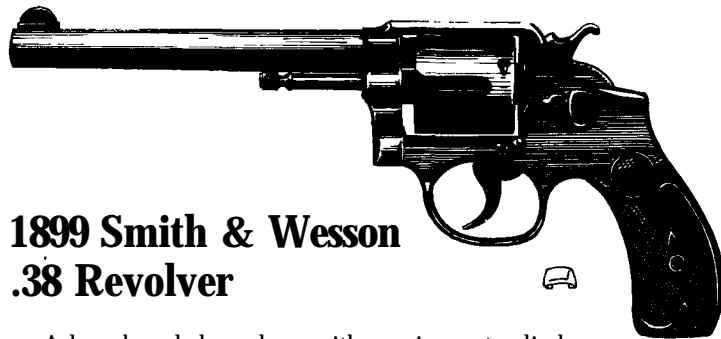

## 1899 Smith & Wesson .38 Revolver

A long barreled revolver, with a swing-out cylinder.

Approx. Weight: 2.2 lbs (1 kg)

H.P./S.D.C. Damage: 3D6 per round/bullet.

Rate of Fire: Each shot — pull of the trigger — counts as one melee action/attack.

Effective Range: 120 feet (36.6 m)

Payload: 6 rounds; it takes one melee round (15 seconds) to reload, unless the character is one of the Gunslinger O.C.C.s, Lawman, Gunfighter, or Bounty Hunter O.C.C.s, in which case it take half a melee round and uses up half the character's attacks that (or the next) melee round.

Cost: 400-700 credits.

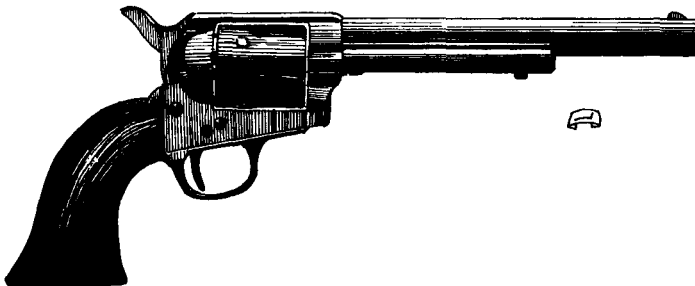

## 1873 Colt .38/.40 Revolver

A single action revolver that can fire .38 to .40 caliber rounds.

Approx. Weight: 3 lbs (1.5 kg)

H.P./S.D.C. Damage: 3D6 or 3D6+3 per round depending on the caliber of the round.

Rate of Fire: Each shot — pull of the trigger — counts as one melee action/attack.

Effective Range: 140 feet (42.6 m)

Payload: 6 rounds; it takes one melee round (15 seconds) to reload, unless the character is one of the Gunslinger O.C.C.s, Lawman, Gunfighter, or Bounty Hunter O.C.C.s, in which case it take half a melee round and uses up half the character's attacks that (or the next) melee round.

Cost: 600-900 credits.

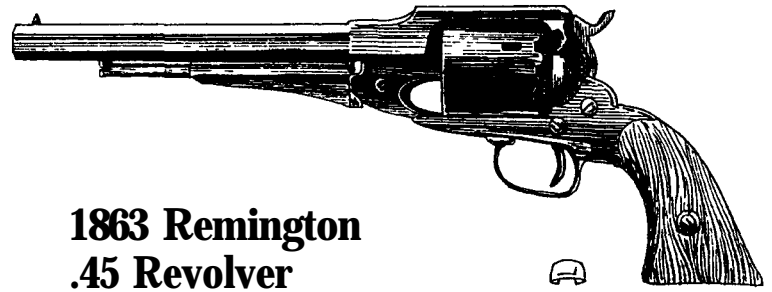

## 1863 Remington .45 Revolver

A replica of the 1863 New Model Army, single-action .45 caliber revolver. Another extremely popular weapon among professional gunmen.

Approx. Weight: 3 lbs (1.5 kg)

H.P./S.D.C. Damage: 4D6+3 per round.

Rate of Fire: Each shot — pull of the trigger — counts as one melee action/attack.

Effective Range: 130 feet (39.6 m)

Payload: 6 rounds; it takes one melee round (15 seconds) to reload, unless a Gunslinger, Lawman, Gunfighter, or Bounty Hunter O.C.C., in which case it take half a melee round and uses up half the character's attacks that (or the next) melee round.

Cost: 800-1000 credits.

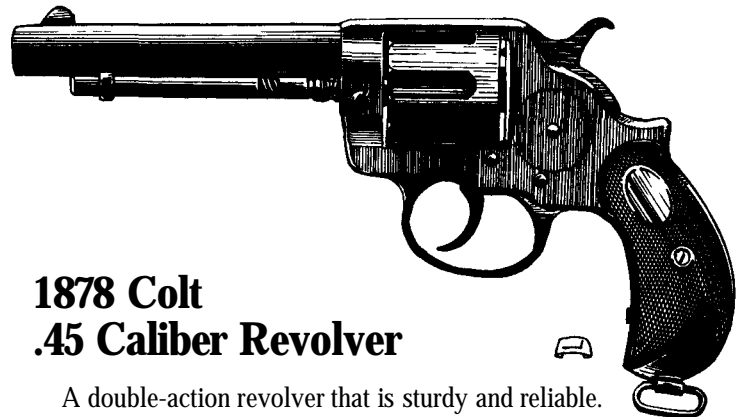

## 1878 Colt .45 Caliber Revolver

A double-action revolver that is sturdy and reliable.

Approx. Weight: 2.5 lbs (1.12 kg)

H.P./S.D.C. Damage: 4D6 per round.

Rate of Fire: Each shot — pull of the trigger — counts as one melee action/attack.

Effective Range: 150 feet (46 m)

Bonus: +1 to strike on an aimed shot.

Payload: 6 rounds; it takes one melee round (15 seconds) to reload, unless a Gunslinger, Lawman, Gunfighter, or Bounty Hunter O.C.C., in which case it take half a melee round and uses up half the character's attacks that (or the next) melee round.

Cost: 700-1000 credits.

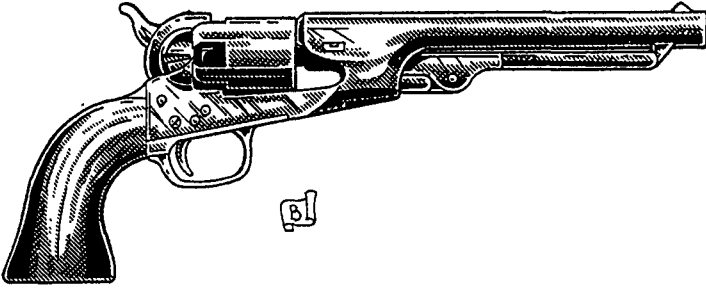

## Model 1860 Colt .44 Revolver

A replica of the Colt 1860 Model Army, percussion .44 caliber revolver — one of the most popular guns in the New West, especially among gamblers, **gunfighters** and **gunslingers**.

Approx. Weight: 3 lbs (1.5 kg)

H.P./S.D.C. Damage: 5D6 per round.

Rate of Fire: Each shot — pull of the trigger — counts as one melee action/attack.

Effective Range: 130 feet (39.6 m)

Payload: 6 rounds; it takes one melee round (15 seconds) to reload, unless a **Gunslinger**, **Lawman**, **Gunfighter**, or **Bounty Hunter O.C.C.**, in which case it take half a melee round and uses up half the character's attacks that (or the next) melee round.

Cost: 900-1200 credits.

## Remington Speed Loaders

The speed loader will reload a conventional, projectile shooting revolver in one melee action. **Cost:** 500 credits each.

## Wilk's Winchester 40-82 Rifle

A lever-action rifle that is popular in the New West for its handling and **firepower**.

Approx. Weight: 8 lbs (3.6 kg)

H.P./S.D.C. Damage: 5D6 per round.

Rate of Fire: Each shot — pull of the trigger — counts as one melee action/attack.

Effective Range: 1200 feet (305 m)

Payload: 8 rounds; it takes one melee round (15 seconds) to reload, unless a **Gunslinger**, **Lawman**, **Gunfighter**, or **Bounty Hunter O.C.C.**, in which case it take half a melee round and uses up half the character's attacks that (or the next) melee round.

Cost: 1200-1500 credits.

# CFT Experimental Weapons

Wilk's has also developed a revolutionary "cartridge" energy weapon system specifically with the frontier of the New West in mind. Fearing this new, experimental (and very different) product might be poorly received by the public, **Wilk's Laser Technologies** decided to release it under the brand name of CFT. This way, if the CFT energy cartridge system (known as the CFT Energy Six System) failed, it would not have a negative impact on the sterling reputation of **Wilk's**.

CFT handguns hold 6 to 12 small energy rounds that have the same general appearance and size of a standard .44 to .45 caliber or 9-10 mm bullet. The energy contained in each round/bullet is

totally expended in a single coherent blast the moment the weapon is fired. The spent energy cartridge/bullet is worth only about 25 cents per shell casing and is usually discarded.

To **Wilk's** delight, the CFT Energy-6 weapons have been a huge hit in the West, particularly among **gunslingers**, **gunfighters**, **bandits**, **gamblers** and average citizens looking for protection or a bit of excitement and power. The big advantages to CFT weapons are that the gun is comparatively inexpensive, one can buy as many or as few E-6 cartridges as he wants (or can afford), the cartridges should last for 8-10 years without losing power (hard to say since the weapons have only been on the market for six years), anybody used to handling a gun (i.e. has a **W.P. revolver** or **W.P. pistol skill**) can use a CFT "energy" gun, and the energy blasts do good amounts of damage.

CFT weapons have four notable disadvantages, most of which don't seem to bother the users of these popular weapons: 1. Limited **payload** (6-10 rounds) depending on the type of weapon. 2. Limited range: about half to a third the range of a conventional energy pistol. 3. CFT Revolvers require manual removal of the spent shells and reloading; pistols will have a clip. 4. The discharge of energy has a recoil, or "kick," like a conventional revolver or pistol; something that many **Westerners** like (it keeps with tradition and has the look and feel of a real **S.D.C. six-shooter** but with mega-damage power).

**Note:** Although these weapons have been designed to look like old style Colt revolvers (6 shots) and automatic pistols (10 shots), the CFT Energy Six System weapons require a *special gun* made from **M.D.** materials to fire the E-6 cartridge. If desperate enough, a character may *try* to fire a CFT E-6 cartridge from a *conventional* revolver or pistol. However, there is a 01-65% likelihood that the round will explode in the gun and inflict double damage to the shooter (roll for each **shot/attempt**)— this is a good way to lose fingers or a hand. If the energy round is successfully discharged, the range is half and firing more than two E-6 rounds a minute will melt the gun, fusing parts together and making it useless junk (irreparable damage).

The cost of each E-6 round is 320 credits or 29,700 cr. for a box of 96 (roughly a 1000 credit savings).

The CFT weapons are not illustrated because they look like the classic Colt revolvers of the old west and similar to those already shown.

## CFT "Peacebringer"

The "Peacebringer" is modeled after the long-barrelled, single-action Army or "Peacemaker" Colt .45 caliber revolver, circa 1872-1900— used by the likes of **Wyatt Earp**, **Bat Masterson**, **Neal Brown** and other legendary figures from the Old West. Like its ancient predecessor, the Peacebringer is one of the finest handguns available. It is reliable and sturdy enough to sustain rough use in the field of combat as both a reliable shooting iron and as a club, used to hit an opponent over the head or alongside the ear with the barrel or handle. This weapon is handcrafted and is commonly found with such added features as pearl, bone, or wooden grips. It has good accuracy and balance, but nothing impressive enough to provide bonuses to shoot.

Weight: 3 lbs (1.4 kg)

Mega-Damage: 2D6+3 **M.D.**

Rate of Fire: Each shot — pull of the trigger — counts as one melee action/attack.

Effective Range: 500 feet (152 m)

Payload: Six-shot revolver; it takes one melee round (15 seconds) to reload, unless a Gunslinger, Lawman, Gunfighter, or Bounty Hunter O.C.C., in which case it takes half a melee round and uses up half the character's attacks that (or the next) melee round.

Cost: 4,400 credits for the gun; each E-6 round costs 320 credits.

## CFT "1886er" or "86er"

The "86er" is a short-barrelled, single-action Army .45 caliber Colt revolver, also known as the "Frontier Six-Shooter" or "Hog Leg," circa 1870-1886. It is a big gun that commands respect and is well known for its durability. It does a bit more damage but has shorter range.

Weight: 3 lbs (1.4 kg)

Mega-Damage: 3D6 M.D.

Rate of Fire: Each shot — pull of the trigger — counts as one melee action/attack.

Effective Range: 300 feet (91.5 m)

Payload: Six-shot revolver; it takes one melee round (15 seconds) to reload, unless a Gunslinger, Lawman, Gunfighter, or Bounty Hunter O.C.C., in which case it takes half a melee round and uses up half the character's attacks that (or the next) melee round.

Cost: 4,800 credits for the gun; each E-6 round costs 320 credits.

## CFT "Auto-Shooter"

A .45 caliber automatic pistol with a 10 shot clip, designed to look like the old Colt Government Model M1911A1.

Weight: 2.7 lbs (1.3 kg)

Mega-Damage: 3D6 M.D.

Rate of Fire: Single shot (each shot counts as a melee action) or automatic (can fire bursts: standard: aimed, burst, wild).

Effective Range: 300 feet (91.5 m)

Payload: 10 shot pistol; when the ammo-clip is empty, pop out the old one and slap in a new one. It takes one melee round (15 seconds) to reload a spent clip.

Cost: 6,500 credits for the gun; each E-6 round costs 320 credits.

## CFT "Cavalryman"

The Cavalryman is one of only two CFT rifles available, namely because the individual E-6 cartridges don't offer enough range to match modern energy rifles, or even most energy pistols. The tiny cartridges just don't hold enough power to propel the blast any great distance. It looks much like the old Spencer rifles from the Old West, circa 1865-1880.

Weight: 4 lbs (1.8 kg)

Mega-Damage: 2D6+3 M.D.

Rate of Fire: Each shot — pull of the trigger — counts as one melee action/attack.

Effective Range: 600 feet (183 m)

Payload: Six-shot rifle; it takes one melee round (15 seconds) to reload, unless a Gunslinger, Lawman, Gunfighter, or Bounty Hunter O.C.C., in which case it takes half a melee round and uses up half the character's attacks that (or the next) melee round.

Cost: 8,800 credits for the gun; each E-6 round costs 320 credits.

## CFT "Rangemaster"

The "Rangemaster" is a favorite in the New West for its range, versatility and accuracy. The "Rangemaster" is designed to use both a conventional E-Clip (for long range and rapid-fire) and E-6 cartridges (for short range and power). The weapon can switch from one to the other with the flick of a switch. The Rangemaster is designed to resemble a Winchester Model 1876 carbine.

Weight: 5 lbs (2.25 kg)

Mega-Damage: Conventional laser: 2D6 M.D.; E-6 charge: 3D6 M.D.

Rate of Fire: Standard or single shot.

Effective Range: Conventional Laser: 2000 feet (610 m)

E-6 cartridge: 600 feet (183 m)

Payload: Conventional laser: 20 shots standard clip or 40 from a long E-Clip.

E-6 Charge: Six; reloaded by hand.

Bonus: +1 to strike on an aimed shot.

Cost: 20,000 credits for the rifle with a standard (20 shot) E-Clip, plus the cost of E-6 rounds, 320 credits each.

---

# Techno-Wizard Equipment

By Chris Kornmann & Kevin Siembieda

---

## TW-Weapons

The following magical weapons and devices are among the most common to the New West. Their availability is limited and some places don't have any. Many communities in the West have seen or heard about such weapons and devices, but have never seen them, or have only seen them in the possession of drifters, gunmen, **Cyber-Knights**, practitioners of magic and adventurers. Most TW-Weapons, equipment and vehicles are found only in and around places where **Techno-Wizardry** is common practice (like the *Colorado Baronies* and *Tolkeen*), or large towns and cities where there might be a magic shop or business owned by two or more **Techno-Wizards** who create and sell their magical wares. From time to time, the **Black Market/Bandito Arms**, other arms dealers, and pawn shops *may* offer a tiny handful of **Techno-Wizard** devices for sale, but often at high prices.

TW weapons are popular because psychics and practitioners of magic don't need any artificial energy source to recharge/reload the weapons (they use their own innate powers), reloading is done with a thought (2-3 seconds and one melee action), most offer superior damage and/or range and the average person can't use the weapons (must have P.P.E. or I.S.P. and know how to focus the energy).

**Techno-Wizard** creations are illegal in the Coalition States and Territories. The possession of a TW item is punishable by death, with the perpetrator often being executed on the spot! Yet despite the Coalition States' extreme policies, **Techno-Wizard**

items are among the most highly prized contraband and fetch excellent prices (20-100% higher than normal), particularly in the 'Burbs and border towns.

**Note:** As a general rule, the I.S.P. cost needed to recharge a TW device is 50-100% more than the P.P.E. or P.P.E. spell equivalent cost. So if 10 P.P.E. is needed the 15 or 20 I.S.P. is needed — most TW devices should list both. Generally, the range and/or payload of a weapon will be increased 50% when a TW weapon is used on a ley line or nexus.

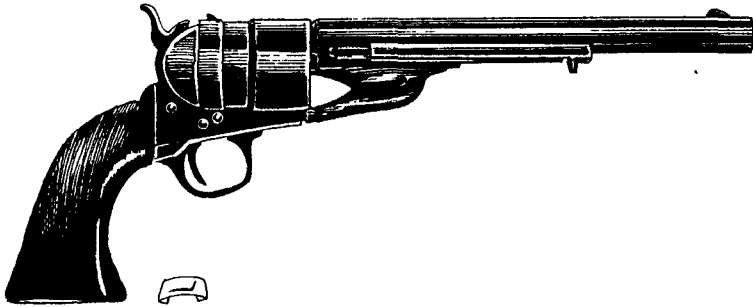

## TW-45 or TW Six-Gun

Six-Guns can appear as any variety of pre-Rifts replicas of the ancient six-shooters — revolvers — of the past. They have been changed through **Techno-Wizardry** to store magical energy that is unleashed as mega-damage energy blasts. The only drawback to these weapons is also their greatest advantage, they must be charged with P.P.E. by either a wizard or a psychic. This is a disadvantage to people without psionic or magical powers because they can't use these devices, which happens to make them appealing to psychics and users of magic. Consequently, these weapons are ideal for characters who have mystic training (and P.P.E.) or some measure of psionic power (I.S.P.).

The TW Six-Gun is unique in that it does not require the user to be a sorcerer, just that he possess the necessary P.P.E. or I.S.P. to recharge the weapon with magical energy. Many TW weapons require an immense amount of psychic I.S.P. or the user must be able to cast the spells used to create the device in order to recharge the weapon. In the case of the TW Six-Gun, and a handful of other weapons and items, the **Techno-Wizards** have created a weapon that can be charged with either P.P.E. or I.S.P., and no actual spell knowledge is required. Obviously, this dramatically increases the number of potential users and the value of the weapon.

### **Creation Stats:**

Initial P.P.E. Cost: 40

Spells Needed: Telekinesis (8) and energy bolt (5)

Physical Requirements: A large revolver and a rose quartz worth 600 credits or more. Takes about 50 hours of work to build.

### **Weapon Stats:**

Weight: Typically 2.5 to 3 lbs (1.2 to 1.4 kg); varies with weapon type.

Damage: 1D6 M.D. per shot.

Rate of Fire: Each shot counts as one melee attack.

Effective Range: 500 feet (152 m)

P.P.E. Cost to Charge & Recharge the Item: 6 P.P.E. or 12 I.S.P. gives the weapon six more 1D6 M.D. blasts.

Payload: 6 energy shots. To reload all six chambers with energy, all a character has to do is concentrate and pump six P.P.E. points (or 12 I.S.P.) into the weapon; counts as one melee action

(2-3 seconds). Although designed to fire magical energy blasts, if so desired, the weapon can be loaded with and fire conventional bullets. However, bullets cannot be loaded or fired until *all* magic energy has been discharged from the gun. This flexibility of use, S.D.C. bullets or M.D. magic energy, is appealing to many people who like the versatility. Using conventional bullets requires reloading by hand. When even one chamber is loaded with a conventional bullet, the weapon cannot be charged to fire magical energy.

**Bonus Note:** The character's usual W.P. and/or O.C.C. bonuses to strike with a revolver apply.

Cost: 45,000+ credits (famed champions of good or fellow mages of renown *may* be given a 10% discount); fairly common with fair to good availability.

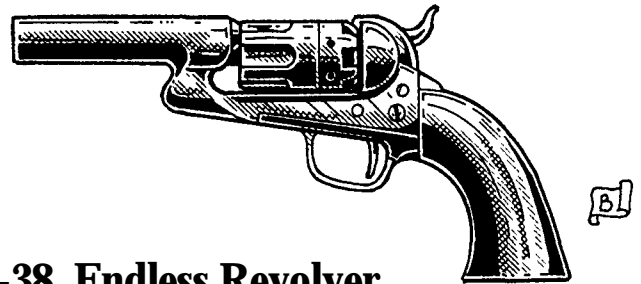

## TW-38, Endless Revolver

A comparatively small, .38 caliber revolver. However, it doesn't get its name, "TW-38" from the caliber of the gun, but from the fact that it has a magical payload of 38 shots! The "TW-38" has all the same basic features of the TW Six-Gun but shoots magical, S.D.C./Hit Point bolts of energy. Obviously, the big advantage of the TW-38 is the magic energy bullets and huge payload of 38 energy blasts; no having to stop and reload after every six bullets are fired like conventional revolvers.

### **Creation Stats:**

Initial P.P.E. Cost: 30

Spells Needed: Telekinesis (8) and Energy bolt (5).

Physical Requirements: An excellent quality .38 caliber revolver and a rose quartz worth 300 credits or more. Takes about 45 hours to build.

### **Weapon Stats:**

Weight: Typically 2.5 lbs (1.2 kg).

Damage: 4D6 S.D.C. per shot.

Rate of Fire: Each shot counts as one melee attack.

Effective Range: 500 feet (152 m)

P.P.E. Cost to Charge & Recharge the Item: 6 P.P.E. or 12 I.S.P. gives the weapon six more 4D6 S.D.C. blasts.

Payload: 38 magical energy blasts. To reload the weapon with 38 energy shots, the character must concentrate and pump six P.P.E. points (or 12 I.S.P.) into the weapon; counts as one melee action (2-3 seconds). Conventional bullets (6) can be fired from the weapon, but cannot be loaded or fired until all magic energy has been discharged. This flexibility of use (S.D.C. bullets or S.D.C. magic energy with a superior payload) adds to the appeal of this weapon. Using conventional bullets requires reloading by hand. When even one chamber is loaded with a conventional bullet, the weapon cannot be charged to fire magical energy. \*

**Bonus Note:** The character's usual W.P. and/or O.C.C. bonuses to strike with a revolver apply.

Cost: 30,000 credits (famed champions of good or fellow mages of renown *may* be given a 10% discount); fairly common with fair to good availability.

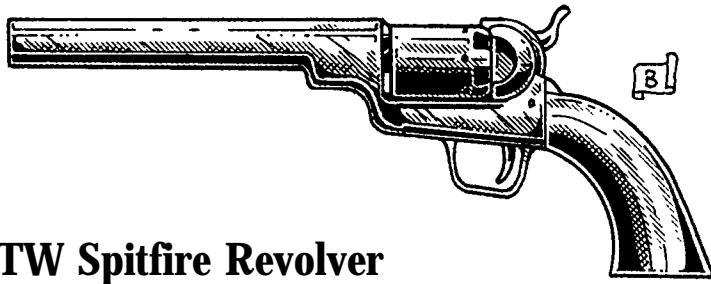

## TW Spitfire Revolver

A large, heavy revolver based on the old Wells Fargo .31 caliber single action revolver. It has all the same basic features of the TW Six-Gun but shoots magical, M.D., mini-fire balls.

**Creation Stats:**

**Initial P.P.E. Cost:** 60

**Spells Needed:** Energy bolt (7) and fire balls (10)

**Physical Requirements:** Wells Fargo .31 caliber revolver and a diamond worth 2000 credits or more. Takes about 60 hours of work to build.

**Weapon Stats:**

**Weight:** Typically 3 lbs (1.4 kg).

**Damage:** 3D6 M.D. per shot.

**Rate of Fire:** Each shot counts as one melee attack.

**Effective Range:** 200 feet (61 m)

**P.P.E. Cost to Charge & Recharge the Item:** 10 P.P.E. or 20 I.S.P. gives the weapon six more 3D6 M.D. blasts.

**Payload:** 6 energy blasts. To reload all six chambers with energy, all a character has to do is concentrate and pump 10 P.P.E. points (or 20 I.S.P.) into the weapon; counts as one melee action (2-3 seconds). Conventional bullets (6) can be fired from the weapon, but cannot be loaded or fired until all magic energy has been discharged. Using conventional bullets requires reloading by hand. When even one chamber is loaded with a conventional bullet, the weapon cannot be charged to fire magical energy.

**Bonus Note:** The character's usual W.P. and/or O.C.C. bonuses to strike with a revolver apply.

**Cost:** 60,000+ credits (famed champions of good or fellow mages of renown *may* be given a 10% discount); fair availability.

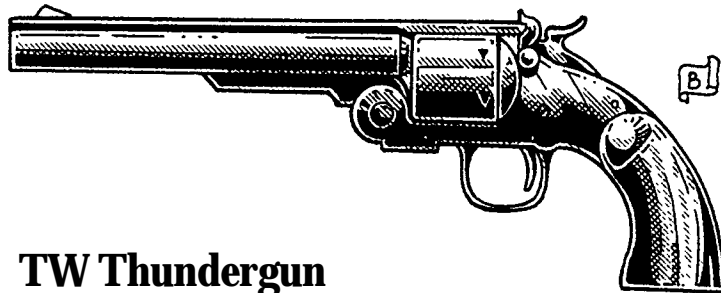

## TW Thundergun

An old style Schofield No. 3 single action revolver. It has all the same basic features of the TW Six-Gun but shoots enchanted projectiles that inflict mega-damage to supernatural beings and creatures of magic.

**Creation Stats:**

**Initial P.P.E. Cost:** 60

**Spells Needed:** Energy bolt (7), sense evil (2), sense magic (4), fly as the eagle, fire bolt (7) and thunderclap (4).

**Physical Requirements:** Schofield No. 3 revolver and a clear diamond worth 5000 credits or more (no more than a few flaws). Takes about 60 hours of work to build. Magic only affects bullets coated with or made entirely of silver. Normal bullets do ordinary damage.

**Weapon Stats:**

**Weight:** Typically 3 lbs (1.4 kg).

**Damage:** Silver bullets: 3D6 S.D.C. damage to mortal beings, but 5D6 M.D. to practitioners of magic and creatures of magic (dragons, faerie folk, etc.), and 1D6x10 to supernatural evil! In addition, each round that strikes a supernatural or magic being cracks with the sound of thunder! The sound of the gun firing is also unusually loud. Has no affect against robots, cyborgs or M.D.C. structures.

**Rate of Fire:** Each shot counts as one melee attack.

**Effective Range:** 500 feet (152 m)

**P.P.E. Cost to Charge & Recharge the Item:** 15 P.P.E. or 30 I.S.P. enchants six more silver bullets (works only on bullets coated with or made of silver).

**Payload:** 6 shots/rounds/bullets, whether enchanted silver bullets or conventional rounds. Conventional bullets have no special properties.

**Bonus Note:** The character's usual W.P. and/or O.C.C. bonuses to strike with a revolver apply.

**Cost:** 60,000+ credits (famed champions of good or fellow mages of renown *may* be given a 10% discount); fair availability. A favorite of vampire hunters and monster slayers.

## TW Super-Six Carbine

Basically a rifle version of the TW Six-Gun revolver, only with substantially greater range.

**Creation Stats:**

**Initial P.P.E. Cost:** 50

**Spells Needed:** Telekinesis (8) and energy bolt (5)

**Physical Requirements:** A rifle and a rose quartz worth 600 credits or more. Takes about 60 hours of work to build.

**Weapon Stats:**

**Weight:** Typically 5 to 8 lbs (2.3 to 3.6 kg); varies with weapon type.

**Damage:** 2D6 M.D. per shot.

**Rate of Fire:** Each shot counts as one melee attack.

**Effective Range:** 1500 feet (457.2 m)

**P.P.E. Cost to Charge & Recharge the Item:** 15 P.P.E. or 30 I.S.P. gives the weapon six more 2D6 M.D. blasts.

**Payload:** 6 energy shots. To reload the rifle with six more energy blasts, all a character has to do is concentrate and pump 15 P.P.E. points (or 30 I.S.P.) into the weapon; counts as one melee action (takes 2-3 seconds). Conventional bullets (6) can also be fired from the weapon, but cannot be loaded or fired until all magic energy has been discharged. Using conventional bullets requires reloading by hand. When even one chamber is loaded with a conventional bullet, the weapon cannot be charged to fire magical energy.

**Bonus Note:** The character's usual W.P. and/or O.C.C. bonuses to strike with a conventional rifle **apply**.

**Cost:** 75,000+ credits (famed champions of good or fellow mages of renown *may* be given a 10%-20% discount); fairly common, with fair to good availability.



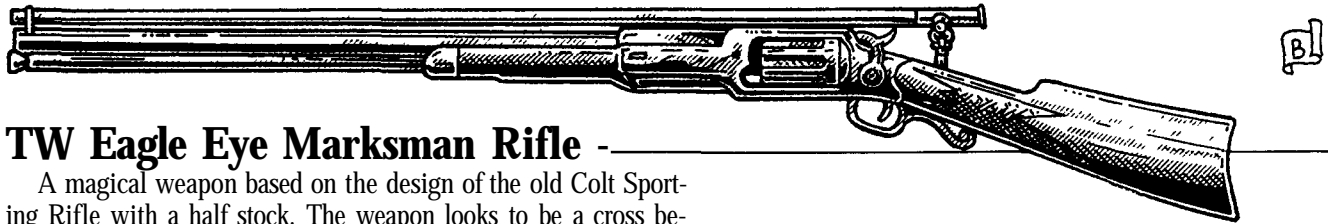

## TW Eagle Eye Marksman Rifle

A magical weapon based on the design of the old Colt Sporting Rifle with a half stock. The weapon looks to be a cross between a revolver and a rifle with a long sight that runs the entire length of the barrel. The sight is magically enchanted to enable the viewer to see the invisible, to have nightvision, telescopic enhancement, and offers a +1 bonus to strike. The gun fires a sort of magic laser beam.

### Creation Stats:

Initial P.P.E. Cost: 85

Spells Needed: See the invisible (4), eyes of the wolf (25), energy field (10), globe of daylight (2) and energy bolt (5).

Physical Requirements: A Colt Sporting rifle with half stock and a yellow crystal worth 500 credits or more. Takes about 70 hours of work to build.

### Weapon Stats:

Weight: Typically 5 to 6 lbs (2.3 to 2.7 kg).

Damage: 2D6 M.D. per shot; effectively a laser.

Rate of Fire: Each shot counts as one melee attack.

Effective Range: 1800 feet (548.6 m)

P.P.E. Cost to Charge & Recharge the Item: 15 P.P.E. or 30 I.S.P. gives the weapon six more 2D6 M.D. blasts.

Payload: 6 laser-like energy blasts. To reload the rifle with six more magical blasts, all a character has to do is concentrate and pump 15 P.P.E. points (or 30 I.S.P.) into the weapon ; counts as one melee action (takes 2-3 seconds). Conventional bullets *cannot* be used in this gun.

Bonus Note: The character's usual W.P. and/or O.C.C. bonuses to strike with a conventional rifle apply.

Cost: 75,000+ credits (famed champions of good or fellow mages of renown *may* be given a 10%-20% discount); fair availability.

## TW Windblaster Rifle

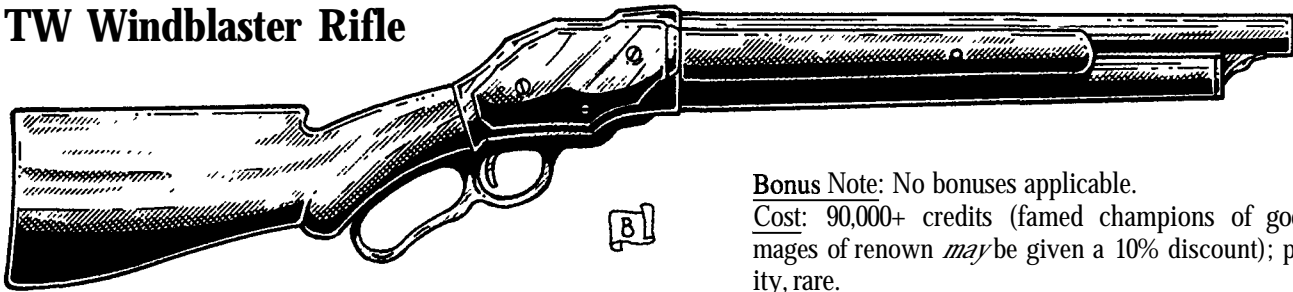

A TW heavy rifle that fires a wind rush with each pull of the trigger; equal to 5th level spell strength. It is based on the styling of an old West Winchester and is sometimes called the "Wind-Chester."

### Creation Stats:

Initial P.P.E. Cost: 50

Spells Needed: Energy bolt (5) and Wind Rush (20)

Physical Requirements: A heavy rifle (cannot have a sawed-off barrel and cannot be a shotgun) and a blue quartz or blue sapphire worth 700 credits or more. Takes about 60 hours of work to build.

### Weapon Stats:

Weight: Typically 5 to 8 lbs (2.3 to 3.6 kg); varies with weapon type.

Damage: Equal to a 5th level Wind Rush spell per shot.

Rate of Fire: Each shot counts as one melee attack.

Effective Range: 300 feet (91.5 m)

P.P.E. Cost to Charge & Recharge the Item: 25 P.P.E. or 50 I.S.P. gives the weapon two Wind Rush blasts.

Payload: Two magical wind blasts. To reload the weapon with two more magic wind blasts, the shooter must concentrate and pump in the appropriate amount of P.P.E. (or I.S.P.) into the weapon; counts as one melee action (takes 2-3 seconds). Conventional bullets can also be fired from this weapon, but not until all magic energy is unleashed from both barrels and must be loaded by hand.

Bonus Note: No bonuses applicable.

Cost: 90,000+ credits (famed champions of good or fellow mages of renown *may* be given a 10% discount); poor availability, rare.

## TW Old Lightning Rifle

A long-barrelled rifle (Volcanic carbines are preferred) that fires powerful bolts of magic lightning with each pull of the trigger.

### Creation Stats:

Initial P.P.E. Cost: 95

Spells Needed: Energy bolt (5) and call lightning (15)

Physical Requirements: A long-barrelled rifle and a yellow or blue crystal (diamond or other) worth 1000 credits or more. Takes about 70 hours of work to build.

### Weapon Stats:

Weight: Typically 5 to 8 lbs (2.3 to 3.6 kg); varies with weapon type.

Damage: 5D6 M.D. per shot.

Rate of Fire: Each shot counts as one melee attack.

Effective Range: 1200 feet (366 m)

P.P.E. Cost to Charge & Recharge the Item: 15 P.P.E. or 30 I.S.P. gives the weapon one more 5D6 M.D. blast.

Payload: Can hold up to 6 shots total. To reload the rifle with one lightning blasts, all a character has to do is concentrate and pump 15 P.P.E. points (or 30 I.S.P.) into the weapon; counts as one melee action (takes 2-3 seconds). Conventional bullets can be shot from the weapon, but only when all magic energy has been fired, and must be loaded by hand.

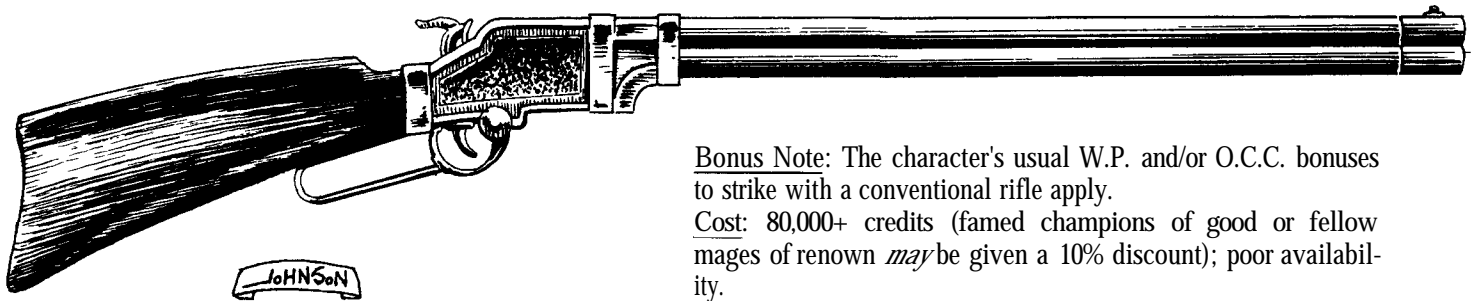

Bonus Note: The character's usual W.P. and/or O.C.C. bonuses to strike with a conventional rifle apply.

Cost: 80,000+ credits (famed champions of good or fellow mages of renown *may* be given a 10% discount); poor availability.



## TW Hellfire Shotgun

A heavy, double-barrelled, sawed-off shotgun that shoots devastating magic fire balls with each pull of the trigger.

### Creation Stats:

Initial P.P.E. Cost: 55

Spells Needed: Ignite fire (6), fire bolt (7), and fireball (10).

Physical Requirements: A heavy, double barrelled, sawed-off shotgun and a rose quartz or red or orange sapphire worth 1000 credits or more. Takes about 60 hours to build.

### Weapon Stats:

Weight: Typically 5 to 6 lbs (2.3 to 2.7 kg).

Damage: 6D6 M.D. per shot.

Rate of Fire: Each shot counts as one melee attack.

Effective Range: 300 feet (91.5 m)

P.P.E. Cost to Charge & Recharge the Item: 16 P.P.E. or 32 I.S.P. gives the weapon two fire ball blasts.

Payload: Two fire ball blasts. To reload the shotgun with two more fire blasts, the shooter must concentrate and pump in the appropriate amount of P.P.E. (or I.S.P.) into the weapon; counts as one melee action (takes 2-3 seconds). Conventional bullets can be shot from the weapon, but not until all magic energy is unleashed from both barrels. Conventional rounds must be loaded by hand.

Bonus Note: No bonuses for shotguns, but the spell bonuses and effects all apply.

Cost: 65,000+ credits (famed champions of good or fellow mages of renown *may* be given a 10% discount); fair availability.

## TW Snare Gun

A double-barrelled, sawed-off shotgun or flare gun that fires a magic net with each pull of the trigger; equal to 5th level spell strength.

### Creation Stats:

Initial P.P.E. Cost: 45

Spells Needed: Energy bolt (5) and magic net (7).

Physical Requirements: A short, double barrelled, sawed-off shotgun and a clear crystal worth 300 credits or more. Takes about 40 hours to build.

### Weapon Stats:

Weight: Typically 3-5 lbs (1.2 to 2.3 kg).

Damage: Fires a magic net equal to a 5th level spell.

Rate of Fire: Each shot counts as one melee attack.

Effective Range: 200 feet (61 m)

P.P.E. Cost to Charge & Recharge the Item: 10 P.P.E. or 20 I.S.P. gives the weapon two net blasts.

Payload: Two magic net blasts. To reload the gun with two more rounds/net blasts, the shooter must concentrate and pump in the appropriate amount of P.P.E. (or I.S.P.) into the weapon; counts as one melee action (takes 2-3 seconds). Conventional rounds or flares can be shot from the weapon, but not until all magic energy is unleashed from both barrels. Conventional rounds must be loaded by hand.

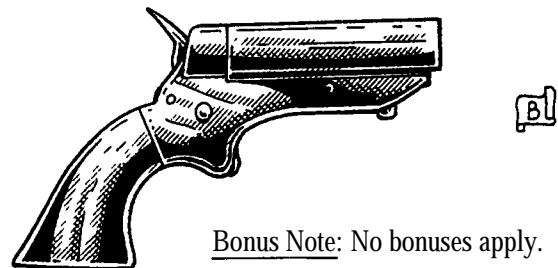

Bonus Note: No bonuses apply.

Cost: 45,000 credits; poor availability. A favorite of bounty hunters and lawmen.

## TW Sapper

This is a powerful and dangerous weapon to all practitioners of magic. It fires a sort of negative or anti-magic energy bolt that dispels P.P.E. energy, effectively sapping sorcerers and creatures of magic of their P.P.E. with every blast that hits.

The weapon typically looks like an old style musket (so fellow Techno-Wizards and mages know when they are facing a Sapper), but can be built into any kind of large gun such as a shotgun, rifle or even a rail gun. The weapon is extremely expensive and is rarely sold to people who are not practitioners of magic themselves, but exceptions are sometimes made for reputable Cyber-Knights, Sky-Knights and lawmen.

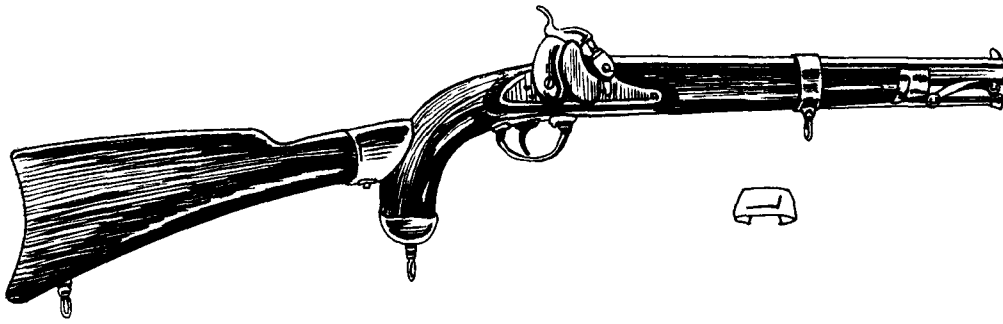

### Creation Stats:

Initial P.P.E. Cost: 195

Spells Needed: Anti-Magic Cloud (140) and Energy Disruption (12)

Physical Requirements: A large gun like a shotgun, rifle or rail gun, a clear diamond with no more than two minor flaws (minimum value 10,000 credits). Takes about 120 hours of work to make.

### Weapon Stats:

Weight: Typically 4-7 lbs (1.8 to 3.2 kg); varies with weapon type.

Damage (special): Each blast does no physical damage but drains P.P.E. from the character at the following rate: 1D6 P.P.E. from an average person, 3D6 from a practitioner of magic, 4D6 P.P.E. from a creature of magic (i.e. dragons, faerie folk) and supernatural beings (demons, elementals, godlings, gods, etc.). Note: If the character was casting a spell at the time, roll initiative to see if the spell caster got his spell off before he/she/it was struck by the anti-magic energy blast. If the spell caster loses on the initiative roll, he/she/it is struck before the spell goes off and the spell is negated and half the P.P.E. necessary to cast it is dispelled (yes, even if it is more than the usual 1D6 to 4D6 P.P.E.). In this case, no further P.P.E. is "sapped" from the spell caster. Timing is everything in order to disrupt a magic spell this way — the shooter must strike just before the spell is finished. If the spell caster wins initiative, the spell is cast and the sapper blast hits an instant later, with the usual drain to the spell caster. When a character is reduced to three P.P.E. the blasts have no further affect on the character.

When fired at a magic barrier, including magical walls force fields, and armor of **Ithan**, the blast does the equivalent of 4D6 M.D. or S.D.C. depending on the nature of the magical barrier. Shooting at illusions has no affect.

Rate of Fire: Each shot counts as one melee attack.

Effective Range: 600 feet (183 m)

P.P.E. Cost to Charge the Item: 40 P.P.E. gives the weapon four P.P.E. sapping or anti-magic blasts.

Payload: The weapon can hold up to 24 shots.

Bonus Note: The character's usual W.P. and/or O.C.C. bonuses to strike with a rifle apply.

Cost: 150,000+ credits (famed champions of good or fellow mages of renown *may* be given a 20% discount); very rare. Popular among **Cyber-Knights**, lawmen and bounty hunters.

## TW Silencers

These are nifty little devices that use a variation of the globe of silence spell to totally negate all sound from the weapon being fired. They can be used on magic firearms or conventional weapons. TW Silencers look just like ordinary silencers except for a trio of magic symbols, and a black or dark blue crystal.

### Creation Stats:

Initial P.P.E. Cost: 45

Spells Needed: Energy bolt (5) and globe of silence.

Physical Requirements: A length of tubing that attaches to the muzzle of the weapon (not applicable to shotguns, machineguns or rail guns), plus three magic symbols, and a black or dark blue crystal worth 200 credits or more. Takes about 3D4 hours to build.

### Physical Stats:

Weight: Typically 1 lb. (0.45 kg).

Damage: None

Rate of Fire: Not applicable.

Effective Range: Reduces the weapon's range by 10%, but completely muffles all sounds from the weapon.

P.P.E. Cost to Charge & Recharge the Item: 10 P.P.E. or 20 I.S.P. for 10 silenced blasts.

Payload: A fully charged TW Silencer will obliterate the sound of 10 gun shots. To recharge the silencer to muffle another 10 shots, the shooter must concentrate and pump in the appropriate amount of P.P.E. (or I.S.P.) into the magic silencer; counts as one melee action (takes 2-3 seconds).

Bonus Note: No bonuses apply.

Cost: 15,000 credits; fair availability. A favorite of gamblers, highwaymen, bounty hunters and assassins.

---

## Glittermount Magical Horse

---

The Glittermount is truly a sight to behold. The artificial horse is plated in polished silver and looks robotic in nature —in many ways it resembles a suit of **barding** brought to life. As a **Techno-Wizard** construct, the Glittermount is made from S.D.C. materials that are magically transformed into mega-damage materials and although they appear robotic, their power system is magical, and their internal structure defies modern science. In any bright light the horse glitters in an array of brilliant colors. As the horse begins to gallop a stream of glittering magical residue is left behind, like a semitransparent stream of sparkling fireworks or a gossamer rainbow. Nobody really knows the reason for the glittering residue (a side effect?), but it adds to the horse's mystical beauty.

The magical creation acts and functions very much like a real horse, with roughly equal intelligence and behavior. They are not as intelligent or programmed as robot horses and cannot speak to their riders; they are however, obedient and dutiful. Riding one requires any of the horsemanship skills. Of course, being magical creations, they do have a few special features.

1. Good speed and leaping capabilities; never tires.

2. When on a ley line, the TW horse can run in the air along the ley line up to 1000 feet (305 high) and at double its normal speed! Leaps are also double when on a ley line.

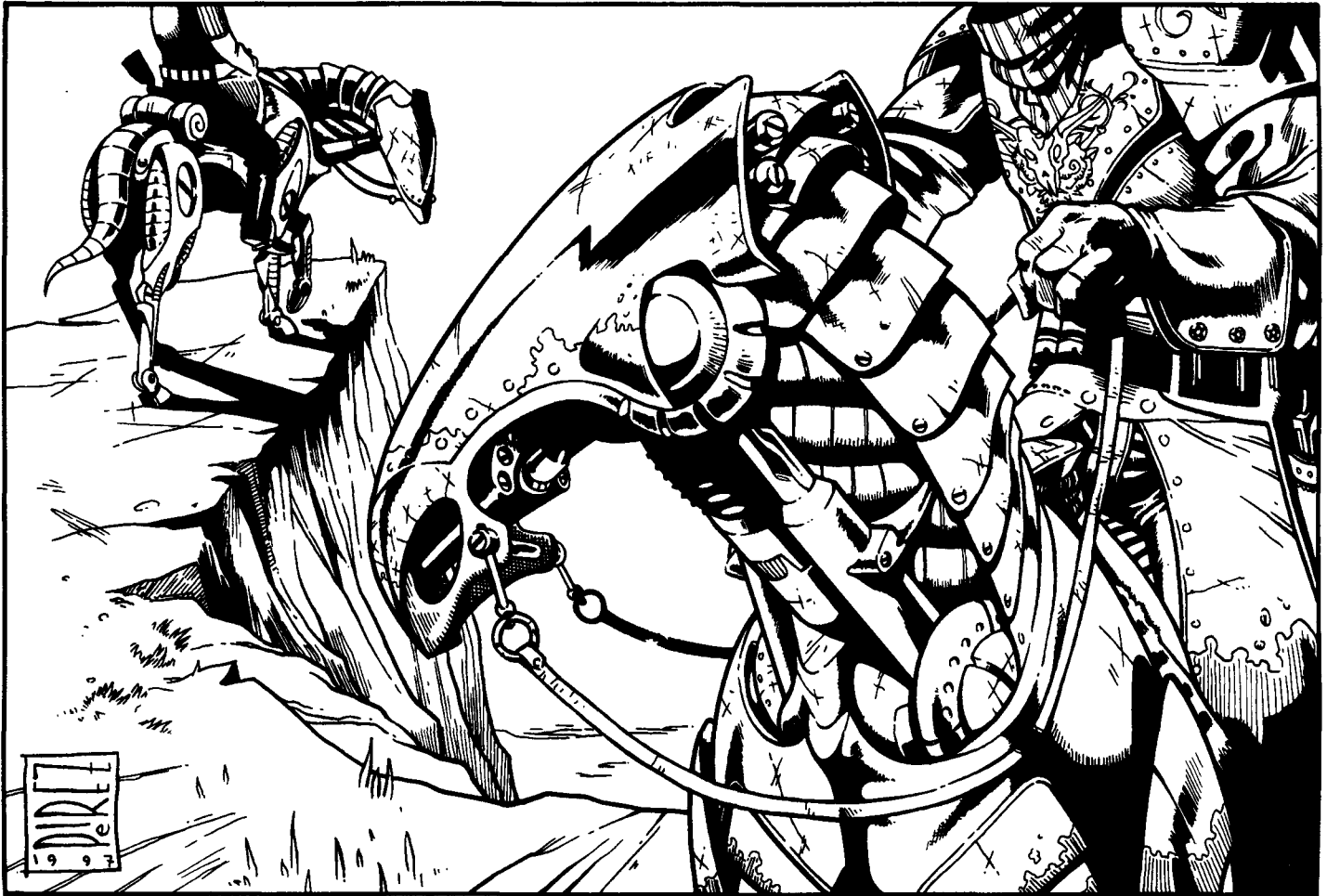

3. **Magical rejuvenation.** The Glittermount can regenerate damage to its body at a rate of 5D6 M.D.C. per hour. A destroyed leg can be magically regrown in 24 hours provided 240 P.P.E. points are pumped into the construct.

4. **Nightvision** 1000 feet (305 m; can see in total darkness) as well as see all spectrums of light. Also has keen hearing, but no sense of smell or speech capabilities.

5. Once a Glittermount magically bonds with a rider, that Glittermount never willingly leaves his side. If the rider is slain, 73% will accept a new owner, however, there are stories of Glittermounts defending the graves of their fallen riders until they wear out. In order to bond with the construct, the very first time the character rides the TW horse, he must expend 3/4 of his P.P.E. into the magical batteries. This does not power the magical horse, but links the two in a magical way.

6. **Limited spell casting abilities:** Globe of daylight (2 P.P.E.), blinding flash (1), turn dead (6) and levitation (5; self and rider only). All are equal to 4th level spell strength. A total of four spells can be cast per day (24 hours) by the Glittermount. However, if the rider wills it, the TW horse can draw on his P.P.E. to cast an additional number of spells from those available to it.

#### **Creation Stats:**

Initial P.P.E. Creation Cost: 285

Spells Needed: Constrain being (20), energy field (10), armor of Ithan (10), superhuman speed (10), globe of day light (2), blinding flash (1), turn dead (6), levitation (5) and a number of secret incantations.

Physical Requirements: The mechanical components, armor plating, silver to plate the exterior armor and mechanical parts, two large rose quartz crystals for eyes (typically concealed under large saucer-like coverings), a tectonic entity locked within the heart of the Glittermount and a number of secret components. Note that the tectonic entity inside the mechanical construct does not consider itself enslaved or abused and enjoys its life as part of the TW mechanical horse. The various magical constructions also keep the entity controlled, obedient and focused in its useful life as a Glittermount. It takes about 960 to 1100 hours to build a Glittermount (about 4-8 months of construction; varies depending on the long hours put into it and the number of people working on its construction).

#### **Techno-Wizard Mechanical Horse**

**Model Type:** Glittermount

**Crew:** One humanoid rider with one additional rider possible in emergencies.

#### **M.D.C. by Location:**

\* Head — 100

\* Legs (4) — 100 each

Main Body — 220

\* Every item marked by a single asterisk is small and/or difficult to strike. An attacker must make a "called shot" to hit and even then he is -3 to strike.

Complete destruction of the main body will destroy the magical construct and free the tectonic entity. Destruction of the head shuts it down. The head must be replaced by a Techno-Wizard at a cost of 1.5 million credits. Destroying one leg

will hobble the **Glittermount** and reduce speed, leaping distance and height by 33%.

### Speed

Running: Maximum speed of 80 mph (128.7 km).

Leaping: 20 (6 m) high and 50 feet (15.2 m) lengthwise, with a running start. Double speed when on a ley line.

Flying: Can run into the air (at double usual speed), up to a 1000 feet (305 m) high when running on a ley line.

Underwater Capabilities: The magical construct can function in and under water, able to walk along the bottom of the sea at about 25% its normal running speed, or swim at a speed of 5 mph (8 km or 4.3 knots). Maximum Depth is 600 feet (183 m).

### Statistical Data

Height: Usually about 14 hands (approx. 4.8 feet/1.4 m) at the shoulders. **Glittermounts** specially designed to be larger cost an additional 5% per every two hands (8 inches/0.24 m) of additional size.

Width: 2.6 feet (0.8 m)

Length: Approximately 8 feet (2.4 m).

Weight: 800 lbs. (360 kg)

Color of Hide: Silver, although the trim is often painted in different colors (rider's choice; red, yellow, gold, and black are the most popular). Never covered with fake fur to make it look like a real animal.

Attributes of Note: Equivalent of a Robot P.S. 30, P.P. 20, P.B. 12, Spd 75; equivalent I.Q. 7.

Power System: Magical. The **Glittermount** must be regularly recharged with 120 P.P.E. every four months. Without the P.P.E. recharge, the magical construct slows down; reduce speed, leaping distance, attacks per melee round, and all bonuses by half. If it goes without a recharge for 10 months it will slow down to a crawl (Spd 6, no bonuses, cannot leap, one melee action per round). Furthermore, it now needs a boost of 240 P.P.E. By 12 months it shuts down completely and needs 400 P.P.E. just to get back to half speed — 600 P.P.E. to get back to full speed and abilities. Consequently, one should never let the **Glittermount** get below half power. Any practitioner of magic or superhuman being with sufficient P.P.E. can recharge the **Glittermount**. Note that trying to feed it less than 120 P.P.E. at a time is useless, the creation is calibrated to accept 120 P.P.E. or more, so nothing less works.

Cargo: Can carry one rider and one companion (if both are roughly human-size, otherwise space may be tight for the companion rider, and this second seat is never comfortable for long periods; an hour or more), and up to 1400 pounds (630 kg). The magical horse **can pull** up to two tons!

Cost: 6.6 to 10 million credits depending on the seller and the needs of the market (famed champions of good or fellow mages of renown *may* be given a 10% discount); generally poor availability at most places (the Colorado Baronies are an exception, where the **TW** horse sells for 6 million credits). Extremely popular among **Techno-Wizards** and **Cyber-Knights**, otherwise too pricey for the average cowpoke.

### Weapon Systems:

1. **Energy Bolt Eyes:** The eyes of the **Glittermount** can fire blasts of energy equivalent to that of light ion blasts. The energy is magical in nature.

Primary Purpose: Defense

Mega-Damage: 2D6 per blast

Range: 500 feet (152 m)

Rate of Fire: Twice per melee round; each blast counts as one attack.

Payload: Effectively unlimited.

2. **Physical Combat:** Its magical nature and silver coated body means the **Glittermount** can attack and damage most supernatural beings, including dragons, demons and vampires.

Attacks per Melee Round: Four

Bonuses: +2 on initiative, +2 to strike, +4 to dodge when running, +4 to roll with punch, fall or impact, impervious to cold, heat, fire, disease, poison and horror factor; it's not alive so it doesn't need food, water or rest; can travel without tiring.

Damage: Double damage to creatures vulnerable to silver or magic.

Restrained Hoof Strike: 1D4 M.D.

Full Hoof Strike: 1D6 M.D.

Rear Kick/Power Kick: 2D6 M.D.

Stomp: 1D4 M.D.

Running Body Block: 1D4 M.D.

Head Butt: 1D4 M.D.

Bite: Not applicable

3. **Magic Spells:** The limited spells listed previously are not devastating magic, but may have applications in combat. Blinding flash can be used to startle, confuse or temporarily blind an opponent or pursuers. Globe of daylight can reap havoc with vampires and blind other nocturnal creatures, while turn dead has its obvious use. All spells are cast at the equivalent of 4th level.

---

## The TW Ironhorse

---

One of the greatest creations of **Techno-Wizardry** to come out of Tolkeen is the return of the "Ironhorse" (or train and railway). **Techno-Wizard** Ironhorses (trains) ride along the ley lines, drawing power from both the lines of energy themselves and from the rage of three **Baal-rog** demons locked inside the engine of the locomotive (Note: In the alternative, a lesser fire and air elemental can be used to power the engine, and these creatures, linked to the Ironhorse and able to move as the train, don't usually feel enslaved or imprisoned)! Nexus points — junctions where two or more ley lines intersect — can be used as a place and means to "switch tracks"; i.e. change direction by turning down a different ley line. The ley line nexus can also be used to open a dimensional Rift to teleport from one ley line to a completely different ley line up to 300 miles (482 km) away! The dimensional portal is opened for just a few seconds (2D4) and bridges space and time in the same reality, not to other dimensions, so there is little risk of encountering other-dimensional beings. However, there is the risk that outside forces (alien intelligences, gods, **Splugorth**, etc.) could, at that exact moment, alter the Rift so that it carries the **Techno-Wizard** train, its cargo and passengers to another dimension, alien world, or to an entirely different continent on Earth. Fortunately, these occurrences are incredibly rare (less than 1%). Thus, the **Techno-Wizard** Ironhorse has become the safest, most practical, and most desirable means of travel in the New West, as well as



the Magic Zone and kingdoms throughout the continent (Tolkeen, Lazlo, New Lazlo and the Colorado Baronies included) where ley lines are numerous and the people accept magic (or are too weak to oppose it). **Note:** The TW trains are outlawed by the Coalition States and are attacked whenever they appear in the States or in Territories controlled by the CS, sometimes even in regions far away from the CS — Coalition troops figure anybody riding a TW Ironhorse is either an enemy, enemy sympathizer, traitor, sorcerer or D-bee and as such, effectively a military target whenever and wherever encountered.

Since it is magically empowered and not dependent on railroad tracks, it is even more maneuverable, faster and versatile than the most advanced conventional train. It can travel at speeds of up to 100 mph (160.9 km), ride above the ground up to 1000 feet (305 m), and can swerve and move within the width of the ley line (rather than a thin umbilical line of track). Although reliant on ley lines, it does not have physical track vulnerable to attack or weather and can make short leaps of teleportation to other ley lines. Of course, being limited to riding along ley lines (typically a half mile to two miles wide) still limits the TW Ironhorse's range, and leaps to other ley lines must be directed to lines that have at least one intersecting nexus, otherwise the magical train will become stranded on that one, single ley line, incapable of teleportation (needs a nexus). This also means that train robbers, Coalition troops and other brigands know exactly where the teleportation/Rifts junction is located, and can set traps, ambushes and barriers there to stop and/or attack the train.

Ley Line Storms are also a problem, reducing speed to a sluggish 1D4x10 mph. When struck by magical lightning bolts from such a storm, the Ironhorse is temporarily knocked out of commission, sending it to a crashing halt and leaving it powerless for 1D4 hours. Random Rifts can, creatures from the Rifts, and sorcerers and demons attracted to ley lines may also prove to be a problem from time to time.

The M.D.C. locomotive engine is the driving force of the TW train, and the source of magic that makes travel and teleportation possible. These impressive magic vehicles can resemble ordinary train locomotives complete with cattle prow and smokestacks belching smoke (actually the smoke is from the fire of the Baal-rogs or fire elemental that powers the vehicle), but more often have a fantastic and/or menacing design. Often the front of the engine is typically designed to resemble a giant monstrous head with a gaping maw, clenched teeth or fangs for the grille of the cattle (or ram) prow, somewhat reminiscent to the CS Death's Head transports. Sometimes the engine has horse or other animal-like features, other times human or demonic; beautiful or ugly. Otherwise, it looks very much like the train engines of old, with large iron wheels, smokestacks that spew clouds of smoke and steam and a chain of cars that carry cargo or passengers. The locomotive can pull as few as 2 cars to as many as 30; the cars pulled can be S.D.C. or M.D.C., sealed, windowless cargo box cars or passenger cars with seats and windows (or a combination of both). Like the trains of old, the Ironhorse is a means of transporting people and cargo, but mainly cargo. Cargo can be raw materials (lumber, sheet metal, electronic parts, produce, etc.) to finished products (vehicles, weapons, computers, etc.), or livestock. A typical box car can hold 70 to 80 tons and weigh 10 tons empty; the Ironhorse can haul up to 24,000 tons or roughly five million pounds!

### **Creation Stats:**

Creation P.P.E. Cost: 9,540

Spells Needed: Too numerous to list, but includes protection circle for the engineers, dimensional portal, restoration, and others.

Physical Requirements: The mechanical components, armor plating, wheels, struts and engine for the locomotive, several expensive crystals and either three Baal-rog demons or one lesser fire and air elemental. The supernatural forces contained inside the mechanical construct are magically and physically bound to the Ironhorse and cannot escape (unless the vehicle is severely damaged) or able to attack or cause trouble. The various magical constructions also keep these deadly forces controlled, obedient and focused. It takes about 3700 to 4000 hours to build an Ironhorse (about 12-18 months of construction; varies depending on the long hours put into it and the number of people working on its construction).

### **Techno-Wizard Train Locomotive:**

**Class:** Ironhorse (note the Ironhorse is only the locomotive; box cars or passenger cars are magically pulled along with it).

**Crew:** The engineers' compartment can typically hold as many as 8-10 people. Crew includes two engineers/pilots, typically a low level (1D4 each) Techno-Wizard and a Shifter, 2-4 assistants/helpers to the engineers, and 6-24 defenders (usually 2-4 in the locomotive and the rest scattered throughout the train); may include a cargo work staff to help load and unload (10-100 people).

If a passenger train, there will be an assistant conductor for every two cars and one chief conductor (supervisor) for the entire train. Passenger trains usually also have one or two box cars and a caboose for luggage and incidental cargo, as well as a dining car with a service staff; typically about 12-20 people to cook food, pour drinks and serve the passengers who come to dine.

### **Ironhorse M.D.C. by Location:**

- \* Windows (4-6) — 15 each
- \* Doors (2; on the sides) — 80 each
- \* Sliding Door (1; large, in the rear of locomotive) — 125
- \* Emergency Exit (1; small; in ceiling/roof) —
- \* Headlights (4; front) — 10 each
- \* Spotlight (1-2; optional) — 15 each
- Large Wheels (2-4) — 100 each
- \* Small Wheels (12-20) — 50 each
- Smokestacks (1-4) — 80 each
- Ram Prow/Cattle-Catcher (1; large) — 450
- \*\* Main Body — 640

S.D.C. Boxcars !D6x100 S.D.C. or equivalent to 1D6 M.D. ea.

M.D. Boxcars typically have 100 M.D.C. each

\* Every item marked by a single asterisk is small and/or difficult to strike. An attacker must make a "called shot" to hit and even then he is -3 to strike.

Destroying 1-4 of the wheels will have no effect on the locomotive. Destroying 6 or 8 will reduce speed and bonuses by 25% (yes, even when flying in the air; TW devices have a certain logic to them, and in this case, moving wheels are a necessary component of travel, on ground and in the air). Destroying all or most will reduce speed and bonuses by half.

\*\* Depleting the M.D.C. of the main body completely destroys the vehicle and unleashes the beings contained inside. Elementals are likely to lash out for 1D6 minutes before van-

ishing, but the Baal-rog demons will seek revenge on the train's operators and defenders and anybody who dares to challenge or annoy them. Worse, the demons are not compelled to leave Earth and are likely to remain in our dimension indefinitely! Also note that after 80% of the M.D.C. has been depleted, there is a 01-50% chance that the Baal-rogs can break loose and escape, rendering the Ironhorse without power and severely damaged (4D6 weeks of repair at a cost of !D4x10 million credits). Only a 01-30% chance of elementals escaping.

**Note:** Magical healing/restoration property of the Ironhorse: !D4x10 M.D.C. can be restored to the locomotive for every 10Q P.P.E. points pumped into it. In addition, the ley line energy can be used to restore M.D.C. at a rate of 5D6 per day (a slow process).

### Speed

Flying or on the Ground: 100 mph (160.9 km), with a maximum altitude of 1000 feet (305 m), but often travels below the tree line to avoid being too obvious.

Water: If there is a ley line present, the Ironhorse can ride atop the water at full speed! No underwater capabilities.

Range: Effectively unlimited.

### Statistical Data for the TW Locomotive

Height: 10-15 feet (3-4.6 m) tall, smokestack may add another 4-8 feet (1.2 to 2.4m).

Length: 20-30 feet (6-9 m) long plus 5-10 feet (1.5 to 3 m) for the heavy ram prow.

Weight: 14-20 tons.

Cargo: Can haul up to 5 million pounds or approx. 2400 tons.

Power System: Magical and effectively unlimited. Powered in part by the three Baal-rog demons or two minor elementals and the ambient P.P.E. of the ley lines.

CS Cost: 500+ million credits; rare. Ironhorses are typically owned and operated by Techno-Wizards. There are two in operation in Colorado, one in Nevada/Arizona (one of the few owned by an independent, non-magical organization, Bandito Arms), one in Wyoming, Washington and the Pecos Empire, and several in Minnesota and the Magic Zone, among others.

### Weapon Systems

**1. Fire Bolt or Fire Balls (2):** Fire bolts of magical energy can be fired either from the eyes of the locomotive or the mouth. Can only fire in the direction faced by the Ironhorse, although the engine can momentarily point in a 30 degree arc of fire (side to side and up and down) without getting off course.

Primary Purpose: Defense

Mega-Damage: !D6x10 per double blast (automatically unleashes two fire balls)

Range: 1000 feet (305 m)

Rate of Fire: As often as twice per melee round.

Payload: Effectively unlimited.

**2. Weapon & Combat Notes:** Weapons and defenses, of the Ironhorse will vary from manufacturer to manufacturer and often reflect the needs of the owner and the level of hostility in the territory that it travels. Laser turrets, rail guns and missile launchers are most common. A total of four different weapon systems can be built into the locomotive, and as many as two on each boxcar or caboose, however, boxcars are generally considered expendable and rarely have weapons built into them.

Most Ironhorses will have 6-24 defenders (occasionally more, sometimes significantly more), with 10-33% being practitioners of magic or supernatural, and at least one major or master psychic. The rest may be virtually any type of man at arms, although 'Borgs, Juicers, Crazies, Headhunters and Gunfighters are most favored (there is rarely more than 1 or 2 'Slingers present).

**3. Bonuses:** +1 on initiative, +2 to strike, +2 to dodge, +2 to roll with impact/crash or fall. In addition, the locomotive is impervious to heat and fire, including M.D. plasma and magic fire. However, cold based attacks (typically magical), rune weapons, and Millennium Tree weapons do double their normal damage.

---

## Experience Tables

---

**CyberSlinger Cyborgs and Mining 'Borgs** use the 'Borg experience (E.P.) tables in the *Rifts® RPG*.

**Fennodi R.C.C.** advance in experience as per the O.C.C. selected.

**Great Dream Snakes and Phantasms** use the Dragon E.P. tables.

### Bounty Hunter O.C.C.,

### Mountain Giant R.C.C.

1	0,000-2,120
2	2,111-4,240
3	4,221-8,480
4	8,441-16,880
5	16,880-24,880
6	24,881-34,880
7	34,881-49,880
8	49,881-69,880
9	69,881-94,880
10	94,881-129,880
11	129,881-179,880
12	179,880-229,880
13	229,881-279,880
14	279,881-329,880
15	329,881-389,880

### Bandit O.C.C.

1	0,000-1,860
2	1,861-3,600
3	3,601-7,000
4	7,001-14,400
5	14,401-23,400
6	23,401-34,400
7	34,401-44,400
8	44,401-60,400
9	60,401-80,400
10	80,401-110,400
11	110,401-145,400
12	145,401-195,400
13	195,401-245,400
14	245,401-290,400
15	290,401-340,400

### Professional Gambler,

### Professional Thief & Smuggler

1	0,000-2,110
2	2,111-4,220
3	4,221-8,440
4	8,201-16,400
5	16,401-23,200
6	23,201-32,400
7	32,401-48,200
8	48,201-68,400
9	68,401-92,200
10	92,201-127,400
11	127,401-178,200
12	178,201-228,400
13	228,201-278,200
14	278,201-328,400
15	328,401-388,200

### Highwayman O.C.C.

### Justice Ranger, 1st Cavalry

1	0,000-2,000
2	2,001-4,000
3	4,001-8,200
4	8,201-16,400
5	16,401-24,500
6	24,501-34,600
7	34,601-49,700
8	49,701-69,800
9	69,801-94,900
10	94,901-129,000
11	129,001-179,100
12	179,101-229,200
13	229,201-279,300
14	279,301-329,400
15	329,401-389,500



**Sheriff's Deputy**

1 0,000-1,900  
 2 1,901-3,800  
 3 3,801-7,300  
 4 7,301-14,300  
 5 14,301-22,800  
 6 22,801-34,300  
 7 34,301-45,800  
 8 45,801-70,300  
 9 70,301-92,800  
 10 92,801-122,300  
 11 122,301-148,000  
 12 148,001-185,800  
 13 185,801-245,300  
 14 245,301-290,800  
 15 290,801-340,000

**Sherriff/Lawman**

1 0,000-2,025  
 2 2,026-4,050  
 3 4,051-8,100  
 4 8,101-16,300  
 5 16,301-25,500  
 6 25,501-35,700  
 7 35,701-50,000  
 8 50,001-70,200  
 9 70,201-95,000  
 10 95,001-130,000  
 11 130,001-180,200  
 12 180,201-230,000  
 13 230,001-280,400  
 14 280,401-340,500  
 15 340,501-400,600

**Gunfighter**

1 0,000-2,100  
 2 2,101-4,200  
 3 4,201-8,400  
 4 8,401-16,800  
 5 16,801-26,000  
 6 26,001-36,400  
 7 36,401-53,000  
 8 53,001-74,000  
 9 74,001-98,000  
 10 98,001-138,000  
 11 138,001-190,000  
 12 190,001-240,000  
 13 240,001-290,000  
 14 290,001-360,000  
 15 360,001-420,000

**Gunslinger,  
Wired-Gunslinger**

1 0,000-2,160  
 2 2,161-4,320  
 3 4,321-8,640  
 4 8,641-18,000  
 5 18,001-27,000  
 6 27,001-38,500  
 7 38,501-54,700  
 8 54,701-77,000  
 9 77,001-100,300  
 10 100,301-140,500  
 11 140,501-210,000  
 12 210,001-250,700  
 13 250,701-325,000  
 14 325,001-395,500  
 15 395,501-455,700

**Saddle Tramp  
Preacher (either)**

1 0,000-1,825  
 2 1,826-3,450  
 3 3,451-6,900  
 4 6,901-13,800  
 5 13,801-19,200  
 6 19,201-29,200  
 7 29,201-39,200  
 8 39,201-49,200  
 9 49,201-70,300  
 10 70,301-99,500  
 11 99,501-130,500  
 12 130,501-180,500  
 13 180,501-230,500  
 14 230,501-280,500  
 15 280,501-320,500

**Saloon Bum & Saloon Girl**

1 0,000-1,875  
 2 1,876-3,750  
 3 3,751-7,250  
 4 7,251-14,100  
 5 14,101-21,200  
 6 21,201-31,200  
 7 31,201-41,200  
 8 41,201-51,200  
 9 51,201-71,200  
 10 71,201-101,500  
 11 101,501-136,500  
 12 136,501-186,500  
 13 186,501-236,500  
 14 236,501-286,500  
 15 286,501-326,500

**Cowboy  
Lyn-Srial Average Citizen**

1 0,000-1,900  
 2 1,901-3,800  
 3 3,801-7,300  
 4 7,301-14,300  
 5 14,301-21,300  
 6 21,301-30,000  
 7 30,001-40,000  
 8 40,001-53,000  
 9 53,001-73,000  
 10 73,001-103,000  
 11 103,001-138,000  
 12 138,001-188,000  
 13 188,001-238,000  
 14 238,001-288,000  
 15 288,001-328,000

**Cactus People R.C.C.  
Psi-Ponies (optional)**

1 0,000-1,935  
 2 1,936-3,870  
 3 3,871-7,750  
 4 7,751-15,400  
 5 15,401-20,000  
 6 20,001-30,000  
 7 30,001-40,000  
 8 40,001-60,000  
 9 60,001-80,000  
 10 80,001-110,500  
 11 110,501-140,000  
 12 140,001-180,000  
 13 180,001-230,000  
 14 230,001-280,000  
 15 280,001-350,000

**Keepers of the Desert**

1 0,000-2,110  
 2 2,111-4,220  
 3 4,221-8,440  
 4 8,441-16,880  
 5 16,881-24,880  
 6 24,881-34,880  
 7 34,881-48,440  
 8 48,441-68,440  
 9 68,441-92,480  
 10 92,481-128,480  
 11 128,481-178,480  
 12 178,481-228,880  
 13 228,881-278,880  
 14 278,881-324,480  
 15 324,481-388,880

**Psi-Slinger,  
Lyn-Srial Cloudweaver**

1 0,000-2,150  
 2 2,151-4,300  
 3 4,301-9,600  
 4 9,601-18,200  
 5 18,201-28,400  
 6 28,401-38,600  
 7 38,601-54,800  
 8 54,801-75,200  
 9 75,201-100,400  
 10 100,401-132,600  
 11 132,601-185,800  
 12 185,801-240,200  
 13 240,201-295,400  
 14 295,401-365,600  
 15 365,601-425,800

**Lyn-Srial Sky-Knight**

1 0,000-2,140  
 2 2,141-4,280  
 3 4,281-8,560  
 4 8,561-17,520  
 5 17,521-25,520  
 6 25,521-35,520  
 7 35,521-50,520  
 8 50,521-71,000  
 9 71,001-96,000  
 10 96,001-131,200  
 11 131,201-181,300  
 12 18,301-231,400  
 13 **231, 401-281, 500**  
 14 **281, 501-341, 600**  
 15 **341, 601-401, 700**

**Worm Wraith**

1 0,000-2,250  
 2 2,251-4,500  
 3 4,501-9,000  
 4 9,001-20,600  
 5 20,601-35,700  
 6 35,701-45,800  
 7 45,801-60,900  
 8 60,901-85,100  
 9 85,101-110,200  
 10 110,201-160,300  
 11 160,301-220,400  
 12 220,401-280,500  
 13 280,501-340,600  
 14 340,601-400,700  
 15 400,701-500,800

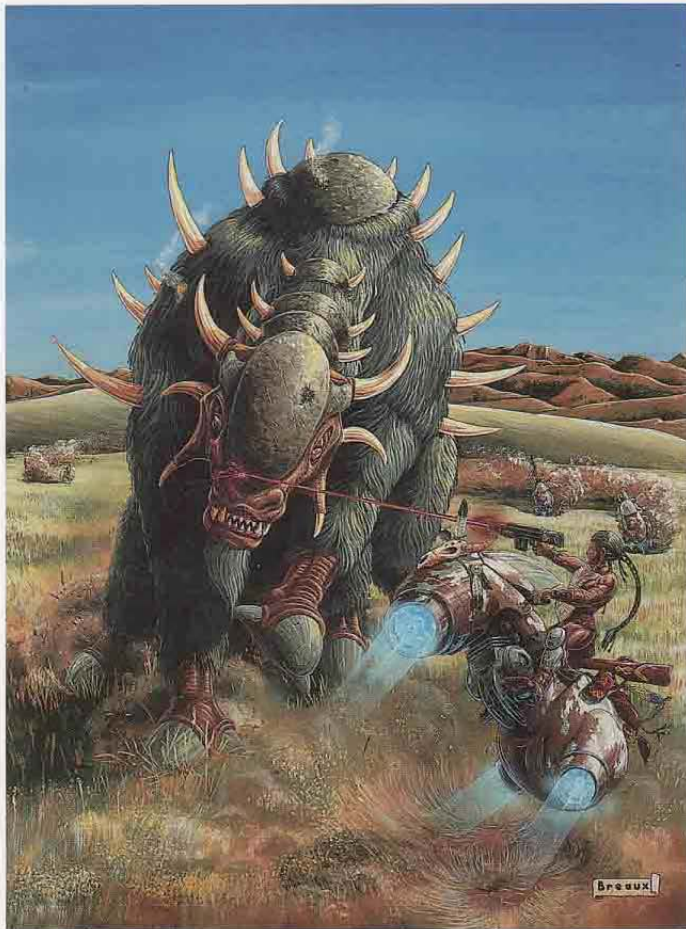

Available at stores everywhere

Also from Palladium Books®

## Rifts® Spirit West™

While the White Man wars with D-bees, sorcerers and his brothers in the East, the Red Man is quietly building new nations in the west and walking with ancient gods.

- Indian warriors, spirits, gods and mysticism.
- Spirit magic, animal totems, fetishes, & beliefs.
- 11 new O.C.C.s, including Mystics, Shaman and Totem Warriors.
- Ancient Indians gods and spirits have returned.
- Plus high-tech weapons, armor, vehicles and equipment.
- Maps, Indian nations, world information and adventure ideas.
- Written by Wayne Breaux Jr. with Kevin Siembieda.
- 224 pages.

## Rifts® Sourcebook 4:

### Coalition Navy™

This sourcebook fits in with Rifts® Lone Star and Coalition War Campaign®. It takes an in depth look at the fledgling Coalition Navy (located in Lone Star/Texas) and which can be found up and down the Mississippi River, the Great Lakes and the Gulf of Mexico.

- CS Naval Officers, ranks and objectives
- CS warships, submarines, patrol boats, power armor and lots of cool equipment.
- Key bases, commanders, and operations.
- Maps, world information and adventure ideas.
- Written by Patrick Nowak with Kevin Siembieda.
- 120 pages

## Rifts® 14: New West™

At last, the Western Wilderness (a no man's zone forbidden to citizens of the CS) is outlined and explored.

- Over 20 O.C.C.s and R.C.C. including the Lawman, Gambler, Gunfighter, Bounty Hunter, Psi-Slinger, Wired Gunslinger, Saddle Tramp, Fennodi, Sky-Knights, and Cloudweavers.
- Techno-Wizard magic that turns ordinary gunpowder weapons into mega-damage weapons.
- Wilk's and Bandito Arms and a new array of special weapons.
- "The Law" — or what passes for it.
- Notable bandits, outlaws, Cyber-Knights and D-bees.
- Notable towns, villages, badlands and world information.
- Overview of the New West, maps and adventure ideas.
- Written by Kevin Siembieda and Chris Kornmann.
- \* Over 200 pages!

\$20.95

Cat. No. 826

I.S.B.N. 157457-001-3

ISBN 1-57457-001-3



9 781574 570014