

Palladium Books® Presents:

# The Compendium of Contemporary Weapons™

By Maryann Siembieda



ZELEZNIK  
1 9 9 3

# Warning!

This book may be inappropriate for young readers.

The **Compendium of Contemporary Weapons** is both a historical and modern reference book. It is an illustrated guide to modern weapons, combat vehicles, equipment and accessories as used by military and law enforcement agencies throughout the world. It is a sourcebook designed for use with role-playing games set in a modern, post modern or military settings.

This book is NOT an instruction manual. It does not teach the reader on how to build, manufacture, modify, purchase or use small arms.

It is not a survivalist's handbook nor meant to be a pro- civil arms statement. None of us at Palladium Books condone or encourage the use of firearms or violence.

Some parents may find a book detailing firearms as inappropriate for young readers/players. We suggest parental discretion.

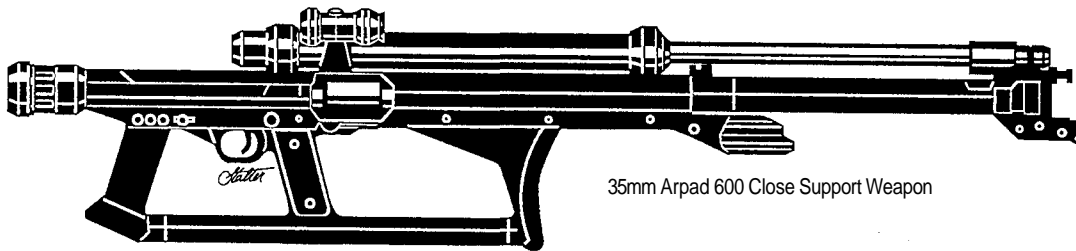

35mm Arpad 600 Close Support Weapon

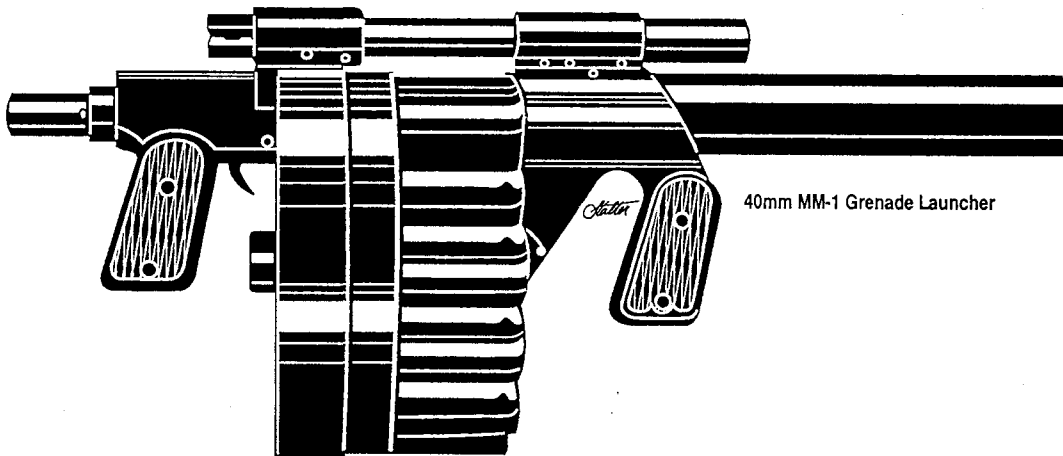

40mm MM-1 Grenade Launcher

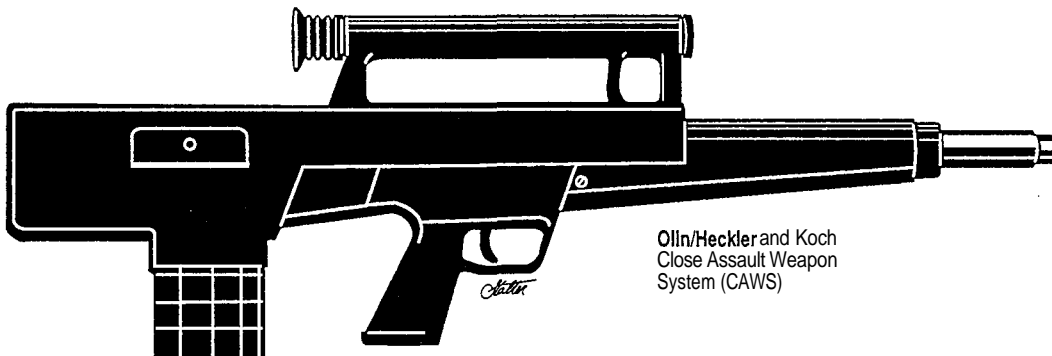

Olin/Heckler and Koch  
Close Assault Weapon  
System (CAWS)

For use with ANY role-playing game.

Compatible with RECON®, Heroes Unlimited™, Ninjas & Super spies™, Beyond the Supernatural™ and the entire Palladium Books® Megaverse®.

**Dedicated to My Father**, I wish you could see how it all turned out. **And to Dad** for being there, even when he didn't want to be. I love you both.

## Warning

This book contains new and original works of art that are **protected by Federal Copyright Law**. NO artwork may be printed or published in any form, for any reason, without *written permission* from the publisher of Palladium Books Inc. The use of this artwork, in any product not produced by Palladium Books is a Federal **crime! Offenders will be pursued in Federal Court.**

**Third Printing - May, 1999**

Copyright © 1984 & 1993 Kevin Siembieda.

All rights reserved under the Universal Copyright **Convention**. No part of this book may be reproduced in part or whole, in any form or by any means, without permission from the publisher, except for brief quotes for use in reviews. All incidents, situations, institutions, governments and people are fictional and any **similarity**, without satiric intent, of characters or persons living or dead, is strictly **coincidental**.

Palladium Books, Rifts and **Megaverse** are all registered trademarks owned & licensed by Kevin Siembieda.

**The Compendium of Contemporary Weapons™** is published by Palladium Books® Inc., 12455 Universal Drive, Taylor, MI 48180. Printed in the USA.

Palladium Books Presents:

## The Compendium of

# Contemporary Weapons™

Written By: **Maryann Siembieda**

Additional Writing By: **Matthew Balent**  
**Kevin Siembieda**

Research & Compiling: **Maryann Siembieda**  
**Kevin Siembieda**  
**Brian Siembieda**  
**Matthew Balent**  
**Alex Marciniszyn**

Senior Editor: **Alex Marciniszyn**

Editors: **Thomas Bartold**  
**James A. Osten**

Cover Painting: **John Zeleznik**

Interior Art: **Steven Stalter**  
**Kevin Siembieda**  
**Wayne Breaux**  
**Roger Peterson**  
**Thomas Miller**

Art Direction & Keylining: **Kevin Siembieda**

Typography: **Maryann Siembieda**

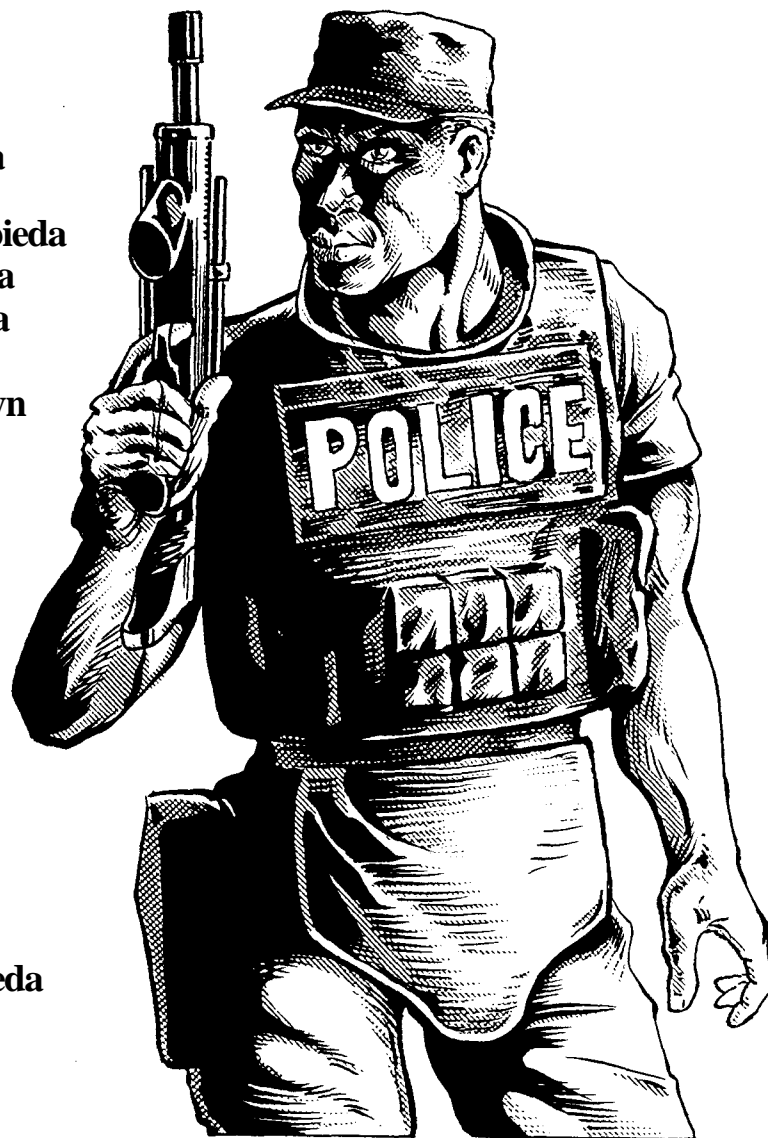

*K. SIEMBIEDA 1993*

**Special Thanks** to Steve Stalter who did an outstanding job on his portion of the weapon artwork. Wayne Breaux, Roger Peterson and George Evans for jumping in on short notice to help on the art. Lastly, I must thank my hard working wife, Maryann, who put a year of research and work into this monster of a book. (And Kevin who kept telling me I could do it).

# Contents

	Page
Guidelines for using the Contemporary Weapons Book . . . . .	5
Abbreviations and Terms . . . . .	6
Modern Ammunition . . . . .	6
How a Bullet Wounds . . . . .	6
Combat Ammunition . . . . .	7
Illustration of Combat Bullets . . . . .	8
Ammunition Damage & Penetration Tables . . . . .	9
Special Cartridges, Bonuses & Penalties . . . . .	11
Weapon Prices in an RPG Setting . . . . .	12
Firearms & Damage in RPGs . . . . .	14
Shock . . . . .	15
Blood Loss . . . . .	16
Hit Location, Damage & Penalties . . . . .	16
Random Hit Location Table . . . . .	17
Damage at Point-Blank Range . . . . .	18
Average Damage Levels of Bullets . . . . .	18
Palladium's Combat System for Modern Weapons . . . . .	19
Body Armor . . . . .	20
Body Armor Classes . . . . .	21
Riot Control Devices . . . . .	31
EOD Equipment . . . . .	35
Revolvers & Pistols . . . . .	37
France . . . . .	43
Germany . . . . .	44
Old USSR . . . . .	55
United Kingdom . . . . .	56
USA . . . . .	57
Rifles . . . . .	61
Germany . . . . .	68
Old USSR . . . . .	75
United Kingdom . . . . .	76
USA . . . . .	79
Rifle Accessories . . . . .	83
Shotguns . . . . .	85
Sub-machineguns . . . . .	88
France . . . . .	92
Germany . . . . .	93
Old USSR . . . . .	98
United Kingdom . . . . .	99
USA . . . . .	100
Machine Guns . . . . .	102
Combat Hand Grenades . . . . .	109
Light Support Weapons . . . . .	112
Flamethrowers . . . . .	112
Grenade & Rocket Launchers . . . . .	114
Special Support Weapons & Anti-Tank . . . . .	123
Anti-Aircraft . . . . .	141
Mortars . . . . .	142
Pyrotechnics . . . . .	145
Surveillance Equipment . . . . .	149
Sighting Equipment . . . . .	151
Tanks & Armored Vehicles . . . . .	156
Bibliography . . . . .	169
Index . . . . .	170

# Guidelines for using the Contemporary Weapons Book

**First**, this is not a game system! This is a guidebook to contemporary weapons for use in ANY role-playing game. The basic information and guidelines may have to be adjusted to reflect each individual system of **rules**, but are presented in such a way that this should be a quick and easy **procedure**.

**Second**, we do not even pretend to have included all of the types and variations of firearms in the world. We **have** tried to include "most" weapons that are *representative* of the major types of small arms available today. Consequently, we have intentionally limited the firearms in this book to weapons manufactured after 1930 or still commonly used (like the Browning and Colt which were produced around the turn of the **century**, but are still popular **today**).

**Third**, the statistical data listed is meant to provide subjective guidelines for use in role-playing games. They are as accurate as we believe necessary. Those of you who are familiar with our previous weapon books know we strive to achieve maximum accuracy and authenticity. However, this is especially difficult with firearms. Everybody who has ever fired a gun (or even reads about them) seems to have a different opinion. Even the experts disagree about each weapon's effectiveness, damage capability, penetration, range and maintenance. Even among Palladium Books **researchers**, one felt automatic weapons were superior to revolvers, while another leaned toward revolvers. Each had sound, logical reasons, statistics and personal experience to support their arguments. One even disagreed with the effective ranges as listed in **Jane's Infantry Weapons** book, which is generally acknowledged as the definitive book on the subject. It really broke down to personal preference, experience and opinion.

**Fourth**, the tissue damage ratings and penetration ratings are **NOT** meant to accurately reflect the damage in the real world, but a reasonable translation into game standards.

**Fifth**, we chose line illustrations over photographs to provide a maximum amount of detail as clearly as possible. Great effort went into the accurate portrayal of the **weapons**, vehicles and accessories. Each illustration has been painstakingly researched. One of our illustrators even works for the **Browning Company**.

**Sixth**, heavy weapons and vehicles such as anti-tank weapons, grenades, rocket launchers, flamethrowers, light artillery, armored vehicles and other items are given comparatively limited coverage. They are included to give the reader some idea of the different types of larger and heavier weapons and vehicles available. Furthermore, when Palladium's small, original weapon

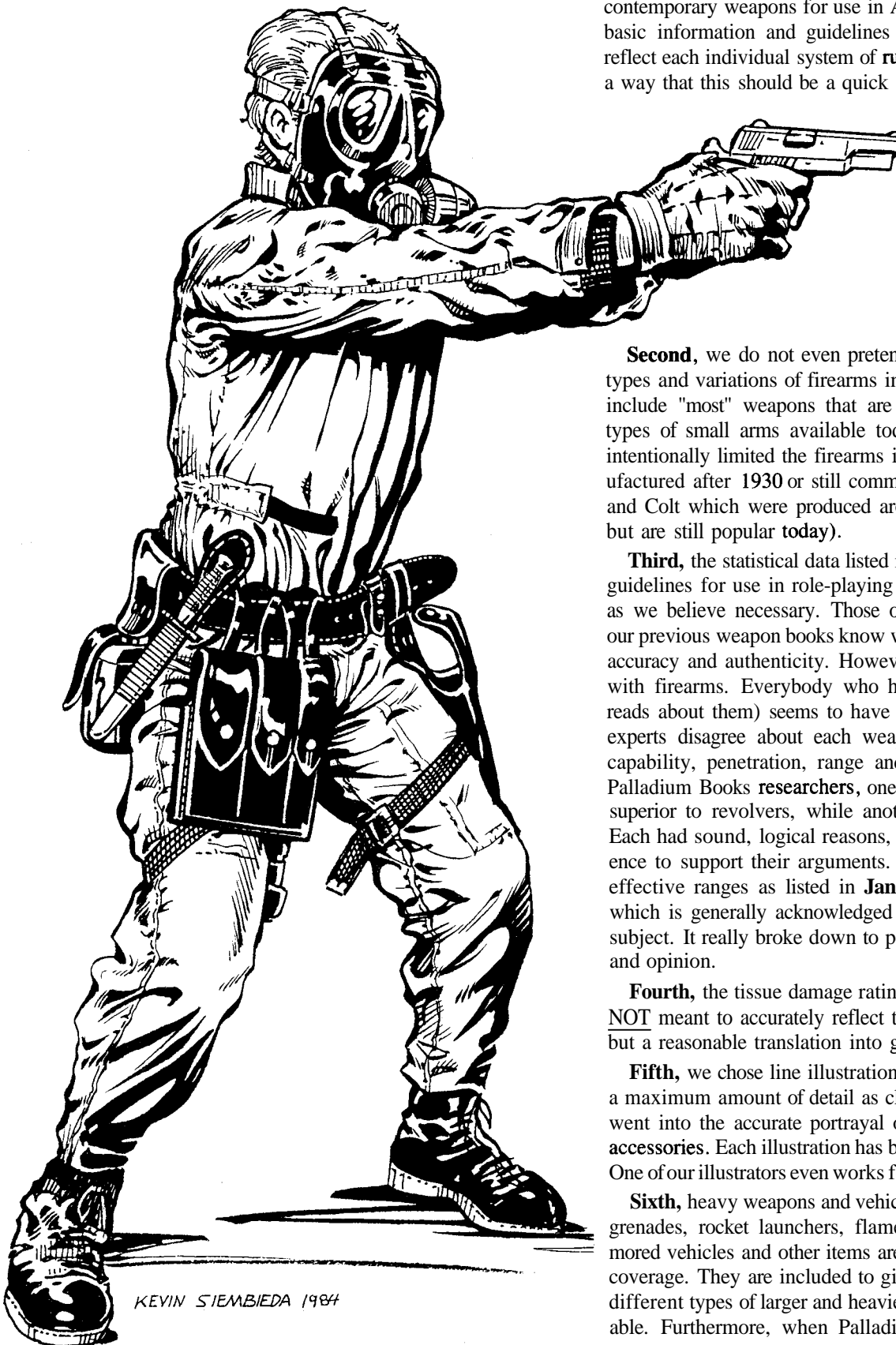

book was sold, many readers asked for at least some basic coverage in these areas. We aim to please, so they are included.

**Seventh**, all the weapons in this book are real. There are no fictional laser rifles or energy guns.

**Eighth**, this book is in no way intended as a guide for survivalist or pro-civil arms movements. Although the weapons are real, this book does not encourage their use by civilians.

---

## Abbreviations and Terms

---

**Approximate Effective Range:** This is the generally accepted maximum range in which the weapon is considered to operate most effectively and accurately. Typically, a round/bullet can be fired at 10% to 20% farther than the effective range, but the shooter should have dramatic penalties or modifiers to strike. For the **Palladium Game System**, we'd suggest a -6 to strike and is equal to shooting wild.

**Barrel Length:** This is only the length of the barrel. The overall length, when it is known, is listed in parenthesis after the barrel length.

**Belt Feed:** A system of supplying ammunition to a machine gun in the form of a continuous belt. One common type of belt feed is the disintegrating link, which consists of independent clips that fall away after the round/bullet is fired.

**Bolt Action:** Used mainly in older rifles and hunting type rifles. By pulling back the "bolt," a spent shell casing is ejected from the breech. A spring-loaded mechanism then snaps the bolt forward, closing the breech and a fresh round/cartridge/bullet is moved into firing position.

**Bullet:** The common term for ammunition/cartridge/round fired from a weapon.

**Caliber:** The internal diameter of a weapon's barrel. The American and British usage of caliber is expressed in hundredths or thousandths of an inch and typically written as a decimal fraction; eg. .357, .45, .22 caliber, etc. Others are expressed in millimeters; eg. 9 mm, 7.65 mm, and so on.

**Cartridge:** Type of round/bullet; ammunition.

**Clips:** Metal grips which hold the cartridge by the rim or base, which is then inserted into the magazine, forming part of the magazine mechanism.

**Damage:** The typical amount of damage inflicted by a round/bullet. It does not take into consideration special cartridges, or internal damage, blood loss and shock to the human body.

**Feed:** Method by which the cartridge enters/feeds into the weapon.

**F.N.:** A reference to the weapons manufacturer, **Fabrique Nationale d'Armes de Guerre** of Belgium.

**Length:** "mm" means metric millimeters.

**Magazine:** The compartment which holds ammunition and is directly inserted into the weapon; typical of automatic weapons.

**Muzzle Velocity:** "m/s" indicates the meters per second the cartridge is traveling when it leaves the muzzle of the weapon.

**Penetration Value (P.V.):** The penetration of a round/bullet through materials other than soft flesh and cloth. The higher the number, the greater the penetration.

**Rounds:** The number of cartridges/bullets/rounds held inside the weapon and/or weapon cartridge; i.e., seven rounds means seven bullets/cartridges are contained in that weapon when

fully loaded. Seven bullets/cartridges/rounds can be fired from that loaded weapon. 13 rounds means it contains 13 bullets, 30 rounds means 30 bullets, and so on.

Weight: "gm" means metric grams; "kg" means kilograms.

## Modern Ammunition

By Matthew Balent

The easiest way to categorize firearm ammunition is by its intended purpose, i.e., target shooting, hunting, or combat. Although there can obviously be overlap between all of these categories, there is no 'universal round' which excels in all. In most cases, a seasoned shooter will choose ammunition based on what type of situation he feels he is most likely to encounter in the field.

### The Modern Cartridge

Virtually all modern firearms fire metallic centerfire cartridges (although the .22 uses a rimfire design). The metallic cartridge design originated in France in 1845 as a way to contain bullet, powder, and primer in a single unit. Originally the design was rimfire, meaning the primer (fulminate of mercury) is contained around the rim of the cartridge. The primer ignites when struck by the weapon's hammer or firing pin.

The next revolutionary step in cartridge design came in the 1860's when the primer was placed in a small, separate unit pressed into the center of the base. With this design, much more powerful cartridges could be developed.

In its basic form, the cartridge consists of the following parts:

**Primer:** Contained in a small metal cap which is pressed into the base of the cartridge case. When struck by the firing pin it ignites and sets off the charge.

**Case:** The metal (generally brass) tube which holds the powder and is capped by the bullet.

**Charge:** This is what propels the bullet. Normally comprised of nitro-cellulose/nitro-glycerine propellants.

**Slug:** The bullet. It is held in place by crimping the neck of the case.

### Firearm Techno-babble

If you read any in-depth study of bullet performance (or any of innumerable magazine articles) you will certainly come across an array of terms designed to quantify, measure and compare. Many of these are used only to support the author's own particular point of view. In game terms, however, these are irrelevant. If you are seriously interested, most ammunition manufacturers (such as Winchester) publish statistics on their products, including data on bullet weight, muzzle energy, trajectory, velocities at various points, etc. You can also get data on penetration capabilities, TKO (Taylor Knock Out) factors, expansion characteristics, and a lot of other stuff from reading any of the countless books, magazines and articles on the subject.

### How a Bullet Wounds

A bullet wounds a target in two ways, penetration and disruption. Penetration is perhaps the most obvious form as this involves the bullet passing through the target. As it does so, it punctures and tears whatever is in its way. If a vital organ, bone, or blood vessel is hit, serious damage can result.

The more devastating effect of a bullet is the disruption it causes in tissue near its point of penetration and path of travel. The primary cause of this tissue disruption is hydrostatic shock. Since most animals are comprised of tissue which is primarily water, and since water is something which cannot *be* compressed (that's why they use it in 'hydraulics'), as a bullet impacts on a target, some of the energy propelling it is transferred to that target. This energy travels through the body as a *pressure wave*, rupturing and tearing surrounding tissue. See the section on shock and blood loss for specific role-playing game damage, penalties and considerations.

## Target Ammunition

Target ammo, at least cartridges used in competition, is manufactured to very exacting standards and is normally used only in the specialized rifles and pistols suited for that purpose. In almost every instance, the bullet type is **ball**. Ball ammunition is what one might consider a 'normal' bullet. Generally it consists of a lead slug, covered with either a metal jacket or copper coating, with a rounded or pointed nose. Competition ammo most commonly is made for .22 caliber and is much more expensive than standard ammunition. Note: Tissue Damage: 1, P.V.: 1.

A second type of target ammunition is the **wadcutter**. Designed primarily for pistols, the wadcutter bullet has a flat nose to cut clean holes in paper targets. This property, however, is also desirable for defense as it cuts a large 'wound channel' in a human target, resulting in rapid blood loss. There is a trade-off though, as these bullets do not penetrate as deeply as others and tend to jam in automatic weapons. Note: Tissue Damage: 2 or 3 depending on the caliber of the cartridge, P.V.: 1, regardless of caliber.

## Hunting Ammunition

Hunting ammo varies depending on the intended animal to be hunted. Rounds intended for use on 'varmints' (like the .22 caliber rifle) are not suited for large animals like bear, elk, or deer. Hunting bullets are primarily designed to expand in their targets, either upon impact or somewhat after penetration. Hunting ammunition is also manufactured to exacting standards to achieve consistent results from round to round.

Some hunters prefer rapid bullet expansion or fragmentation on impact for instant stopping power. **Hollow Point and Soft Point** are examples of this type of cartridge.

Larger game requires the bullet to retain more penetration power after impact, so as to break through hide and bone. Examples of these include **Jacketed Soft Point** and **Power Point**. Both of these have metal jackets over the rear of the slug to control bullet expansion. These types of cartridges are available in virtually every common rifle caliber and most pistol calibers as well.

## Combat Ammunition

For combat purposes, the number one consideration in any situation is reliability in all climates and conditions. Additionally, since the Geneva and Hague conventions specify the type of ammunition allowed in conflicts between nations (in a humane desire to inflict as little injury as possible), the normal type of bullet used is ball. This is either a round nosed or spire pointed, fully jacketed, bullet with sufficient weight and power to operate

in a variety of weapons at various ranges. These **full metal jacket** rounds have very good penetration capabilities and, given a sufficiently large caliber, will go through cinder blocks, a foot of soft wood, or a few millimeters of sheet metal. The current NATO caliber of 5.56 X 45mm has much less penetration capability than the older 7.62 x 51mm but does tend to tumble more upon impact, increasing its wounding potential.

In Special Forces (SF) situations, which generally have the least political and moral restraints, the number one consideration for ammunition is stopping power. Special Forces operations normally involve close-range reactive situations where immediate incapacitation of the enemy is needed to prevent hostages or bystanders from being killed. Today, nearly all modern high-tech weapons used for this type of close quarter combat are 9mm caliber. To bring home this point, it is interesting to note that more people in modern times have been killed with 9mm bullets than any other.

The problem with 9mm is that although it does kill, it does not **stop!** Many instances can be examined in police files where criminals have had to be shot numerous times with 9mm bullets before they were stopped.

The 9mm round was designed to operate in reciprocating machines which require a smooth, tapered cartridge with no sharp angles. It must be small enough to fit into a pistol butt but powerful enough to operate a submachine gun. The 9mm **Parabellum** fits all of these requirements but because of the bullet's shape, weight, and velocity, tends to go right through its intended target; not a good characteristic of a round with stopping power.

There are generally five ways to increase the stopping power of a cartridge. These are: increase bullet size, use a bullet which creates a large wound channel, use bullets designed to expand on impact, increase bullet 'break up' (frangibility), and raise the kinetic energy of the round by decreasing its weight and increasing its velocity.

Increased bullet size is generally not an accepted solution in Special Forces situations since it normally requires a switch to the .45 caliber which causes serious resupply problems in the field and a severely restricted choice of weapons (at least in **sub-machineguns**).

The **semi-wadcutter** cartridge was developed to increase the bullet's wound channel (the wound does not close behind the bullet, causing greater blood loss). The semi-wadcutter has a slightly tapered tip with a blunt nose. Unfortunately, the blunt tip of these cartridges cause an unacceptably high percentage of **misfeeds/jams**, which can be fatal in a close combat situation.

**Expanding bullets**, like the hollow or soft points, are designed to open up or 'peel open' on impact, thus increasing their diameter sufficiently to stop within the target. As mentioned above, these types are used extensively in hunting rounds designed for rifles. Unfortunately, in pistol cartridges the velocity is often too low to guarantee bullet expansion. Some lightweight, high-velocity hollow points have been developed but their jackets are often so thin that they break up if they impact on any hard surface such as a wallet or military kit and do little damage to the true target.

**Fragmenting bullets** are also likely to break up like the hollow points when they strike a solid obstacle. They commonly have



# Combat Bullet Tips

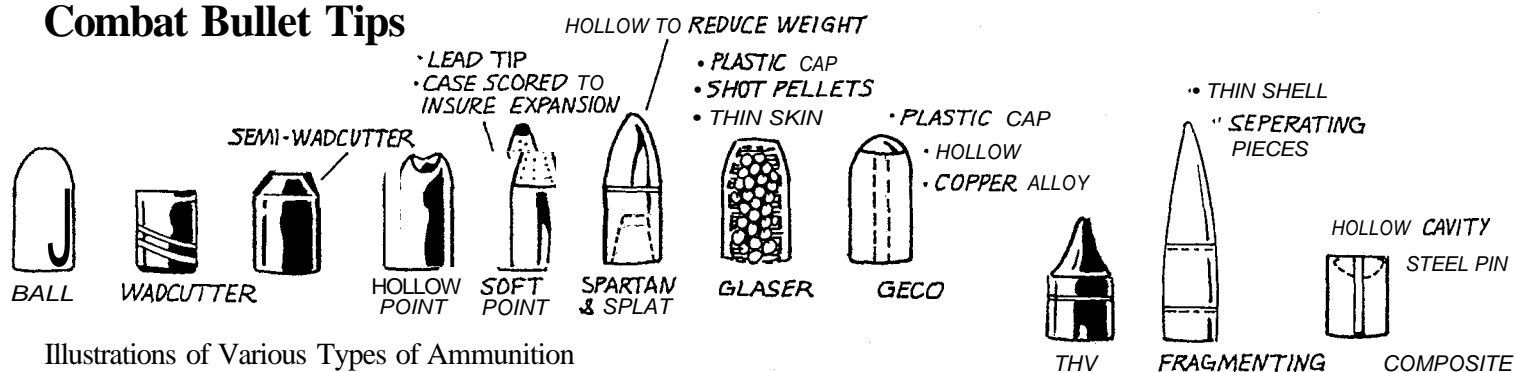

Illustrations of Various Types of Ammunition

a two or three part bullet which either separates in flight due to air resistance or after hitting any obstacle in their path.

The final method, that of increasing the kinetic energy of the bullet, proved to be the most effective round in the original quest to improve stopping power. Known as **Plus P rounds**, the charge is increased while the bullet weight is decreased. The lighter projectile tends to stop quicker, thereby transferring more of its energy to the target.

The success of these rounds caused the various ballistic experts to attempt to perfect other high kinetic energy transfer rounds. This would lead to what are now known as 'fourth generation rounds' and are basically of two types: frangible and 'accelerated energy transfer' or AET.

**Of the frangible rounds** there are three main examples: Glaser, Spartan, and Splat.

**The Glaser** round consists of number 12 shot pellets encapsulated in a thin metal jacket with a plastic cap to seal them in. It is fired at around 550 meters per second and when it hits an uneven or semi-liquid medium the cap fractures, spilling the shot out of the bullet. The shot transfers the energy into the target some eight times faster than if the bullet had remained intact. This speed of energy transfer causes massive systemic shock and stops the subject almost instantly. It is said that 87% of people shot with small arms survive but over 90% of those shot with Glaser have died.

The round does have some drawbacks however. The first is cost: between three and five dollars a bullet, even though they are available in virtually every caliber from .22 to 7.62 X 39mm. The second problem is that if a hostage is accidentally hit, they are dead! The final problem (and most important) is that the bullet is totally defeated by any angled cover; it has virtually no capacity to penetrate doors, windshields, or wallboard!

**The Spartan** round was initially designed for training purposes. It is made of lead dust and a polymer mix pressure molded into the required shape. It is designed to break up on impact and not penetrate too deeply. Since it does contain lead (which is very heavy), however, there are limitations as to the velocity of the bullet which limits its stopping power. It also has the drawback of having little penetration capabilities.

**The Splat** round is derivative of the Spartan, being constructed of a metal and polymer mix. The metal content, however, is non-lead and designed to give velocities in excess of 550 meters per second. These rounds are also molded with a profile designed

to allow it to penetrate medium cover without breaking up until it exits the far side. These rounds are also much more affordable, retailing for pretty much the same as a standard round.

The first effective **AET round** was developed for .38 revolvers and basically was a hollow based wad-cutter loaded into the case upside down. The expansion properties of these rounds were very high. In an attempt to control the rate of expansion and thereby improve the penetration, a steel pin was pressed into the center of the hollow. These **AET composite** rounds tended to give the effect of two projectiles, one of lead which expanded and stopped rapidly and the other of steel with excellent penetration. These rounds do have problems with reliable feeding/jamming in automatic weapons.

Another type of **AET round** was developed in Germany and is referred to as the **Geco**. It is a totally hollow, copper alloy bullet with a plastic core and cap which falls away shortly after being fired. Its design makes it tumble upon impact, causing a high level of tissue damage. These rounds also have very good penetration capabilities, even when shot through plywood or wallboard.

**The Equalloy** round was developed in England for use in revolvers. The bullet is made of aluminum alloy and is about twice as long as a standard round. To insure a good seal and to prevent aluminum from depositing inside the gun barrel, a nylon coating is used. Even with velocities of over 625 meters per second the bullet will stop in 3.5 inches of ordnance gelatin (a human tissue substitute).

Current development has produced a totally new type of round called the THV. The design employs a "reverse ogive" shape where the front section of the bullet is concave rather than convex. This causes the round to have the same effect on the target as a 'belly flop' does on a diver. These rounds are very high velocity (over 750 meters per second), have good armor penetration capabilities, low ricochet potential, and low recoil.

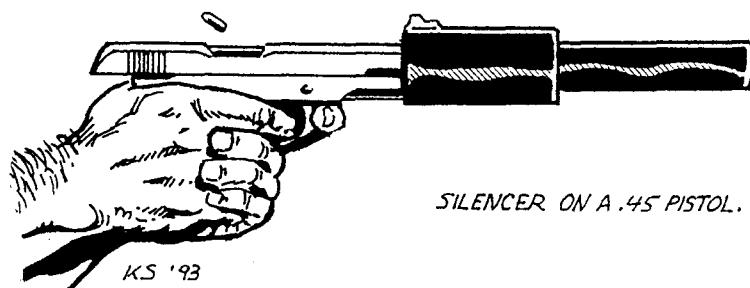

SILENCER ON A .45 PISTOL.

# Ammunition Damage & Penetration Tables

## Penetration Values

Penetration Values (P.V.) apply to the penetration of a **round/bullet** through materials other than soft flesh and clothes. The higher the number, the greater the penetration.

### Penetration Values (P.V.)

1. Poor: Deflects off bone
2. Fair: Deflects off **bone**.
3. Adequate: May lodge in bone
4. Good: May break bone
5. Very good: Shatters bone, wood, goes through cinderblock.
6. Excellent: Shatters bone, wood, goes through 1/4 inch armor plate steel.
7. Superior (.50 caliber): Goes through brick, thin metal.

## Tissue Damage Rating

The major factor in determining combat damage from any firearm is the type (size/caliber) of the **round/bullet** it **fires**. To keep damage reference quick and **easy**, we are attributing damage to the **cartridge/round/bullet**, rather than each type of individual weapon.

One may argue that the specific features of each particular firearm may add to its effectiveness and damage capabilities. This can be true. However, the various features and construction elements of a weapon are more likely to attribute to its effective range, accuracy, durability, reliability, weight, number of rounds **fired**, and similar elements rather than the **damage**. For Example: Generally speaking, a typical .45 caliber bullet will inflict approximately the same damage when fired from any .45 caliber revolver, regardless of its age, the manufacturer, or its styling. All .45 caliber revolvers have the necessary features, size and construction needed to fire a .45 caliber round. This is true of most firearms.

Attributing the damage to the **round/bullet**, also enables us to take into account special cartridges such as **dum dums** and armor piercing rounds.

The tissue damage indicates the suggested amount of damage caused by a particular weapon. This is by no means a definitive evaluation of its effectiveness in the real world. However, it is what we believe to be an acceptable translation to the weapon's effectiveness for fictional role-playing games. Those of you who have firsthand knowledge of firearms and believe otherwise, are free to adjust these ratings as you see fit. Game Masters, you should not be intimidated by a player who swears that these ratings are not accurate. If you are comfortable with them, then stick to the table or do some research to confirm them (see **bibliography**). The authors of this book are confident that the rating system is a fair and reasonable adaptation.

The damage numbers indicate the direct damage to the body by the **round/bullet** itself. It does not take into consideration shock, blood loss, damage to internal organs or other factors. See the sections on optional **damage**, blood loss and hit **location**.

The lowest number on this chart is the number one (1). It symbolizes the least effective and least damaging **round/bullet**. However a bullet with a rating of one does meet the requirements

for basic **self-defense**. Typically, this is a small caliber cartridge such as a .22 caliber bullet. The higher the number, the greater the damage.

The damage is presented in increments of dice **rolls**. This is a *suggested* damage value that should work for most role-playing games. It may be necessary to adjust the damage up or down for a particular **game**.

The cartridges listed are considered the most common and universally used.

### General Damage Ratings

1. Barely Adequate
2. Fair
3. Good
4. Very Good
5. Excellent
6. Very Excellent
7. Superior
8. Light Machine Gun
9. Heavy Machine Gun
10. Heavier Caliber Machine Gun

### Tissue Damage

1. Barely Adequate	1D6
2. Fair	1D8
3. Good	2D6
4. Very Good	3D6
5. Excellent	4D6
6. Very Excellent	5D6
7. Superior	6D6
8. Light Machine Gun	1D4 × 10
9. Heavy Machine Gun	1D6 × 10
10. Heavier Caliber Machine Gun	1D6 × 10 + 10

(Both 9 and 10 will shoot through a car engine block)

## Damage Ratings By Cartridge Type

- Almost all auto shells are jacketed to inhibit expansion.
- The number in parentheses is the tissue damage ranking on a 1-10 scale, with one inflicting the least damage and ten inflicting the most.
- **P.V.** represents the **Penetration Value**. The higher the number the better. Also see the description for Penetration Value and the section on damage and blood loss.

## Revolvers: Caliber Cartridges & Damage

- (1) **.22 Short, P.V. 1:** Very little penetration. Little or no nerve trauma.
- (2) **.22 Long, P.V. 1:** Slightly more powerful than the .22 short and the .25 (especially in long barreled **guns**). Better expansion properties of bullet results in greater tissue and nerve trauma. Penetration is poor due to the soft mushrooming of the bullet which tends to disintegrate on heavy bone.
- (3) **.22 Long Rifle, P.V. 2:** When used as a rifle round, the performance of this cartridge enjoys increased penetration.
  - (1) **.25 A.C.P. (6.35 mm), P.V. 1:** (Note: A.C.P. stands for Automatic Colt Pistol). Adequate for self-defense if shots are placed in the face, head, neck or body areas with no bones to deflect the small projectile, adequate penetration.
  - (2) **.32 A.C.P. (7.65 mm), P.V. 3:** Fair to good protection when used in a high capacity automatic. Decent penetration with little or no expansion, typical of the jacketed projectiles used in automatics.
  - (2) **.32 Long (7.65 mm), P.V. 4:** (Revolver) Better velocity and penetration. More variety of loads increase its deadliness.

- (3) **.38 Special, P.V. 4:** A good self-defense cartridge with good offensive capabilities.
- (4) **.38 (Power), P.V. 5:** More power than the standard .38 with better expansion and penetration.
- (5) **.357 Magnum, P.V. 5:** An excellent choice for offense and defense. This cartridge produces great amounts of tissue damage, has excellent stopping power, and has great penetration, even when using hollow point rounds. An excellent hunting round. The weapon itself has been found to be an easier handgun to use than the 9mm, .45 auto., .41 Magnum and .44 Magnum for both men and women.
- (5) **.45 A.C.P., P.V. 4:** Introduced in 1911, this shell has proven itself to be a man-stopper. This cartridge was created to be used against human adversaries and has little or no hunting value. A wide wound channel is caused by this wide, heavy, cartridge resulting in severe nerve trauma (shock).
- (5) **.45 Long, P.V. 5:** Rates the same as the .45 A.C.P., but has better penetration.
- (5) **.41 Magnum, P.V. 6:** High velocity, excellent penetration, a very good man-stopper, and fine hunting round. Despite this, the cartridge has never been very popular; the .357 and .44 magnum are in much greater demand.
- (6) **.44 Magnum, P.V. 6:** An excellent handgun cartridge. The large, heavy slug does large amounts of damage to tissue and bone. It has great penetration and stopping power. Even if a person were only wounded, the damage inflicted would severely hamper any retaliation (this is also true with the .357 and .41 Magnum, but to a lesser degree). A very good hunting cartridge.

---

## Automatic Pistols: Millimeter Cartridges & Damage

---

- (1) **5.45mm, P.V. 1:** Poor stopping power, with poor to good accuracy.
- (2) **7.62mm Nagant, P.V. 1:** A service round used by the former Soviet countries and in gas-seal target revolvers.
- (2) **7.63mm Mauser, P.V. 2:** Standard old U.S.S.R. pistol and sub-machine gun round, under the name of 7.62 Tokarev.
- (3) **7.62mm Parabellum, P.V. 2:** Used by central European police and security forces. Not currently in first line service with any army.
- (3) **7.65mm Long, P.V. 3:** Unique to French forces. Comparable in power to the contemporary 9mm Browning long cartridge. (The Browning being the world standard for pocket pistols).
- (2) **9mm Short, P.V. 4:** Used in U.S. and in central Europe. This cartridge has reasonable stopping power with a low velocity which reduces the risk of ricochet.
- (3) **9mm Standard, P.V. 5:** Used by many armies, this cartridge may one day replace the venerable .45 Colt in the U.S. Army because of its better penetration of body armor. Yet, since it does not expand (like all autos), it does not inflict the trauma effect that the fat, stubby .45 round does traveling at a slower speed.
- (3) **9mm Police, P.V. 4:** Used by several European police forces.
- (3) **9mm Makarov, P.V. 4:** Not yet made outside the former Soviet countries. For use with the Makarov pistol.
- (4) **10mm Colt, P.V. 5:** Used in the U.S. and in Central Europe. This cartridge has good stopping power and penetration. Fairly recent.

---

## Rifle Cartridges & Damage

---

- (4) **.256 Mannlicher-Carcano, P.V. 4:** It is doubtful that any of the rifles for which this cartridge was designed are in service. It was used by the Italian military.
- (7) **.223 Armalite, P.V. 6:** Used in the M-16 in the late 1960's and later adopted by the U.S. Army in Europe.
- (6) **5.45mm Soviet, P.V. 6:** For use with the AK-47 Rifle from the old U.S.S.R.
- (5) **7.62mm Soviet Model 1943, P.V. 5:** Standard infantry cartridge of the former Soviet countries. It is in widespread use by third world countries.
- (6) **7.62mm NATO, P.V. 6:** Comparable in performance to the .30-06, but in a shorter case. A long range sniper-type shell.
- (5) **7.62mm Czechoslovak M 1952, P.V. 4:** Adopted in 1952 for use in the Czechoslovakian assault rifle. Abandoned in the early 1960's.
- (5) **7.62mm Mosin-Nagant, P.V. 4:** Still in service with the former Soviets and other countries, eg., Finland and China.
- (5) **7mm Spanish Mauser, P.V. 5:** No longer used in first line weapons. Still serves in several countries with police and security forces.
- (5) **7mm Medium, P.V. 5:** An odd cartridge which has not sold well and may soon go out of production.
- (6) **7.5mm French MAS, P.V. 6:** Used by the French army and ex-French possessions.
- (6) **7.5mm Swiss, P.V. 6:** Standard Swiss round.
- (5) **.30-06 Caliber Springfield, P.V. 6:** A widely distributed cartridge.
- (4) **.30 Caliber Carbine, P.V. 4:** Originally developed for the U.S. carbine M-1. A moderately effective, short range cartridge.
- (5) **7.65mm Argentine Mauser, P.V. 5:** Widely adopted in South America. It is also used elsewhere in the world.
- (5) **.303 British, P.V. 5:** Standard British and Imperial cartridge from 1889 to the 1960's. Best reports indicate that it has never been made in steel-cased form. Excellent range and accuracy.
- (6) **7.92mm Mauser, P.V. 6:** Probably the most widely distributed military rifle cartridge in history.
- (5) **7.92mm Kurtz, P.V. 6:** Used by the East German military for some years after W. W. II. A special steel jacket with dilding metal construction which gives it a semi-armor-piercing effect, eg. penetrates 3-7mm of plate at 100 m.
- (5) **8mm Lebel, P.V. 5:** Developed by France and still in use by former French countries.
- (5) **8mm Mannlicher, P.V. 5:** Until recently, the standard Hungarian round. It is still in reserve use.
- (8) **12.7mm Soviet, P.V. 5:** Used mainly by the former Soviet and satellite countries. The case is usually made of brass, but some small batches made of steel have been found.
- (8) **.50 Caliber Spotting Rifle, P.V. 7:** This bullet is a special design of observing-tracer which carries a spotting charge of incendiary material in the front section so that the strike of the bullet is signaled by a flash and a puff of smoke.
- (8) **.50 Caliber Browning, P.V. 7:** A machine gun cartridge adopted by almost every army outside the Soviet Bloc. Steel-cased cartridges have been made, but brass-cased are the most common.
- (9) **14.5mm Soviet, P.V. 7:** A machine gun cartridge currently manufactured by the former Soviets and China. It is usually

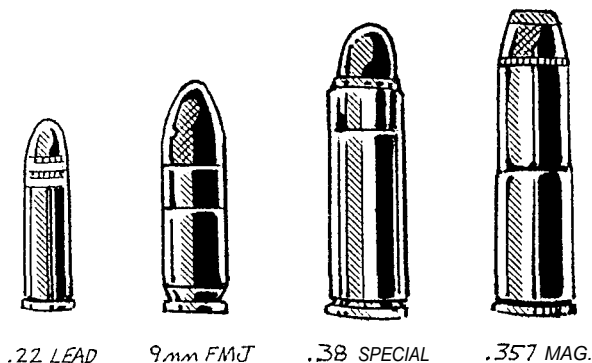

**SOME COMMON FULL SIZE CARTRIDGES**

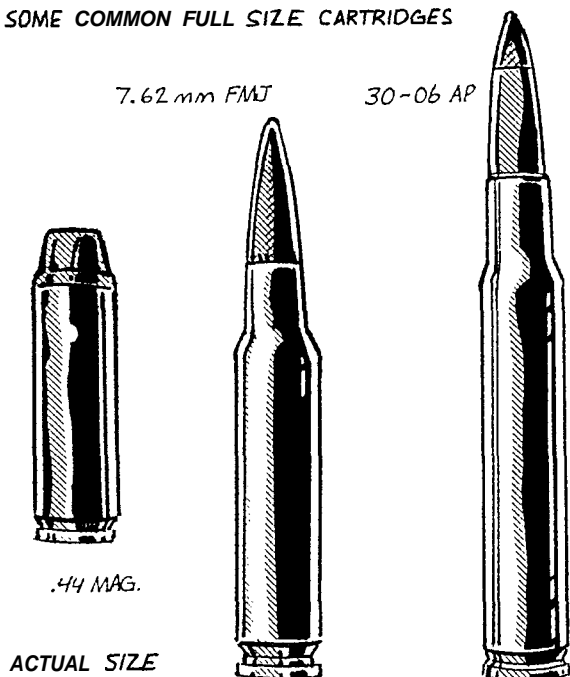

**Special Cartridges, Bonuses & Penalties**

**Dum-Dum:** Normally a pistol or revolver cartridge with crossed marks cut into its tip. This "scoring" enhances the bullet's expansion, damage and stopping power, but reduces penetration. Bonuses & Penalties: + 1 damage rank; P.V. - 1 rank and range is reduced by 15%. Also note that there is a tendency to jam (25%).

**Exploding/Mercury:** Lead nosed bullets, generally pistol, which have a short channel drilled in their tips. A drop of mercury is put into the hole and then it is sealed with a small lead plug. They produce an effect similar to the Glaser rounds but are much less effective. Bonuses & Penalties: + 2 damage ranks and doubles the effects and duration of shock to animals and humans when struck! P.V. - 1 rank (poor regardless of caliber) and reduce range by 10%.

**Frangible AET Composite round (for handguns only):** Bonuses & Penalties: P.V.: + 2 rank bonus to any caliber, plus one damage rank. Range reduced by 10%.

**Frangible AET Geco round (for handguns only):** Bonuses & Penalties: P.V. + 1 rank bonus to any caliber, plus it increases the damage of the round by two damage ranks. Reduce range by 10%.

**Frangible AET Equalloy round (for revolvers only):** Bonuses & Penalties: P.V. + 1 bonus to any caliber, plus it increases the damage of the round by one damage rank. Reduce range by 10%.

**Frangible AET THV round (for handguns only):** Bonuses & Penalties: P.V. + 1 bonus to any caliber, plus it increases the damage of the round by one damage rank and is + 1 to strike. Reduce range by 10%.

**Frangible Glaser round (for handguns only):** Bonuses & Penalties: Double damage and double the effects and duration of shock to animals and humans when struck! But only 1D6 damage to body armor and most other hard structures including glass, plaster, and so on. Reduce range by 5%. P.V.: 1 (poor regardless of caliber).

**Frangible Spartan round (for handguns only):** Bonuses & Penalties: + 1 damage rank to animals and humans. Half damage to hard structures and body armor. P.V. - 1. Reduce range by 10%.

**Frangible Splat round (for handguns only):** Bonuses & Penalties: P.V. + 1 bonus to any caliber, no damage bonus. Reduce range by 10%.

**Hollow Point (handguns, sub-machineguns & rifles only):** Hollow points have the tip of the bullet's lead core exposed and hollowed out like a small bowl. This causes rapid expansion upon impact. If the end of the bullet is clad in metal the bullet will generally mushroom but otherwise remain intact. This causes the round to expand on impact, creating a large wound and greater tissue damage. Bonus and Penalties: Increases a cartridge's damage rating by one (i.e. a round that has a damage rank of 3 becomes 4 and does more damage); P.V.: - 1 rank. Range is reduced by 5%.

**Power Point Fragmentation Round (handguns, sub-machineguns & rifles only):** Bonuses & Penalties: Increases a cartridge's damage rating by one rank. No P.V. bonus. No range penalty.

**Plus-P (handguns or sub-machineguns only):** Bonus and Penalties: Increases a cartridge's damage rating by two ranks, but is -2 P.V. ranks and range is reduced by 5%.

**Soft Point (for handguns, sub-machineguns, and rifles):** Soft points are designed to maintain velocity over long ranges. The lead tip is exposed while the remainder of the slug is clad in metal. Bonuses & Penalties: + 1 damage rank; P.V. - 1 rank and range is reduced by 5%. Also note that there is a tendency to jam (10%).

**Teflon/Armor Piercing (handguns, sub-machineguns, rifles and machineguns):** Generally a standard full metal jacket rounds with a teflon cap which greatly enhances its penetration capabilities. Bonuses & Penalties: P.V. + 2 rank bonus to any caliber, plus it increases the damage of the round by one damage rank and is + 1 to strike. No range penalty.

**Tracer/Incendiary Rounds (rifle and machinegun only):** No bonuses: P.V.: 1, Damage (2): 1D8 regardless of caliber. These rounds have a cavity in the bullet which contains phosphorus or some other smoke/heat producing agent. They are used mainly for night combat to create a visible line that allows for correction of aim. They are most commonly used in automatic rifles (typically the first two or three rounds in a magazine) and machineguns. Normally tracers are loaded in machineguns every 5 or 10 rounds to aid in aiming. Note that the range of a tracer round is reduced by 20%, compared to a normal cartridge.

**Wadcutter (for handguns, sub-machineguns, and rifles):** Bonuses & Penalties: + 1 damage rank; P.V. - 1 rank and range is reduced by 5%.

# Weapon Prices in an RPG Setting

.41 & .44 Ruger "Redhawk" Revolver

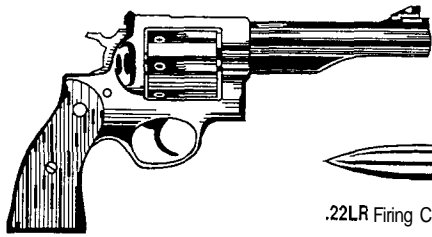

.22LR Firing Combat Knife

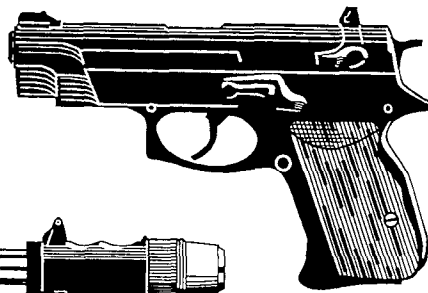

9mm Tanfoglio "Baby" Pistol



Glock 17 9mm Service Pistol

**Handgun** purchasers are supposed to get mandatory training and registration in the United States, Canada and many other countries. The purchaser must also get a permit to "carry" a concealed weapon. **Handguns**, which include a large variety of revolvers and automatic pistols, are considered "concealed weapons" because they are small and can be easily **hidden/concealed**; particularly the smaller caliber revolvers and most **pistols**. These weapons can be concealed in holsters under the arm, on the chest, at the waist, the small of the back, on the hip, at the ankle, **and even in pants or jacket pockets and lady's handbags**.

Automatic pistols, revolvers, hunting rifles and shotguns are available to the **public**. Automatic rifles and machineguns are **not**.

The majority of the heavier weapons listed in this book, including automatic rifles, **sub-machineguns**, machineguns, flamethrowers, rocket launchers and grenades, are not typically available to the average person. Theoretically, they are reserved for the military. The Armed Forces of most countries around the world take great effort to account for each and every weapon and **round/bullet** in their possession. Weapons and ammunition are guarded and kept under lock and key. However, common military type items such as automatic pistols, the AK-47 and **M-16** type automatic weapons are frequently made available through civilian gun shops and **clubs**. Military issued rifles cannot be sold as an **automatic weapon**, so they are modified to become single shot weapons and are sold as hunting, sports or target **rifles**. Individuals knowledgeable in weapons can make modifications that turn these firearms back into deadly automatic weapons. Of course, this does not mean one cannot acquire illegal firearms.

**The black market and smugglers** will frequently sell military issue weapons. Fully automatic rifles, sub-machineguns, even rocket launchers and explosives. In many instances, these weapons are of foreign manufacture and may be "**knock-offs**" — weapons made to look like a particular item but made in another country by an unauthorized manufacturer. In other **cases**, they are stolen goods. These **firearms** are smuggled across the border and sold to interested **parties**. Purchasers may be members of the underworld, terrorists, fanatical **survivalists** and collectors. The price will be average to high. Special weapons, ammunition and rare items may cost many times more. Quantity discounts (10% to 20%) may be available.

**Criminal Street Purchases:** A variety of illegal firearms, especially **handguns**, can be easily acquired from a wide variety of street criminals, from junkies and thieves to drug dealers, assassins and illegal arms dealers/gun runners.

The lower the seller is on the social scale of the streets, the cheaper the weapon's price, but the more likely the weapon is "hot" and/or "dirty" — meaning it is stolen and has been used in 3D6 previous crimes (60% chance it was used in 1D6 shootings, 25% chance it was used in a murder). The individuals who sell these weapons will include junkies (desperate and will steal anything and sell **cheap**), gang **members**, street thugs, muggers, two-bit thieves, and malicious fences and crooked pawn-shop **operators**.

The cost of a weapon from such unscrupulous **low-lives** are likely to be one-third the real market value! However, **RPG** characters will be buying a weapon with a criminal history that could get them in extremely serious trouble if they are caught with such a **weapon**! Furthermore, the weapon may be dirty or damaged and there may be no additional ammunition other than what is currently in the gun!

Professional gunmen, assassins, terrorists, smugglers and illegal arms dealers will typically sell weapons that are clean — meaning they have no previous criminal record, work perfectly (probably brand new), and may have special features, accessories, customizing options and ammunition available for an extra cost. The price of these weapons will be top dollar. Handguns and sub-machineguns are the most easily accessible, but virtually anything can be acquired from a well connected underworld dealer.

---

## Typical Prices for some Typical Weapons

---

The price will vary depending on the source from which the weapon is acquired. The typical pistol is made of stainless steel **and has** a matte silver/grey finish. All prices are in **U.S. dollars**.

Petty criminals, thieves and junkies will sell common rifles, handguns and the occasional sub-machinegun at 30% to 50% of the market value (the lower the price, the more desperate the seller and the more likely the weapon is hot **and/or dirty**).

Smugglers will sell only in bulk (minimum 144 weapons) at 50% to 60% the market value.

Pawnshops and gun-clubs will frequently sell common rifles and handguns at 75% the market value.

Legitimate gun dealers will typically sell the weapons at full market value, but military type weapons are not likely to be available.

Illegal gun-dealers and gunrunners will sell weapons at full market **value**.

### Additional Cost Considerations:

- + 5% for rear adjustable sight
- + 5% for combat stock/handle
- + 5% for black or blue finish over stainless steel.
- + 10% for a nickel finish.
- + 10% for notable brand names, including Heckler & Koch, Sig Sauer, Smith & Wesson, and Walther.
- 10% for no-name or poor name brands.
- + 20% for competition weapons; superior quality.

**Note:** Scopes, special sights and accessories are separate and additional purchases. The prices of conventional weapons are average ranges. The cost for many of the military weapons are fictional speculation.

### Revolvers

- Revolver of small caliber/low mm:** \$150.00 to \$250.00
- Revolver of medium caliber/mm (.38 caliber/9 mm and up):** \$400.00 to \$550.00
- Magnum Revolver (any caliber):** \$600.00 to \$800.00

### Automatic Pistols

- Pistol of small caliber/low mm:** \$180.00 to \$300.00
- Pistol of medium caliber/mm (.45 caliber/9 mm and up):** \$600.00 to \$800.00
- Magnum Pistol (any caliber):** \$800.00 to \$900.00
- Auto-Pistols and Sub-machineguns (8 to 12 shot magazine):** \$500.00 to \$800.00
- Auto-Pistols and Sub-machineguns (20 to 40 shot magazine):** \$800.00 to \$1200.00
- Ammunition:** Ranges from \$12.00 to \$30.00 per 50 round box. The higher caliber rounds tend to cost the most.

### Rifles

- Airgun Rifle:** \$400.00 to \$1200.00
- Bolt-action hunting or target rifle of small caliber/low mm:** \$400.00 to \$800.00
- Bolt-action hunting rifle of large caliber (7.6 mm, 30-06, 300 mag.):** \$1400.00 to \$2100.00
- Non-Automatic Rifles — AK-47 type:** \$300.00
- Automatic Rifle — AK-47 type:** \$600.00
- Automatic Rifle — AR-15, M-16 type:** \$1000.00 to \$1600.00
- Sniper Rifle — Long Range:** \$2200.00 to \$3000.00
- Springfield M-1A:** \$1800.00
- Ammunition:** Ranges from \$20.00 to \$50.00 per 30 round box. The higher caliber rounds tend to cost the most.

### Shotguns

- Standard 12 Gauge Pump Type:** \$200.00 to \$400.00
- Over & Under Type:** \$700.00 to \$1200.00
- Autoloaders 12 & 20 Gauge Type:** \$600.00 to \$1000.00
- Police/Military, Automatic Drum Type (8 to 30 shots):** \$2500.00
- Ammunition:** Ranges from \$10.00 to \$20.00 per 10 round box. The higher caliber rounds tend to cost the most.

### Scopes & Sights

- Magnifying/Telescopic (1x to 3x):** \$100.00 to \$200.00
- Targeting Dot & Telescopic System (1x to 3x):** \$250.00 to \$350.00
- Telescopic & Targeting (20x to 40x):** \$350.00 to \$500.00
- Laser Targeting (10x, 20 mm):** \$400.00 to \$600.00
- Laser Targeting (20x, 40 mm):** \$700.00 to \$1200.00
- Infrared Telescopic & Targeting Sight (20x):** \$350.00 to \$500.00
- Passive Nightsight & Telescopic (20x, 40 mm):** \$1000.00 to \$1600.00
- Thermo-Imager & Telescopic (10x, 20 mm):** \$1900.00 to \$2500.00
- Front Sight:** \$8.00 to \$12.00
- Open Sight:** \$20.00 to \$80.00
- Handgun Sight:** \$50.00 to \$125.00
- Rifle, Micrometer Adjustable Sight:** \$70.00 to \$150.00

### Rocket Launchers & Heavy Weapons

- Note:** These items are available only on the black market or through other criminal channels. The black market cost is listed below.
- Average Flamethrower:** \$700.00 to \$1000.00
  - Average Bazooka:** \$500.00 to \$700.00
  - Average LAW:** \$600.00 to \$900.00
  - Average Rocket Launcher:** \$800.00 to \$1000.00
  - Average SAM:** \$1800.00
  - Grenade Launcher (M-79 type):** \$800.00
  - Rifle Incendiary Fragmentation Grenades (M-34 type):** \$8.00 each or \$210.00 for a box of 30.
  - Incendiary Hand Grenade:** \$12.00 each or \$300.00 for a box of 30.
  - Fragmentation Hand Grenade (M-61 type):** \$10.00 each or \$275 for a box of 30.
  - Tear Gas Grenade:** \$15.00 each or \$400.00 for a box of 30.
  - Smoke Grenade (M-8 type):** \$6.00 each or \$140.00 for a box of 30.
  - Dynamite/TNT:** \$10.00 per stick.
  - Anti-Personnel Mine (M-1611 type):** \$160.00 each
  - Anti-Personnel Mine (Claymore type):** \$200.00 each
  - Anti-Tank Mine (M-19 type):** \$300.00 each
  - Mortar (M-1 81 mm type):** \$4500.00
  - Mortar (M-2 4.2 inch type):** \$6000.00
  - Mortar (M-19 60 mm type):** \$6000.00
  - Recoilless Rifle (M-40A1 type):** \$50,000.00
  - Mortar Shell & Rocket Projectile:** \$40.00 each.

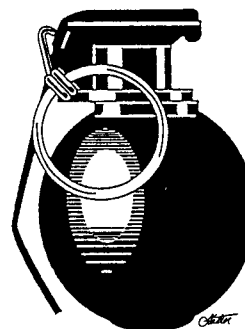

Mini Hand Grenade

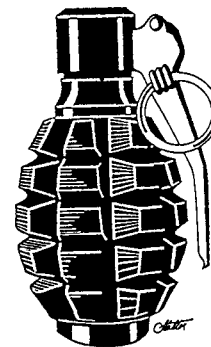

Polish Hand Grenade



OD/82 Hand Grenade

# Firearms & Damage in RPGs

## How to determine firearm damage in role-playing games

The popular misconception among role-playing gamers is that shooting somebody should instantly kill them. Wrong. Frequently, the victim of a shooting lives for long **minutes**, even hours or days (especially with medical assistance). Sadly, one needs only to listen to the evening news in any big city for real life examples of this: "Died on arrival to the hospital," "critical condition," "shot in the head (neck, chest, arm, etc.) and drove to a friend's house ..." and so on. Other examples can be found in popular and comparatively realistic movies like **The Unforgiven**. Clint's character plugs a cowboy in the stomach with a rifle. The shot cowpoke is going to die, but he is conscious and continually shouts to his comrades, "They shot me boys!" and begs for a drink of water for several minutes before he finally dies. The point is, bullets don't usually kill instantly. That's part of **their** horror in real life.

What does happen after a person gets shot depends mainly on the skill or luck of the shooter (**and/or** the luck of his **target**), the caliber of the **cartridge**, penetration of the bullet and where the victim gets shot. Other factors that may come into play are things like the character's physical endurance, will to live/mental **endurance**, and the speed in which the character receives medical treatment.

I'm not a big advocate of hit location tables, especially when dealing with the human body. I have two reasons for **this**. One is that the subject is rather gross and the second is that role-playing games are NOT real life but a fantasy adventure.

No matter how supposedly realistic a game may seem, it is at best a fictional simulation that is played out in words and imagination. In heroic fiction, the hero, whether it is a **Bruce Willis** character from the movies, Dirty Harry, James Bond or Spider-Man, all have superhuman endurance, willpower and luck. They all tend to survive events and injury that would kill or cripple a normal person.

The same is true for the main characters in most role-playing games. The fictional heroes and villains are larger than life. They can overcome incredible odds and survive terrible injury so that they may fight another day (often making an amazingly quick recovery with no or little permanent damage or **trauma**). This is okay, because I think few people want to play a character who dies or is incapacitated two minutes into the game from a blow to the head or a single gunshot wound. However, there can be a happy medium by establishing a role-playing game setting that seems plausible and **realistic**. The following observations and optional rules are provided to give your game the air of realism that many players may desire. The information is presented in such a way that most of it can be easily used in ANY game system. This also means the Game Master or players

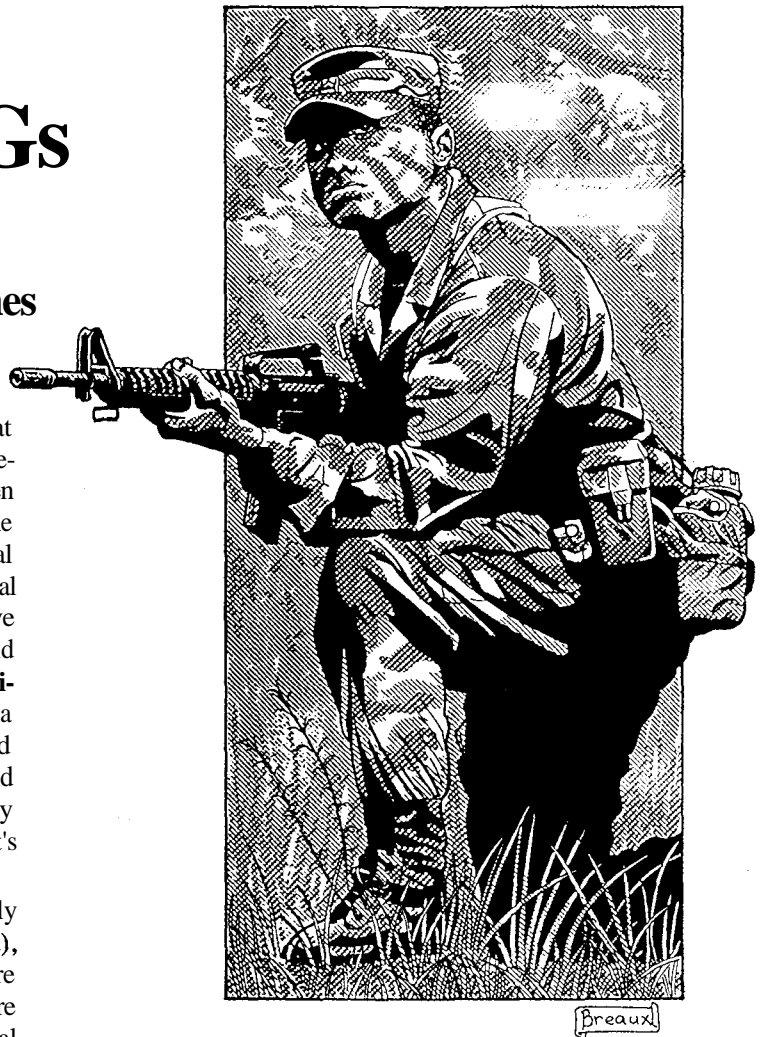

can dissect this information, taking and using only the parts that they like or feel appropriate for **their** games. **Note:** The rules for shock, blood loss and damage may be exactly what is needed for games where the characters (particularly superheroes) seem too powerful or played too **unrealistically**.

## Use Common Sense

Over the years I've heard and seen some pretty silly and outrageous incidents of game play regarding physical damage and modern **weapons**. Players tend to abuse the concept behind **life/hit/S.D.C.** points and body armor. These incidents seem to occur mostly in super-hero and science fiction RPGs where the outrageous **is** more common. I think it's a matter of not understanding modern firearms combined with a lack of common sense and failure to stop and think about the situation for a moment.

Main characters tend to be tougher than the average **Joe**. Their training has made them physically stronger and more skilled in the ways of combat. Furthermore, they are fictional heroes (and villains) and are therefore stronger, braver, and more capable. Fine, but they too are subject to scientific laws, logic, and common sense.

A character with incredible physical endurance, life/hit **points**, and clad in the best body armor will not charge through a hail of bullets without fear for his life (unless desperate, crazy or **suicidal**)! The odds of one or more of those bullets hitting the

head or extremities is very real, very painful, and potentially life threatening.

The character may actually escape a fatal wound and suffer only minor damage. However, while the minor wound is not immediately life **threatening**, the character is hurt! Do not underestimate pain. Think about how little you can do when you cut or otherwise hurt your hand or even slam a door on your finger. When the injury happened, you probably grabbed your finger or hand moaning, howling, and danced around in pain for a minute or two (shock). Later, something as simple as writing your name or opening a jar may be impossible or, at best, difficult and **painful**.

Even if the hero is able to shrug off the pain and shock of a bullet wound, and keeps on **fighting**, it does not change the fact that the character is injured, suffering and losing blood. Unless each wound is properly bandaged (roll under the appropriate medical skill), the character will continue to lose blood. The loss of blood causes weakness/increased fatigue and further physical damage. After the bleeding has been stopped, the hero must still have surgery to remove the bullets or risk infection and health **complications**. The wound is also painful and may impair movement **and/or** the performance of **skills**.

The following rules are some simple and realistic ways to play physical damage.

## Shock

Getting hit by a bullet anywhere hurts and traumatizes the body. The initial hit will cause at least *momentary shock*. This means the character who is shot by a bullet, arrow or even stabbed by a **knife**, inevitably looks at and clutches the area that is hurt. He is likely to stagger and probably fall down, even if the damage is not all that bad. Large caliber handgun and rifle wounds usually knock the character off his feet.

Being in shock means that the character is **dazed/stunned** for some period of time (seconds, minutes or hours depending on the severity of the injury). His or her full attention is on the gunshot wound and pain — the character is oblivious to everything else around him. He/she may clutch or just stare at the wound, writhe and groan in pain, try to stop the bleeding, or even pass out! The loss of consciousness is more typical from large caliber bullets, damage to the head or multiple gunshot **wounds**. After the initial shock, the character recovers his wits and can respond or react to his situation, whether that reaction is to counterattack, stop the bleeding, retreat, or surrender.

The shock rules which follow are a basic rule of thumb for role-playing games. In the real world, every person reacts differently. One 9mm slug may kill one person, while another person can get shot ten times by the same caliber and live. Likewise, the duration and severity of shock will vary with every person. One individual might lose consciousness from a flesh wound from a .22 caliber revolver, while another might get shot ten times from a 9mm, stay on his feet and charge his attacker.

**For greater realism**, the duration period of shock can be doubled, particularly from large caliber weapons and damage. Also note that characters under the influence of drugs (including alcohol) may react differently. In some instances, the shock duration might be half or virtually nonexistent. This can happen because the drug influences the person's mind and body. Thus, he or she might not feel or recognize the full extent of the damage

they are suffering. This disconnection from reality can give such individuals seemingly superhuman **strength**, endurance and resistance to pain, but the damage and blood loss is real and continuing. When reality strikes, it will hit hard and often with lethal results.

Note: Body armor offers some protection against shock, impact and physical damage. See the section on Body Armor for details.

## Shock Rules (optional)

The reaction to shock is for the average human being. Characters who are in superior physical condition, superhuman or non-human may react differently (half penalties and duration). Body armor also protects the body and will dramatically reduce damage and shock.

**Minor injury and shock:** Low caliber rounds do the least damage and trauma to the body. The .22 to .32 caliber bullet (P.V. 1-2), small arrows and knife stab wounds would have a similar shock effect. There have been reports of people getting shot in the head by a .22 caliber round (pistol or rifle) and not even realizing it until they feel the blood trickling down their neck.

Typically, a character shot by a low caliber round will lose 1D4 melee **action/attacks** for that round as a result of shock. This is usually true even if the damage is minimal. The character recovers from shock within 15 seconds and can continue his attack, flee, bandage his wound, etc., with minimal impairment (see hit location **table**). The Palladium System: The above holds true, but the character can roll to save vs physical **trauma/shock**. A 16 or higher is needed to save and P.E. bonuses are applicable. A successful save means the character is stunned only for a moment, one melee action (about 3 seconds), before recovering.

**Medium injury and shock:** Medium caliber rounds (.38 caliber and 7mm, 9mm and low caliber rifle rounds; P.V. 3-4) do serious damage and trauma to the body.

Typically, a character shot by a medium caliber round will lose ALL of his melee **action/attacks** for that round and the next as a result of shock. This attack knocks the character on his butt! There is also a 50% chance of dropping anything that he was holding at the time of the shooting, including his **weapon**. If shot in the arm or the hand, the character will drop any item he was holding in it at the time.

The character recovers from shock within 20 to 30 seconds and can continue his attack, flee, bandage his wound, etc. However, blood loss will be a problem, speed is reduced by 20% and skill performance is reduced by 30%. Unless this character gets medical attention he is likely to die. The Palladium System: The above holds true, but the character can roll to save vs physical **trauma/shock**. An 18 or higher is needed to save and P.E. bonuses are applicable. A successful save means the character is stunned for only half the **time**.

**Heavy/severe injury and shock:** High caliber rounds (.41 caliber and higher, shotgun and high caliber rifle rounds; P.V. 5-6) do extremely serious damage and trauma to the body.

Typically, a character shot by a heavy caliber round will lose ALL of his melee **action/attacks** for that round and the next four rounds as a result of shock. This attack knocks the character off his feet and there is a 30% chance of losing consciousness for 1D4 minutes! The gunshot victim is also likely (75%) to drop



anything that he was holding at the time of the **shooting**, including his weapon. If shot in the arm or the hand, the character will drop any item he was holding in it at the time and that limb will be barely usable.

The character recovers from shock within a minute and a half (90 seconds) and he can continue his attack, flee, bandage his wound, surrender, etc. However, blood loss and pain will be severe. Furthermore, speed is reduced by 80%, the number of attacks per melee round is reduced by **half**, combat bonuses are reduced to zero and skill performance is reduced by **90%**. Unless this character gets medical attention he will **die!** The Palladium System: The above holds **true**, but the character can roll to save vs physical **trauma/shock**. A 20 (natural or with bonuses) is needed to save and P.E. bonuses are applicable. A successful save means the character is stunned for only half the time, but all penalties and blood loss remain unchanged.

**Superior damage and shock:** The highest caliber rifle rounds and machinegun rounds (P.V. 7) inflict incredible damage and trauma to the body.

A character shot by a superior **caliber/machinegun** round will lose ALL of his melee **action/attacks** for that round and the next 3D4 rounds as a result of shock. This attack knocks the character off his feet and there is a 60% chance of losing consciousness for 2D4 minutes! The machinegun victim is also likely (80%) to drop anything that he was holding at the time of the shooting. If shot in the arm or the **hand**, the character will drop any item he was holding in it at the time and that limb will be useless (it may even be shot **off**).

The character semi-recovers from shock only after several minutes. Blood loss and pain will be severe. Speed is reduced by 80%, the number of attacks per melee round is reduced to one, combat bonuses are reduced to zero and additional penalties should be applied to strike, parry and dodge. Skill performance is reduced by **90%**. Unless this character gets medical attention he will die! The Palladium System: The above holds true, but the character can roll to save vs physical **trauma/shock**. A 20 (natural or with bonuses) is need to save and P.E. bonuses are applicable. A successful save means the character is stunned for only half the time, but all penalties and blood loss remain unchanged.

**Explosive impact, trauma and shock!** Getting caught in an explosion causes severe trauma to the body. Assuming the character was lucky and wore protective armor **and/or** was caught at the edge of the blast, he will be knocked unconscious for 1D6 **minutes**. When he regains consciousness, he will still be in shock for another 2D6 minutes! Blood loss and pain will be severe. Speed is reduced by 95%, the number of attacks/actions per melee is reduced to one, combat bonuses are reduced to zero and the character should have dramatic penalties to strike, parry or dodge. Skill performance is reduced by 95%. Unless this character gets immediate medical attention he will **die!** The Palladium System: The above holds true, but the character can roll to save vs physical **trauma/shock**. A 20 (natural or with bonuses) is need to save and P.E. bonuses are applicable. A successful save means the character is stunned for only half the time and all penalties are **half**. Blood loss and damage remains unchanged.

## Blood Loss (optional)

Blood loss is the shooting victim's next immediate problem. When one loses blood he gets weaker and weaker. The loss of too much blood will eventually result in death.

A character loses blood from every wound that has penetrated the body. This includes cuts, stab wounds, and gunshot wounds (most automatic pistols, and calibers under .45). Typically, the injured character will suffer one point of damage for every wound, every minute. Three gunshots means three points of damage every minute (60 seconds/4 melees).

Wounds inflicted by high caliber rounds (rifles, 10mmpistol, .45 caliber and higher) and special cartridges (**dumdum**, hollow point, ATE, etc.) cause larger wounds and the blood loss is doubled (two damage points per minute per each **wound**). The Palladium System: Damage is first subtracted from the S.D.C. When all the S.D.C points are gone, the damage is subtracted from the character's hit points. Note: Blood loss can also occur from internal bleeding.

Only first-aid or paramedic techniques that bind or plug the wounds will prevent further blood loss. Stopping blood loss can be performed by the wounded individual if the wound is not serious or if he knows first-aid.

Yes, a character can live and function without binding his wounds or seeking medical treatment. However, he will continue to lose blood and suffer more damage every **minute**. The character will also become increasingly slow, weak and disoriented. Eventually, he will pass out (when the character is down to about 5% of his life/hit points). Without immediate treatment and a blood transfusion, he will die. This is exemplified by such film classics as **Once Upon A Time In The West** and any number of John Wayne movies. It is the classic: "Nobody knows I'm hurt, keep on moving/fighting, and then collapse **and/or** die." A common event in heroic fiction.

When a character is severely hurt, down to 15% of his life/hit **points**, he will suffer from increased **hemorrhaging** and exhaustion: reduce current speed by half and double the damage from blood loss. Only a medical doctor and surgery can save him. First-aid and paramedic skills can only make the injured character more comfortable and slow the blood loss (even give transfusions), but they cannot save him. Without the appropriate medical aid, the person will continue to slowly lose blood (one point of damage every few **minutes**). When the injured character's life/hit points falls below zero, he lapses into a coma. He may remain in a coma for hours or days or slip away and die.

---

## Hit Location, Damage & Penalties (optional)

---

### Dividing Life/Hit Points to Body Locations

Dividing a character's life/hit points (or equivalent damage rating) to different parts of his body obviously makes the character more vulnerable and the game far more lethal. One way to play it is to make the **area/limb** completely useless if the damage capacity for that body area is depleted. Depleting the damage capacity of the head or main body causes unconsciousness **and/or** coma.

- 24% Head
- 50% Main Body
- 14% Legs (7% each leg)
- 8% Arms (4% each arm)
- 4% Hands and Feet (1% each)

Example: 30 life/hit points (or equivalent damage rating); round up **fractions**. Obviously, dividing up the life/hit points this way makes certain locations *very* weak (even though the total points usually increase because of rounding up). This is often unrealistic and unnecessarily complicates game play. Because of this I hate hit locations and never use them when I play. Note: In the Palladium game system, Structural Damage Capacity (S.D.C.) is divided and assigned in the same way as hit points. The inclusion of the Palladium S.D.C. system makes this more **plausible** and playable.

- 8 Head (round up fractions)
- 15 Main Body
- 3 Each Leg (2.1 rounded up to 3)
- 2 Each Arm (1.2 rounded up to 2)
- 1 Each Hand and Foot

## Random Hit Location Table

This table can be used when shooting at an enemy without trying to strike any particular part of the body. It is also appropriate when firing bursts or shooting wild.

- 01-08 Foot
- 09-15 Hand
- 16-20 Head
- 21-30 Arm
- 31-55 Main Body: Chest area
- 56-80 Main Body: Lower torso/stomach area
- 81-95 Leg
- 95-97 Neck
- 98-00 Main Body: Lower extremity/groin

## Damage and Penalties by Hit Location

What follows is a simple and fairly realistic system for hit location on the human body. Its use in any game is strictly *optional*.

**The Main Body** is the **trunk/upper** torso of a human being. It is the largest and easiest part of the body to strike. It is also one of the most vulnerable parts of the body because it contains the internal organs, heart, lungs, etc. It also has the largest amount of hit points (or equivalent damage **rating**).

**Main Body: Heart:** Hitting the heart with a weapon is more difficult than one might initially think. The heart is enclosed by the rib-cage and most low caliber rounds will hit it and either get lodged in the bone or deflected off of it. Bullets with a P.V. of 1-3 have no chance of penetration and hitting the heart. Bullets with a P.V. of 4 have little chance (25%) of penetration. Bullets with a P.V. of 5 or 6 (including special rounds) have a 60% chance of penetration. Rounds with a P.V. of 7 will penetrate and do extensive **damage!** High caliber rifle cartridges and explosive shells will shatter the bone. If the bullet doesn't penetrate and strike the heart, bone and bullet fragments **will**.

**Damage:** Shooting the heart causes quadruple damage (in Palladium, direct to hit points), extensive blood loss (3D6 life/hit points per minute) and instant **shock/coma**. The character will **DIE** in 1D6 minutes without immediate and extensive medical

treatment. Immediate attempts to stabilize the condition and contain blood loss *may* enable the medics to get the individual into surgery. However, the chance for survival and recovery is slim. Low caliber or small fragments in the heart or arteries: 10% chance of recovery, medium caliber: 5% chance of recovery, heavy caliber: 1% chance of recovery. **Note:** To shoot the heart, the character must either use a sniper skill **and/or** make a carefully **aimed**/"called" shot. Even at point-blank range, the bullet might be deflected (probably into a lung).

**Main Body: Lungs:** The lungs are also protected by the rib-cage but are much larger targets. Shooting a lung will puncture or collapse it. **Damage:** Normal per weapon and round. **Penalties:** A damaged lung will cause the victim great pain and even greater difficulty breathing. Also reduce the character's number of melee rounds attacks/action by **half**. Running speed is reduced by 75% and fatigue is increased two-fold. The pain is also distracting and frightening, so reduce the execution of skills also by half. Blood loss is standard. Without medical treatment within 2D4 X 10 **minutes**, both lungs will collapse or fill with blood and the character will collapse into a coma and die.

**Main Body: Lower Torso/Abdomen:** Getting shot in the lower body is anything below the rib cage, including the stomach, spleen, bladder, other internal organs and the pelvic area.

*When shot in the lower torso, roll percentile dice:*

A roll of 01-40% means that the bullet misses ALL vital organs; blood loss and shock are normal. 01-15% means the bullet not only missed any vital organ, but went in one side and out the other (no bullet to **remove**). In both **cases**, **penalties** are as follows: Reduce the character's number of melee round attacks and running speed by **half**. The pain is distracting and **frightening**, so reduce the execution of skills also by half.

A roll of 41-00% means there is serious internal damage. Medical attention is critical or the character will die within 6D6 minutes. **Penalties:** Reduce the character's number of attacks/actions per melee round to one (1). Running is impossible; reduce **speed/movement** by 90%. The pain and likelihood of death is so distracting that the execution of skills is reduced by 80%. Blood loss and shock are double!

**The Extremities: The head, neck, arms, hands, groin, legs and feet:** All are small and difficult targets to hit. To deliberately strike any of the extremities, the attacker must make a carefully **aimed/called** shot. This means taking the time to aim and shoot at that particular extremity with ONE bullet at a time. Each aimed shot counts as one **combat/melee** attack. The head, neck, eyes, ears, hand, feet and groin are - 5 to strike, the arms - 3 and the legs - 2.

**Head:** Bullets with a P.V. of 1 or 2 have little chance (5%) of penetrating the skull or other bones in the head, even at close range. Bullets with a P.V. 3 or 4 have a 25% chance of penetrating bone (triple at point-blank **range**), while bullets with a P.V. of 5 or 6 will almost definitely penetrate bone, especially at close range (50 ft/15 m or closer). Rounds with a P.V. of 7 will penetrate and do extensive **damage!** High caliber rifle cartridges and explosive shells will penetrate and shatter the **bone**, including the skull.

**Roll percentile:** 01-50% means a grazing strike or the round was deflected by the bone or stopped by (stuck in) the **bone/skull**. Double blood loss (head wounds always bleed a great deal). Normal damage and shock. Speed, number of combat attacks and skill performance are reduced by 25%.

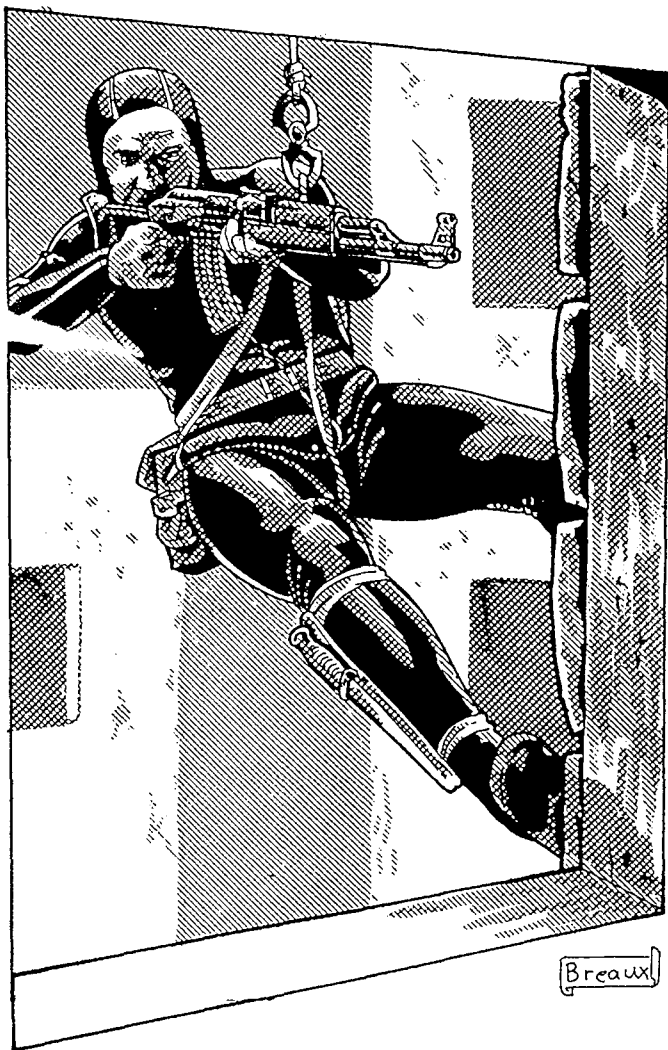

51-90% A perfect head shot: Double damage, triple the duration of shock and blood loss, and the victim is knocked to the ground. Severe trauma to the head by high caliber bullets *may* cause permanent brain damage, memory loss, disfigurement, paralysis of face muscles and even paralysis of the lower extremities.

91-00% A brain shot! Damage: Shooting the brain causes quadruple damage (in Palladium, direct to hit points), extensive blood loss (4D6 life/hit points per minute) and instant shock/coma. The character will DIE in 1D6 minutes without immediate and extensive medical treatment. Immediate attempts to stabilize the condition and contain blood loss *may* enable the medics to get the individual into surgery. However, the chance for survival and recovery is slim. Low caliber or small fragments (bone, shrapnel, etc.) in the brain offers 30% chance of recovery, medium caliber or fragments 15% chance of recovery, heavy caliber 1% chance of recovery. Note: To shoot the brain (an assassin's head shot), the character must make a carefully aimed "called" shot.

**Neck**: Normal damage, double blood loss and shock.

**Eye**: Getting shot in the eye, even by the smallest caliber weapon, causes extreme trauma. Double damage, triple shock, but blood loss is normal.

**Leg**: Normal bullet damage, shock and blood loss. Reduce speed by 40%.

**Arm**: Normal bullet damage, shock and blood loss. Reduce physical prowess, arm strength and skill performance by 40%. May temporarily lose use of the limb. Permanent damage/impairment may occur from severe damage.

**Hand**: Normal bullet damage and shock. Half blood loss. Reduce physical prowess, hand strength and skill performance by 45%. May temporarily lose use of the limb. Permanent damage/impairment may occur from severe damage.

**Foot**: Normal bullet damage and shock. Half blood loss. Reduce speed by 20%.

**Groin Area**: Getting shot in the groin, even by a low caliber weapon, causes extreme trauma. Double damage, triple shock, but blood loss is normal.

### Damage at Point-Blank Range (optional)

There can be a big difference between getting shot from 300 yards/meters away or at point-blank range. For one thing, the assailant will be less accurate at greater distances and for another, the bullet will have less impact when fired from a distance. Of course, a well placed long-range shot can kill as easily as a close-range or point-blank attack.

**We will define point-blank range as approximately 10 feet (3 m) or closer.** At ten feet away, the assailant has a better chance to hit his target (especially a human-sized target) and take an aimed shot at the extremities or vital areas. The bullet will have greater impact, inflicting more damage (double) and the attack is more likely to hit a vital organ.

The following rules take into consideration the damage and effects of point-blank attacks.

1. If the target is immobile, i.e. tied up or unconscious, the attacker has as long as he wants to carefully aim and shoot at point-blank range (10 ft/3 m or closer). No roll to strike should be necessary unless the target/victim can dodge or unless the attacker is shooting wild.
2. Damage and shock at point-blank range should typically be double damage when fired into a vital area such as head, eye, chest, etc. Blood loss is normal.
3. A character can not survive a point-blank confrontation with a grenade or other explosive without severe injury, no matter how many life/hit points (or equivalent damage system)! A limb or two will be blown off and the character will suffer massive trauma and shock. Without immediate and extensive medical treatment he will die.

Covering a grenade with one's torso/main body will kill him. And I mean DEAD! There is no chance of survival, because he was laying right on the grenade. At the risk of being gory, his guts were blown to smithereens. That's the only realistic way to play explosives vs the human body.

Protective body armor may protect the body (or vital parts of the body), but even the best protection will not prevent some measure of damage and shock from the force of the explosion.

### Average Damage levels of Bullets

**Low Caliber (P.V. 1-2)**: .22 to .32 caliber and arrows.

**Medium Caliber (P.V. 3-4)**: .35 to 38 caliber, 9mm and under, and light rifles. These may penetrate some types of body armor.

**Heavy or High Caliber (P.V. 5-6):** .357, .41 caliber and higher, 10mm, most rifles, shotguns and special rounds (dum dums, armor piercing, etc.). These have an excellent likelihood of penetrating most types of body armor.

**Superior (P.V. 7):** .50 caliber and higher/machineguns — punches through all modern body armor, car doors, and 1/2 inch of steel.

---

# Palladium's Combat System For Modern Firearms

---

Palladium Books has developed a quick, simple and reasonably realistic combat system for the use of modern firearms. It has appeared in such notable games as **Heroes Unlimited**, **Ninjas & Superspies**, **Beyond the Supernatural**, **RECON Modern Combat** and **Rifts**. We present it here for readers who might like to incorporate some of its ideas into their games of modern combat. Note: All combat rolls to strike, parry, and dodge are made with a 20 sided die.

## Modern Weapon Proficiencies

**Weapon Proficiencies (W.P.)** are areas of training and practiced skill with a particular type of weapon. Such skill areas are divided into categories such as W.P. revolvers, W.P. automatic pistols, W.P. bolt-action rifles, W.P. semi & automatic rifles, W.P. sub-machineguns, W.P. machineguns, and W.P. heavy weapons (LAWs, mortars, and similar). Expertise in each skill area provides special bonuses to strike when using that particular type of weapon (i.e. any revolver, etc.). Do not add the strike bonus to your character's hand to hand combat bonuses to strike. The use of a weapon is a distinctively different skill.

Weapon Proficiencies provide the following skills and bonuses:

- **The W.P. skill** enables the character to easily reload, disassemble, unjam, clean and otherwise maintain the weapon.
- **Recognizes weapon quality:** 30% at level one and +5% per each additional level of experience.
- **No Weapon Proficiency** means the character shoots without bonuses to strike. Anybody can pull a trigger, but there is more to using firearms than that.
- **Add a bonus** of + 1 to strike for every THREE levels of experience beyond level one. There are three main modes or categories of attack with firearms: aimed, burst or wild.
- **Aimed:** + 3 to strike.
- **Burst:** + 1 to strike.
- **Wild:** No bonus or penalty.

## Aimed Shots

An aimed shot means the character takes the time to carefully aim and squeeze off one well placed shot. Each individual shot takes one full melee **attack/action**. Thus, if a character has four attacks per melee (15 seconds) he or she can shoot four aimed shots. This applies to all modern weapons. Roll to strike for each shot. The aimed shot bonus to strike is +4 for revolvers and +3 for all others projectile shooting weapons.

## Bursts

A burst is the shooting of several rounds, one immediately after another. Aim is more hasty and the recoil moves the weapon with each shot, reducing the overall accuracy. Semi-automatic and all automatic weapons (assault rifles, machineguns, sub-machineguns etc.) are designed to fire **bursts**. The concept behind their design is that while accuracy is reduced, the odds of hitting **one's** target by firing many rounds in a few seconds is **increased**. The strike bonus when firing a burst is only + 1.

**Note:** Roll to strike once to see if the entire burst hits. Do not roll for each individual bullet. If the burst misses its target, then all the rounds in that burst miss. The following indicates how many rounds strike if the burst hits its mark.

**Short bursts** fire 20% of the entire magazine/payload; i.e.: a 30 round magazine means six (6) rounds/bullets are fired. **Damage:** Roll the normal damage dice for ONE round X 2. The burst attack uses up one melee **attack/action** and can be fired at only one target.

**Long bursts** fire 50% of the entire magazine; i.e.: a 30 round magazine means 15 rounds/bullets are fired. **Damage:** Roll the normal damage dice for ONE round X 5. The burst uses up one melee attack and can be fired at only one target.

**Entire magazine burst:** Shooting off the entire clip/magazine within a melee round (15 seconds) is possible with most automatic and semi-automatic weapons. Machineguns are the only exception to this rule. 100% of the rounds are **fired!** **Damage:** Roll the normal damage dice for ONE round x 10. This attack uses up two melee attacks/actions that combat round. The burst is fired at only one target.

**Spray:** Shooting a burst at *several* targets at once is also possible, but the level of accuracy is terrible and is the same as *shooting wild*. However, a spray is likely to keep the enemy off balance (ducking bullets) and prevent them from counterattacking or squeezing off an aimed shot (afraid to raise their heads for fear of catching a bullet). The character must fire a long burst or the entire magazine in order to **spray**. See shooting **wild**.

## Shooting Wild

Shooting wild occurs when even a trained character shoots without taking time to aim. This usually applies when the character is blinded, angry, running, rolling, leaping, shooting from a moving vehicle, flying, shooting through a closed door, shooting in the dark or when the exact location of the enemy cannot be seen, and similar situations.

**Strike Bonuses & Penalties:** Characters who have a W.P. in that particular type of weapon shoot without any sort of **mod-**

**ifier:** there is no bonus or **penalty**, just the natural roll of the **die**.

Characters using a weapon without benefit of a W.P. strike with a penalty of — 6. Long bursts or the entire magazine must be fired and can be fired at one target or in a spray. The attack counts as two melee actions/attacks.

**Damage from shooting wild burst at one target:** Roll normal damage dice for ONE round x 2. Remember, roll to strike only once for the entire wild burst. Hitting an innocent bystander is a real possibility when shooting wild; 20% chance. Roll once for each wild burst fired. Damage to bystanders is the normal damage from one round (a wild shot).

**Spraying an area with bullets** can be dangerous and is considered to be shooting wild. The object of a spray is to hit several targets simultaneously or one after another. First, roll once to determine if you strike the target "area" (1D20). A roll of five or higher strikes targets in the general area. Then roll 1D4 to determine how many individual targets are struck within the target area. However, each target gets to roll a dodge to avoid getting shot by diving behind cover. Damage is the normal damage from one round. Hitting an innocent bystander is even more likely; 50% chance to strike 1D4 bystanders. Damage is from one round (a wild shot.)

## Bursts or Sprays from a Machinegun

Bursts and sprays from a machinegun are different in the number of rounds fired, number of targets struck, and the increased chance of hitting bystanders. **Machineguns** have a much greater ammunition capacity, so they do NOT have to empty half or more of their entire magazine/payload to fire a long burst or spray.

**Short burst aimed at one target:** 10% of the rounds in the magazine (payload) of a machinegun are fired. They inflict normal round damage X 2. Counts as one attack. The short burst is comparatively contained and offers NO threat of striking innocent bystanders.

**Short burst spray:** 10% of the rounds in the magazine of a machinegun are fired. They inflict normal damage from ONE round and hit 1D4 enemy targets. There is also a 30% chance of hitting one innocent bystander. Counts as one melee attack.

**Long burst/one target:** 30% of the rounds in the magazine are fired. They inflict normal round damage X 5. The chance of hitting one innocent bystanders is 5%. Counts as one melee attack.

**Long burst spray:** 30% of the rounds in the magazine are fired. They inflict normal damage from ONE round and hit 2D4 targets. Counts as one melee attack. Chance of hitting 1D6 innocent bystanders is 50%.

**Empty the entire magazine/one target:** All rounds are fired and inflict normal damage from ONE round X 20. This attack uses up ALL the **character's** melee actions/attacks that full round. The chance of hitting one innocent bystander is 10%.

**Empty the entire magazine in a spray:** All rounds are fired and inflicts normal damage from ONE x 2 per each enemy struck. The attack hits 4D4 enemy targets. This attack uses up ALL the character's melee actions/attacks that full combat round (15 seconds). Chance of hitting 2D4 innocent bystanders is 70%.



## Body Armor

Most types of "Bullet-Proof" body armor are vests constructed of synthetic polymers, nylon, plastics, ceramics, Kevlar, and steel. The Class A or Class I/IA armors all tend to rely solely on Kevlar fabrics, whereas the Class B or Class IV and higher armors also have steel and/or ceramic plating.

Ballistic materials technology has continually improved since its introduction in the 1960's. Space age materials are thinner and lighter, yet many times stronger. There are three common materials used in most contemporary vests. **Polyethylene fibers** that are 10 times stronger than steel, **Kevlar™** and **Twaron™**, both of which use aramid based fibers.

The vast majority of all protective vests and body armor use a weave of aramid based fibers. **Kevlar** is a product of the **DuPont Co.** and the most commonly used material for body armor in the world! Most current vests contain aramid fibers known by the tradename of **Kevlar 29™**. The latest in aramid armor technology is **Kevlar 129™**. Not only is it stronger and lighter than Kevlar 29, but softer and more flexible, making it less restrictive and more comfortable.

**Twaron™** is another aramid based fiber that is comparable to **Kevlar™**. It is produced by the European company, **Akzo**.

DuPont and Akzo compete to dominate the world market of "Bullet-Proof body armor.

---

## Body Armor Classes

---

### Body Armor & Damage

Body armor typically comes in the form of a "vest," which protects the chest, stomach, back and, frequently, the pelvic areas of the body.

Gunshots to the trunk of the body (main body) are the most likely so these armored vests do provide tremendous protection. However, even the best body armor only offers limited protection. Vests leave the extremities of the body (legs, arms, hands, neck) unprotected — the head is usually protected by the addition of a helmet. Rounds fired into the main body of the vest may be stopped and save one's life, but they still hurt. The body underneath the armor will be bruised and sore. The impact is also likely to knock wearers off their feet.

**Superficial Damage — Limited Damage and Shock Under the Best Conditions:** Specific damage and shock data per armor class/type is provided under the listings of each Body Armor Class. Or use the Quick Roll General Rules presented [here](#).

**Quick Roll Rules (optional):** Generally speaking, the impact of a bullet will cause some degree of damage to the armor wearer due to the power of the impact. A basic damage modifier is *one-quarter the normal damage* of the bullet even though it has been stopped by the body armor. The impact from medium and high caliber weapons will also knock the character off his feet. The shock to the body stuns him for one **minute**. No attacks or melee actions are possible while stunned.

---

### What degree of Protection?

No vest ever made, by any manufacturer, is 100% "Bullet-Proof!" The best a manufacturer can offer is that in "laboratory tests," a particular vest and armor class stopped particular bullets. Body armor is designed as protection against the most typical threats. It is impossible to account for every type of bullet, velocity, trajectory, modifications/enhancements, range or other random conditions on the streets.

**At close range** (15 m/50 ft), there is a 1% chance that low caliber cartridges (P.V. 1-2) will penetrate the average **IIA** or **IIIA** body armor and 3% for medium (P.V. 3-4) or 5% for high (P.V. 5-6) caliber rounds. Reduce this percentage by half for Class IV and V armor. Bullets that penetrate the armor inflict 75% of their full damage.

**At point-blank range** (3 m/10 ft or closer), low caliber rounds have a 3% chance of penetrating the body armor, 7% for medium and 15% for high caliber. High caliber "special" bullets (armor piercing, THV, etc., with a P.V. of 6 or higher) have a 40% likelihood of penetration at point-blank range. Reduce this percentage by half for Class IV and V armor. Bullets that penetrate the armor inflict full damage.

**High caliber machinegun rounds** and the most powerful rifles (P.V. 7) will punch through all known forms of modern body armor like a hot knife through butter. They inflict full damage and shock from any range.

**Grenades and other explosives** will also injure characters wearing body armor. The damage is half and mainly from the concussion and injury to the extremities. Shock is also at half.

Most body armor and vests are Class II, **IIA** and **IIIA**. These are the thinnest, flexible, most comfortable, and lightweight. Class IV and V armor are typically reserved for the military and are a rarity. Both are comparatively heavy.

**"Concealed" body armor**, armored shirts and EOD soft armor, are typically a light, Class I or II vest that protects only the upper body; chest, stomach and back (no protection below the waist). It is soft, thin and can be easily concealed under a loose fitting shirt, sweater or jacket.

**Typical riot vests**, prison riot vests, **Aircrewman** armor (aircraft and helicopter crew), security guard vests, Covert Operations Protective System (COPS), Execuvests and Marksman jackets, and light combat vests are typically Class **I, II, or IIA**.

**Nato/SWAT**, USA SWAT, USA Ranger tactical vest, USA Building Entry Team Armor (**BETA**), Tac-Jac, Street Jac, Command Jac, Ballistic Raincoat, Ballistic Flotation vests, Hi-Risk Modular Tactical Armor, Magnum-Lite tactical vest, Titanium Man protection (upper torso vest), UK Flak jacket, UK Swat, most Fragmentation vests and armored attache cases are typically Class **IIA** or **IIIA**.

**The Reinforced USA Ranger tactical vest** is a Class **IIIA** vest upgraded to Class **IVA** with rifle resistant inserts of **ceramic/laminate** and steel plates.

**Point-Blank Body Armor**, Boarding Party Vest (BPV), heavy-duty EOD armor vests or suits, USA **Hardcorps** armor HC3 and HC4, Browning Model P303 and P304 vests, French SEMA Class B vest, Italy's Fibrosint LAS-710 vest, and the Yugoslavian Protective vest Type 4 are all Class **IVA** and **IVB/C**.

**The typical SWAT, police, riot "helmet"** is equal to Class **IIA** or **IIIA**.

**Note:** The majority of military and police body armor are covered and lined with washable nylon and are waterproof.

---

### Class I/IA Body Armor (P.V. 1-4)

Resistant to rounds with a penetration value up to P.V. 4. Protects against:

- .22 caliber
- .22 high velocity long rifle
- .25/6.35mm
- .32 automatic/7.65mm
- .38 special.

**Impact Damage:** Cartridges with a P.V. of 1 or 2 do one damage point. Bullets with a P.V. of 3 or 4 do 1D4 damage from the force of impact.

Higher caliber, rifle and special rounds will knock the character off his feet, penetrate the armor, and inflict 100% of their damage and shock.

**Shock:** Bullets with a P.V. of 1 have no noticeable effect on the wearer of the armor. P.V. of 2 to 4 will cause a stinging impact, as if getting punched in the chest. This causes momentary shock that lasts for about six or seven seconds and the character loses two of his attacks/actions for that **melee**.

---

---

## Class II/IIA Body Armor (P.V. 1-5)

Resistant to rounds with a penetration value of up to P.V. 4; protects against All class I/LA rounds described above, plus:

.38 FMJ  
.357 Magnum semi-jacketed/soft point  
9mm Parabellum  
9mm ATE  
12 gauge shotgun "buckshot"

**Impact Damage:** Cartridges with a P.V. of 1 or 2 do one point of damage. Bullets with a P.V. of 3 or 4 do 1D4 points of damage from the force of impact. P.V. 4 bullets will penetrate at close range and inflict half damage and full shock.

Higher caliber bullets, rifle and special rounds will knock the character off his feet, penetrate the armor, and inflict 75% of its damage and full shock.

**Shock:** Bullets with a P.V. of 1 have no noticeable effect on the wearer of the armor. P.V. of 2 to 4 will cause an impact like that of getting punched in the chest. The character will be knocked backwards/staggered and probably (60% chance) be knocked to the ground. The impact causes momentary shock that lasts for about eight to ten seconds and the character loses half of his attacks/actions for that **combat/melee** round.

---

## Class IIIA (P.V. 1-6)

Resistant to rounds with a penetration value of up to P.V. 6; protects against All class I/IA, II/IIA rounds described previously, plus:

.357 Magnum jacketed  
.41 Magnum  
.44 Magnum  
.45 ACP  
9mm ATE FMJ  
dum dum  
12 gauge Brenneke  
12 gauge OO buckshot  
12 gauge slugs

**Impact Damage:** Cartridges with a P.V. of 1 or 2 do one point of damage. Bullets with a P.V. of 3 or 4 do two points of damage from the force of impact. Bullets with a P.V. of 5 or 6 do 1D4 damage from the force of impact. Higher caliber, rifle and special rounds will penetrate the armor and inflict 75% of their damage and full shock.

**Shock:** Bullets with a P.V. of 1 or 2 have no noticeable effect on the wearer of the armor. P.V. of 3 to 4 will cause a stinging impact, as if getting punched in the chest. This causes momentary shock that lasts for about five seconds and the character loses one-third of his attacks/actions for that **combat/melee** round.

Shotgun blasts and bullets with a P.V. of 5 and 6 feel like getting kicked in the chest. The character will be knocked backwards and off his feet. The momentary shock from impact lasts about 45 seconds or three full **combat/melee** rounds.

---

## Class IVA (P.V. 1-6 & Many Special Rounds)

Resistant to rounds with a penetration value of up to P.V. 6 as well as most special rounds for handgun (armor piercing, dum dum, hollow point, wadcutter, THV, and ATE, even if the special round bonuses give the bullet a P.V. of 7 or higher).

.38 Special THV  
.357 Armor Piercing  
.357 Magnum THV  
.41 Magnum THV  
.44 Magnum THV  
.45 ACP THV  
.45 ACP ATE  
9mm THV  
.30 US (M1) carbine soft point.

**Impact Damage:** Cartridges with a P.V. of 1 or 2 do one point of damage. Bullets with a P.V. of 3 or 4 do two points of damage from the force of impact. Bullets with a P.V. of 5 or 6 do 1D4 damage from the force of impact.

Higher caliber, rifle and special rounds not listed will penetrate the armor and inflict 75% of their damage and full shock.

**Shock:** Bullets with a P.V. of 1 or 2 have no noticeable effect on the wearer of the armor. P.V. of 3 to 4 will cause a stinging impact, as if getting punched in the chest. This causes momentary shock that lasts for about four seconds and the character loses one-third of his attacks/actions for that **combat/melee** round.

Shotgun blasts, special rounds, and bullets with a P.V. of 5 and 6 feel like getting kicked in the chest by a mule. The character will be knocked off his feet! The momentary shock from impact lasts about 45 seconds or three full **combat/melee** rounds.

---

## Class IVB/C (P.V. 1-6, rifles & All Special Rounds)

Resistant to rounds with a penetration value of up to P.V. 6, as well as many rifle rounds and ALL special rounds for handguns (including armor piercing, hollow point, explosive, Glaser, THV and ATE, even if the special round bonuses gives it a P.V. of seven or higher).

5.56mm×45mm  
7.62mm×39  
7.62mm×51 NATO  
US .30 Carbine FMJ

**Impact Damage:** Cartridges with a P.V. of 1 or 2 do one point of damage. Bullets with a P.V. of 3 or 4 do two points of damage from the force of impact. Bullets with a P.V. of 5 or 6 and special rounds do 1D4 damage from the force of impact.

Higher caliber, and rifle rounds not listed will penetrate the armor and inflict 75% of their damage and full shock.

**Shock:** Bullets with a P.V. of 1 or 2 have no noticeable effect on the wearer of the armor. P.V. of 3 to 4 will cause a stinging impact, as if getting punched in the chest. This causes momentary shock that lasts for about four seconds and the character loses one of his attacks/actions for that **combat/melee** round.

Shotgun blasts, special rounds, and bullets with a P.V. of 5 and 6 feel like getting kicked in the chest. The character will be knocked off his feet. The momentary shock from impact lasts about 30 seconds or two full **combat/melee** rounds.

---

## Class V (P.V. 6, handguns, rifles & All Special Rounds)

Resistant to rounds with a penetration value of up to P.V. 6, as well as many rifle rounds and ALL special rounds for handguns (including armor piercing, hollow point, explosive, Glaser, THV and ATE).

5.56mm×45mm

7.62mm×39

7.62mm×51 NATO

US .30 Carbine FMJ

.30-06

**Impact Damage:** Cartridges with a P.V. of 1 or 2 do one point of damage. Bullets with a P.V. of 3 or 4 do two points of damage from the force of impact. Bullets with a P.V. of 5 or 6 and special rounds do two points of damage from the force of impact.

Higher caliber and rifle rounds not listed will penetrate the armor and inflict 75% of their damage and full shock.

**Shock:** Bullets with a P.V. of 1 or two have no noticeable effect on the wearer of the armor. P.V. of 3 to 4 will cause a stinging impact, as if get punched in the chest. This causes momentary shock that lasts for about four seconds and the character loses one of his attacks/actions for that **combat/melee** round.

Shotgun blasts, special rounds, and bullets with a P.V. of 5 and 6 feel like getting kicked in the chest. The character will be knocked to the ground. The momentary shock from impact lasts about 30 seconds or two full **combat/melee** rounds.

### LAYERS OF KEVLAR

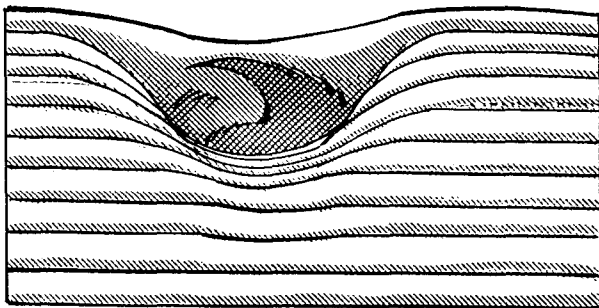

AN EXAMPLE OF A BULLET STOPPED BY LAYERS OF KEVLAR. TYPICALLY 12, 16 OR 18 LAYERS OF KEVLAR ARE USED IN BULLET-PROOF BODY ARMOR.

### Weight of Body Armor

Weight depends on the size of the wearer, the amount of protection and the types of materials used in the armor. The heavier the armor, the more protection it offers, but it may also be uncomfortable to wear for long periods of time, and may restrict movement slightly.

Penalties for heavy armor and full suits: Reduce speed by 5% and increase fatigue by 5%; - 10% to **prowl/stealth** movement, climbing and swimming type skills.

**Average light armored shirts and vests:** 0.9 to 1.4 kg (2 or 3 lbs) — Class I and light Class II.

**Average medium armored vests:** 1.8 to 3.2 kg (4 to 7 lbs) — Class II/IIA and IIIA.

**Average heavy armored vests:** 3.2 to 4.5 kg (7 to 10 lbs) — Class IV and V.

**Full Body suits:** 9.1 to 13.6 kg (20 to 30 lbs) — Typically Class IIA/IIIA.

## Some Examples of Body Armor



### Liukko Survival & Rescue Suits (Finland)

These survival suits are constructed out of two basic types of material: PVC and Gore-Tex, a breathable laminate which lets through condensation. The Liukko suits have been in wide use throughout Finland and Sweden since 1974 and are used by those country's Navy, Army, Air Force and Frontier Guard.

The survival suits are not intended to offer protection from bullets, but from harsh, cold elements of the outdoors. They have proven to be hard-wearing and dependable in rescue operations. Tests have shown that after one hour's immersion in water at 5 degrees Centigrade (38 degrees Fahrenheit), the average drop in body temperature is no more than .30 degrees C for those wearing the protective suit. Class I.



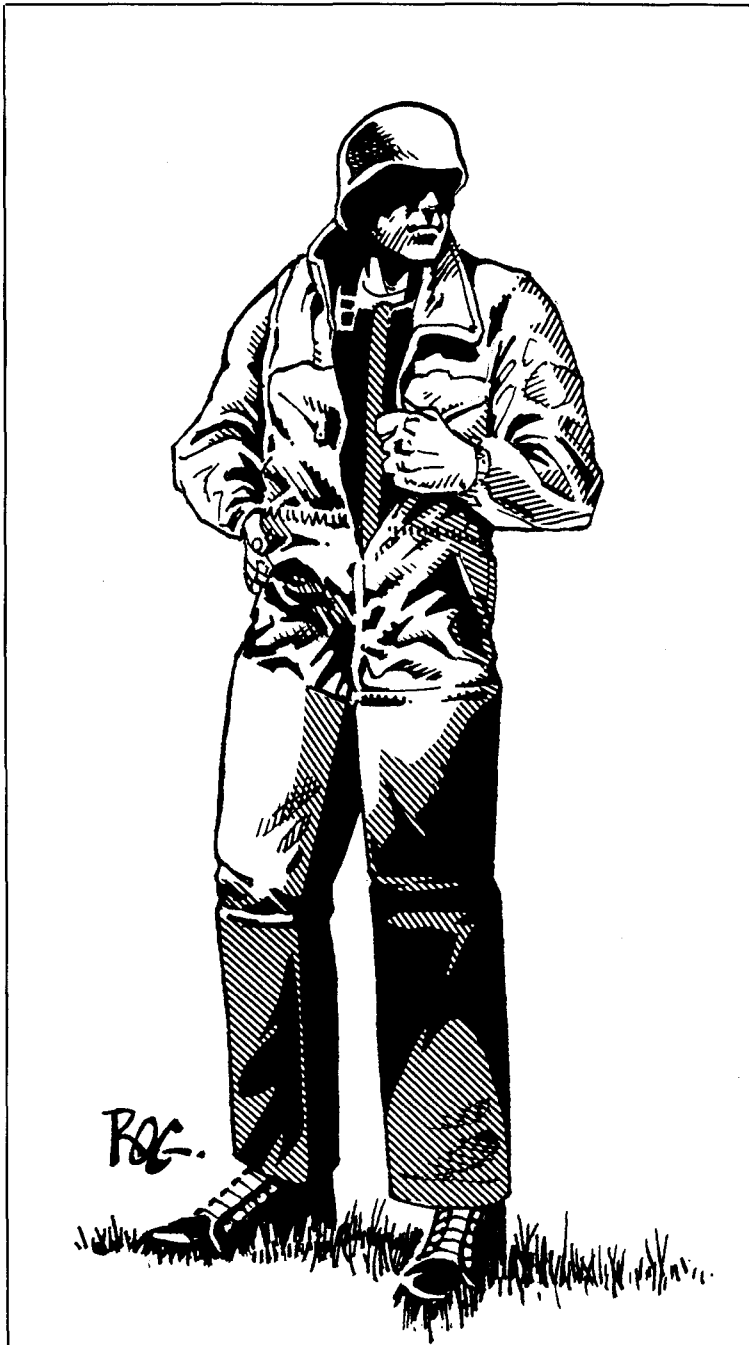

### Bombsuit MIL-300

This is a light coverall garment with inserts which mainly protect the trunk, and front of the legs. The normal level of protection will cover fragments and most pistol bullets up to a velocity of 300 m/s. The weight of the average suit is 5.35 kg (12 lbs) and protects an area of approximately 7190 square cm (7.4 square feet). Class I or IIA.

### German Body Armor Fragmentation Vest MIL-110

This is a light and flexible, splinterproof vest. Although this is mainly a frag vest, Class I, it can be upgraded to protect against 9mm Parabellum, .41 Magnum and similar rounds; class IIA. The weight of a medium size vest with standard protection is approximately 1.55 kg (a little over 3 lbs). The vest protects approximately a 3500 square cm (3.8 square feet) area.



### Other German Vests of Note

**Slip-On Vest S 811:** An all-around protection vest used by the German police and military. The neck and pelvic protectors are removable and do not interfere with mobility. Class II, IIA and IIIA. The average weight is 3 kg (roughly 7 lbs).

**Slip-On Vest Type T-200:** Class IIIA and IVA; 3.2kg (7 lbs).

**Vest Type S 321:** Class II, IIA, IIIA, IVA, IVB/C and V; 6.8 kg (15 lbs).

**Vest Type S 911:** Class IIA, IIIA and IVA; 4.47 kg (10.5 lbs).

**German Ballistic Protective Shield:** Class IIA, IIIA and IVB/C; 7.5 kg (16.5 lbs).

Full suit: Class IIIA and IVA. Weight: 13 kg (29 lbs). It is very easily worn and easily removed.

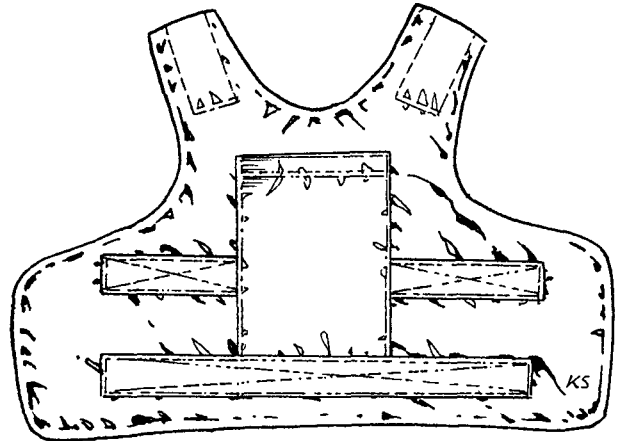
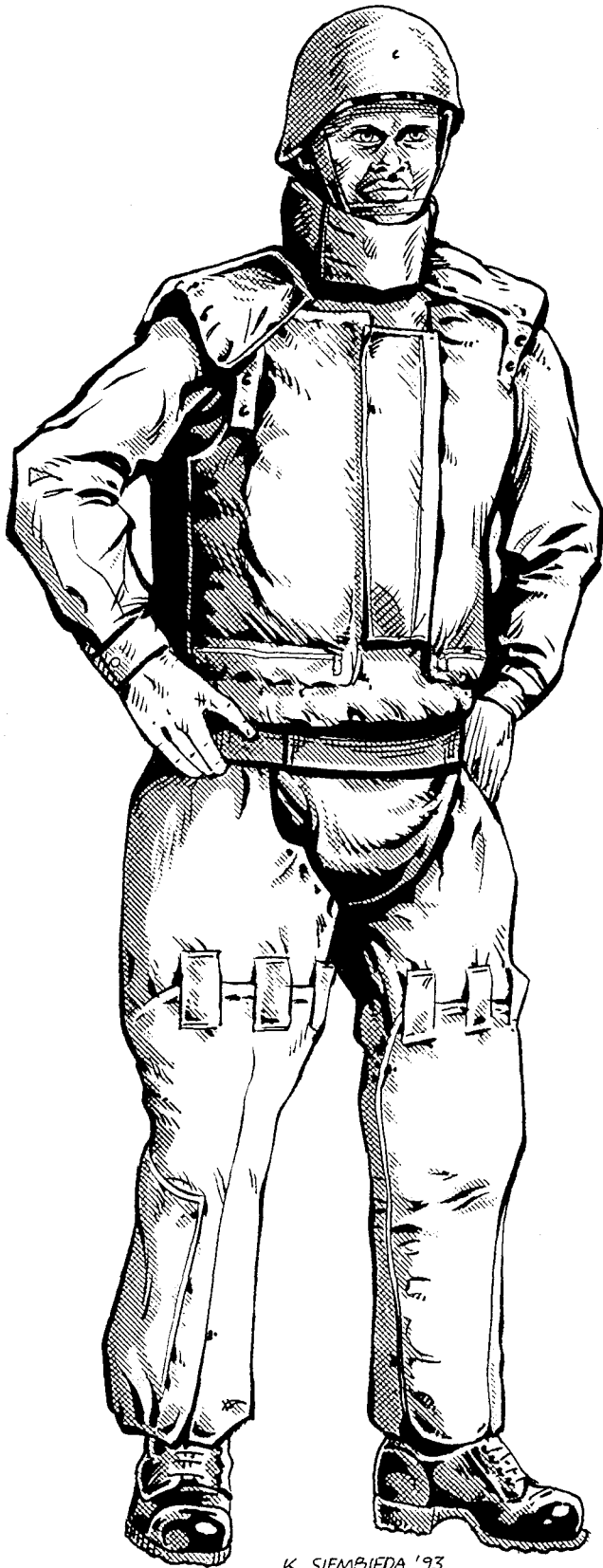

Vest only: Class IIA, IIIA; weighs 2.7 kg (6 lbs) and Class IV; weight: 3.6 kg (8 lbs)

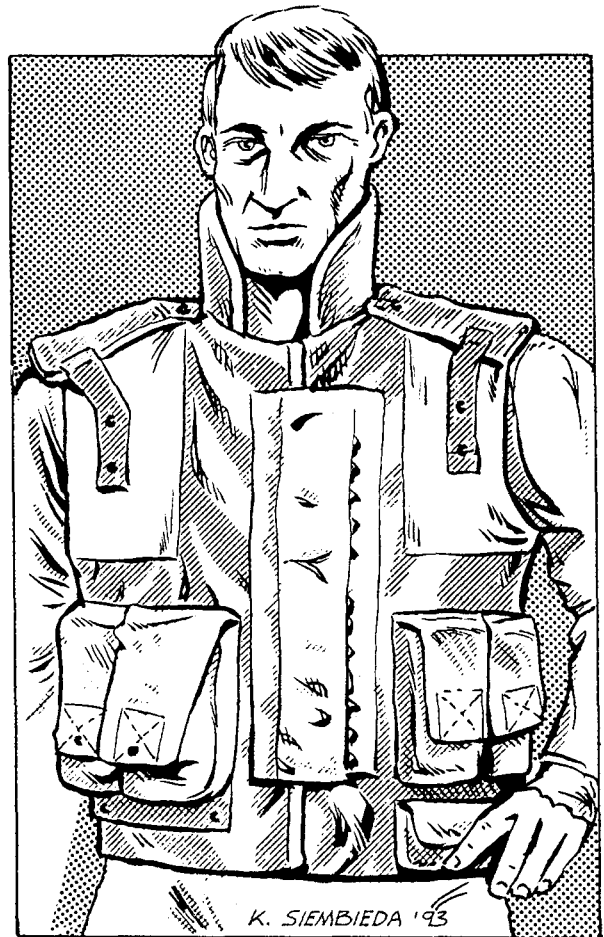

### **SEMA Personal Armour (France)**

This body armor comes in two different types: The "basic" model can be worn under or over normal clothing. Protection ranges from Class I to Class IIIA.

The military version is an over-jacket fitted with ammunition pouches and pockets. The protection afforded includes type Classes IIA, IIIA, IVA, IVB/C and Class V. The SEMA Class IV and V vests incorporate a combination of Kevlar, steel and ceramic plates.

### **Eagle armored body-suit (Israel & NATO)**

This full body-suit armor is available to most police, EOD, and military units. The Eagle garment is surprisingly comfortable, does not impede movement and does not require special care. It is a 24-layer suit constructed of Kevlar 29 and rigid plates of composite materials. This particular suit has been field-tested in operational situations and has saved lives.

## UK Series 25 Modular Armour

**Model FW25:** This is a full, wrap-around vest that protects the entire upper body with extra "side" protection and with a removable groin/pelvic protector. Class II/IIA and IIIA; 2.9 kg (6.4 lbs).

It can be uparmored by the insertion of a "Midi" ceramic front plate, adding 2.5 kg (5.5 lbs) or the larger and thicker "Midi" plate adding, 3.4 kg (7.5 lbs). The plates increase the armor class level to Class IVA or IVB/C.

**Restricted Entry Vest REV/25:** Similar to the previous vest except that it has been designed and tailored for parachute jumping, rappelling and movement in confined spaces; no pelvic plate. Class IIA, IIIA, or IVA

**General Purpose Vest GPV/25:** Basically the same as the FW25 except that it gives greatly increased areas of protection around the shoulders and underarms. The groin plate is wider to give additional protection to the hip and thigh. Class IIIA, IVA, IVB/C.



**Armorshield Ultra-Light Flak Jacket 777/FL17:** The jacket has been designed to be as light and thin as possible, yet maintain maximum protection. It comes in the form of a sleeveless vest with neck protector and pelvic plate. Two different sizes fits all. Velcro fasteners are concealed on the sides — there are no front openings or fasteners. Class IIIA. A ballistic plate insert uparmors the level of protection to Class IVA/B/C protection. Weight: 2.9 kg (6.5 lbs).

### ML Lifeguard Body Armor (UK)

The Lifeguard Equipment Company of the UK produces a variety of armors. The following are just a few.

### Ambassador Protective Vest

An armored vest designed for use by the police and military. It slips-on over the outer clothing and is fully adjustable at the sides and shoulders, secured by Velcro straps. Pelvic area protector is optional. Typically Class II/IIA and IIIA, but can be uparmored with trauma plates to Class IVA. A Class II/IIA vest weighs 2.5 kg (5.5 lbs). It is available in all armor class levels I-IVA.

## Anti-knife jacket

This jacket looks like a standard flak jacket. The difference is the type of insert. In order to provide protection against a knife attack, the anti-knife vest has a lightweight metal section, much like chainmail, which is in front of a kevlar panel on the front and back. The metal is not visible and the vest looks like any other flak vest. The vest weighs approximately 2.3 kg (5 pounds). Typically Class II/IIA.



## SWAT Model Jacket

This jacket has been designed to offer the maximum protective areas for the user while allowing unrestricted movement. It is adjustable at the shoulders and sides. A typical Class II/IIA or IIIA jacket weighs approximately 4.25 kg (9.8 lbs). It is available in all armor class levels I-IVA.



## Helicopter Jacket

This jacket is specifically designed for helicopter pilots. It is specially designed for quick release in the event of a fire or crash emergency. The jacket weighs approximately 3 kg (6.9 lbs). Typically Class II A or IIIA.

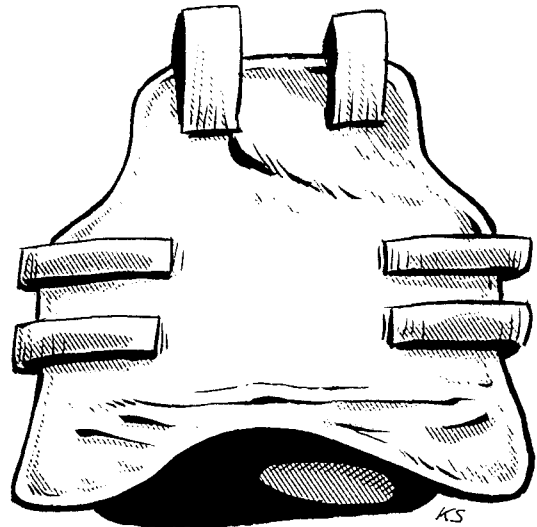

## Soft body armor TFV-U/0-9NATO

This is a lightweight slip-over vest intended for quick insertion. It is made in two parts and closes at the sides with Velcro. It

weighs just 2.17 kg (4.9 lbs) and is made out of Kevlar. It can protect an area of up to 3387 square cm (3.5 square feet). It will protect against pistols and submachine guns to 9mm Parabelum with a velocity no higher than 400 m/s. Class II/IIA and IIIA.



### Immediate Response Jacket

This jacket has been designed specifically for special forces in both military and police work. The jacket is made of lightweight nylon netting, which makes it cool and ideal for hot climates. On the average, the jacket only weighs 1.5 kg (3.2 lbs) which is much lighter than most. This jacket allows total freedom of movement and offers rapid access to all weapons and items which he is carrying. Pockets are lined with tough Belflex material. Class I or II/IIA.



### Flak Jacket

This jacket is primarily for military use. It has shoulder padding so that a weapon may be fired from either shoulder. Protection is provided to the front, back and groin of the wearer. A typical Class II/IIA or IIIA vest weighs approximately 4.5 kg (10lbs). It can be uparmored to Class IVB/C with insert plates.

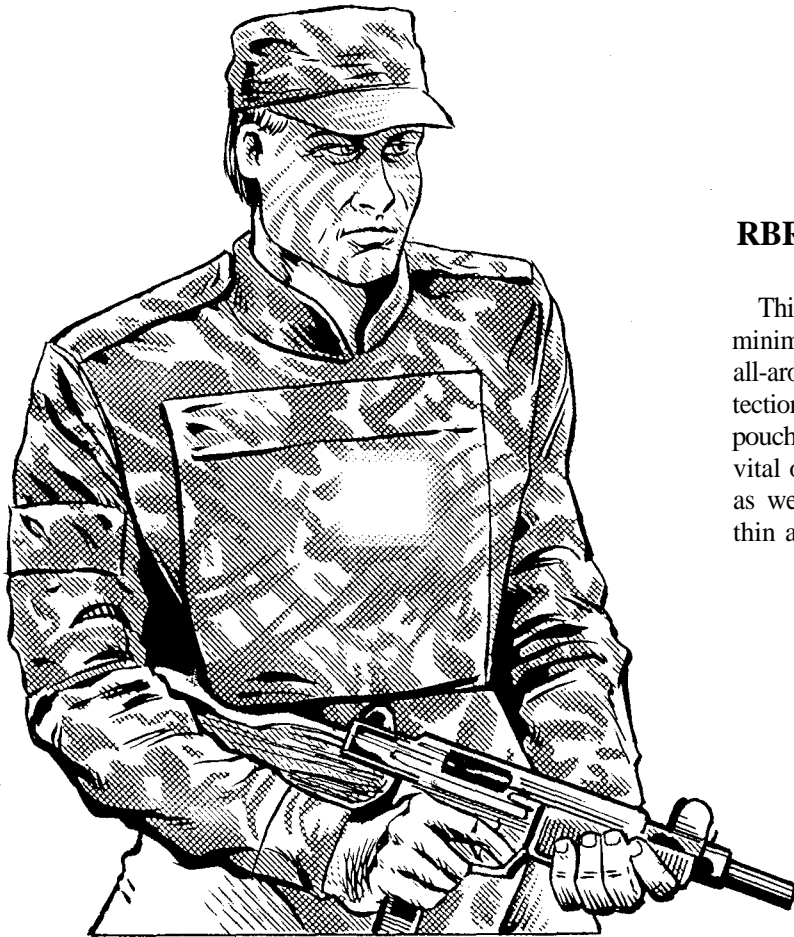

### RBR 3001 Military Jacket (UK)

This jacket was designed to give maximum protection with minimum weight to reduce fatigue during combat. It will give all-around protection against grenade fragments as well as protection against pistol and sub-machinegun attacks. There are pouches for inserting ceramic plates for increased protection to vital organs. You can also get attachments for groin protection as well as detachable pockets and ammunition pouches. It is thin and easily concealed. Weighs 2.7 kg (7 lbs). Class IIIA.

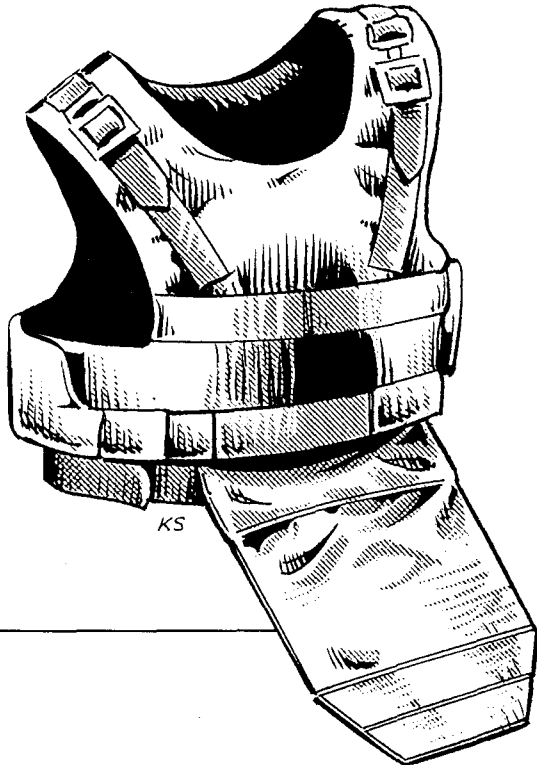

### Rigid body Armour TFV-R-G20 (Italy)

This is a rigid body armor composed of three pieces to protect the front, rear and groin. When not needed, the pelvic portion may be removed or folded up and fastened to the front. The armor weighs 2 kg (4.4 lbs), with a thickness of 4.5 mm. It will protect an area of approximately 4000 square cm (4.1 square feet). The protection afforded by this vest will stop a .357 Magnum, 9mm Parabellum to a .44 Magnum. Class IIA and IIIA.



### Highmark Bomb Disposal Suit (Ireland)

The Highmark Company of Belfast, Ireland has developed a full range of body armor used by civilians, police and military around the world. They include low profile "concealed" vests to full body EOD suits and hard armor. All soft armor uses Kevlar. Hard armor uses Kevlar and ceramic and steel plates.

**Mark Ia Ultra-light soft armor concealed vest:** Class I and II; 1.2 kg (2.8 lbs).

**Mark I soft armor vest:** Class I, II/IIA; 1.4 kg (3 lbs).

**Mark II/IIa soft armor vest:** Class IIA and IIIA and can be uparmored with the addition of multi-curvature ceramic armored plates to Class IVA.; 1.8 (4 lbs) without plates, 2.7 kg (6 lbs) with plates.

**Mark III soft armor vest:** Class IIIA and uparmorable to Class IV and V; 2.7 to 3.6 kg (6 to 8 lbs).

**Mark III EOD full body suit:** Class IIIA or IVA; 10 kg (22 lbs).

**Hard Armor Category III:** Class IIIA; 2.7 kg (6 lbs).

**Hard Armor Category II:** Class IVB/C; 3.6 kg (8 lbs).

**Hard Armor Category I:** Class V; 4.1 kg (9 lbs).

**Undercover Body Armor/Mark I:** Comes in nine different models, including quilted body-warmers, VIP waistcoats worn with business suits, safari jackets, denim jackets and corduroy jackets. Class I and II.

**Police & Riot Body Armor/Mark II:** Class II/IIA and IIIA.

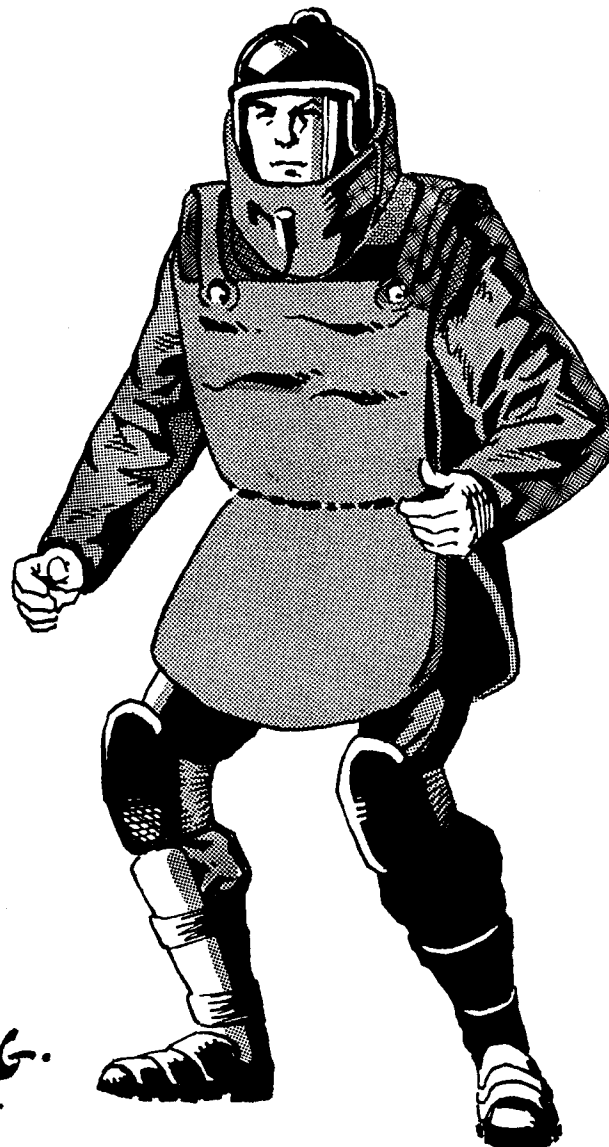

**Military Armor/Mark III:** Is usually Class IIIA and comes with a matching ballistic hood (Class I).

**Anti-Riot Shield:** Class IIIA and IVA; 6.8 kg (15 lbs).

### Body Shield Fragmentation Vest (USA)

This vest may be constructed with 10, 16 or 18 layers of Kevlar and may be upgraded with the use of ceramic plates to withstand high-velocity rifle rounds. This vest can also be incorporated into discreet styles such as ski and sports jackets, a dress vest or waistcoat, a hunter's vest, a dress shirt or undershirt. Typically Class I, II/IIA or IIIA; average weight is around 3.2 kg (7 lbs).

### BETA Vest (USA)

The Building Entry Team Armor is made from 1000-denier Cordura nylon. In the front are pouches for ammunition/grenades/radio. Typically armor level Class IIA or IIIA.

## Ranger Tactical Vest (USA)

This protective garment offers state-of-the-art ballistic protection. The vest is made entirely of Kevlar and comes with a protective neck collar, armored shoulder pads and lined with 400-denier waterproof nylon. The standard design offers ammunition pouches, shotgun/grenade cartridge loops, and built-in pistol holster. The typical vest is Class IIA or IIIA. The addition of rifle-resistant inserts, Hex Hard Case, a ceramic laminate and 7mm Zoned Armor Steel, raises the protection to Class IVA.



## Ultra Cool Ventilating Undergarment (USA)

This is an undergarment designed to be worn under body armor which has to be worn for prolonged periods of time. The ribbing of this shirt creates channels when the outer garment is placed over it. This allows air to flow between the garment and the undershirt. No armor class rating.

# Riot Control Devices

Notes: Most countries have some sort of riot control plan and equipment. The following are just a few examples.

## Riot Control Shields

wide use in the United Kingdom and Israel, but are also used in the United States, China and many other countries.

The shields are primarily designed to protect law enforcement officers from thrown projectiles (rocks, bottles, etc.), liquids, stray bullets, and other forms of violence. The tough shields can withstand battery with clubs, stabbing knives and the penetration of most handguns and rifles. Machinegun fire will penetrate and the shields offer no protection against explosive concussion.

Many law enforcement agencies around the world utilize riot shields. There are a variety of shields on the market, but most are constructed of transparent polycarbonate or high-impact plastic materials which are virtually indestructible yet lightweight. This provides the user with maximum protection and minimum encumbrance and fatigue. Such riot shields are in particularly

All are made of tough, high-impact plastics. The transparent varieties seem to be the most popular. The shields come in a variety of sizes and shapes. Round and rectangular are the most common. The newest shields have better handles and padding for the arm to reduce the impact shock and some are also chemically treated with fire retardants.

Typical thicknesses are 3 mm and 4 mm (about 1/8 of an inch) and they have an average weight of 1.8 to 2.7 kg (4 to 6 pounds).

**Most riot shields are Class IIIA or IV** and are resistant up to and including P.V. 6 and most special rounds. **Note:** High caliber rounds that have a P.V. of 5 and 6 strike with such a hard impact that the shield user will be staggered and possibly (50% chance) be knocked to the ground unless he is kneeling and braced for impact. The shock of impact will cause the shield user to be stunned for 1D4 melee actions/attacks. Furthermore, the arm will be bruised and sore.

**Full riot gear** typically includes a helmet with impact resistant visor/face shield (Class IIIA: stops rounds up to P.V. 5 and some P.V. 6), quilted vest/padded armor (stops rounds up to P.V. 2), elbow, forearm, leg and knee protectors (stops rounds up to P.V.4), but increases the overall weight by 20% and restricts movement by 5%. Armored vests (typically Class II/IIA or IIIA) can be worn instead of the quilted vest for greater protection.

## Riot & Combat Helmets

**The typical anti-riot helmet** is equal to a body armor of Class I and comes complete with a transparent, protective visor or face shield. It is designed to ensure good protection against shock from clubbing and being struck by thrown projectiles. **Weight:** 1.4 kg (3 lbs).





A **bullet-proof, anti-riot helmet** is designed to ensure protection against pistol bullets. The outer helmet is a hard shell made from a high-impact plastic or fiberglass. The inner helmet is lined with layers of Kevlar fabric padding to absorb shock, and foam. Most are equipped with an articulated, 3 mm thick protective visor (made of the same plastics as the riot shield) and a neck cover made of Kevlar fabric.

Most are equal to body armor Class II/IIA (resistant to P.V. 1-4) and can resist 9mm and even .357 Magnum bullets fired from a close range (15 m/50 ft). The heavier, military helmets are often Class IIIA.

At closer range, the high caliber rounds may penetrate (25%) the helmet. At point-blank range (3 m/10 ft or closer), they are even more likely to penetrate (50%). **Average weight:** 1.4 kg (3 lbs) without the visor, 1.6 kg (3.4 lbs) with the visor.

**Special Shotgun Ammunition:** Shok Lock cartridges are loaded with a unique ceramic-metal projectile for shooting locks and hinges off of doors. The projectile disintegrates into a fine powder on impact, thus greatly reducing the chance of injury to the people inside the room (no shrapnel or bullet fragments). P.V. 5, 5D6 damage.

Starflash cartridges are roughly equivalent to the stun/flash grenade, traveling about 50 m (164 ft) before exploding with a **bang**, flash and shower of white-hot **sparks**. Covers a 3 m (10 ft) area.

Tearblast cartridges are the equivalent to CS/tear gas grenades but with about half the radius of effect; 3 m (10 ft radius) — enough to fill a small room.

Multi-Ball low lethality cartridges are buck-shot with tiny, soft rubber balls. Damage (1): 1D6, P.V. 1, but shock is equal to a medium caliber pistol.

**Rubber Bullets:** Damage: 1 point per bullet; P.V.: None, and shock is equal to a low caliber handgun.

**Rubber Batons & Inert Grenades/Rockets:** Damage (2): 1D8/2D4 each, P.V. 1, and shock is equal to a medium caliber handgun.

**Stun/Flash Grenades:** This type of grenade is designed to confuse and disorient terrorists or criminals who are holding hostages in confined places. The grenade makes a loud exploding boom and a bright flash (and some smoke) which startles and blinds the terrorists. Many stun/flash grenades, like the M459 'Starflash,' provide a brilliant shower of white-hot **sparklettes** for enhanced effect. Covers a 6 m (20 foot area). Palladium RPG System: Victims are — 8 to **strike**, **parry**, and **dodge**, - 1 initiative and lose one **melee attack/action** for the next 1D4 **melee rounds**.

**CS/Tear Gas:** This type of chemical gas is often used for riot control. The grenade releases a cloud or vapor that reacts with the eyes and skin of all who are exposed to its chemical agents. Typically, the gas causes the eyes to **burn/sting** and water profusely, causing great discomfort and make seeing difficult. It also burns the throat and nasal passages, causing coughing and difficulty **breathing**, as well as irritating exposed **skin**. Only a gas mask can completely protect a person from CS/Tear gas type attacks. The effects last for 3D4 minutes after leaving the tear gas filled area. Area of Effect: 7.6 m (25 ft) radius, enough to fill a large room. The gas is most effective in small, confined indoor areas/rooms. It is not as effective outdoors where the wind can carry the gas away. Palladium RPG System: Victims are — 10 to **strike**, **parry**, and **dodge**, — 3 initiative and lose one **melee attack/action** for the next 1D6 + 1 **melee rounds**.

**Smoke Grenade:** P.V. 1, releases a cloud that covers an approximate 6 m (20 ft) radius; used for troop cover and crowd **dispersement/riot control**. Obscures vision in and through the smoke cloud and causes minor difficulty **breathing**. Infrared optic systems cannot see into or through smoke. Palladium RPG System: Those in the cloud are — 5 to **strike**, **parry**, and **dodge** and — 1 on **initiative**. Attackers firing into/through the cloud are shooting completely **wild!** Aimed shots or controlled bursts are impossible (the shooter cannot see the **target!**)!

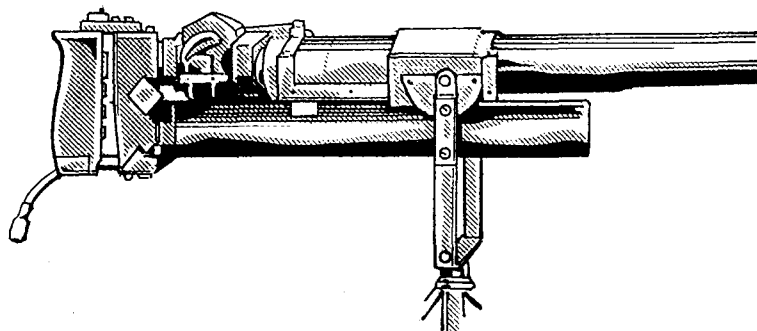

### Browning SA Pneumatic Grenade Launcher

This weapon is a low-velocity gun designed to be used either free standing or mounted on a light vehicle. It is equipped to fire any 48mm **grenade**, including M5 tear gas, stun and smoke grenades.

**Caliber:** 48mm, **Overall Length:** 810mm, **Weight of Launcher:** 3.5 kg without feed system, **Rate of Fire:** 15 rounds

per minute, **Blast Diameter:** varies with type of grenade, **Damage:** varies with type of grenade; riot control, **Approx. Effective Range:** Launcher: 150 m (492 ft).



### MECAR Disorienting Grenade DS-RFL-35 BTU M278

This projectile is made to be used as a shoulder-fired rifle grenade to penetrate light structures such as doors, windows and so on. It can also be used to disorient, shock and stun human targets by the use of intense illumination and sound.

**Length:** 321mm, **Weight:** 360 grams, **Approx. Effective Range:** 150 m (492 ft) when fired from a 5.56mm or 7.62mm rifle with a 22mm diameter muzzle or adaptor. **Note:** P.V. 4, Damage (5) 4D6.

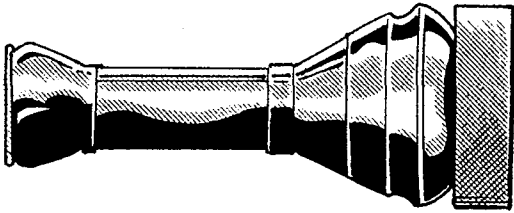

### MECAR Anti-Riot Baton AR-RFL-75 BTUM296

This projectile is an inert grenade/baton having a conical body with a flat, round cushioned head. It is used as a shoulder-fired rifle grenade to strike rioters in the head or body with non-lethal effect. It can also shatter windows.

**Length:** 175mm, **Weight:** 380 grams, **Maximum Effective Range:** 75 m (246 ft) when fired from a 5.56mm or 7.62mm rifle with a 22mm diameter muzzle or adaptor. **Note:** P.V. 1, Damage (2): 1D8 or 2D4 each hit, shock equal to medium caliber handguns.

## FRANCE

### Ruggieri Illuminating Rifle Grenade

This grenade can be fired from any 5.56 mm, 7.5mm or 7.62mm rifle, by fitting the grenade over the muzzle of the rifle. It is fired with a blank cartridge, which comes with each grenade. It is recommended that the rifle butt is place on the ground before firing. The illuminating grenade provides 20 seconds of 60,000 candela light.

**Length:** 228mm, **Diameter:** 40mm, **Weight:** 280 grams, **Delay:** 2 seconds, **Damage:** N/A, **Approx. Effective Range:** At 70 degree angle: 80 m (262 ft), at 45 degree angle: 300 m (984 ft).

### Ruggieri Type 241 Blinding Hand Grenade

This grenade was designed to temporarily blind one or more persons. It achieves this by emitting a blinding flash and a loud, but not deafening report/bang. The victim can then be apprehended safely. This grenade is a low powered weapon and can be safely used at a distance of one meter (3 1/2 ft) and its effects last approximately two minutes.

**Length:** 120mm, **Diameter:** 50mm, **Weight:** 100 grams, **Delay:** 1.5 seconds, **Weight:** 130 grams, **Blast Diameter:** 3 m (10 ft), **Damage:** Stun/blind, **Approx. Effective Range:** Thrown 30.5 m (100ft).

## Ruggieri Spider In-Vehicle Defence System

The Spider defence system was designed for protection against personnel and light armored vehicles. It can be loaded with a number of different ammunition: **CAPIRO 50** is loaded with 900 tungsten balls which when fired, can penetrate 7mm (.28 inches) of aluminum at 20 m (68 ft; 1D6 x 10 damage, P.V. 6); **SOUND** uses the same charge as the CAPIRO, however instead of firing a warhead, it emits a loud report which is meant to disorient its target (lose 1D4 combat/melee actions that round, - 1 on initiative, strike, parry and dodge); **SEPIA** is a non-toxic smoke projectile (combination CS gas and smoke; the smoke provides concealment through the visible and infrared spectrum); **SEPMI** is almost the same as the **SEPIA**, however it only obscures the visible spectrum. Each of the shells are loaded in pre-packed magazines with two projectiles, each with variable warhead, with a maximum range of 44 m (145 ft).

The system is also designed so that either all the projectiles may be fired simultaneously or they may be fired individually. Depending on the configuration of this unit, it can weigh from 40 to 150 kg (90 to 330 lbs).

## UNITED KINGDOM

### Arwen Ace Low Lethality Weapon

The Arwen Ace is a single-shot 37mm weapon specifically designed for law enforcement use. It is lightweight and needs very little maintenance. It can fire a variety of different ammunition which is listed after the basic statblock.

**Cartridge:** 37mm rimless, **Operation:** single shot, mechanical, auto-ejecting, **Length:** 760-840mm adjustable to 12 positions, **Weight:** empty 2.1 kg, loaded 2.3 kg. **Range:** Varies per ammunition type.

#### Ammunition:

##### AR1 kinetic energy baton round

Weight: 80 grams  
Velocity: 74 m/s  
Range: 20-100 m (68 to 328 ft)  
Damage (2): 1D8 or 2D4  
P.V.: 1

##### AR1 RE reduced energy baton round

Weight: 80 grams  
Velocity: 50 m/s  
Range: 0.3-30 m (1 to 100 ft)  
Damage (1): 1D6  
P.V.: 1

##### AR2 irritant smoke round and AR4 screening smoke round

Weight: 120 grams  
Velocity: 54 m/s  
Range: 60 m (200 ft)  
Area covered: 78 square meters (840 square feet).

##### AR3 frangible-nosed irritant baton round

This round fractures on impact, delivering the CS irritant while the remainder of the round delivers a less-than-lethal body blow.

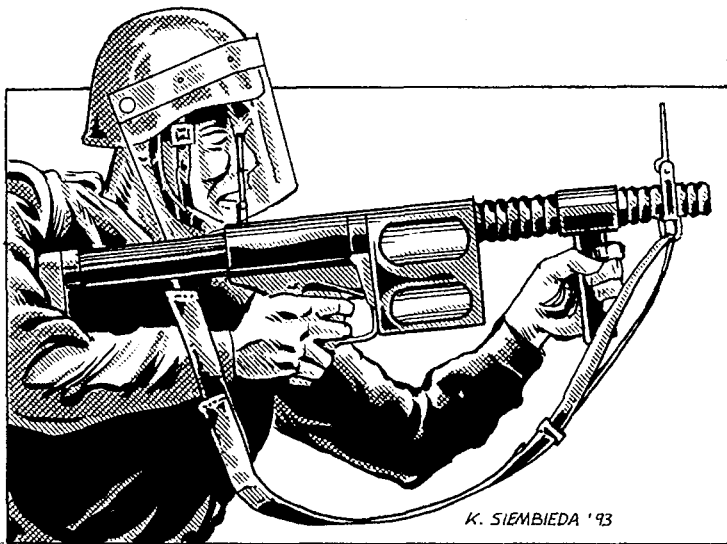

Weight: 76 grams  
 Velocity: 76 m/s  
 Range: 20-50 m (68-164 f)  
 Area covered: 1 square meter (3 1/2 square ft)  
 Damage (1): 1D6 plus CS  
 P.V.: 1

#### AR5 barricade penetrating round

This cartridge is designed to penetrate a barrier and then release CS gas.

Damage (5): 4D6, P.V. 4.  
 Weight: 60 grams  
 Velocity: 138 m/s  
 Penetration ranges: Glass window: 80 m (262 ft)  
 Hollow core door: 60 m (200 ft)  
 12mm (.5 inch) plywood: 40 m (131 ft)  
 Auto glass: 20 m (68 ft)

## UNITED STATES OF AMERICA

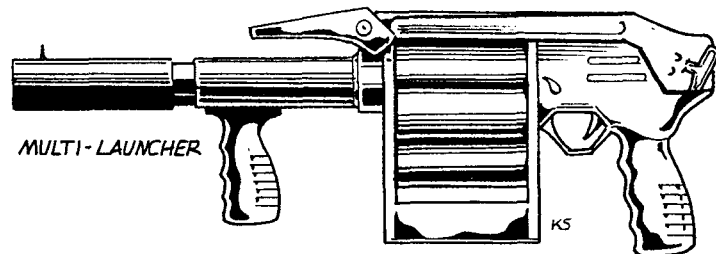
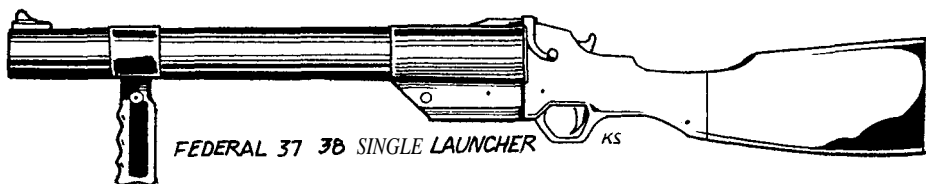

#### Federal L6 37mm Multi-launcher

This is a six-shot tear gas launcher capable of firing at a rapid rate.

**Caliber:** 37mm, **Capacity:** 6 shots, up to 157mm in length,

**Length:** 864mm stock extended, 610mm stock folded, **Weight:** empty, 3.85 kg, **Barrel:** 305mm. **Blast Diameter/cloud:** 4.6 square m (50 sq. ft), **Damage:** CS/Tear gas causing difficulty breathing and seeing, **Approx. Effective Range:** 175m (492 ft).

#### Stingball Grenade

The Stingball grenade is a fragmentation device that discharges over a hundred, marble-sized, soft rubber pellets.

**Weight:** 380 grams, **Length:** 96mm, **Diameter:** 50mm, **Weight of Charge:** 30 grams, **Number of fragments:** approx. 100, **Delay Time:** 3.5 seconds nominal, **Blast Diameter:** 6 m (20 ft), **Damage:** 1D4, **Shock:** Equal to a low caliber handgun. **Range:** Thrown: 30.5 m (100 ft).

#### Comboball M452C

A sister device to the Stingball that combines a powdered CS irritant agent dispersed among the rubber pellets to provide a double effect.

**Weight:** 380 grams, **Length:** 96mm, **Diameter:** 50mm, **Weight of Charge:** 30 grams, **Number of fragments:** approx. 100, **Delay Time:** 3.5 seconds nominal, **Blast Radius:** 6 m (20 ft), **Damage:** 1D4 plus CS agent, **Shock:** Equal to a low caliber handgun. **Range:** Thrown: 30.5 m (100 ft).

#### Stun-Gun System

This rifle-like gun is based on a 40mm caliber discharger which shoots a collapsed cloth bag filled with metal shot. When fired, the bag spins and expands to its full diameter of 76mm and flies into its target. On impact, it will hit hard enough to knock a man down at ranges of up to 200 m (656 ft). **Damage (3):** 2D6 each, **P.V.:** 1, **Shock:** Equal to a heavy caliber handgun.

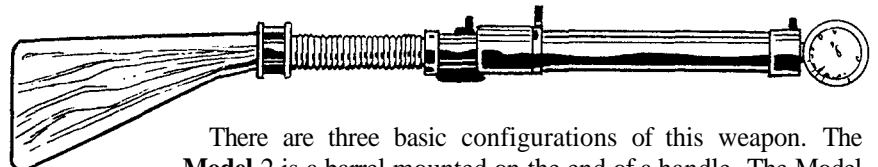

There are three basic configurations of this weapon. The **Model 2** is a barrel mounted on the end of a handle. The **Model 3** is a slight variation in that the handle is **extended**. The **Model 4** is yet another variation with an attached stock.

There is another application for this weapon when circumstances demand less power or a non-firearm solution. The **'Prowler-Fouler'** are baton-like discharges which use compressed gas as the **propellant**. By using different types of bottled gas or using them in combination, the available power can propel the bag to ranges from 10 to 100 m (32 to 328 ft). **Damage (2):** 1D8/2D4 each, **P.V.:** 1, **Shock:** Equal to a low caliber handgun.

#### M429 Grenade Launching System (for revolvers & shotguns)

The launch system consists of an adaptor, plastic sabot and a special blank cartridge. The launching system can be used to fire a variety of different Accuracy System Inc. riot control

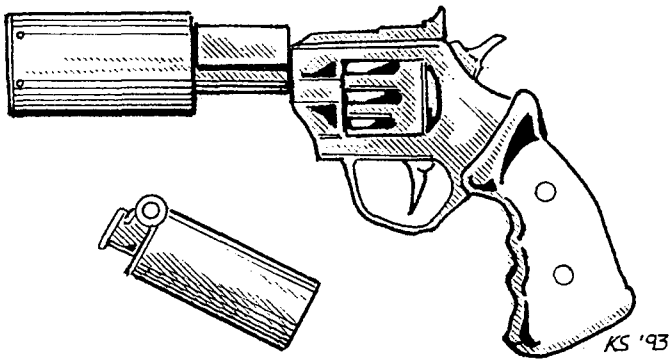

grenades, including the CS gas, M400, M408, M425, M450 (multi-flash), M451 (multi-flash), M470 and M471 grenades.  
**Approx. Effective Range:** Shotgun or revolver: 75 m (246 feet).

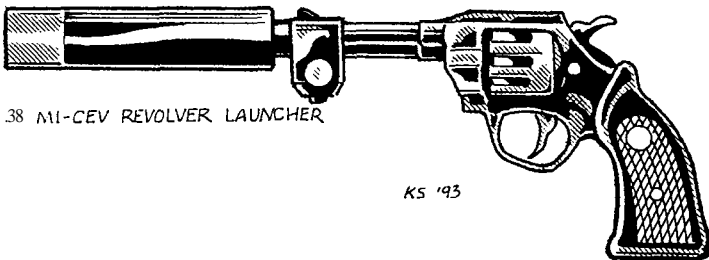

projectile which may consist of a liquid, loose material or solid according to the type of explosive to be detonated.

**Country:** France, **Length of Gun:** 320mm, **Weight:** 2.5 kg, **Caliber:** 30mm, **Weight of Base:** 9 kg, **Weight of Case and Contents:** 12 kg.

### Hobo L3A1 EOD Robot

Originally designed for use in EOD and IED situations, the hobo robot has also been found to be useful in fire-fighting, nuclear incidents, terrorist and hostage situations. It has six wheels which are all driven independently and gives the vehicle the ability to maneuver through the roughest terrain, through mud, water, sand or snow.

This unit can be operated either via radio control or with a 150 m (492 ft) umbilical cord (which can be extended up to 500 m/1640 ft). When using radio control, the range is limited to one km (0.8 miles) line of sight operation.

This robot also is equipped with a three camera system, as well as having a manipulative arm, 440 degree turret rotation, 180 degree wrist rotation, and 360 degree claw rotation. It also comes equipped with front and rear claw arms.

**Country:** Ireland, **Control:** By radio remote-control or via umbilical cable, **Drive:** 6-wheel independent electric drive, **Speed:** 0-4.8 km/h (3 mph), **Weight:** 228 kg.

## EOD Equipment

The data presented here on Explosive Ordnance Disposal (EOD) equipment offers a small selection of devices, tools, blankets, and robots used in the removal and detonation of explosives. Most all nations have comparable EOD equipment like those presented in this very short, basic list. Also see the Body Armor section for some EOD suits and other types of protective armor.

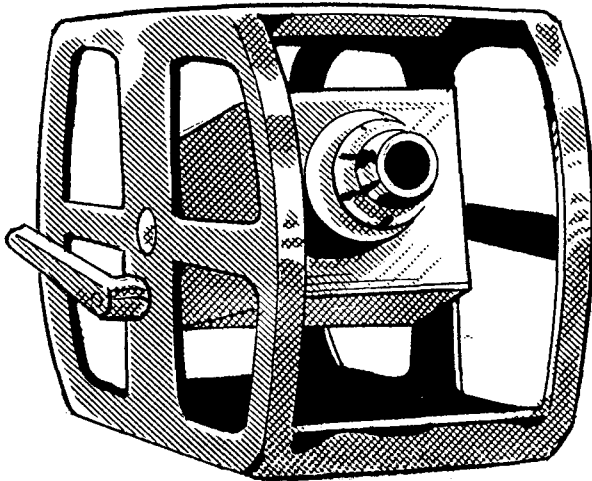

### Manurhin Disrupter Gun

This weapon has been designed to neutralize, through partial detonation, improvised explosive devices (IEDs). The gun is electronically fired at the IED using a special cartridge with a

### Bomb Suppression Blankets

This blanket is intended to be used to cover suspected bombs while awaiting examination. Should the bomb explode the blanket would contain much of the blast and fragments, protecting the surrounding personnel.

**Country:** Ireland, **Size:** 1.22 x 1.22 m (4 x 4 ft), **Weight:** 14.51 kg

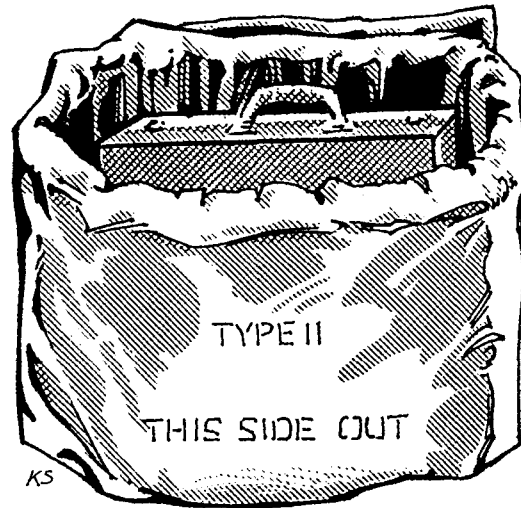

### SC-2 Safety Circle

The safety circle is a cylinder of ballistic nylon cloth and is made to be used in conjunction with the suppression blanket. The suspected bomb is placed inside the circle and then covered with the blanket. The circle is constructed so that the item can still be x-rayed without requiring it to be uncovered. The blanket and circle can be removed by EOD robots quite easily.

**Country:** USA, **Weight:** 6.8 kg, **Depth:** 432mm, **Circumference:** 1.83 m.

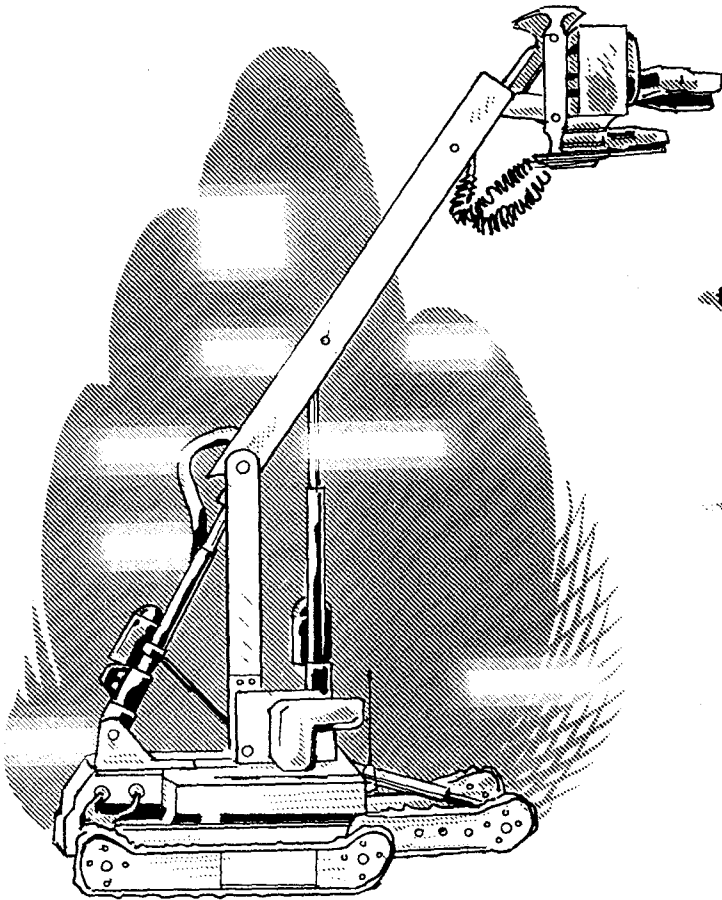

### Imp miniature EOD Robot

This robot was specifically designed for use in areas where access is denied to larger robots. The unit is best suited for use in aircraft, trains, ships and building interiors. However, it is more than just a surveillance vehicle, in that it may be equipped with disruptors, a shotgun, explosive sniffers, x-ray equipment and surveillance devices.

In its standard form the Imp has a radio and video control, reconnaissance arm, monochrome camera, lights, sound system and antennas. The control console has a 9 inch monitor, operational controls, detachable hand control with joystick, 100 m (328 ft) cable, antennas, battery charger and carrying case.

**Width:** 420mm, **Length:** 800mm with front ramp retracted; 940mm with front ramp extended, **Vertical Reach:** 1.2 m, **Horizontal Reach:** 1.2 m, **Weight:** 75 kg, **Speed:** 200mm per seconds (0.45 mph).

### Liquid Nitrogen Neutralizer

This is designed for the instant interruption and stoppage of the battery power supply of an explosive device's activation circuits. In addition, should the device contain a clock, simultaneous stopping of the balance mechanism occurs. This effect is produced by the extremely low temperature of the liquid nitrogen, which has a boiling point of - 196 degrees C. **Country:** Yugoslavia.

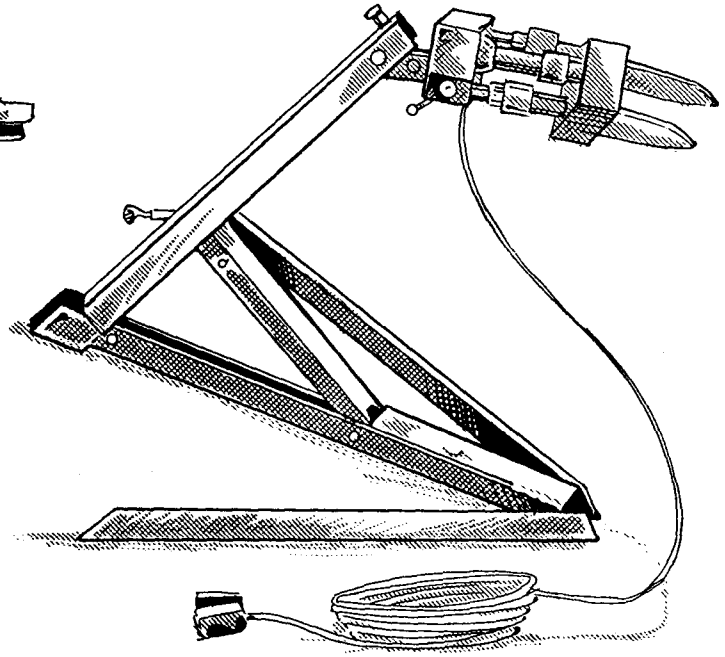

### Model 1152 Disruptor

This device has been designed for the disruption of IEDs by firing a charge of water by means of an electrically initiated cartridge. It is used for the disruption of explosive devices placed in bags, cases, parcels and similar objects, leaving the explosive contents undamaged. It is used either singly or in pairs, mounted on a special telescopic, aluminum stand.

**Country:** Yugoslavia, **Length:** 290mm, **Diameter:** 45mm, **Water Charge:** 100cm, **Weight:** 480 grams.

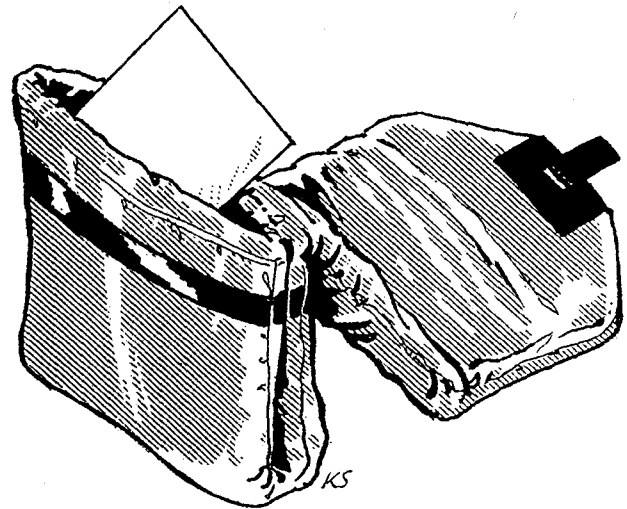

### Letter-bomb Suppression Pouch

This is a simple, but effective pouch used when there is a threat of a letter bomb. The suspected bomb is placed inside the pouch, which is made of ballistic nylon and kevlar. Typically, a line is attached to the pouch and it is dragged to a safe place to await disposal or detonation. Should the bomb explode, the pouch should contain all or most of the force.

**Country:** USA, **Weight:** 6.8 kg, **Measurements:** 432×457×127mm.

# Revolvers & Pistols

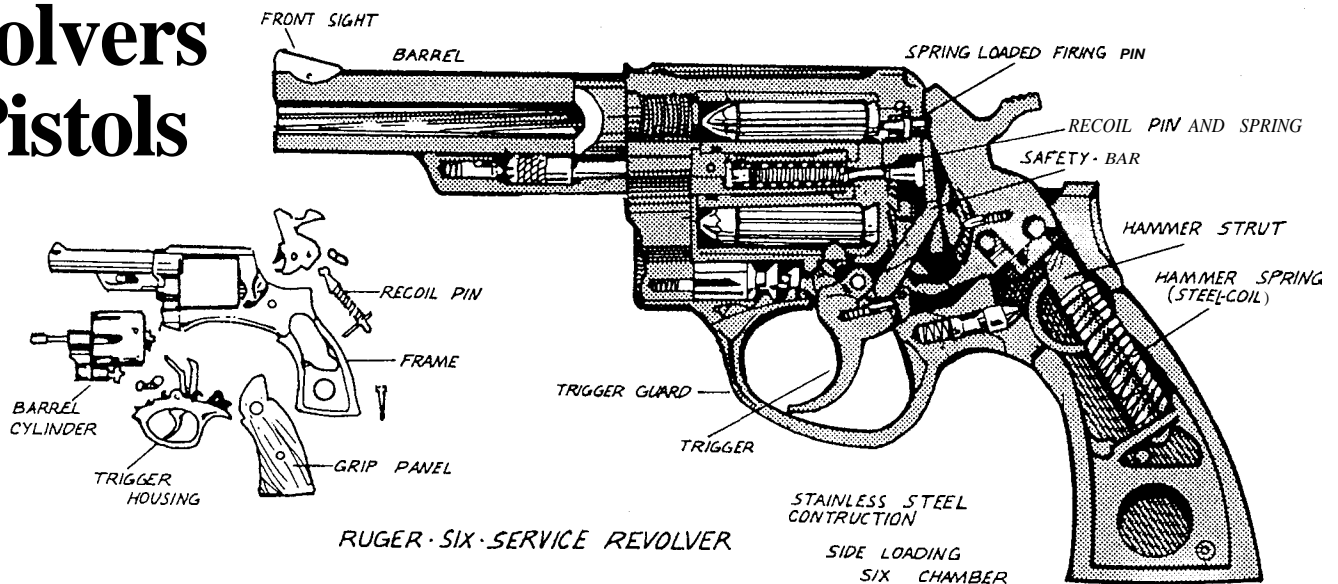

## Revolvers

The **single-action** revolver is the predecessor to the modern revolver which required the cocking of the hammer, by hand, between shots. The cocking action causes the cylinder to rotate to the next round. The trigger only releases the hammer.

The **double-action or self-loading** design was introduced to the public around 1830, but did not gain significant popularity until the late 1850's. The activities of the Colt company were a major factor in the early development and popularity of the double-action revolver. The double-action revolver enables the operator to cock the hammer and rotate the cylinder simultaneously, and then release the hammer with one trigger pull. Most types can also be thumb-cocked like the old single-action revolvers.

The double-action revolver is simple to operate. The ammunition in the chamber is clearly visible and never misfires. If a shell should jam or is a dud, the operator need only press the trigger, rotating the cylinder to the next shell (an automatic would need to be cleared by hand). The firing mechanism produces a smooth trigger action, promoting good accuracy. The larger caliber revolvers can usually fire a variety of bullet loads with no appreciable difference.

On the negative side, these weapons are bulky and difficult to conceal. They are generally limited to six rounds and require a long time to reload compared to automatic weapons. The low muzzle velocity of revolvers is due to the weapon's design that allows gas to escape where the cylinder and forcing cone meet. A long-barreled revolver will have a greater velocity, but still falls short of most automatic weapons. Of course, the greater the velocity the better the penetration, especially at a distance.

## Automatic Pistols

Automatic pistols are weapons which automatically advance each spent shell. To do this the trigger must be pulled and released for each shot fired. A person can fire an automatic pistol as quickly as he/she can pull the trigger. It is important to point out that most "automatic" pistols are not truly automatic, but "self-loading." Very few, such as the Soviet **Stechkin**, are true automatics, which means they will fire successive rounds from one trigger pull until the trigger is released. The problem with a totally automatic pistol is that, because of the way the

weapon is gripped, the muzzle moves upward after each round. This decreases the accuracy of hitting the target with each round.

In most cases, the self-loading (automatic) pistol is a very effective weapon. High muzzle velocity provides maximum penetration even at great distances. Replacing the magazine (clip) is extremely simple, requiring but a few seconds. Automatic magazines tend to have a greater cartridge (bullet) capacity, carrying eight, thirteen or even more rounds, depending on the particular **weapon**. Most of these pistols are flat and unobtrusive, which makes them easy to conceal.

However, for all of its good points there are **drawbacks**. The trigger pull is rarely as smooth as a revolver, reducing the accuracy of the weapon when used by the unskilled (though many would argue it is not an appreciable difference). It has a complicated firing mechanism which, under certain conditions, could make maintenance a problem. Furthermore, the ammunition is concealed in the magazine so unless you are counting your shots, you could suddenly find yourself out of ammo. All misfires of ammunition (jamming, duds, etc.) must be cleared by hand, which could be dangerous depending on the nature of the **misfire**, as well as requiring what might be crucial **seconds**. Unlike many revolvers, which can fire a variety of bullet loads from the same gun, the automatic pistol can fire only the types of ammunition for which it is specifically designed; i.e. a 9mm can only fire 9mm rounds.

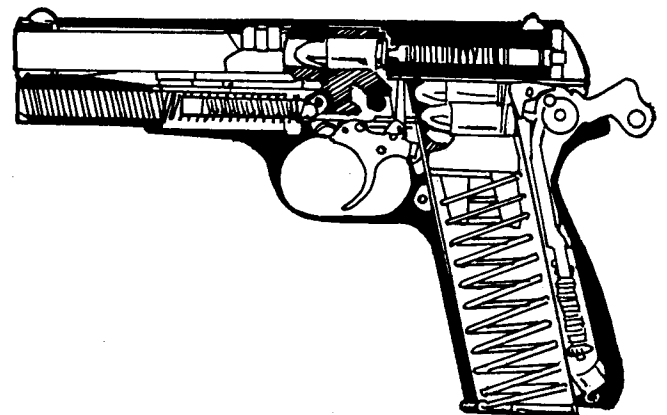

THE TRIGGER MECHANISM  
OF THE AUTOMATIC PISTOL.

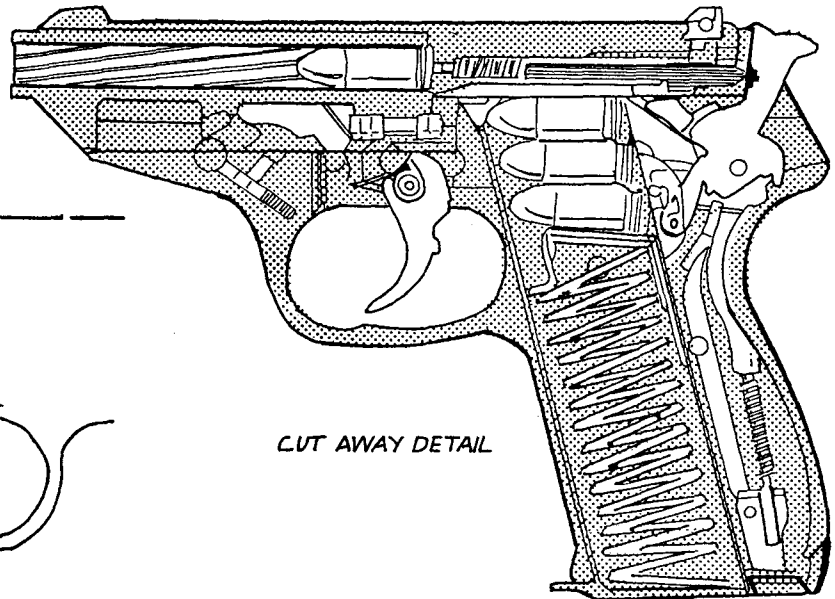

CUT AWAY DETAIL

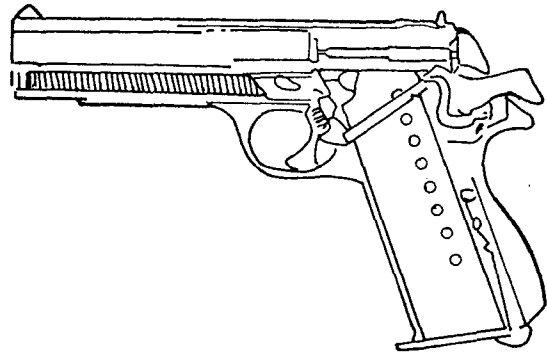
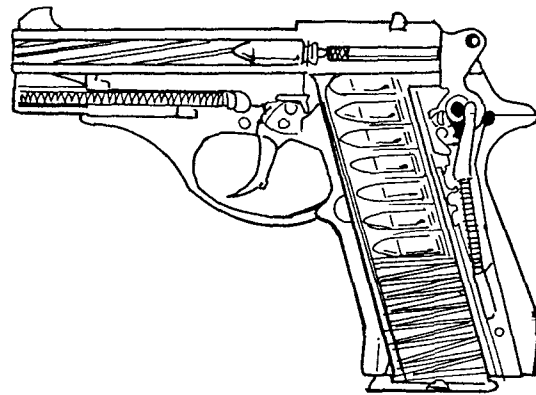
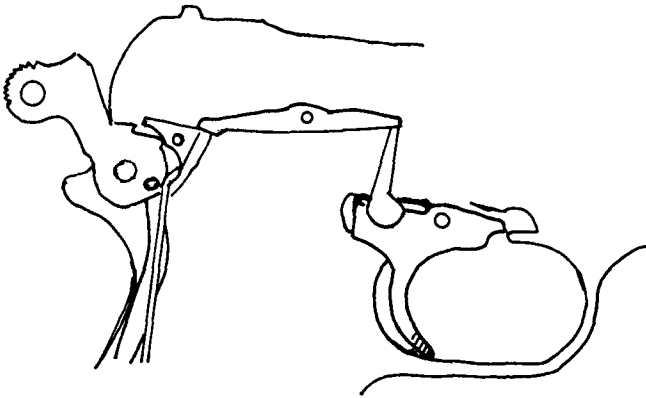
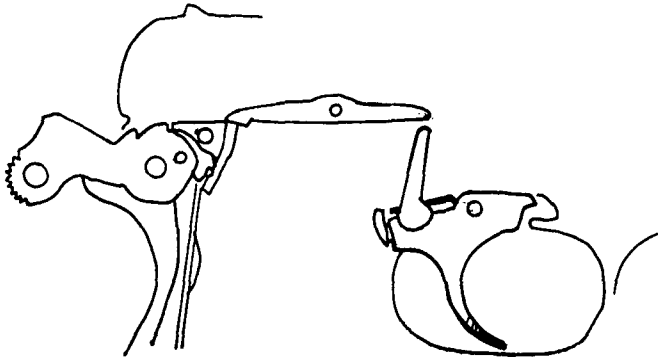
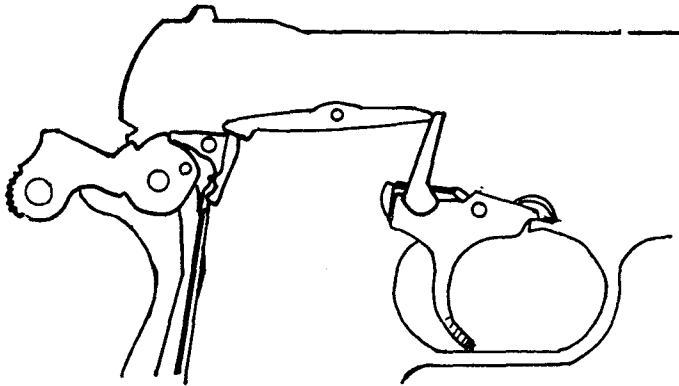

## ARGENTINA

### .45 Ballister Molina Pistol

Cartridge: .45 Damage: 4D6, P.V.: 4, Feed: 7 round box mag., Weight: 1.02 kg, Barrel Length: 127mm (216mm), Muzzle Velocity: 253 m/s, Approx. Effective Range: 50 meters (164 feet).



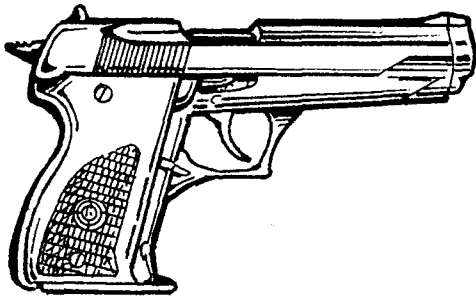

## AUSTRIA

### 9mm GB Steyr

**Cartridge:** 9mm, **Damage:** 2D6, **P.V.:** 4, **Feed:** Detachable 18 round box mag., **Weight:** 845 grams, **Barrel Length:** 136mm (216mm), **Muzzle Velocity:** 380 m/s, **Approx. Effective Range:** 45 meters (147.6 ft).

### Glock 17

**Cartridge:** 9 x 19mm Parabellum, **Damage:** 2D6, **P.V.:** 4, **Feed:** 17 round staggered box mag. (plastic construction), **Weight:** 21.175 ounces, **Barrel Length:** 4.5 inches, **Muzzle Velocity:** 335 m/s, **Approx. Effective Range:** 50 m (164 ft)

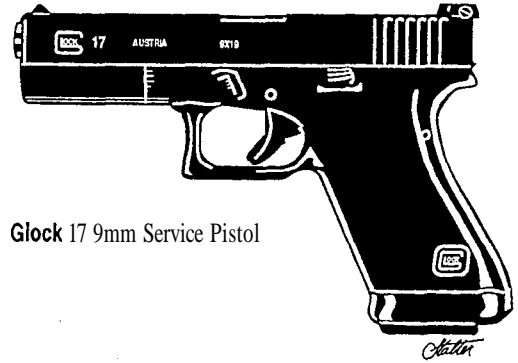

Glock 17 9mm Service Pistol

## BELGIUM

### Browning GP 35

**Cartridge:** 9mm, **Damage:** 2D6, **P.V.:** 4, **Feed:** 13 round mag., **Weight:** 990 grams, **Barrel Length:** 118mm (216mm), **Muzzle Velocity:** 350 m/s, **Approx. Effective Range:** 40 m (131 ft).

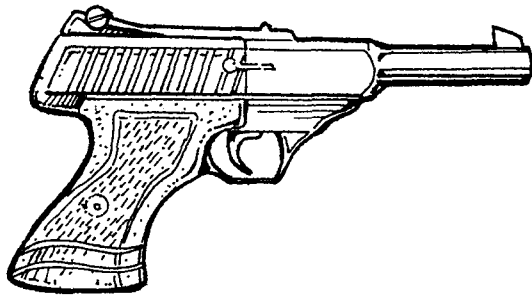
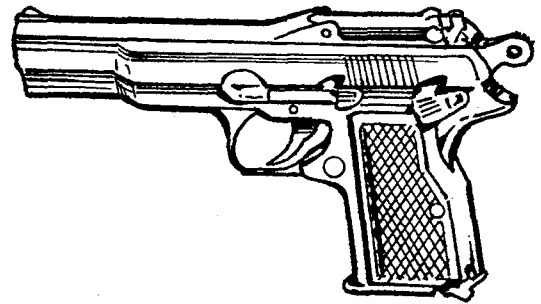

### Browning Nomad

**Cartridge:** .22 cal., **Damage:** 1D6, **P.V.:** 1, **Feed:** 10 round mag., **Weight:** 1050 grams, **Barrel Length:** 171mm, **Muzzle Velocity:** 300 m/s, **Approx. Effective Range:** 40-50 m (131 to 164 feet).

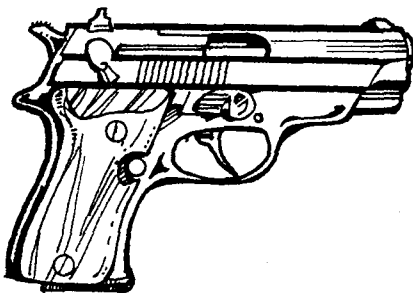

### 7.65mm 140 Double-Action FN

**Cartridge:** 9mm short or 7.65mm, **Damage:** 1D8 or 2D6, **P.V.:** 4, **Feed:** (9mm short) 13 round box mag. (7.65mm) 12 round box mag., **Weight:** 640 grams, **Barrel Length:** 173mm, **Muzzle Velocity:** (9mm short) 280 m/s (7.65mm) 295 m/s, **Approx. Effective Range:** 50 m (164 ft).



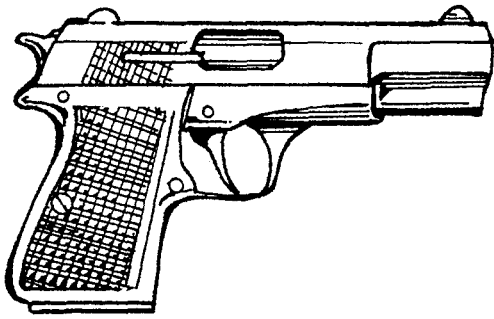

### 9mm FN Browning High Power

**Cartridge:** 9mm, **Damage:** 2D6, **P.V.:** 4, **Feed:** 13 round box mag., **Weight:** 0.81 kg, **Barrel Length:** 118mm (200mm), **Muzzle Velocity:** 350 m/s, **Approx. Effective Range:** 50 m (164 ft).

### 9mm Fabrique Nationale Standard Double-Action Model

**Cartridge:** 9mm, **Damage:** 2D6, **P.V.:** 4, **Feed:** 14 round box mag., **Weight:** 850 grams, **Barrel Length:** 118mm (200mm), **Muzzle Velocity:** 350 m/s, **Approx. Effective Range:** 50 m (164 ft).

### 9mm Fabrique Nationale Medium Double-Action Model

**Cartridge:** 9mm, **Damage:** 2D6, **P.V.:** 4, **Feed:** 14 round box mag., **Weight:** 770 grams, **Barrel Length:** 96mm (173mm), **Muzzle Velocity:** 350 m/s, **Approx. Effective Range:** 50 m (164 ft).

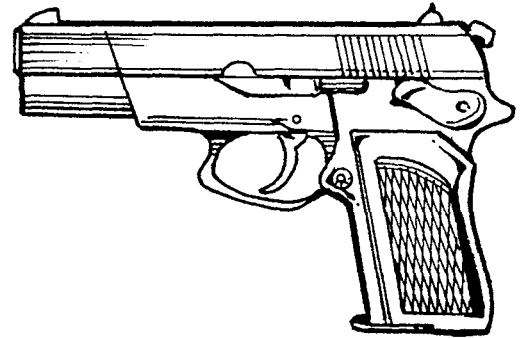

### 9mm Fabrique Nationale Compact Double-Action Model

**Cartridge:** 9mm, **Damage:** 2D6, **P.V.:** 4, **Feed:** 8 round box mag., **Weight:** 708 grams, **Barrel Length:** 96mm (173mm), **Muzzle Velocity:** 350 m/s, **Approx. Effective Range:** 50 m (164 ft).

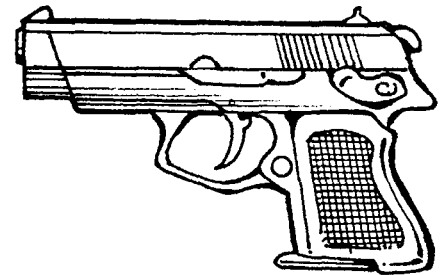

### Barracuda FN Revolver

**Cartridge:** .357 Magnum or .38 Special, **Damage:** 4D6 or 2D6, **P.V.:** 5 or 3, **Feed:** 6 round cylinder, **Weight:** 1.05 kg, **Barrel Length:** 76.2mm, **Muzzle Velocity:** 360 m/s, **Approx. Effective Range:** 50 m (164 ft).

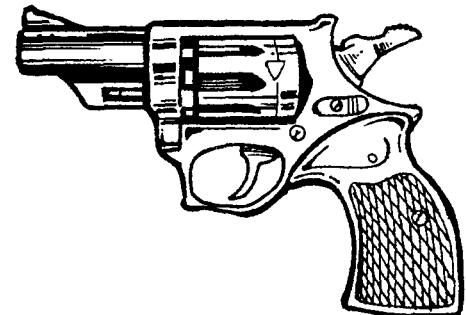

### 5.7mm FN P90 Personal Weapon (Auto-pistol).

**Cartridge:** 5.7 x 28mm, **Damage:** 2D6, **P.V.:** 4, **Feed:** 50 round mag., **Weight:** 2.80 kg (empty), 3.70 kg (with full magazine), **Muzzle Velocity:** 850 m/s, **Approx. Effective Range:** 150-200 m (492-656 ft), **Rate of Fire:** 800-1000 rounds/minute.

## CANADA

### Brigadier

**Cartridge:** .45, **Damage:** 4D6, **P.V.:** 4, **Feed:** 8 round mag., **Weight:** 1925 grams, **Barrel Length:** 140mm, **Muzzle Velocity:** 253 m/s, **Approx. Effective Range:** 50 m (164 ft).

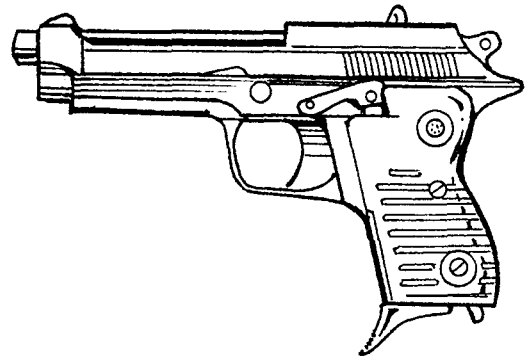

## CHINA, PEOPLE'S REPUBLIC

### 7.62mm Type 51 or Type 54

**Cartridge:** 7.62mm, **Damage:** 1D8, **P.V.:** 2, **Feed:** 8 round box mag., **Weight:** 854 grams, **Barrel Length:** 116mm (196mm), **Muzzle Velocity:** 420 m/s, **Approx. Effective Range:** 50 m (164 ft).

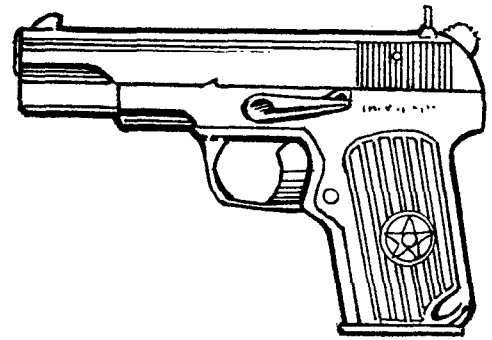

### 7.65mm Type 64 or Type 67 Silenced

**Cartridge:** 7.65mm x 17 rimless, **Damage:** 2D6, **P.V.:** 3, **Feed:** 8 round box mag., **Weight:** 1.27 kg, **Barrel Length:** 124mm (330mm), **Muzzle Velocity:** 274 m/s, **Approx. Effective Range:** 35 m (115 ft).

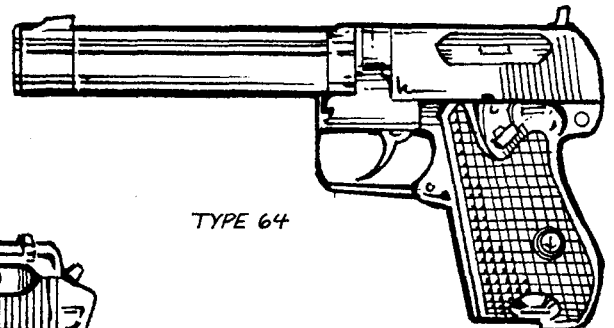

TYPE 64

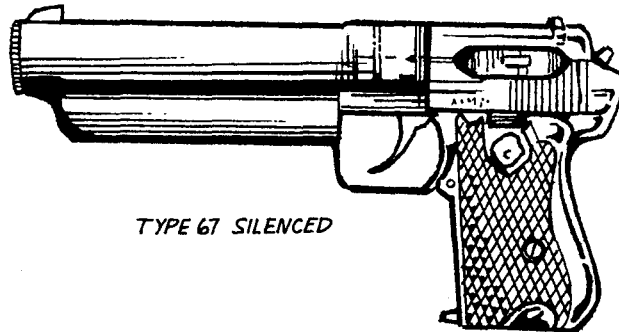

TYPE 67 SILENCED

### .22LR Firing Combat Knife

**Cartridge:** .22LR rimfire, **Damage:** 1D8, **P.V.:** 2, **Feed:** 4 pre-loaded barrels, **Weight:** 464 grams, **Overall Length:** 262mm, **Approx. Effective Range:** 30 m (100 ft).



.22LR Firing Combat Knife

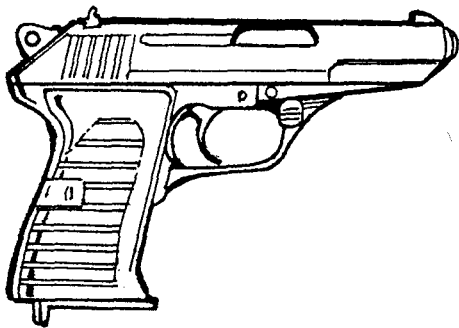

## CZECHOSLOVAKIA

### 7.62mm Model 52 Pistol

**Cartridge:** 7.62mm bottleneck, **Damage:** 1D8, **P.V.:** 2, **Feed:** 8 round box mag., **Weight:** 850 grams, **Barrel Length:** 90mm (170mm), **Muzzle Velocity:** 492 m/s, **Approx. Effective Range:** 63 m (206.7 ft).

### 7.65mm Model 50

**Cartridge:** 7.65mm, **Damage:** 1D8, **P.V.:** 2, **Feed:** 8 round detachable box mag., **Weight:** 681 grams, **Barrel Length:** 97mm, **Muzzle Velocity:** 280 m/s, **Approx. Effective Range:** 40 m (131 ft).



### 7.65mm Model 61 Skorpion

**Cartridge:** .32 ACP (7.65mm), **Damage:** 1D8, **P.V.:** 3, **Feed:** 10 or 20 round box mag., **Weight:** 1.59 kg, **Barrel Length:** 112mm (513mm, butt extended — 269mm butt retracted), **Muzzle Velocity:** 317 m/s or 274 m/s with silencer, **Approx. Effective Range:** 50 m (164 ft).

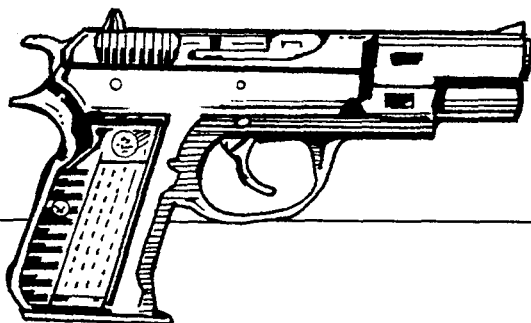
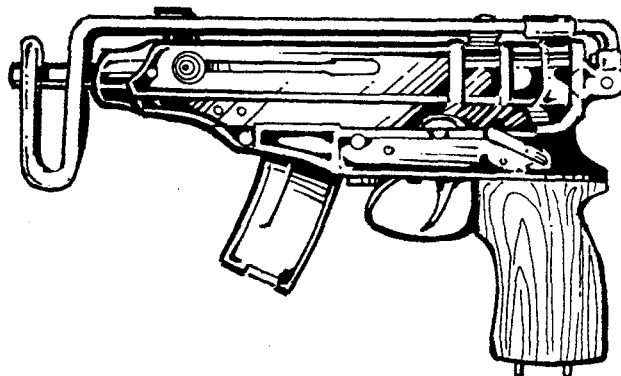

## EGYPT

### 9mm Tokagypt

**Cartridge:** 9mm, **Damage:** 2D6, **P.V.:** 4, **Feed:** 7 round detachable box mag., **Weight:** .91 kg, **Barrel Length:** 114mm (194mm), **Muzzle Velocity:** 350 m/s, **Approx. Effective Range:** 50 m (164 ft).

### 9mm Model 75

**Cartridge:** 9mm, **Damage:** 2D6, **P.V.:** 4, **Feed:** 15 round box mag., **Weight:** .98 kg, **Barrel Length:** 120mm (203mm), **Muzzle Velocity:** 350 m/s, **Approx. Effective Range:** 50 m (164 ft).

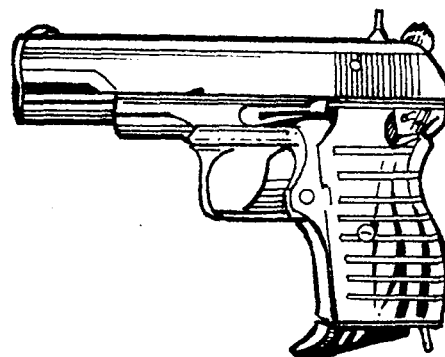

## FINLAND

### Lahti Model 35 and Model 40

**Cartridge:** 9mm, **Damage:** 2D6, **P.V.:** 4, **Feed:** 8 round detachable mag., **Weight:** 1.22 kg, **Barrel Length:** 107mm(246mm), **Muzzle Velocity:** 350 m/s, **Approx. Effective Range:** 40 m (131 ft).

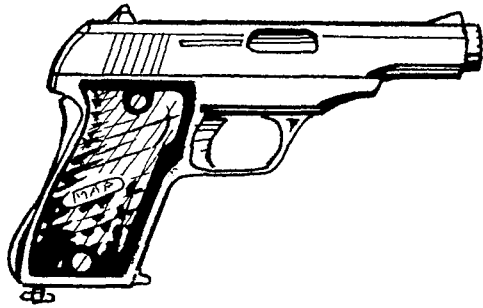
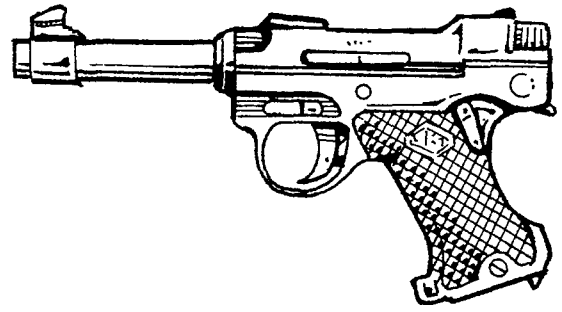

## FRANCE

### Model D MAB

**Cartridge:** 7.65mm or 9mm short, **Damage:** 2D6 or 1D8, **P.V.:** 3 or 4, **Feed:** 9 round detachable mag., **Weight:** .725 kg, **Barrel Length:** 103mm (176mm), **Muzzle Velocity:** (7.65mm) 280m/s (9mm) 350 m/s, **Approx. Effective Range:** 7.65mm: 40 m (131 ft), 9mm: 50 m (164 ft).

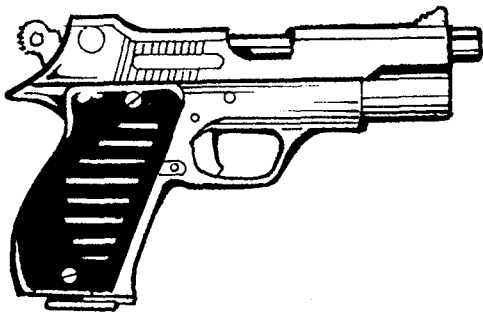

### 9mm Model 1950 MAS Self-Loading

**Cartridge:** 9mm, **Damage:** 2D6, **P.V.:** 4, **Feed:** 9 round box mag., **Weight:** 860 grams, **Barrel Length:** 112mm (195mm), **Muzzle Velocity:** 354 m/s, **Approx. Effective Range:** 50 m (164ft).

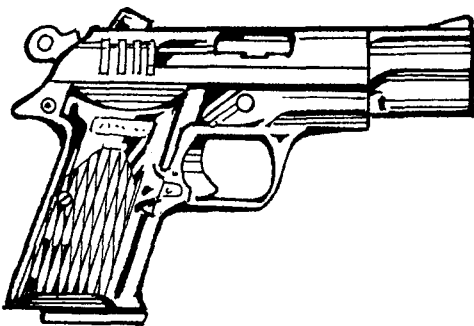

### 9mm PA15 MAB

**Cartridge:** 9mm, **Damage:** 2D6, **P.V.:** 4, **Feed:** 15 round box mag., **Weight:** 1.09 kg, **Barrel Length:** 114mm (203mm), **Muzzle Velocity:** 350 m/s, **Approx. Effective Range:** 7.65mm: 40 m (131 ft), 9mm: 50 m (164 ft).

### Unique-Model Bet-66

**Cartridge:** 7.65mm, **Damage:** 2D6, **P.V.:** 3, **Feed:** 8 round box mag., **Weight:** 1 kg, **Barrel Length:** 100mm, **Muzzle Velocity:** 280 m/s, **Approx. Effective Range:** 40 m (131 ft).

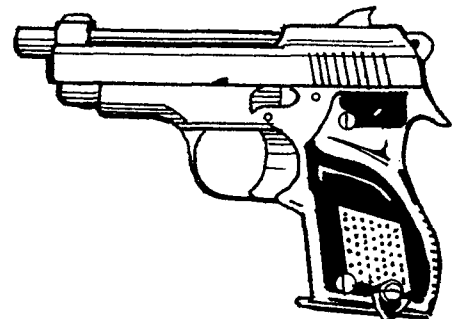

### **.357 MR 73 Manurhin Revolver**

**Cartridge:** .357 Magnum, **Damage:** 4D6, **P.V.:** 5, **Feed:** 6 chamber side-loading cylinder, **Weight:** 890 grams, **Barrel Length:** 76.2mm (205mm), **Muzzle Velocity:** 430 m/s, **Approx. Effective Range:** 55 m (180.4 ft).

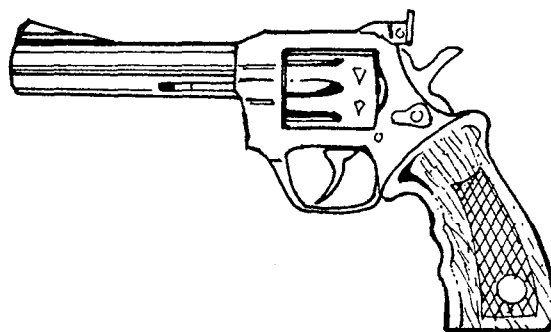

### **MR 32 Match Manurhin**

**Cartridge:** .32 Smith & Wesson long or .38 Special, **Damage:** 1D8 or 2D6, **P.V.:** 3 or 4, **Feed:** 6 round cylinder, **Weight:** 1.088 kg, **Barrel Length:** (MR 32) 152mm (MR 38) 146mm (277mm), **Muzzle Velocity:** 360 m/s, **Approx. Effective Range:** 50 m (164 ft).

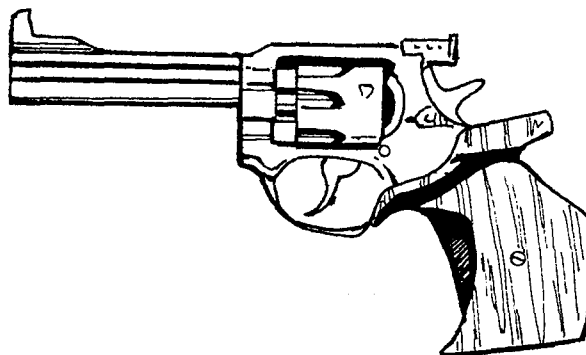

## **GERMANY**

### **Pistole M**

**Cartridge:** 9mm x 18, **Damage:** 2D6, **P.V.:** 4, **Feed:** 8 round detachable box mag., **Weight:** 663 gm, **Barrel Length:** 91mm (160mm), **Muzzle Velocity:** 315 m/s, **Approx. Effective Range:** 50 m (164 ft).

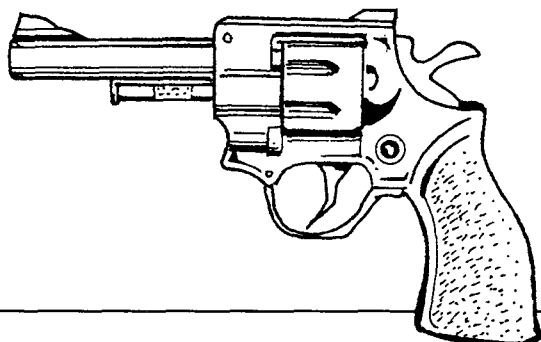

### **Arminius (Weirauch) HW3**

**Cartridge:** .22, **Damage:** 1D6, **P.V.:** 1, **Feed:** 8 round mag., **Weight:** 680 grams, **Barrel Length:** 70mm, **Muzzle Velocity:** 300 m/s, **Approx. Effective Range:** 55 m (180.4 ft).

### **Erma Olympia**

**Cartridge:** .22, **Damage:** 1D6, **P.V.:** 1, **Feed:** 10 round mag., **Weight:** 1100 grams, **Barrel Length:** 200mm, **Muzzle Velocity:** 300 m/s, **Approx. Effective Range:** 40 m (131 ft).

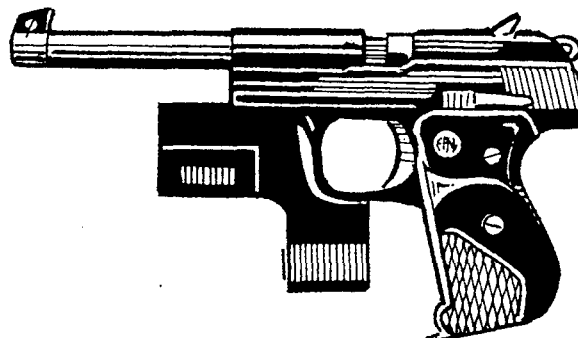

### Erma KGP 68

**Cartridge:** 7.65mm, **Damage:** 2D6, **P.V.:** 3, **Feed:** 9 round box mag., **Weight:** 638 grams, **Barrel Length:** 89mm, **Muzzle Velocity:** 280 m/s, **Approx. Effective Range:** 40 m (131 ft).

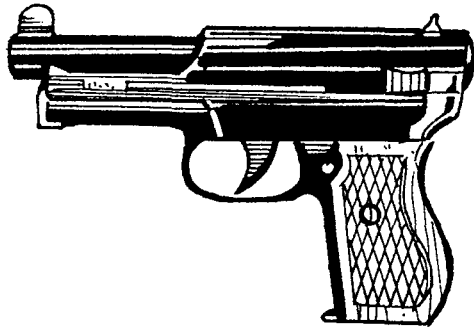
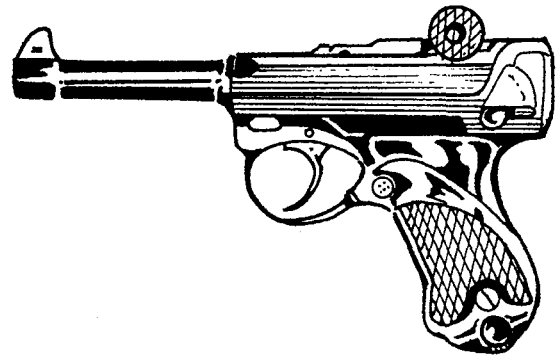

### Mauser 1934

**Cartridge:** 7.65mm, **Damage:** 2D6, **P.V.:** 3, **Feed:** 8 round box mag., **Weight:** 600 grams, **Barrel Length:** 87mm, **Muzzle Velocity:** 280 m/s, **Approx. Effective Range:** 45 m (148 ft).

### 7.65mm (or 9mm) HSI Mauser

**Cartridge:** 7.65mm, **Damage:** 2D6, **P.V.:** 3, **Feed:** 8 round detachable box mag., **Weight:** 596 grams, **Barrel Length:** 86mm (165mm), **Muzzle Velocity:** 290 m/s, **Approx. Effective Range:** 40 m (131 ft).

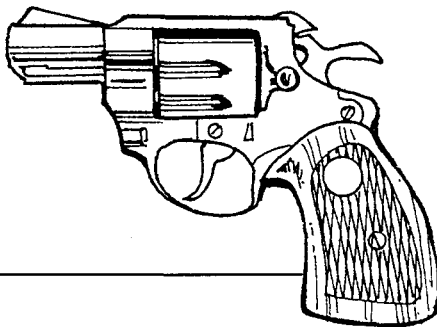
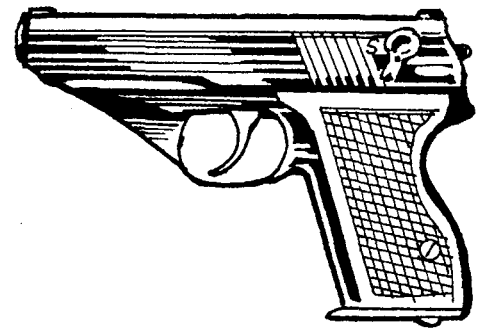

### .38 Special Mauser Revolver

**Cartridge:** .38 Special, **Damage:** 3D6, **P.V.:** 4, **Feed:** 6 round cylinder, **Weight:** approx. 600-660 grams, **Barrel Length:** 63.5mm (175mm), **Muzzle Velocity:** 360 m/s, **Approx. Effective Range:** 50 m (164 ft).

### Parabellum Mauser

**Cartridge:** 7.65mm, **Damage:** 2D6, **P.V.:** 3, **Feed:** 8 round box mag., **Weight:** 910 grams, **Barrel Length:** 150mm (165mm), **Muzzle Velocity:** 280 m/s, **Approx. Effective Range:** 40 m (131 ft).

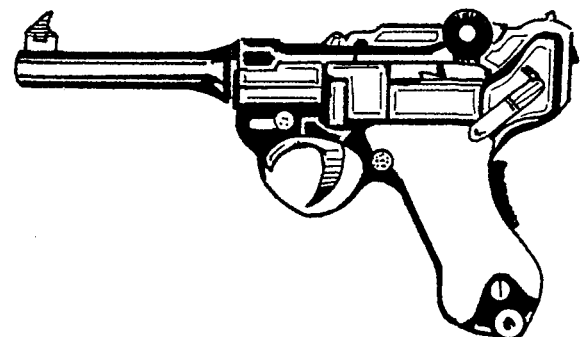

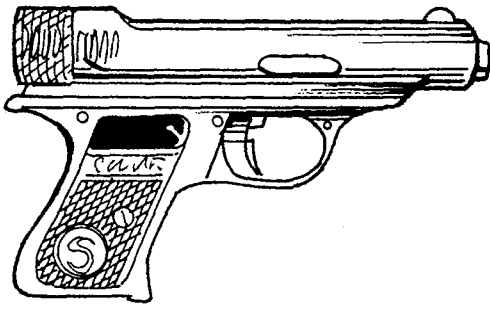

### Sauer Behorden Model

**Cartridge:** 7.65mm, **Damage:** 2D6, **P.V.:** 3, **Feed:** 7 round box mag., **Weight:** 620 grams, **Barrel Length:** 77mm (165mm), **Muzzle Velocity:** 280 m/s, **Approx. Effective Range:** 40 m (131 ft).

### Sauer Model 38H

**Cartridge:** 7.65mm, **Damage:** 2D6, **P.V.:** 3, **Feed:** 8 round box mag., **Weight:** 720 grams, **Barrel Length:** 83mm, **Muzzle Velocity:** 280 m/s, **Approx. Effective Range:** 45 m (148 ft).

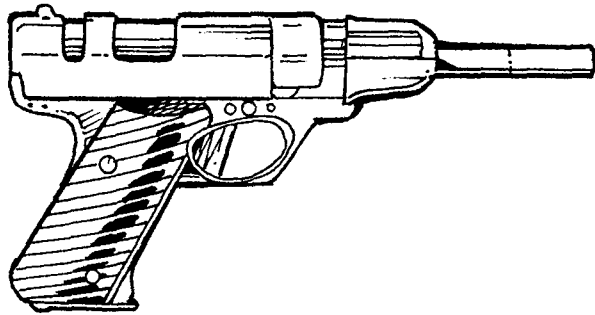

### Volkspistole

**Cartridge:** 9mm, **Damage:** 2D6, **P.V.:** 5, **Feed:** 8 round box mag., **Weight:** 960 grams, **Barrel Length:** 130mm, **Muzzle Velocity:** 350 m/s, **Approx. Effective Range:** 50 m (164 ft).

### 7.65mm PP Walther

**Cartridge:** 7.65mm, 9mm short, **Damage:** 2D6 or 1D8, **P.V.:** 3 or 4, **Feed:** 8 round detachable box mag., **Weight:** 682 grams, **Barrel Length:** 99mm (173mm), **Muzzle Velocity:** 290 m/s, **Approx. Effective Range:** 40 m (131 ft).



### 7.65mm PPK Walther

**Cartridge:** 7.65mm, **Damage:** 2D6, **P.V.:** 3, **Feed:** 7 round detachable box mag., **Weight:** 568 g, **Barrel Length:** 86mm (155mm), **Muzzle Velocity:** 280 m/s, **Approx. Effective Range:** 40 m (131 ft).

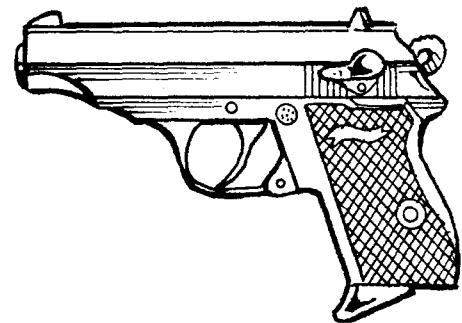

### 9mm Model P1 Walther

**Cartridge:** 9mm×19 Parabellum, **Damage:** 2D6, **P.V.:** 5, **Feed:** 8 round box mag., **Weight:** 772 grams, **Barrel Length:** 90mm (218mm), **Muzzle Velocity:** 350 m/s, **Approx. Effective Range:** 50 m (164 ft).

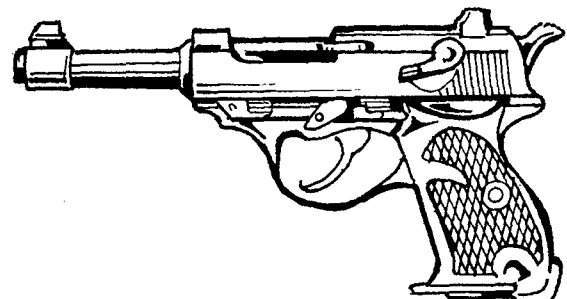

### 9mm Model P5 Walther

**Cartridge:** 9mm x 19 Parabellum, **Damage:** 2D6, **P.V.:** 5, **Feed:** 8 round detachable box mag., **Weight:** 795 grams, **Barrel Length:** 90mm (180mm), **Muzzle Velocity:** 350 m/s, **Approx. Effective Range:** 50 m (164 ft).



### 9mm P9S Heckler & Koch

**Cartridge:** 9mm x 19 Parabellum or .45ACP, **Damage:** 2D6 or 4D6, **P.V.:** 5 or 4, **Feed:** 9 round box mag., (.45 ACP) 7 round box mag., **Weight:** (9mm) 880 grams, (.45 ACP) 750 grams, **Barrel Length:** 102mm (192mm), **Muzzle Velocity:** 9mm: 351 m/s, .45 ACP: 260 m/s, **Approx. Effective Range:** 50m (164 ft).

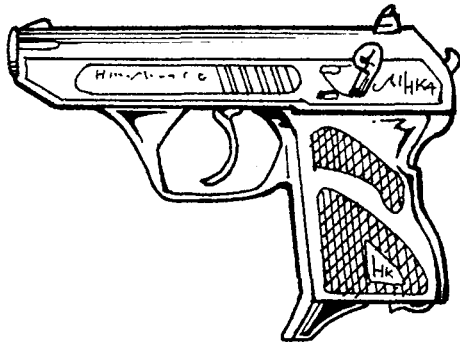
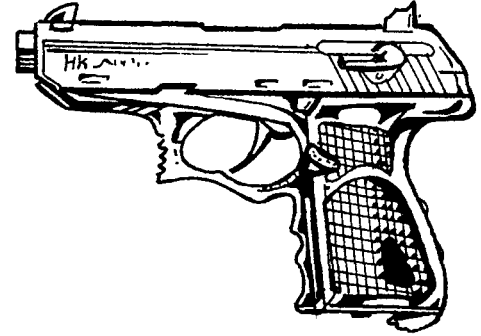

### HK4 Self-Loading Heckler & Koch

**Cartridge:** 9mm short, **Damage:** 1D8, **P.V.:** 4, **Feed:** 7 round box mag., **Weight:** 480 grams, **Barrel Length:** 85mm (157mm), **Muzzle Velocity:** 299 m/s, **Approx. Effective Range:** 40-50 m (131 to 164 ft).

### 9mm P7 (PSP) Self-Loading Heckler & Koch

**Cartridge:** 9mm x 19 Parabellum, **Damage:** 2D6, **P.V.:** 5, **Feed:** 8 round detachable box mag., **Weight:** 785 grams, **Barrel Length:** 105mm (166mm), **Muzzle Velocity:** 351 m/s, **Approx. Effective Range:** 50 m (164 ft).

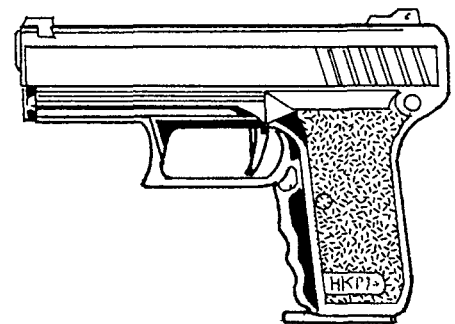

### 9mm VP70M & VP70Z Auto Heckler & Koch

**Cartridge:** 9mm x 19 Parabellum, **Damage:** 2D6, **P.V.:** 5, **Feed:** 18 round box mag., **Weight:** 823 grams, **Barrel Length:** 116mm (204mm), **Muzzle Velocity:** 360 m/s, **Approx. Effective Range:** 50 m (164 ft).

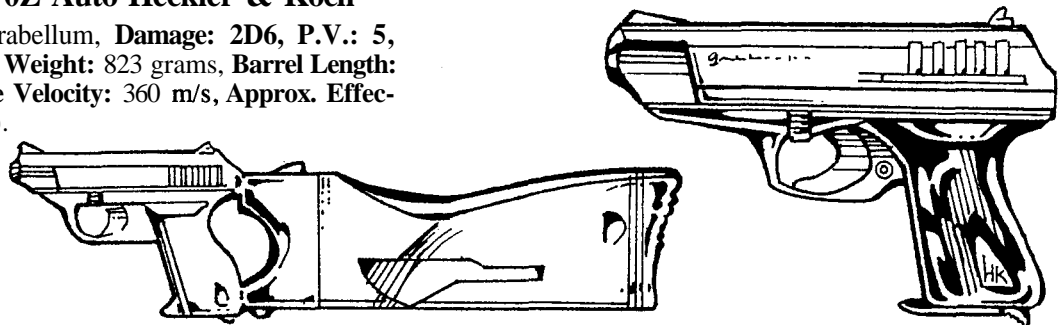



## HUNGARY

### Frommer M37

**Cartridge:** 7.65mm, **Damage:** 2D6, **P.V.:** 3, **Feed:** 7 round box mag., **Weight:** 770 grams, **Barrel Length:** 110mm, **Muzzle Velocity:** 280 m/s, **Approx. Effective Range:** 40 m (131 ft).

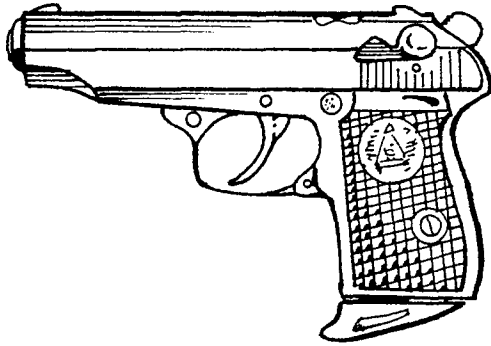
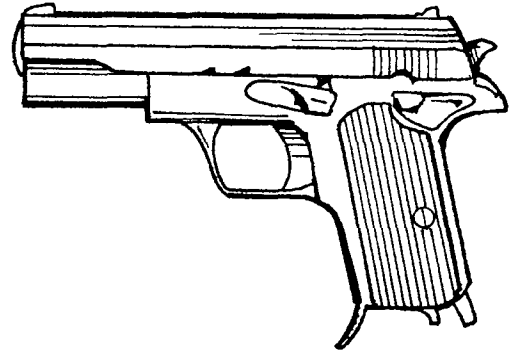

### 7.62mm Model 48

**Cartridge:** 7.62mm × 25 Pistol Type P, **Damage:** 1D8, **P.V.:** 2, **Feed:** 8 round box mag., **Weight:** 846 grams, **Barrel Length:** 116mm (196mm), **Muzzle Velocity:** 420 m/s, **Approx. Effective Range:** 50 m (164 ft).

### 9mm or 7.65mm PA63

**Cartridge:** 9mm short or 7.65mm, **Damage:** 1D8 or 2D6, **P.V.:** 4 or 3, **Feed:** 9mm: 7 round box mag.; 7.65mm: 8 round detachable box mag., **Weight:** 0.7 kgs, **Barrel Length:** 104mm (175mm), **Muzzle Velocity:** 315 m/s, **Approx. Effective Range:** 50 m (164 ft).

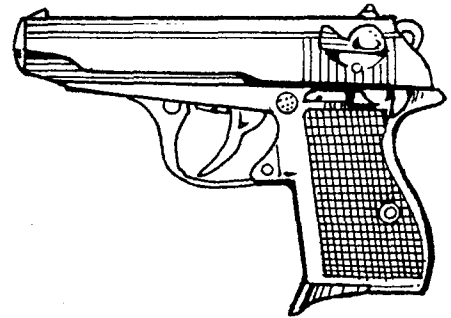

## INDONESIA

### 9mm Pindad Pistol

**Cartridge:** 9mm × 19 Parabellum, **Damage:** 2D6, **P.V.:** 5, **Feed:** 13 round box mag., **Weight:** 0.88 kgs, **Barrel Length:** 112mm (196mm), **Muzzle Velocity:** 354 m/s, **Approx. Effective Range:** 50 m (164 ft).

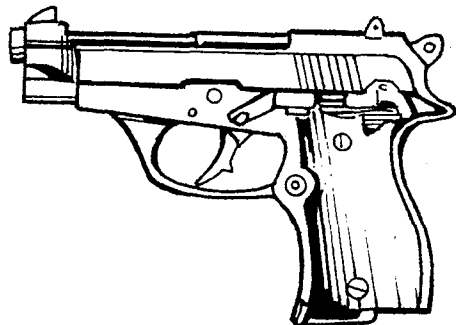
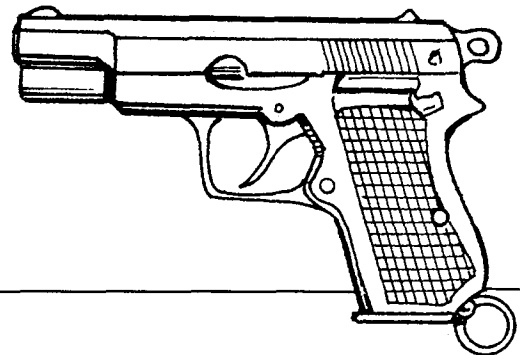

## ITALY

### 7.65mm Model 81 Double-Action Beretta

**Cartridge:** 7.65mm, **Damage:** 2D6, **P.V.:** 3, **Feed:** 12 round detachable box mag., **Weight:** 665 grams, **Barrel Length:** 97mm (172mm), **Muzzle Velocity:** 300 m/s, **Approx. Effective Range:** 45 m (148 ft).

### 9mm Model 1934 Beretta

**Cartridge:** 9mm short, **Damage:** 1D8, **P.V.:** 4, **Feed:** 7 round detachable box mag., **Weight:** 568 grams, **Barrel Length:** 90mm (152mm), **Muzzle Velocity:** 290 m/s, **Approx. Effective Range:** 40 m (131 ft).

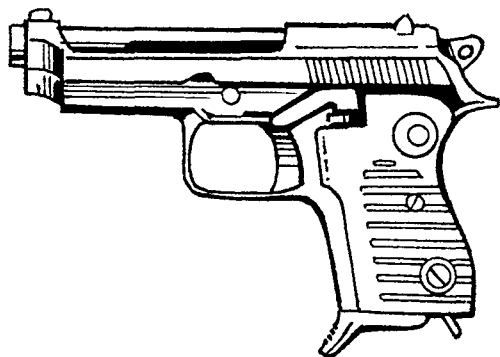
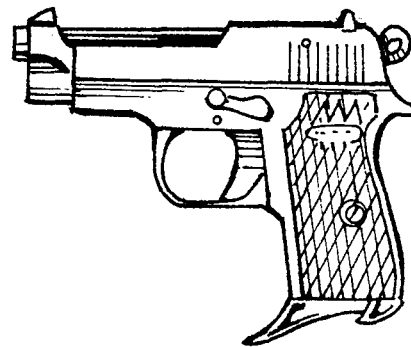

### 9mm Model 1951 Self-Loading Beretta

**Cartridge:** 9mm×19 Parabellum, **Damage:** 2D6, **P.V.:** 5, **Feed:** 8 round box mag., **Weight:** 0.87 kgs, **Barrel Length:** 114.2mm (203.2mm), **Muzzle Velocity:** 350 m/s, **Approx. Effective Range:** 50 m (164 ft).

### 9mm Model 84 Double-Action Beretta

**Cartridge:** 9mm short, **Damage:** 1D8, **P.V.:** 4, **Feed:** 13 round detachable box mag., **Weight:** 640 grams, **Barrel Length:** 97mm (172mm), **Muzzle Velocity:** 280 m/s, **Approx. Effective Range:** 45 m (148 ft).

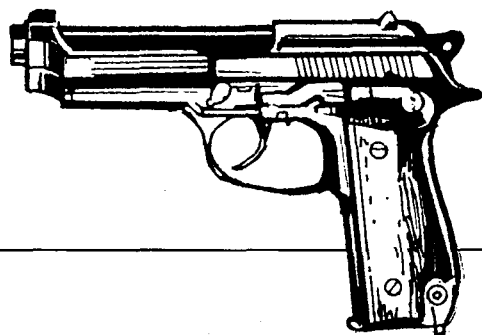
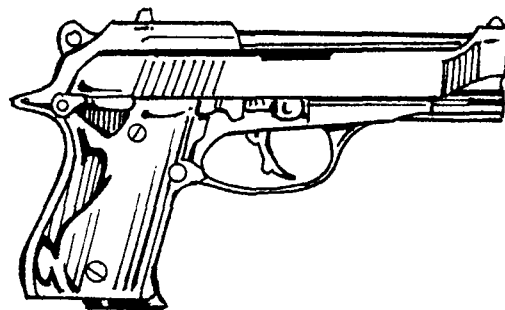

### 9mm Model 92 Double-Action Beretta

**Cartridge:** 9mm Parabellum, **Damage:** 2D6, **P.V.:** 4, **Feed:** 15 round detachable box mag., **Weight:** 950 grams, **Barrel Length:** 125mm (217mm), **Muzzle Velocity:** 390 m/s, **Approx. Effective Range:** 50 m (164 ft).

### 9mm 93R Selective Fire Beretta

**Cartridge:** 9mm Parabellum, **Damage:** 2D6, **P.V.:** 4, **Feed:** 15 or 20 round detachable box mag., **Weight:** 1.12kg, **Barrel Length:** 156mm (240mm), **Muzzle Velocity:** 375 m/s, **Approx. Effective Range:** 50 m (164 ft).

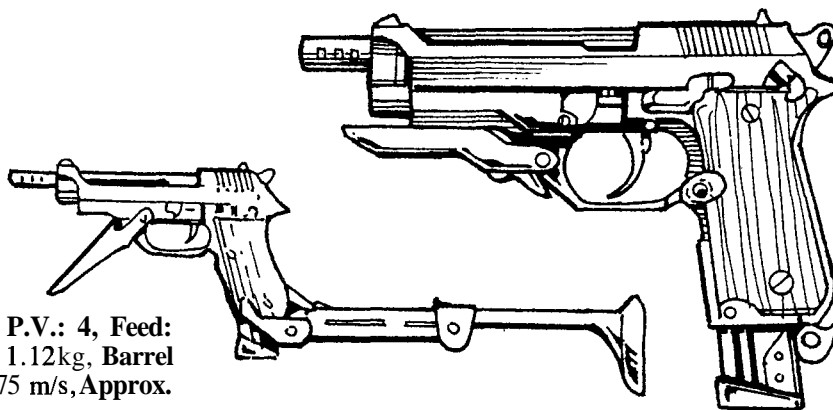

### 9mm Model 951R Semi & Full Auto Beretta

**Cartridge:** 9mm Parabellum, **Damage:** 2D6, **P.V.:** 4, **Feed:** 10 round detachable box mag., **Weight:** 1350 grams, **Barrel Length:** 125mm (170mm), **Muzzle Velocity:** 390 m/s, **Approx. Effective Range:** 55 m (180.4 ft).

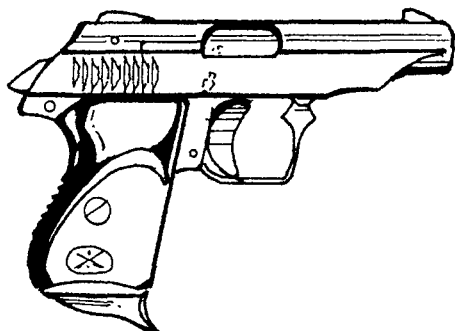
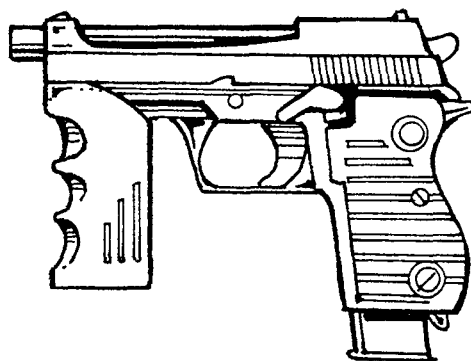

### P-018 & P-018-9 Bernadelli

**Cartridge:** 7.65mm or 9mm Parabellum, **Damage:** 2D6, **P.V.:** 3 or 4, **Feed:** 14 round box mag., **Weight:** 998 grams, **Barrel Length:** 122mm (213mm), **Muzzle Velocity:** 280 m/s, **Approx. Effective Range:** 45 m (148 ft).

### Bernadelli Model 60

**Cartridge:** 7.65mm, **Damage:** 2D6, **P.V.:** 3, **Feed:** 8 round box mag., **Weight:** 670 grams, **Barrel Length:** 90mm, **Muzzle Velocity:** 320 m/s, **Approx. Effective Range:** 40 m (131 ft).

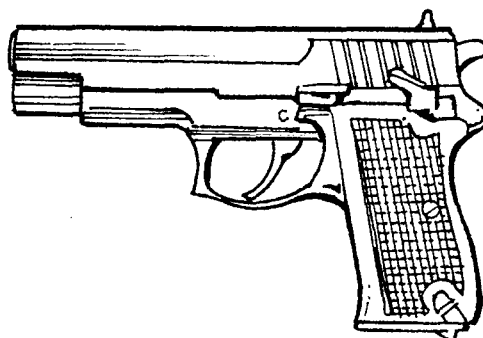

### Model 80 Mauser HSc Renato Gamba

**Cartridge:** 7.65mm, **Damage:** 2D6, **P.V.:** 3, **Feed:** 11 or 25 round detachable box mag., **Weight:** approx. 750 grams, **Barrel Length:** 90mm (166mm), **Muzzle Velocity:** 280 m/s, **Approx. Effective Range:** 40 m (131 ft).

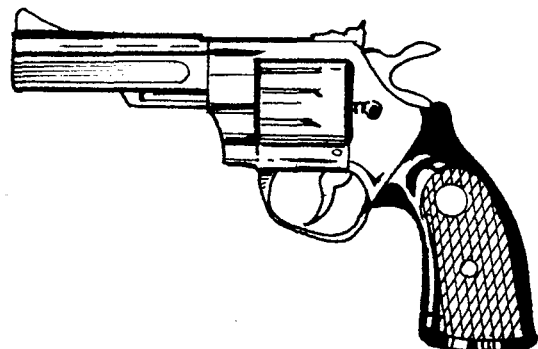
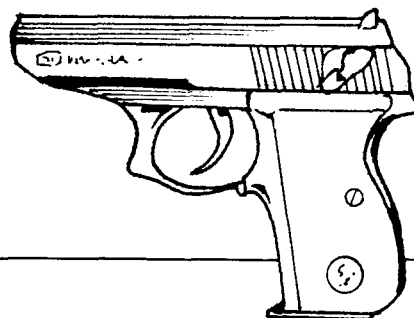

### .38 Trident Super 4 Renato Gamba Revolver

**Cartridge:** .38 Special, **Damage:** 2D6, **P.V.:** 4, **Feed:** 6 chamber cylinder, **Weight:** approx. 720 grams, **Barrel Length:** 101mm (240mm), **Muzzle Velocity:** 360 m/s.

### 9mm 'Baby' Tanfoglio Pistol

**Cartridge:** 9mm x 19 Parabellum, **Damage:** 2D6, **P.V.:** 4, **Feed:** 12 round box mag., **Weight:** 850 grams, **Barrel Length:** 90mm (175mm), **Approx. Effective Range:** 45 m (148 ft).



9mm Tanfoglio "Baby" Pistol

*Chilton*



.38 Luigi Franchi Revolver

*Chilton*

### .38 RF83 Luigi Franchi Revolver

**Cartridge:** .38 Special, **Damage:** 2D6, **P.V.:** 4, **Feed:** 6 chamber cylinder, **Weight:** 800 grams, **Barrel Length:** 101mm, **Muzzle Velocity:** 335 m/s, **Approx. Effective Range:** 50 m (164 ft).

## JAPAN

### Japanese Model 94

**Cartridge:** 9mm, **Damage:** 2D6, **P.V.:** 5, **Feed:** 6 round box mag., **Weight:** 820 grams, **Barrel Length:** 96mm, **Muzzle Velocity:** 300 m/s, **Approx. Effective Range:** 40 m (131 ft).

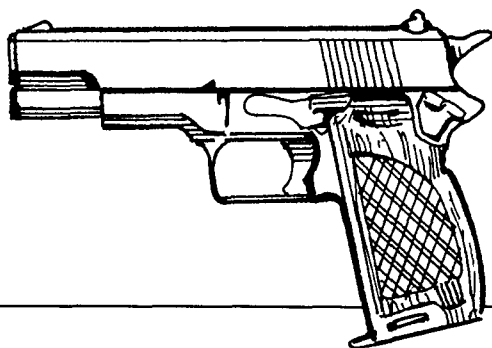
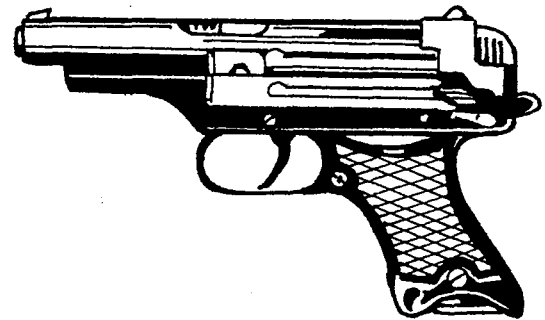

### 9mm Model 57A Auto New Nambu

**Cartridge:** 9mm x 19 Parabellum, **Damage:** 2D6, **P.V.:** 5, **Feed:** 18 round box mag., **Weight:** 823 grams, **Barrel Length:** 116mm (204mm), **Muzzle Velocity:** 360 m/s, **Approx. Effective Range:** 50 m (164 ft).

### 7.65mm Model 57B Auto New Nambu

**Cartridge:** .32 ACP, **Damage:** 1D8, **P.V.:** 3, **Feed:** 8 round box mag., **Weight:** 600 grams, **Barrel Length:** 90mm (150mm), **Muzzle Velocity:** 300 m/s, **Approx. Effective Range:** 40 m (131 ft).

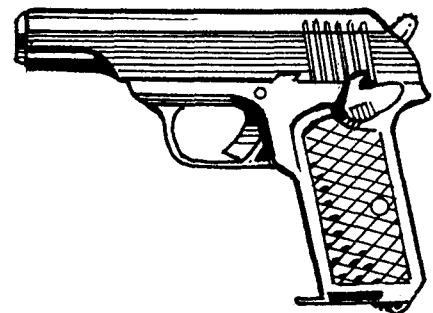

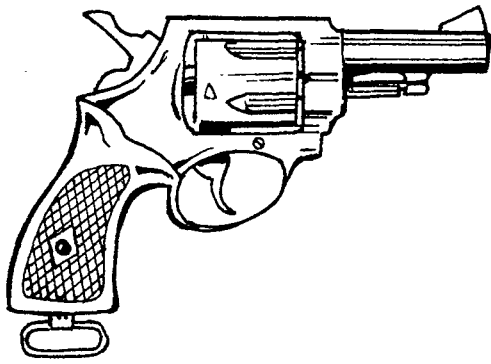

### **.38 Model 60 New Nambu Revolver**

**Cartridge:** .38 Special, **Damage:** 2D6, **P.V.:** 4, **Feed:** 5 chamber cylinder, **Weight:** 680 grams, **Barrel Length:** 77mm (197mm), **Muzzle Velocity:** 220 m/s, **Approx. Effective Range:** 40 m (131 ft).

## **KOREA, Democratic People's Republic**

### **7.62mm Type 68**

**Cartridge:** 7.62mm×25, **Damage:** 1D8, **P.V.:** 2, **Feed:** 8 round box mag., **Weight:** 795 grams, **Barrel Length:** 108mm (185mm), **Muzzle Velocity:** 396 m/s, **Approx. Effective Range:** 50 m (164 ft).

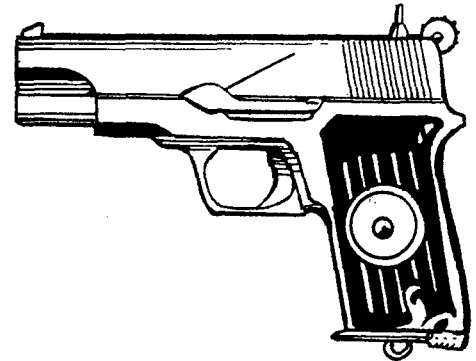

### **7.65mm Type 64**

**Cartridge:** 7.65mm, **Damage:** 2D6, **P.V.:** 3, **Feed:** 7 round detachable box mag., **Weight:** 624 grams, **Barrel Length:** 102mm (171mm), **Muzzle Velocity:** 290 m/s, **Approx. Effective Range:** 30 m (100 ft).

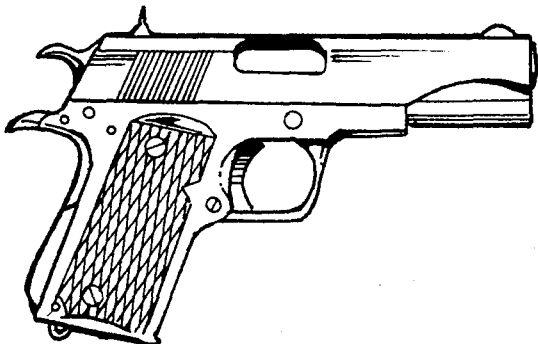
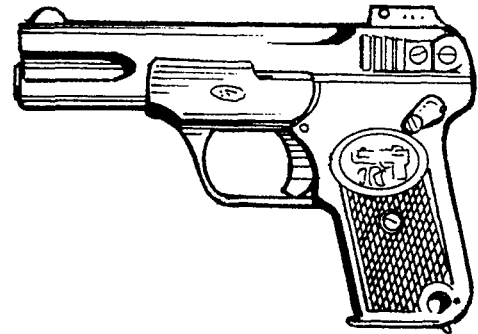

## **MEXICO**

### **.45 Obregon**

**Cartridge:** .45 ACP, **Damage:** 4D6, **P.V.:** 4, **Feed:** 7 round detachable box mag., **Weight:** 1.13 kg, **Barrel Length:** 127mm (216mm), **Muzzle Velocity:** 253 m/s, **Approx. Effective Range:** 50 m (164 ft).

## POLAND

### 9mm Model 35 Random

**Cartridge:** 9mm Parabellum, **Damage:** 2D6, **P.V.:** 4, **Feed:** 8 round detachable box mag., **Weight:** 1.022kg, **Barrel Length:** 121mm (197mm), **Muzzle Velocity:** 351 m/s, **Approx. Effective Range:** 50 m (164 ft).

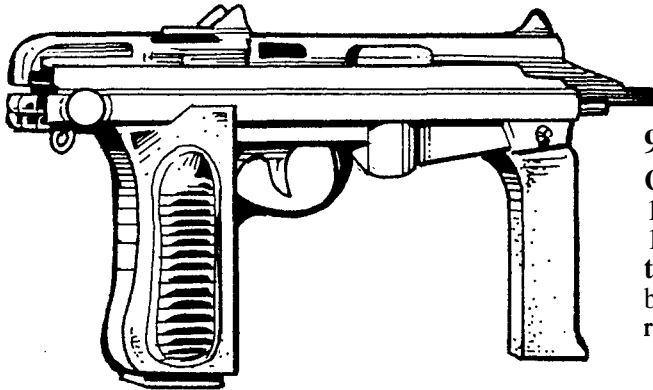
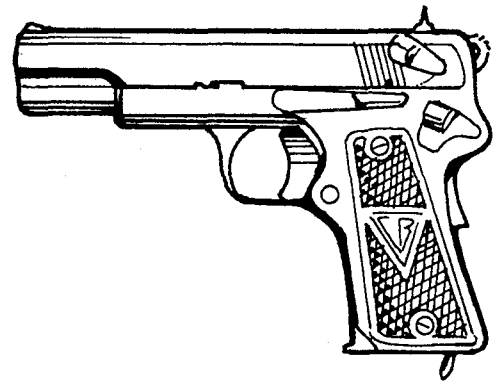

### 9mm Wz 63 (PM-63) Machine Pistol

**Cartridge:** 9mm x 18 Makarov, **Damage:** 2D6, **P.V.:** 4, **Feed:** 15 or 250 round box mag., **Weight:** 1.8 kg, **Barrel Length:** 152mm (333mm), **Muzzle Velocity:** 324 m/s, **Approx. Effective Range:** 65 m (213 ft), **Note:** Has a retractable stock or can be given the handle of an AK-47. **Rate of Fire:** (cyclic) 600 rounds/min, (auto) 75 rounds/min., (single shot) 40 rounds/min.



### 9mm P64 Self-Loading

**Cartridge:** 9mm x 18, **Damage:** 2D6, **P.V.:** 4, **Feed:** 6 round box mag., **Weight:** .636 kg, **Barrel Length:** 84mm (155mm), **Muzzle Velocity:** 314 m/s, **Approx. Effective Range:** 59 m (193.6 ft).

## SPAIN

### 9mm Super Star

**Cartridge:** 9mm Largo, **Damage:** 2D6, **P.V.:** 4, **Feed:** 9 round detachable box mag., **Weight:** 1.02 kg, **Barrel Length:** 133mm (204mm), **Muzzle Velocity:** 366 m/s, **Approx. Effective Range:** 50 m (164 ft).

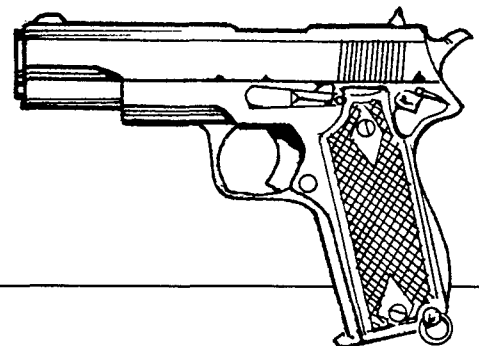

### 9mm Model 28DA Double-Action Star

**Cartridge:** 9mm Parabellum, **Damage:** 2D6, **P.V.:** 4, **Feed:** 15 round box mag., **Weight:** 1.14kg, **Barrel Length:** 110mm (205mm), **Muzzle Velocity:** 350 m/s, **Approx. Effective Range:** 50 m (164 ft).

### 9mm Model A80 Double-Action Astra

**Cartridge:** 9mm Parabellum, **Damage:** 2D6, **P.V.:** 4, **Feed:** 15 round box mag., **Weight:** 985 grams, **Barrel Length:** 95.5mm (180mm), **Muzzle Velocity:** 350 m/s, **Approx. Effective Range:** 50 m (164 ft).



### .38 Special Model 960 Astra Revolver

**Cartridge:** .38 Special, **Damage:** 2D6, **P.V.:** 4, **Feed:** 6 chamber cylinder, **Weight:** 1.15 kg, **Barrel Length:** 102mm (241mm), **Muzzle Velocity:** 265 m/s, **Approx. Effective Range:** 50 m (164 ft).

## SWEDEN

### 9mm Model 40 Husquarna

**Cartridge:** 9mm Parabellum, **Damage:** 2D6, **P.V.:** 4, **Feed:** 8 round detachable box mag., **Weight:** 1.11 kg, **Barrel Length:** 140mm (271mm), **Muzzle Velocity:** 381 m/s, **Approx. Effective Range:** 50 m (164 ft).

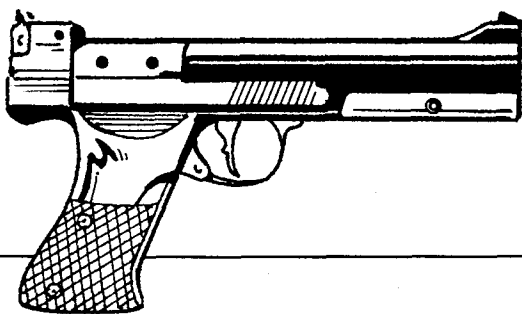
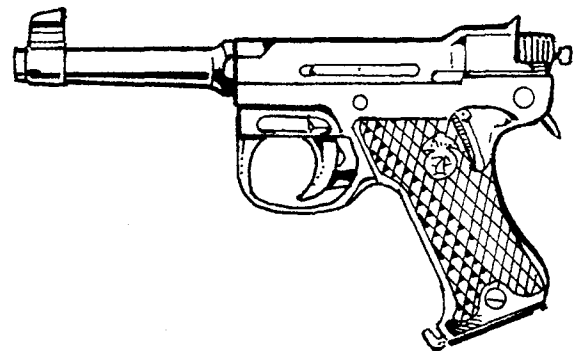

## SWITZERLAND

### Hammerli Model 208

**Cartridge:** .22, **Damage:** 1D6, **P.V.:** 1, **Feed:** 8 round box mag., **Weight:** 750 grams, **Barrel Length:** 125mm, **Muzzle Velocity:** 300 m/s, **Approx. Effective Range:** 40 m (131 ft).

### P210-5 & 9mm Model 49 SIG

**Cartridge:** 9mm Parabellum, **Damage:** 2D6, **P.V.:** 4, **Feed:** 8 round box mag., **Weight:** 900 grams, **Barrel Length:** 120mm (215mm), **Muzzle Velocity:** 335 m/s, **Approx. Effective Range:** 50 m (164 ft).

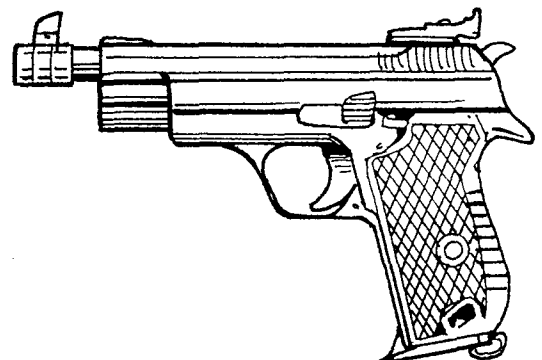

### **P220 (Model 75) Sig Sauer**

**Cartridge:** 9mm Parabellum, **Damage:** 2D6, **P.V.:** 4, **Feed:** 9 round box mag., **Weight:** 730 grams, **Barrel Length:** 112mm (198mm), **Muzzle Velocity:** 345 m/s, **Approx. Effective Range:** 50 m (164 ft).

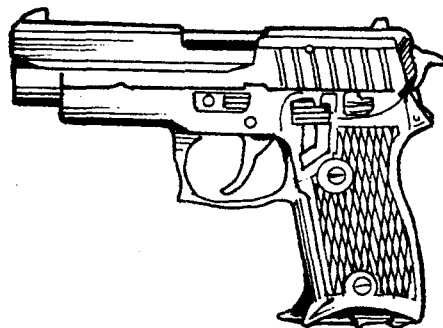

### **P230 Sig Sauer**

**Cartridge:** 9mm Police, **Damage:** 2D6, **P.V.:** 4, **Feed:** 7 round box mag., **Weight:** 690 grams, **Barrel Length:** 98mm (180mm), **Muzzle Velocity:** 320 m/s, **Approx. Effective Range:** 50 m (164 ft).

### **P225 (P9) Sig Sauer**

**Cartridge:** 9mm x 19, **Damage:** 2D6, **P.V.:** 4, **Feed:** 8 round box mag., **Weight:** 720 grams, **Barrel Length:** 98mm (180mm), **Muzzle Velocity:** 350 m/s, **Approx. Effective Range:** 50 m (164 ft).

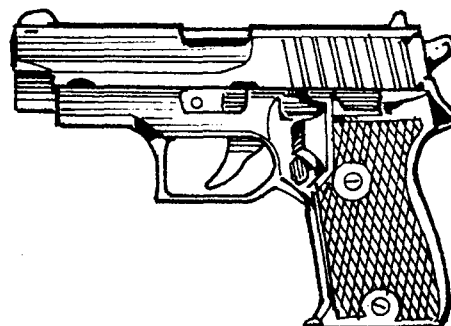

### **TURKEY**

#### **9mm MKE & 7.65mm MKE**

**Cartridge:** 9mm short or 7.65mm, **Damage:** 1D8 or 2D6, **P.V.:** 4 or 3, **Feed:** 7 round detachable box mag., **Weight:** 680 gm, **Barrel Length:** 98mm (180mm), **Muzzle Velocity:** 260-280 m/s, **Approx. Effective Range:** 30 m (100 ft).

### **The Old U.S.S.R.**

Note: These weapons are common throughout much of Eastern Europe.

#### **7.62mm TT-33 Tokarev**

**Cartridge:** 7.62mm x 25 Type P, **Damage:** 1D8, **P.V.:** 2, **Feed:** 8 round box mag., **Weight:** .85 kg, **Barrel Length:** 116mm (196mm), **Muzzle Velocity:** 420 m/s, **Approx. Effective Range:** 55 m (180.4 ft).

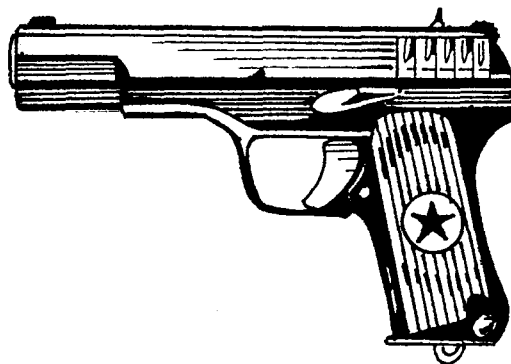



### 9mm Stechkin Auto (APS).

**Cartridge:** 9mm x 18, **Damage:** 2D6, **P.V.:** 4, **Feed:** 20 round box mag., **Weight:** 1.03 kg, **Barrel Length:** 127mm (225mm), **Muzzle Velocity:** 340 m/s, **Approx. Effective Range:** 50 m (164 ft).

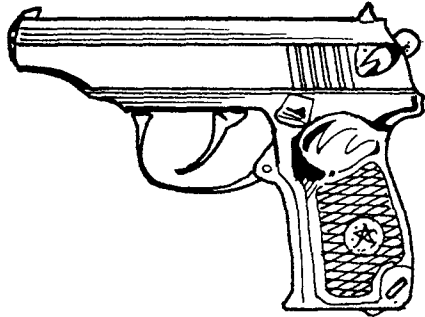
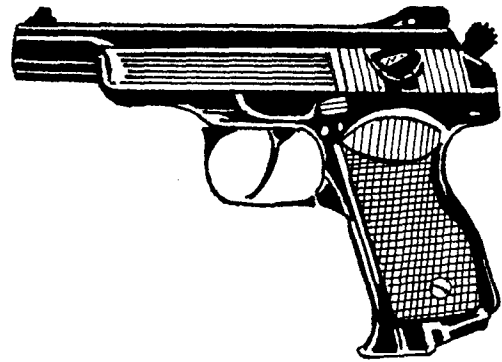

### 9mm Makarov Self-Loading (PM).

**Cartridge:** 9mm x 18, **Damage:** 2D6, **P.V.:** 4, **Feed:** 8 round box mag., **Weight:** 663 grams, **Barrel Length:** 91mm (160mm), **Muzzle Velocity:** 315 m/s, **Approx. Effective Range:** 50 m (164 ft).

## UNITED KINGDOM

### Welrod

**Cartridge:** 7.65mm, **Damage:** 2D6, **P.V.:** 3, **Feed:** 6 round mag., **Weight:** 650 grams, **Barrel Length:** 110mm (215mm), **Muzzle Velocity:** 280 m/s, **Approx. Effective Range:** 40 m (131 ft).

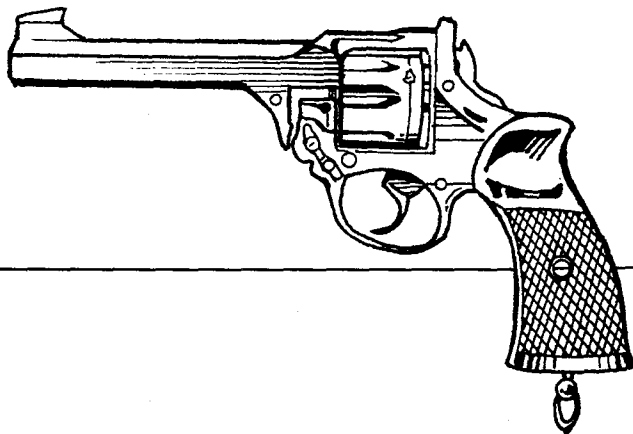
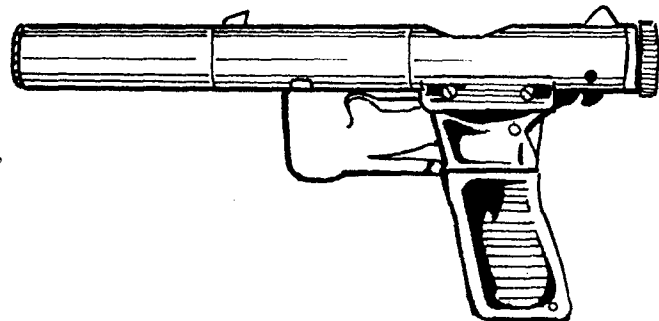

### .38 No. 2 Pistol Revolver

**Cartridge:** .380 SAA Ball; .380 Revolver; .38 Smith & Wesson, .38 Webley, **Damage:** 2D6, **P.V.:** 3, **Feed:** 6 chamber cylinder, **Weight:** 767 grams, **Barrel Length:** 102mm (260mm), **Muzzle Velocity:** 183 m/s, **Approx. Effective Range:** 40 m (131 ft).

### .38 Special, .357 Magnum Sterling Revolver

**Cartridge:** .38 Special or .357 Magnum, **Damage:** 2D6 or 4D6, **P.V.:** 4 or 5, **Feed:** 6 chamber cylinder, **Weight:** 1077 grams, **Barrel Length:** 70 & 102mm (240mm), **Muzzle Velocity:** 360 m/s, **Approx. Effective Range:** 50 m (164 ft).

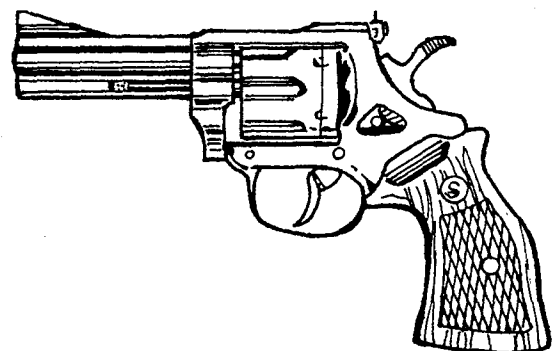

# UNITED STATES OF AMERICA

## Auto Mag

**Cartridge:** .44, **Damage:** 5D6, **P.V.:** 6, **Feed:** 8 round mag., **Weight:** 1665 grams, **Barrel Length:** 166mm, **Muzzle Velocity:** 335 m/s, **Approx. Effective Range:** 50 m (164 ft).

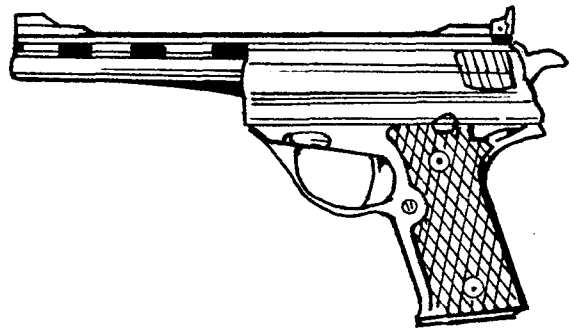

## 9mm Calico M-950 Pistol

This is a semi-automatic handgun with a unique Helical Feed system. It uses a 50 round magazine which can be loaded and stored and using a speed loader can be reloaded in less than 15 seconds.

**Cartridge:** 9 x 9mm Parabellum, **Damage:** 2D6, **P.V.:** 2, **Feed:** 50 or 100 round helical mag., **Weight:** 1.81 kg with 50 round mag., **Barrel Length:** 356mm with 50 round mag., **Muzzle Velocity:** 393m/s, **Effective Range:** 75 m (246 ft).

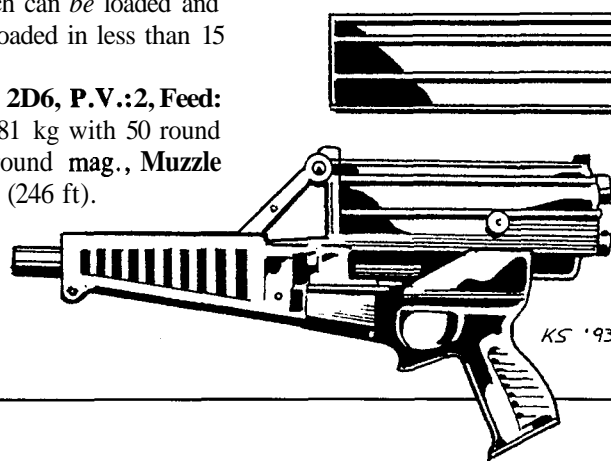

100 ROUND MAGAZINE

9mm CALICO WITH 50 ROUND MAGAZINE

## Colt .45 Pistol

**Cartridge:** .45, **Damage:** 4D6, **P.V.:** 4, **Feed:** 6 round box mag., **Weight:** 1190 grams, **Barrel Length:** 140mm, **Muzzle Velocity:** 250 m/s, **Approx. Effective Range:** 50 m (164 ft).

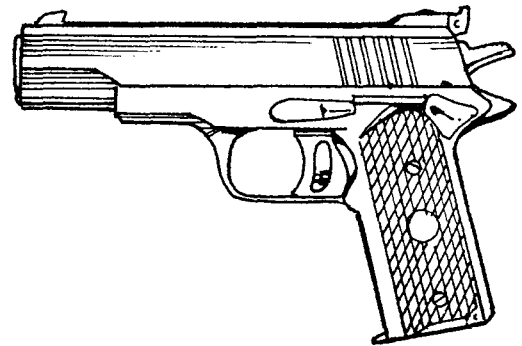
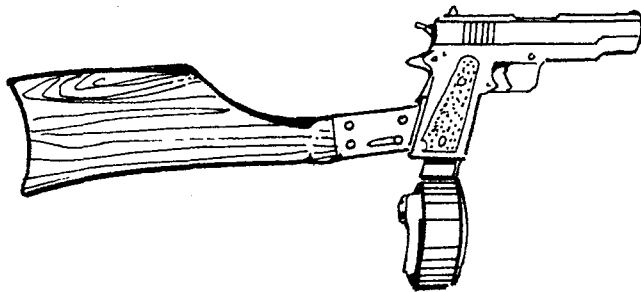

## Colt .45 Model 15 General Officers Pistol

**Cartridge:** .45 ACP, **Damage:** 4D6, **P.V.:** 4, **Feed:** 7 round box mag., **Weight:** 1.02 kg, **Barrel Length:** 106mm (200mm), **Muzzle Velocity:** 245 m/s, **Approx. Effective Range:** 50 m (164 ft).



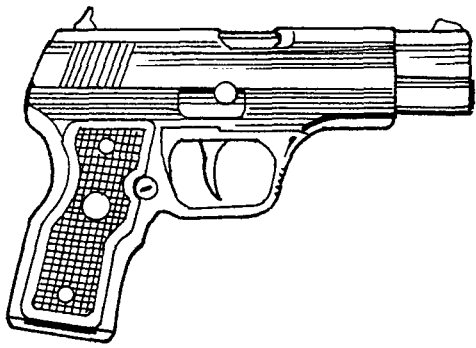

### Colt 2000, 9mm Pistol

This new pistol marks the first move away from John Browning's original design of the locking breech that drops and swings. The barrel of the Colt 2000 has lugs above and below the chamber. The top lug locks into a recess in the slide and the bottom lug rides in a cam path cut into a "cam block" that rests in the frame. The firing mechanism is also innovative. The magazine release is ambidextrous and there is no form of applied safety; the self-cocking mechanism being intrinsically safe from accidental discharge.

**Cartridge:** 9mm, **Damage:** 3D6, **P.V.:** 4, **Feed:** 9 round mag., **Weight:** 1.01 kg, **Barrel Length:** Not available, **Muzzle Velocity:** not available, **Approx. Effective Range:** 55 m (180.4 ft).

### Colt 10mm Delta Elite Pistol

**Cartridge:** 10mm, **Damage:** 4D6, **P.V.:** 4, **Feed:** 9 round mag., **Weight:** 1.02 kg, **Barrel Length:** 110mm (215mm), **Muzzle Velocity:** 255 m/s, **Approx. Effective Range:** 50 m (164 ft).

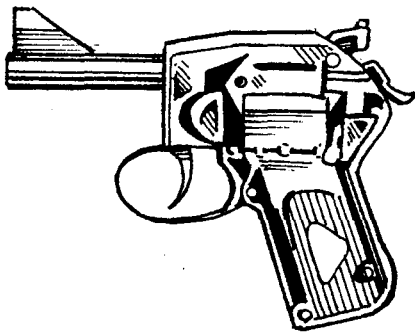
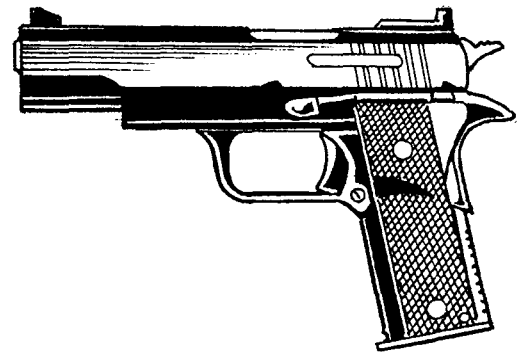

### Dardick

**Cartridge:** .38, **Damage:** 2D6, **P.V.:** 4, **Feed:** 11 round mag., **Weight:** 700 grams, **Muzzle Velocity:** 360 m/s, **Approx. Effective Range:** 50 m (164 ft).

### Harrington & Richardson Defender Revolver

**Cartridge:** .38, **Damage:** 2D6, **P.V.:** 4, **Feed:** 5 chamber side-loading cylinder, **Weight:** 878 grams, **Barrel Length:** 101mm, **Muzzle Velocity:** 245 m/s, **Approx. Effective Range:** 40 m (131 ft).

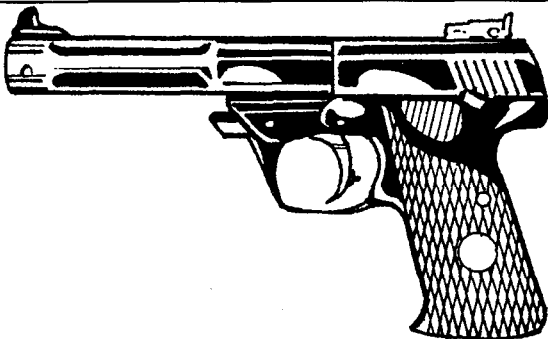
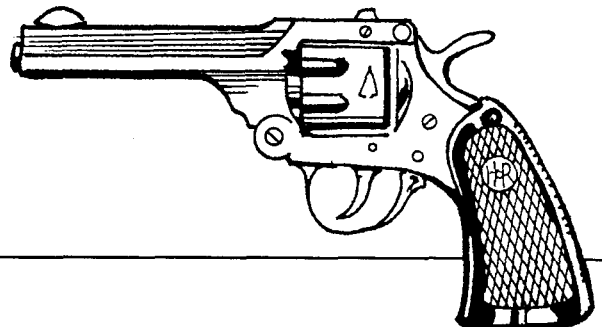

### High Standard Supermatic

**Cartridge:** .22, **Damage:** 1D8, **P.V.:** 2, **Feed:** 10 round mag., **Weight:** 1088 grams, **Barrel Length:** 171mm, **Muzzle Velocity:** 300 m/s, **Approx. Effective Range:** 45 m (476 ft).

### High Standard Victor

**Cartridge:** .22, **Damage:** 1D8, **P.V.:** 2, **Feed:** 10 round box mag., **Weight:** 1360 grams, **Barrel Length:** 115mm, **Muzzle Velocity:** 320 m/s, **Approx. Effective Range:** 40 m (131 ft).

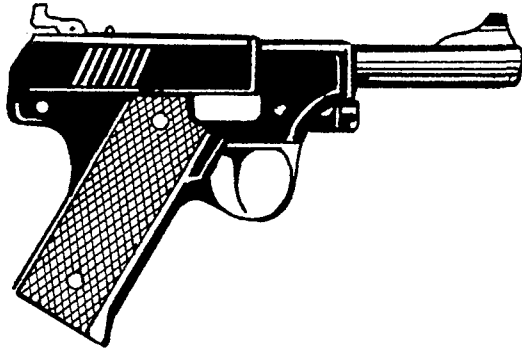
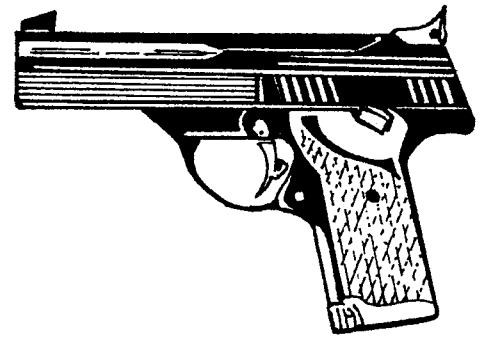

### Kimball

**Cartridge:** .30, **Damage:** 1D8, **P.V.:** 2, **Feed:** 7 round box mag., **Weight:** 1133 grams, **Barrel Length:** 127mm (215mm), **Muzzle Velocity:** 280 m/s, **Approx. Effective Range:** 40 m (131 ft).

### Model GS-32N Military Ruger Revolver

**Cartridge:** .38 Special, **Damage:** 2D6, **P.V.:** 4, **Feed:** 6 chamber side-loading cylinder, **Weight:** 964 grams, **Barrel Length:** 70mm (197mm), **Muzzle Velocity:** 360 m/s, **Approx. Effective Range:** 50 m (164 ft).

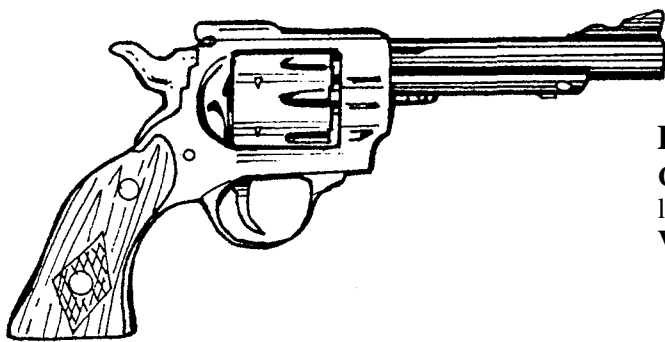
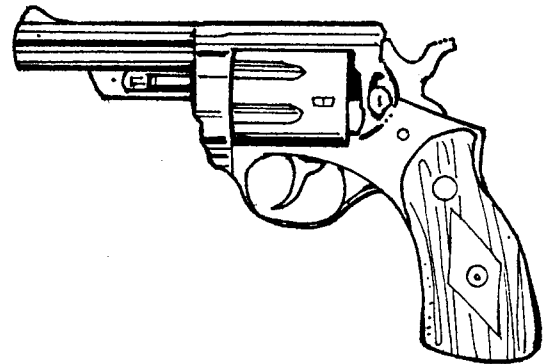

### Ruger Single-Six

**Cartridge:** .22, **Damage:** 1D8, **P.V.:** 2, **Feed:** 6 chamber cylinder, **Weight:** 978 grams, **Barrel Length:** 165mm, **Muzzle Velocity:** 300 m/s, **Approx. Effective Range:** 40 m (131 ft).

### .38 Service-Six Ruger Revolver

**Cartridge:** .38 Special, **Damage:** 2D6, **P.V.:** 4, **Feed:** 6 chamber side-loading cylinder, **Weight:** 935 grams, **Barrel Length:** 101mm (235mm), **Muzzle Velocity:** 350 m/s, **Approx. Effective Range:** 50 m (164 ft).

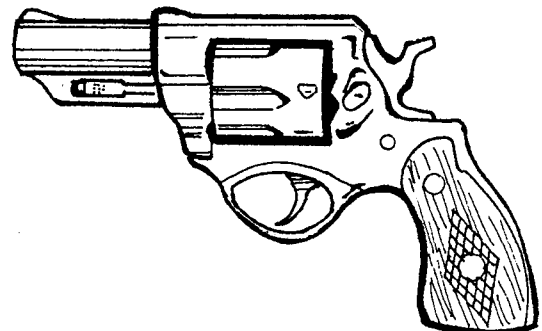

**ASP 9mm Combat version of Smith & Wesson M39**

**Cartridge:** 9mm Parabellum, **Damage:** 2D6, **P.V.:** 4, **Feed:** 7 round box mag., **Weight:** 0.57 kg, **Barrel Length:** 57mm (188mm), **Muzzle Velocity:** 350 m/s, **Approx. Effective Range:** 50 m (164 ft).

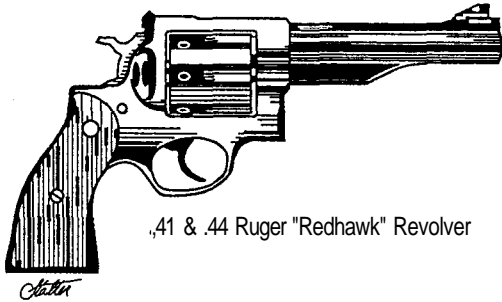

.41 & .44 Ruger "Redhawk" Revolver

**.44 Magnum Ruger 'Super Redhawk' Revolver**

**Cartridge:** .44 Magnum, **Damage:** 5D6, **P.V.:** 6, **Feed:** 6 shot cylinder, **Weight:** 1.502 kg, **Barrel Length:** 190mm (330mm), **Muzzle Velocity:** 350 m/s, **Approx. Effective Range:** 55 m (180.4 ft).

**YUGOSLAVIA**

**7.62mm Model M57**

**Cartridge:** 7.62mm TT, **Damage:** 1D8, **P.V.:** 2, **Feed:** 9 round box mag., **Weight:** 900 grams, **Barrel Length:** 116mm (200mm), **Muzzle Velocity:** 450 m/s, **Approx. Effective Range:** 55 m (180.4 ft).

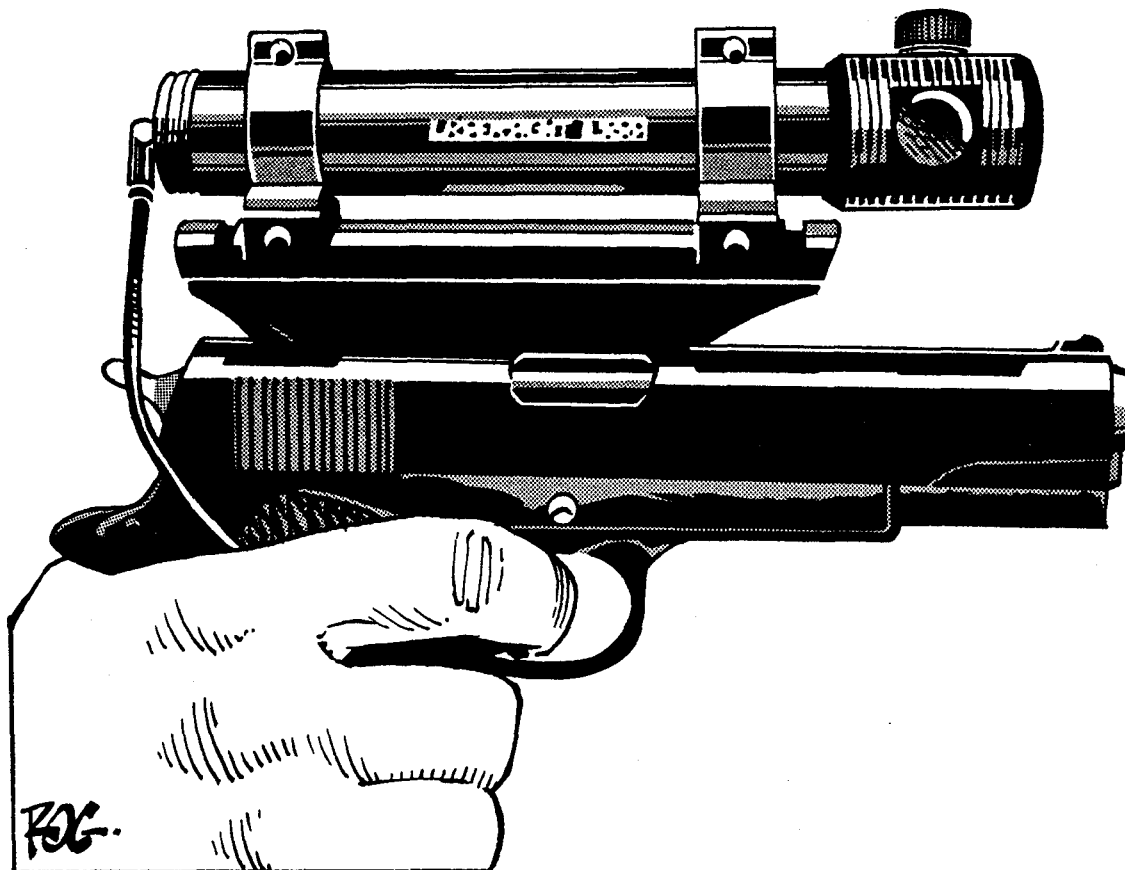
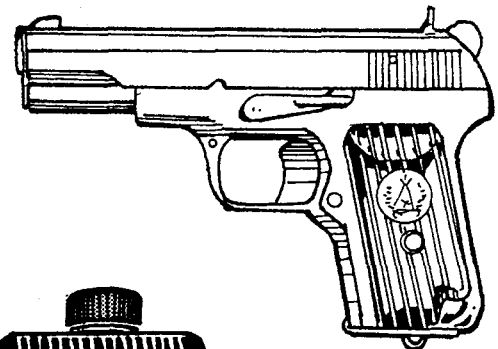

# Rifles

One of the strange features about rifles in general, is the stability in their design. From 1870 to 1900 there were a great deal of changes made in rifles. Then the world seemed to settle down to some form of bolt-action magazine weapon which fired a 7.92mm caliber shell. This continued until the end of World War II and designs began to slowly change. By 1960 the pattern had settled again. At this time, the majority of the world then started using self-loading rifles equipped with box magazines holding at least 20 rounds. All of these used a less powerful round, but were very effective in normal combat conditions. Much of the ammunition used was derived from wartime designs and fired a heavy, slow bullet compared to much more modern ammunition.

Most of the rifles now in use have been in service for approximately 15 years. Unfortunately, unlike its predecessor, the old bolt-action rifles, the newer self-loading rifles experience more wear. They are subject to much higher forces and loads when they fire and unfortunately they are not made in the heavily engineered ways of the past. The parts do wear out faster. The

decision most countries were faced with was to decide whether it would be worth the time and trouble to revamp an old design or whether they should try and find a more modern design altogether. It has been found that an infantry rifleman can be just as effective with a lightweight rifle that has an effective range of 300 m as he can with a heavier weapon with an effective range of 1000 m. Also, the ammunition for the smaller weapon may weigh half of that of the heavier weapon. It is this sort of thing that has brought about the present change in rifle designs. Calculations show that troops can be more effective with these short-range rifles than those that can shoot farther.

An interesting side effect of the new interest in self-loading rifles is sniping. Very few self-loading rifles are capable of such precise shooting. Therefore, there has been a renewed interest in the old bolt-action rifles, along with the necessary aids for good target shooting. This is naturally going to improve one's domination on the battlefield beyond that of the normal infantryman. This is also very useful in terrorist and police actions. **Note:** Not all rifle listings have a Rate of Fire.

## AUSTRALIA

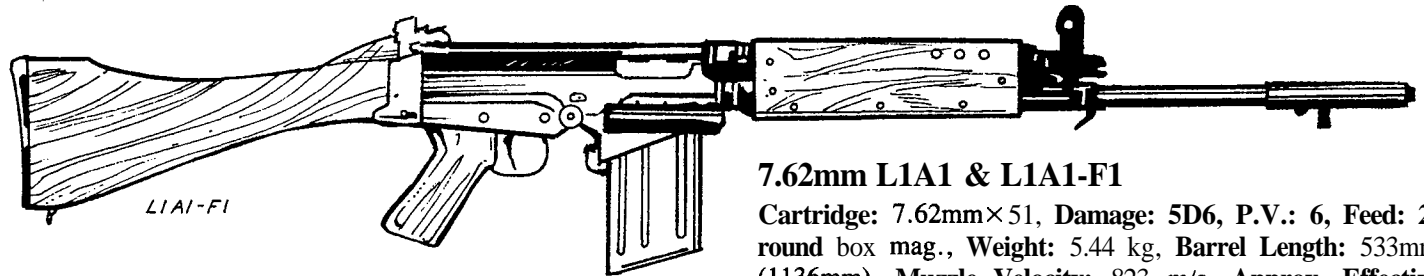

### 7.62mm L1A1 & L1A1-F1

**Cartridge:** 7.62mm×51, **Damage:** 5D6, **P.V.:** 6, **Feed:** 20 round box mag., **Weight:** 5.44 kg, **Barrel Length:** 533mm (1136mm), **Muzzle Velocity:** 823 m/s, **Approx. Effective Range:** 600 m (1968.5 ft).

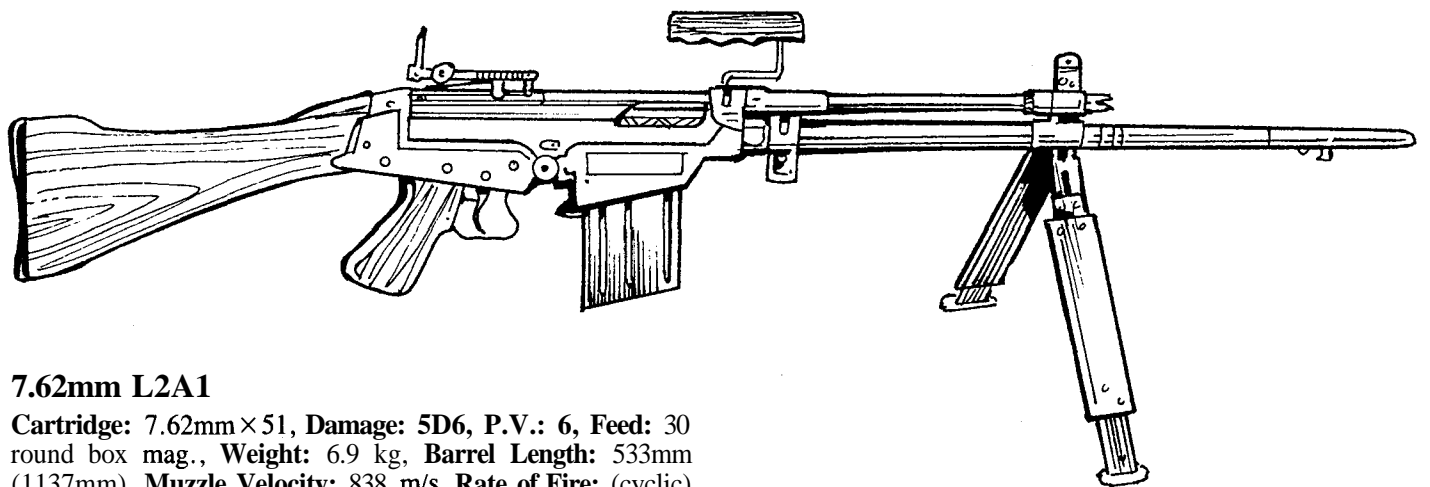

### 7.62mm L2A1

**Cartridge:** 7.62mm×51, **Damage:** 5D6, **P.V.:** 6, **Feed:** 30 round box mag., **Weight:** 6.9 kg, **Barrel Length:** 533mm (1137mm), **Muzzle Velocity:** 838 m/s, **Rate of Fire:** (cyclic) 675-750 rounds/min., **Approx. Effective Range:** 800 m (2625 ft).

## AUSTRIA

---

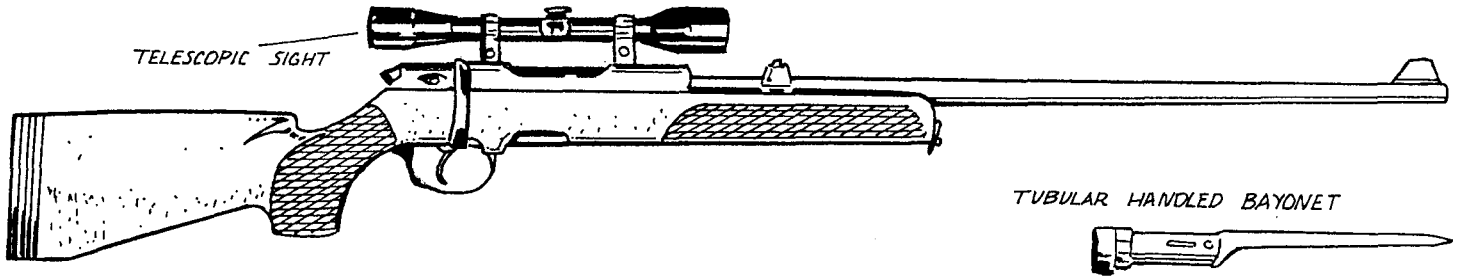

### 7.62mm SSG 69

**Cartridge:** 7.62mm x 51, or .243 Winchester, **Damage:** 5D6, **P.V.:** 6, **Feed:** 5 round rotary mag. or 10 round box mag., **Weight:** 3.9 kg, **Barrel Length:** 650mm (1140mm), **Muzzle Velocity:** 860 m/s, **Approx. Effective Range:** 800 m (2625 ft).

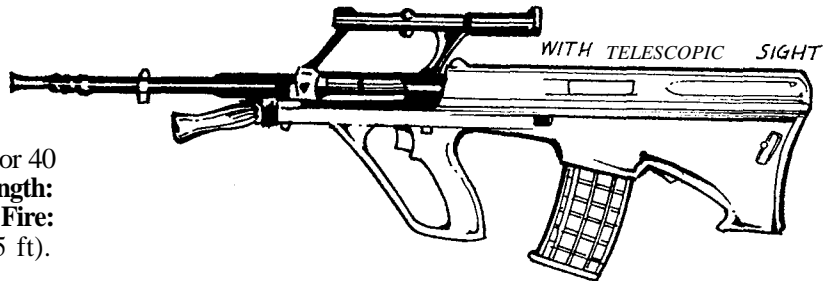

### 5.56mm Army Universal Gun Steyr

**Cartridge:** 5.56mm, **Damage:** 5D6, **P.V.:** 6, **Feed:** 30 or 40 round detachable box mag., **Weight:** 3.6 kg, **Barrel Length:** 508mm (790mm), **Muzzle Velocity:** 960 m/s, **Rate of Fire:** 650 rounds/min., **Approx. Effective Range:** 800 m (2625 ft).

## BELGIUM

---

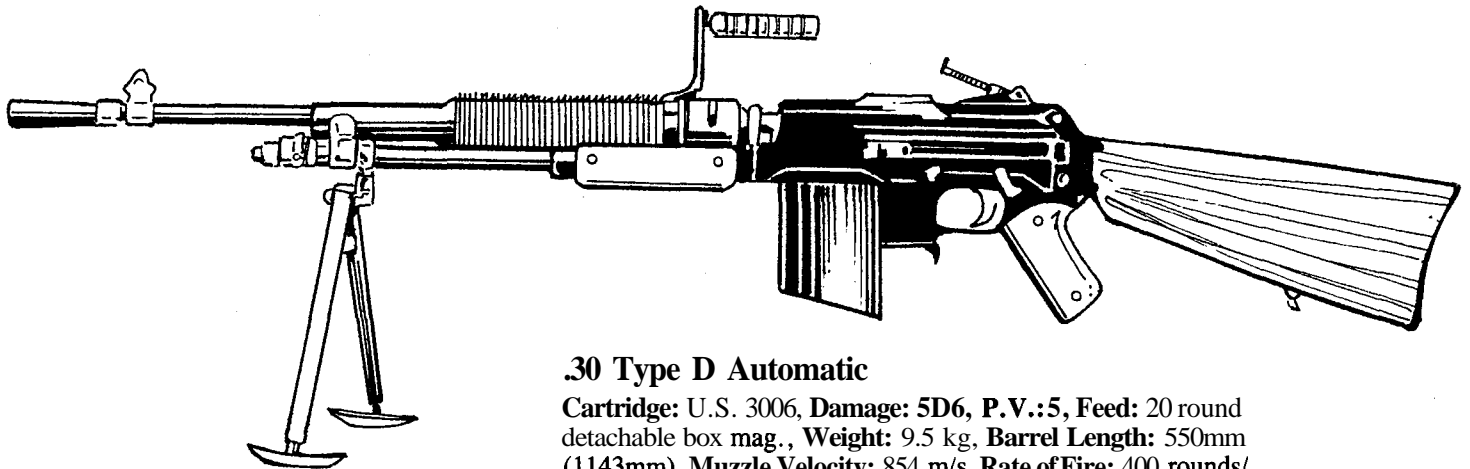

### .30 Type D Automatic

**Cartridge:** U.S. 3006, **Damage:** 5D6, **P.V.:** 5, **Feed:** 20 round detachable box mag., **Weight:** 9.5 kg, **Barrel Length:** 550mm (1143mm), **Muzzle Velocity:** 854 m/s, **Rate of Fire:** 400 rounds/min., **Approx. Effective Range:** 800 m (2625 ft).

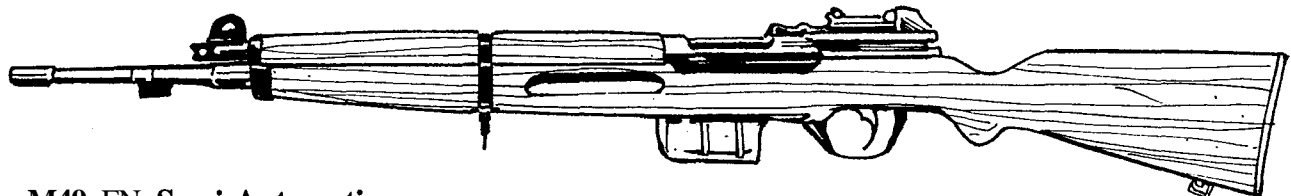

### 7.92mm M49 FN Semi-Automatic

**Cartridge:** 7.92mm, **Damage:** 5D6, **P.V.:** 6, **Feed:** 10 round charger-loaded mag., **Weight:** 4.3 kg, **Barrel Length:** 589mm (1110mm), **Muzzle Velocity:** 754 m/s, **Approx. Effective Range:** 700 m (2297 ft).

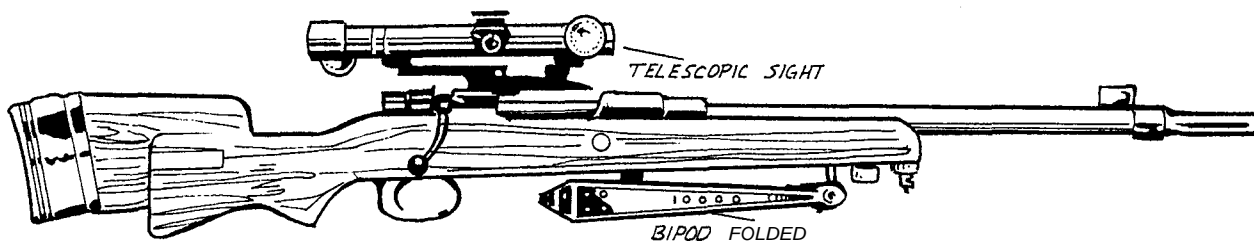

### 7.62mm Model 30-11 Sniping FN Rifle

**Cartridge:** 7.62mm×51 Nato, **Damage:** 5D6, **P.V.:** 5, **Feed:** 9 round removeable box mag., **Weight:** 4.85 kg, **Barrel Length:** 502mm (1117mm), **Muzzle Velocity:** 850 m/s, **Approx. Effective Range:** 650 m (2133 ft).

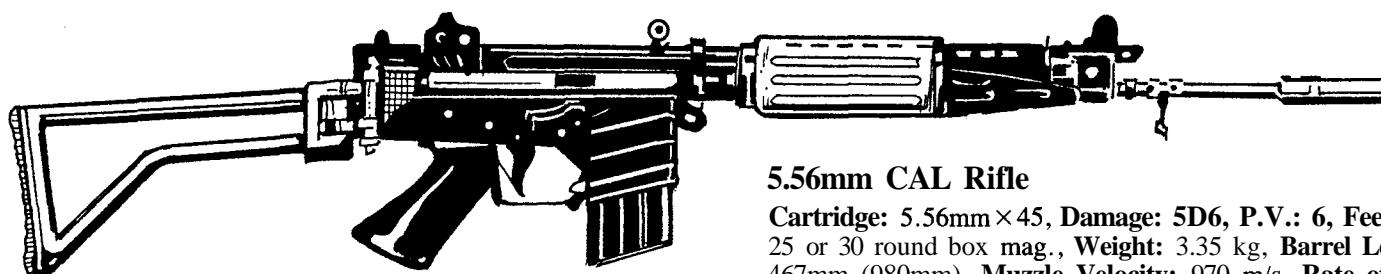

### 5.56mm CAL Rifle

**Cartridge:** 5.56mm×45, **Damage:** 5D6, **P.V.:** 6, **Feed:** 20, 25 or 30 round box mag., **Weight:** 3.35 kg, **Barrel Length:** 467mm (980mm), **Muzzle Velocity:** 970 m/s, **Rate of Fire:** 650-700 rounds/min., **Approx. Effective Range:** 680 m (2231 ft).

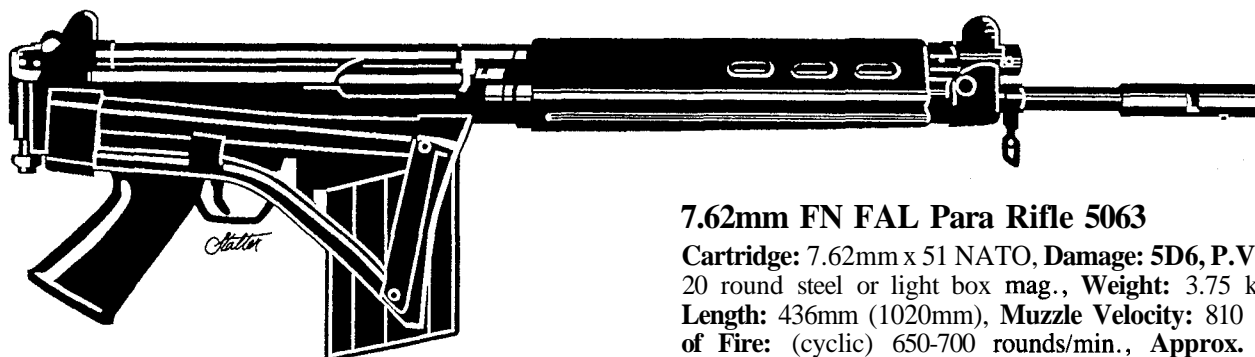

### 7.62mm FN FAL Para Rifle 5063

**Cartridge:** 7.62mm x 51 NATO, **Damage:** 5D6, **P.V.:** 6, **Feed:** 20 round steel or light box mag., **Weight:** 3.75 kg, **Barrel Length:** 436mm (1020mm), **Muzzle Velocity:** 810 m/s, **Rate of Fire:** (cyclic) 650-700 rounds/min., **Approx. Effective Range:** 650 m (2133 ft).

## BRAZIL

---

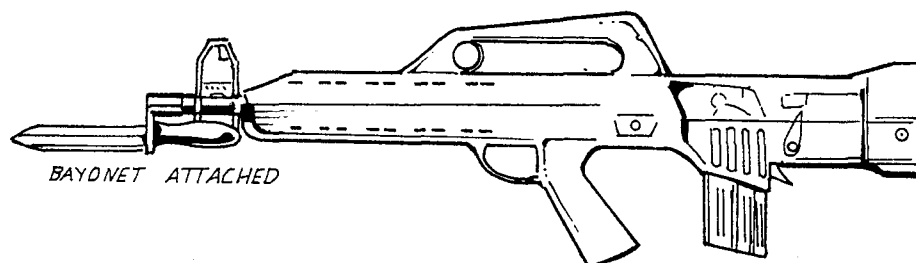

### 5.56mm Model 03 LAPA FA Assault Rifle

**Cartridge:** 5.56mm×45, **Damage:** 5D6, **P.V.:** 6, **Feed:** 20, 30 or 40 round plastic box mag., **Weight:** 3.48 kg, **Barrel Length:** 489mm (738mm), **Muzzle Velocity:** 1000 m/s, **Rate of Fire:** (cyclic) 650-700 rounds/min., **Approx. Effective Range:** 630 m (2067 ft).



## CANADA

---

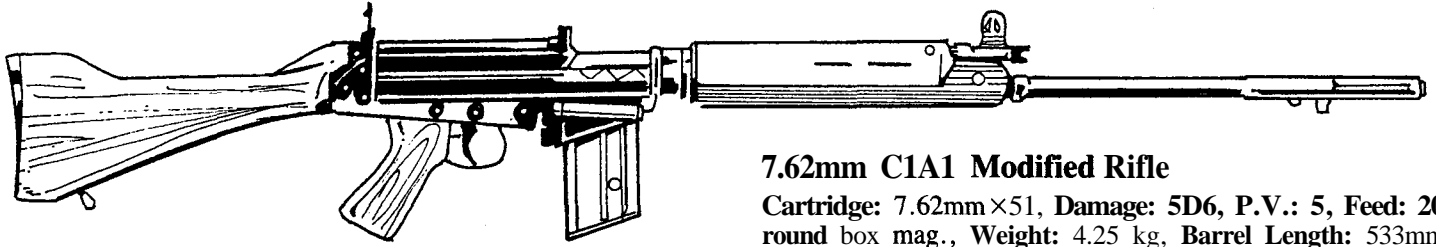

### 7.62mm C1A1 Modified Rifle

**Cartridge:** 7.62mm×51, **Damage:** 5D6, **P.V.:** 5, **Feed:** 20 round box mag., **Weight:** 4.25 kg, **Barrel Length:** 533mm (1136mm), **Muzzle Velocity:** 854 m/s, **Approx. Effective Range:** 650 m (2133 ft).

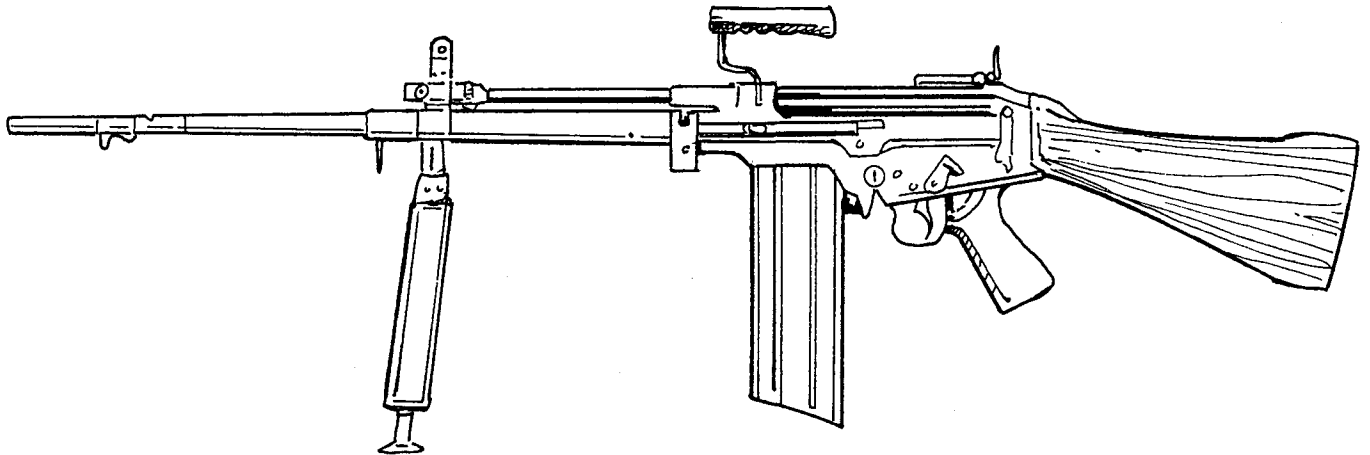

### 7.62mm C2 & C2A1 Automatic Rifle

**Cartridge:** 7.62mm×51, **Damage:** 5D6, **P.V.:** 6, **Feed:** 30 round box mag., **Weight:** 6.9 kg, **Barrel Length:** 533mm (1136mm), **Muzzle Velocity:** 854 m/s, **Rate of Fire:** 10-15 rounds/min., **Approx. Effective Range:** 700 m (2297 ft).

## CHINA

---

### 7.62mm Type 53 Carbine

**Cartridge:** 7.62mm×54R, **Damage:** 5D6, **P.V.:** 6, **Feed:** 30 round internal box mag., **Weight:** 3.92 kg, **Barrel Length:** 520mm (1029mm), **Muzzle Velocity:** 766 m/s, **Rate of Fire:** 10-15 rounds/min., **Approx. Effective Range:** 400 m (1312 ft).

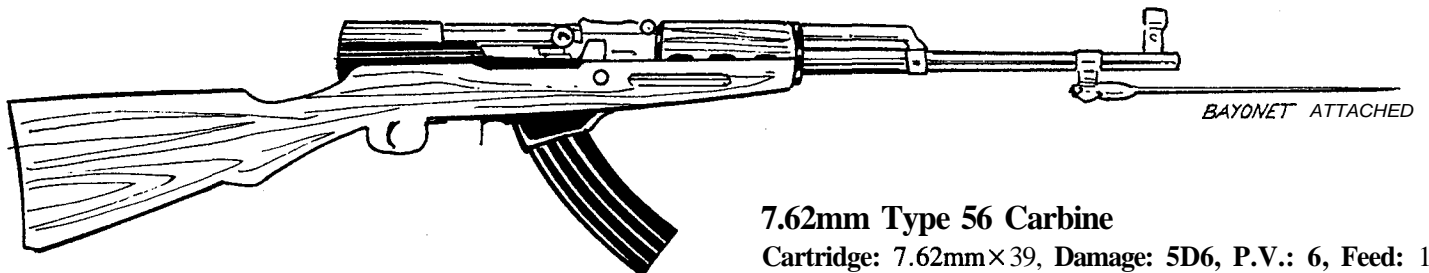

### 7.62mm Type 56 Carbine

**Cartridge:** 7.62mm×39, **Damage:** 5D6, **P.V.:** 6, **Feed:** 10 round internal mag., **Weight:** 3.86 kg, **Barrel Length:** 521mm (1021mm), **Muzzle Velocity:** 735 m/s, **Rate of Fire:** 10-15 rounds/min., **Approx. Effective Range:** 400 m (1312 ft).

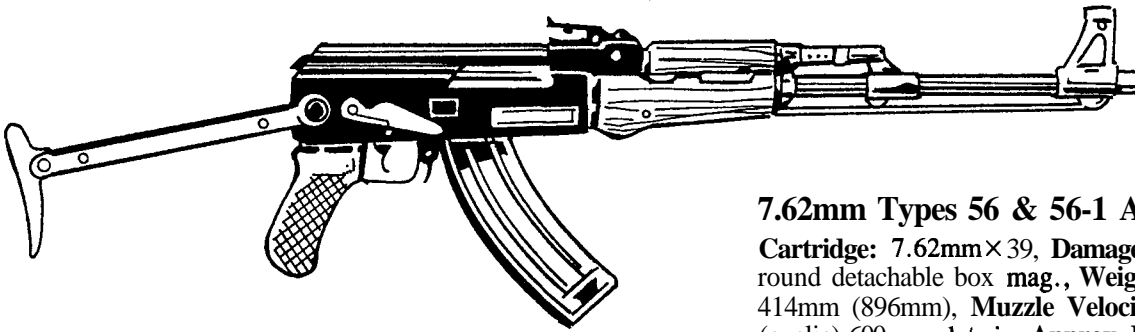

### 7.62mm Types 56 & 56-1 Assault Rifles

**Cartridge:** 7.62mm×39, **Damage:** 5D6, **P.V.:** 6, **Feed:** 30 round detachable box mag., **Weight:** 4.3 kg, **Barrel Length:** 414mm (896mm), **Muzzle Velocity:** 824 m/s, **Rate of Fire:** (cyclic) 600 rounds/min. **Approx. Effective Range:** 300 m (984 ft).

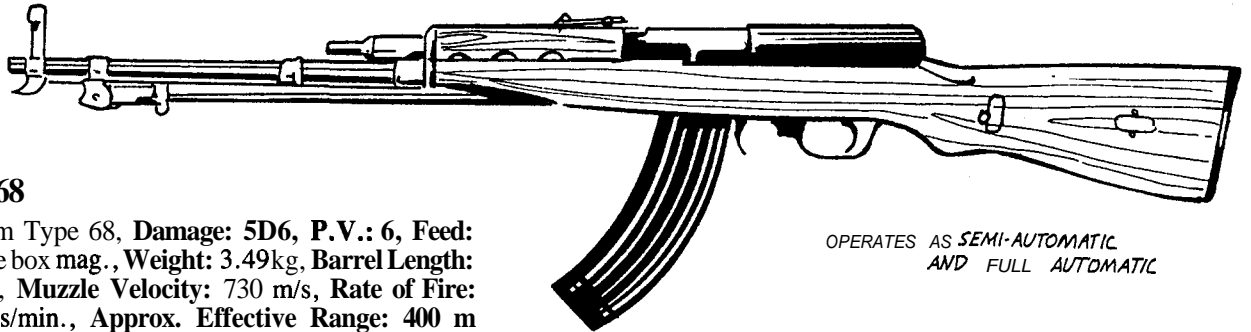

OPERATES AS SEMI-AUTOMATIC  
AND FULL AUTOMATIC

### 7.62mm Type 68

**Cartridge:** 7.62mm Type 68, **Damage:** 5D6, **P.V.:** 6, **Feed:** 15 round detachable box mag., **Weight:** 3.49kg, **Barrel Length:** 521mm (1029mm), **Muzzle Velocity:** 730 m/s, **Rate of Fire:** (cyclic) 750 rounds/min., **Approx. Effective Range:** 400 m (1312 ft).

## CZECHOSLOVAKIA

---

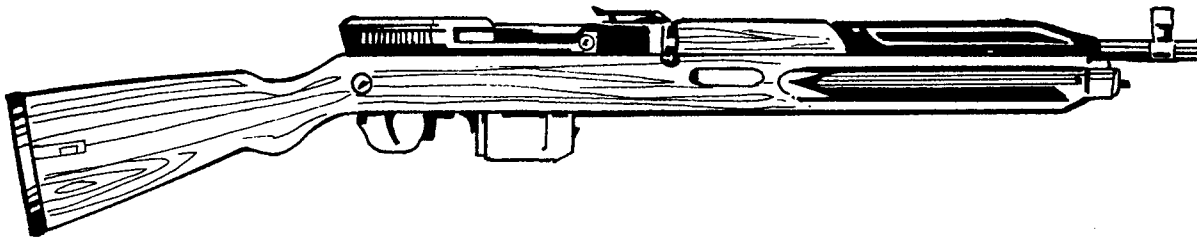

### 7.62mm Models 52 & 56/57 Self-Loading

**Cartridge:** 7.62mm×45, **Damage:** 5D6, **P.V.:** 6, **Feed:** 10 round box mag., **Weight:** 4.1 kg, **Barrel Length:** 523mm (1003mm), **Muzzle Velocity:** 744 m/s, **Approx. Effective Range:** 350 m (1148 ft).

### 7.62mm M54 Sniping Rifle

**Cartridge:** 7.62mm×54R, **Damage:** 5D6, **P.V.:** 6, **Feed:** 10 round box mag., **Weight:** 4.1 kg, **Barrel Length:** 552mm (1148mm), **Muzzle Velocity:** 811 m/s, **Approx. Effective Range:** 1000 m (3280 ft).

### 7.62mm Model 58 Assault Rifle

**Cartridge:** 7.62mm×39, **Damage:** 5D6, **P.V.:** 6, **Feed:** 30 round box mag., **Weight:** 3.14 kg, **Barrel Length:** 401mm (820mm), **Muzzle Velocity:** 710 m/s, **Rate of Fire:** (cyclic) 800 rounds/min., **Approx. Effective Range:** 400 m (1312 ft).



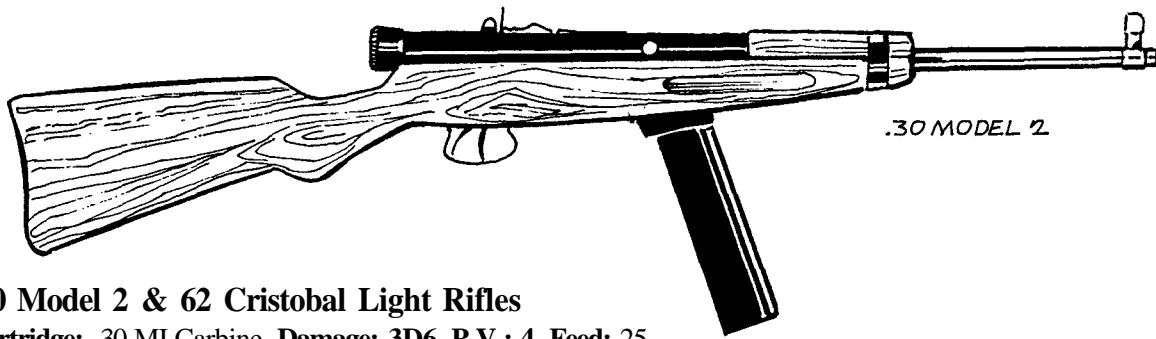

*.30 MODEL 2*

**.30 Model 2 & 62 Cristobal Light Rifles**

**Cartridge:** .30 MI Carbine, **Damage:** 3D6, **P.V.:** 4, **Feed:** 25 or 30 round detachable box mag., **Weight:** 3.52 kg, **Barrel Length:** 409mm (945mm), **Muzzle Velocity:** 572 m/s, **Rate of Fire:**(cyclic) 580 rounds/min., **Approx. Effective Range:** 300 m (984 ft).

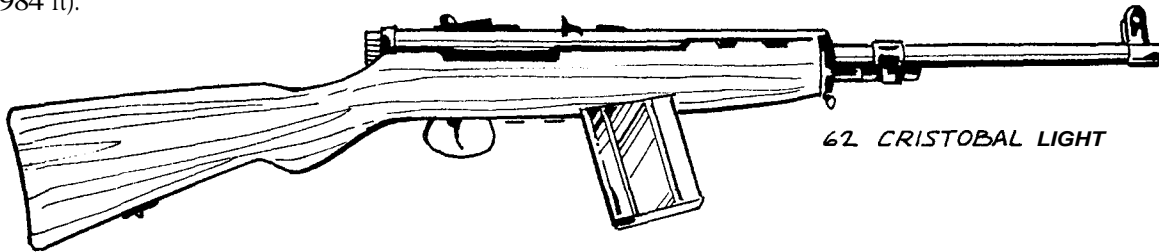

*62 CRISTOBAL LIGHT*

**FINLAND**

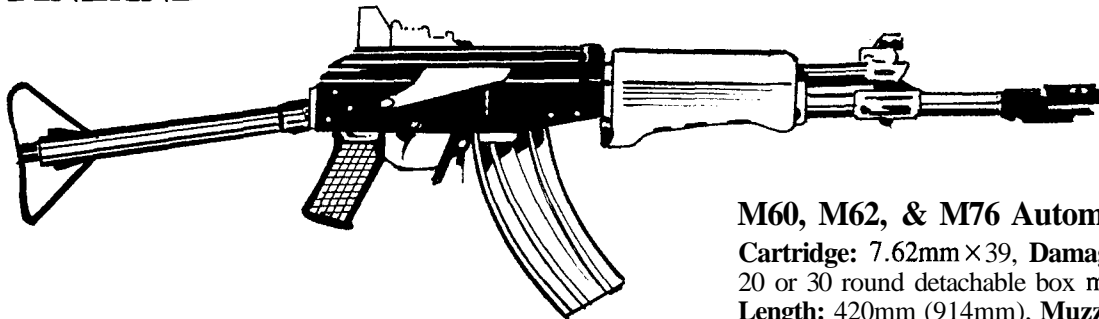

**M60, M62, & M76 Automatic Valmet**

**Cartridge:** 7.62mm×39, **Damage:** 5D6, **P.V.:** 6, **Feed:** 15, 20 or 30 round detachable box mag., **Weight:** 3.6 kg, **Barrel Length:** 420mm (914mm), **Muzzle Velocity:** 719 m/s, **Rate of Fire:** (cyclic) 650 rounds/min., **Approx. Effective Range:** 350-400 m (1148-1312 ft).

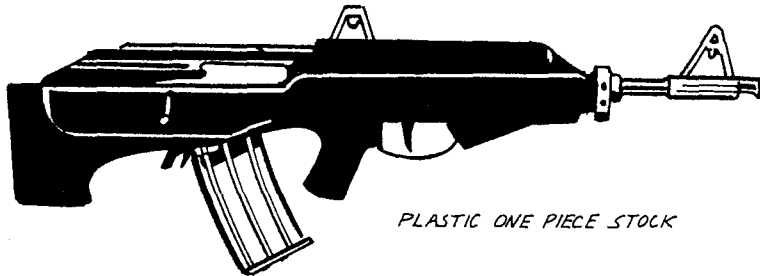

*PLASTIC ONE PIECE STOCK*

**5.56mm M76 Short (Model 255 470) Automatic Valmet**

**Cartridge:** 5.56mm×45, **Damage:** 3D6, **P.V.:** 5, **Feed:** 15, 20 or 30 round box mag., **Weight:** 3.3 kg, **Barrel Length:** 420mm (7106mm), **Muzzle Velocity:** 960 m/s, **Rate of Fire:** (cyclic) 650 rounds/min., **Approx. Effective Range:** 350-400 m (1148-1312 ft).

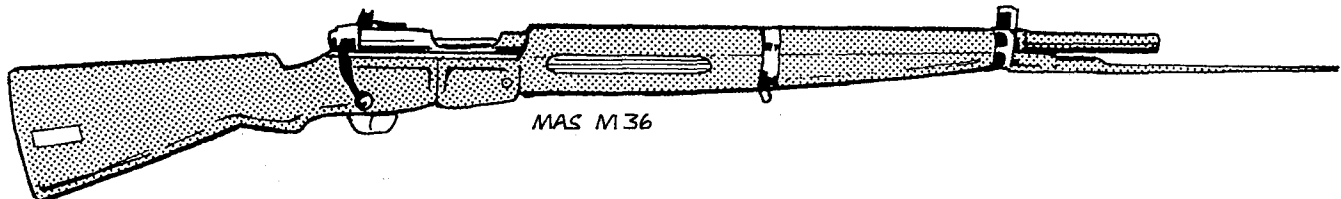

*MAS M36*

**7.65mm MAS M 36 Rifle**

**Cartridge:** 7.65mm M29, **Damage:** 4D6, **P.V.:** 5, **Feed:** 5 round internal mag., **Weight:** 3.8 kg, **Barrel Length:** 574mm (1018mm), **Muzzle Velocity:** 800 m/s, **Approx. Effective Range:** 500 m (1640 ft).

**7.5mm MAS 49 Rifle**

**Cartridge:** 7.5mm Model 1929, **Damage:**5D6, **P.V.:** 6, **Feed:** 10 round detachable box mag., **Weight:** 4.7 kg, **Barrel Length:** 580mm (1100mm), **Muzzle Velocity:** 823 m/s, **Rate of Fire:** 30 rounds/min., **Approx. Effective Range:** 600 m (1969 ft).

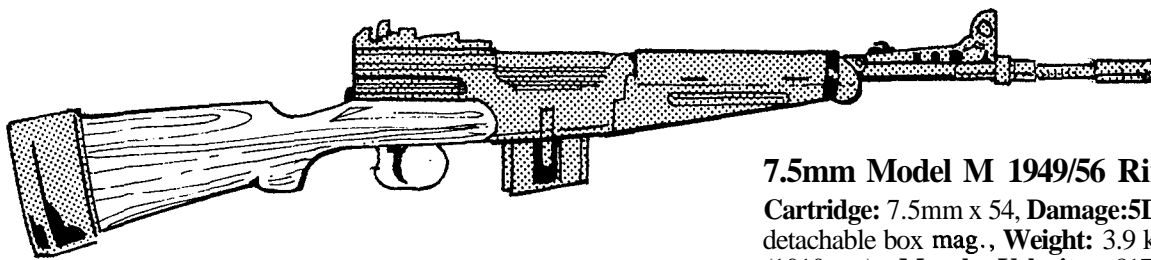

**7.5mm Model M 1949/56 Rifle**

**Cartridge:** 7.5mm x 54, **Damage:** 5D6, **P.V.:** 6, **Feed:** 10 round detachable box mag., **Weight:** 3.9 kg, **Barrel Length:** 521mm (1010mm), **Muzzle Velocity:** 817 m/s, **Approx. Effective Range:** 600 m (1969 ft).

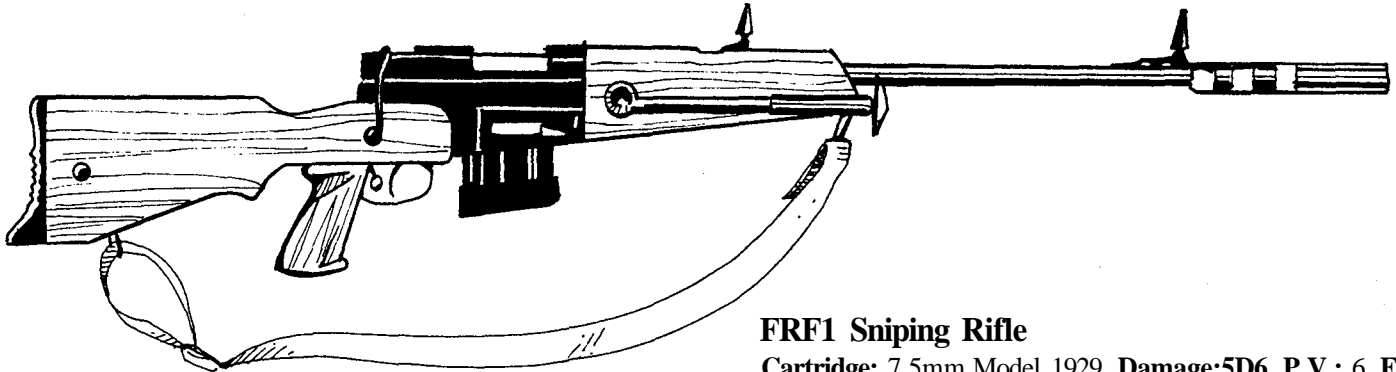

**FRF1 Sniping Rifle**

**Cartridge:** 7.5mm Model 1929, **Damage:** 5D6, **P.V.:** 6, **Feed:** 10 round detachable box mag., **Weight:** 5.2 kg, **Barrel Length:** 552mm (1138mm), **Muzzle Velocity:** 852 m/s, **Rate of Fire:** 10-15 rounds/min., **Approx. Effective Range:** 800 m (2625 ft).

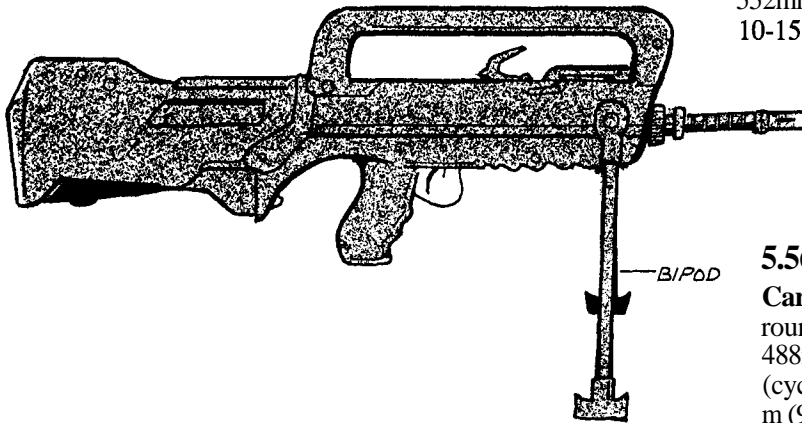

**5.56m FA MAS Rifle**

**Cartridge:** 5.56mm x 45, **Damage:** 3D6, **P.V.:** 5, **Feed:** 25 round detachable box mag., **Weight:** 3.61 kg, **Barrel Length:** 488mm (757mm), **Muzzle Velocity:** 960 m/s, **Rate of Fire:** (cyclic) 900-1000 rounds/min., **Approx. Effective Range:** 300 m (984 ft).

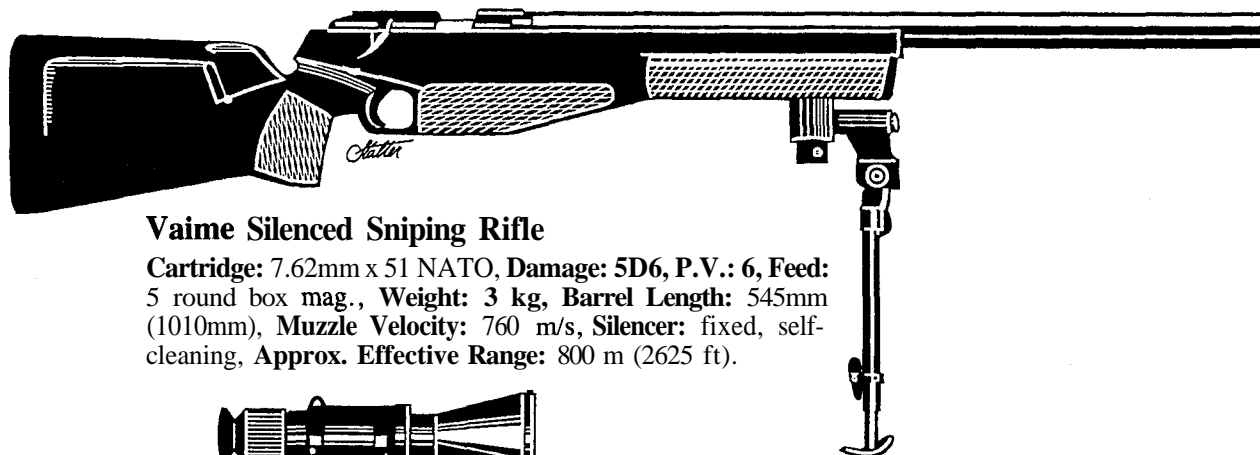

**Vaime Silenced Sniping Rifle**

**Cartridge:** 7.62mm x 51 NATO, **Damage:** 5D6, **P.V.:** 6, **Feed:** 5 round box mag., **Weight:** 3 kg, **Barrel Length:** 545mm (1010mm), **Muzzle Velocity:** 760 m/s, **Silencer:** fixed, self-cleaning, **Approx. Effective Range:** 800 m (2625 ft).

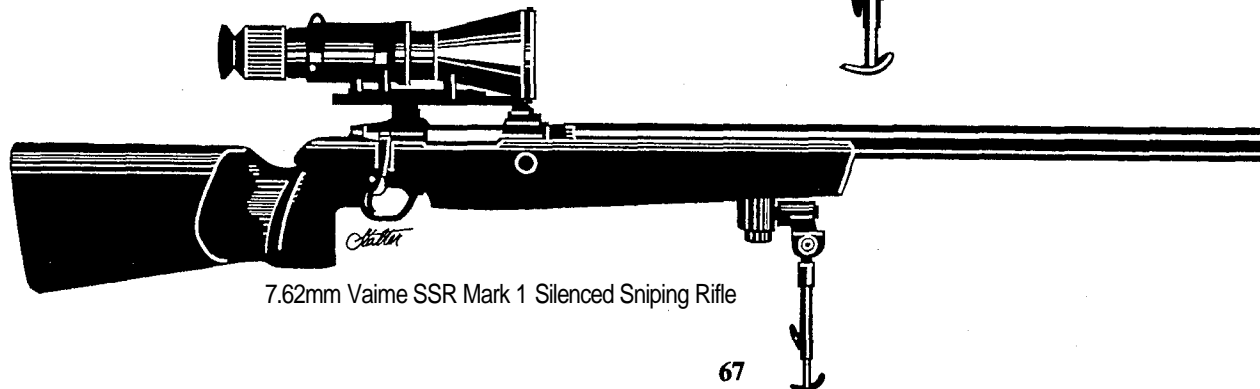

7.62mm Vaime SSR Mark 1 Silenced Sniping Rifle

# GERMANY

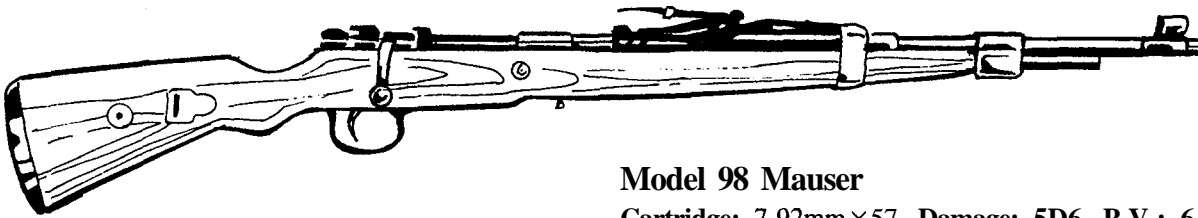

## Model 98 Mauser

**Cartridge:** 7.92mm×57, **Damage:** 5D6, **P.V.:** 6, **Feed:** 5 round internal box mag., **Weight:** 3.89 kg, **Barrel Length:** 597mm (1103mm), **Muzzle Velocity:** 754 m/s, **Approx. Effective Range:** 600 m (1969 ft).

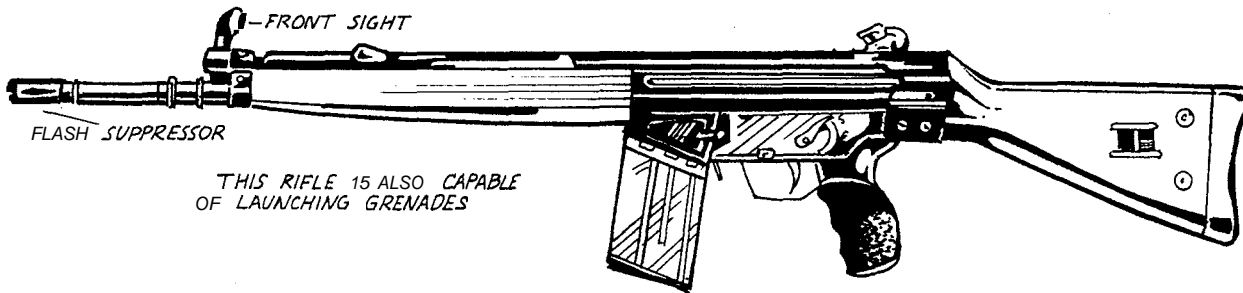

THIS RIFLE IS ALSO CAPABLE OF LAUNCHING GRENADES

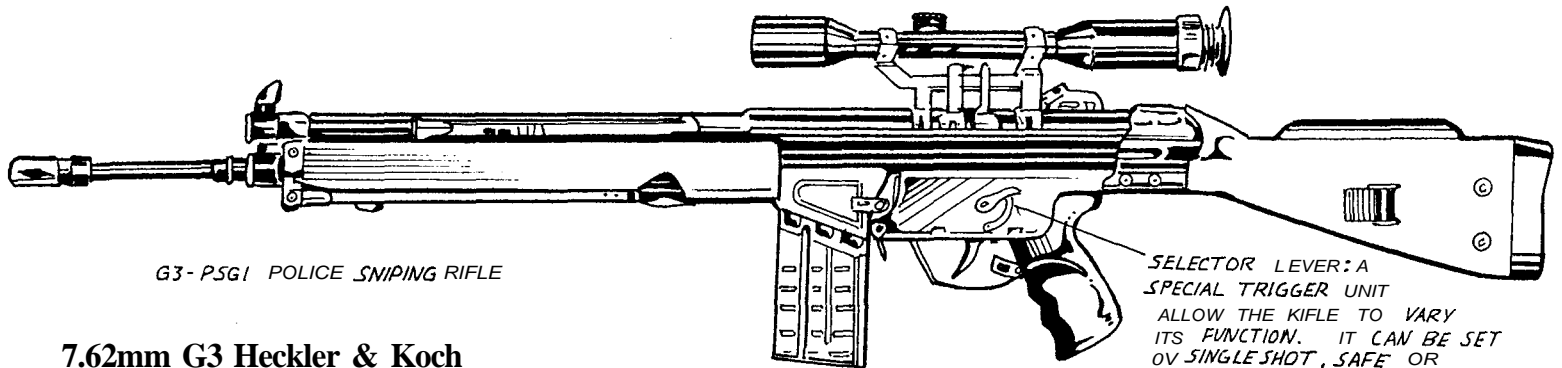

G3-PSG1 POLICE SNIPING RIFLE

SELECTOR LEVER: A SPECIAL TRIGGER UNIT ALLOW THE RIFLE TO VARY ITS FUNCTION. IT CAN BE SET ON SINGLE SHOT, SAFE OR AUTOMATIC.

## 7.62mm G3 Heckler & Koch

**Cartridge:** 7.62mm×51, **Damage:** 5D6, **P.V.:** 6, **Feed:** 20 round box mag., **Weight:** 4.4 kg, **Barrel Length:** 450mm (1025mm), **Muzzle Velocity:** 780-800 m/s, **Rate of Fire:** (cyclic) 500-600 rounds/min., (auto) 100 rounds/min., **Approx. Effective Range:** 400 m (1312 ft).

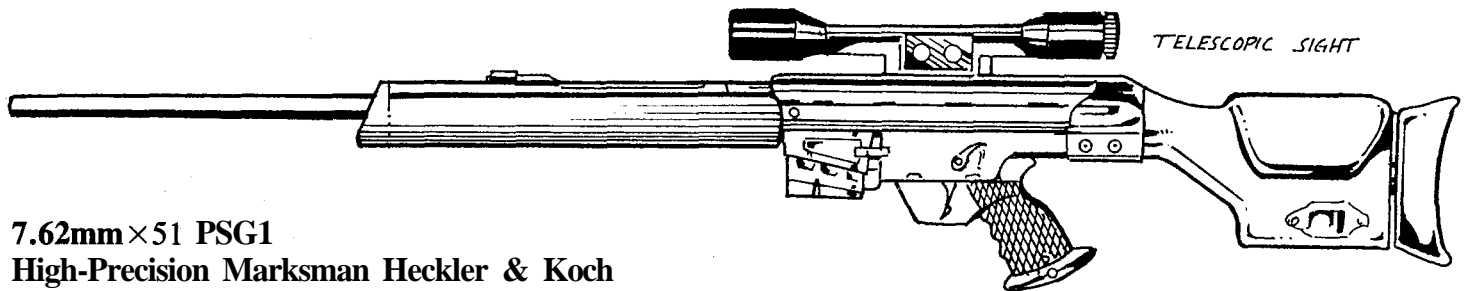

TELESCOPIC SIGHT

## 7.62mm×51 PSG1

### High-Precision Marksman Heckler & Koch

**Cartridge:** 7.62mm x 51, **Damage:** 5D6, **P.V.:** 6, **Feed:** Single-shot; option for 15, 20 or 30 round mag., **Weight:** 7.2 kg, **Barrel Length:** 650mm, **Muzzle Velocity:** 800 m/s, **Approx. Effective Range:** 400 m (1312 ft).

SEMI-AUTOMATIC - EXCELLENT ACCURACY -  
SPECIAL SYSTEM PROVIDES SILENT BOLT CLOSING-

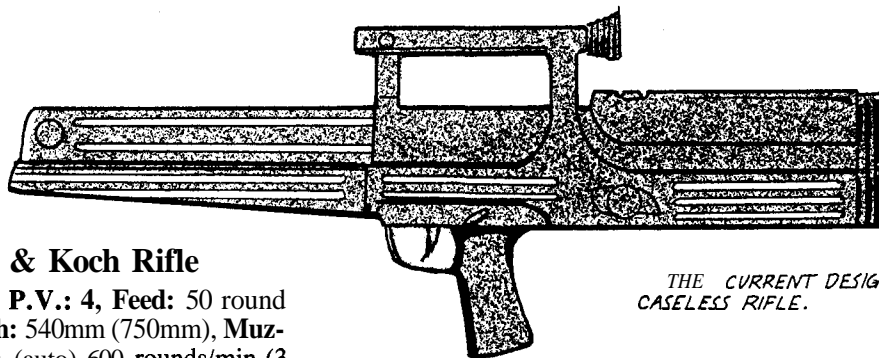

### 4.7mm G11 Caseless Heckler & Koch Rifle

**Cartridge:** 4.7mm, **Damage:** 3D6, **P.V.:** 4, **Feed:** 50 round mag., **Weight:** 3.6 kg, **Barrel Length:** 540mm (750mm), **Muzzle Velocity:** 800 m/s, **Rate of Fire:** (auto) 600 rounds/min. (3 round bursts) 2000 rounds/min., **Approx. Effective Battle Range:** 300 m (984 ft).

*THE CURRENT DESIGN OF THE H.K. CASELESS RIFLE.*

### 7.62mm Model SP66 Mauser Sniping Rifle

**Cartridge:** 7.62mm×51 (selected sniper batches), **Damage:** 5D6, **P.V.:** 6, **Feed:** 3 round integral mag., **Weight:** 4.3 kg, **Barrel Length:** 730mm, **Muzzle Velocity:** 754 m/s, **Approx. Effective Range:** 600 m (1969 ft).

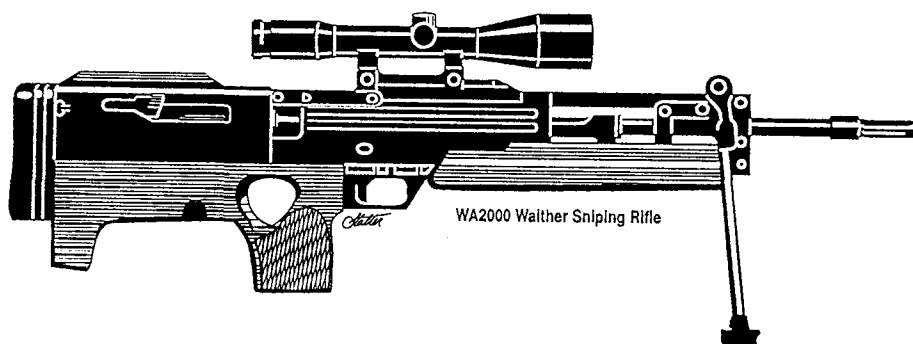

### WA2000 Walther Sniping Rifle

**Cartridge:** .300 Winchester Magnum, 7.62mm×51 NATO, **Damage:** 5D6, **P.V.:** 6, **Feed:** 6 round box mag., **Weight:** 6.95 kg, **Barrel Length:** 650mm (905mm), **Muzzle Velocity:** 830 m/s, **Approx. Effective Range:** 700 m (2297 ft).

## HUNGARY

---

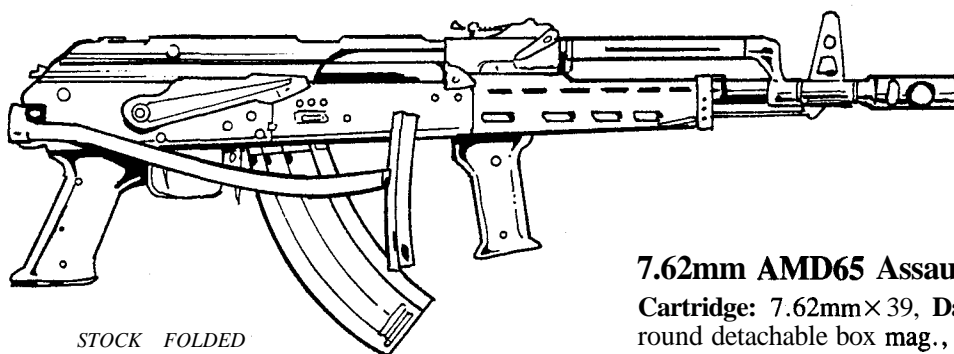

STOCK FOLDED

### 7.62mm AMD65 Assault Rifle

**Cartridge:** 7.62mm×39, **Damage:** 5D6, **P.V.:** 6, **Feed:** 30 round detachable box mag., **Weight:** 3.27kg, **Barrel Length:** 378mm (851mm), **Muzzle Velocity:** 700 m/s, **Rate of Fire:** (cyclic) 600 rounds/min., **Approx. Effective Range:** 500 m (1640 ft).

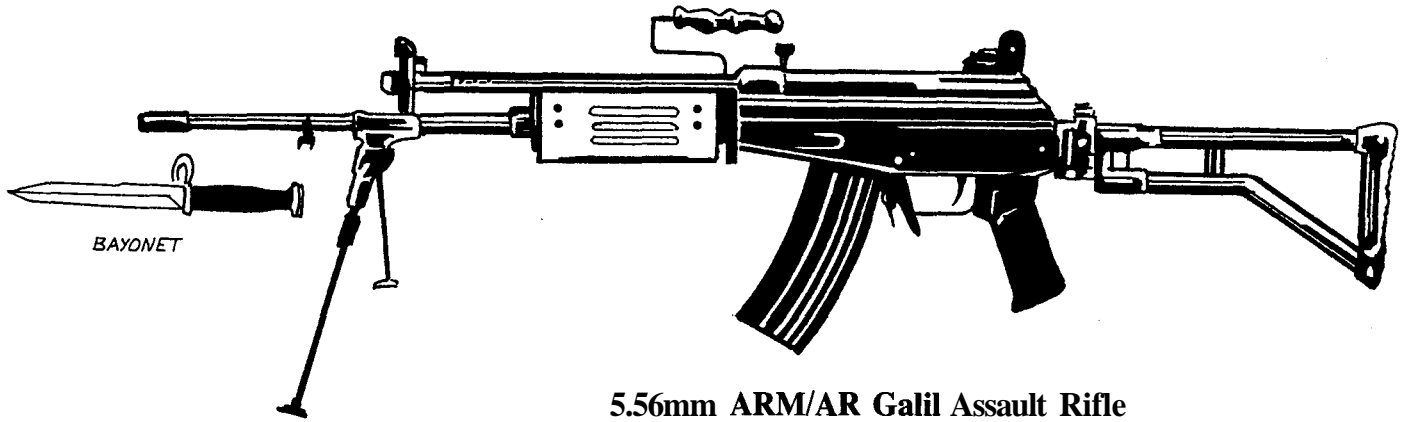

**5.56mm ARM/AR Galil Assault Rifle**

**Cartridge:** 5.56mm, **Damage:** 3D6, **P.V.:** 4, **Feed:** 35 or 50 round box mag., **Weight:** 3.9 kg, **Barrel Length:** 460mm (979m), **Muzzle Velocity:** 980 m/s, **Rate of Fire:** 650 rounds/min., **Approx. Effective Range:** 500 m (1640 ft).

**5.56mm SAR Galil Assault Rifle**

**Cartridge:** 5.56mm, **Damage:** 3D6, **P.V.:** 4, **Feed:** 35 or 50 round box mag., **Weight:** 3.65 kg, **Barrel Length:** 332mm (851mm), **Muzzle Velocity:** 920 m/s, **Rate of Fire:** 650 rounds/min., **Approx. Effective Range:** 400 m (1312 ft).

**7.62mm ARM/AR Galil Assault Rifle**

**Cartridge:** 7.62mm NATO, **Damage:** 5D6, **P.V.:** 6, **Feed:** 25 round box mag., **Weight:** 3.95 kg, **Barrel Length:** 533mm (1050mm), **Muzzle Velocity:** 850m/s, **Rate of Fire:** 650 rounds/min., **Approx. Effective Range:** 600 m (1969 ft).

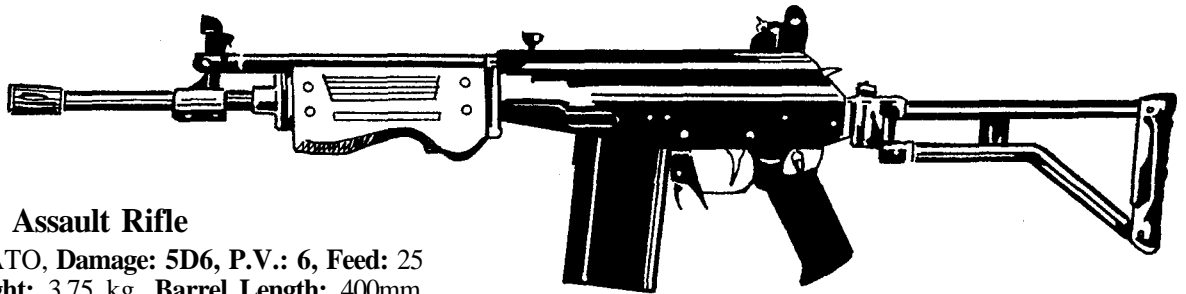

**7.62mm SAR Galil Assault Rifle**

**Cartridge:** 7.62mm NATO, **Damage:** 5D6, **P.V.:** 6, **Feed:** 25 round box mag., **Weight:** 3.75 kg, **Barrel Length:** 400mm (915mm), **Muzzle Velocity:** 800 m/s, **Rate of Fire:** 750 rounds/min., **Approx. Effective Range:** 550 m (1804 ft).

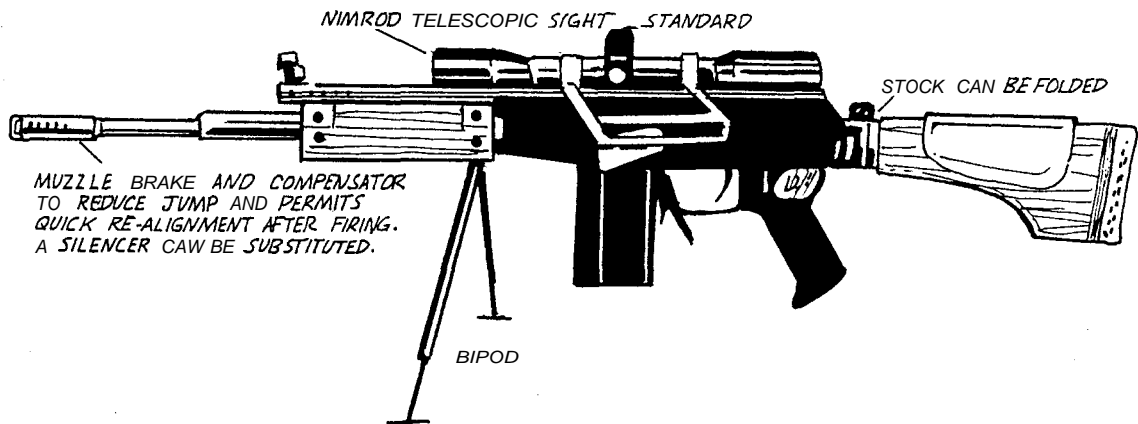

**7.62mm Galil Sniping Rifle**

**Cartridge:** 7.62mm x 51 NATO, **Damage:** 5D6, **P.V.:** 5, **Feed:** 20 round box mag., **Weight:** 6.4 kg, **Barrel Length:** 508mm (840mm), **Muzzle Velocity:** 815 m/s, **Approx. Effective Range:** 500 m (1640 ft).

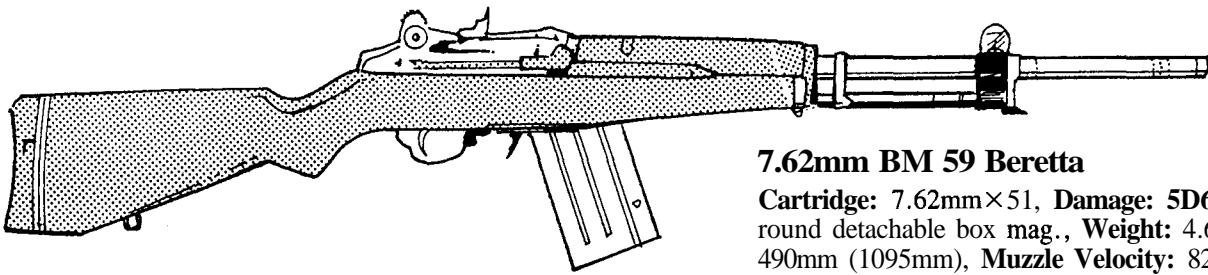

**7.62mm BM 59 Beretta**

**Cartridge:** 7.62mm×51, **Damage:** 5D6, **P.V.:** 6, **Feed:** 20 round detachable box mag., **Weight:** 4.6 kg, **Barrel Length:** 490mm (1095mm), **Muzzle Velocity:** 823 m/s, **Rate of Fire:** (cyclic) 750 rounds/min., **Approx. Effective Range:** 600 m (1969 ft).

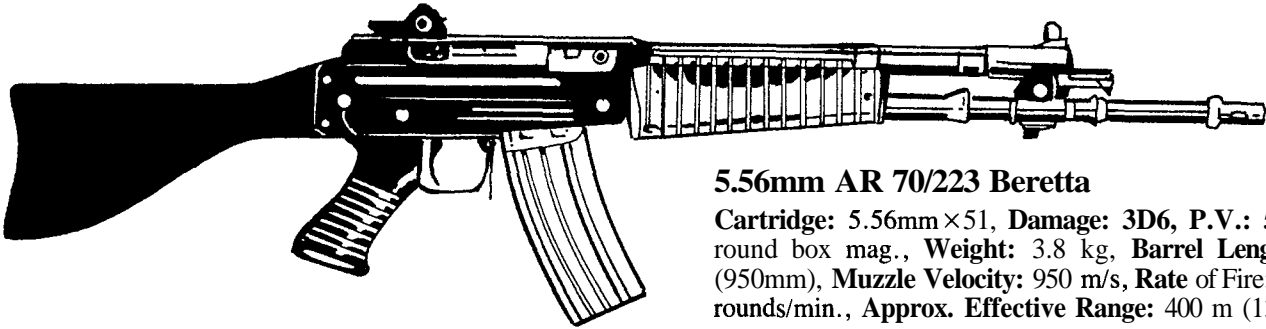

**5.56mm AR 70/223 Beretta**

**Cartridge:** 5.56mm×51, **Damage:** 3D6, **P.V.:** 5, **Feed:** 30 round box mag., **Weight:** 3.8 kg, **Barrel Length:** 450mm (950mm), **Muzzle Velocity:** 950 m/s, **Rate of Fire:**(cyclic) 650 rounds/min., **Approx. Effective Range:** 400 m (1312 ft).

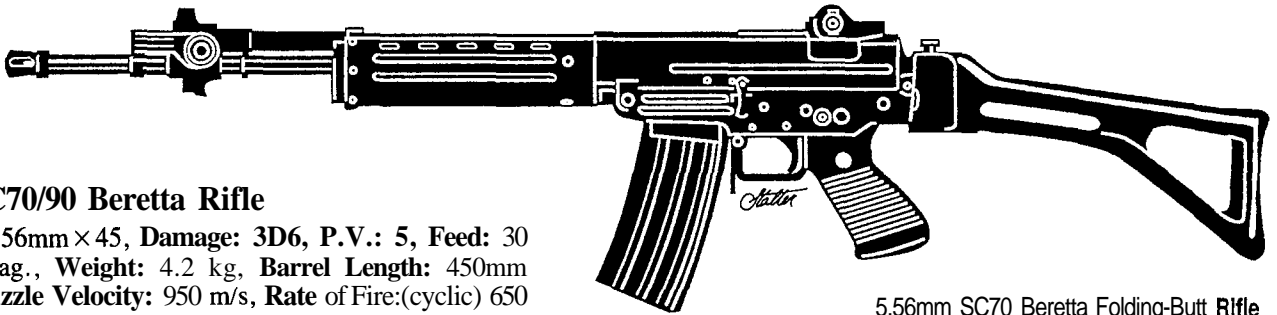

**5.56mm SC70/90 Beretta Rifle**

**Cartridge:** 5.56mm×45, **Damage:** 3D6, **P.V.:** 5, **Feed:** 30 round box mag., **Weight:** 4.2 kg, **Barrel Length:** 450mm (960mm), **Muzzle Velocity:** 950 m/s, **Rate of Fire:**(cyclic) 650 rounds/min., **Approx. Effective Range:** 750 m (2461 ft).

5.56mm SC70 Beretta Folding-Butt Rifle

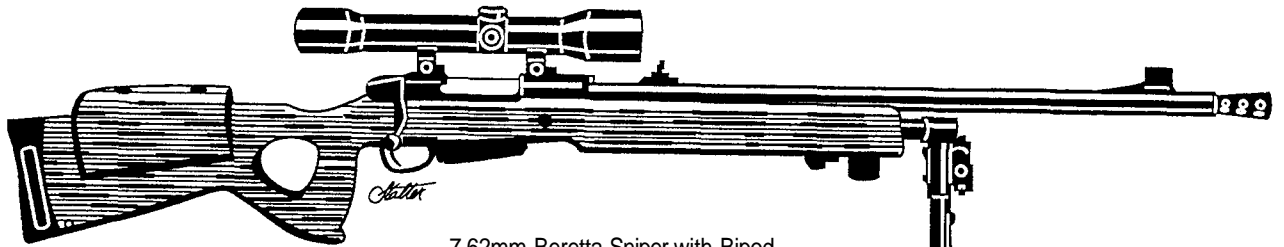

7.62mm Beretta Sniper with Bipod

**7.62mm Beretta Sniper Rifle**

**Cartridge:** 7.62mm x 51 NATO, **Damage:** 5D6, **P.V.:** 6, **Feed:** 5 round box mag., **Weight:** 5.55 kg, **Barrel Length:** 586mm (1165mm), **Muzzle Velocity:** 840 m/s, **Approx. Effective Range:** 600 m (1969 ft).

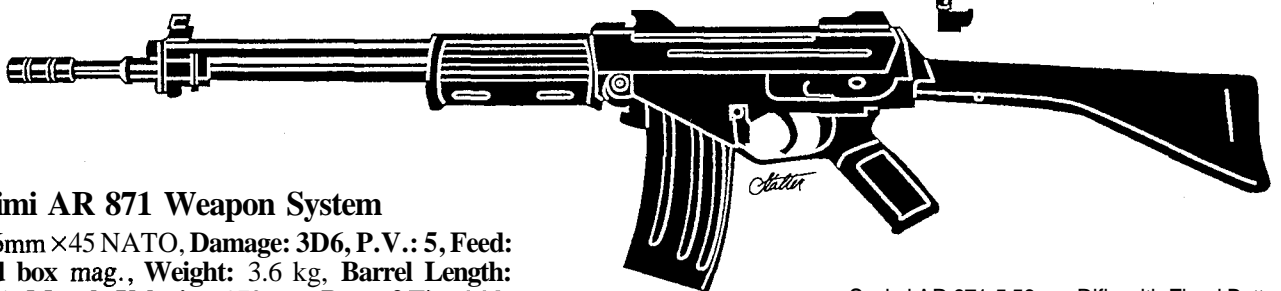

Socimi AR 871 5.56mm Rifle with Fixed Butt

**5.56mm Socimi AR 871 Weapon System**

**Cartridge:** 5.56mm×45 NATO, **Damage:** 3D6, **P.V.:** 5, **Feed:** 20 or 30 round box mag., **Weight:** 3.6 kg, **Barrel Length:** 450mm (970mm), **Muzzle Velocity:** 970 m/s, **Rate of Fire:**700-750 rounds/min., **Approx. Effective Range:** 600 m (1969 ft).



## JAPAN

---

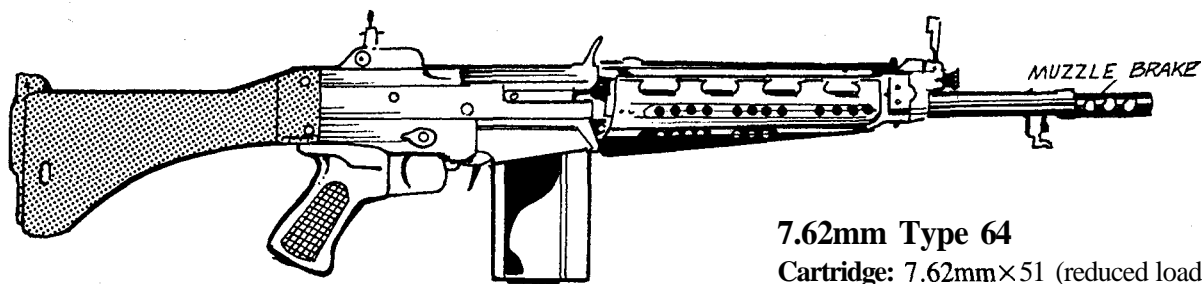

### 7.62mm Type 64

**Cartridge:** 7.62mm×51 (reduced load), **Damage:** 5D6, **P.V.:** 6, **Feed:** 20 round detachable box mag., **Weight:** 4.4 kg, **Barrel Length:** 450mm (990mm), **Muzzle Velocity:** 700 m/s, **Rate of Fire:** (cyclic) 500 rounds/min., **Approx. Effective Range:** 400 m (1312 ft).

## SINGAPORE

---

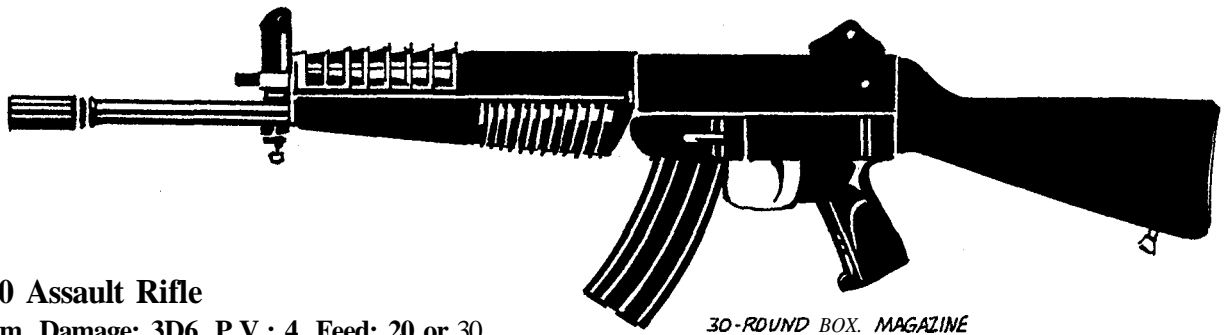

### 5.56mm SAR80 Assault Rifle

**Cartridge:** 5.56mm, **Damage:** 3D6, **P.V.:** 4, **Feed:** 20 or 30 round mag., **Weight:** 3.7 kg, **Barrel Length:** 459mm (970mm), **Muzzle Velocity:** 970 m/s, **Rate of Fire:** (cyclic) 600-800 rounds/min., **Approx. Effective Range:** 400 m (1312 ft).

## SOUTH AFRICA

---

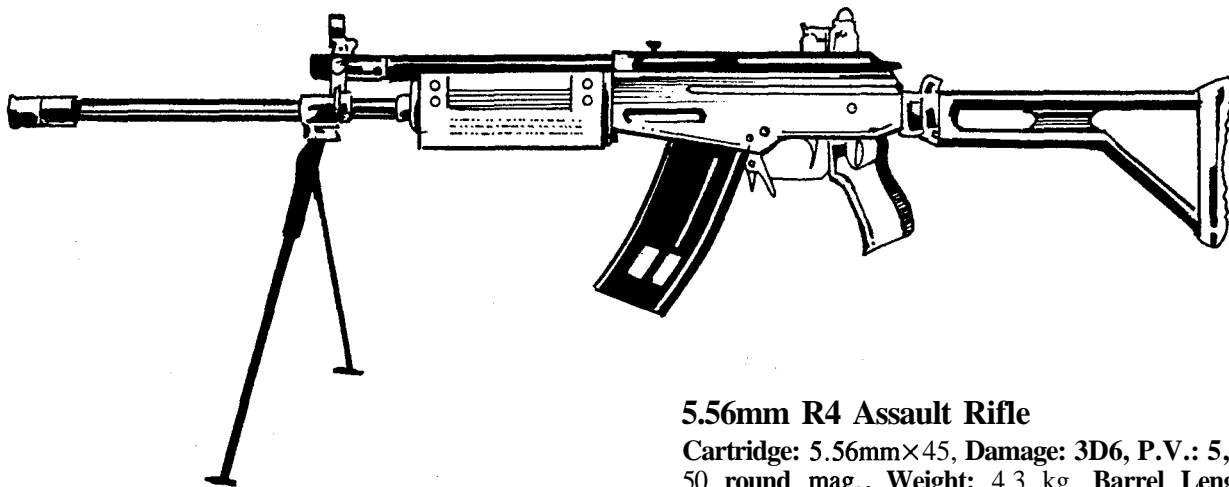

### 5.56mm R4 Assault Rifle

**Cartridge:** 5.56mm×45, **Damage:** 3D6, **P.V.:** 5, **Feed:** 35 or 50 round mag., **Weight:** 4.3 kg, **Barrel Length:** 460mm (1005mm), **Muzzle Velocity:** 980 m/s, **Rate of Fire:** (cyclic) 650 rounds/min., **Approx. Effective Range:** 400 m (1312 ft).

## SPAIN

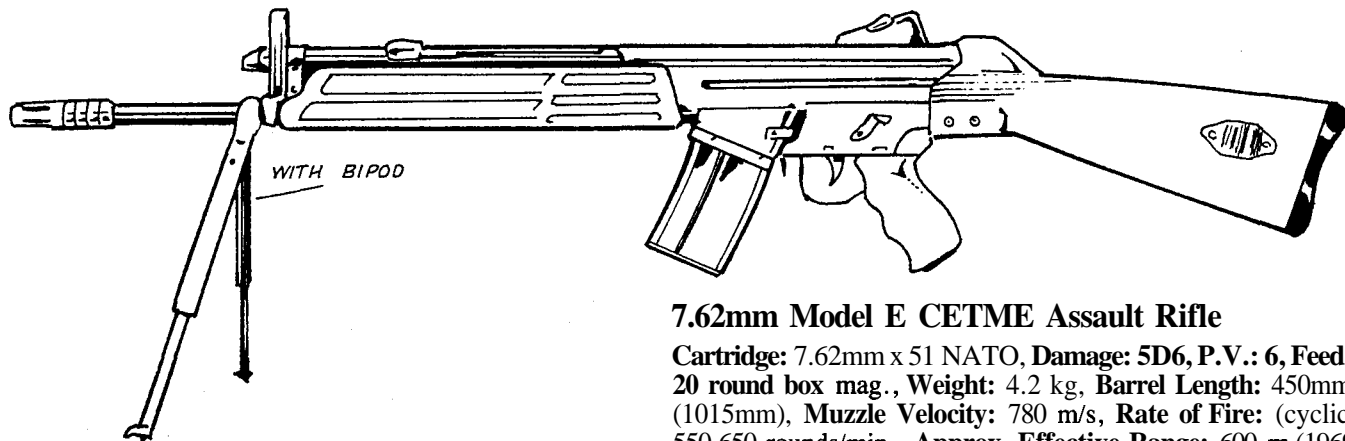

### 7.62mm Model E CETME Assault Rifle

**Cartridge:** 7.62mm x 51 NATO, **Damage:** 5D6, **P.V.:** 6, **Feed:** 20 round box mag., **Weight:** 4.2 kg, **Barrel Length:** 450mm (1015mm), **Muzzle Velocity:** 780 m/s, **Rate of Fire:** (cyclic) 550-650 rounds/min., **Approx. Effective Range:** 600 m (1969 ft).

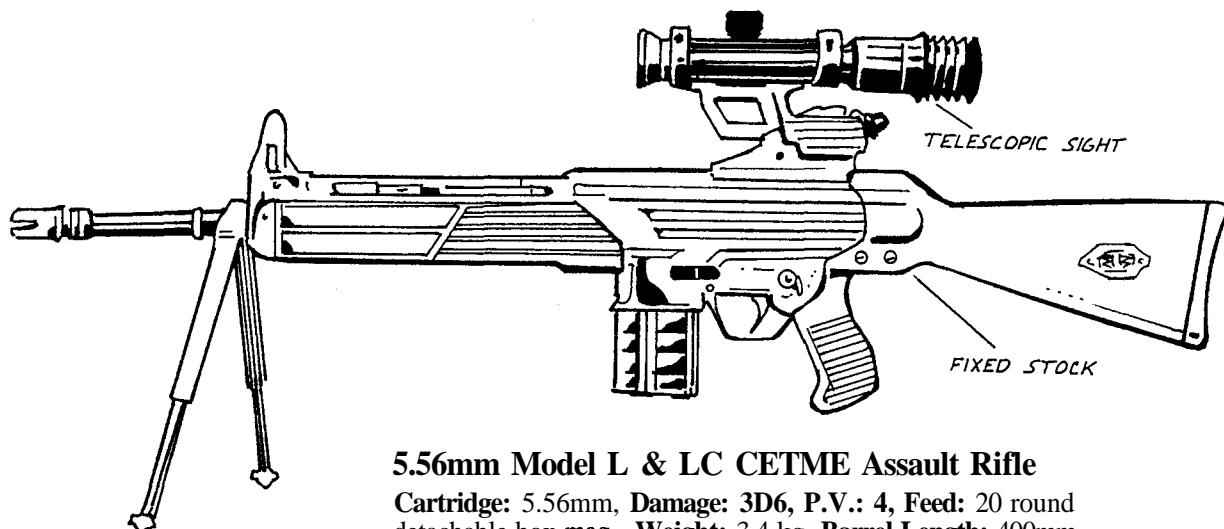

### 5.56mm Model L & LC CETME Assault Rifle

**Cartridge:** 5.56mm, **Damage:** 3D6, **P.V.:** 4, **Feed:** 20 round detachable box mag., **Weight:** 3.4 kg, **Barrel Length:** 400mm (925mm), **Muzzle Velocity:** 920 m/s, **Rate of Fire:** (cyclic) 700-800 rounds/min., **Approx. Effective Range:** 400 m (1312 ft).

## SWEDEN

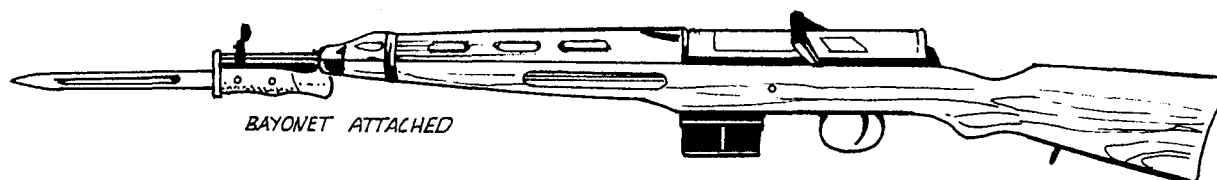

### 6.5mm AG42 (Ljungman) Rifle

**Cartridge:** 6.5mm x 55, **Damage:** 3D6, **P.V.:** 3, **Feed:** 10 round nondetachable box mag., **Weight:** 4.71 kg, **Barrel Length:** 214mm (622mm), **Muzzle Velocity:** 750 m/s, **Approx. Effective Range:** 500 m (1640 ft).

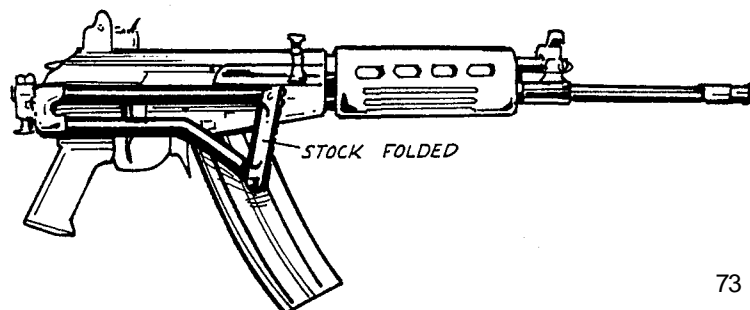

### 5.56mm 890C FFV Assault Rifle

**Cartridge:** 5.56mm x 45 (new design), **Damage:** 3D6, **P.V.:** 4, **Feed:** 35 round box mag., **Weight:** 3.5 kg, **Barrel Length:** 340mm (860mm), **Muzzle Velocity:** 860 m/s, **Rate of Fire:** (cyclic) 650 rounds/min., **Approx. Effective Range:** 400 m (1312 ft).

## SWITZERLAND

---

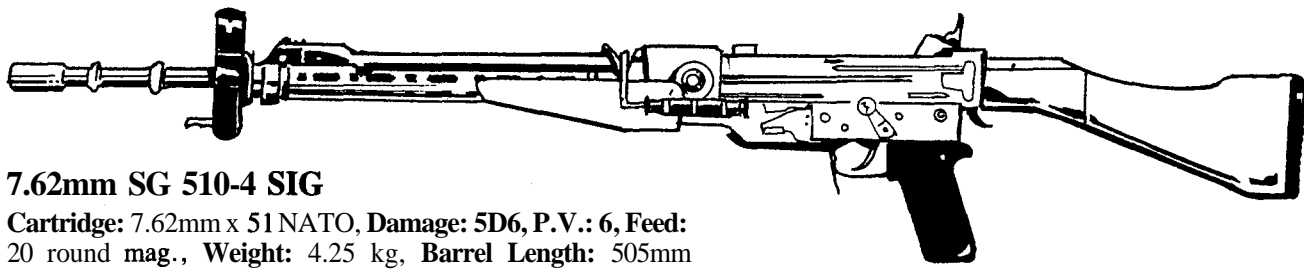

### 7.62mm SG 510-4 SIG

**Cartridge:** 7.62mm x 51 NATO, **Damage:** 5D6, **P.V.:** 6, **Feed:** 20 round mag., **Weight:** 4.25 kg, **Barrel Length:** 505mm (1016mm), **Muzzle Velocity:** 790 m/s, **Rate of Fire:** (cyclic) 600 rounds/min., **Approx. Effective Range:** 400 m (1312 ft).

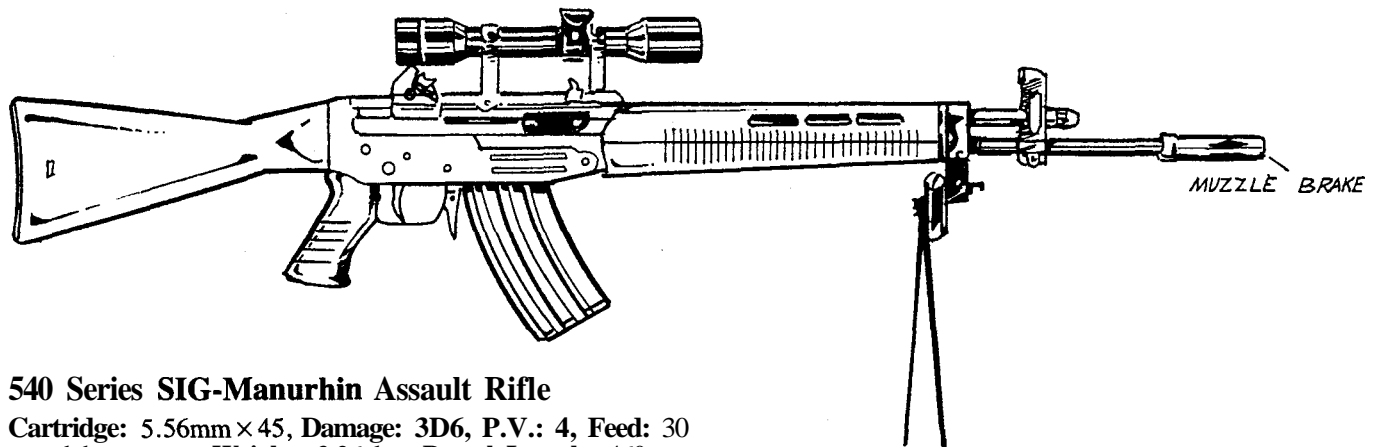

### 540 Series SIG-Manurhin Assault Rifle

**Cartridge:** 5.56mm x 45, **Damage:** 3D6, **P.V.:** 4, **Feed:** 30 round box mag., **Weight:** 3.26 kg, **Barrel Length:** 460mm (950mm), **Muzzle Velocity:** 980 m/s, **Rate of Fire:** (cyclic) 650 rounds/min., **Approx. Effective Range:** 600 m (1969 ft).

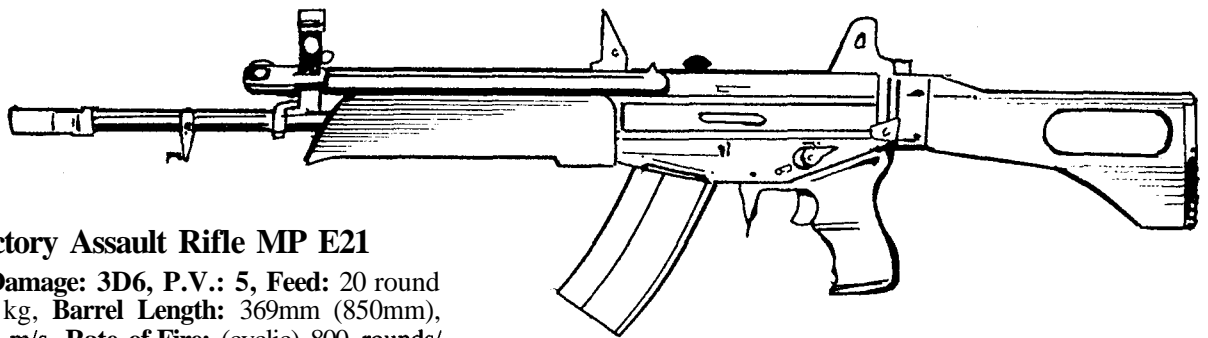

### Federal Arms Factory Assault Rifle MP E21

**Cartridge:** 6.45mm, **Damage:** 3D6, **P.V.:** 5, **Feed:** 20 round mag., **Weight:** 3.91 kg, **Barrel Length:** 369mm (850mm), **Muzzle Velocity:** 770 m/s, **Rate of Fire:** (cyclic) 800 rounds/min., **Approx. Effective Range:** 500 m (1640 ft).

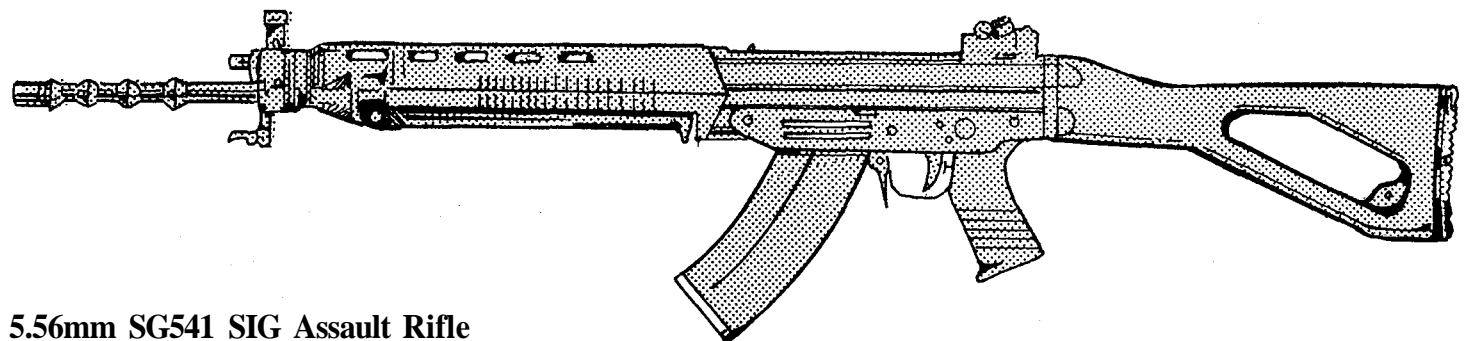

### 5.56mm SG541 SIG Assault Rifle

**Cartridge:** 5.56mm, **Damage:** 3D6, **P.V.:** 4, **Feed:** 32 round mag., **Weight:** 3.75 kg, **Barrel Length:** 540mm (1000mm), **Muzzle Velocity:** 780 m/s, **Rate of Fire:** (cyclic) 700-800 rounds/min., **Approx. Effective Range:** 500 m (1640 ft).

# TAIWAN

## 5.56mm Type 65 Assault Rifle

**Cartridge:** 5.56mm×45 M193, **Damage:** 3D6, **P.V.:** 5, **Feed:** 20 or 30 round detachable box mag., **Weight:** 3.17kg, **Barrel Length:** 508mm (990mm), **Muzzle Velocity:** 690 m/s, **Rate of Fire:** (cyclic) 700-800 rounds/min., **Approx. Effective Range:** 400 m (1312 ft).

## The Old U.S.S.R.

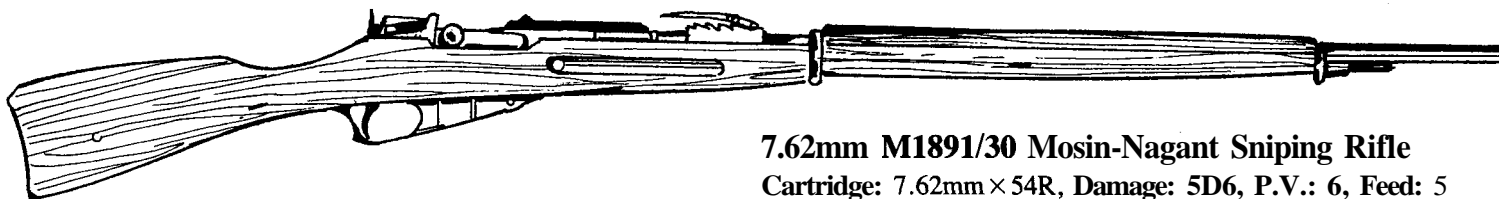

### 7.62mm M1891/30 Mosin-Nagant Sniping Rifle

**Cartridge:** 7.62mm×54R, **Damage:** 5D6, **P.V.:** 6, **Feed:** 5 round internal box mag., **Weight:** 5.05 kg, **Barrel Length:** 720mm (1232mm), **Muzzle Velocity:** 811 m/s, **Approx. Effective Range:** 800 m (2625 ft).

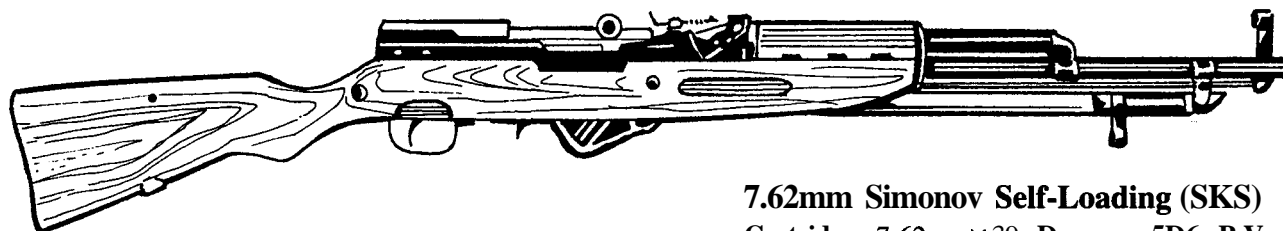

### 7.62mm Simonov Self-Loading (SKS)

**Cartridge:** 7.62mm×39, **Damage:** 5D6, **P.V.:** 6, **Feed:** 10 round detachable box mag., **Weight:** 3.85 kg, **Barrel Length:** 550mm (1021mm), **Muzzle Velocity:** 735 m/s, **Approx. Effective Range:** 400 m (1312 ft).



BAYONET



CHINESE TYPE BAYONET

### 7.62mm AK-47 (East German Version)

**Cartridge:** 7.62mm×39, **Damage:** 5D6, **P.V.:** 6, **Feed:** 30 round detachable box mag., **Weight:** 4.3 kg, **Barrel Length:** 414mm (869mm), **Muzzle Velocity:** 710 m/s, **Rate of Fire:** (cyclic) 600 rounds/min., **Approx. Effective Range:** 300 m (984 ft).

### 7.62mm AKM Assault Rifle

**Cartridge:** 7.62mm×39, **Damage:** 3D6, **P.V.:** 5, **Feed:** 30 round detachable box mag., **Weight:** 3.15 kg, **Barrel Length:** 414mm (876mm), **Muzzle Velocity:** 715 m/s, **Rate of Fire:** (cyclic) 600 rounds/min., **Approx. Effective Range:** 300 m (984 ft).

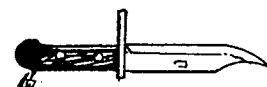

BAYONET ATTACHMENT

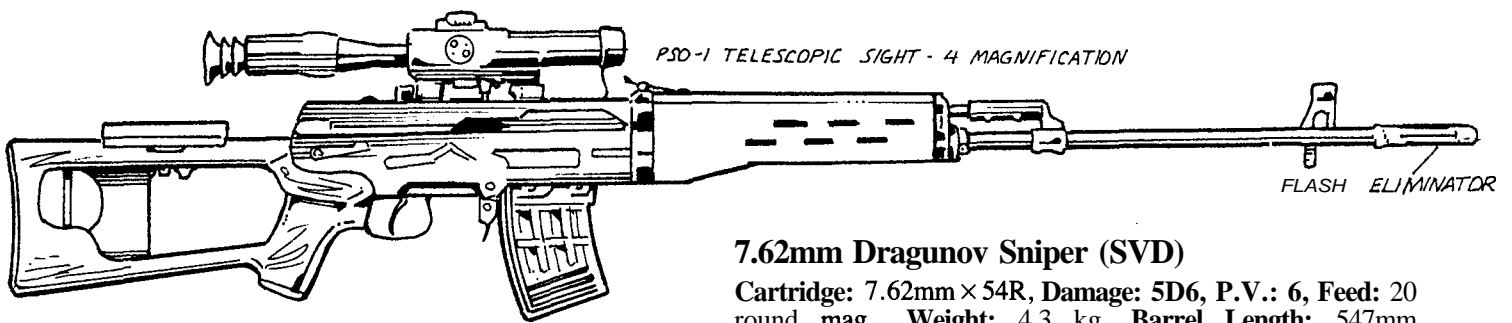

### 7.62mm Dragunov Sniper (SVD)

Cartridge: 7.62mm × 54R, Damage: 5D6, P.V.: 6, Feed: 20 round mag., Weight: 4.3 kg, Barrel Length: 547mm (1225mm), Muzzle Velocity: 830 m/s, Approx. Effective Range: 1300 m (4265 ft).

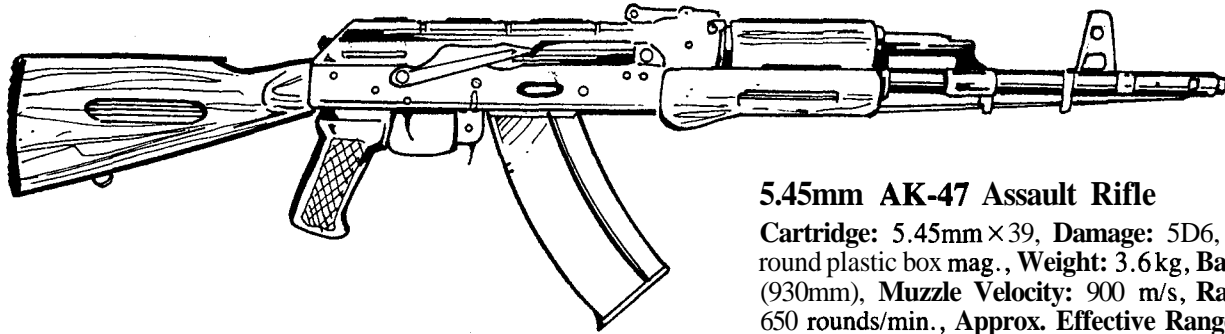

### 5.45mm AK-47 Assault Rifle

Cartridge: 5.45mm × 39, Damage: 5D6, P.V.: 6, Feed: 30 round plastic box mag., Weight: 3.6 kg, Barrel Length: 400mm (930mm), Muzzle Velocity: 900 m/s, Rate of Fire: (cyclic) 650 rounds/min., Approx. Effective Range: 500 m (1640 ft).

## UNITED KINGDOM

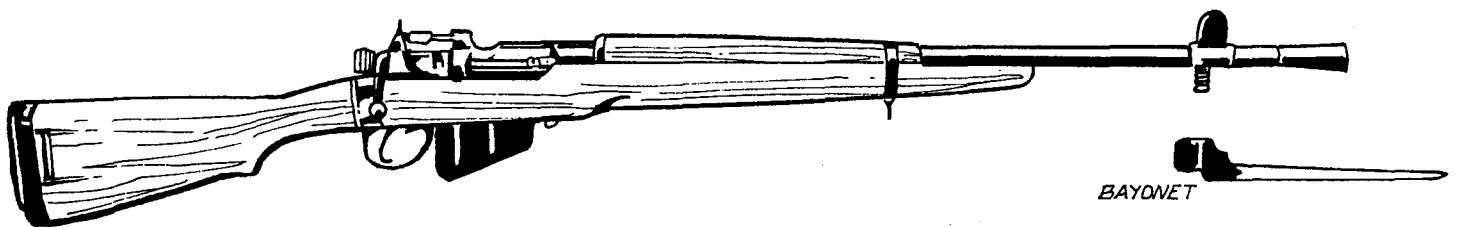

### .303 Lee-Enfield

Cartridge: .303 MK VII ball type, Damage: 4D6, P.V.: 5, Feed: 10 round detachable box mag., Weight: 4.5 kg, Barrel Length: 550mm (1130mm), Muzzle Velocity: 751 m/s, Rate of Fire: up to 20 rounds/min., Approx. Effective Range: 500 m (1640 ft).

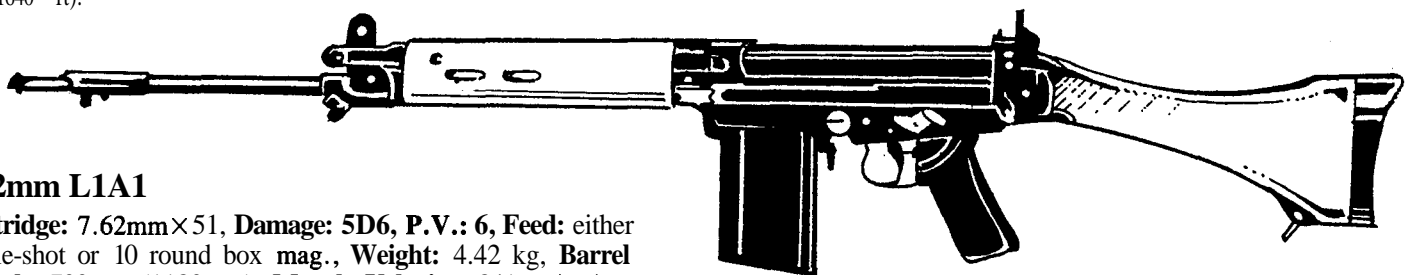

### 7.62mm L1A1

Cartridge: 7.62mm × 51, Damage: 5D6, P.V.: 6, Feed: either single-shot or 10 round box mag., Weight: 4.42 kg, Barrel Length: 700mm (1180mm), Muzzle Velocity: 841 m/s, Approx. Effective Range: 500 m (1640 ft).

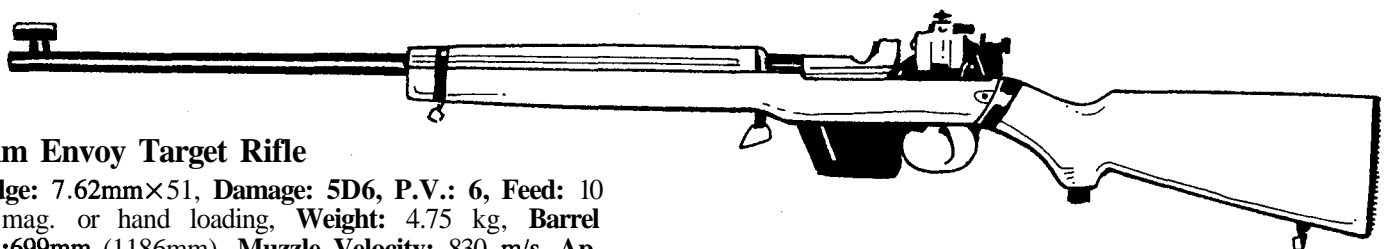

### 7.62mm Envoy Target Rifle

Cartridge: 7.62mm × 51, Damage: 5D6, P.V.: 6, Feed: 10 round mag. or hand loading, Weight: 4.75 kg, Barrel Length: 699mm (1186mm), Muzzle Velocity: 830 m/s, Approx. Effective Range: 400 m (1312 ft).

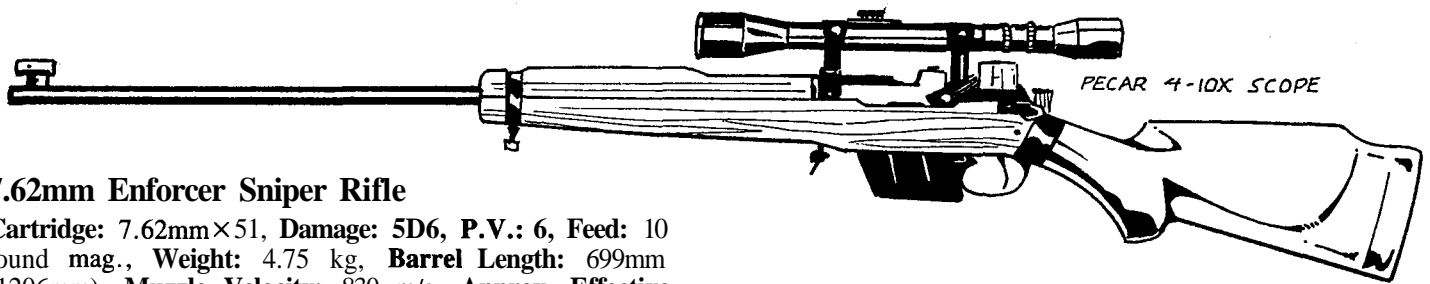

PECAR 4-10X SCOPE

### 7.62mm Enforcer Sniper Rifle

**Cartridge:** 7.62mm×51, **Damage:** 5D6, **P.V.:** 6, **Feed:** 10 round mag., **Weight:** 4.75 kg, **Barrel Length:** 699mm (1206mm), **Muzzle Velocity:** 830 m/s, **Approx. Effective Range:** 300 m (984 ft).

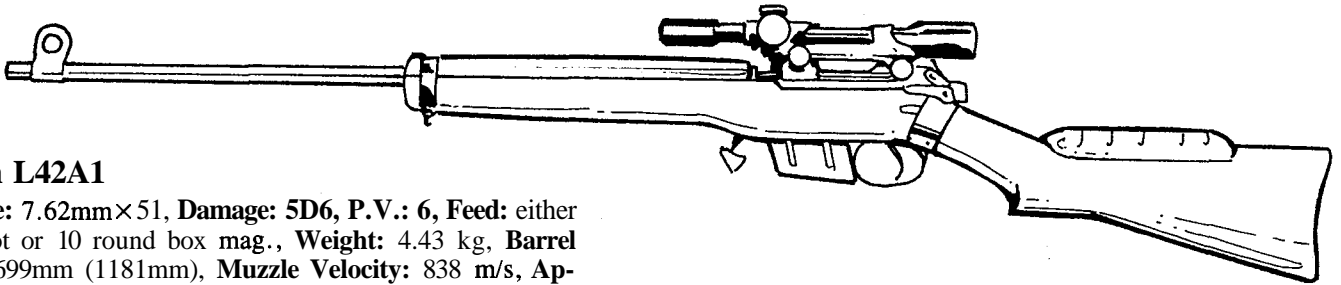

### 7.62mm L42A1

**Cartridge:** 7.62mm×51, **Damage:** 5D6, **P.V.:** 6, **Feed:** either single-shot or 10 round box mag., **Weight:** 4.43 kg, **Barrel Length:** 699mm (1181mm), **Muzzle Velocity:** 838 m/s, **Approx. Effective Range:** 400 m (1312 ft).

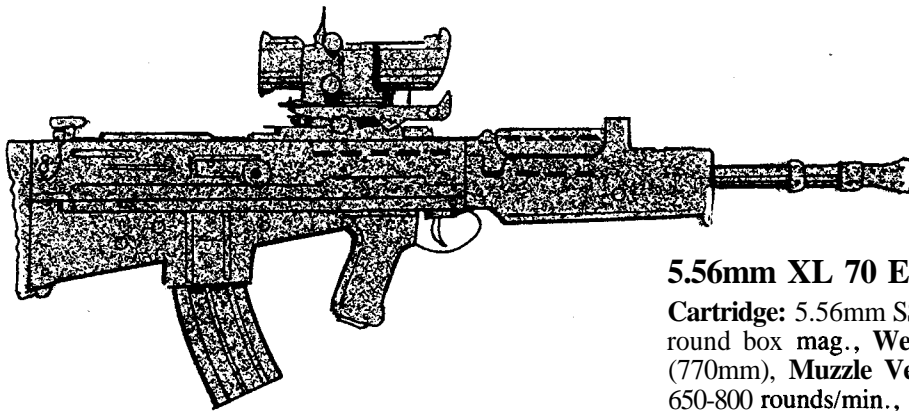

### 5.56mm XL 70 E3 Enfield

**Cartridge:** 5.56mm SS 109, **Damage:** 3D6, **P.V.:** 5, **Feed:** 30 round box mag., **Weight:** 3.12 kg, **Barrel Length:** 518mm (770mm), **Muzzle Velocity:** 950 m/s, **Rate of Fire:** (cyclic) 650-800 rounds/min., **Approx. Effective Range:** 600 m (1969 ft).

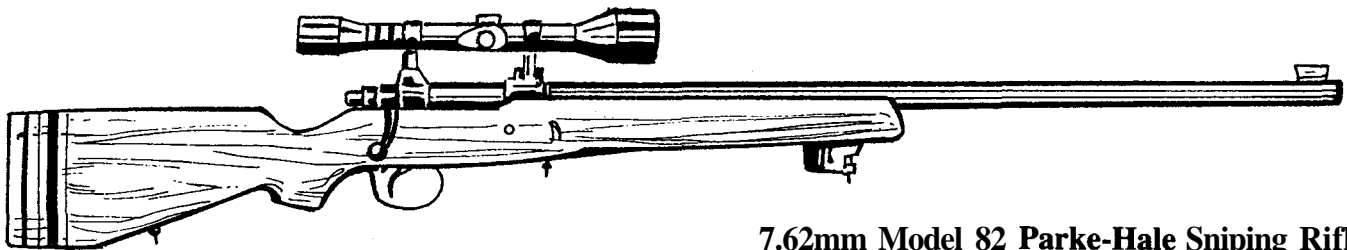

### 7.62mm Model 82 Parke-Hale Sniping Rifle

**Cartridge:** 7.62mm×51, **Damage:** 5D6, **P.V.:** 6, **Feed:** 20 round box mag., **Weight:** 4.8 kg, **Barrel Length:** 660mm (1162mm), **Muzzle Velocity:** 838 m/s, **Approx. Effective Range:** 660 m (2165 ft).

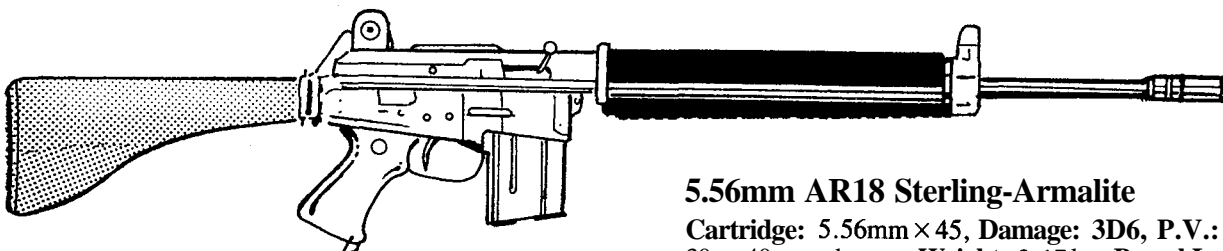

### 5.56mm AR18 Sterling-Armalite

**Cartridge:** 5.56mm×45, **Damage:** 3D6, **P.V.:** 5, **Feed:** 20, 30 or 40 round mag., **Weight:** 3.17kg, **Barrel Length:** 464mm (940mm), **Muzzle Velocity:** 1000 m/s, **Rate of Fire:** (cyclic) 800 rounds/min., **Approx. Effective Range:** 460 m (1509 ft).

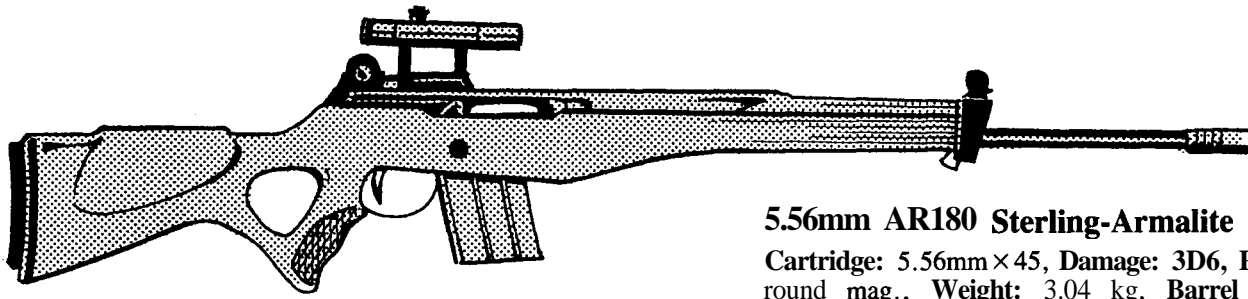

**5.56mm AR180 Sterling-ARmalite**

**Cartridge:** 5.56mm×45, **Damage:** 3D6, **P.V.:** 5, **Feed:** 20 round mag., **Weight:** 3.04 kg, **Barrel Length:** 476mm (965mm), **Muzzle Velocity:** 900 m/s, **Approx. Effective Range:** 400 m (1312 ft).

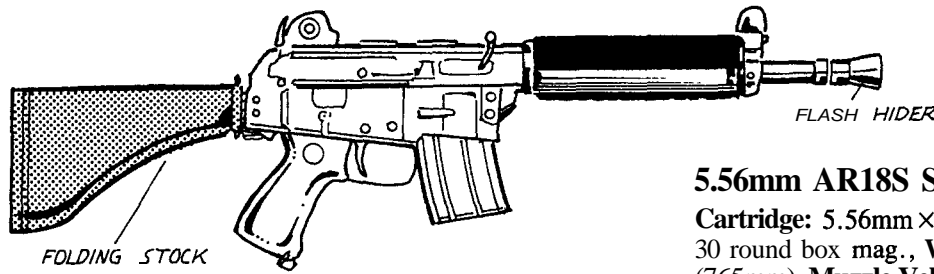

**5.56mm AR18S Sterling-ARmalite**

**Cartridge:** 5.56mm×45, **Damage:** 3D6, **P.V.:** 5, **Feed:** 20 or 30 round box mag., **Weight:** 3.1 kg, **Barrel Length:** 257mm (765mm), **Muzzle Velocity:** 780-830 m/s, **Rate of Fire:** (cyclic) 800 rounds/min., **Approx. Effective Range:** 330 m (1083 ft).

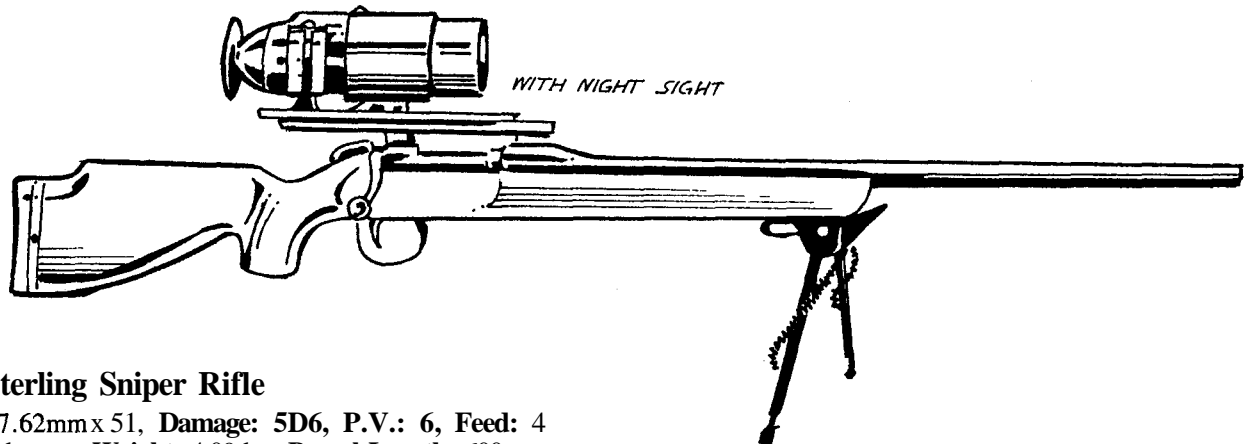

**7.62mm Sterling Sniper Rifle**

**Cartridge:** 7.62mm×51, **Damage:** 5D6, **P.V.:** 6, **Feed:** 4 round integral mag., **Weight:** 4.09 kg, **Barrel Length:** 600mm (1128mm), **Muzzle Velocity:** 830 m/s, **Approx. Effective Range:** 400 m (1312 ft).

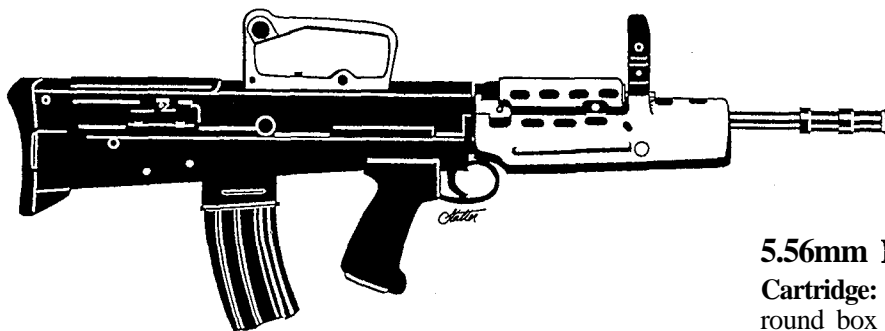

**5.56mm Enfield L-85-A1 (Individual Weapon)**

**Cartridge:** 5.56mm NATO, **Damage:** 3D6, **P.V.:** 5, **Feed:** 30 round box mag., **Weight:** 4.98 kg, **Barrel Length:** 518mm (785mm), **Muzzle Velocity:** 940 m/s, **Rate of Fire:** (cyclic) 650-800 rounds/min., **Approx. Effective Range:** 550 m (1804 ft).

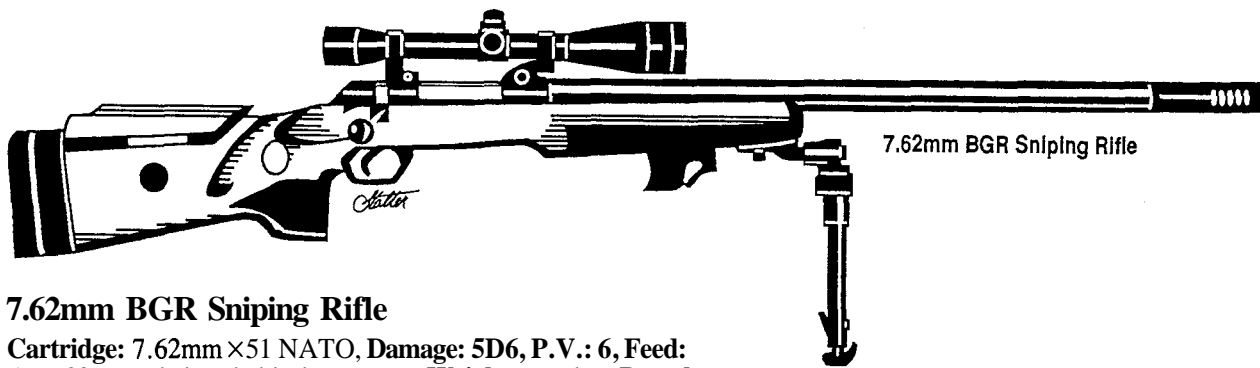

7.62mm BGR Sniping Rifle

### 7.62mm BGR Sniping Rifle

**Cartridge:** 7.62mm×51 NATO, **Damage:** 5D6, **P.V.:** 6, **Feed:** 5 to 20 round detachable box mag., **Weight:** 6.6 kg, **Barrel Length:** 700mm (1200mm), **Muzzle Velocity:** 950 m/s, **Approx. Effective Range:** 460 m (1509 ft).

## UNITED STATES

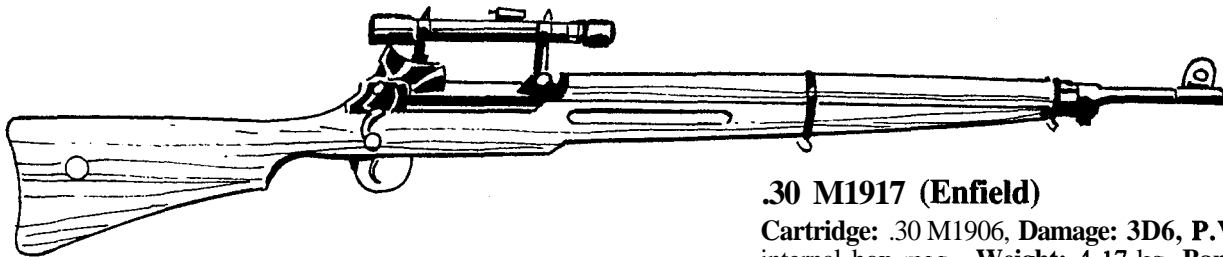

### .30 M1917 (Enfield)

**Cartridge:** .30 M1906, **Damage:** 3D6, **P.V.:** 4, **Feed:** 5 round internal box mag., **Weight:** 4.17 kg, **Barrel Length:** 660mm (1082mm), **Muzzle Velocity:** 862 m/s, **Approx. Effective Range:** 500 m (1640 ft).

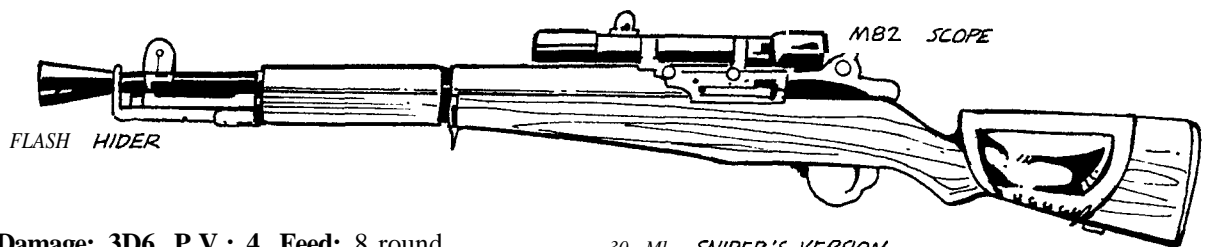

### .30 M1

**Cartridge:** .30 M2, **Damage:** 3D6, **P.V.:** 4, **Feed:** 8 round clip, **Weight:** 4.3 kg, **Barrel Length:** 610mm (1106mm), **Muzzle Velocity:** 865 m/s, **Rate of Fire:** 30 rounds/min., **Approx. Effective Range:** 600 m (1969 ft).

.30 M1 SNIPER'S VERSION

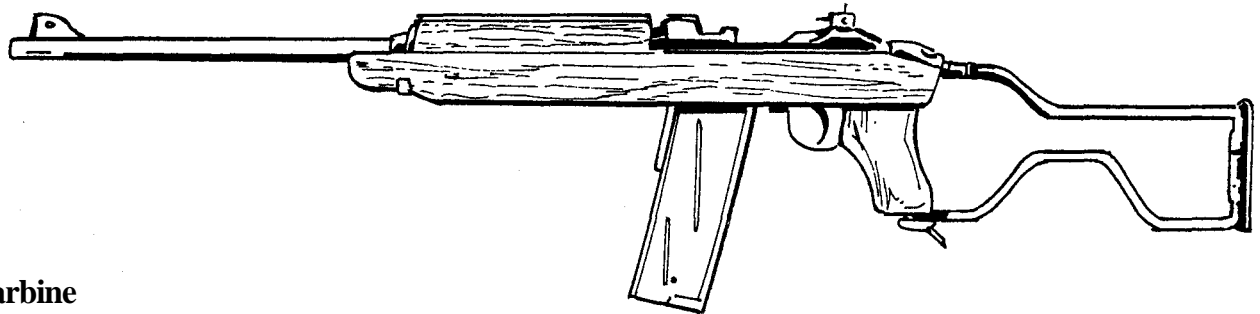

### .30 M1 Carbine

**Cartridge:** .30 M1, **Damage:** 3D6, **P.V.:** 4, **Feed:** 15 or 30 round mag., **Weight:** 2.26 kg, **Barrel Length:** 458mm (904mm), **Muzzle Velocity:** 607 m/s, **Rate of Fire:** (cyclic) 750 rounds/min., **Approx. Effective Range:** 300 m (984 ft).



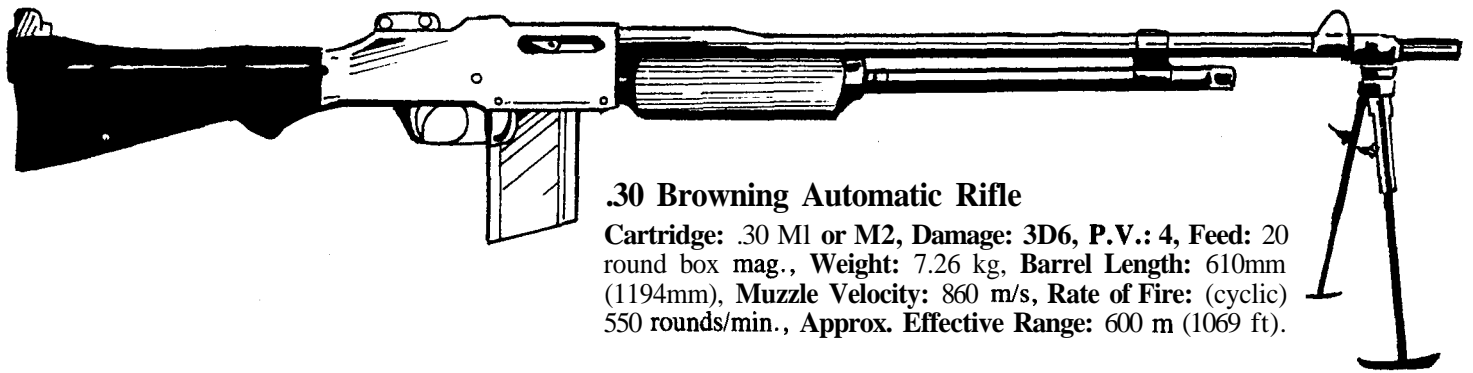

### **.30 Browning Automatic Rifle**

**Cartridge:** .30 M1 or M2, **Damage:** 3D6, **P.V.:** 4, **Feed:** 20 round box mag., **Weight:** 7.26 kg, **Barrel Length:** 610mm (1194mm), **Muzzle Velocity:** 860 m/s, **Rate of Fire:** (cyclic) 550 rounds/min., **Approx. Effective Range:** 600 m (1069 ft).

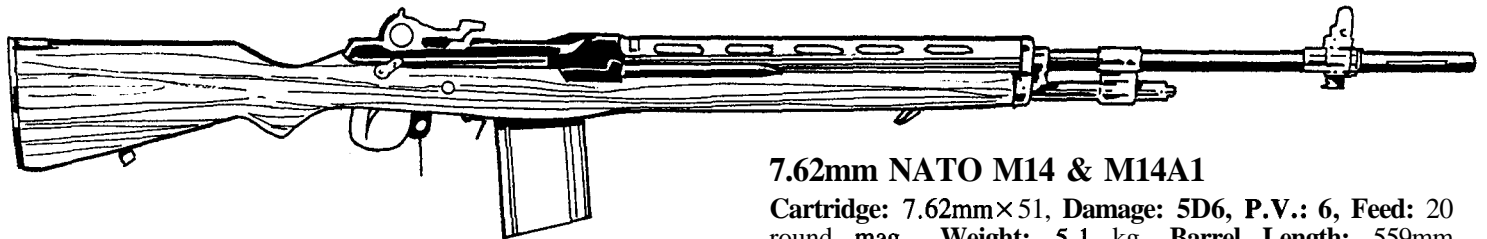

### **7.62mm NATO M14 & M14A1**

**Cartridge:** 7.62mm×51, **Damage:** 5D6, **P.V.:** 6, **Feed:** 20 round mag., **Weight:** 5.1 kg, **Barrel Length:** 559mm (1120mm), **Muzzle Velocity:** 853 m/s, **Rate of Fire:** (cyclic) 700-750 rounds/min., **Approx. Effective Range:** 460 m (1509 ft).

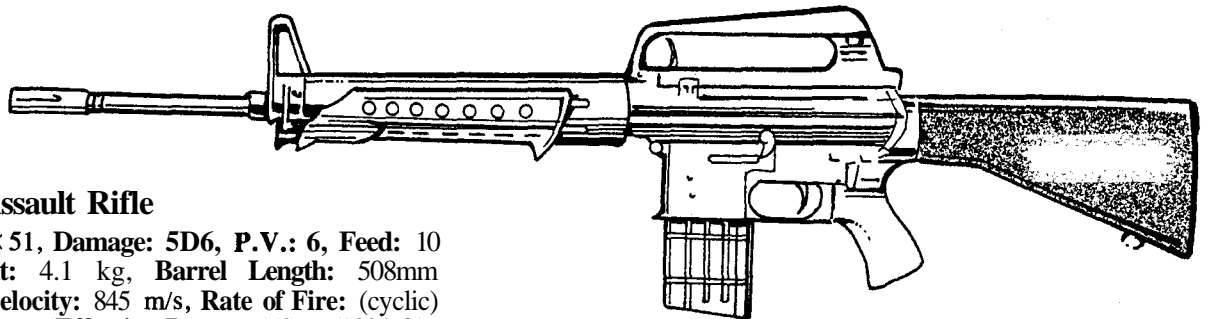

### **7.62mm AR-10 Assault Rifle**

**Cartridge:** 7.62mm×51, **Damage:** 5D6, **P.V.:** 6, **Feed:** 10 round mag., **Weight:** 4.1 kg, **Barrel Length:** 508mm (1029mm), **Muzzle Velocity:** 845 m/s, **Rate of Fire:** (cyclic) 700 rounds/min., **Approx. Effective Range:** 550 m (1804 ft).

*M16 ASSAULT RIFLE*

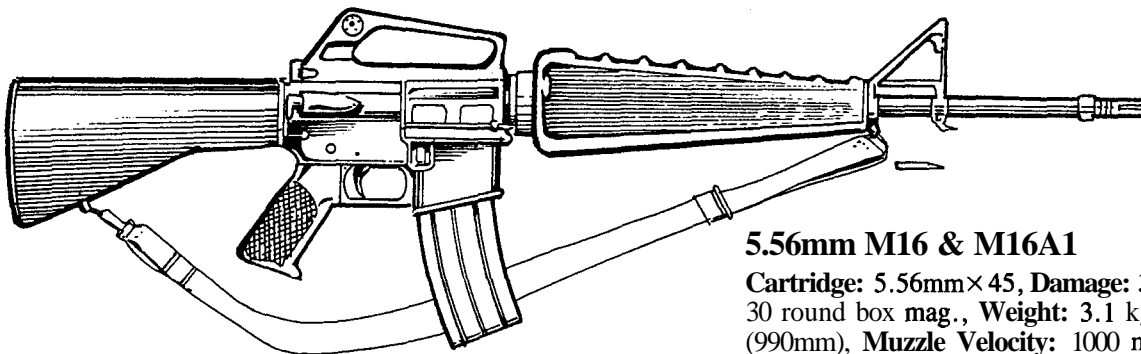

### **5.56mm M16 & M16A1**

**Cartridge:** 5.56mm×45, **Damage:** 3D6, **P.V.:** 5, **Feed:** 20 or 30 round box mag., **Weight:** 3.1 kg, **Barrel Length:** 508mm (990mm), **Muzzle Velocity:** 1000 m/s, **Rate of Fire:** (cyclic) 700-950 rounds/min., **Approx. Effective Range:** 400 m (1312 ft).

*M203 40mm SEMIAUTOMATIC GRENADE LAUNCHER MOUNTED ON A M16A1 RIFLE.*

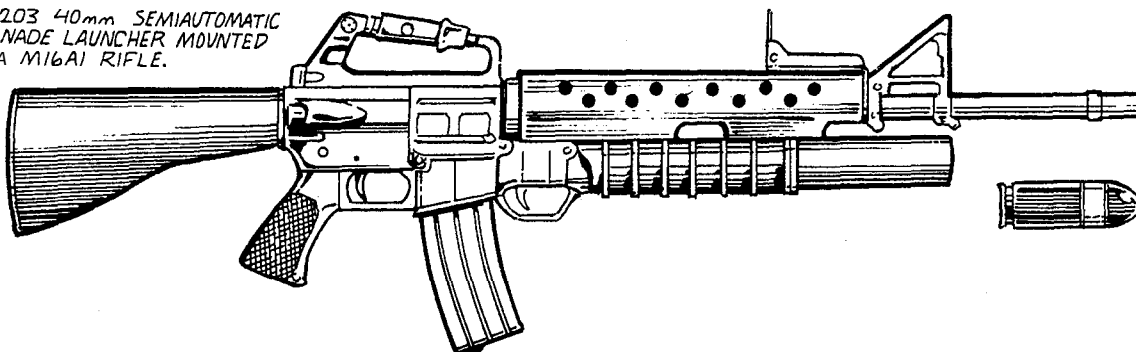

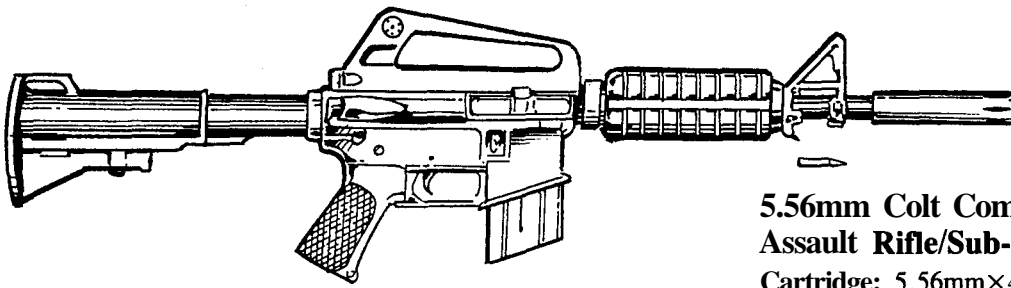

**5.56mm Colt Commando  
Assault Rifle/Sub-Machinegun**

**Cartridge:** 5.56mm×45, **Damage:** 3D6, **P.V.:** 5, **Feed:** 20 round mag., **Weight:** 2.78 kg, **Barrel Length:** 254mm (787mm), **Muzzle Velocity:** 924 m/s, **Rate of Fire:** (cyclic) 700-800 rounds/min., **Approx. Effective Range:** 200 m (656 ft).

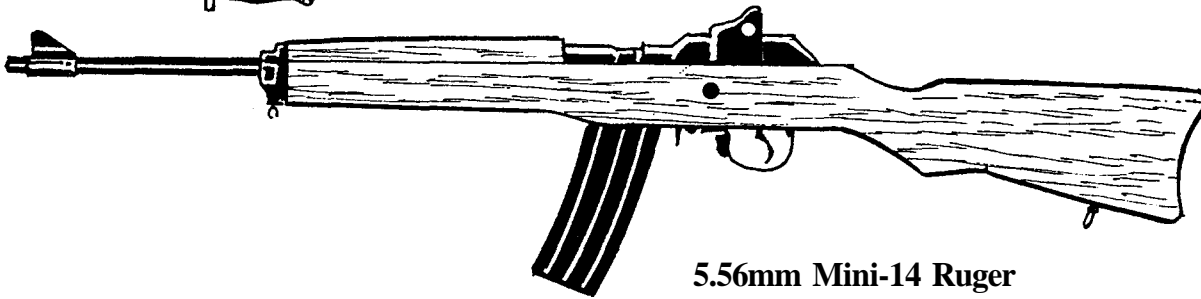
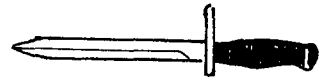

**5.56mm Mini-14 Ruger**

**Cartridge:** 5.56mm×45 M193, **Damage:** 3D6, **P.V.:** 5, **Feed:** 5, 10, 20 or 30 round box mag., **Weight:** 2.9kg, **Barrel Length:** 470mm (946mm), **Muzzle Velocity:** 1005 m/s, **Rate of Fire:** single shot — 40 rounds/min., **Approx. Effective Range:** 300 m (984 ft).

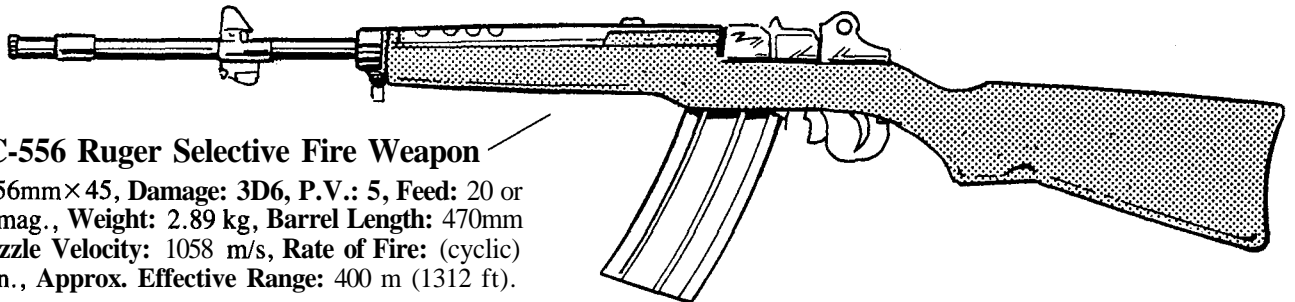

**5.56mm AC-556 Ruger Selective Fire Weapon**

**Cartridge:** 5.56mm×45, **Damage:** 3D6, **P.V.:** 5, **Feed:** 20 or 30 round box mag., **Weight:** 2.89 kg, **Barrel Length:** 470mm (984mm), **Muzzle Velocity:** 1058 m/s, **Rate of Fire:** (cyclic) 750 rounds/min., **Approx. Effective Range:** 400 m (1312 ft).

**5.56mm Hughes Lockless Rifle/Machine Gun**

**Cartridge:** 5.56mm, **Damage:** 3D6, **P.V.:** 5, **Feed:** 64 round mag. (reload time is 3 seconds), **Weight:** 4.45 kg, **Barrel Length:** 559mm (1016mm), **Muzzle Velocity:** 945 m/s, **Rate of Fire:** 420 rounds/min., **Approx. Effective Range:** 1200 m (3937 ft).

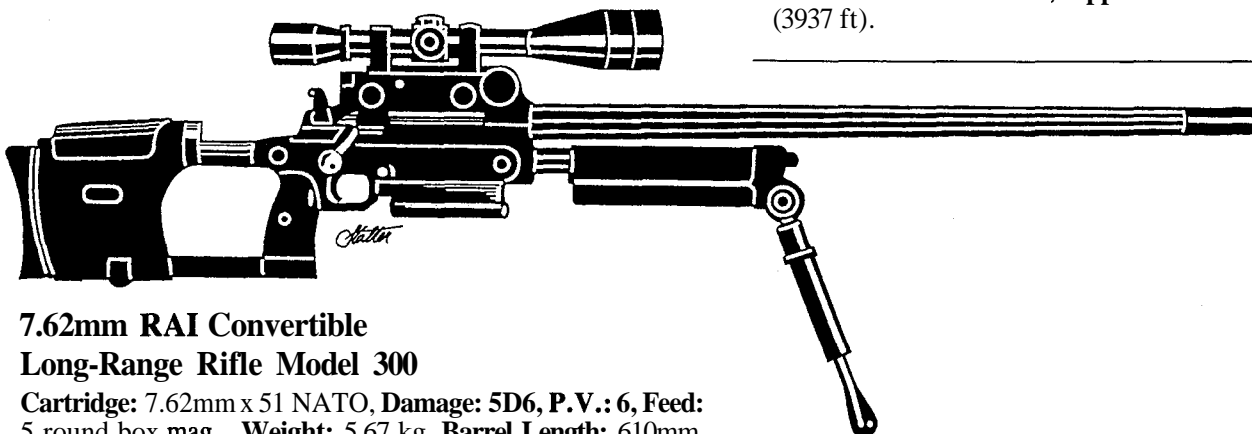

**7.62mm RAI Convertible  
Long-Range Rifle Model 300**

**Cartridge:** 7.62mm x 51 NATO, **Damage:** 5D6, **P.V.:** 6, **Feed:** 5 round box mag., **Weight:** 5.67 kg, **Barrel Length:** 610mm, **Muzzle Velocity:** 800 m/s, **Approx. Effective Range:** 1300 m (4265 ft).



**5.56mm Colt M16A2 Model 723 Carbine**

**Cartridge:** 5.56mm x 45 NATO, **Damage:** 3D6, **P.V.:** 5, **Feed:** 20 or 30 round box mag., **Weight:** 3.2 kg, **Barrel Length:** 368mm (838mm), **Muzzle Velocity:** 921 m/s, **Rate of Fire:**(cyclic) 750-950 rounds/min., **Approx. Effective Range:** 600 m (1969ft).

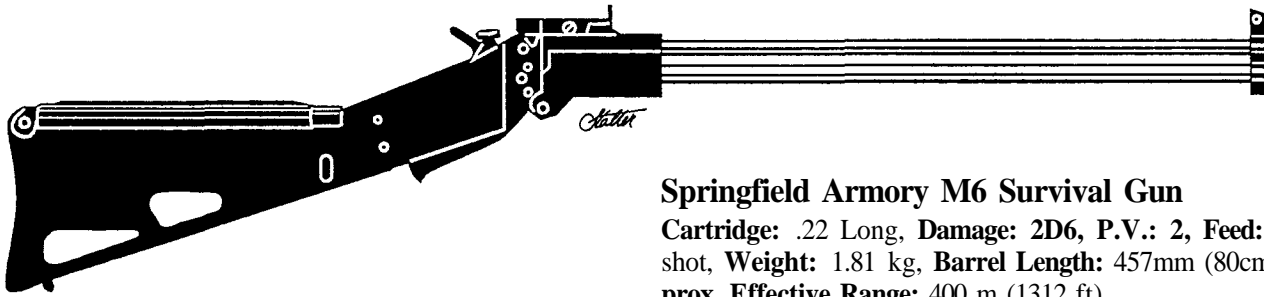

**Springfield Armory M6 Survival Gun**

**Cartridge:** .22 Long, **Damage:** 2D6, **P.V.:** 2, **Feed:** single shot, **Weight:** 1.81 kg, **Barrel Length:** 457mm (80cm), **Approx. Effective Range:** 400 m (1312 ft).

**YUGOSLAVIA**

---

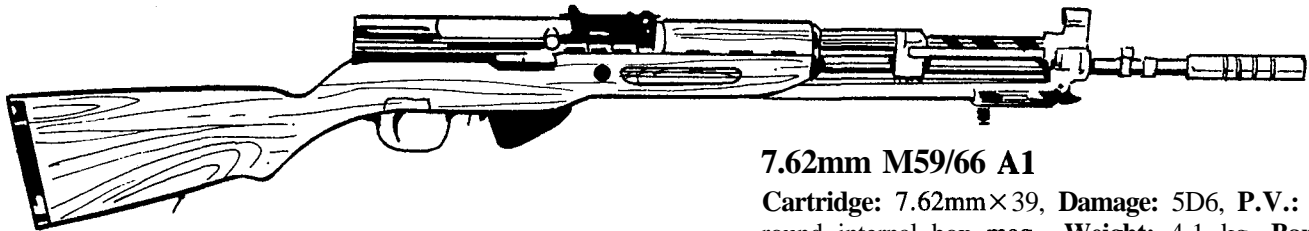

**7.62mm M59/66 A1**

**Cartridge:** 7.62mm x 39, **Damage:** 5D6, **P.V.:** 6, **Feed:** 10 round internal box mag., **Weight:** 4.1 kg, **Barrel Length:** 508mm (1120mm), **Muzzle Velocity:** 735 m/s, **Rate of Fire:** 30-40 rounds/min., **Approx. Effective Range:** 500 m (1640 ft).

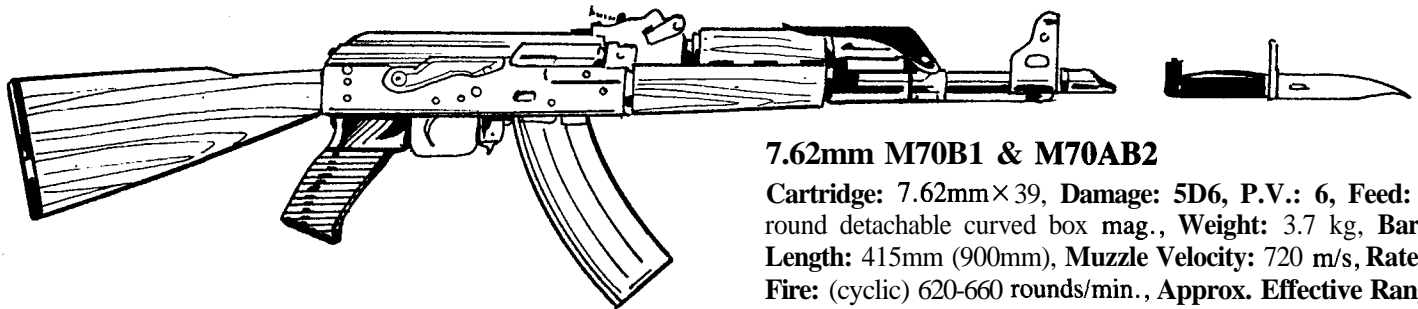

**7.62mm M70B1 & M70AB2**

**Cartridge:** 7.62mm x 39, **Damage:** 5D6, **P.V.:** 6, **Feed:** 30 round detachable curved box mag., **Weight:** 3.7 kg, **Barrel Length:** 415mm (900mm), **Muzzle Velocity:** 720 m/s, **Rate of Fire:** (cyclic) 620-660 rounds/min., **Approx. Effective Range:** 400 m (1312 ft).

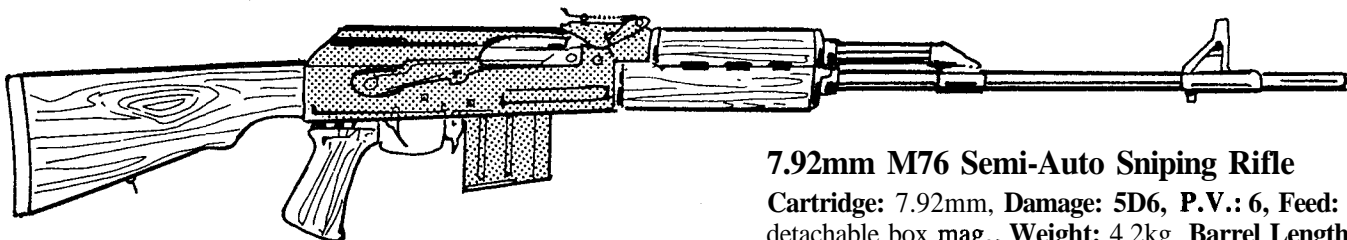

**7.92mm M76 Semi-Auto Sniping Rifle**

**Cartridge:** 7.92mm, **Damage:** 5D6, **P.V.:** 6, **Feed:** 10 round detachable box mag., **Weight:** 4.2kg, **Barrel Length:** 550mm (1135mm), **Muzzle Velocity:** 720m/s, **Approx. Effective Range:** 1000m, **Rate of Fire:** 30 rounds/min.

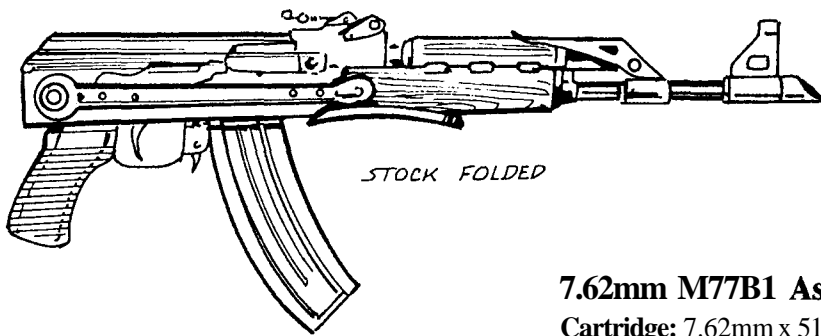

STOCK FOLDED

### 7.62mm M77B1 Assault Rifle

**Cartridge:** 7.62mm x 51 NATO, **Damage:** 5D6, **P.V.:** 6, **Feed:** 20 round detachable box mag., **Weight:** 4.8 kg, **Barrel Length:** 500mm (990mm), **Muzzle Velocity:** 840 m/s, **Rate of Fire:** (cyclic) 600 rounds/min., **Approx. Effective Range:** 600 m (1969 ft).

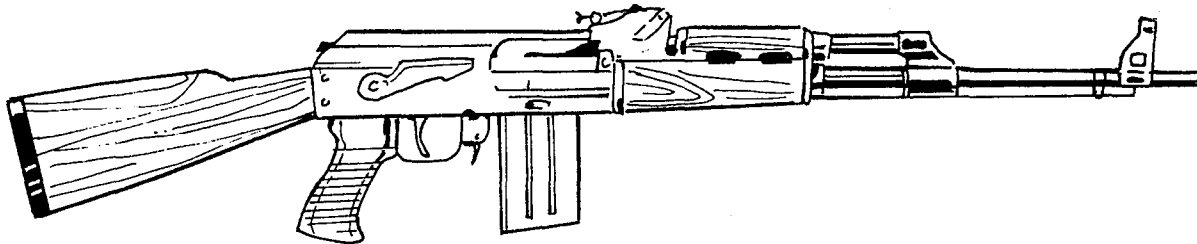

WITH FIXED WOODEN STOCK

### 5.56mm Assault Rifle

**Cartridge:** 5.56mm x 45, **Damage:** 3D6, **P.V.:** 5, **Feed:** 20 round detachable straight box mag., **Weight:** 3.5 kg, **Barrel Length:** 460mm (990mm), **Muzzle Velocity:** 970 m/s, **Approx. Effective Range:** 300 m (984 ft).

---

## RIFLE ACCESSORIES

---

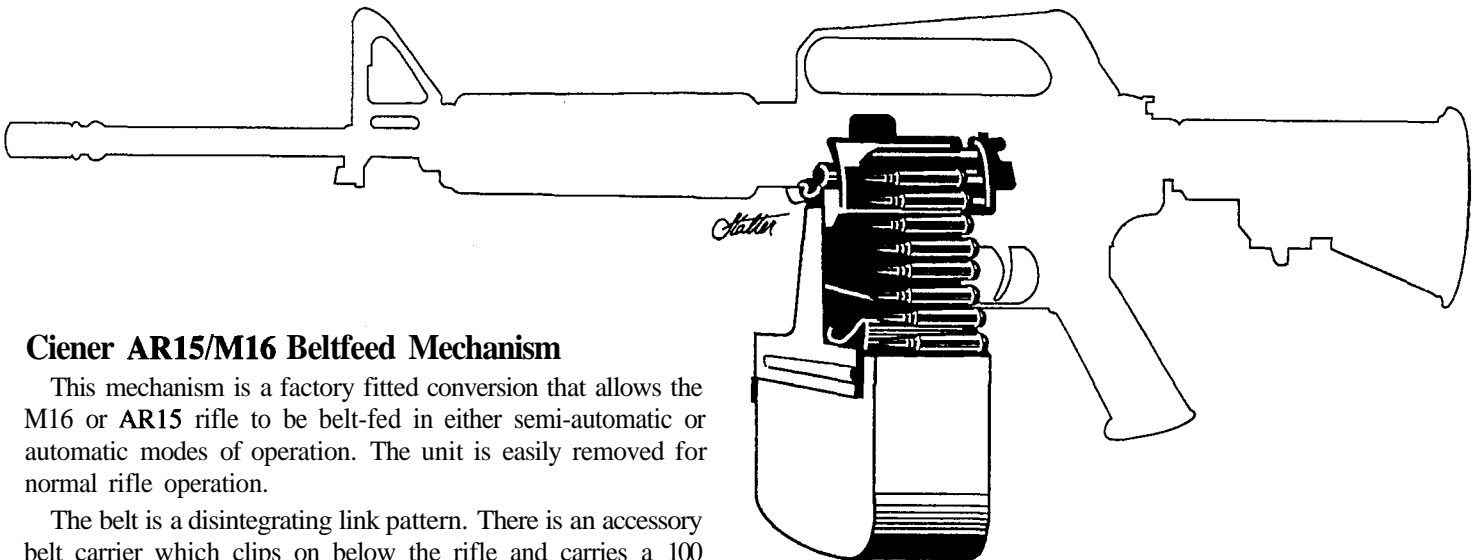

### Ciener AR15/M16 Beltfeed Mechanism

This mechanism is a factory fitted conversion that allows the M16 or AR15 rifle to be belt-fed in either semi-automatic or automatic modes of operation. The unit is easily removed for normal rifle operation.

The belt is a disintegrating link pattern. There is an accessory belt carrier which clips on below the rifle and carries a 100 round belt. It also has a chute which catches the empty links for future use.

MWG 5.56mm 90 Round Magazine

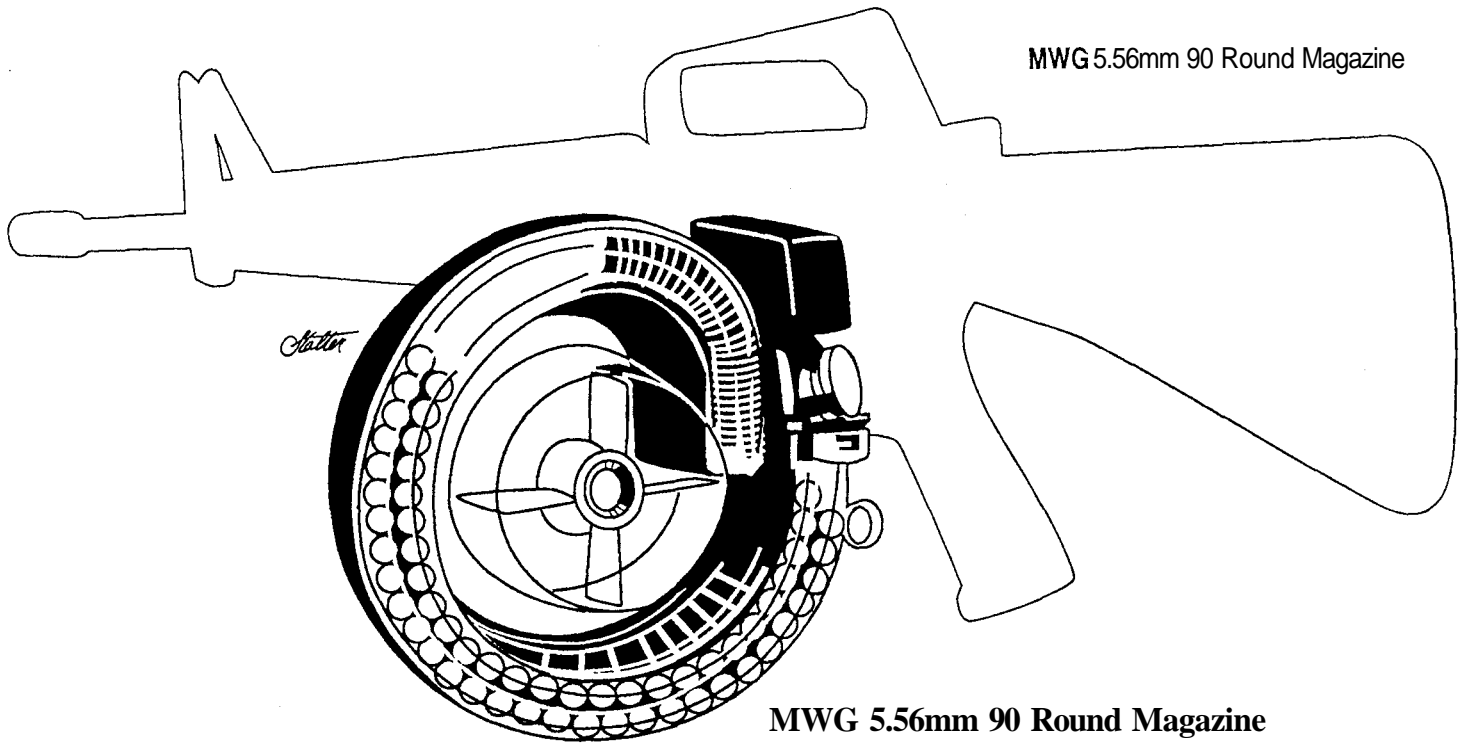

### MWG 5.56mm 90 Round Magazine

This option is also for the M16/AR15 rifles, however, with minor modifications it can also *be* converted for use with other weapons. This magazine is of the "snail" form and is made of a high-strength plastic material. It is loaded by means of an accessory tool. The magazine rests comfortably on the forearm and the whole assembly is very stable when firing.

5.56mm Colt M16A2 Model 732 Carbine Rifle

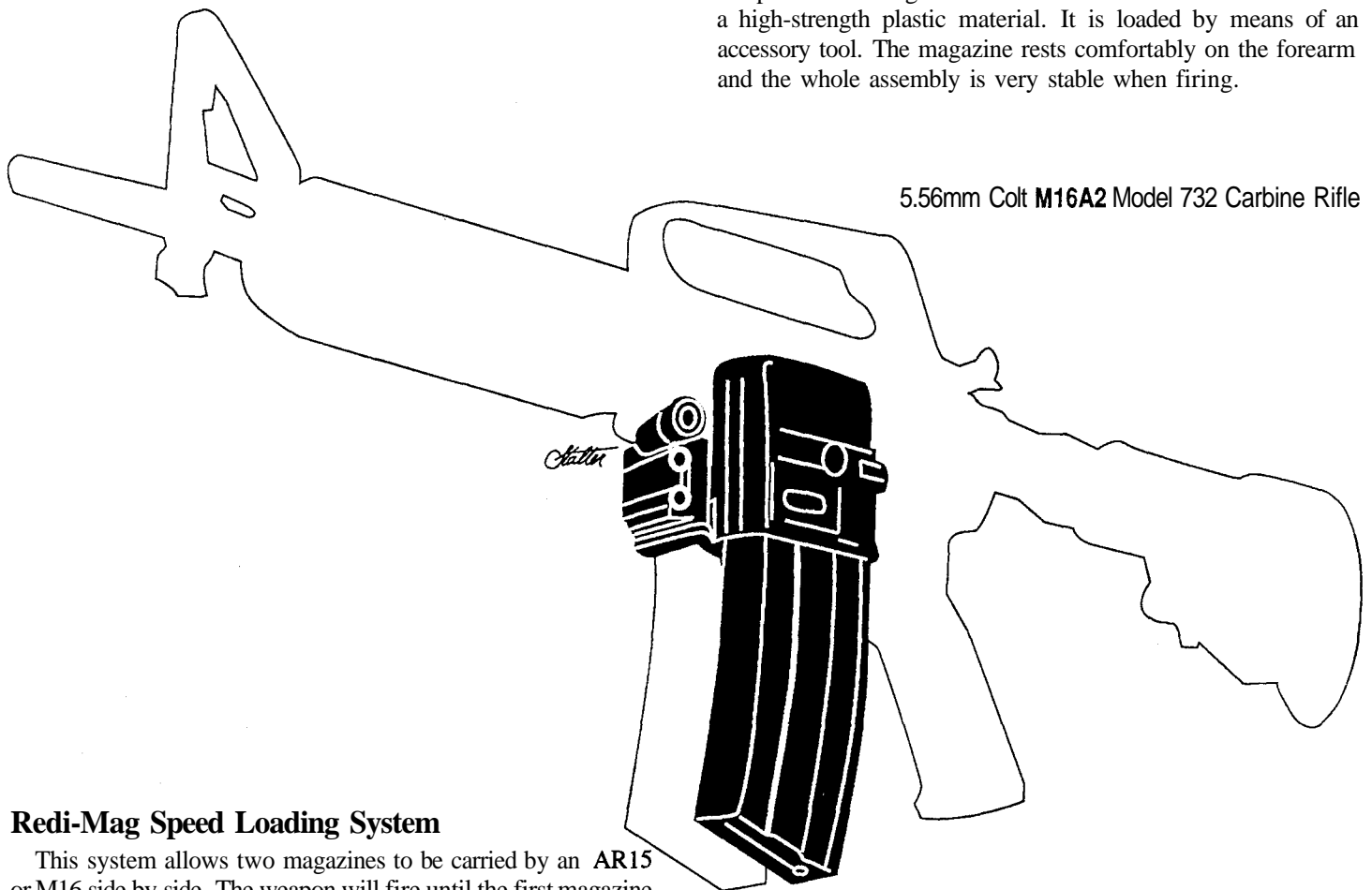

### Redi-Mag Speed Loading System

This system allows two magazines to be carried by an AR15 or M16 side by side. The weapon will fire until the first magazine is **empty**. The operator then presses the magazine **catch**, releasing the first magazine and pushing the second sideways and into the **feed-way**. A new magazine can be inserted within two seconds of the last shot **fired**.

---

# Shotguns

**Note:** The effective range for virtually all shotguns is 45.7 to 75 m (150 to 246 feet). Buckshot and similar fragmentation rounds will spray a 0.9 meter (3 ft) area. A sawed-off shotgun has a dramatically reduced barrel length which increases the width of the buckshot "spray" (covers a 1.5 m/5 foot area), but reduces the effective range to about 15 to 18 meters (50 to 60 feet).

Many of the combat shotguns have been specially designed to resist corrosion in damp environments and all are extremely reliable. Most can fire a variety of different cartridges.

---

## ITALY

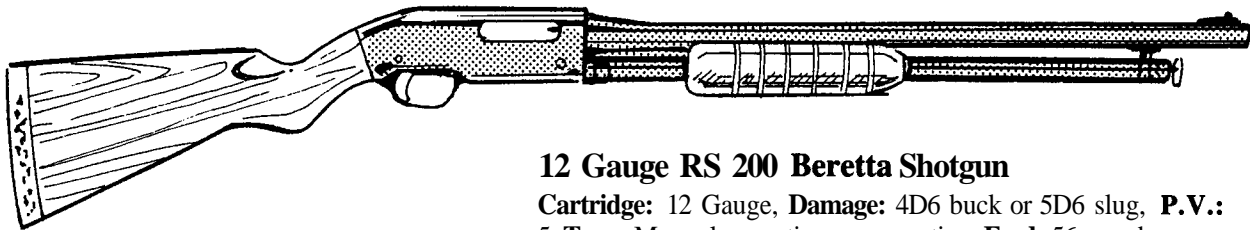

### 12 Gauge RS 200 Beretta Shotgun

**Cartridge:** 12 Gauge, **Damage:** 4D6 buck or 5D6 slug, **P.V.:** 5, **Type:** Manual, repeating, pump action, **Feed:** 56 round pump-operated mag., **Weight:** approx. 3 kg, **Barrel Length:** 520mm.

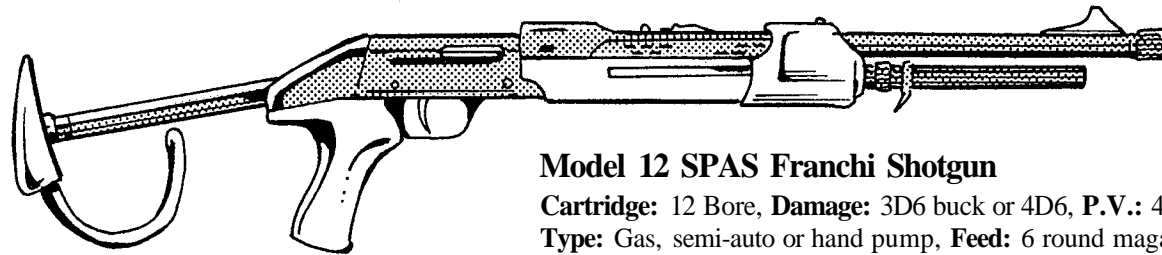

### Model 12 SPAS Franchi Shotgun

**Cartridge:** 12 Bore, **Damage:** 3D6 buck or 4D6, **P.V.:** 4 or 5, **Type:** Gas, semi-auto or hand pump, **Feed:** 6 round magazine, **Weight:** 3.2 kg, **Barrel Length:** 500mm (900mm).

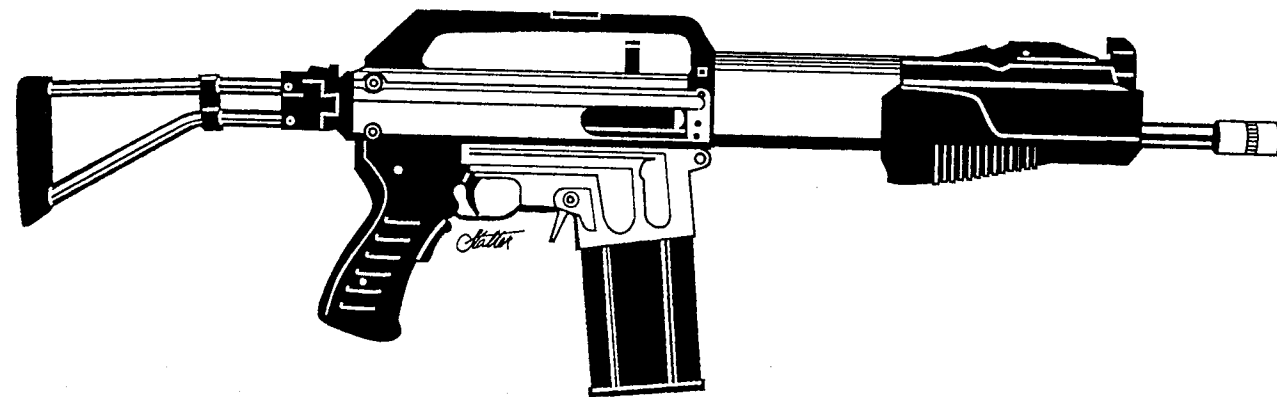

### 12 Gauge Franchi SPAS 15 Shotgun

**Cartridge:** 12 Gauge, **Damage:** 4D6 buck or 5D6 slug, **P.V.:** 4 or 5, **Type:** Gas, semiautomatic, or manual pump action, **Feed:** 6 round box mag., **Weight:** 3.80 kg (without mag.), **Barrel Length:** 400mm (920mm).

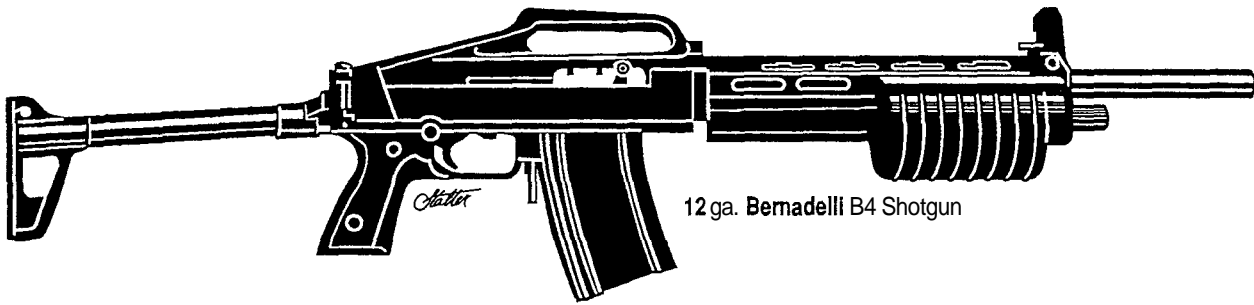

12 ga. Bernadelli B4 Shotgun

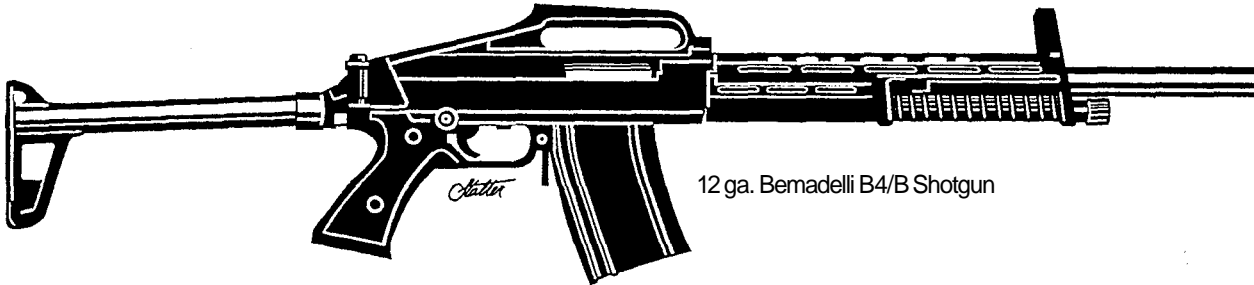

12 ga. Bernadelli B4/B Shotgun

### 12 Gauge Bernadelli B4 Shotgun

**Cartridge:** 12 Gauge, **Damage:** 4D6 buck or 5D6, **P.V.:** 5, **Type:** Gas, semiautomatic or manual pump action, **Feed:** 3, 5 or 8 round mag., **Weight:** 3.45 kg, **Barrel Length:** 460mm (950mm).

## SOUTH AFRICA

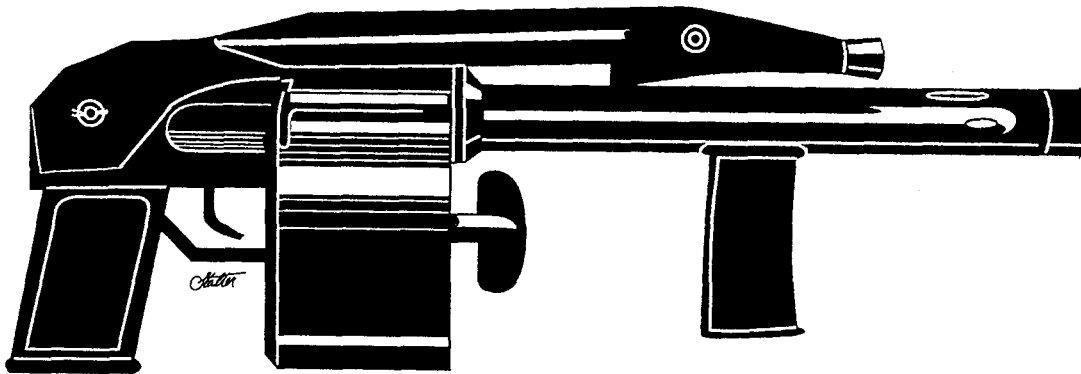

### 12 Gauge Striker semiautomatic Shotgun

**Cartridge:** 12 Gauge, **Damage:** 4D6 buck or 5D6, **P.V.:** 4 or 5, **Type:** Repeating revolver, **Feed:** 12 shot cylinder, **Weight:** 4.20 kg (empty), **Barrel Length:** 300mm (780mm).

## UNITED STATES



### Model 37M Ithaca Shotgun

**Cartridge:** 12 Gauge, **Damage:** 4D6 buck or 5D6 slug, **P.V.:** 5, **Type:** Slide action repeater, **Feed:** 5 or 8 shot tubular mag., **Weight:** 3.06 kg, **Barrel Length:** 470mm.

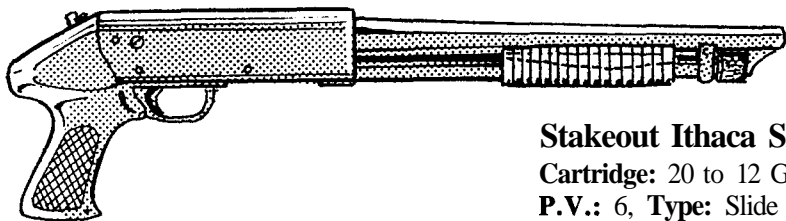

### Stakeout Ithaca Shotgun

**Cartridge:** 20 to 12 Gauge, **Damage:** 4D6 buck or 5D6 slug, **P.V.:** 6, **Type:** Slide action repeater, **Feed:** 5 round tubular mag., **Weight:** (20 gauge) 1.58 kg, (12 gauge) 2.26 kg, **Barrel Length:** 336m.

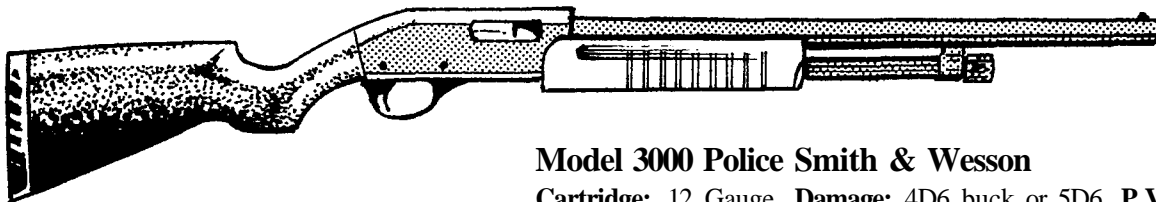

### Model 3000 Police Smith & Wesson

**Cartridge:** 12 Gauge, **Damage:** 4D6 buck or 5D6, **P.V.:** 5, **Type:** Single shot, **Weight:** 3.06 kg, **Barrel Length:** 458mm (978mm).

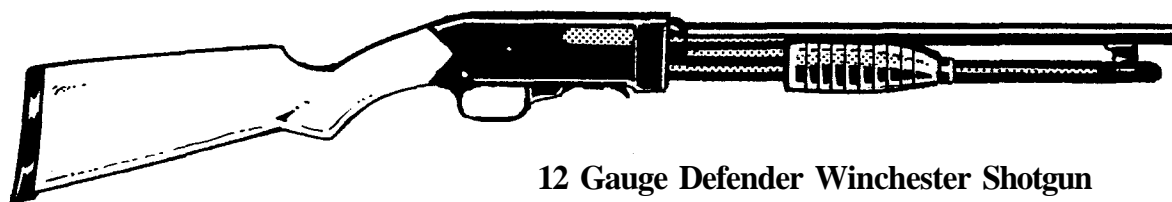

### 12 Gauge Defender Winchester Shotgun

**Cartridge:** 12 Gauge, **Damage:** 4D6 buck or 5D6 slug, **P.V.:** 5, **Type:** Slide action repeater, **Feed:** 7 shot tubular mag., **Weight:** 3.06 kg, **Barrel Length:** 457mm.

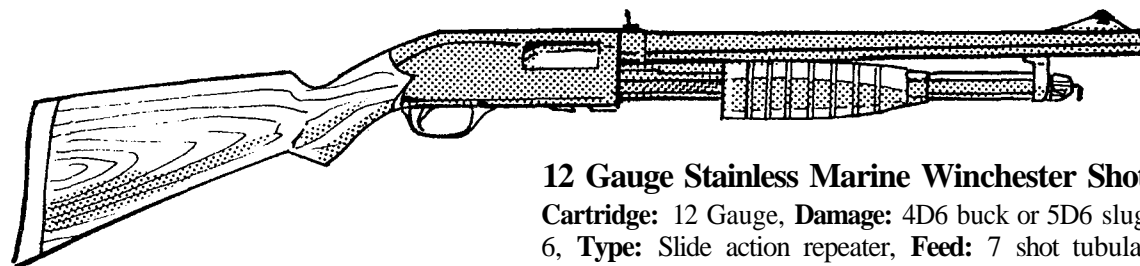

### 12 Gauge Stainless Marine Winchester Shotgun

**Cartridge:** 12 Gauge, **Damage:** 4D6 buck or 5D6 slug, **P.V.:** 6, **Type:** Slide action repeater, **Feed:** 7 shot tubular mag., **Weight:** 3.17 kg, **Barrel Length:** 457mm.

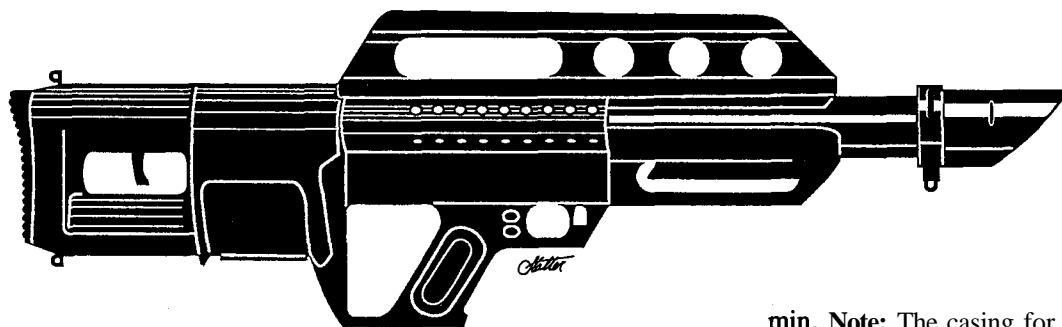

### Pancor Jackhammer Mark 3A2

**Cartridge:** 12 Gauge, **Damage:** 4D6 buck, 5D6 most conventional slugs, 6D6 for rocket assisted and special rounds, **P.V.:** 5 for most, P.V. 6 for rocket assisted, glaser and armor piercing, **Feed:** 10 shot rotating cylinder, **Weight:** 4.57kg, **Barrel Length:** 525mm (787mm), **Cyclic Rate of Fire:** 240 rounds/

**min. Note:** The casing for this shotgun is made almost entirely of a highimpact plastic called *Rynite SST* and fiberglass! The internal workings are steel. A fairly inexpensive sound suppressor is being developed for this weapon. The suppressor can be discarded after a limited **life**. It is designed to allow such payloads as armor piercing, **flechettes**, fragmentation loads, canister loadings, chemical rounds, and rocket-assisted projectiles, as well as conventional loads.



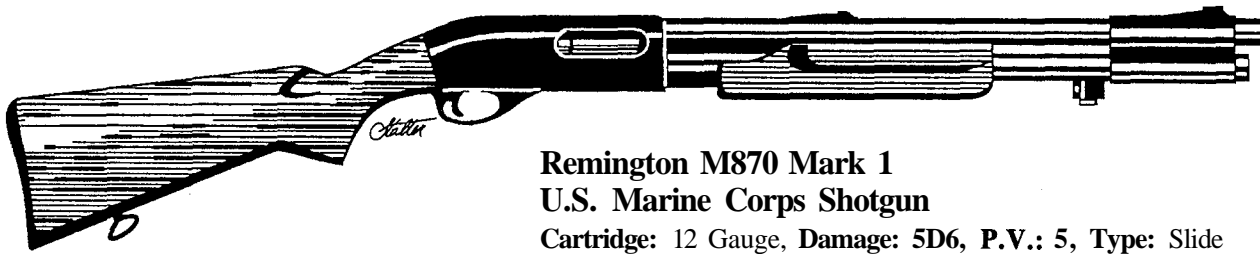

**Remington M870 Mark 1  
U.S. Marine Corps Shotgun**

**Cartridge:** 12 Gauge, **Damage:** 5D6, **P.V.:** 5, **Type:** Slide action, **Feed:** 7 shot tubular mag., **Weight:** 3.6 kg, **Barrel Length:** 533mm (1060mm).

---

## Sub-Machineguns

A **sub-machinegun** is not much different from a pistol. It is a light automatic weapon which can be fired from a shoulder or hip position. The big difference is that it usually requires two hands for stable firing.

During the First World War, sub-machineguns came into use because of the need for close-range **firepower**. However, it was not until World War II that the sub-machinegun was actually mass produced. Since that time, the major improvements made have been in size and weight. These weapons use *pistol ammunition* and little can be done to improve on their performance. This has created a problem for the manufacturers because with

the improvements that are being made on automatic and semiautomatic rifles, sub-machineguns as a separate class of weapon may well soon be extinct. However, the low cost and ease of maintenance creates a strong case for keeping sub-machineguns around for many years to come.

As for the major characteristics of sub-machine **guns**, **Jane's Infantry Weapons** sums it up rather well in that they are "light, handy and easy to carry; fire low-powered ammunition with limited range and penetration; magazine feed; automatic fire, usually with the provision of single shots; simple and cheap to produce."

---

### ARGENTINA

#### 9mm PA3-DM sub-machinegun

**Cartridge:** 9mm Parabellum, **Damage:** 2D6, **P.V.:** 4, **Feed:** 25 round box mag., **Weight:** 3.4 kgs, **Barrel Length:** 290mm (700mm), **Muzzle Velocity:** 400 m/s, **Rate of Fire:** (cyclic) 650 rounds/min., **Approx. Effective Range:** 200 m (656 ft).

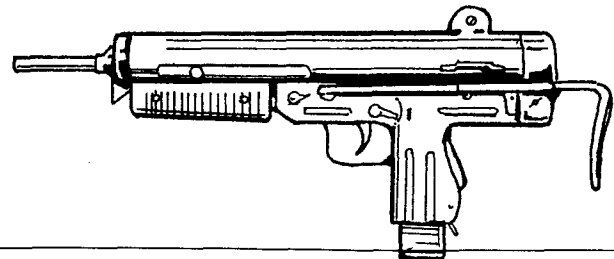

---

### AUSTRALIA

#### Owen MK1

**Cartridge:** 9mm, **Damage:** 2D6, **P.V.:** 4, **Feed:** 33 round box mag., **Weight:** 4.24 kg, **Barrel Length:** 305mm (813mm), **Muzzle Velocity:** 381 m/s, **Rate of Fire:** (cyclic) 700 rounds/min., **Approx. Effective Range:** 200 m (656 ft).

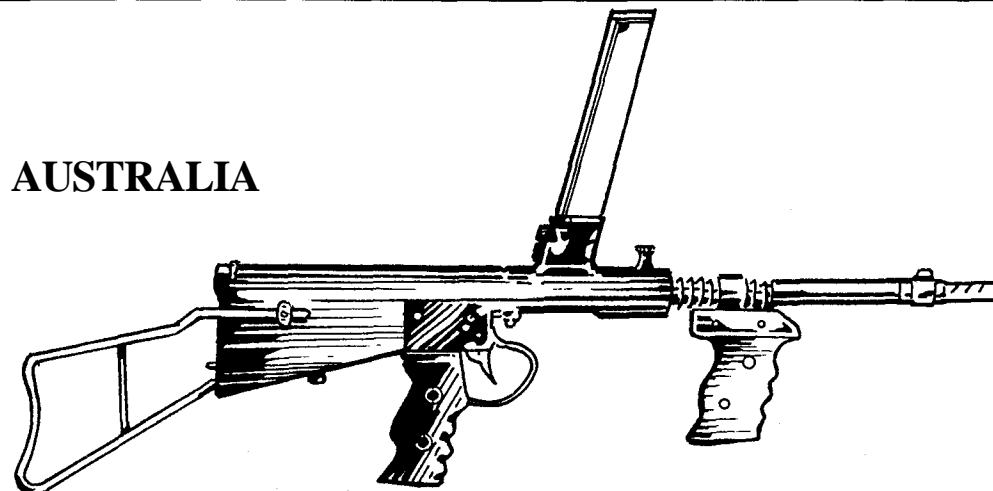

## AUSTRIA

### 9mm MPi 69 & MPi 81 Steyr

**Cartridge:** 9mm×19 Parabellum, **Damage:** 2D6, **P.V.:** 4, **Feed:** 25 or 32 round box mag., **Weight:** 2.93 kg, **Barrel Length:** 228mm (670mm), **Muzzle Velocity:** 381 m/s, **Rate of Fire:**(cyclic) 550 rounds/min., (auto) 100 rounds/min., **Approx. Effective Range:** 200 m (656 ft).

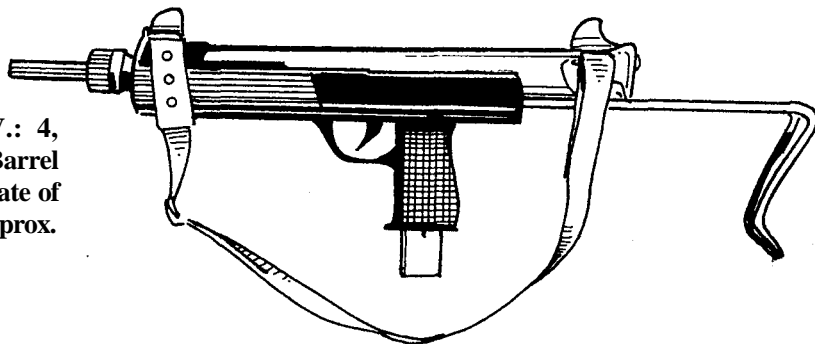

## BELGIUM

### 9mm Mitraillette Vigneron M2

**Cartridge:** 9mm Parabellum, **Damage:** 2D6, **P.V.:** 4, **Feed:** 32 round box mag., **Weight:** 3.29 kg, **Barrel Length:** 305mm (886mm), **Muzzle Velocity:** 381 m/s, **Rate of Fire:** (cyclic) 629 rounds/min., (auto) 120 rounds/min., **Approx. Effective Range:** 200 m (656 ft).

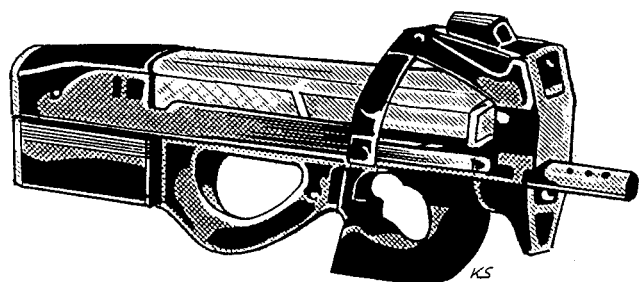
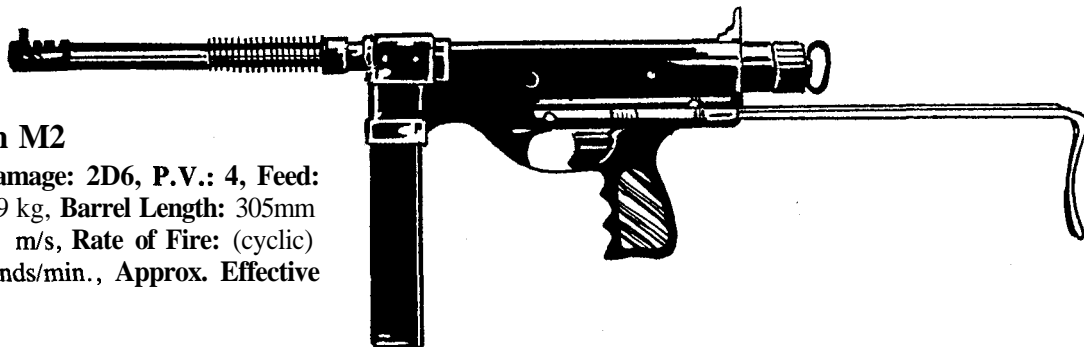

### 5.7mm FN P90 personal weapon

**Cartridge:** 5.7×28, **Damage:** 2D6, **P.V.:** 4, **Feed:** 50 round mag., **Weight:** 2.80 kg (empty), 3.70 kg (with full magazine), **Muzzle Velocity:** 850 m/s, **Rate of Fire:** 800-1000 rounds/minute, **Approx. Effective Range:** 150-200 m (492 to 656 ft).

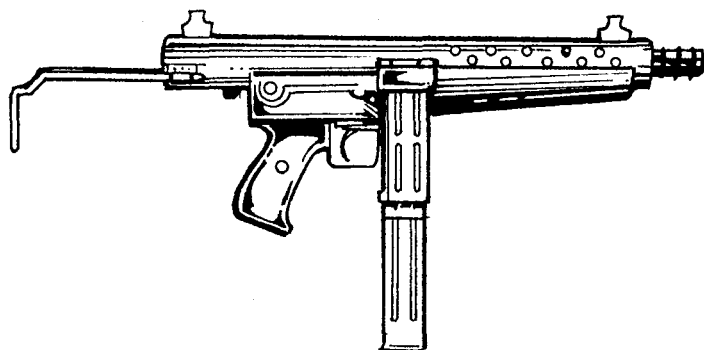

## BRAZIL

### 9mm BSM/9 M3

**Cartridge:** 9mm Parabellum, **Damage:** 2D6, **P.V.:** 4, **Feed:** 20 or 32 round box mag., **Weight:** 3.03 kg, **Barrel Length:** 228mm (698mm), **Muzzle Velocity:** 400 m/s, **Rate of Fire:** (cyclic) 600 rounds/min., **Approx. Effective Range:** 150 m (492 ft).

### 9mm MD1 and MD-1A1 IMBEL

**Cartridge:** 9mm×19 Parabellum, **Damage:** 2D6, **P.V.:** 4, **Feed:** 30 round box mag., **Weight:** 3.28 kg, **Barrel Length:** 211mm (720mm), **Muzzle Velocity:** 400 m/s, **Rate of Fire:**(cyclic) 550 rounds/min., **Approx. Effective Range:** 175 m (574 ft).

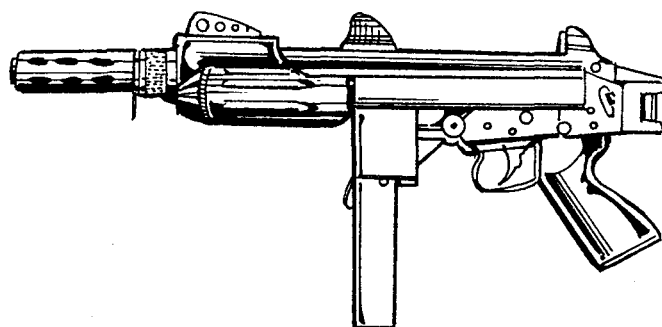

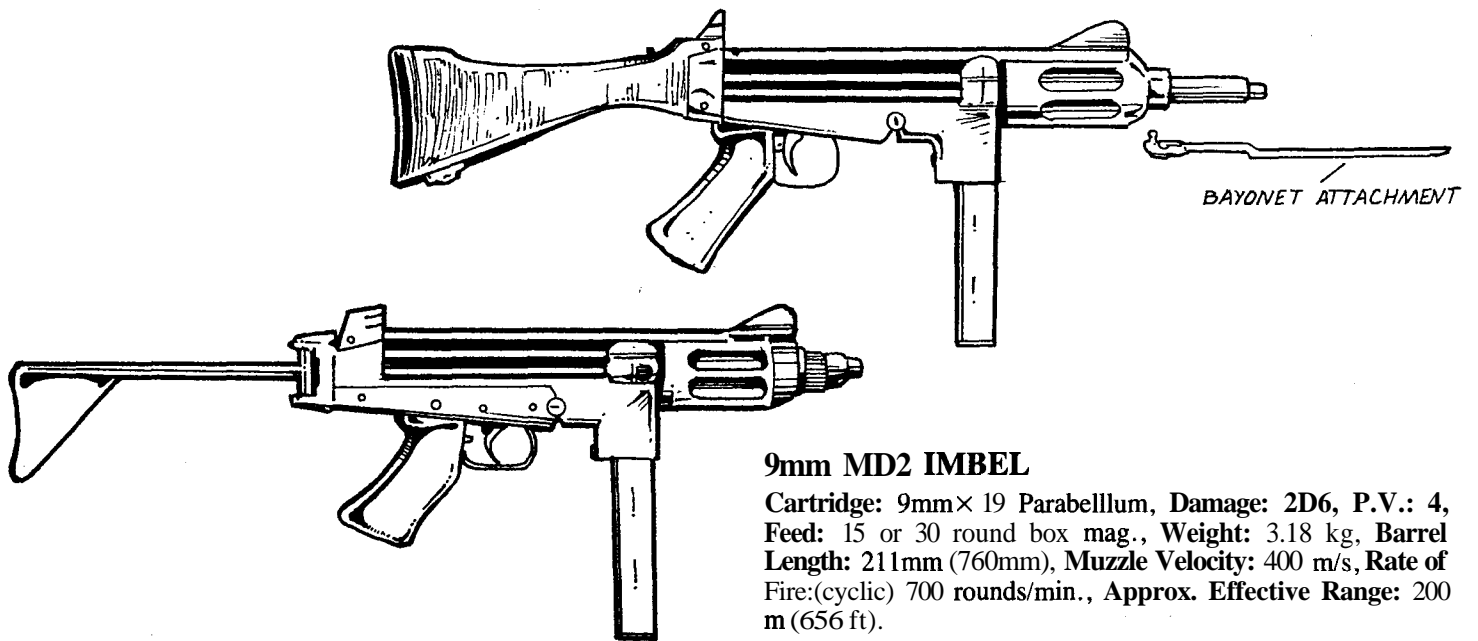

**9mm MD2 IMBEL**

**Cartridge:** 9mm×19 Parabellum, **Damage:** 2D6, **P.V.:** 4, **Feed:** 15 or 30 round box mag., **Weight:** 3.18 kg, **Barrel Length:** 211mm (760mm), **Muzzle Velocity:** 400 m/s, **Rate of Fire:**(cyclic) 700 rounds/min., **Approx. Effective Range:** 200 m (656 ft).

**.45 INA MB 50**

**Cartridge:** Colt .45 auto pistol, **Damage:** 4D6, **P.V.:** 5, **Feed:** 30 round mag., **Weight:** 3.4 kg, **Barrel Length:** 213mm (794mm), **Muzzle Velocity:** 280 m/s, **Rate of Fire:** (cyclic) 650 rounds/min., (auto) 120 rounds/min., **Approx. Effective Range:** 200 m (656 ft).

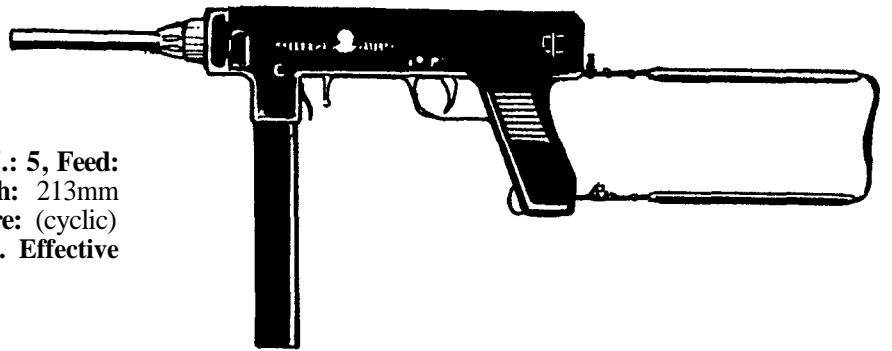

**9mm LAPA SM Model 02**

**Cartridge:** 9mm×19 Parabellum, **Damage:** 2D6, **P.V.:** 4, **Feed:** 30 or 32 round straight or curved box mag., **Weight:** 3.38 kg, **Barrel Length:** 202mm (623mm), **Muzzle Velocity:** 405 m/s, **Rate of Fire:** 485 rounds/min., **Approx. Effective Range:** 200 m (656 ft).

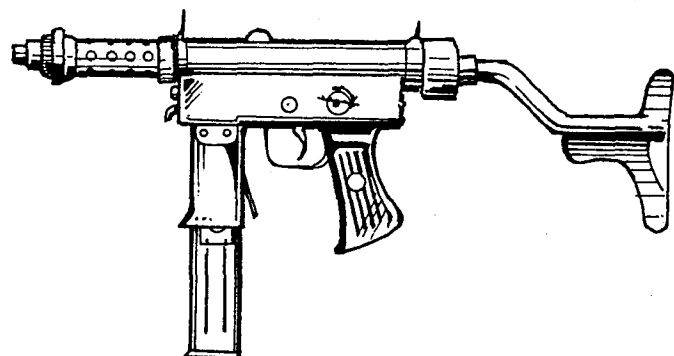
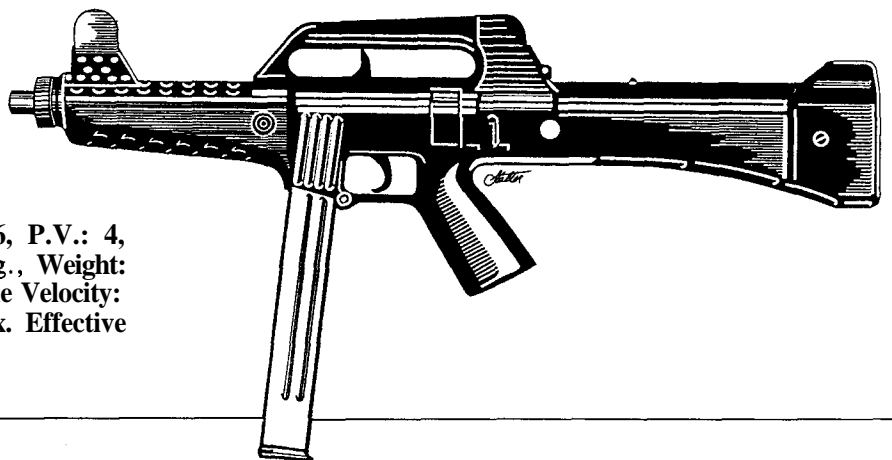

**9mm Uru Mekanika**

**Cartridge:** 9mm×19 Parabellum, **Damage:** 2D6, **P.V.:** 4, **Feed:** 30 round box mag., **Weight:** 3.01 kg, **Barrel Length:** 175mm (671mm), **Muzzle Velocity:** 389 m/s, **Rate of Fire:**(cyclic) 750 rounds/min., **Approx. Effective Range:** 138m (453 ft).

## CANADA

### 9mm CI

**Cartridge:** 9mm Parabellum, **Damage:** 2D6, **P.V.:** 4, **Feed:** 30 round box mag., **Weight:** 2.95 kg, **Barrel Length:** 198mm (686mm), **Muzzle Velocity:** 366 m/s, **Rate of Fire:** (cyclic) 550 rounds/min., **Approx. Effective Range:** 185 m (607 ft).

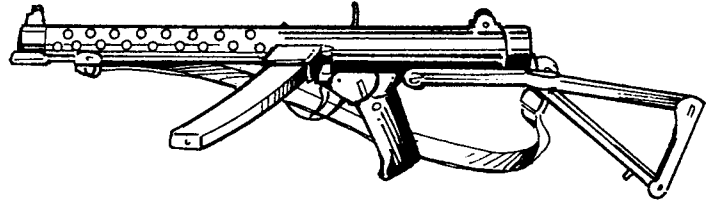

## CHINA, PEOPLE'S REPUBLIC

### 7.62mm Type 64

**Cartridge:** 7.62mm x 25 Type P Ball, **Damage:** 1D8, **P.V.:** 2, **Feed:** 30 round curved box mag., **Weight:** 3.4 kg, **Barrel Length:** 244mm (843mm), **Muzzle Velocity:** 513 m/s, **Rate of Fire:** (cyclic) 13-15 rounds/min., **Approx. Effective Range:** 135 m (445 ft).

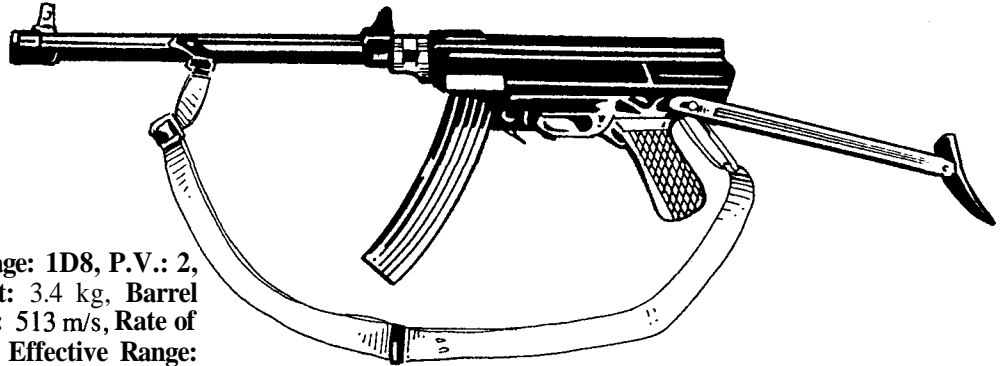

## CZECHOSLOVAKIA

### Model 23, 24, 25 & 26

**Cartridge:** 9mm Parabellum, **Damage:** 2D6, **P.V.:** 4, **Feed:** 24 or 40 round box mag., **Weight:** 3.27 kg, **Barrel Length:** 284mm (686mm), **Muzzle Velocity:** 381 m/s, **Rate of Fire:** (cyclic) 650 rounds/min., **Approx. Effective Range:** 200 m (656 ft).

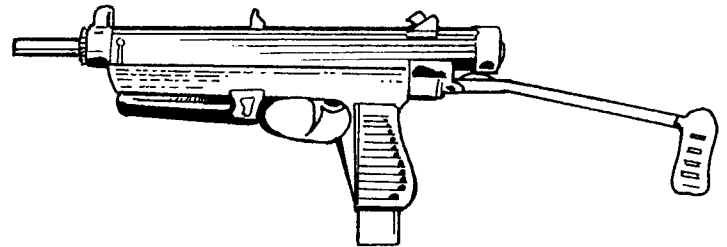

## DENMARK

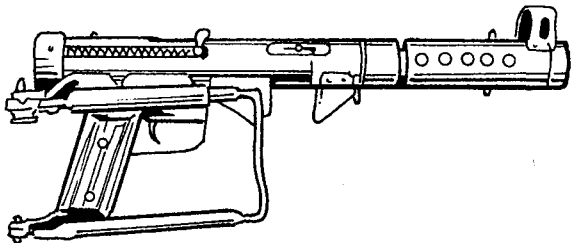

### 9mm Model 49 Hovea

**Cartridge:** 9mm Parabellum, **Damage:** 2D6, **P.V.:** 4, **Feed:** 36 round detachable box mag., **Weight:** 3.4 kg, **Barrel Length:** 215mm (810mm), **Muzzle Velocity:** 390 m/s, **Rate of Fire:** (cyclic) 600 rounds/min., **Approx. Effective Range:** 180m (590 ft).

### 9mm Madsen

**Cartridge:** 9mm Parabellum, **Damage:** 2D6, **P.V.:** 4, **Feed:** 32 round box mag., **Weight:** 3.2 kg, **Barrel Length:** 198mm (794mm), **Muzzle Velocity:** 390 m/s, **Rate of Fire:** (cyclic) 550 rounds/min., **Approx. Effective Range:** 145 m (475 ft).

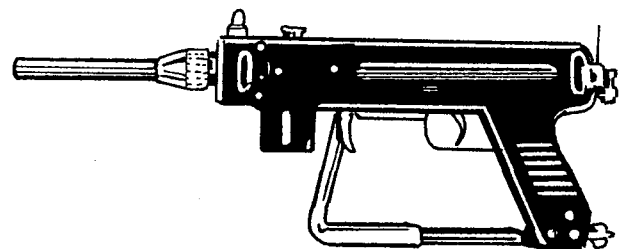

## FINLAND

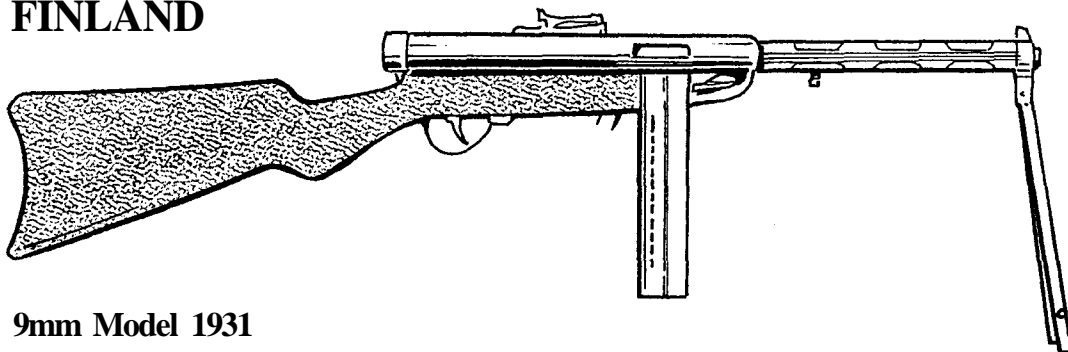

### 9mm Model 1931

**Cartridge:** 9mm Parabellum, **Damage:** 2D6, **P.V.:** 4, **Feed:** 50 round box or 71 round drum mag., **Weight:** 4.68 kg, **Barrel Length:** 318mm (870mm), **Muzzle Velocity:** 399 m/s, **Rate of Fire:** (cyclic) 900 rounds/min., (auto) 120 rounds/min., **Approx. Effective Range:** 200 m (656 ft).

### 9mm Model 1944

**Cartridge:** 9mm×19 Parabellum, **Damage:** 2D6, **P.V.:** 4, **Feed:** 36 round box or 71 round drum mag., **Weight:** 2.94 kg, **Barrel Length:** 249mm (831mm), **Muzzle Velocity:** 399 m/s, **Rate of Fire:** (cyclic) 650 rounds/min., (auto) 120 rounds/min., **Approx. Effective Range:** 200 m (656 ft).

### 9mm Jati-Matic

**Cartridge:** 9mm Parabellum, **Damage:** 2D6, **P.V.:** 4, **Feed:** 20 or 40 round detachable box mag., **Weight:** 1.95 kg, **Barrel Length:** 203mm (375mm), **Muzzle Velocity:** 360-400m/s, **Rate of Fire:** 600-650 rounds/min., **Approx. Effective Range:** 150 m (492 ft).

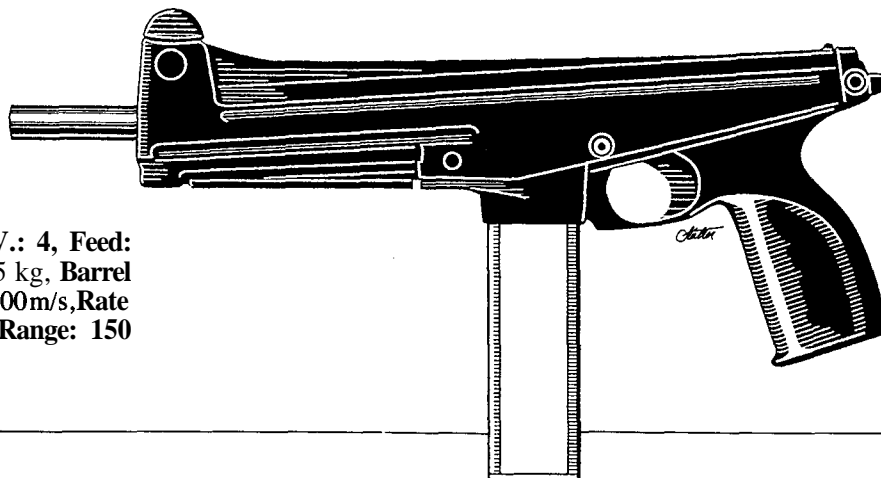

## FRANCE

### 7.65mm Model 38 MAS

**Cartridge:** 7.65mm long, **Damage:** 2D6, **P.V.:** 3, **Feed:** 32 round detachable box mag., **Weight:** 2.87 kg, **Barrel Length:** 224mm (734mm), **Muzzle Velocity:** 351 m/s, **Rate of Fire:** (cyclic) 600 rounds/min., (auto) 120 rounds/min., **Approx. Effective Range:** 200 m (656 ft).

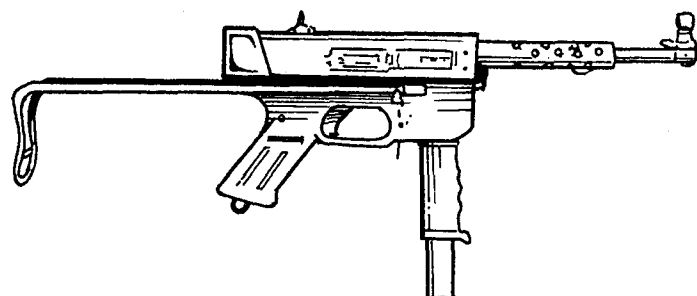
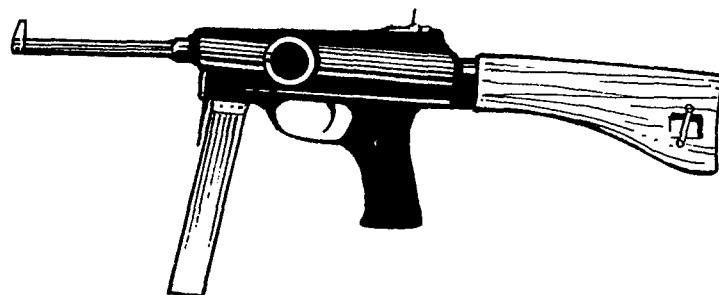

### 9mm MAT 49

**Cartridge:** 9mm Parabellum, **Damage:** 2D6, **P.V.:** 4, **Feed:** 20 or 32 round box mag., **Weight:** 3.5 kg, **Barrel Length:** 228mm (720mm), **Muzzle Velocity:** 390 m/s, **Rate of Fire:** (cyclic) 600 rounds/min., **Approx. Effective Range:** 185 m (607 ft).

## 9mm Gevarm

**Cartridge:** 9mm Parabellum, **Damage:** 2D6, **P.V.:** 4, **Feed:** 32 round detachable box mag., **Weight:** 3.2 kg, **Barrel Length:** 220mm (500mm), **Muzzle Velocity:** 390 m/s, **Rate of Fire:**(cyclic) 600 rounds/min., **Approx. Effective Range:** 200 m (656 ft).

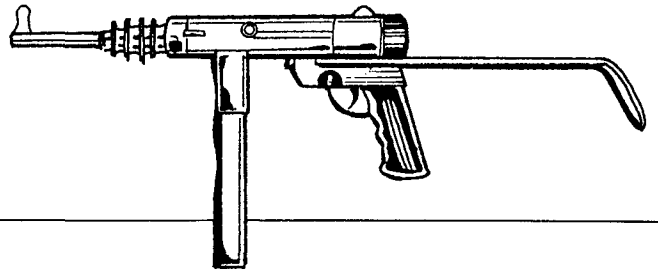

## GERMANY

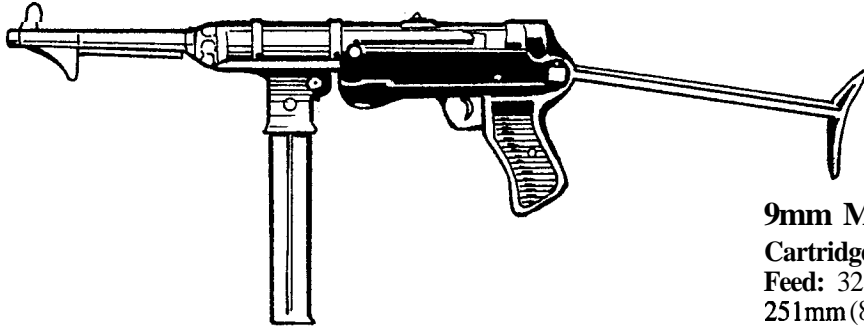

### 9mm MP40

**Cartridge:** 9mm×19 Parabellum, **Damage:** 2D6, **P.V.:** 4, **Feed:** 32 round box mag., **Weight:** 4.03 kg, **Barrel Length:** 251mm (833mm), **Muzzle Velocity:** 381 m/s, **Rate of Fire:**(cyclic) 500 rounds/min., **Approx. Effective Range:** 138 m (453 ft).

### 9mm Dux

**Cartridge:** 9mm×19 Parabellum, **Damage:** 2D6, **P.V.:** 4, **Feed:** 50 round Suomi box mag., **Weight:** 3.58 kg, **Barrel Length:** 251mm (826mm), **Muzzle Velocity:** 381 m/s, **Rate of Fire:**(cyclic) 500 rounds/min., **Approx. Effective Range:** 200 m (656 ft).

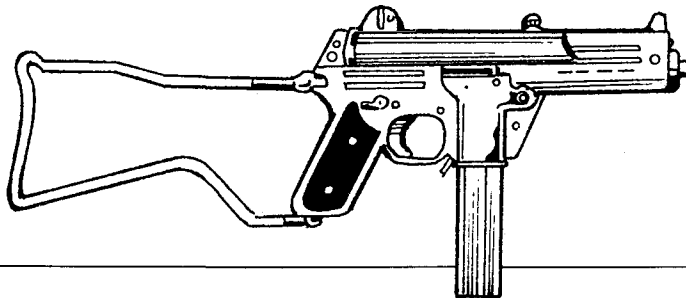
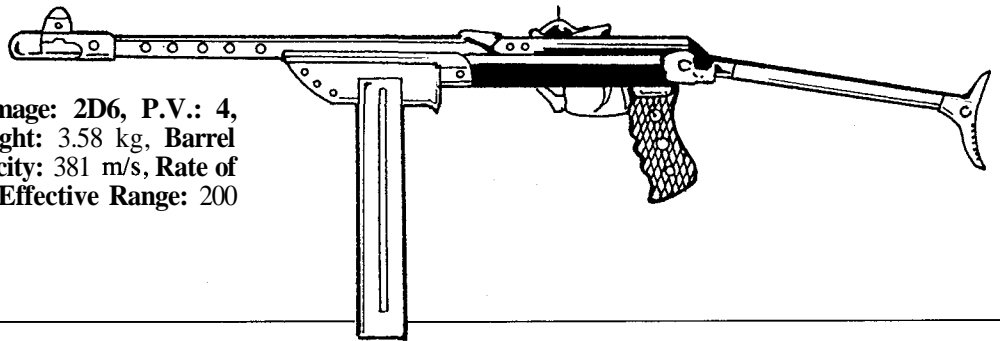

### 9mm MP-K & MP-L Walther

**Cartridge:** 9mm×19, **Damage:** 2D6, **P.V.:** 5, **Feed:** 32 round box mag., **Weight:** 2.8 kg, **Barrel Length:** 171mm (653mm), **Muzzle Velocity:** 356 m/s, **Rate of Fire:** (cyclic) 550 rounds/min., **Approx. Effective Range:** 188m (617 ft).

### 9mm MP5 Heckler & Koch

**Cartridge:** 9mm×19 Parabellum, **Damage:** 2D6, **P.V.:** 4, **Feed:** 15 or 30 round curved box mag., **Weight:** 2.45 kg, **Barrel Length:** 225mm (680mm), **Muzzle Velocity:** 400 m/s, **Rate of Fire:** (cyclic) 800 rounds/min., **Approx. Effective Range:** 200 m (656 ft).

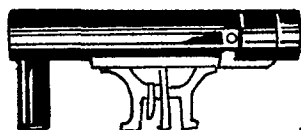
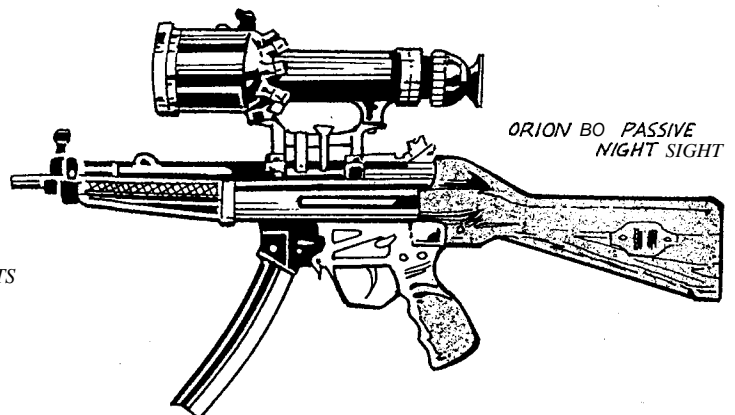

AIMING-POINT-PROJECTOR  
MI ELECTRONIC SIGHT



TELESCOPIC SIGHTS

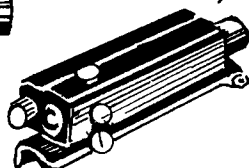

### 9mm MP5 SD Heckler & Koch

**Cartridge:** 9mm×19 Parabellum, **Damage:** 2D6, **P.V.:** 4, **Feed:** 15 or 30 round curved box mag., **Weight:** 3.1 kg, **Barrel Length:** 146mm (780mm), **Muzzle Velocity:** 285 m/s, **Rate of Fire:** (cyclic) 800 rounds/min., **Approx. Effective Range:** 185 m (607 ft).

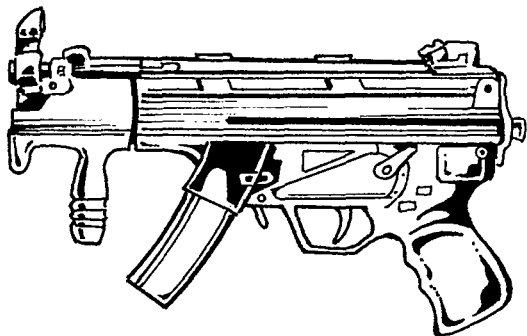
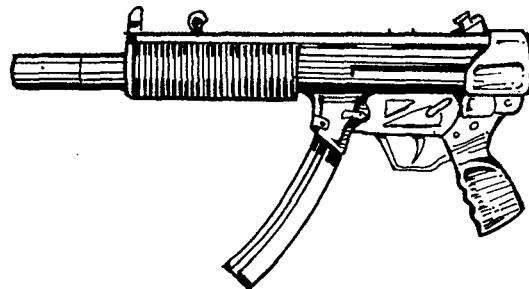

### 9mm MP5K Heckler & Koch

**Cartridge:** 9mm×19 Parabellum, **Damage:** 2D6, **P.V.:** 4, **Feed:** 15 or 30 round detachable box mag., **Weight:** 2 kg, **Barrel Length:** 115mm (325mm), **Muzzle Velocity:** 375 m/s, **Rate of Fire:** (cyclic) 900 rounds/min., **Approx. Effective Range:** 200 m (656 ft).

## INDONESIA

### 9mm PM Model VII

**Cartridge:** 9mm×19 Parabellum, **Damage:** 2D6, **P.V.:** 4, **Feed:** 33 round box mag., **Weight:** 3.29 kg, **Barrel Length:** 274mm (840mm), **Muzzle Velocity:** 381 m/s, **Rate of Fire:** (cyclic) 600 rounds/min., **Approx. Effective Range:** 165m (542 ft).

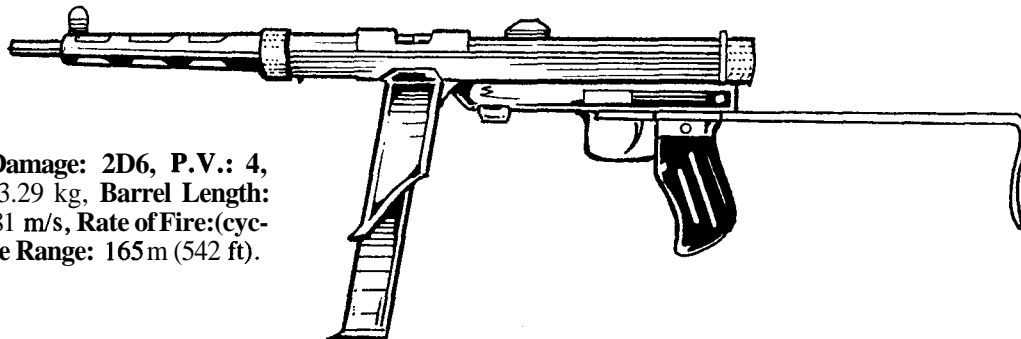

## ISRAEL

### 9mm Uzi

**Cartridge:** 9mm X 19, **Damage:** 2D6, **P.V.:** 4, **Feed:** 25 or 30 round box mag., **Weight:** 3.5 kg, **Barrel Length:** 260mm (650mm), **Muzzle Velocity:** 400 m/s, **Rate of Fire:** (cyclic) 600 rounds/min., **Approx. Effective Range:** 200 m (656 ft).

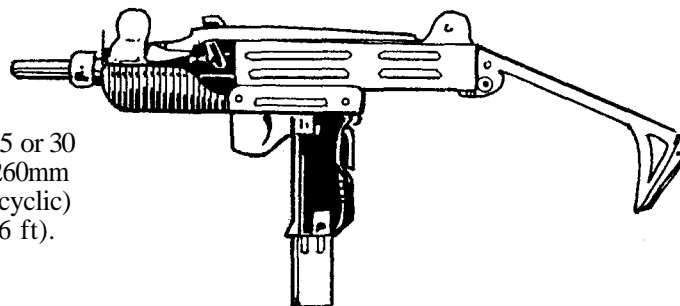

### 9mm Mini Uzi

**Cartridge:** 9mm Parabellum, **Damage:** 2D6, **P.V.:** 4, **Feed:** 20, 25 or 32 round box mag., **Weight:** 2.70 kg, **Barrel Length:** 197mm (600mm), **Muzzle Velocity:** 350 m/s, **Rate of Fire:** (cyclic) 950 rounds/min., **Approx. Effective Range:** 150m (492 ft).

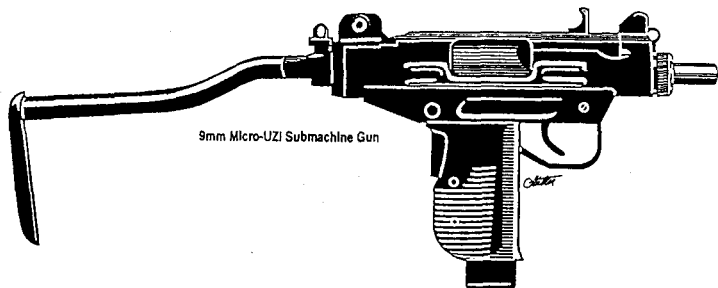

### 9mm Micro-Uzi

**Cartridge:** 9mm x 19 or .45 ACP, **Damage:** 2D6 or 4D6, **P.V.:** 4 or 5, **Feed:** 20 round box mag., **Weight:** 1.95 kg, **Barrel Length:** 117mm, **Muzzle Velocity:** 350 m/s (9mm), 240 m/s (.45 ACP), **Rate of Fire:** (cyclic) 1250 rounds/min., **Approx. Effective Range:** 200 m (656 ft).

# ITALY

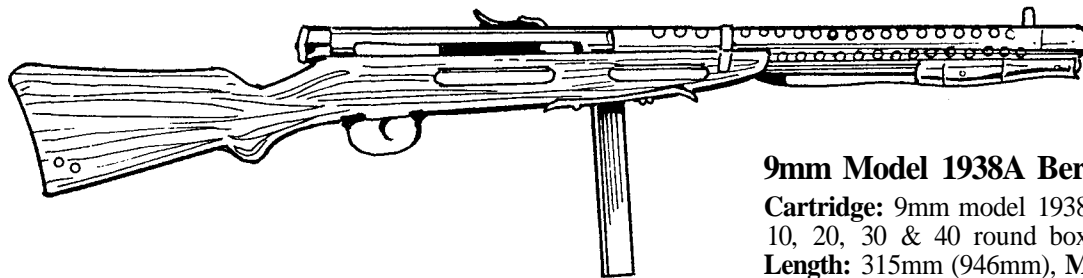

## 9mm Model 1938A Beretta (1st variant)

**Cartridge:** 9mm model 1938, **Damage:** 2D6, **P.V.:** 5, **Feed:** 10, 20, 30 & 40 round box mag., **Weight:** 4.2 kg, **Barrel Length:** 315mm (946mm), **Muzzle Velocity:** 420 m/s, **Rate of Fire:**(cyclic) 600 rounds/min., **Approx. Effective Range:** 175 m (574 ft).

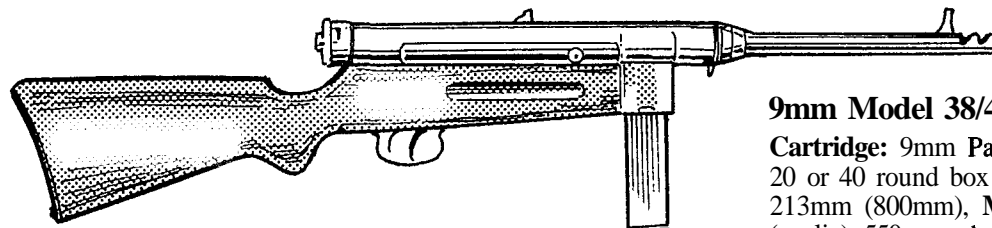

## 9mm Model 38/42 Beretta

**Cartridge:** 9mm Parabellum, **Damage:** 2D6, **P.V.:** 4, **Feed:** 20 or 40 round box mag., **Weight:** 3.27 kg, **Barrel Length:** 213mm (800mm), **Muzzle Velocity:** 381 m/s, **Rate of Fire:** (cyclic) 550 rounds/min., **Approx. Effective Range:** 200 m (656 ft).

## 9mm Model 12 Beretta

**Cartridge:** 9mm Parabellum, **Damage:** 2D6, **P.V.:** 4, **Feed:** 20, 32 or 40 round detachable box mag., **Weight:** 3 kg, **Barrel Length:** 200mm (645mm), **Muzzle Velocity:** 381 m/s, **Rate of Fire:** (cyclic) 550 rounds/min., (auto) 120 rounds/min., (single shot) 40 rounds/min., **Approx. Effective Range:** 200 m (656 ft).

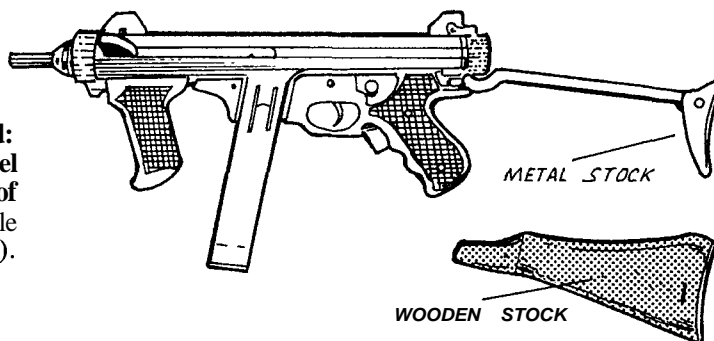

## 9mm Model 12S

**Cartridge:** 9mm×19 Parabellum, **Damage:** 2D6, **P.V.:** 4, **Feed:** 32 round detachable box mag., **Weight:** 3.2 kg, **Barrel Length:** 198mm (660mm), **Muzzle Velocity:** 381 m/s, **Rate of Fire:** (cyclic) 500-550 rounds/min., **Approx. Effective Range:** 181 m (594 ft).

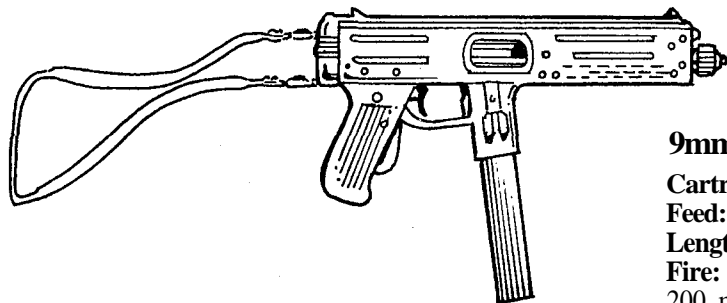

## 9mm Model LF 57 Franchi

**Cartridge:** 9mm×19 Parabellum, **Damage:** 2D6, **P.V.:** 4, **Feed:** 30 round detachable box mag., **Weight:** 4.24 kg, **Barrel Length:** 205mm (680mm), **Muzzle Velocity:** 400 m/s, **Rate of Fire:** (cyclic) 450-470 rounds/min., **Approx. Effective Range:** 200 m (656 ft).



## JAPAN

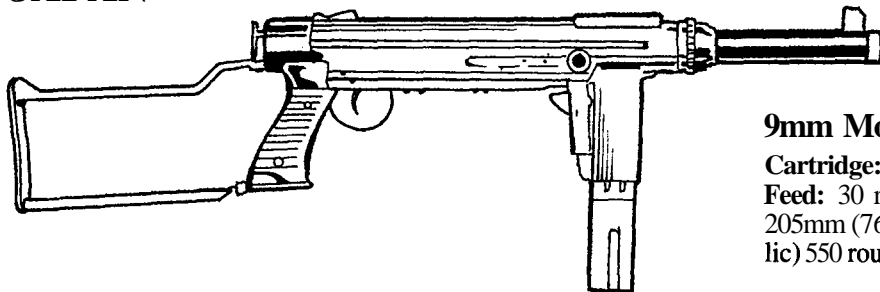

### 9mm Model 66 SCK

**Cartridge:** 9mm×19 Parabellum, **Damage:** 2D6, **P.V.:** 4, **Feed:** 30 round box mag., **Weight:** 4.08 kg, **Barrel Length:** 205mm (762mm), **Muzzle Velocity:** 360 m/s, **Rate of Fire:**(cyclic) 550 rounds/min., **Approx. Effective Range:** 195m (640 ft).

## LUXEMBOURG

### 9mm Model Super Sola

**Cartridge:** 9mm×19 Parabellum, **Damage:** 2D6, **P.V.:** 4, **Feed:** 32 round box mag., **Weight:** 2.86 kg, **Barrel Length:** 305mm (889mm), **Muzzle Velocity:** 396 m/s, **Rate of Fire:**(cyclic) 550 rounds/min., **Approx. Effective Range:** 200 m (656 ft).

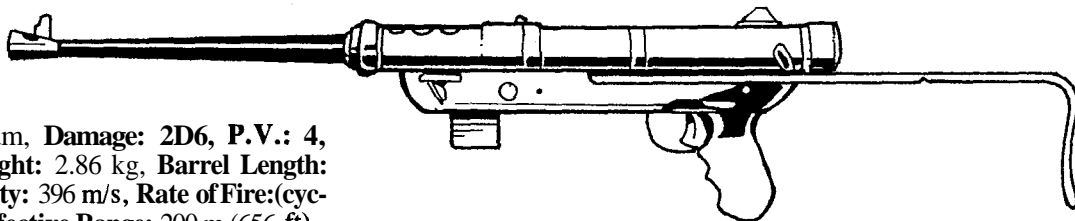

## MEXICO

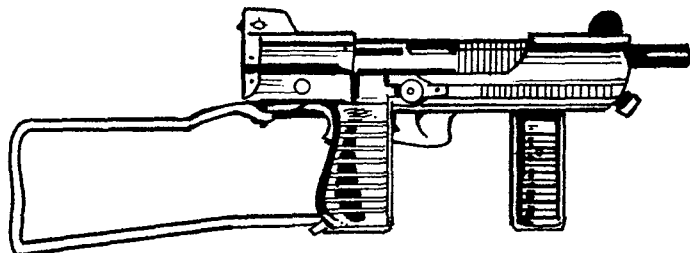

### 9mm Model HM-3

**Cartridge:** 9mm×19 Parabellum, **Damage:** 2D6, **P.V.:** 4, **Feed:** 32 round box mag., **Weight:** 2.69 kg, **Barrel Length:** 255mm (635mm), **Muzzle Velocity:** 381 m/s, **Rate of Fire:**(cyclic) 600 rounds/min., **Approx. Effective Range:** 200 m (656 ft).

## PORTUGAL

### 9mm M948 FMBP

**Cartridge:** 9mm×19 Parabellum, **Damage:** 2D6, **P.V.:** 4, **Feed:** 32 round box mag., **Weight:** 3.77 kg, **Barrel Length:** 249mm (807mm), **Muzzle Velocity:** 390 m/s, **Rate of Fire:**(cyclic) 500 rounds/min., **Approx. Effective Range:** 200 m (656 ft).

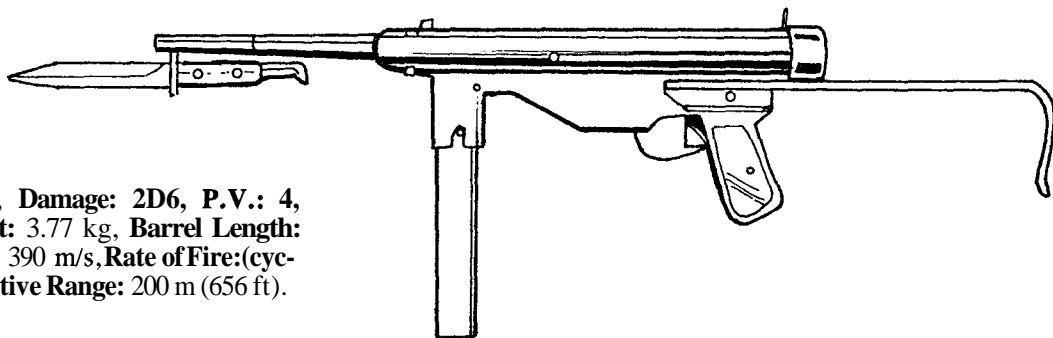

### 9mm INDEP M86

**Cartridge:** 9mm Parabellum, **Damage:** 2D6, **P.V.:** 4, **Feed:** 30 round box mag., **Weight:** 2.54 kg, **Barrel Length:** 160mm (445mm), **Muzzle Velocity:** 390 m/s, **Rate of Fire:** 900 rounds/min., **Approx. Effective Range:** 200 m (656 ft).

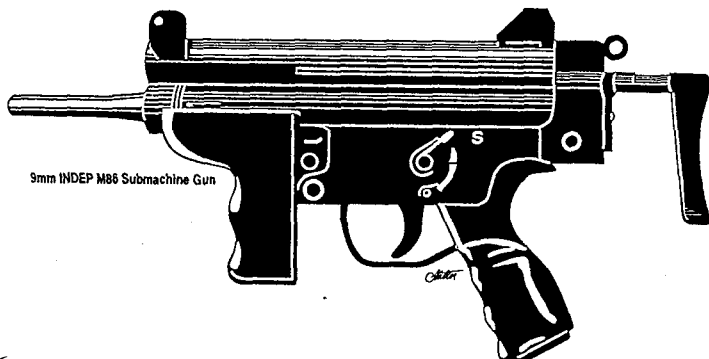

9mm INDEP M86 Submachine Gun

### 9mm M976 FMBP

**Cartridge:** 9mm Parabellum, **Damage:** 2D6, **P.V.:** 4, **Feed:** 32 or 36 double column detachable box mag., **Weight:** 3.12 kg, **Barrel Length:** 250mm (850mm), **Muzzle Velocity:** 360 m/s, **Rate of Fire:** (cyclic) 600-650 rounds/min., **Approx. Effective Range:** 200 m (656 ft).

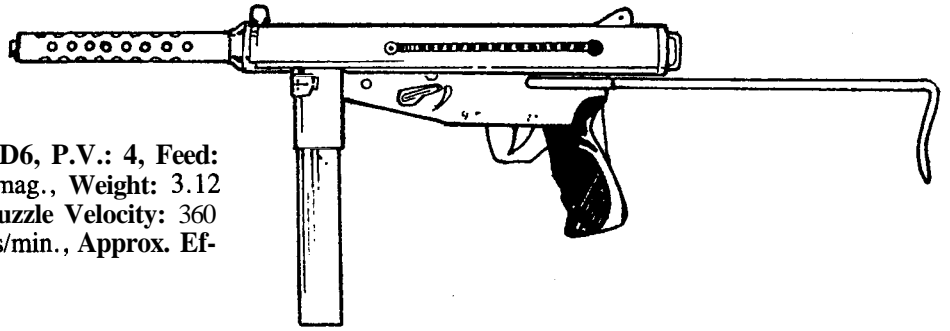

## ROMANIA

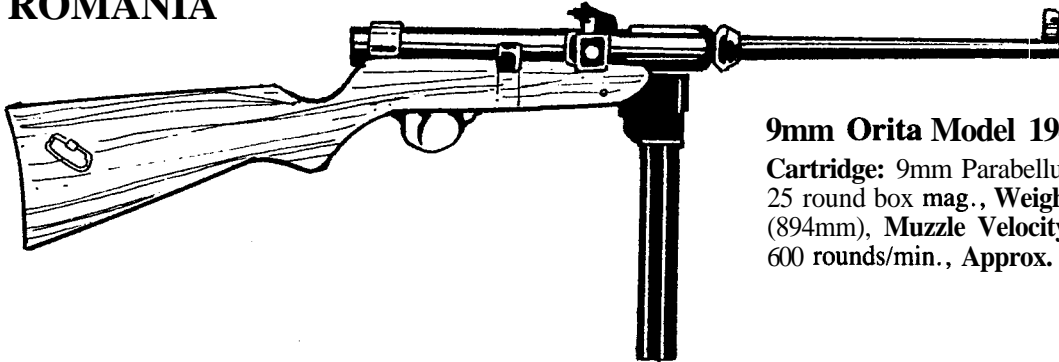

### 9mm Orita Model 1941

**Cartridge:** 9mm Parabellum, **Damage:** 2D6, **P.V.:** 4, **Feed:** 25 round box mag., **Weight:** 3.46 kg, **Barrel Length:** 287mm (894mm), **Muzzle Velocity:** 381 m/s, **Rate of Fire:** (cyclic) 600 rounds/min., **Approx. Effective Range:** 200 m (656 ft).

## SOUTH AFRICA

### 9mm SANNA 77

**Cartridge:** 9mm Parabellum, **Damage:** 2D6, **P.V.:** 4, **Feed:** 40 round box mag., **Weight:** 2.8 kg, **Barrel Length:** 289mm (650mm), **Muzzle Velocity:** 380 m/s, **Rate of Fire:** (cyclic) 550 rounds/min., **Approx. Effective Range:** 170 m (558 ft).

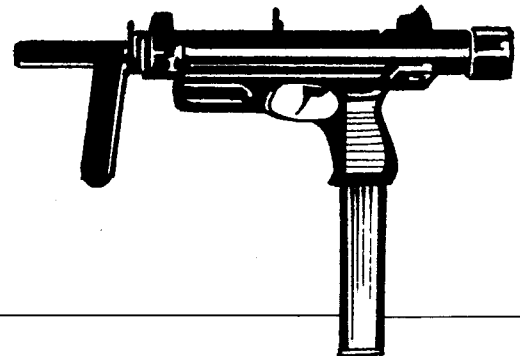

## SPAIN

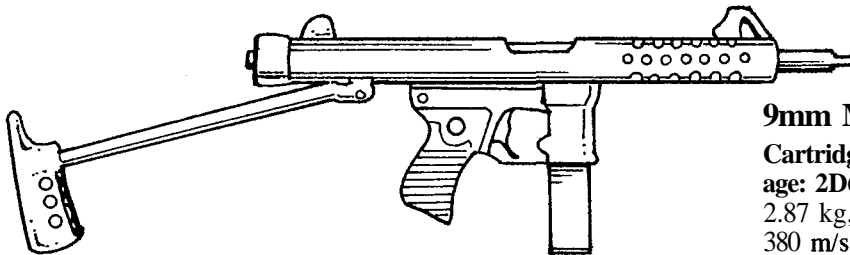

### 9mm Model Z62 Star

**Cartridge:** 9mm Bergman Bayard or 9mm Parabellum, **Damage:** 2D6, **P.V.:** 4, **Feed:** 20, 30 or 40 round box mag., **Weight:** 2.87 kg, **Barrel Length:** 201mm (701mm), **Muzzle Velocity:** 380 m/s, **Rate of Fire:** (cyclic) 550 rounds/min., **Approx. Effective Range:** 200 m (656 ft).

### 9mm C2

**Cartridge:** 9mm Parabellum or 9mm Largo, **Damage:** 2D6, **P.V.:** 4, **Feed:** 32 round detachable box mag., **Weight:** 2.87 kg, **Barrel Length:** 212mm (720mm), **Muzzle Velocity:** 325 m/s, **Rate of Fire:** (cyclic) 600 rounds/min., **Approx. Effective Range:** 200 m (656 ft).

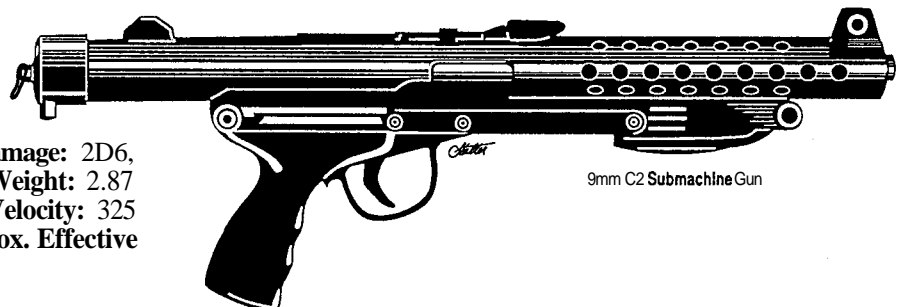

9mm C2 Submachine Gun

## SWEDEN

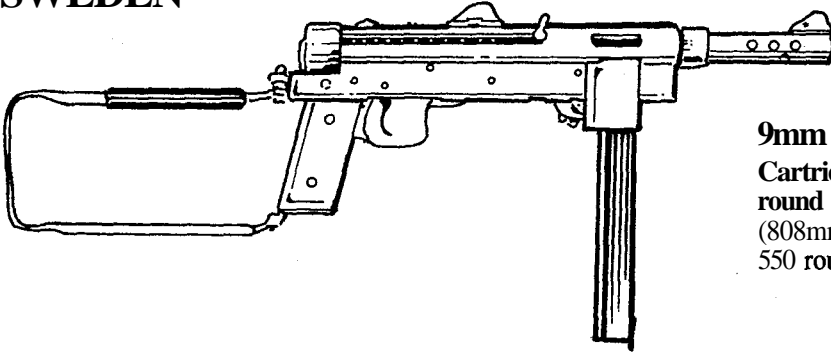

### 9mm Model 45

**Cartridge:** 9mm M39B, **Damage:** 2D6, **P.V.:** 4, **Feed:** 36 round box mag., **Weight:** 4.2 kg, **Barrel Length:** 213mm (808mm), **Muzzle Velocity:** 365 m/s, **Rate of Fire:** (cyclic) 550 rounds/min., **Approx. Effective Range:** 189 m (620 ft).

## SWITZERLAND

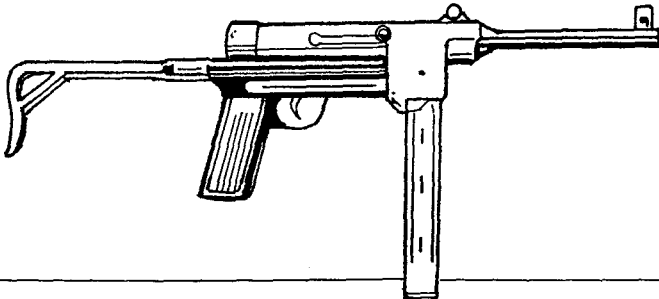

### MP310 SIG

**Cartridge:** 9mm×19 Parabellum, **Damage:** 2D6, **P.V.:** 4, **Feed:** 33 round folding box mag., **Weight:** 3.15 kg, **Barrel Length:** 200mm (735mm), **Muzzle Velocity:** 365 m/s, **Rate of Fire:** (cyclic) 900 rounds/min., **Approx. Effective Range:** 200 m (656 ft).

## TURKEY

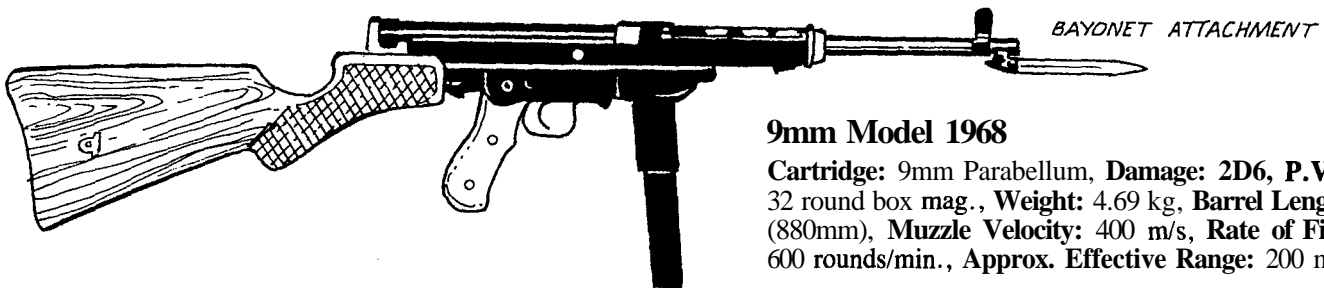

### 9mm Model 1968

**Cartridge:** 9mm Parabellum, **Damage:** 2D6, **P.V.:** 4, **Feed:** 32 round box mag., **Weight:** 4.69 kg, **Barrel Length:** 350mm (880mm), **Muzzle Velocity:** 400 m/s, **Rate of Fire:** (cyclic) 600 rounds/min., **Approx. Effective Range:** 200 m (656 ft).

## The Old U.S.S.R.

### 7.62mm pps43

**Cartridge:** 7.62mm×25 Type P pistol, **Damage:** 1D8, **P.V.:** 2, **Feed:** 32 round box mag., **Weight:** 3.36 kg, **Barrel Length:** 250mm (820mm), **Muzzle Velocity:** 500 m/s, **Rate of Fire:** (cyclic) 650 rounds/min., **Approx. Effective Range:** 200 m (656 ft).

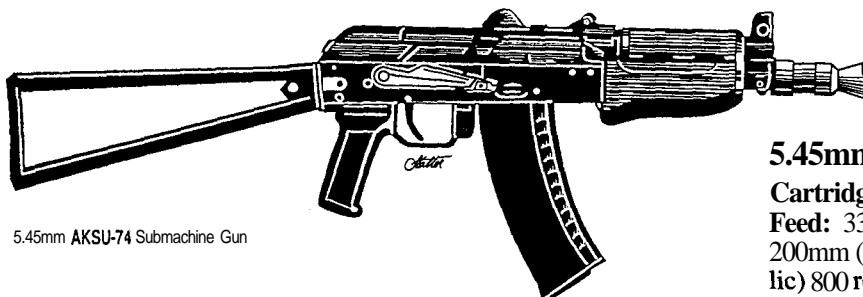
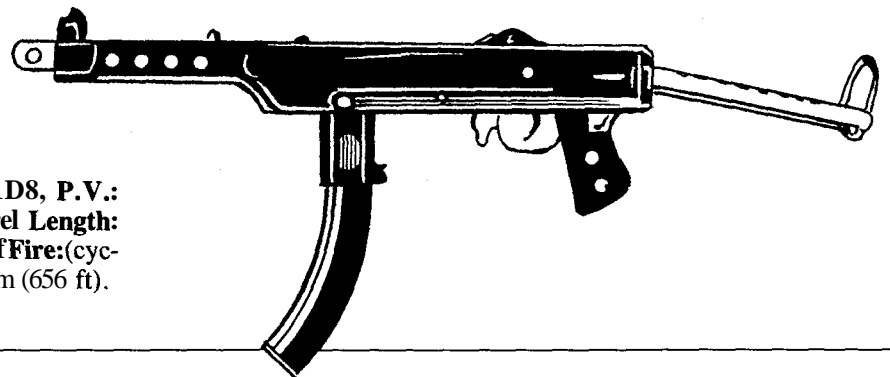

### 5.45mm AKSU74

**Cartridge:** 5.45mm×39.5 Soviet, **Damage:** 1D6, **P.V.:** 2, **Feed:** 33 round box mag., **Weight:** 3.93 kg, **Barrel Length:** 200mm (675mm), **Muzzle Velocity:** 800 m/s, **Rate of Fire:** (cyclic) 800 rounds/min., **Approx. Effective Range:** 200 m (656 ft).

5.45mm AKSU-74 Submachine Gun

## UNITED KINGDOM

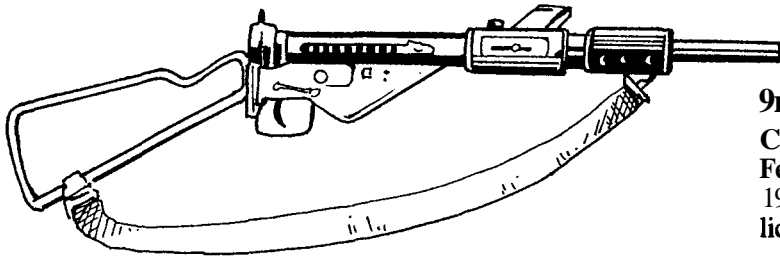

### 9mm Sten MKII

**Cartridge:** 9mm × 19 Parabellum, **Damage:** 2D6, **P.V.:** 4, **Feed:** 32 round box mag., **Weight:** 2.8 kg, **Barrel Length:** 197mm (762mm), **Muzzle Velocity:** 366 m/s, **Rate of Fire:**(cyclic) 550 rounds/min., **Approx. Effective Range:** 195m (640 ft).

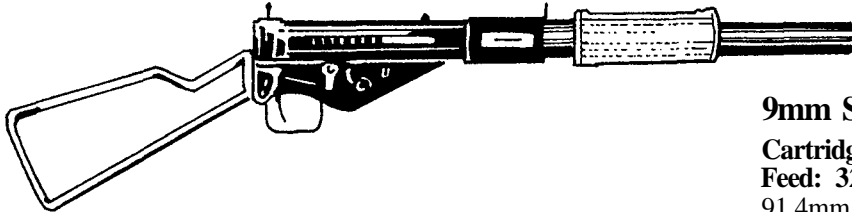

### 9mm Sten MK IIS

**Cartridge:** 9mm × 19 Parabellum, **Damage:** 2D6, **P.V.:** 4, **Feed:** 32 round box mag., **Weight:** 3.5 kg, **Barrel Length:** 91.4mm (857mm), **Muzzle Velocity:** 305 m/s, **Rate of Fire:**(cyclic) 550 rounds/min., **Approx. Effective Range:** 200 m (656 ft).

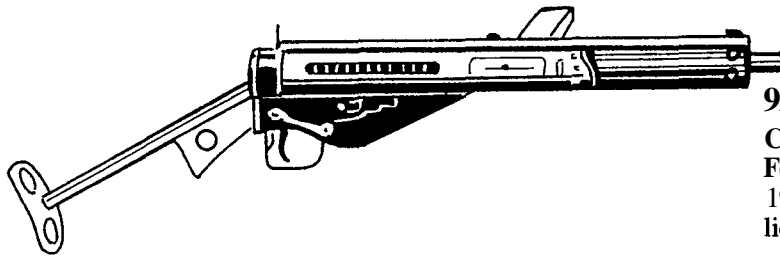

### 9mm Sten MK III

**Cartridge:** 9mm x 19 Parabellum, **Damage:** 2D6, **P.V.:** 4, **Feed:** 32 round box mag., **Weight:** 3.18 kg, **Barrel Length:** 197mm (762mm), **Muzzle Velocity:** 366 m/s, **Rate of Fire:**(cyclic) 550 rounds/min., **Approx. Effective Range:** 200 m (656 ft).

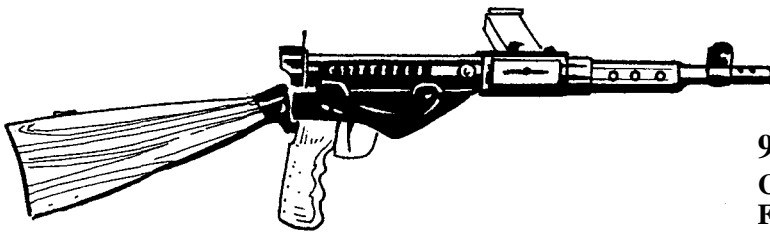

### 9mm Sten MK V

**Cartridge:** 9mm × 19 Parabellum, **Damage:** 2D6, **P.V.:** 4, **Feed:** 32 round box mag., **Weight:** 3.9 kg, **Barrel Length:** 198mm (762mm), **Muzzle Velocity:** 366 m/s, **Rate of Fire:**(cyclic) 550 rounds/min., **Approx. Effective Range:** 200 m (656 ft).

### 9mm L2A3 Sterling

**Cartridge:** 9mm × 19 Parabellum, **Damage:** 2D6, **P.V.:** 4, **Feed:** 34 round box mag., **Weight:** 2.72 kg, **Barrel Length:** 198mm (690mm), **Muzzle Velocity:** 390 m/s, **Rate of Fire:**(cyclic) 550 rounds/min., **Approx. Effective Range:** 180 m (590 ft).

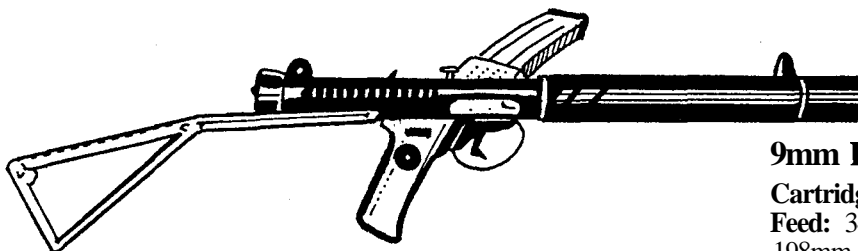

### 9mm L34A1 Sterling MK5

**Cartridge:** 9mm × 19 Parabellum, **Damage:** 2D6, **P.V.:** 4, **Feed:** 34 round box mag., **Weight:** 3.6 kg, **Barrel Length:** 198mm (864mm), **Muzzle Velocity:** 293-310m/s, **Rate of Fire:**(cyclic) 515-560 rounds/min., **Approx. Effective Range:** 200 m (656 ft).

## UNITED STATES

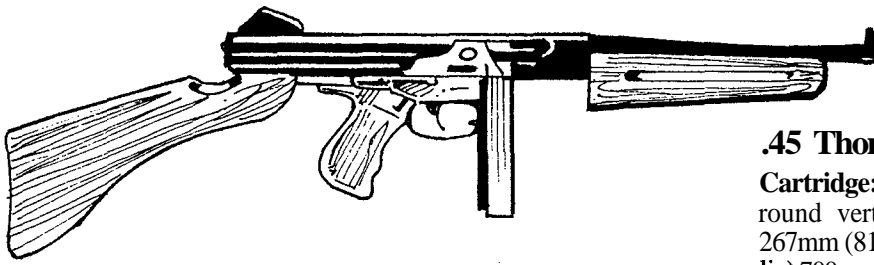

### .45 Thompson M1

**Cartridge:** .45 ACP, **Damage:** 4D6, **P.V.:** 4, **Feed:** 20 or 30 round vertical box mag., **Weight:** 4.8 kg, **Barrel Length:** 267mm (810mm), **Muzzle Velocity:** 282 m/s, **Rate of Fire:** (cyclic) 700 rounds/min., **Approx. Effective Range:** 200 m (656 ft).

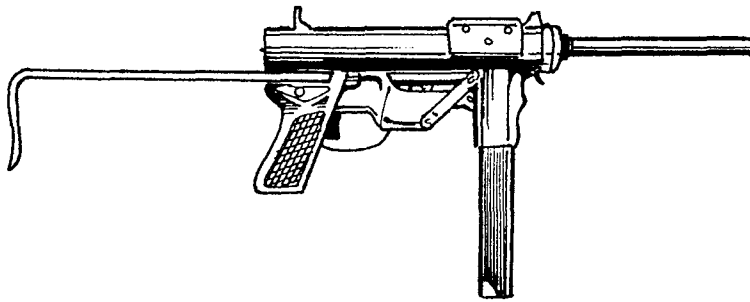

### .45 M3

**Cartridge:** .45 ACP, **Damage:** 4D6, **P.V.:** 4, **Feed:** 30 round box mag., **Weight:** 3.63 kg, **Barrel Length:** 203mm (757mm), **Muzzle Velocity:** 280 m/s, **Rate of Fire:** (cyclic) 450 rounds/min., **Approx. Effective Range:** 188 m (616 ft).

### Ingram Model 10

**Cartridge:** .45 ACP, **Damage:** 4D6, **P.V.:** 5, **Feed:** 30 round box mag., **Weight:** 2.84 kg, **Barrel Length:** 146mm (548mm), **Muzzle Velocity:** 280 m/s, **Rate of Fire:** (cyclic) 11-45 rounds/min., **Approx. Effective Range:** 200 m (656 ft).

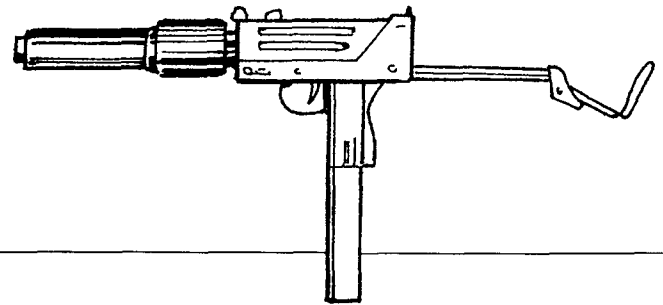

### 9mm Viking

**Cartridge:** 9mm×19 Parabellum, **Damage:** 2D6, **P.V.:** 4, **Feed:** 36 round box mag., **Weight:** 3.52 kg, **Barrel Length:** 216mm (584mm), **Muzzle Velocity:** 400 m/s, **Rate of Fire:** (cyclic) 700-800 rounds/min., **Approx. Effective Range:** 180 m (607 ft).

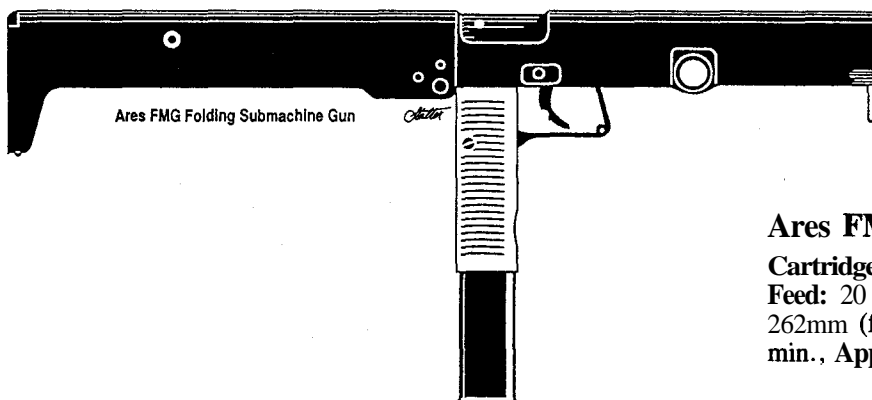
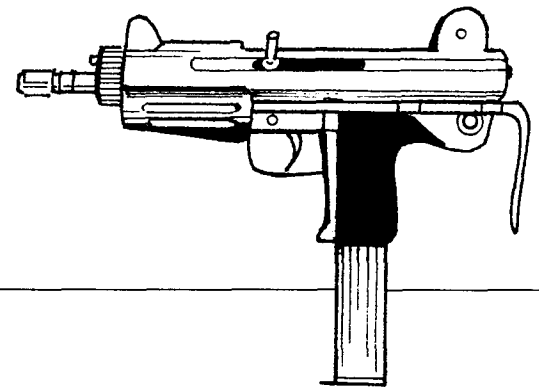

### Ares FMG Folding Sub-Machinegun

**Cartridge:** 9mm×19 Parabellum, **Damage:** 2D6, **P.V.:** 4, **Feed:** 20 or 32 round box mag., **Weight:** 2.38 kg, **Length:** 262mm (folded), 503mm (opened), **Rate of Fire:** 650 rounds/min., **Approx. Effective Range:** 150 m (492 ft).

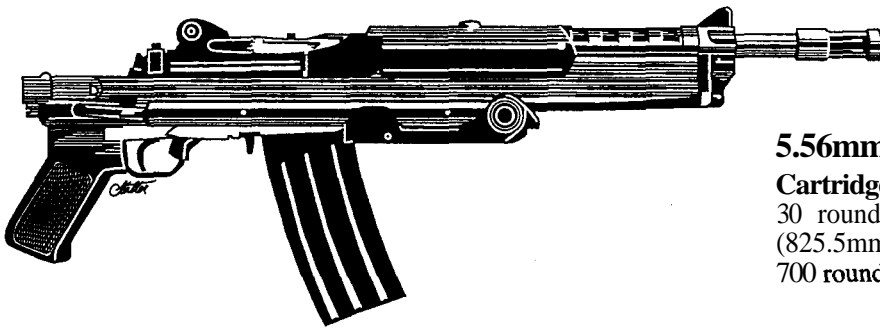

### 5.56mm Ruger AC556F

**Cartridge:** 5.56mm×45, **Damage:** 1D6, **P.V.:** 2, **Feed:** 20 or 30 round mag., **Weight:** 3.5 kg, **Barrel Length:** 292mm (825.5mm), **Muzzle Velocity:** 381 m/s, **Rate of Fire:** (cyclic) 700 rounds/min., **Approx. Effective Range:** 200 m (656 ft).

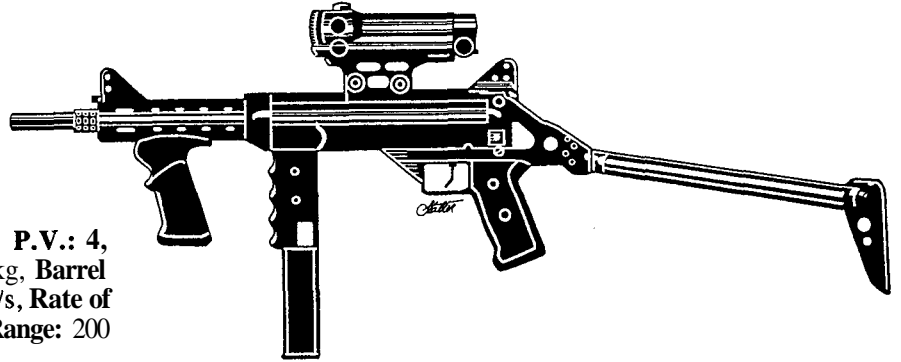

### 9mm Weaver PKS9 Ultralite

**Cartridge:** 9mm×19 Parabellum, **Damage:** 2D6, **P.V.:** 4, **Feed:** 25, 30 or 42 round box mag., **Weight:** 2.77 kg, **Barrel Length:** 181mm (416mm), **Muzzle Velocity:** 385 m/s, **Rate of Fire:** (cyclic) 600 rounds/min., **Approx. Effective Range:** 200 m (656 ft).

### KFAMP Assault Machine Pistol

**Cartridge:** 9mm×19 Parabellum, **Damage:** 2D6, **P.V.:** 4, **Feed:** 20, 36, 60 or 108 round box mag., **Weight:** 2.65 kg, **Barrel Length:** 76.2mm (603mm), **Muzzle Velocity:** 360 m/s, **Rate of Fire:** 800 rounds/min., **Approx. Effective Range:** 200 m (656 ft).

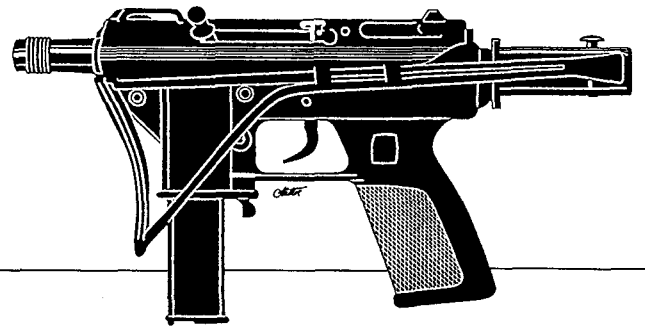

## VIETNAM

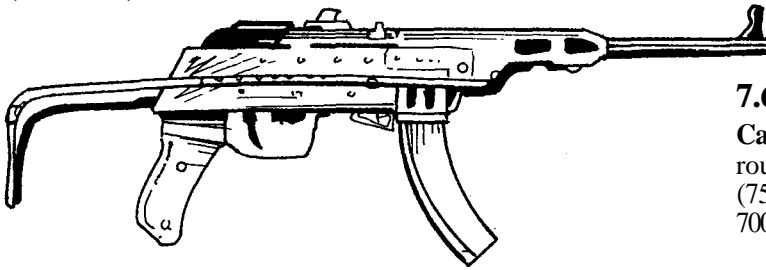

### 7.62mm K-50 Modified

**Cartridge:** 7.62mm Mauser, **Damage:** 1D8, **P.V.:** 2, **Feed:** 35 round box mag., **Weight:** 3.44 kg, **Barrel Length:** 269mm (756mm), **Muzzle Velocity:** 488 m/s, **Rate of Fire:** (cyclic) 700 rounds/min., **Approx. Effective Range:** 200 m (656 ft).

## YUGOSLAVIA

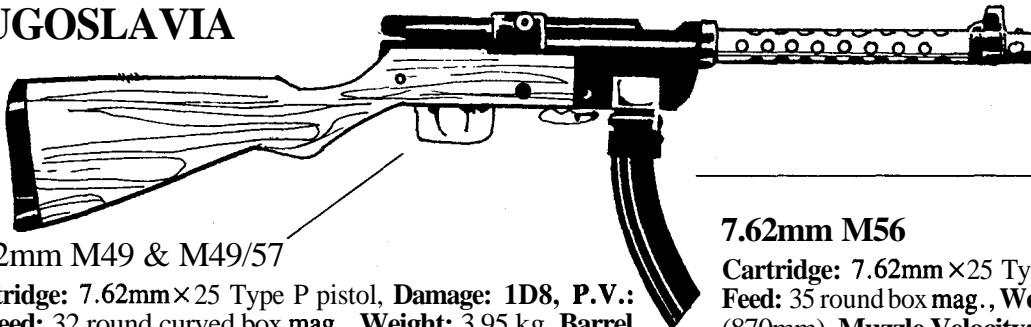

### 7.62mm M49 & M49/57

**Cartridge:** 7.62mm×25 Type P pistol, **Damage:** 1D8, **P.V.:** 2, **Feed:** 32 round curved box mag., **Weight:** 3.95 kg, **Barrel Length:** 273mm (870mm), **Muzzle Velocity:** 500 m/s, **Rate of Fire:** (cyclic) 700 rounds/min., **Approx. Effective Range:** 200 m (656 ft).

### 7.62mm M56

**Cartridge:** 7.62mm×25 Type Pistol, **Damage:** 1D8, **P.V.:** 2, **Feed:** 35 round box mag., **Weight:** 3 kg, **Barrel Length:** 250mm (870mm), **Muzzle Velocity:** 500 m/s, **Rate of Fire:** (cyclic) 600 rounds/min., **Approx. Effective Range:** 200 m (656 ft).

---

# Machine Guns

---

## Light Machine Guns

The light machine gun differs from rifles and machine rifles in that, first, the barrel is changeable. The gunner only has to release a latch or lock and he can change a hot barrel for a cool one in approximately 20 to 30 seconds. Second, the gun has a bipod to aid in supporting the weapon when firing a **burst**. **Third**, it uses the same ammunition as rifles, although some light machine guns are belt fed. Belts of ammunition cannot be made in the field, either you have a belt or you do not. Consequently, the use of box magazines is more effective and widely used.

Light machine guns are usually manned by two people. One carries the weapon, the other carries the ammunition. The number two man also helps load the gun and functions as an observer. The majority of light machine guns weigh roughly twice as much as a rifle of the same caliber. P.V. 5, 5D6 damage.

## General Purpose Machine Guns

A general purpose machine gun falls somewhere between a light and medium machine gun. It can be carried like the light machine gun or it can be mounted on a tripod. To accommodate these two functions it has to be belt fed and is reasonably **heavy**.

Problems with the general purpose machine gun have risen in the **past**. Many have found it too heavy to be a light machine gun and too light to be a medium machine gun. The problem of lightweight caliber was solved by equipping it with a heavier

**barrel**. Of course this meant more heavy equipment to transport. P.V. 5-6, 6D6 damage.

## Medium Machine Gun

Medium machine guns were deployed tactically as a separate support section with their own sub-unit control. The ammunition fired from these guns was the same used in rifles and light machine **guns**, though some variations for long-range fire were used. The ideas for using medium machine guns were to employ them in pairs or larger numbers for heavy **firepower**. However, it was found that more effective firepower could come from the guns on armored personnel carriers and similar armored **vehicles**. P.V. 6-7, 6D6 damage.

## Heavy Machine Gun

Heavy machine guns are those which fire ammunition larger than standard rifle size. The most popular being 12.7 mm and .50 caliber. Many heavy machine guns are vehicle mounted, though there are many used on ground mounts. Still others are used as anti-aircraft and fitted on different **mounts**. The general use for heavy machine guns is to provide larger caliber fire, with greater hitting power. The line between heavy machine gun and cannon is tested when explosive ammo is used. However, generally a heavy machine gun is said to be less than 20mm in caliber and designed to fire solid bullets rather than small shells. P.V. 7 + , 1D4 × 10 + 10 to 1D6 × 10 + 6 damage.

---

## AUSTRIA

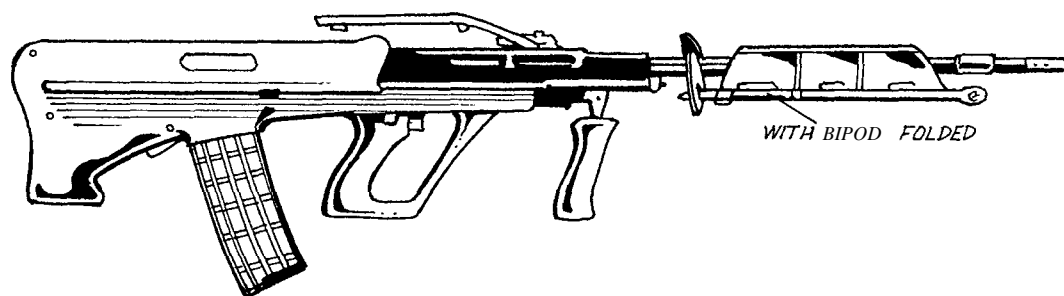

### 5.56mm Steyr Army Universal Gun Light Machine Gun Version

**Cartridge:** 5.56mm × 45, **Feed:** 30 or 40 round box mag., **Weight:** 4.9 kg, **Barrel Length:** 621mm, **Muzzle Velocity:** 1000 m/s, **Approx. Effective Range:** 1000 m (3280 ft), **Rate of Fire:** (cyclic) 680 rounds per minute, **P.V.:** 5, **Damage:** 5D6.

## BELGIUM

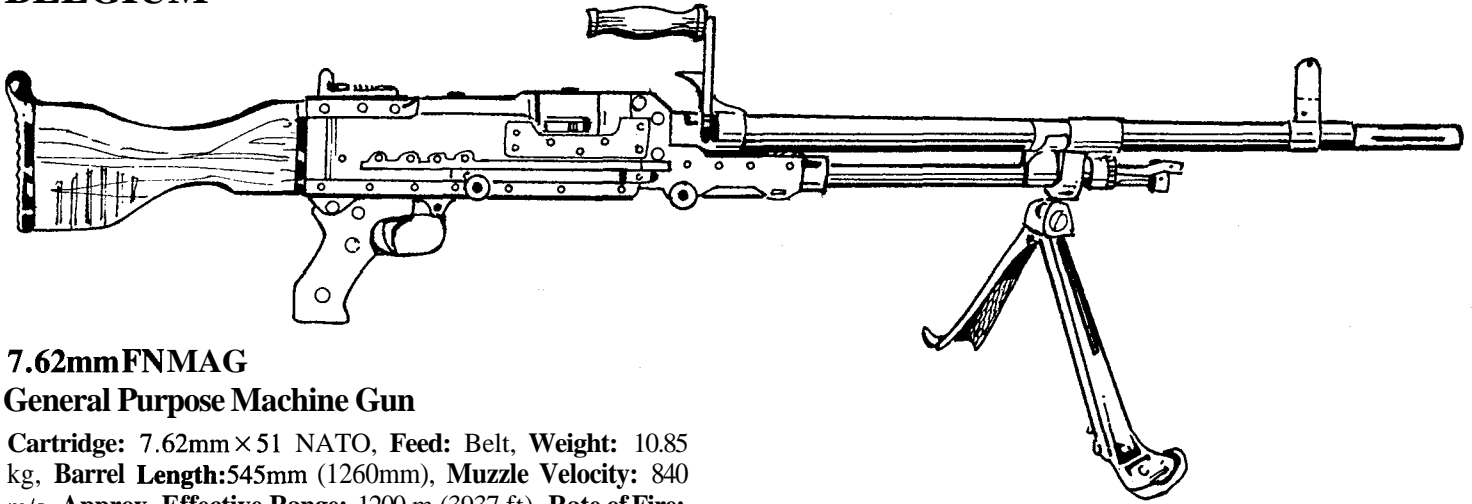

### 7.62mm FN MAG

#### General Purpose Machine Gun

**Cartridge:** 7.62mm×51 NATO, **Feed:** Belt, **Weight:** 10.85 kg, **Barrel Length:** 545mm (1260mm), **Muzzle Velocity:** 840 m/s, **Approx. Effective Range:** 1200 m (3937 ft), **Rate of Fire:** (cyclic) 600-1000 rounds per minute, **P.V.:** 6, **Damage:** 6D6.

## CHINA

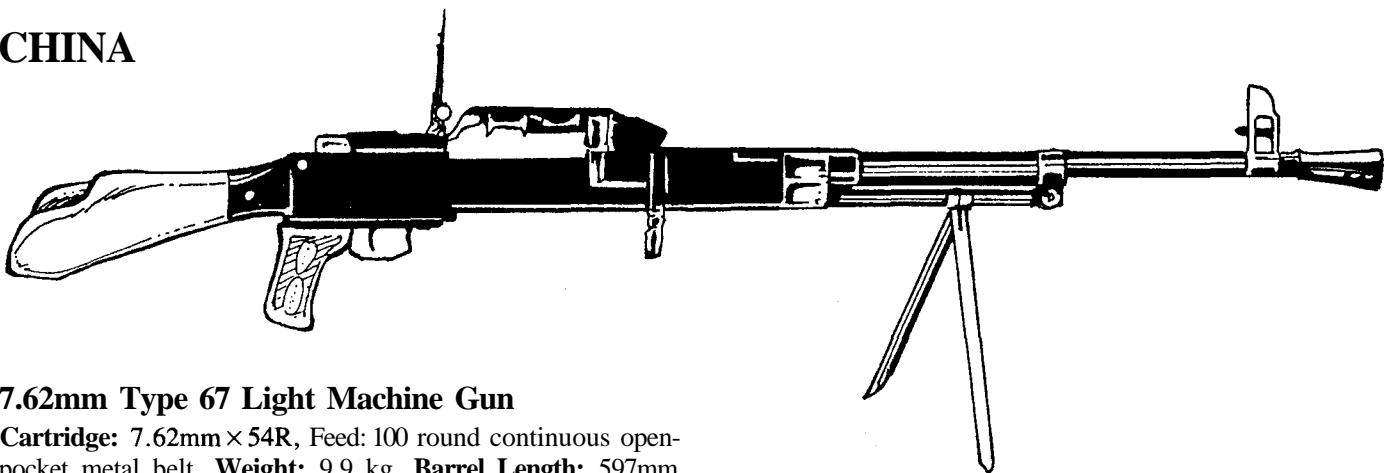

### 7.62mm Type 67 Light Machine Gun

**Cartridge:** 7.62mm×54R, **Feed:** 100 round continuous open-pocket metal belt, **Weight:** 9.9 kg, **Barrel Length:** 597mm (1143mm), **Muzzle Velocity:** 835 m/s, **Approx. Effective Range:** 800 m (2625 ft), **Rate of Fire:** (cyclic) 650 rounds per minute, **P.V.:** 6, **Damage:** 6D6.

### 12.7mm Anti-Aircraft Machine Gun Type 77 & W-85

**Cartridge:** 12.7mm×107, **Feed:** 60 round belt, **Weight:** 35.7 kg, **Barrel Length:** 1070mm (1588mm), **Muzzle Velocity:** 800 m/s, **Approx. Effective Range:** 1600 m (5250 ft), **Rate of Fire:** (cyclic) 650-750, rounds per minute, **P.V.:** 7+, **Damage:** 1D4×10+16.

### 7.92mm Model 37 Medium Machine Gun

**Cartridge:** 7.92mm×57, **Feed:** Continuous open-pocket belt, **Weight:** 18.8 kg, **Barrel Length:** 678mm (1105mm), **Muzzle Velocity:** 793 m/s, **Approx. Effective Range:** 1000 m (3280 ft), **Rate of Fire:** (cyclic) 650 rounds per minute, **P.V.:** 6, **Damage:** 5D10 or 1D4×10+10.

### 14.5mm Anti-Aircraft Machine Gun Type 75

**Cartridge:** 14.5mm, **Feed:** 80 round link belt, **Weight:** 165 kg (with mount), **Barrel Length:** 2.39 m, **Muzzle Velocity:** 995 m/s, **Approx. Effective Range:** 2000 m (6562 ft), **Rate of Fire:** (cyclic) 550 rounds per minute, **P.V.:** 7+, **Damage:** 1D6×10+6.



## CZECHOSLOVAKIA

---

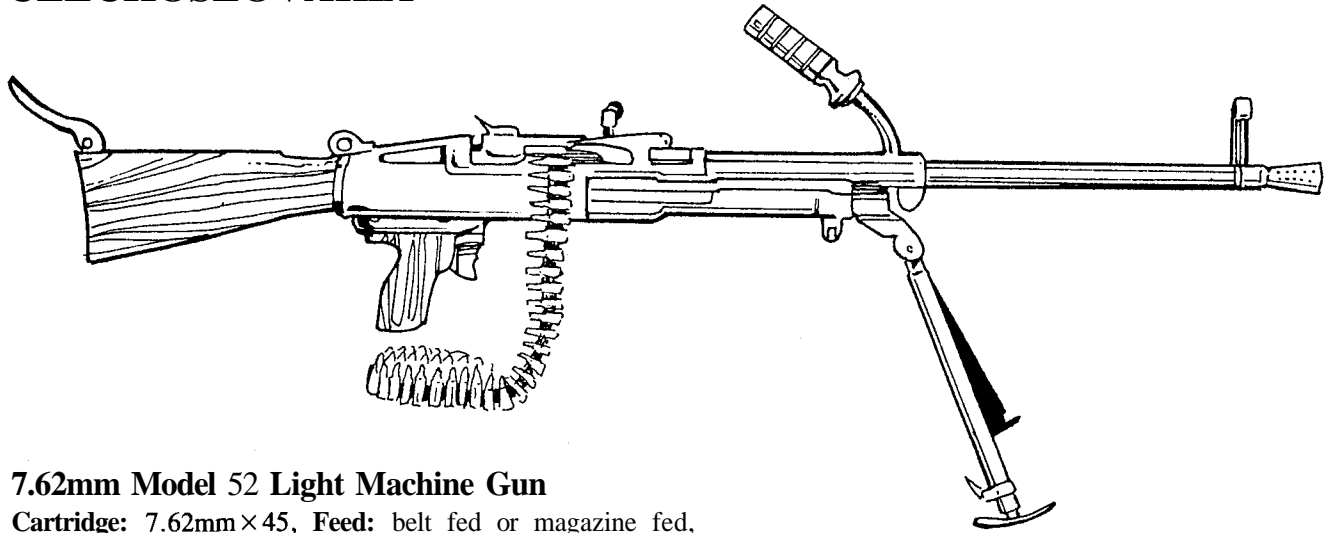

### 7.62mm Model 52 Light Machine Gun

**Cartridge:** 7.62mm×45, **Feed:** belt fed or magazine fed, **Weight:** 8 kg, **Barrel Length:** 581mm (1041mm), **Muzzle Velocity:** 755 m/s, **Approx. Effective Range:** 1000 m (3280 ft), **Rate of Fire:** (cyclic) 1200 rounds per minute belt fed or 900 magazine fed, **P.V.:** 5, **Damage:** 6D6.

## DENMARK

---

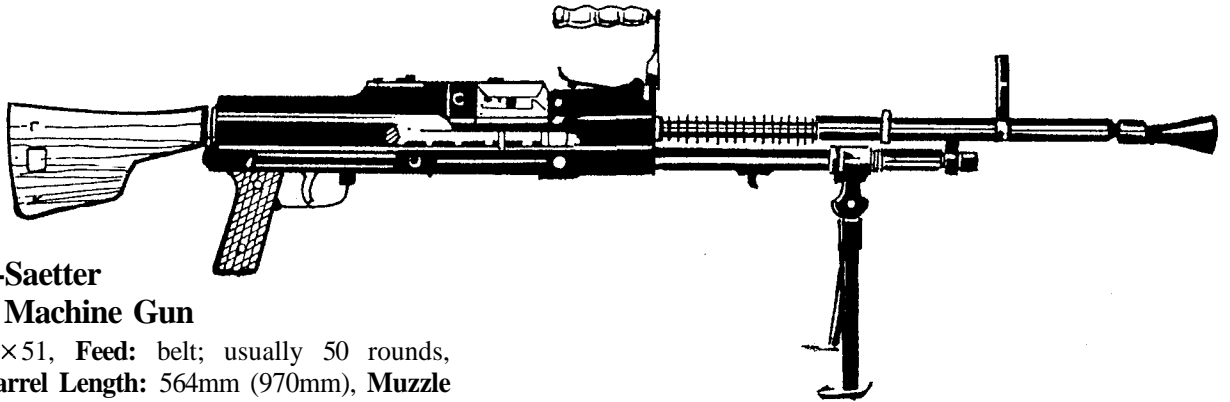

### 7.62mm Madsen-Saetter General Purpose Machine Gun

**Cartridge:** 7.62mm×51, **Feed:** belt; usually 50 rounds, **Weight:** 10.1 kg, **Barrel Length:** 564mm (970mm), **Muzzle Velocity:** 750 m/s, **Approx. Effective Range:** 800 m (2625 ft), **Rate of Fire:** (cyclic) 750 rounds per minute (auto), **P.V.:** 6, **Damage:** 6D6.

## FINLAND

---

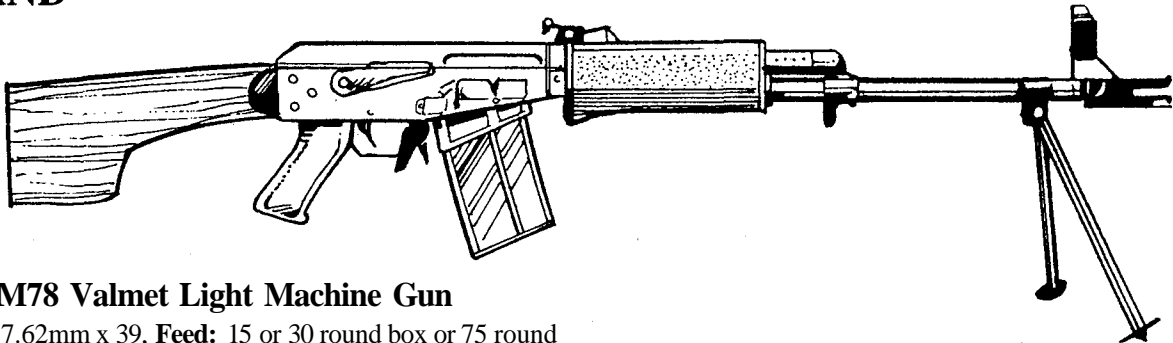

### 7.62mm M78 Valmet Light Machine Gun

**Cartridge:** 7.62mm x 39, **Feed:** 15 or 30 round box or 75 round drum mag., **Weight:** 4.7 kg, **Barrel Length:** 500mm (1060mm), **Muzzle Velocity:** 719 m/s, **Approx. Effective Range:** 1000 m (3280 ft), **Rate of Fire:** (cyclic) 650 rounds per minute, **P.V.:** 5, **Damage:** 6D6.

## FRANCE

---

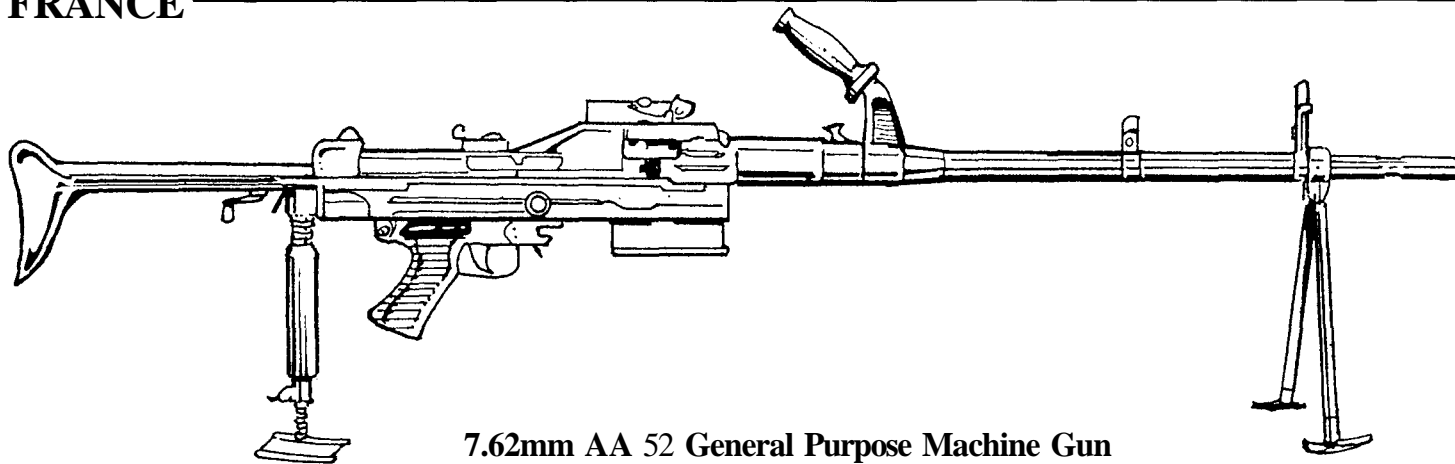

### 7.62mm AA 52 General Purpose Machine Gun

**Cartridge:** 7.5mm M/29, **Feed:** disintegrating link belt, **Weight:** 9.15 kg, **Barrel Length:** 500mm (1145mm), **Muzzle Velocity:** 840 m/s, **Approx. Effective Range:** 800 m (2625 ft), **Rate of Fire:** (cyclic) 700 rounds per minute, **P.V.:** 6, **Damage:** 6D6.

## GERMANY, FEDERAL REPUBLIC

---

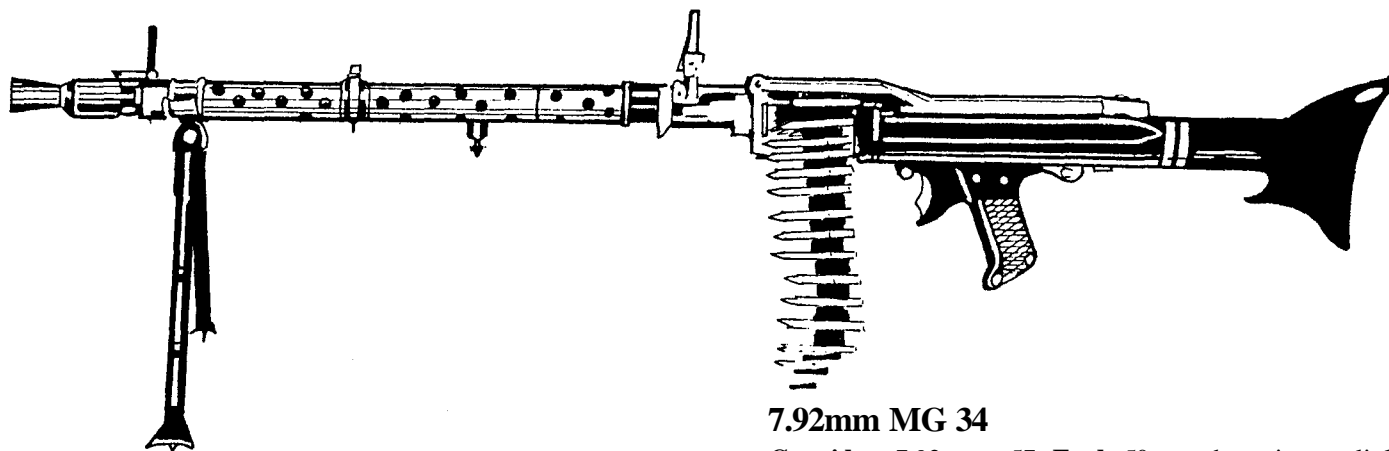

### 7.92mm MG 34

**Cartridge:** 7.92mm x 57, **Feed:** 50 round continuous link belt, **Weight:** 12 kg, **Barrel Length:** 629mm (1224mm), **Muzzle Velocity:** 755 m/s, **Approx. Effective Range:** 1800 m (5905 ft; tripod), **Rate of Fire:** (cyclic) 900 rounds per minute, **P.V.:** 6, **Damage:** 1D4 x 10 + 10.

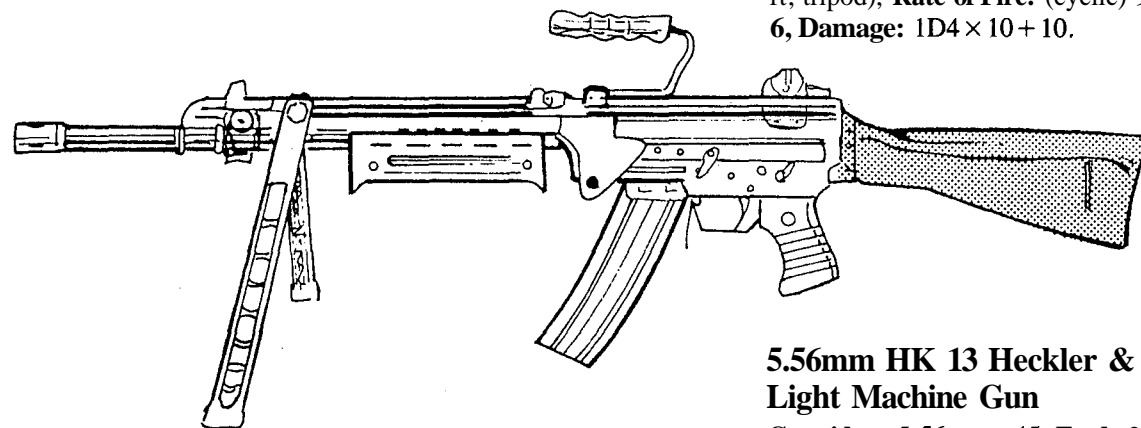

### 5.56mm HK 13 Heckler & Koch Light Machine Gun

**Cartridge:** 5.56mm x 45, **Feed:** 25 round box mag., **Weight:** 5.4 kg, **Barrel Length:** 450mm (980mm), **Muzzle Velocity:** 950 m/s, **Approx. Effective Range:** 400 m (1312 ft), **Rate of Fire:** (cyclic) 750 rounds per minute, **P.V.:** 5, **Damage:** 5D6.

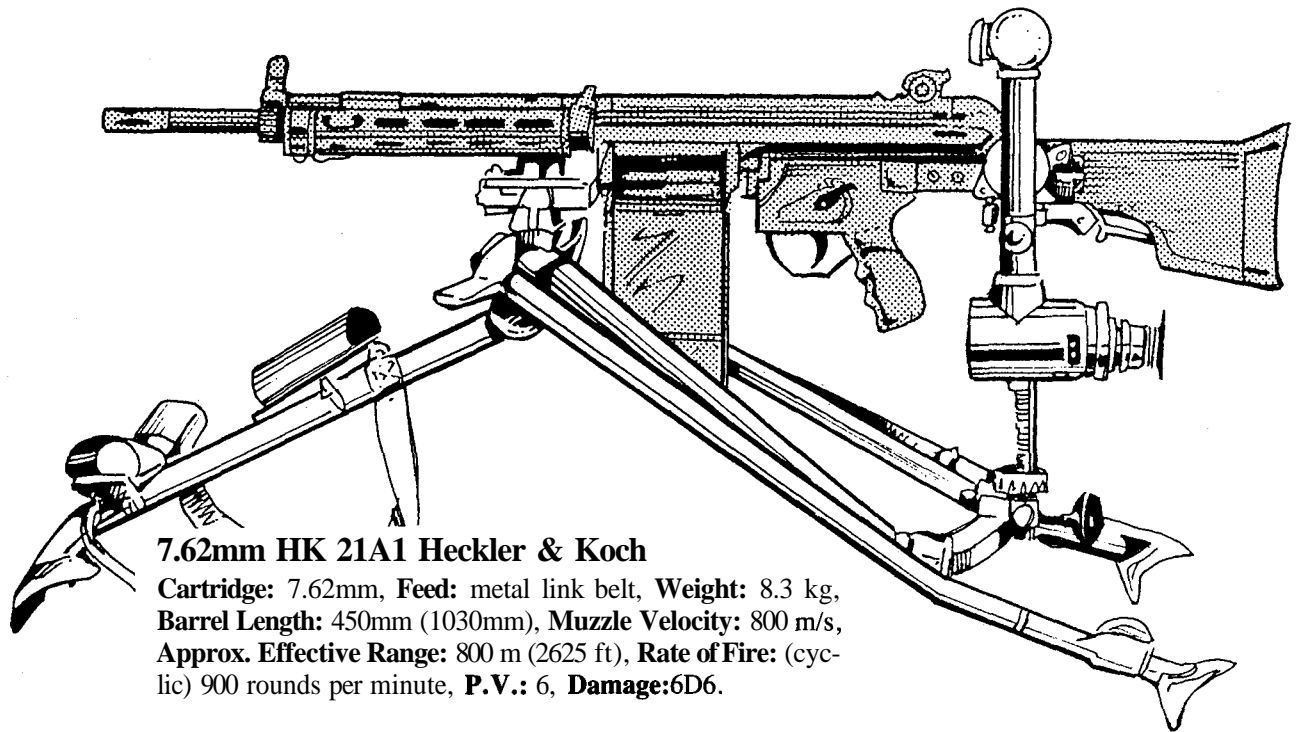

**7.62mm HK 21A1 Heckler & Koch**

**Cartridge:** 7.62mm, **Feed:** metal link belt, **Weight:** 8.3 kg, **Barrel Length:** 450mm (1030mm), **Muzzle Velocity:** 800 m/s, **Approx. Effective Range:** 800 m (2625 ft), **Rate of Fire:** (cyclic) 900 rounds per minute, **P.V.:** 6, **Damage:**6D6.

**ITALY**

**5.56mm Model 70-78 Beretta Light Machine Gun**

**Cartridge:** 5.56mm×45, **Feed:** 40 round box mag., **Weight:** 5.3 kg, **Barrel Length:** 450mm (955mm), **Muzzle Velocity:** 970 m/s, **Approx. Effective Range:** 500 m (1640 ft), **Rate of Fire:** (cyclic) 670 rounds per minute, **P.V.:** 5, **Damage:** 5D6.

**JAPAN**

**7.62mm Model 62**

**Cartridge:** 7.62mm×51, **Feed:** disintegrating link belt, **Weight:** 10.7 kg, **Barrel Length:** 524mm (1200mm), **Muzzle Velocity:** 855 m/s, **Approx. Effective Range:** 800 m (2625 ft), **Rate of Fire:** (cyclic) 600 rounds per minute, **P.V.:** 6, **Damage:** 6D6.

**MEXICO**

**.30 RM2 Mendoza Machine Gun**

**Cartridge:** 30-06, **Feed:** 20 or 32 round detachable box mag., **Weight:** 6.4 kg, **Barrel Length:** 610mm (1100mm), **Muzzle Velocity:** 800 m/s, **Approx. Effective Range:** 400 m (1312 ft), **Rate of Fire:** (cyclic) 450-650 rounds per minute, **P.V.:** 5, **Damage:** 4D6.

**SPAIN**

**5.56mm CETME Ameli Light Machine Gun**

**Cartridge:** 5.56mm×45, **Feed:** disintegrating link belt or 200 round box mag., **Weight:** 6.7 kg, **Barrel Length:** 400mm (930mm), **Muzzle Velocity:** 910 m/s, **Approx. Effective Range:** 1650 m (5413 ft), **Rate of Fire:** (cyclic) 900-1250 rounds per minute, **P.V.:** 5, **Damage:** 5D6.

**SWITZERLAND**

**7.62mm SIG 710-3 General Purpose Machine Gun**

**Cartridge:** 7.62mm×51, **Feed:** disintegrating or continuous link belt, **Weight:** 9.25 kg, **Barrel Length:** 559mm (1143mm), **Muzzle Velocity:** 790 m/s, **Approx. Effective Range:** (tripod) 2200 m (7217 ft), **Rate of Fire:** (cyclic) 800-950 rounds per minute, **P.V.:** 6, **Damage:** 1D4×10+ 10.

**The Old U.S.S.R.**

**7.62mm RPD Model 4 Light Machine Gun**

**Cartridge:** 7.62mm×39, **Feed:** 100 round disintegrating belt carried in a drum, **Weight:** 7.1 kg, **Barrel Length:** 521mm (1036mm), **Muzzle Velocity:** 700 m/s, **Approx. Effective Range:** 800 m (2625 ft), **Rate of Fire:** (cyclic) 700 rounds per minute, **P.V.:** 5, **Damage:** 5D6.

**7.62mm SGM (Goryunov) Medium Machine Gun**

**Cartridge:** 7.62mm×54R, **Feed:** 250 round pocketed belt, **Weight:** 13.6 kg, **Barrel Length:** 719mm (1120mm), **Muzzle Velocity:** 800 m/s, **Approx. Effective Range:** 1000 m (3280 ft), **Rate of Fire:** (cyclic) 650 rounds per minute, **P.V.:** 6, **Damage:** 6D6.

**12.7mm Degtyarev**

**(Dsh K-38 & Model 38/46) Heavy Machine Gun**

**Cartridge:** 12.7mm×108, **Feed:** 250 round pocketed belt, **Weight:** 35.7 kg, **Barrel Length:** 1070mm (1588mm), **Muzzle Velocity:** 860 m/s, **Approx. Effective Range:** 2000 m (6562 ft), **Rate of Fire:** (cyclic) 575 rounds per minute, **P.V.:** 7+, **Damage:** 1D4×10+6.

**14.5mm KPV Heavy Machine Gun**

**Cartridge:** 14.5mm, **Feed:** 250 round continuous metallic closed pocket, **Weight:** 49.1 kg, **Barrel Length:** 1346mm (2006mm), **Muzzle Velocity:** 1000 m/s, **Approx. Effective Range:** 2000 m (6562 ft), **Rate of Fire:** (cyclic) 575 rounds per minute, **P.V.:** 7+, **Damage:** 1D6x 10+6.

## UNITED KINGDOM

### .303 Mark 1 Vickers Machine Gun

**Cartridge:** .303 ball Mark 8Z, **Feed:** 250 round fabric belt; earlier belts had metal spacers, **Weight:** 15 kg, **Barrel Length:** 724mm (1156mm), **Muzzle Velocity:** 777 m/s, **Approx. Effective Range:** 1500 m (4921 ft), **Rate of Fire:** (cyclic) 450-500 rounds per minute (normal & rapid rates: 125 & 200 rounds per minute in 25 round bursts), **P.V.:** 6, **Damage:** 6D6.

## UNITED STATES

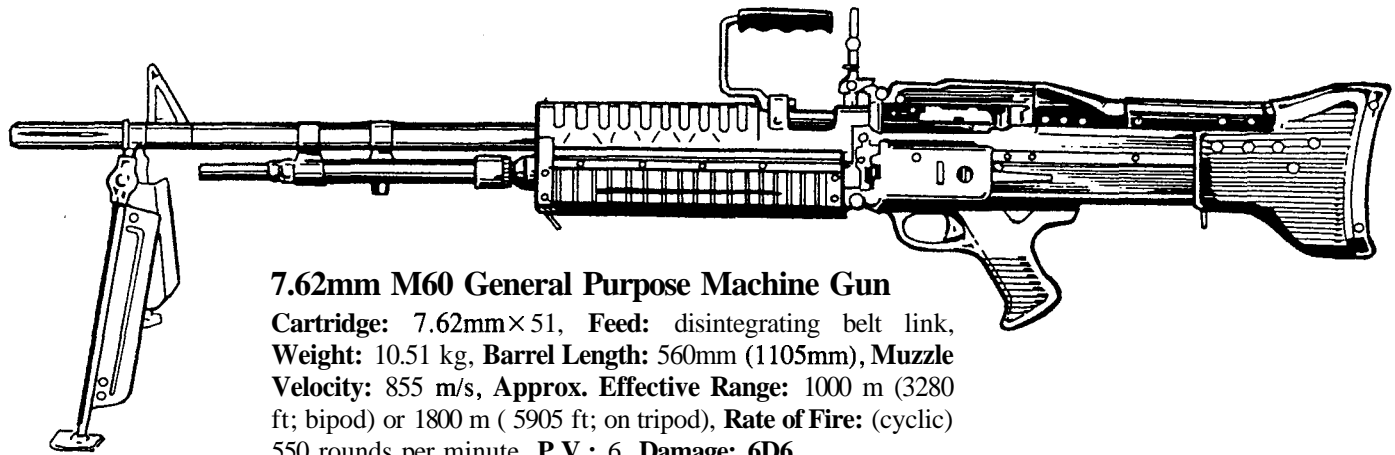

### 7.62mm M60 General Purpose Machine Gun

**Cartridge:** 7.62mm×51, **Feed:** disintegrating belt link, **Weight:** 10.51 kg, **Barrel Length:** 560mm (1105mm), **Muzzle Velocity:** 855 m/s, **Approx. Effective Range:** 1000 m (3280 ft; bipod) or 1800 m (5905 ft; on tripod), **Rate of Fire:** (cyclic) 550 rounds per minute, **P.V.:** 6, **Damage:** 6D6.

*.30 CALIBRE MODEL 1919A6  
BROWNING MACHINE GUN*

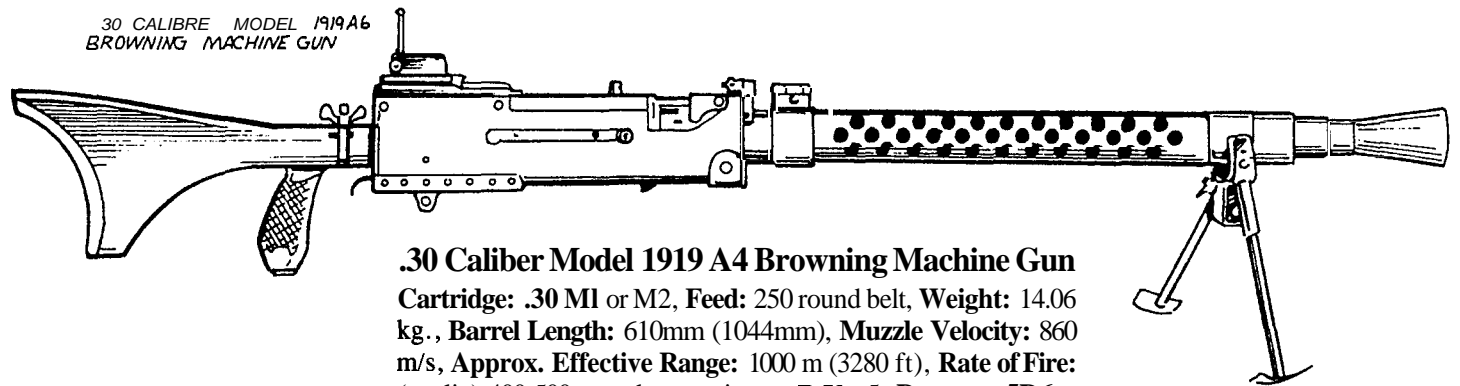

### .30 Caliber Model 1919 A4 Browning Machine Gun

**Cartridge:** .30 M1 or M2, **Feed:** 250 round belt, **Weight:** 14.06 kg., **Barrel Length:** 610mm (1044mm), **Muzzle Velocity:** 860 m/s, **Approx. Effective Range:** 1000 m (3280 ft), **Rate of Fire:** (cyclic) 400-500 rounds per minute, **P.V.:** 5, **Damage:** 5D6.

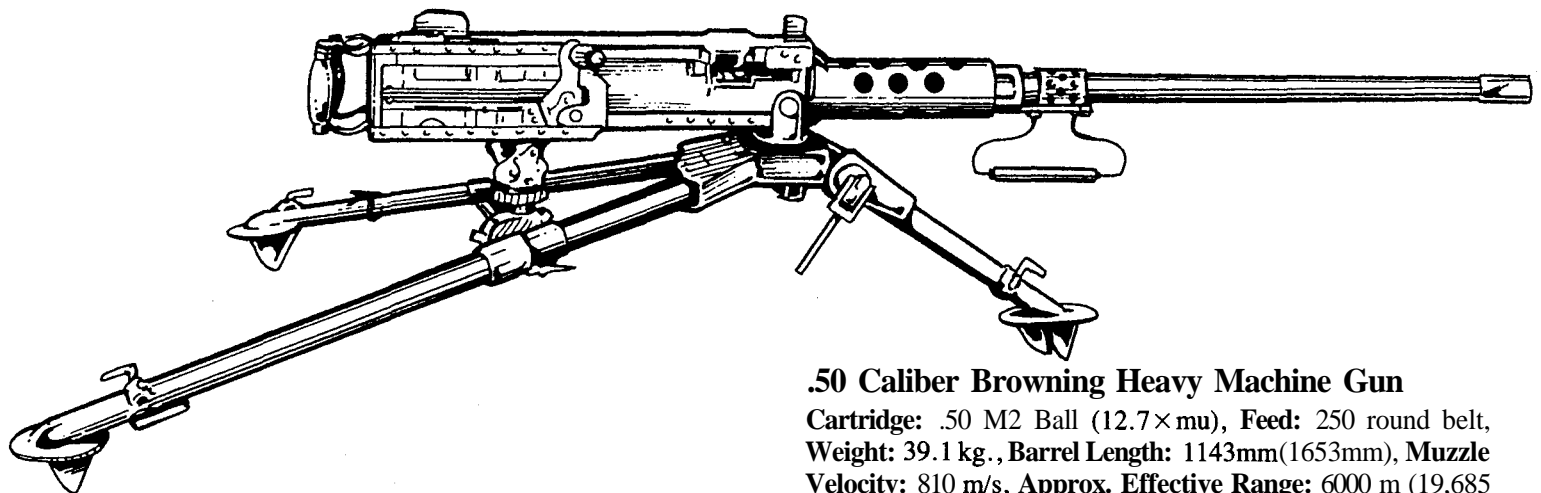

### .50 Caliber Browning Heavy Machine Gun

**Cartridge:** .50 M2 Ball (12.7×mu), **Feed:** 250 round belt, **Weight:** 39.1 kg., **Barrel Length:** 1143mm(1653mm), **Muzzle Velocity:** 810 m/s, **Approx. Effective Range:** 6000 m (19,685 ft), **Rate of Fire:** (cyclic) 450-600 rounds per minute, **P.V.:** 7+, **Damage:** 1D6 x 10 + 10.

"LIGHTNING BUB" SEARCHLIGHT AND  
.50 CALIBER MACHINE GUN

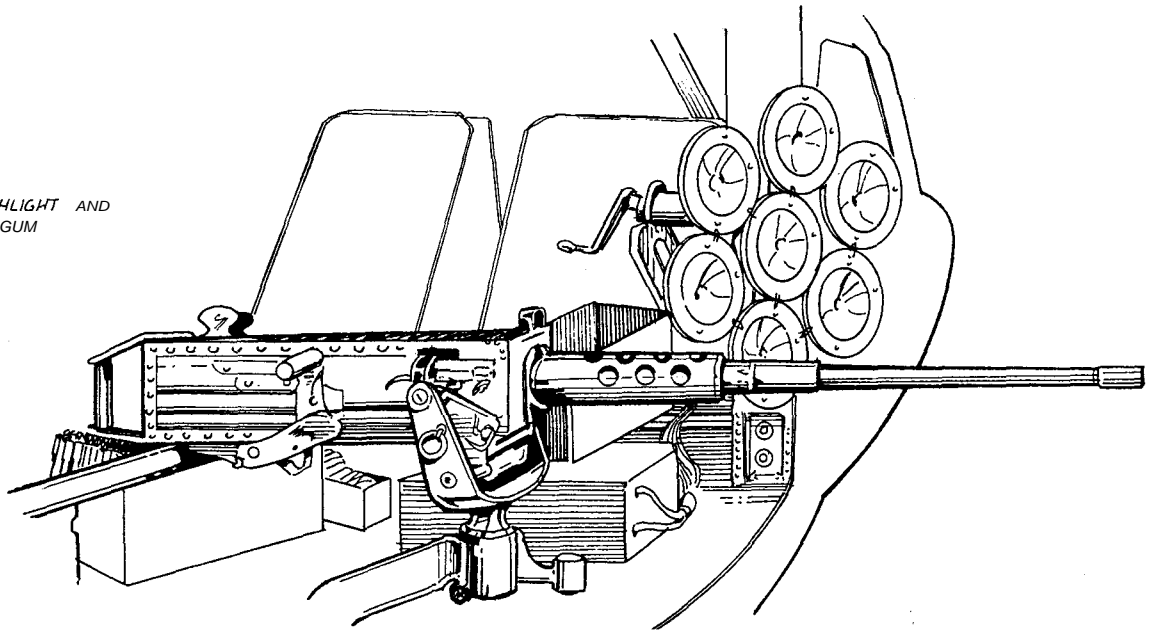

**.50 Caliber Saco Defense  
'Fifty/50' .50 inch Heavy Machine Gun**

**Cartridge:** .50 M2 Ball (12.7 x 99mm), **Feed:** 250 round belt,  
**Weight:** 32.5 kg., **Barrel Length:** 1143mm(1653mm), **Muzzle Velocity:** 810 m/s, **Approx. Effective Range:** 6800 m(22,310 ft), **Rate of Fire:** (cyclic) 500-725 rounds per minute, **P.V.:** 7+, **Damage:** 1D6 x 10+10.

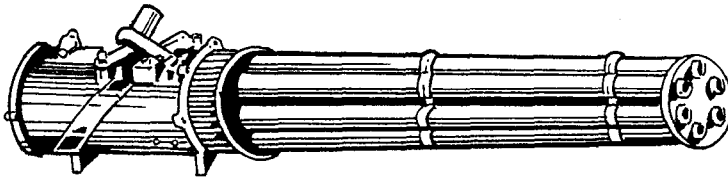

**.50 Caliber GECAL 50, Six Barrel, Machine Gun**

This .50 caliber gatling gun is capable of firing up to a maximum of 8000 rounds per minute! It also comes in a three barrel version.

**Cartridge:** .50 M2 Ball (12.7 x 99mm), **Feed:** 250 round linked or linkless belt, **Weight:** 43.6 kg., **Barrels' Length:** 914mm (1181mm), **Muzzle Velocity:** 884 m/s, **Approx. Effective Range:** 6000 m (19,685 ft), **Rate of Fire:** (cyclic) 8000 rounds per minute (4000 rounds per minute for the three barrel gun), **P.V.:** 7+, **Damage:** 2D6 x 10+10.

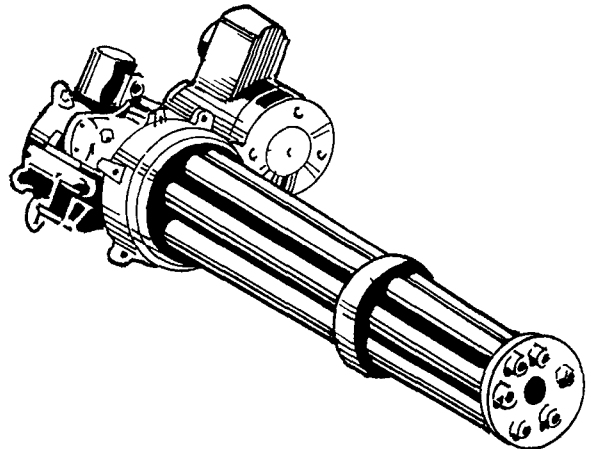

**5.56mm XM-214/Six-Pak Mini-Gun**

This is a lightweight, gatling gun style, mini-gun intended for use on small boats, light vehicles and on the ground. It is capable of firing up to a maximum of 1000 rounds per minute!

**Cartridge:** 5.56 mm x 45, **Feed:** 500 round cassette, **Weight:** 38.6 kg., **Barrels' Length:** 686mm (1041mm), **Muzzle Velocity:** 991 m/s, **Approx. Effective Range:** 4000 m (13,123 ft), **Rate of Fire:** (cyclic) 1000 rounds per minute, **P.V.:** 6, **Damage:** 1D6 x 10+10.

# Combat Hand Grenades

**Note:** Most hand grenades are round, egg-shaped, or cylindrical canisters.

**Typical Hand Grenade Fragments/Shrapnel P.V.:** 4

**Typical Hand Grenade Explosive P.V.:** 7+

**Typical Hand Grenade Damage:** Fragmentation or High Explosive (HE). 1D6 X 10 to 2D4 X 10 damage.

**Typical Effective Hand Grenade Throwing Range:** 30.5 m (100 ft).

**Typical Hand Grenade Blast/Lethal Radius:** 4.6 to 9 m (15 to 30 ft); characters are absolutely safe from fragmentation at 20 m (65 ft) away from the impact point.

**Typical Smoke Grenade:** P.V.I, releases a cloud that covers an approximate 6 m (20 ft) radius; used for troop cover and crowd dispersement/riot control.

**Typical CS/Tear Gas:** This type of chemical gas is often used for riot control. The grenade releases a cloud or vapor that reacts with the eyes and skin of all who are exposed to its chemical agents. See riot control for complete description and penalties.

**Note:** See the section on Riot Control for other non-lethal grenades, rounds and weapons.



## Type HG80 Mini-Fragmentation Grenade

This is a small grenade developed for close quarter fighting. Excellent for clearing buildings. Because of the low weight it can be carried in rather large quantities, and can be thrown accurately a long distance.

**Weight:** 165 grams, **Length:** 76mm, **Diameter:** 40mm, **Weight of Charge:** 13 grams, **Number of fragments:** approx. 1000, **Diameter of Fragments:** 2-2.3mm, **Delay Time:** 4.0 seconds nominal, **Blast Diameter:** 6 m (20 ft), **Damage:** 1D6 x 10. **Range:** Thrown: 42.6 m (140 ft).

## AUSTRIA



## Type HG77 Fragmentation Hand Grenade

**Weight:** 480 grams, **Length:** 96mm, **Diameter:** 65mm, **Weight of Charge:** 70 grams, **Number of fragments:** approx. 5500, **Diameter of Fragments:** 2-2.3mm, **Delay Time:** 4 seconds nominal, **Blast Diameter:** 4.6 m (15 ft), **Damage:** 1D6 x 10, **Range:** Thrown: 30.5 m (100 ft).

## BELGIUM

### PRB NR 423 Hand Grenade

**Length:** 79.3mm, **Diameter:** 52mm, **Weight:** 230 grams; (fragmentation sleeve 65 grams); (explosive charge 60 grams), **Delay:** 4 seconds, **Number of Fragments:** 50 steel balls + 900 fragments, **Fragment Velocity:** 2000 m/s, **Blast Diameter:** 9 m (30 ft), **Damage:** 2D4 x 10, **Range:** Thrown: 30.5 m (100 ft).

## BRAZIL

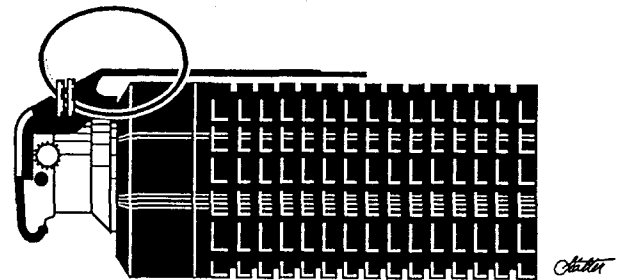

## M3 Defensive/Offensive Hand Grenade

**Length:** 96mm, **Diameter:** 40mm; (with sleeve) 47mm, **Weight:** 415 grams; (fragmentation sleeve) 200 grams; (explosive charge) 90 grams, **Delay:** 4.5 seconds, **Number of Fragments:** 240+, **Fragment Velocity:** 2000 m/s, **Blast Diameter:** 7.6 m (25 ft), **Damage:** 2D4 x 10, **Range:** Thrown: 30.5 m (100 ft).

## CHILE

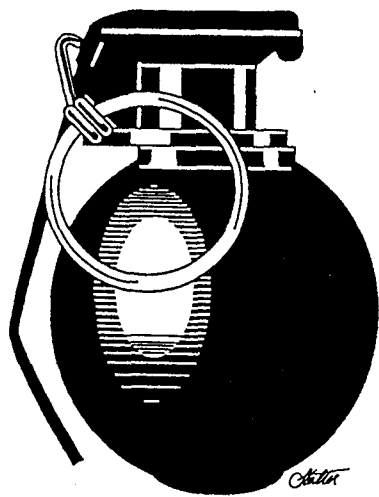

### Mini Hand Grenade

This is a small grenade which was developed for maximum throwing range combined with effective fragmentation. The body is loaded with TNT and provides good lethal coverage.

**Length:** 79.3mm, **Diameter:** 52mm, **Weight:** 332 grams; (fragmentation sleeve 200 grams); (explosive charge 90 grams), **Delay:** 4.5 seconds, **Number of Fragments:** 200+ , **Fragment Velocity:** 2000 m/s, **Blast Diameter:** 7.6 m (25 ft), **Damage:** 2D4 × 10, **Range:** Thrown: 30.5 m (100 ft).

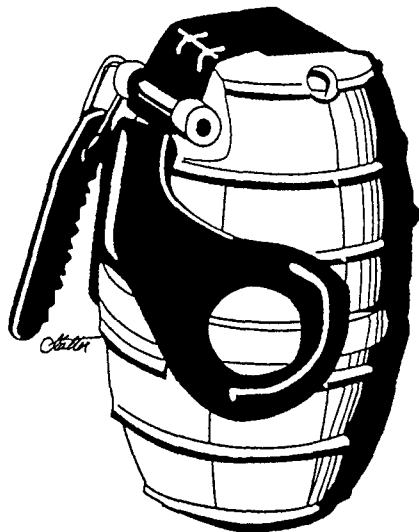

### OD/82 Hand Grenade

**Length:** 83mm, **Diameter:** 59mm, **Weight:** 286 grams, **Delay:** 5 seconds, **Weight of One Fragment:** 0.05 grams, **Safety Distance:** 20 m (65 ft), **Blast Diameter:** 4.6 m (15 ft), **Damage:** 1D6 × 10, **Range:** Thrown: 30.5 m (100 ft).

## POLAND

### Model 31, Fragmenting Hand Grenade (& Rifle version)

**Length:** 270mm, **Diameter:** 55mm, **Weight:** 632 grams, **Delay:** 4.5 seconds, **Number of Fragments:** 900+ , **Penetration:** 100 mm, **Blast Diameter:** Hand grenade: 9 m (30 ft), rifle grenade: 15 m (50 ft), **Damage:** 3D4x 10, **Range:** Thrown: 40 m (131 ft), rifle: 200 m (656 ft).



Polish Hand Grenade

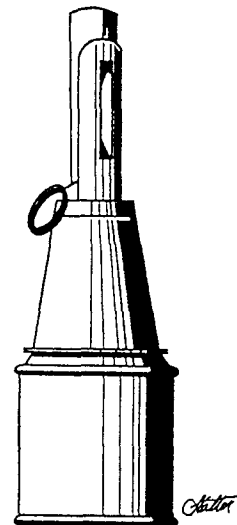

RPG-43 Anti-Tank Hand Grenade

## The Old U.S.S.R.

### RPG-43 Anti-Tank Hand Grenade

**Length:** 279mm, **Diameter:** 102mm, **Weight:** 1200 grams, **Delay:** 4 seconds, **Number of Fragments:** 600+ , **Penetration:** 75mm, **Blast Diameter:** 20 m (68 ft), **Damage:** 2D4 × 10, **Range:** Thrown: 30.5 m (100 ft).

## UNITED STATES OF AMERICA

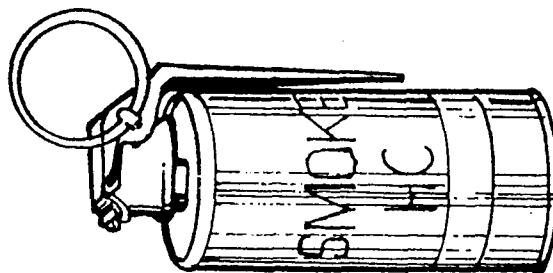

### M67 Delay Fragmentation Hand Grenade

The M67 is one of the standard grenades in service with the US Army. It is a small, round grenade well suited for being thrown.

**Length:** 89.7mm, **Diameter:** 63.5mm, **Weight:** 71 grams, **Delay:** 4 to 5 seconds, **Number of Fragments:** 600+, **Blast Diameter:** 12 m (40 ft), **Damage:** 2D4 × 10, **Range:** Thrown: 40 m (131 ft).

### An-M14 TH3 Incendiary Hand Grenade

This grenade is used primarily to provide a source for intense heat to destroy equipment. It generates heat up to 2200 Centigrade and burns for 30 to 45 seconds. The grenade is normally

thrown but can be fired from a rifle by using a special M2 series projection adaptor.

**Length:** 145mm, **Diameter:** 63.5mm, **Weight:** 42 grams, **Delay:** 2 seconds, **Number of Fragments:** N/A, **Radius of Effect:** 3 m (10 ft), **Damage:** 3D4 × 10, **Range:** Thrown: 25 m (81 ft).

## YUGOSLAVIA

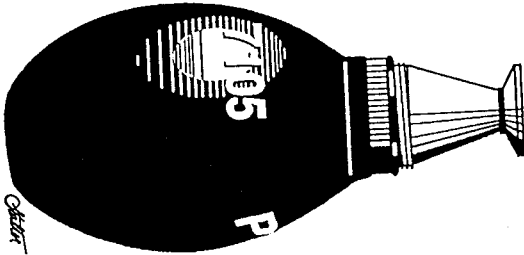

### Yugoslav M69 Anti-Personnel Hand Grenade

**Length:** 307mm, **Diameter:** 30mm, **Weight:** .52 kg, **Blast Diameter:** Hand grenade: 7.6 m (25 ft), rifle grenade: 12 m (40 ft), **Damage:** 2D4x 10, **Range:** Thrown: 40 m (131 ft), rifle: 300 m (984 ft).

### Yugoslav M79 Anti-Tank Hand Grenade

**Length:** 379mm, **Diameter:** 76mm, **Weight:** 1200 grams, **Delay:** 4 seconds, **Penetration:** 220mm, **Blast Diameter:** 10 m (34 ft), **Damage:** 2D4 × 10, **Range:** Thrown: 25 m (81 ft).

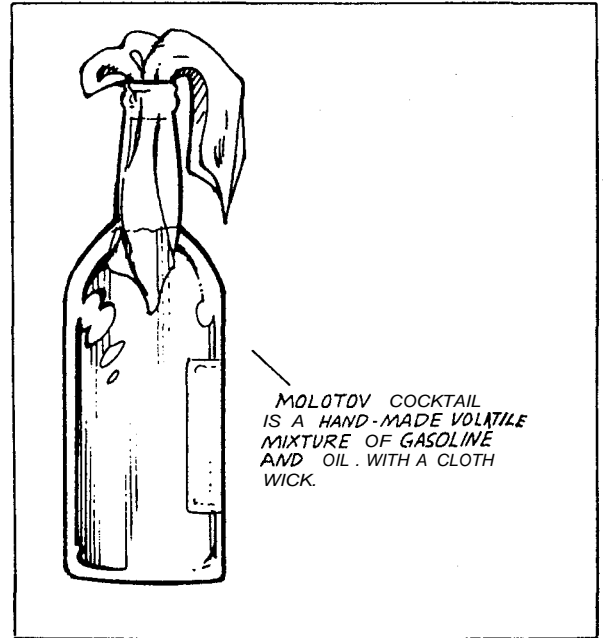

DRAWINGS ARE NOT TO SCALE.

## Various Grenade Designs . . .

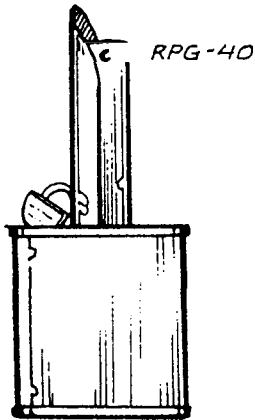

RPG-40

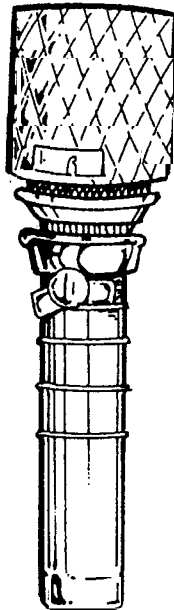

RDG-33 ANTI-PERSONNEL  
HAND GRENADE

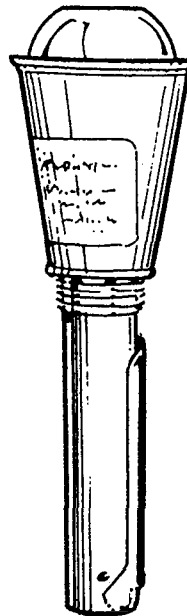

RPG-6 ANTI-TANK HAND GRENADE

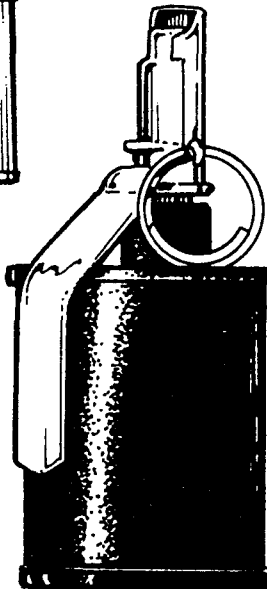

RG-42 ANTI-PERSONNEL  
HAND GRENADE

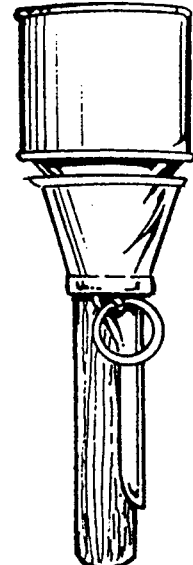

RPG-43 ANTI-TANK  
HAND GRENADE



# Light Support Weapons

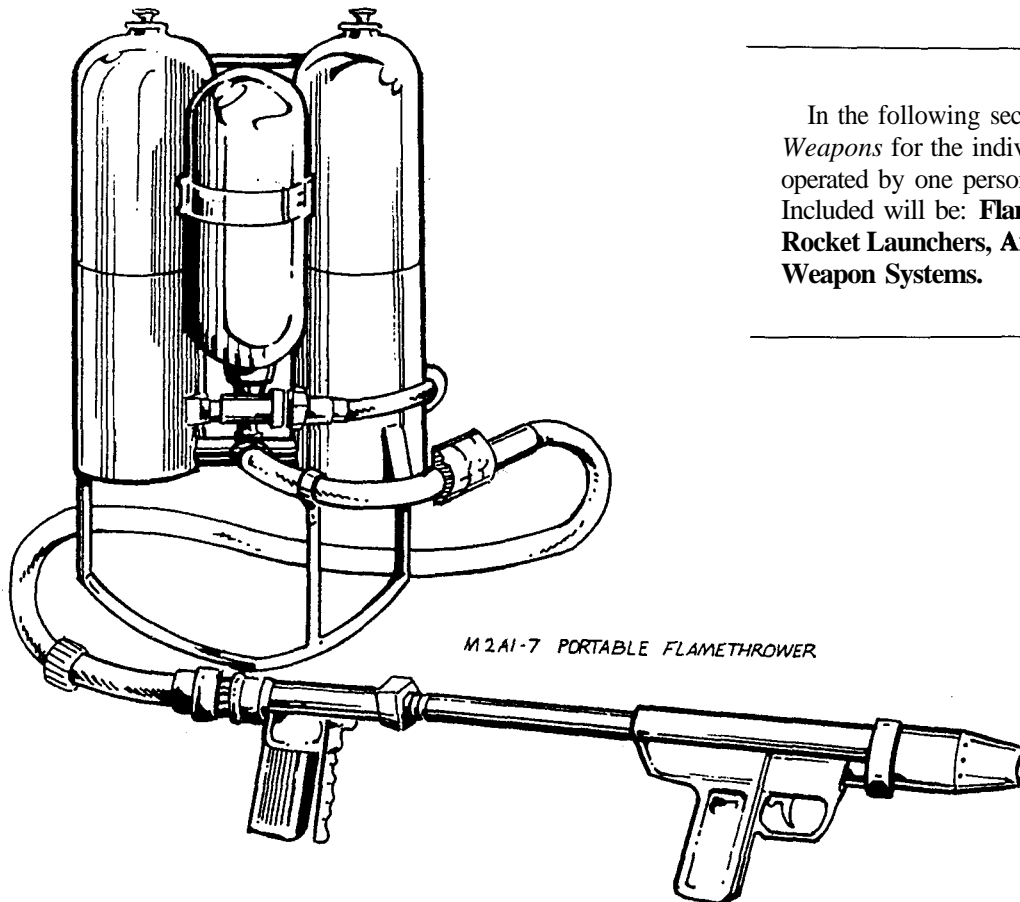

---

In the following section you will find described *Light Support Weapons* for the individual. These weapons are designed to be operated by one person so there is no need for an entire crew. Included will be: **Flamethrowers, Grenade Launchers, Small Rocket Launchers, Anti-Tank/Armor weapons and Specialty Weapon Systems.**

---

## Flamethrowers

**Fuels:** Most flamethrowers use a gasoline and oil mixture or similar mixtures.

**Fuel Capacity & Rate of Fire:** Fuel capacities vary from 15 to 22 liters (4-6 gallons) and offers a one to three second flame burst per every 3 liters (one gallon) of **fuel!**

**Typical Damage:** 1D4 X 10 plus the flame will set any combustible items, including human hair, clothes, cloth, wood, dry grass and other flammable chemicals/liquids on fire (95% likelihood of **combustion**). The intense heat is also likely to ignite explosives and ammunition (30% chance from a three second flaming burst; 90% likelihood after about 30 to 60 seconds of fire — caused by the initial **burst**).

**Typical Effective Range:** 50 (164 ft)

**Typical Maximum Range:** 70 m (230 ft)

## BRAZIL

### LC T1 M1 Flamethrower

**Weight:** (unloaded) 21 kg; **Fuel Capacity:** 15 liters (4 gal.) or 18 liters (5 gal.), **Fuel Hose Length:** 1.115 m (4 ft), **Weapon Tube Length:** 635 mm, **Damage:** 1D4x 10 plus combustion, **Maximum Range:** 70 m (230 ft).

## GERMANY

### HAFLA DM 34 Hand Flame Cartridge Launcher

This is a small, handheld, single shot, disposable weapon which is designed to propel an incendiary smoke charge into areas 70 to 80 meters away (230 to 262 ft).

The launcher is shipped in a watertight, plastic carrying case that contains three HAFLA DM 34 launch units and three **car-**

tridges. Once fired, the projectile bursts after traveling 70 to 80 meters and burning particles will spread in an area approximately 10 meters in diameter (33 ft). However, if the projectile hits a solid object within a range of 8 to 70 meters (26 to 230 ft), the incendiary smoke charge will immediately scatter on impact and will cover a 5 to 8 meter (16 to 26 ft) area with fire and fragments (impact causes 6D6 damage). In either case, the hot (1300 Centigrade) fragments continue to burn for at least 2 minutes.

**Caliber:** 35mm, **Weight:** 625 grams, **Overall Length:** 445mm, **Incendiary Composition:** Red Phosphorus, **Damage:** 1D6 x 10 plus combustion to a 10 m (33 ft) diameter area, **Maximum Range:** 80 m (262 ft).

## ITALY

### Mod T148 Portable Flamethrower

**Total Weight:** 25.5 kg, **Operational Temperature Limits:** 20 to 55 Centigrade, **Fuel Capacity:** 15 liters (4 gallons), **Damage:** 1D4 x 10, **Maximum Range:** 70 m (230 ft).

## TAIWAN

### Type 67 Flamethrower

**Weight:** 23.51 kg (with fuel), **Height:** 700mm, **Width:** 530mm, **Length:** 300mm, **Fuel:** Gasoline and napalm, **Fuel Capacity:** 15 liters (4 gallons), **Damage:** 1D6 x 10, **Maximum Range:** 55 m (180 ft).

## UNITED STATES

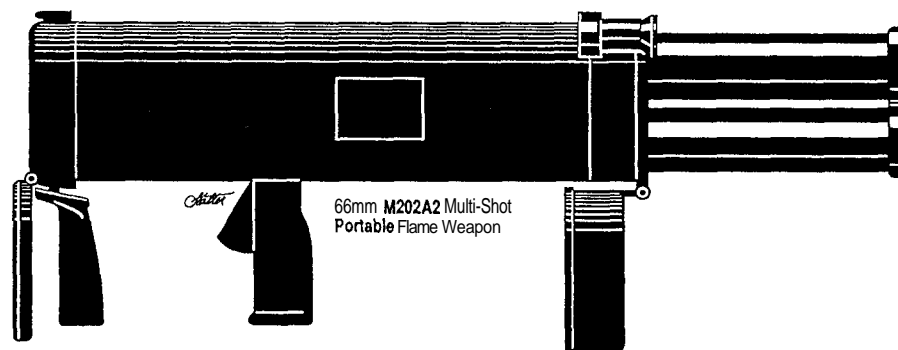

### 66mm M202A2 Multi-Shot Portable Flame Weapon

This weapon consists of a light, shoulder-fired, four tube rocket launcher. It uses a pre-loaded four cartridge clip which slides into the launch tubes.

This weapon can easily be fired from a standing, sitting or kneeling position. The launcher is reusable.

**Weight:** 12 kg, **Length, extended for firing:** 82.26 cm, **Payload:** Four, **Blast Area:** 9 m (30 ft; 20 m/68 ft from blast area is minimum safety), **Damage:** 3D4 x 10, **Maximum Range:** 750 m (2461 ft).

### ABC-M9-7 Portable Flamethrower

**Total Weight:** 22.7 kg (loaded), **Operational Temperature Limits:** 20 to 55 Centigrade, **Fuel Capacity:** 15 liters (4 gallons), **Damage:** 1D4 x 10, **Maximum Range:** 55 m (180 ft). **Note:** The M2A1-7 is a similar USA military flamethrower with nearly identical stats.

# Grenade & Rocket Launchers

Grenade launchers and grenade guns are simply large caliber small arms designed to fire a grenade instead of a bullet. Most are also capable of firing anti-riot and flare projectiles. The predominant calibers of these weapons are 40mm, 37/38mm, and 25mm, although others do exist. Types of cartridges include the following: High Explosive (HE), Multiple projectile (either steel shot similar to a shotgun or needle-like *flechettes*), Illumination (normally parachute flare), Smoke/Irritant (CS or tear gas), Baton (used to inflict pain — usually called 'low lethality projectiles,' i.e. rubber bullets, batons, etc.), and combination rounds like **baton/irritant** or **penetration/irritant** (used to punch through a door and then disperse tear gas). There are also adaptors to allow rifles to fire the grenades.

The **rocket launcher and recoilless gun** are products of WW II, born from the need to place effective anti-armor weapons in the hands of the infantryman. They allow the firing of relatively large projectiles from a man's shoulder but suffer from the drawbacks of having a large back-blast which can give away the **firer's** position and can kill someone who is too close behind the weapon. The principle behind most rocket launchers is Newton's Third Law: for every action there is an equal and opposite reaction. The forward motion of the projectile at launch is balanced by a backward moving counter weight (often iron filings) or a stream of high velocity **gases**. Firing from the shoulder is made possible by the lack of recoil and the relatively light weight of the launch **tube**.

The most common form of projectile for these weapons are called *shaped charge* shells. A shaped charge warhead basically consists of a hollow, funnel shaped, cone of explosive which detonates at its base (the narrow part of the cone) when it strikes a target. The shape of the explosive focuses the blast into a high velocity jet of gas capable of melting a hole through armor. Molten metal is then sprayed inside the tank, either killing the crew or setting off the ammunition. The great advantage of these types of shells is that they are capable of penetrating the same amount of armor at long range as at short range, because they do not rely on kinetic energy to help them punch through. Normally these projectiles are called **High Explosive Anti Tank (HEAT)** rounds.

Other types of projectiles used are smoke (for troop **cover**), illuminating (to light an area with a powerful parachute flare), **High Explosive (HE)**, and **High Explosive Dual Purpose (HEDP)**, which is a combination round for use against either exposed troops or lightly armored vehicles.

An outgrowth of the rocket launcher was the development of the anti-tank missile which was designed to enable the troops to engage armored targets at very long ranges. Although they still rely primarily on the HEAT warhead, a number of improvements have been made to improve accuracy and first hit **probability**. The first of these improvements was the development of wire guidance wherein the missile carries a spool of wire which unwinds behind it as it flies. This allows the firer to send flight corrections to the missile after launch. The two main versions

of wire guidance are called **Manual Command to Line Of Sight (MCLOS)** and **Semi-Automatic Command to Line Of Sight (SACLOS)**. Both versions rely on the firer keeping an eye on the target.

The manual MCLOS weapon also requires the firer to track the missile as well and guide it to the target. The SACLOS semi-automatic weapon uses a sensor in the firing unit which picks up infrared emissions from flares at the rear of the rocket and then automatically computes and sends flight corrections. **Laser guided missiles** have also been developed which rely on the target being "painted" with a laser beam. The reflected laser light is picked up by sensors in the nose of the missile and it then homes in on the target. Laser guided missiles do not rely on the firer to man the laser, i.e. any other unit can designate targets. Some wire-guided and laser guided systems offer the firer the advantage of a low firing signature (back-blast) since these systems are remote controlled; often they can also be fired remotely from as far as 100 meters **away**. This greatly reduces the chance of counter fire meant to disrupt the operator from guiding the missile.

---

## Grenade Launchers

---

### AUSTRIA



#### M203 Grenade Launcher

This launcher was designed to fit on the barrel of the Steyr Army Universal Gun, however because of its versatility it is adaptable to any variant of the AUG rifle family.

**Launcher Caliber:** 40mm, **Overall Length of Complete Unit:** 725mm, **Rifle Barrel Length:** 610mm, **Weight of Complete Unit:** 3 kg, **Blast Diameter:** 12 m (40 feet), **Damage:** 1D6 × 100, **Approx. Effective Range:** Launcher: 400 m (1312 ft). **Note:** Can also fire smoke, CS and illumination grenades.

#### Arges 40mm grenades for M79/M203 Pattern Launchers

**Weight:** 262 grams, **Length:** 102mm, **Weight of Charge:** 40 grams, **Number of fragments:** approx. 900, **Diameter of Fragments:** 2-2.3mm, **Delay Time:** impact or 8 seconds self-destruct, **Blast Diameter:** 12 m (40 feet), **Damage:** 1D6 × 100, **Max. Range:** Launcher: 400 m (1312 ft).

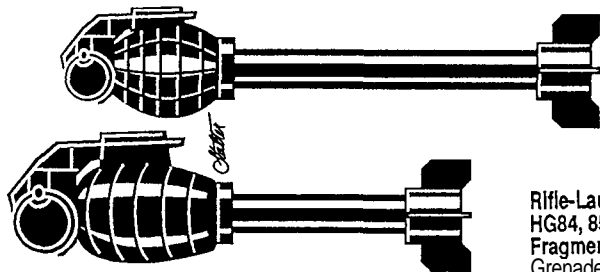

Rifle-Launched  
HG84, 85 & 86 Mini  
Fragmentation  
Grenades (SSG)

### Rifle-launched HG84 fragmentation grenades (SSG)

Weight: 640 grams, Length: 260mm, Diameter: 78mm, Weight of Charge: 90 grams, Number of fragments: approx. 1000, Diameter of Fragments: 2-2.3mm, Delay Time: 5.5 seconds, Blast Diameter: 4.6 m (15 ft), Damage: 2D4 x 10, Approx. Effective Range: 5.56 rifle: 135 m (443 ft) or 7.62 rifle: 200 m (656 ft).

## BELGIUM

### FLY-K PRB Grenade Launcher/Mortar

This weapon uses a flashless, smokeless, and noiseless launching system. The tail portion of the grenade/bomb is hollow and a sliding piston contains the blast of the propellant. The launcher itself has a bubble level type ranging device attached to its upper portion. A sliding sleeve on the launch tube cocks and fires the projectile.

Caliber: 52mm, Length: 605mm, Weight: 4.5 kg unloaded, Feed: single-shot, Velocity: 85-100 m/s, Rate of Fire: 6-8 rounds per minute, Damage: 1D6 x 10, Blast Diameter: 6 m (20 ft), Approx. Effective Range: 600 m (1969 ft).

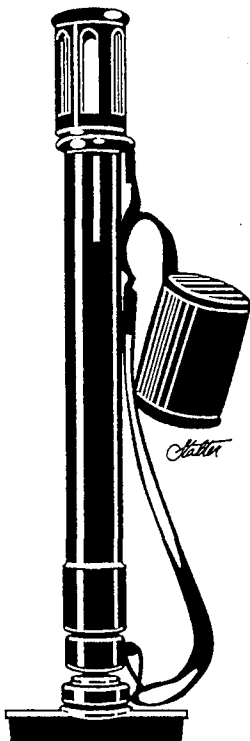

Fly-KPRB Grenade Launcher

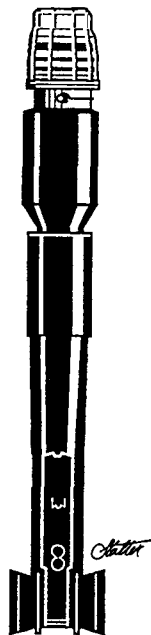

35mm HE-RFL-35 BTU M262  
Anti-Personnel MECAR Rifle  
Grenade

### NR8464PRB Multiple Grenade Launcher/Mortar

This is a modification of the basic FLY-K system designed to be mounted on vehicles or in a fixed defensive position. By adjusting the angles of the twelve launchers, an area of 1000 square meters can be covered by a single salvo. The unit is fired electrically.

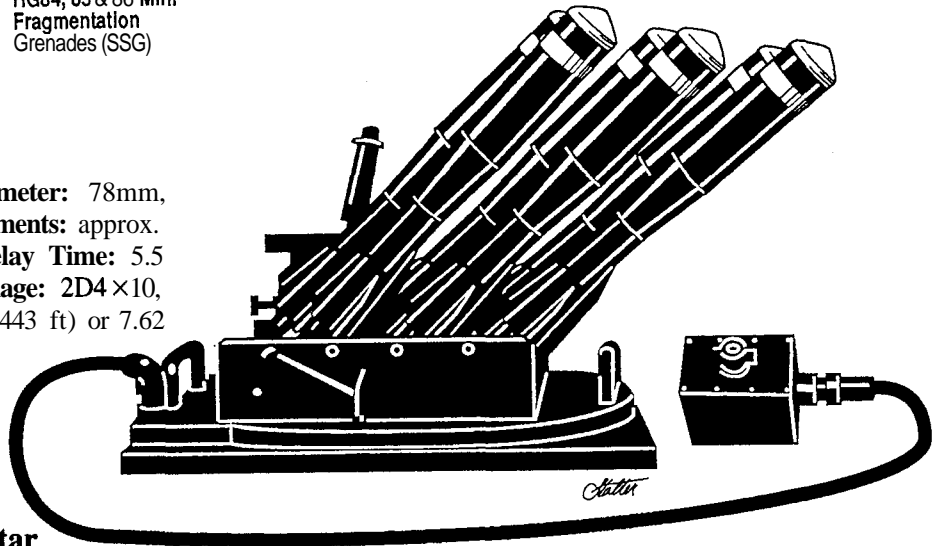

Caliber: 58mm, Length: 310mm, Weight: 95 kg unloaded, Feed: 12 single-shot dischargers, Rate of Fire: 1-12 grenades per salvo, Velocity: 100 m/s, Damage: 1D4 x 100, Blast Diameter: 16 m (53 ft), Approx. Effective Range: 800 m (1969 ft).

### MECAR Disorienting Grenade DS-RFL-35 BTU M278

This projectile is made to be used as a shoulder-fired rifle grenade to penetrate light structures such as doors, windows and so on. It can also be used to disorient, shock and stun human targets by the use of intense illumination and sound.

Length: 321mm, Weight: 360 grams, Approx. Effective Range: 150 m (492 ft) when fired from a 5.56mm or 7.62mm rifle with a 22mm diameter muzzle or adaptor. Note: P.V. 4, Damage (5) 4D6.

### 35mm HE-RFL-35 BTU M262 Anti-Personnel MECAR Rifle Grenade

Caliber: 35mm, Weight: 405 grams, Length: 288mm, Number of fragments: approx. 300, Blast Diameter: 9 m (30 feet), Damage: 2D4 x 10, Approx. Effective Range: 300-400 m (1984-1312 ft) depending on the rifle used.

### Types of Rifle Grenades

NR 208 Rifle Grenade: Caliber: 52mm, Length: 330mm, Weight: 750 grams, Velocity: 90 m/s, Penetration: 5mm, Blast Radius: 6 m (20 ft), Damage: 2D4 x 10, Range: 400 m (1312 ft).

NR 209 Rifle Grenade — illuminating: Caliber: 48mm, Length: 410mm, Weight: 605 grams, Velocity: 100 m/s, 220 m height, Blast: 2 lux 225 m radius, 4 lux 40m radius, Duration: 10 to 20 seconds, Damage: N/A, Range: 450 m (1476 ft).

**NR 210 Rifle Grenade** — **smoke:**, **Caliber:** 52mm, **Length:** 330mm, **Weight:** 600 grams, **Velocity:** 85 m/s, **Blast:** WP 5 m radius dispersal, **Damage:** N/A, **Range:** 600 m (1969 ft).

---

## GERMANY

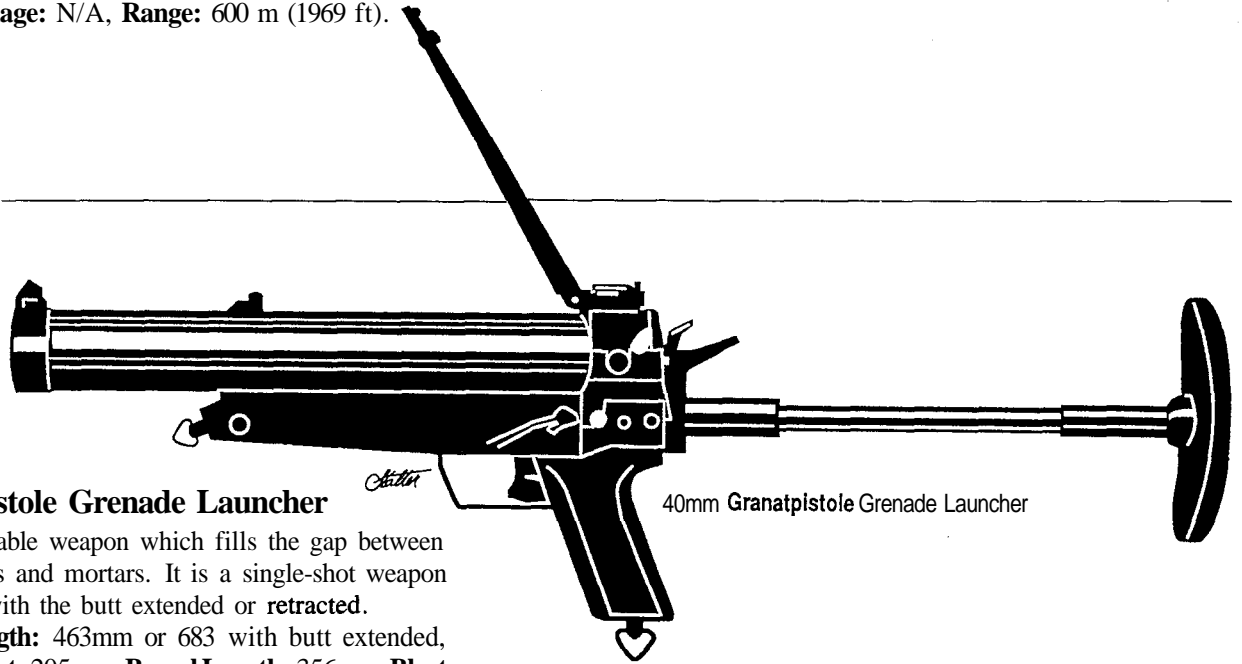

### 40mm Granatpistole Grenade Launcher

This is a light portable weapon which fills the gap between hand thrown grenades and mortars. It is a single-shot weapon which may be fired with the butt extended or **retracted**.

**Caliber:** 40mm, **Length:** 463mm or 683 with butt extended, **Weight:** 3.4 kg, **Height:** 205mm. **Barrel Length:** 356mm, **Blast Diameter:** 6 m (20 feet), **Damage:** 1D6 x 10, **Approx. Effective Range:** 350 m (1148 ft). **Note:** It can also fire smoke, CS, and illumination grenades.

40mm Granatpistole Grenade Launcher

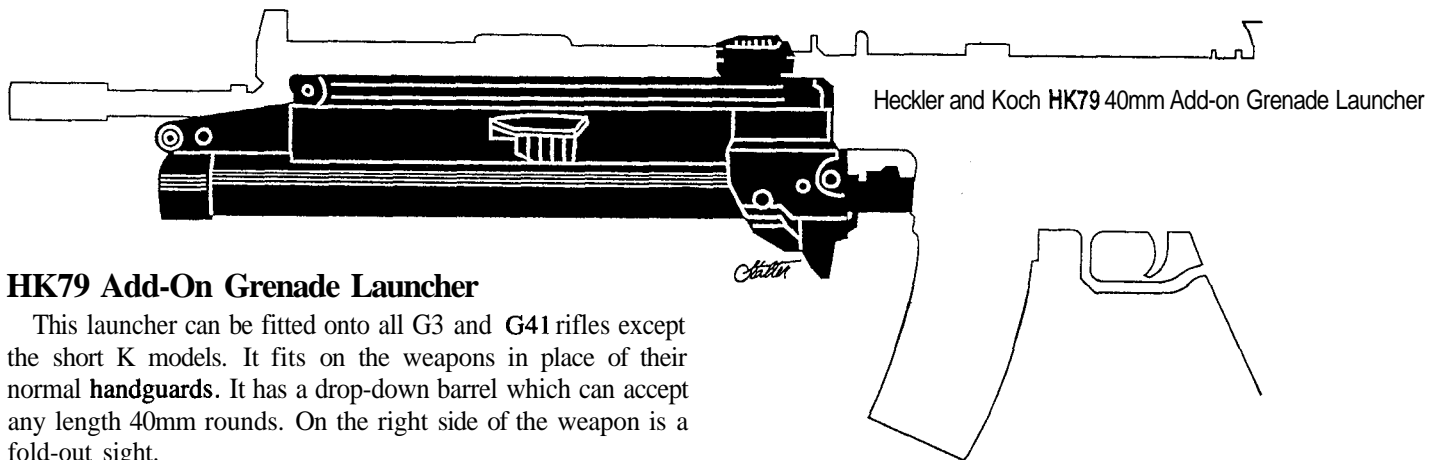

Heckler and Koch HK79 40mm Add-on Grenade Launcher

### HK79 Add-On Grenade Launcher

This launcher can be fitted onto all G3 and G41 rifles except the short K models. It fits on the weapons in place of their normal **handguards**. It has a drop-down barrel which can accept any length 40mm rounds. On the right side of the weapon is a fold-out sight.

**Caliber:** 40mm, **Length:** 350mm, **Weight:** 1.5 kg, **Barrel Length:** 356mm, **Feed:** Single-shot, **Rate of Fire:** Approx. 6 rounds per minute, **Velocity:** 76 m/s, **Penetration:** 2mm, **Blast Diameter:** 9 m (30 feet), **Damage:** 1D6 x 10, **Approx. Effective Range:** 350 m (1148 ft). **Note:** It can also fire smoke, CS, and illumination grenades.

**HK 40mm grenade cartridge:** **Caliber:** 40mm, **Length:** 99mm, **Weight:** 230 grams, **Range:** 350 m (8 seconds of flight), **Penetration:** 2mm, **Blast Diameter:** 9 m (30 feet), **Damage:** 1D6 x 10.

---

## SINGAPORE

### CIS-40GL Grenade Launcher

This modular construction weapon is capable of firing all standard 40mm grenades. Although normally fitted with a buttstock, it can be mounted on a wide range of assault rifles with the appropriate adaptor. The barrel is loaded by pressing down the receiver on the left side and then swinging it out to the side. It has a manual safety.

40mm CIS-40GL Grenade Launcher

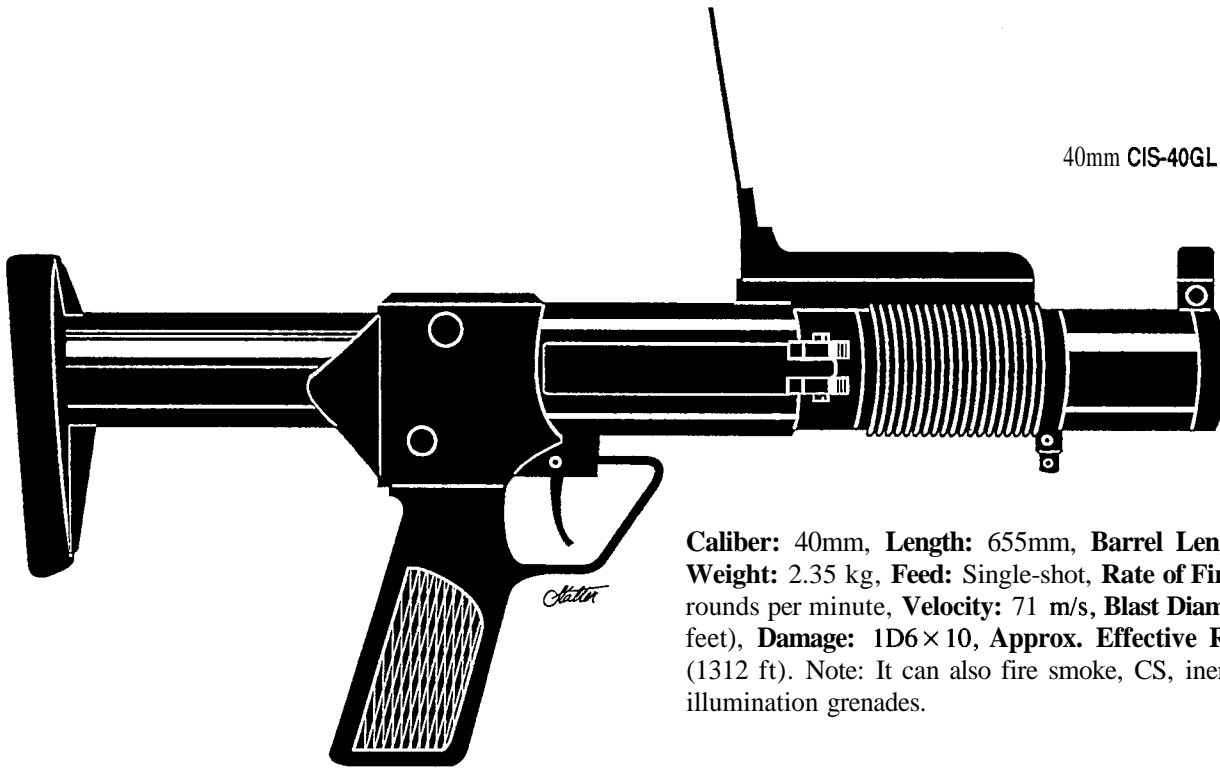

**Caliber:** 40mm, **Length:** 655mm, **Barrel Length:** 305mm, **Weight:** 2.35 kg, **Feed:** Single-shot, **Rate of Fire:** Approx. 6 rounds per minute, **Velocity:** 71 m/s, **Blast Diameter:** 9 m (30 feet), **Damage:** 1D6 x 10, **Approx. Effective Range:** 400 m (1312 ft). Note: It can also fire smoke, CS, inert batons, and illumination grenades.

## SOUTH AFRICA

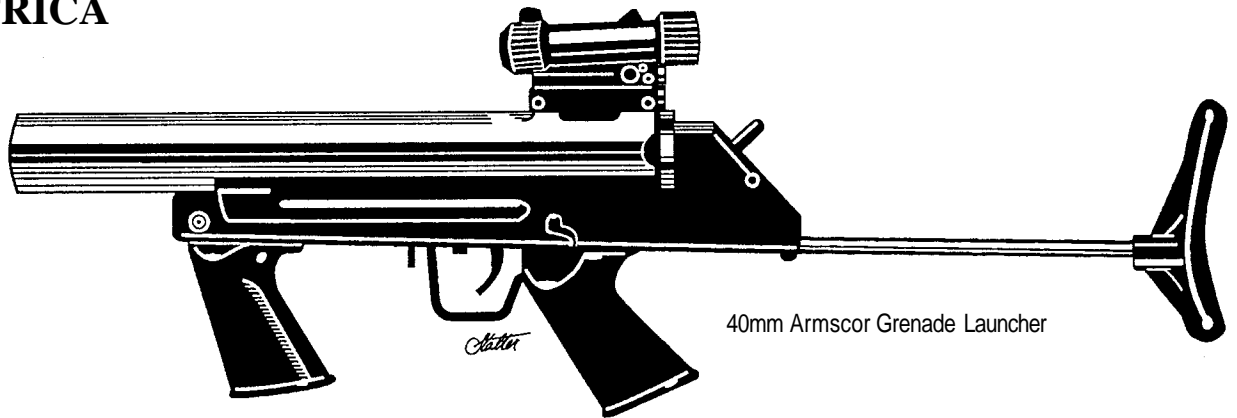

40mm Armscor Grenade Launcher

### 40mm Armscor Grenade Launcher

Another rifle-like launch tube.

**Caliber:** 40mm, **Overall Length:** 655mm, **Barrel Length:** 340mm, **Weight:** 3.7 kg, **Feed:** Single-shot, **Rate of Fire:** Approx. 5 rounds per minute, **Velocity:** 78 m/s, **Blast Diameter:** 6 m (20 feet), **Damage:** 1D6 x 10, **Minimum Range:** 30 m (100 ft), **Maximum Effective Range:** 150 m (492 ft). Note: It can also fire smoke, CS, inert batons, and illumination grenades.

### 40mm Armscor MGL 6-Shot Grenade Launcher

This weapon is a light, semi-automatic grenade launcher with a six round capacity. Although it was designed for combat purposes, it is very effective as an anti-riot weapon or for other security purposes.

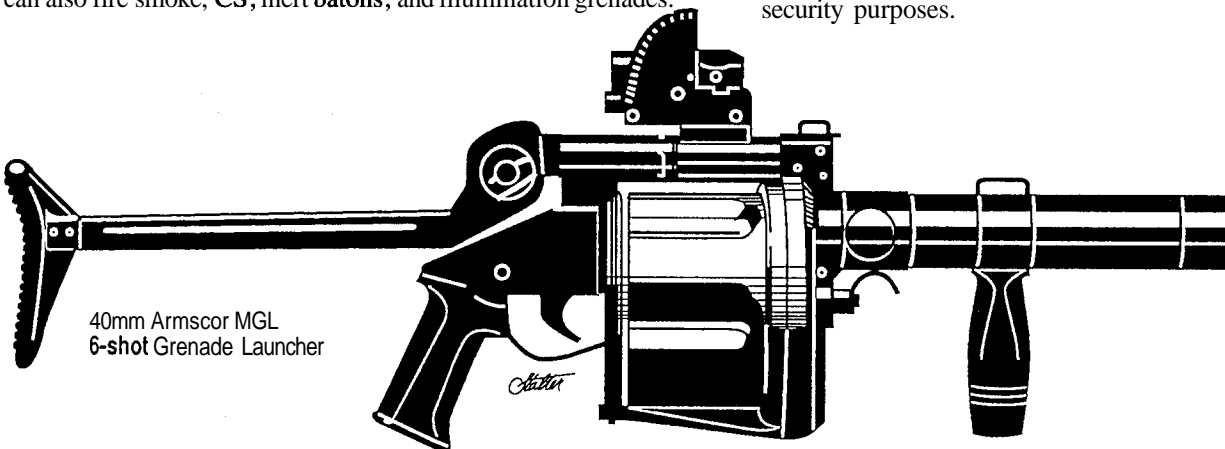

40mm Armscor MGL 6-shot Grenade Launcher

**Caliber:** 40mm, **Overall Length:** 788mm, **Barrel Length:** 310mm, **Weight:** 6.7 kg, **Feed:** Six, **Sustained Rate of Fire:** Approx. 18 rounds per minute, **Velocity:** 76 m/s, **Blast Diameter:** 6 m (20 feet), **Damage:** 1D6×10, **Minimum Range:** 30 m (100 ft), **Maximum Effective Range:** 350 m (1148 ft). **Note:** It can also fire smoke, CS, inert batons, and illumination grenades. The United Kingdom's MSRG 38 Excalibur Mark 2 is a similar, five shot weapon; it accepts all standard 37/38mm rounds. Also see the USA Federal (6 shot) and MM-1 (12 shot).

## 37mm Stopper Riot Control Weapon

Another rifle-like, multi-purpose grenade launch tube.  
**Caliber:** 37mm, **Overall Length:** 506mm, (700 with stock extended), **Weight:** 3.7 kg, **Feed:** Single-shot, **Sustained Rate of Fire:** Approx. 5 rounds per minute, **Velocity:** 84 m/s, **Blast Diameter:** 6 m (20 feet), **Damage:** 1D6 x 10, **Maximum Effective Range:** 300 m (984 ft). **Note:** It can also fire smoke, CS, inert batons, and illumination grenades.

## SWITZERLAND

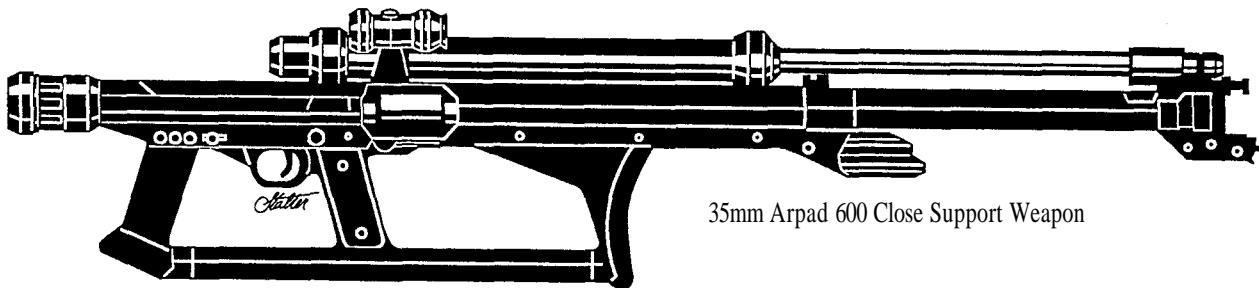

35mm Arpad 600 Close Support Weapon

### 35mm Arpad 600 Close Support Weapon

This is a shoulder fired recoilless weapon designed for infantry use. It is lightweight, compact and can be directed on targets very rapidly. It was designed for use against stationary and moving targets. The Arpad was meant to destroy point objectives, such as machine gun posts, light vehicles or assault helicopters.

Special ammunition (see below) has been designed specifically for the Arpad. The ammunition has been designed to be light enough for the firer to be able to carry 20 to 30 rounds easily.

**The Arpad 600:** **Caliber:** 35mm, **Overall Length:** 960mm, **Barrel Length:** 805mm, **Weight:** 6.8 kg, **Feed:** 29 round belt, **Sustained Rate of Fire:** Approx. 18-20 rounds per minute, **Velocity:** 600 m/s, **Blast Diameter:** 10 m (30 feet), **Damage:** 2D4×10, **Approx. Effective Range:** 1200 m (3937 ft). **Note:** It can also fire smoke, CS, inert batons, and illumination grenades.

**Ammunition:** **Caliber:** 35mm, **Weight:** 167 grams, **Length:** 176mm, **Time to Self-Destruction:** 2 seconds, **Time of Flight to 500 m:** One second, **Penetration:** 50mm steel plate. **Damage:** 2D4×10

## The Old U.S.S.R.

### AGS-17 grenade launcher

This weapon, nicknamed 'Plamya' (Flame) by the Soviet forces, was introduced in 1975. It can be mounted in helicopters and on vehicles or mounted on a tripod for use on the ground.

**Caliber:** 30mm, **Overall Length:** 840mm, **Weight:** 18 kg (weapon), 35 kg with tripod, **Feed:** 29 round belt magazine, **Sustained Rate of Fire:** Approx. 65 rounds per minute, **Penetration:** 10mm, **Velocity:** 80 m/s, **Blast Diameter:** 9 m (30 feet), **Damage:** 1D6×10, **Approx. Effective Range:** 1750 m (5741 ft). **Note:** It can also fire smoke, CS, inert batons, and illumination grenades.

### BG-15 Grenade Launcher

This short, under-barrel grenade launcher can be fitted beneath the AK-47. On the left side of the barrel is a fold-down sight.  
**Caliber:** 30mm, **Overall Length:** 300mm, **Weight:** 1.4 kg (weapon), **Feed:** Single-shot, **Rate of Fire:** Approx. 6 rounds per minute, **Penetration:** 5mm, **Velocity:** 80 m/s, **Blast Diameter:** 9 m (30 feet), **Damage:** 1D6×10, **Approx. Effective Range:** 400 m (1312 ft). **Note:** It can also fire smoke, CS, inert batons, and illumination grenades.

## UNITED KINGDOM

### L1A1 Grenade Discharger

This is a light, single-shot grenade launcher which is shoulder fired and electrically operated. A new cartridge was developed specifically for the L1A1 to provide a better means of projecting CS gas into riot situations and to prevent gas canisters from being thrown back. It is powered by 2 dry cell batteries and can fire numerous grenades before they need to be replaced.

**Caliber:** 66mm, **Overall Length:** 695mm, **Weight:** 2.7 kg, **Feed:** Single-shot, **Sustained Rate of Fire:** Approx. 5 rounds per minute, **Velocity:** 74 m/s, **Blast Diameter:** 6 m (20 feet), **Damage:** 1D6×10, **Maximum Effective Range:** 100 m (328 ft). **Note:** It can also fire smoke, CS, inert batons, and illumination grenades. Standard Weight of Grenade: 550 grams.

### Hilton MPRG Multi-Purpose Gun

This simple weapon can fire a wide range of projectiles due to a variety of interchangeable barrels. The basis of the weapon is a receiver and pistol grip trigger unit into which either a long or short 37mm barrel can be screwed. The 37mm barrel is break-open. An insert can be fitted inside the long 37mm barrel, allowing any 12 gauge round to be fired. An extractor is fitted in this

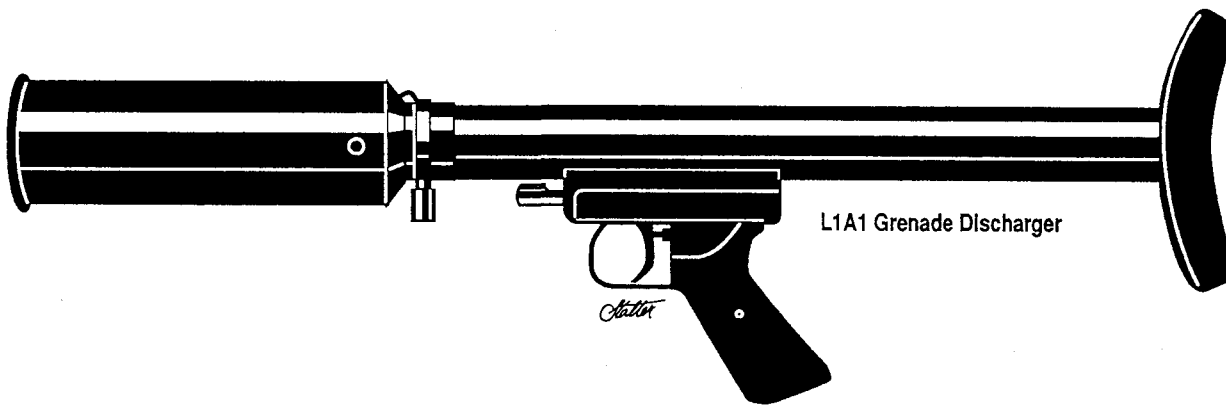

L1A1 Grenade Discharger

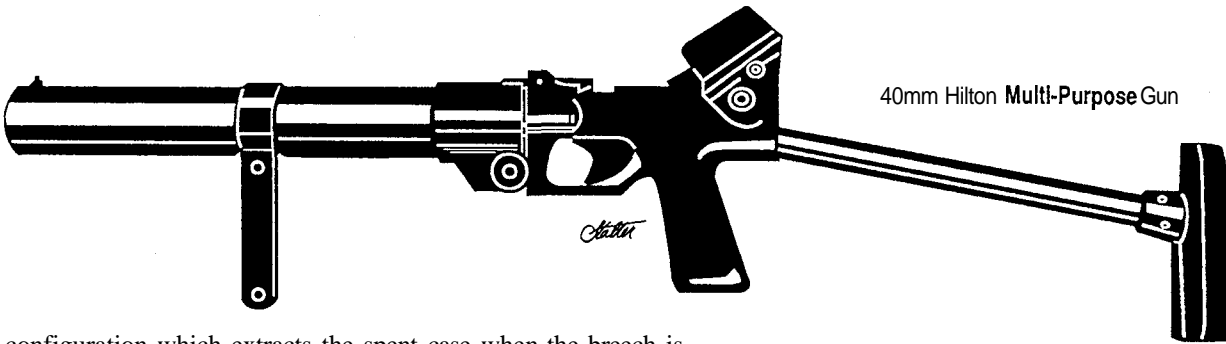

40mm Hilton Multi-Purpose Gun

configuration which extracts the spent case when the breech is opened. The short 37mm barrel can also be fitted with an insert allowing the firing of standard 25mm flares or anti-riot cartridges. Although fitted with open sights, an optical one can be fitted, improving accuracy.

There is also a 5.56mm rifled insert to allow for the single-shot firing of standard NATO ammunition as well as a 40mm barrel to allow for the firing of most military grenade rounds.

**Caliber:** Varies (5.56mm - 40mm), **Overall Length:** 828mm, **Weight:** 2.8 kg with 12 gauge insert, **Feed:** Single-shot, **Sustained Rate of Fire:** Approx. 6 rounds per minute, **Velocity:** 80 m/s, **Blast Diameter:** 7.6 m (25 feet), **Damage:** 2D4 x 10, **Maximum Effective Range:** 400 m (1312 ft). Note: It can also fire smoke, CS, inert batons, and illumination grenades.

### Schermuly multi-purpose riot gun

This weapon consists of a high tensile aluminum barrel and trigger assembly fitted to a hardwood stock. It is able to fire all standard 37/38mm rounds, including smoke, irritant, baton, and illumination. It is a break-open, breech loaded weapon. There is also a 12 gauge adaptor available.

**Caliber:** 38mm, **Overall Length:** 820mm, **Weight:** 2.7 kg, **Feed:** Single-shot, **Sustained Rate of Fire:** Approx. 6 rounds per minute, **Velocity:** 100 m/s, **Blast Diameter:** 6 m (20 feet), **Damage:** 1D6 x 10, **Maximum Effective Range:** 200 m (ft). **Note:** It can also fire smoke, CS, and illumination grenades.

## UNITED STATES

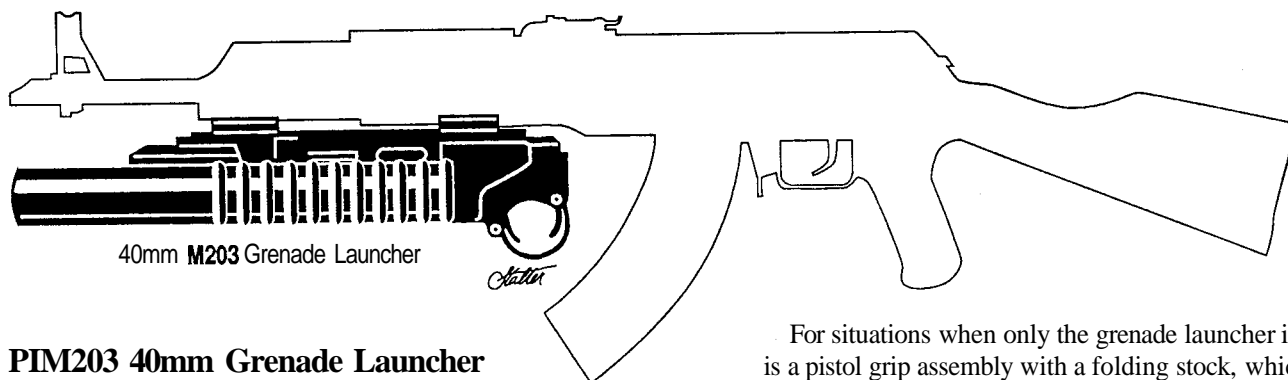

40mm M203 Grenade Launcher

### PIM203 40mm Grenade Launcher

This weapon is the replacement for the M203 grenade launcher which was previously used by the U.S. Armed Forces. This new version makes it much easier to secure to the barrel of the rifle by use of a simple bar which attaches to the rifle. Where the M203 was available for use with only a limited number of weapons, the PIM203 can be used with any type of rifle made today.

For situations when only the grenade launcher is needed, there is a pistol grip assembly with a folding stock, which the launcher can be snapped onto, creating a highly effective long-range weapon.

**Caliber:** 40mm, **Length of Launcher:** 305mm, **Weight:** 2.7 kg, **Feed:** Single-shot, **Sustained Rate of Fire:** Approx. 6 rounds per minute, **Velocity:** 74.7 m/s, **Blast Diameter:** 6 m (20 feet), **Damage:** 1D6 x 10, **Maximum Effective Range:** 400 m (1312 ft). **Note:** It can also fire smoke, CS, inert batons, and



illumination grenades. The old M203 is very similar but with a 300 m (984 ft) effective range.

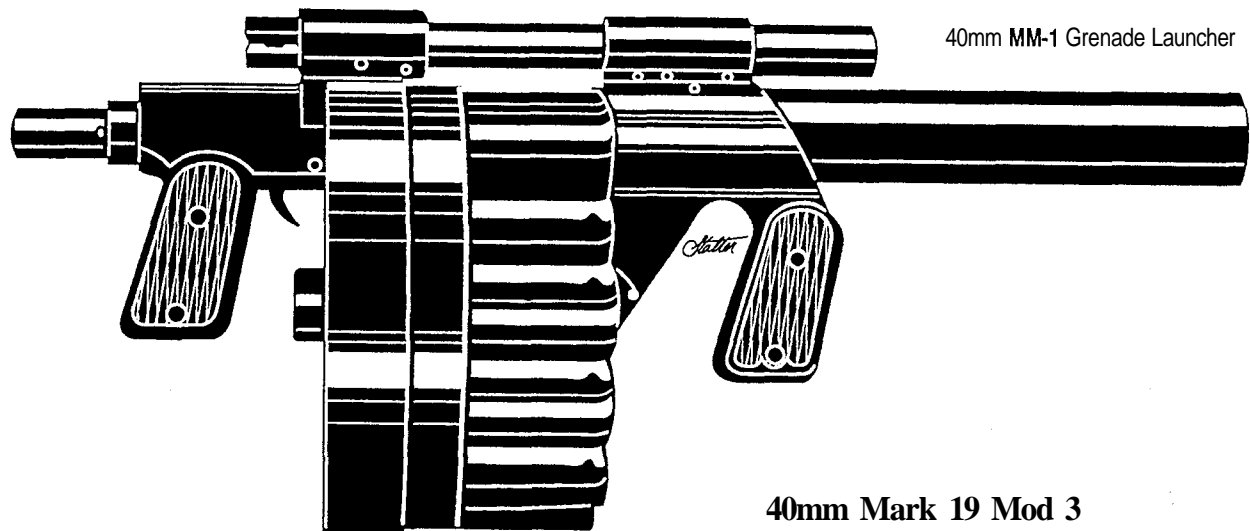

### 40mm MM-1 Multiple Grenade Launcher

This is a high-powered grenade launcher which can be operated by a single man at a high rate of speed. The MM-1 is a revolver-type weapon which can be easily and quickly reloaded with any US and foreign 40mm grenade (up to 101 mm/4 inches in length). Furthermore, it is extremely reliable and as easy to maintain as a service revolver. It is useful in any number of tactical situations and can be an especially effective addition as emergency firepower for boats, helicopters, and tank crews.

**Caliber:** 40mm, **Length of Launcher:** 635mm, **Weight:** 5.7 kg, **Feed:** 12 shot cylinder, spring-assisted, **Sustained Rate of Fire:** Approx. 30 rounds per minute (cyclic: 144 rds/m), **Velocity:** 76 m/s, **Blast Diameter:** 6 m (20 feet), **Damage:** 1D6 x 10, **Maximum Effective Range:** 350 m (1148 ft). **Note:** It can also fire smoke, inert batons, illumination grenades, HE, flame, fragmentation, shape charge (HEAT), CS/chemical gas, and stun/flash grenades.

### 40mm Mark 19 Mod 3 Automatic Grenade Launcher

The Mark 19 is actually a machine gun which fires 40mm grenades! The system was developed by the Navy for use on river patrols in Vietnam. It can be used with a tripod or mounted on a vehicle (*jeep*, truck, tank, boat, helicopter, etc.).

The ammunition used is a unique belt system in that the belt links stay with the cartridge case and are ejected after firing. It can be fired manually or by remote control using an electrical solenoid. It is an excellent weapon to use against both personnel and light armored vehicles. It is used by all US Military Forces. **Caliber:** 40mm of virtually any variety, **Length of Launcher:** 1028mm, **Height:** 206 mm, **Weight:** 34 kg, **Feed:** 20 or 50 round belt, **Sustained Rate of Fire:** 325-375 rounds per minute, **Velocity:** 240 m/s, **Blast Diameter:** 6 m (20 feet), **Damage:** 1D6 x 10, **Approx. Effective Range:** 1600 m (5249 ft). **Mountings:** Turret, pedestal or tripod. **Note:** It can also fire smoke, illumination grenades, HE, AP, flame, fragmentation, shape charge (HEAT), CS/chemical gas, and stun/flash grenades.

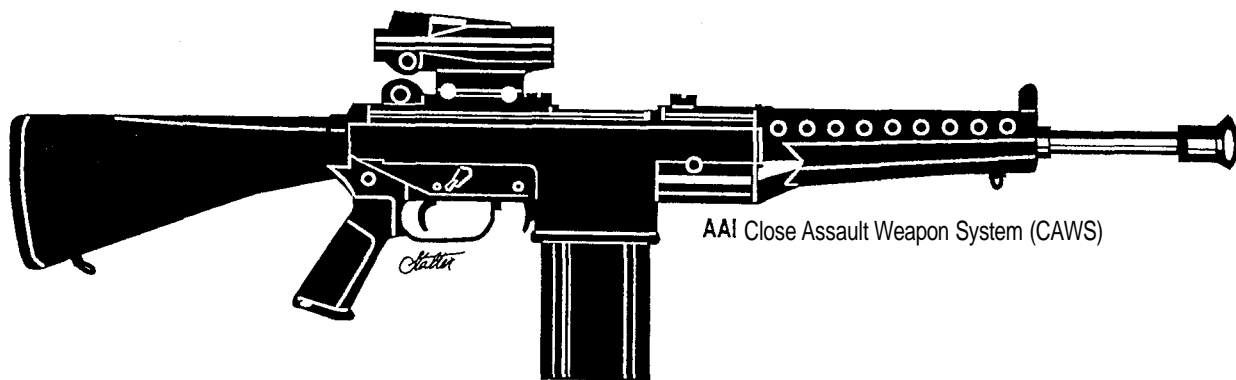

### AAI Close Assault Weapon System (CAWS)

This shotgun type weapon was developed for use by the Navy for quick fire, close combat situations. Its recoil is slightly less than an M-16 rifle, which makes it easy to control in burst fire.

The ammunition for this weapon was specially developed and is slightly larger than a normal 12-gauge cartridge, ensuring that it will not be used in sporting-type weapons. However, it is possible to use a commercial 12-gauge shell in the CAWS unit. The anti-personnel cartridge is loaded with eight flechettes, each

weighing one gram. The accuracy of this round is so good that all eight flechettes will strike within a 4 meter (13 ft) circle at 150 m (492 ft) range. At this range the flechettes will penetrate 76mm of pine or 3mm of light steel!

**Caliber:** 12 gauge special and commercial 12 gauge, **Length:** 984mm, **Weight:** 4.08 kg, **Feed:** 12 round box magazine, **Velocity:** 240 m/s, **Blast Diameter:** 6 m (20 feet), **Damage:** 1D6 x 10, **Approx. Effective Range:** 150 m (492 ft). **Note:** It can also fire smoke, illumination grenades, HE, AP, fragmentation, CS/chemical gas, and stun/flash grenades.

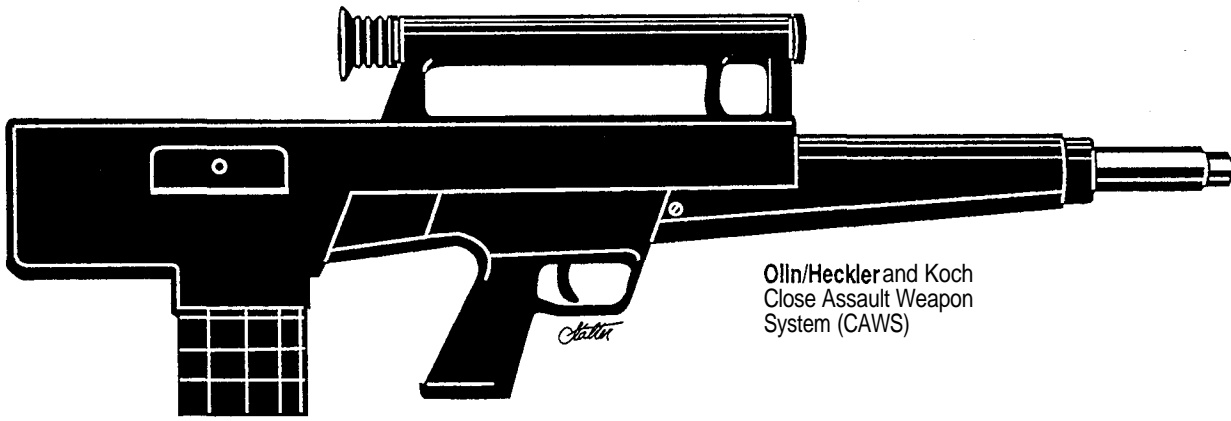

Olin/Heckler and Koch  
Close Assault Weapon  
System (CAWS)

### Olin/Heckler and Koch Close Assault Weapon Systems (CAWS)

This is another close combat weapon which was designed to use a 12-gauge shotgun shell. Once again, the ammunition for this weapon was specially developed so that it could not be used in commercial shotguns. The cartridge for this weapon is loaded with eight tungsten steel pellets, which at 150 m can penetrate 20mm of pine or 1.5mm of light steel plate. It can also be loaded with '000' buck-shot or a flechette package.

**Caliber:** 12-bore 3-inch belted (19.5mm×76) or commercial

12 gauge, **Length Overall:** 764mm, **Barrel Length:** 460mm (with barrel extension 685mm), **Weight:** 3.7 kg with magazine, **Feed:** 10 rounds, **Velocity:** Tungsten alloy cartridge: 538 m/s; '000 Buck' load cartridge: 488 m/s; flechette load cartridge: 900 m/s., **Blast Diameter:** 4 m (13 feet), **Damage:** Varies, 1D4 X 10 HE or fragmentation, 1D4 × 10 flechette (P.V. 6), shotgun slug 5D6, buck-shot 4D6, **Approx. Effective Range:** 150 m (492 ft). **Note:** It can also fire smoke, illumination grenades, HE, AP, CS/chemical gas, and stun/flash grenades.

### Scorpion Urban Fighting Weapon

This weapon is an add-on attachment for an assault rifle. It uses the rifle sights but has its own trigger and firing mechanism. It is capable of penetrating 300 mm of brick or 200 mm of reinforced concrete. It will also penetrate earth and rubble bunkers and light armored vehicles.

**Caliber:** 52mm, **Length of Launcher:** 559mm, **Weight:** 3.17 kg, **Feed:** Single-shot, **Sustained Rate of Fire:** Approx. 5 rounds per minute, **Velocity:** 305 m/second, **Blast Diameter:** 6 m (20 feet), **Damage:** 1D6 x 10, **Maximum Effective Range:** 300 m (984 ft). **Note:** It can also fire smoke, AP, HE, CS, inert batons, and illumination grenades.

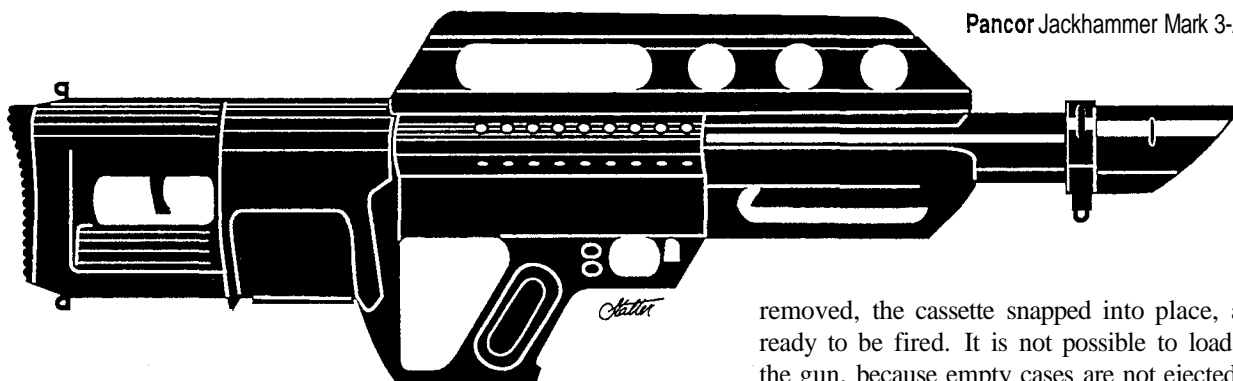

Pancor Jackhammer Mark 3-A2 Combat Shotgun

### Pancor Jackhammer Mark 3-A2

The Jackhammer is an automatic 12-gauge shotgun which uses a pre-loaded cylinder as its magazine. The cylinder which is called the 'Ammo Cassette,' contains 10 shots and is pre-loaded and sealed with a plastic film. It is color coded to indicate the type of round loaded in the ammo cassette. The film is

removed, the cassette snapped into place, and is immediately ready to be fired. It is not possible to load single rounds into the gun, because empty cases are not ejected while firing — the entire cassette must be ejected to reload.

**Caliber:** 12 gauge special, 70mm or commercial, **Length Overall:** 787mm, **Barrel Length:** 525mm, **Weight:** 4.57 kg, **Feed:** 10 rounds, **Rate of Fire:** (cyclic) 240 rounds/min., **Blast Diameter:** 4 m (13 feet), **Damage:** Varies, 1D4 × 10 HE or fragmentation, 1D4 x 10 flechette (P.V. 6), shotgun slug 5D6, buck-shot 4D6, **Approx. Effective Range:** 150 m (492 ft). **Note:** It can

also fire armor piercing (AP), smoke, illumination grenades, CS/chemical gas, and stun/flash grenades.

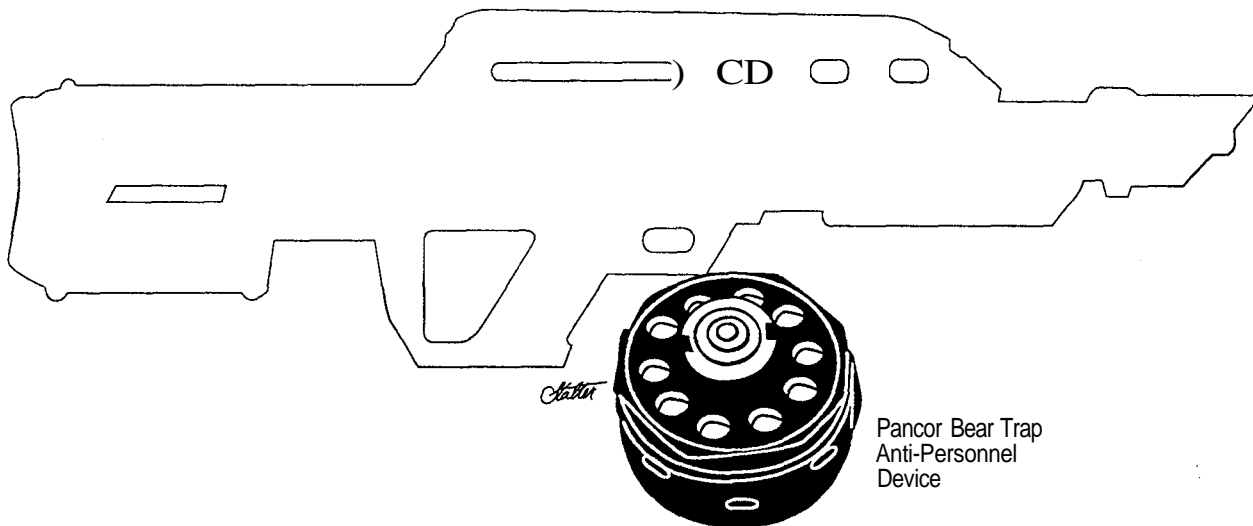

### Pancor 'Bear Trap' Anti-Personnel Device

This is actually an anti-personnel mine which is created from the magazine ("Ammo Cassette") which is used in the Mark 3-A2 Jackhammer. The device consists of three parts, 1) the ammo cassette loaded with one to ten shells, 2) a detonator base containing a firing mechanism which surrounds the lower portion of the cassette, and 3) the detonator plunger or pressure plate. It can be set to fire when pressed or by delay reaction to a spring-loaded 12-hour timer which can be set at one-hour release intervals.

Once assembled, the 'Bear Trap' is put in place with the open end positioned toward the intended target. When activated/triggered, the entire payload is fired in rapid succession (nearly simultaneous). The firing device itself is designed to withstand the blast effect of the discharge so that it can be reused.

**Damage per each round (10 rounds):** 1D4 x 10 HE or fragmentation, 1D4 X 10 flechette (P.V. 6), shotgun slug 5D6, buck-shot 4D6, **Approx. Effective Range:** Contact. Note: It can also fire armor piercing (AP), smoke, illumination grenades, CS/chemical gas, and stun/flash grenades.

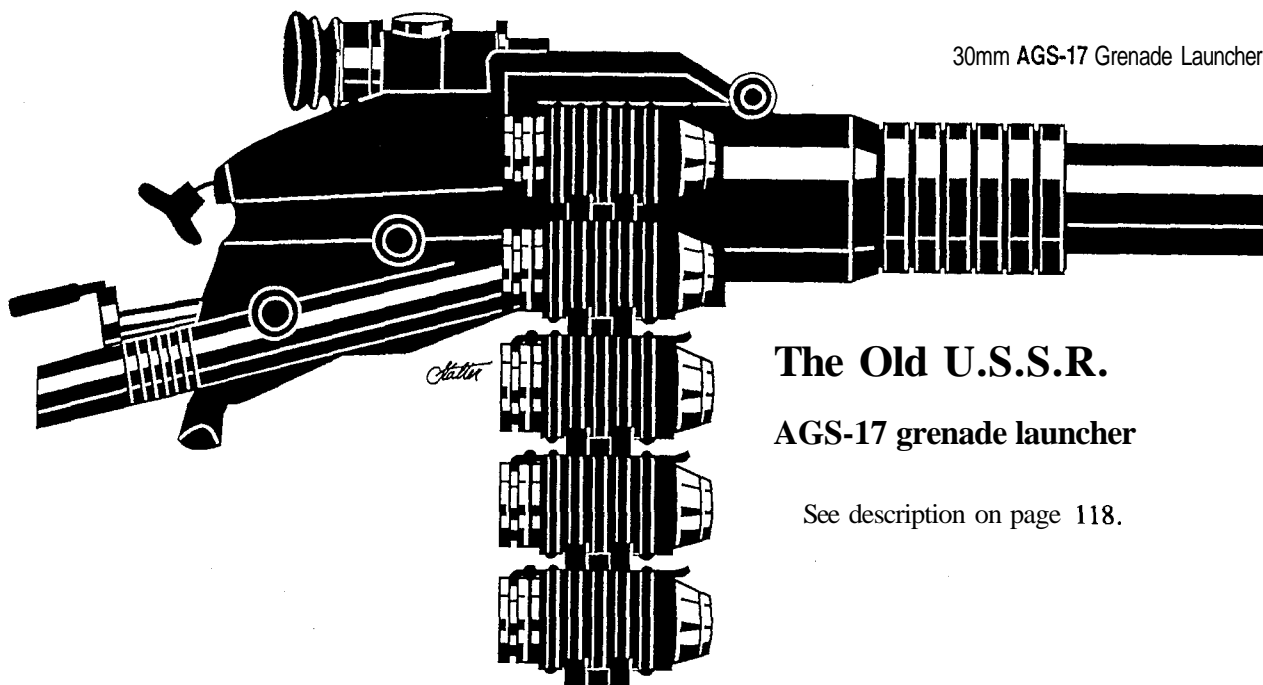

### The Old U.S.S.R. AGS-17 grenade launcher

See description on page 118.

# SPECIAL Support Weapons & Anti-Tank Weapons

**Note:** The damage listed is typically for *anti-tank* high explosive (HE) rounds. Most *anti-tank/rocket* launchers can also fire armor piercing (AP) rounds which can penetrate 50-100mm of reinforced steel plate (but only half the blast diameter), smoke (30

seconds duration) and illuminating rounds (300,000 candela; 30 second duration). Some also fire HEAT and guided missiles. Many *anti-tank* missiles and rockets, especially guided systems, are also effective against helicopters and slow, low flying aircraft.

## AUSTRIA

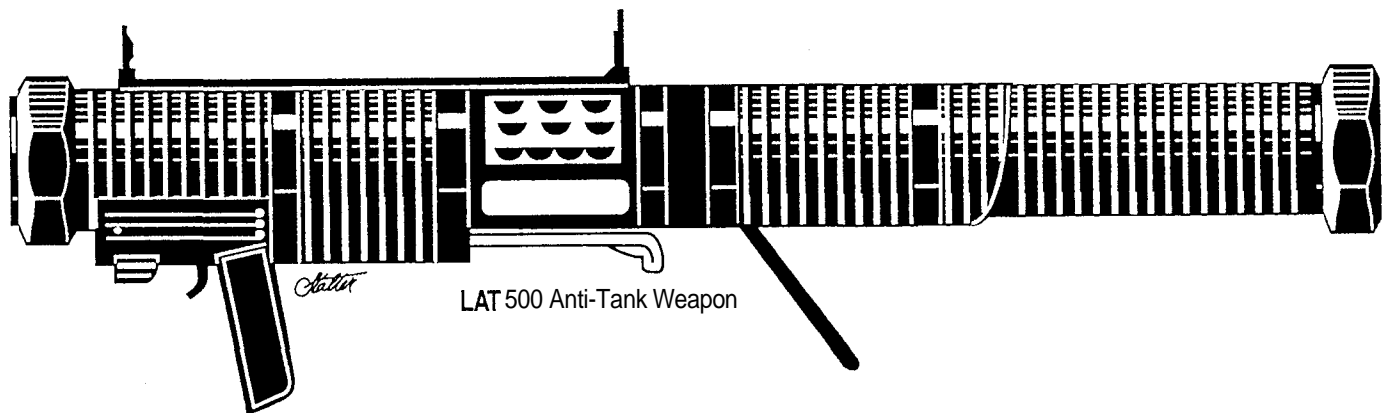

### LAT 500 Anti-Tank Weapon

The Light Anti-Tank 500 (LAT) is a disposable shoulder-fired weapon for infantry use. The weapon is completely self-contained and can be fired in confined spaces such as rooms or pillboxes.

**Caliber:** 82mm, **Overall Length:** 900mm, **Total Weight:** 7 kg, **Weight of Projectile:** 1.6 kg, **Feed:** Single-shot, **Penetration:** 500mm of armor or 1000mm of concrete, **Velocity:** 255 m/s, **Blast Diameter:** 12 m (40 feet), **Damage:** 1D4 x 100, **Approx. Effective Range:** 400 m (1312 ft).

## CHINA

### Red Arrow 8 Guided Weapon System

This is a guided missile system that is designed to be used by the infantry against tanks and other armored targets which are 100 to 3000 m away. It can be fired from a ground mount or vehicle mounted tripod. It is controlled by a SACLOS system based on infrared tracking.

**Warhead Diameter:** 120mm, **Missile Weight:** 11.2kg, **Missile Length:** 875mm, **Launch Tube Length:** 1566mm, **Launch Tube Weight:** 24.5 kg, **Flight Velocity:** 200-240 m/s, **Penetration:** 800mm, **Blast Diameter:** 21 m (70 feet), **Damage:** 1D6 x 100, **Approx. Effective Range:** 100-3000 m (328 to 9843 ft), **Hit Probability:** 90%.

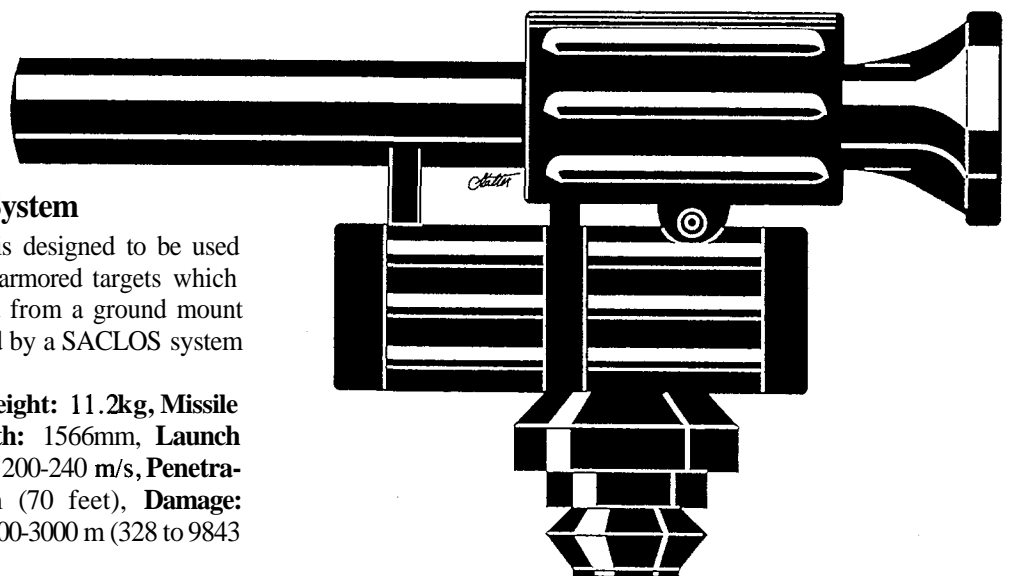



### 40mm Type 69 Anti-Tank Grenade Launcher

A shoulder-fired, bazooka/LAW styled weapon that is a local variant of the Soviet RPG-7.

**Caliber:** 40mm, **Length:** 992mm, **Launch Velocity:** 300 m/s, **Weight:** Launcher: 7 kg, missile: 2.25 kg, **Feed:** Single-shot, **Rate of Fire:** 3-4 rounds per minute, **Penetration:** 120mm armor, **Blast Diameter:** 12 m (40 feet), **Damage:** HEAT 1D6 × 10, **Approx. Effective Range:** 200 m (656 ft).

## CZECHOSLOVAKIA

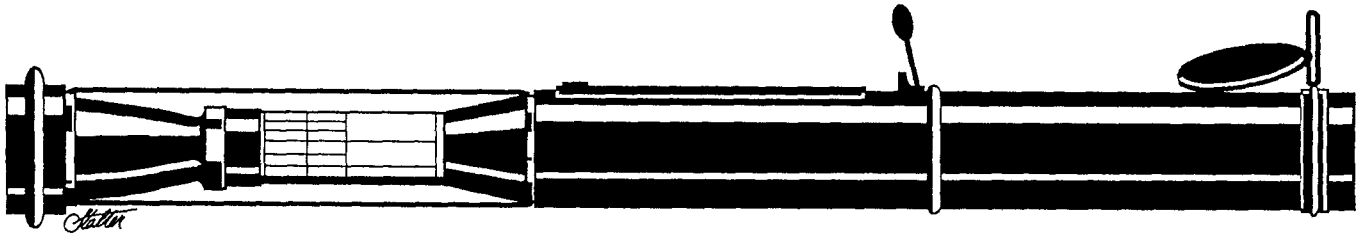

### RPG-75 Light Anti-Armor Weapon

The Rocket Projectile Gun (RPG)-75 is a shoulder-fired, bazooka/LAW styled weapon that is a local variant of the Soviet RPG-18.

**Caliber:** 68mm, **Weight, firing:** 3.1 kg, **Length:** (folded) 633mm, (extended) 890mm, **Launch Velocity:** 189 m/s, **Feed:** Single-shot, **Rate of Fire:** 3-4 rounds per minute, **Penetration:** 300mm, **Blast Diameter:** 12 m (40 feet), **Damage:** 4D4 × 10, **Approx. Effective Range:** Moving target: 200 m (656 ft), stationary target: 300 m (984 ft).



### Type P-27 (Pancerovoka) Anti-Tank Grenade Launcher

A shoulder-fired, bazooka/LAW styled weapon that is a local variant of the Soviet RPG-18.

**Caliber:** 45mm, **Length:** 1092mm, **Launch Velocity:** 150 m/s, **Weight:** Launcher: 2.83 kg, missile: 3.3 kg, **Feed:** Single-shot, **Rate of Fire:** 3-4 rounds per minute, **Penetration:** 250mm, **Blast Diameter:** 12 m (40 feet), **Damage:** HEAT 1D4 × 10, **Approx. Effective Range:** 200 m (656 ft).

## FINLAND

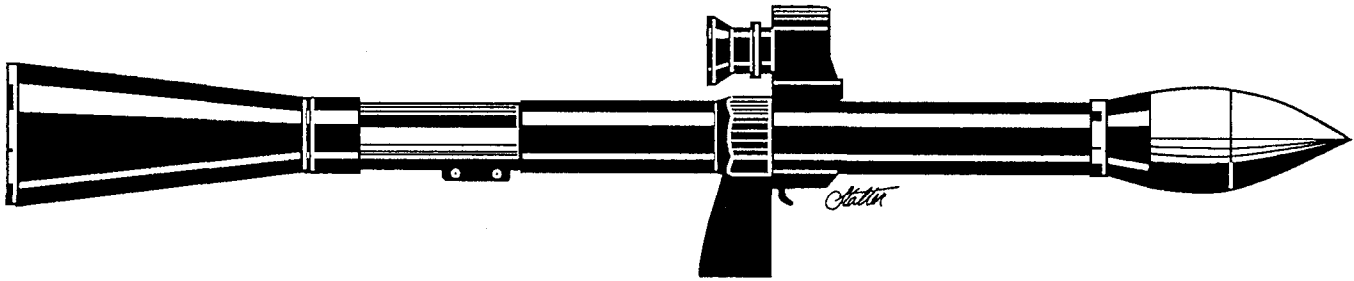

### M-55 recoilless launcher

A shoulder-fired launch tube fitted with an optical sight, the M-55 is the light anti-tank weapon of the Finnish Army.

**Caliber:** 55mm, **Weight:** 8.5 kg (11 kg loaded), **Length:** (unloaded) 940mm, (loaded) 1240mm, **Launch Velocity:** 120 m/s,

**Feed:** Single-shot, **Rate of Fire:** 2-3 rounds per minute, **Penetration:** 200mm, **Blast Diameter:** 12 m (40 feet), **Damage:** 3D6 x 10, **Approx. Effective Range:** Moving target: 200 m (656 ft), stationary target: 300 m (984 ft).

## FRANCE

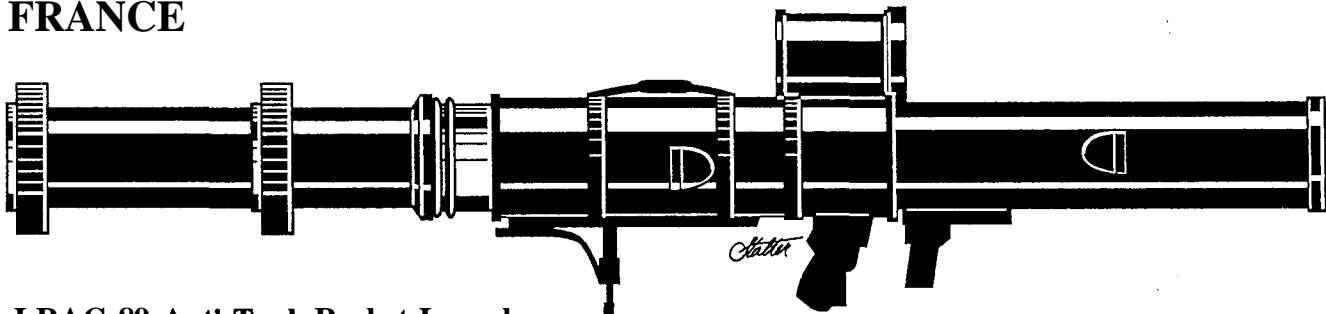

### LRAC 89 Anti-Tank Rocket Launcher

This weapon consists of a plastic and fiberglass launch tube (fitted with sight, trigger mechanism, and bipod) and a self-contained rocket which is attached to it prior to firing. The fuse of the rocket cannot function until the container is screwed into the launcher. The rocket is armed by the propellant gas after it is fired. The minimum distance to rocket arming is 10 meters (32 ft).

The anti-armor warhead is capable of penetrating 120mm of armor at a 65 degree angle; it is also effective against spaced armor arrangements, defeating a 40mm plate and a 110mm plate, both set at 65 degrees and separated by a gap of 150mm. An anti-personnel/anti-vehicle round is also used which has a warhead made out of molded steel balls which break up into about 1600 projectiles. Two smoke rounds are available, one containing a liquid smoke generating compound which produces

a thick blanket upon bursting. The other smoke round has a phosphorus head which produces smoke more slowly but has an incendiary effect (it burns for about 35 seconds). Parachute flare rockets are available as well, which burn for about 30 seconds.

**Caliber:** 89mm, **Weight:** 5.5 kg (8.2 kg loaded), **Length:** (folded) 1.17 m, (extended) 1.6m, **Launch Velocity:** 300 m/s, **Feed:** Single-shot, **Rate of Fire:** 3-4 rounds per minute, **Penetration:** 400mm steel, 1300mm concrete, **Blast Diameter:** 24.4 m (80 feet), **Damage:** AP 1D4 x 100, **Effective Range:** (anti-tank) 600 m (1969 ft), (maximum range) 2000 m (6562 ft).

**Note:** In addition to anti-tank rockets, the LRAC can fire armor piercing (AP penetrating 100mm of steel), smoke and illuminating rounds (300,000 candela; 30 second duration).

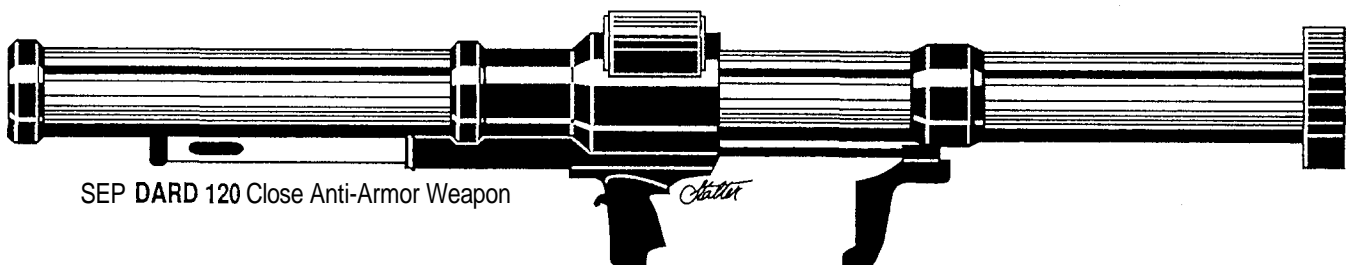

SEP DARD 120 Close Anti-Armor Weapon

### SEP DARD 120 Close Anti-Armor Weapon

The DARD was designed to defeat battle tanks head-on at ranges of up to 600 m (1969 ft) and at an ideal combat range of 300 m (984 ft). It is a shoulder-fired weapon that normally requires a crew of two to operate at full effectiveness. It can currently defeat any armor vehicle/tank in service and should be able to defeat any future tanks as well.

**Caliber:** 120mm, **Weight:** 14 kg (loaded/ready to fire), **Length:** 1.6 m (ready to fire), **Launch Velocity:** 280 m/s, **Feed:** Single-shot, **Rate of Fire:** 4-6 rounds per minute, **Penetration:** 820mm, **Blast Diameter:** 24.4 m (80 feet), **Damage:** HEAT 2D4 x 100, **Approx. Effective Range:** 600 m (1969 ft). **Note:** DARD utilizes a standard optical sight.

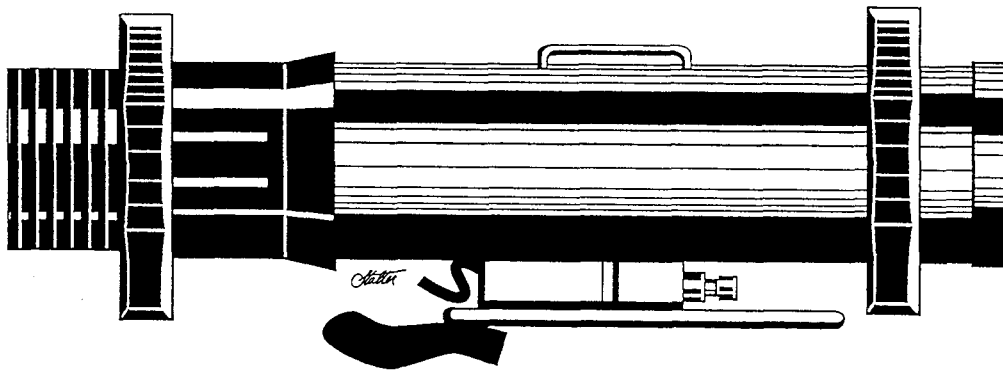

### Eryx Anti-Tank Missile

This weapon was designed to be used by forward infantry and had the requirements of ease of transport, highly accurate fire, and the capability of defeating any armor currently in service. The Eryx consists of a missile packaged in a container/launch tube which is attached to a compact firing unit which contains the ignition and control systems. The whole assembly sequence can be done in less than five seconds. The missile carries an infrared beacon which is detected by the launch unit. Corrections

in course are sent via a wire link which unspools behind the missile. The weapon is usable in confined spaces, with only about two meters behind it required.

**Caliber:** 160mm, **Weight:** 11 kg (loaded/ready to fire), **Length:** 925mm (ready to fire), **Launch Velocity:** 300 m/s, **Feed:** Single-shot, **Rate of Fire:** 4-6 rounds per minute, **Penetration:** 900mm, **Blast Diameter:** 24.4 m (80 feet), **Damage:** 1D6 x 100, **Approx. Effective Range:** 600 m (1969 ft).

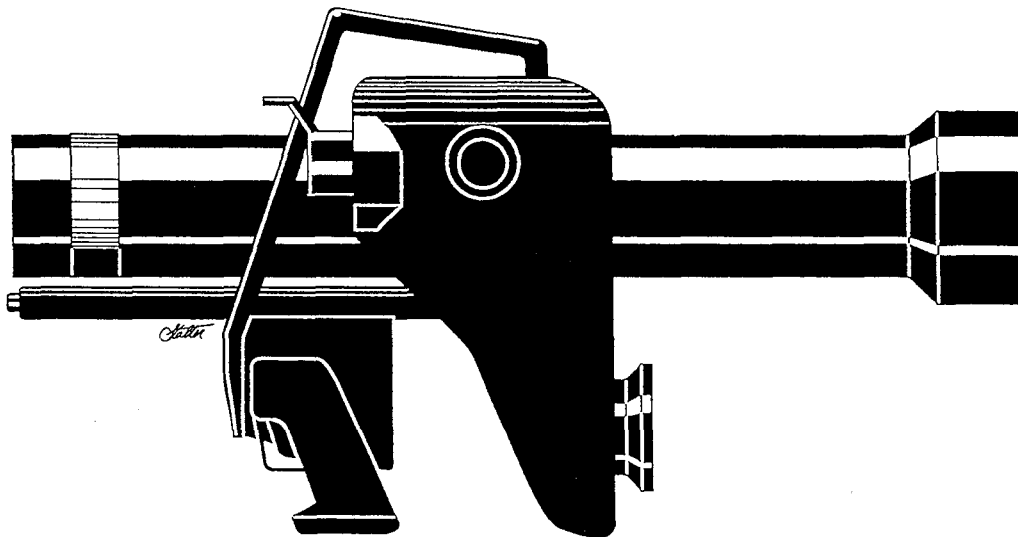

### MILAN Anti-Tank Weapon

The MILAN (Missile d'Infanterie Leger Anti-char) was designed to be used by infantry from a defensive position. It was originally developed by a French-German consortium called Euromissile. It is a wire-guided SACLOS missile system whose operator need only keep the target in the cross-hairs. A flare on the missile is detected by the launch unit and a computer relays target corrections via the wire.

The entire weapon system consists of a missile loaded into a sealed container/launcher, a combination launcher/guidance unit with an optical/infrared sight tracking system, and a tripod. In addition, the weapon can be fitted with the MIRA-thermal imaging system which allows night firing at up to two kilometers (1 1/4 miles); the sight weighs nine kilograms and is mounted on the standard firing post.

The MILAN 2 was introduced in 1984 to improve the weapon's performance against tanks. It has a missile caliber of 115mm and the fuse is mounted on a forward probe which adds about

145mm to its length. In this configuration it is capable of penetrating up to 1060mm of armor.

**Caliber:** 103mm, **Weight:** 16.4 kg (loaded/ready to fire), **Length:** 900mm (ready to fire), **Weight of Missile:** 6.5 kg, **Launch Velocity:** 75 m/s initial, 200 m/s after 13 seconds, **Feed:** Single-shot, **Rate of Fire:** 4-6 rounds per minute, **Penetration:** 900mm, **Blast Diameter:** 21 m (70 feet), **Damage:** HEAT 1D6 X 100 or HE 1D4 X 100, **Approx. Effective Range:** 25-2000 m (85-6562 ft).

### APILAS anti-armor weapon

The APILAS (Armor Piercing Infantry Light Arm System) is a disposable launcher carrying a HEAT warhead rocket. The storage/launch tube is made of fiberglass and has a retractable optical sight. The warhead of the rocket is armed by gas pressure from the engine and is safe up to 25 meters (85 ft) from the

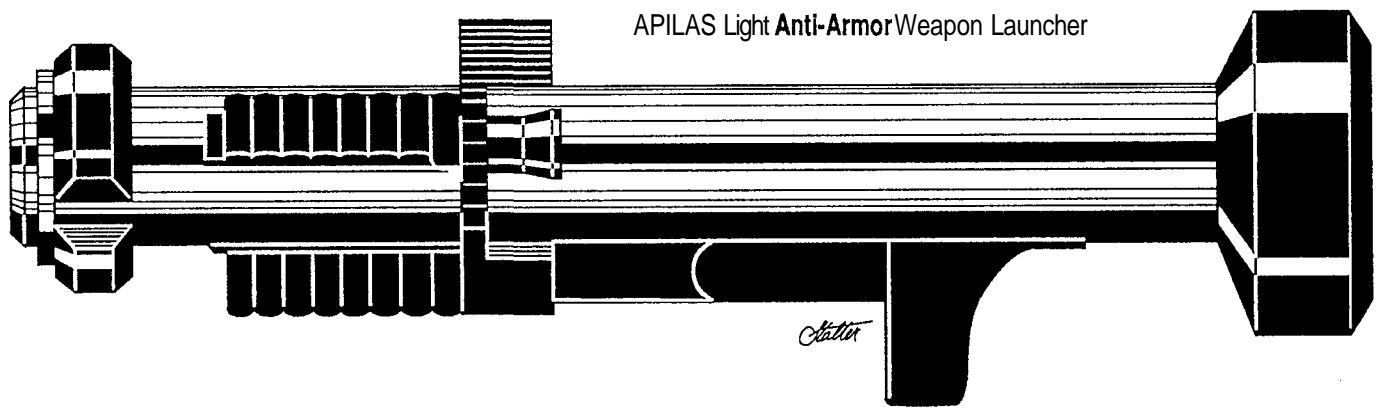

firer. The long warhead nose cone causes detonation even on a glancing blow to the target.

**Caliber:** 112mm, **Weight:** 16.4 kg (loaded/ready to fire), **Length:** 1.29 m (ready to fire), the rocket is 925mm, **Weight of Rocket:** 4.3 kg, **Launch Velocity:** 293 m/s initial, **Feed:** Single-shot, **Penetration:** 700mm armor, 2000mm concrete, **Blast Diameter:** 21 m (70 feet), **Damage:** HEAT 1D6 × 100, **Approx. Effective Range:** 330 m (1083 ft).

## GERMANY

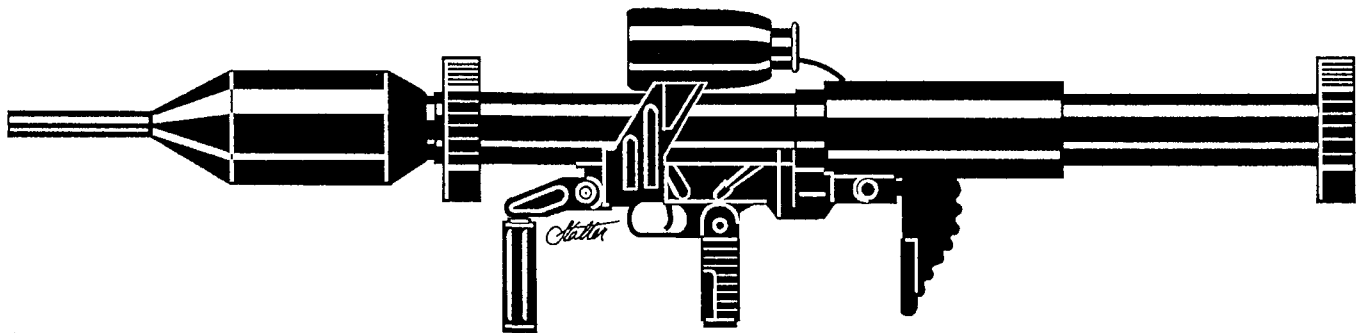

### Panzerfaust 3

The Panzerfaust is a lightweight, reusable, portable, shoulder-fired weapon system. This system has proven effective against MBTs (Main Battle Tanks). The total system consists of a disposable cartridge with a 110mm warhead, and a reusable firing and sighting device. It can be fired in confined spaces, permitting its use in built up areas. It is possible to use the launcher in darkness by fitting a target marker to the sight tube and having the firer wear infrared goggles.

A variety of warheads have been designed for the Panzerfaust including HEAT in 125mm, 110mm, and 90mm; HESH; smoke – both standard and infrared screening (phosphorus); illuminating flare; and fragmentation.

Two specialized firing mounts for the weapon have been developed: the Tire **Salamander** and an Off-route Mine System. **The Fire Salamander** is an autonomous firing mount which carries four launchers around a central command sensor unit. It can be set for automatic fire according to some pre-set criteria (noise level, infrared signature, etc.) or by remote control via video camera.

**Caliber:** 60mm for the launcher, 110mm projectile, **Weight:** 12 kg (loaded/ready to fire), **Length:** 1.2 m (ready to fire), **Weight of Rocket:** 3.8 kg, **Launch Velocity:** 250 m/s, **Feed:** Single-shot, **Rate of Fire:** 6 rounds per minute, **Penetration:** 700 + mm, **Blast Diameter:** 21 m (70 feet), **Damage:** HEAT 2D4 x 100, **Approx. Effective Range:** Tank/moving targets: 330 m (1083 ft), stationary targets: 500 m (1640 ft).



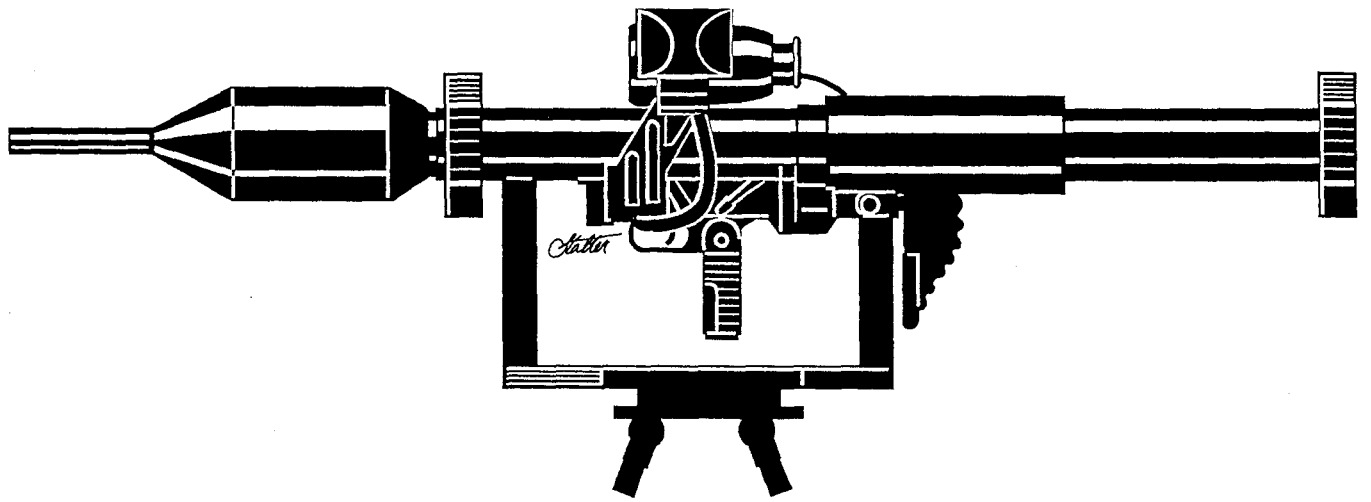

### Panzerfaust Off-Route Mine System

The Panzerfaust 3 may be converted to a mine system by the addition of the **SIRA** acoustic-infrared sensor. The **SIRA** unit is fitted to the weapon by means of the portion which would usually accept the dovetail firing device.

The sensor will detect any approaching targets by the use of the acoustic function, it will then activate the infrared sensor. The activated sensor will determine the **speed**, **distance**, direction of movement, and temperature and then send the signal to fire

to a microprocessor in the unit. The Mine System is a single-shot autonomous weapon with an effective range of 150 meters and has an operational time of up to 40 days from set-up.

**Target speed range:** 30-60 km/h, **Dimensions of sensor:** 100mm×150mm, **Operational time:** up to 40 days, **Power supply:** 2 x 3.4 V lithium cells, **Blast Diameter:** 21 m (70 feet), **Damage:** HEAT 2D4 x 100, **Approx. Effective Range:** up to 150 m, **Special functions:** Programmable target counting; direction of movement discrimination. **Hit Probability:** 90%.

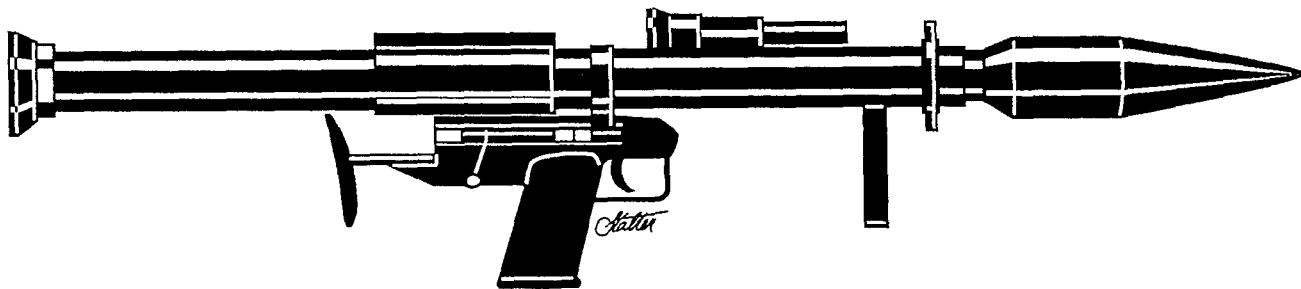

### PZF 44 2A1 (Lanze)

This weapon is also known simply as the Panzerfaust and traces its ancestry to the closing days of WWII. In service since the early 1960's, it consists of an open-ended tube with a pistol grip and firing mechanism underneath on the point of balance. A telescopic sight is mounted on the left side just forward from the grip. The ammunition is in two parts; the warhead and rocket motor in one and the propelling charge in the other.

The Lanze is armed by pushing the **propellant** stick into the front of the tube until only the top is protruding. The rear of the rocket is then pushed down into an indentation on the propellant charge, locking them together. The rocket is then pushed into the launcher until only the warhead is protruding. When it is

fired, a recoilless effect is achieved by the igniting propellant charge shooting out a counter-mass of iron filings to the rear as the rocket goes forward. Safe rear distance is only about two meters (7 ft). Warheads for this weapon include both HEAT and fragmentation.

**Caliber:** 67mm, **Weight:** 10.3 kg (loaded/ready to fire), **Length:** 1162 mm (ready to fire), **Launch Velocity:** 210 m/s, **Feed:** Single-shot, **Rate of Fire:** 4-6 rounds per minute, **Penetration:** 370mm, **Blast Diameter:** 21 m (70 feet), **Damage:** HEAT 1D6 x 100 or Frag. 4D4 x 10, **Approx. Effective Range:** Tank/moving targets: 330 m (1083 ft), stationary targets: 400 m (1312 ft).



### Armbrust Anti-Armor & Self Defense Weapon

This weapon is relatively unique in that it emits no smoke or flash when it is fired and it is quieter than a pistol shot! This allows the firer a very good chance of remaining concealed after the rocket has been launched. This is achieved by sealing the launching propellant between two pistons within the launch tube. The forward piston propels the rocket and the rear one propels the counter-mass in the form of plastic/metal composite rods. It

requires a rear safety zone of less than one meter (3 1/2 ft).

**Caliber:** 47mm, **Weight:** 6.3 kg (loaded/ready to fire), **Length:** 850 mm (ready to fire), **Launch Velocity:** 300 m/s, **Feed:** Single-shot, disposable, **Penetration:** 300mm, **Blast Diameter:** 12 m (40 feet), **Damage:** 3D4 x 10, **Approx. Effective Range:** Tank/moving targets: 330 m (1083 ft), stationary targets: 1500 m (4921 ft).

## ISRAEL

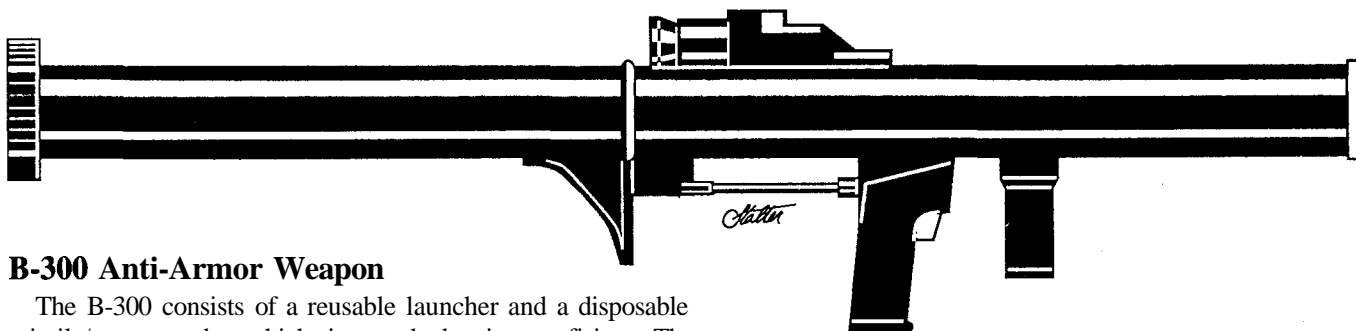

### B-300 Anti-Armor Weapon

The B-300 consists of a reusable launcher and a disposable missile/storage tube which is attached prior to firing. The launcher can be fitted with a telescopic sight or a starlight scope as needed. In addition to the basic HEAT round there are also illuminating and HEFT rounds. A HEFT round (High Explosive Follow Through) blows a hole in a target using a shaped charge and then launches a secondary explosive into the interior.

**Caliber:** 82mm, **Weight:** 3.65 kg (launcher, empty), **Length:** 1440mm (loaded and ready to fire), 775 mm unloaded, **Weight of the Rocket:** 4.5 kg, **Launch Velocity:** 270 m/s, **Feed:** Single-shot, **Rate of Fire:** 3 rounds per minute, **Penetration:** 450mm, **Blast Diameter:** 21 m (70 feet), **Damage:** 1D6 x 100 (HEAT or HEFT), **Approx. Effective Range:** Tank/moving targets: 400 m (1312 ft).

## ITALY

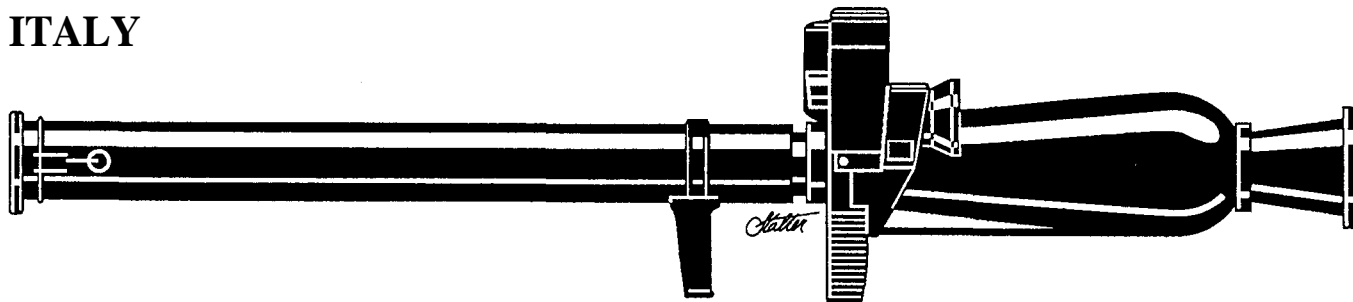

### Folgore Anti-Tank Rocket

The Folgore comes in two versions, a tripod mounted one-man version and a single man bipod or shoulder-mounted type. The tripod version is fitted with an optical/electronic sighting and aiming device which allows the firer to gauge range, target speed, and elevation angle quickly. The shoulder version is fitted with a lighter optical sight. Both systems fire the same rockets.

**Caliber:** 80mm, **Weight:** 18.9 kg shoulder version, 27 kg with tripod, **Length:** 1.85 m (loaded and ready to fire), **Launch Velocity:** 300 m/s, **Feed:** Single-shot, **Rate of Fire:** 4 rounds per minute, **Penetration:** 80mm, **Blast Diameter:** 21 m (70 feet), **Damage:** 1D4 x 100, **Approx. Effective Range:** (anti-tank) 1000 m (3280 ft), **Maximum Range:** 4500 m (14,764 ft), **Hit Probability:** 75% when firing beyond 1000 m.

# SPAIN

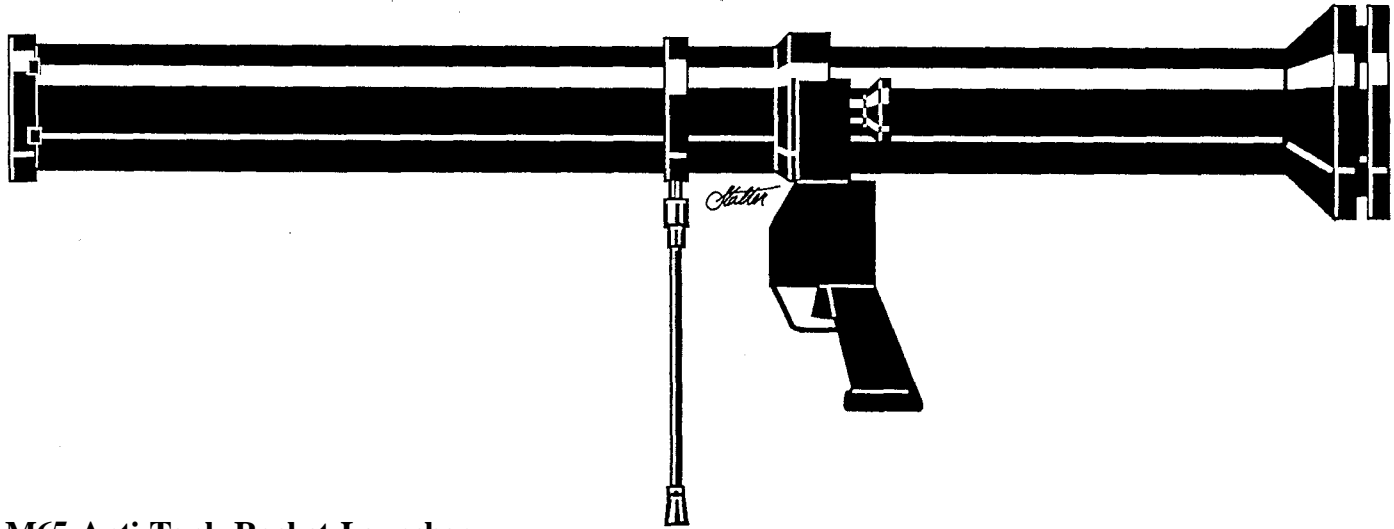

## M65 Anti-Tank Rocket Launcher

The M65 launch tube is fitted with an electromagnetic firing device, optical sight, and bipod. The types of rounds used with it are anti-tank (HEAT), fragmentation, and smoke.

**Caliber:** 89mm, **Weight:** 6 kg, **Length:** 1640 mm (loaded and ready to fire), **Launch Velocity:** 250 m/s, **Feed:** Single-shot, **Rate of Fire:** 4 rounds per minute, **Penetration:** 250 to 400mm, **Blast Diameter:** 21 m (70 feet), **Damage:** 1D6 X 100, **Approx. Effective Range:** (anti-tank) 1000 m (3280 ft), **Maximum Range:** 1300 m (4,265 ft), **Hit Probability:** 75% when firing beyond 1000 m.

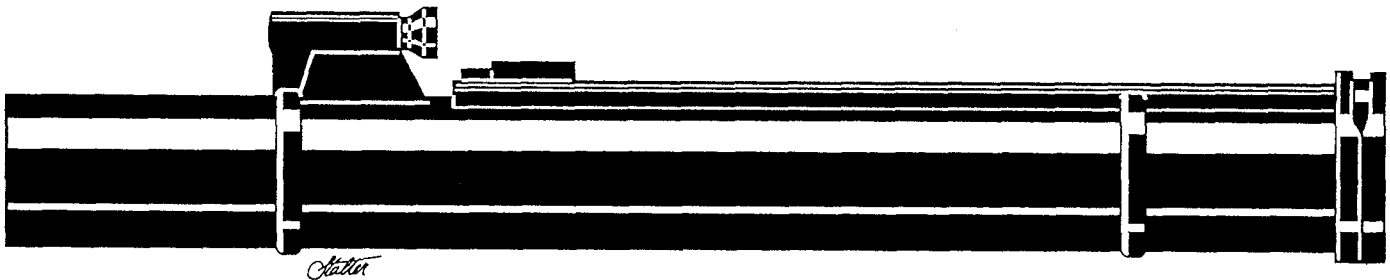

## C-90 C and CR Anti-Tank Weapons

This self-contained system consists of a fiberglass/plastic tube, containing the rocket, fitted with optical sight, firing mechanism, and carrying strap. There are a variety of variant models of the C-90 rockets.

The C is an anti-tank round but can penetrate up to 1000 mm of concrete; it has an effective range against vehicles of 200 meters (656 ft). The C-AM is an anti-tank/anti-personnel fragmentation round which can penetrate 600mm of concrete.

The CR is an anti-tank round, effective up to 300 meters (984 ft), which can penetrate 1000 mm of concrete. The CR-RB is also anti-tank round but can penetrate 480mm of steel or 1200mm

of concrete. The CR-AM is an anti-tank/anti-personnel round capable of penetrating 220mm of steel or 600mm of concrete.

**Caliber:** 90mm, **Weight:** 4.45 kg, **Length:** 940mm (loaded and ready to fire), **Launch Velocity:** 160 m/s, **Feed:** Single-shot, **Rate of Fire:** 4 rounds per minute, **Penetration:** 100 to 480 mm of steel or 400 to 1000mm of concrete, **Blast Diameter:** 21 m (70 feet), **Damage:** Frag. 4D4 x 10 or Anti-Tank HE 1D4 x 100, **Approx. Effective Range:** (anti-tank) 600 m (1969 ft), **Maximum Range:** 800 m (2625 ft), **Hit Probability:** 85% when firing beyond 600 m.

## SWEDEN

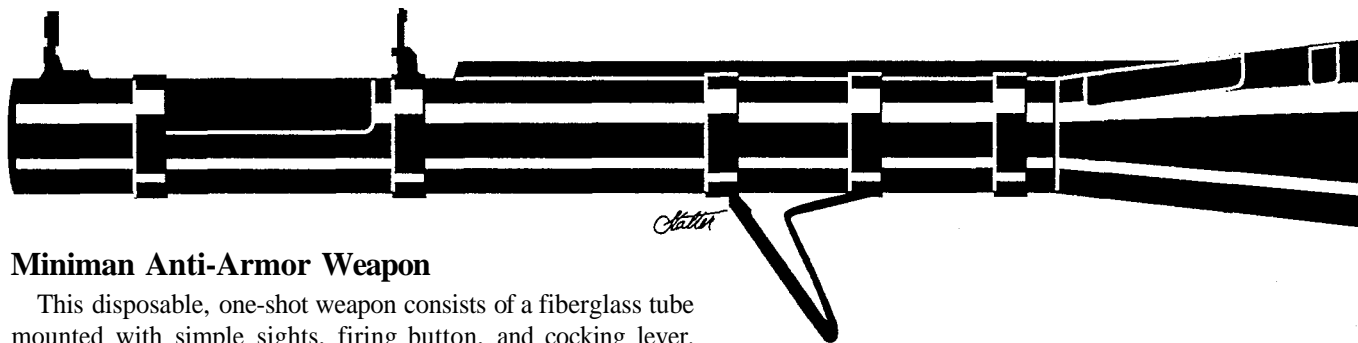

### Miniman Anti-Armor Weapon

This disposable, one-shot weapon consists of a fiberglass tube mounted with simple sights, firing button, and cocking lever. Against moving targets the effective range is about 150 meters (492 ft). The shell is stabilized by small fins which deploy after it leaves the launcher. Two weapons per carrying case.

**Caliber:** 74mm, **Weight:** 7.5 kg, **Length:** 325mm (loaded and ready to fire), **Launch Velocity:** 160 m/s, **Feed:** Single-shot, disposable, **Rate of Fire:** One, **Penetration:** 340 mm, **Blast**

**Diameter:** 15 m (50 feet), **Damage:** Frag. 4D4 × 10 or Anti-Tank HE 1D4 × 100, **Approx. Effective Range:** (moving targets) 150 m (492 ft), **Maximum Range:** 300 m (984 ft), **Hit Probability:** 65% when firing beyond 150m at moving targets.

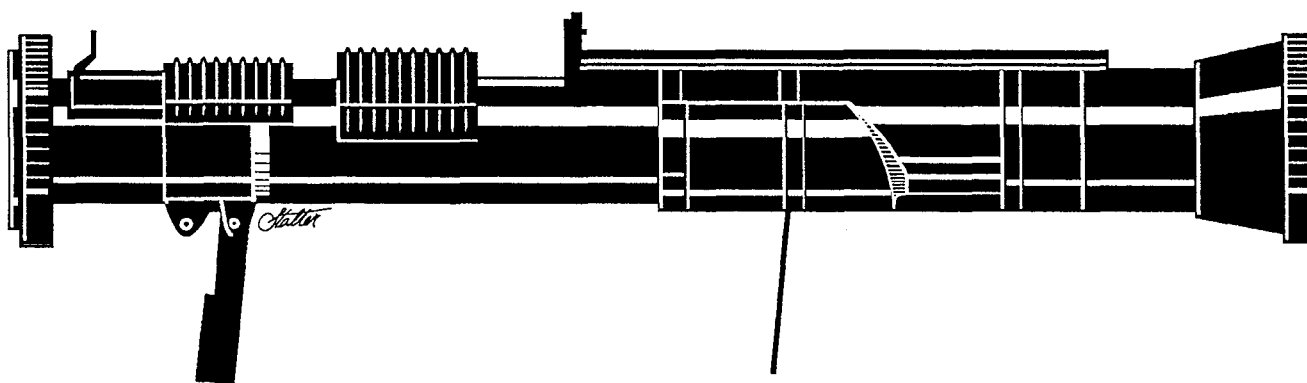

### AT4 FFV Anti-Armor Weapon

This disposable weapon is fitted with simple sights, a forward grip holding the firing mechanism, shoulder stop, and carry strap. Its HEFT warhead is designed primarily for use against armored personnel carriers and light tanks. It has a backblast of 2 to 4 meters (7-13 ft).

**Caliber:** 84mm, **Weight:** 6 kg, **Length:** 1000mm (loaded and ready to fire), **Launch Velocity:** 290 m/s, **Feed:** Single-shot, disposable, **Rate of Fire:** One, **Penetration:** 450 mm, **Blast Diameter:** 21 m (70 feet), **Damage:** HEFT 1D4 X 100, **Approx. Effective Range:** 300 m (984 ft).

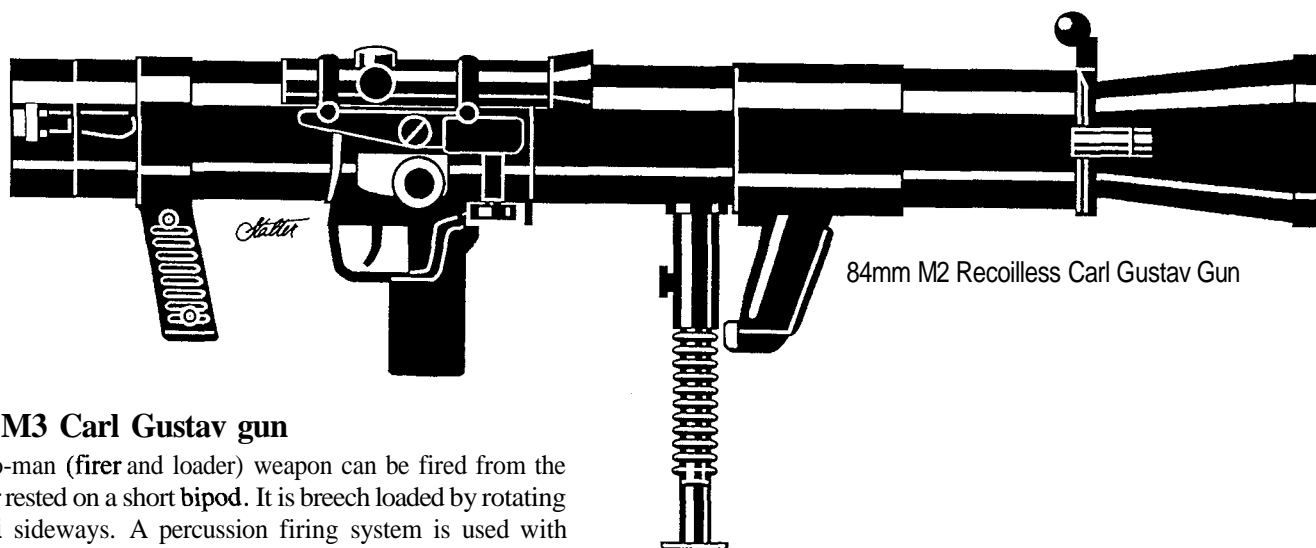

84mm M2 Recoilless Carl Gustav Gun

### M2 and M3 Carl Gustav gun

This two-man (firer and loader) weapon can be fired from the shoulder or rested on a short bipod. It is breech loaded by rotating the venturi sideways. A percussion firing system is used with the mechanism mounted in a small tube on the right side of the main barrel. Although simple sights are provided, the launcher is normally fitted with an optical system.

The M3 is a lighter version of the standard M2 launcher. Although the liner and venturi are steel, the launch tube and all other external parts are fiberglass, plastic, or aluminum.

**Caliber:** 84mm, **Weight:** 15 kg, **Length:** 1130mm (loaded and ready to fire), **Launch Velocity:** 310 m/s, **Feed:** Single-shot, **Rate of Fire:** 4-6 rounds per minute, **Penetration:** 400 mm, **Blast Diameter:** 15 m (50 feet), **Damage:** HE 1D4×100 or Frag. 4D6 X 10, **Approx. Effective Range:** HE or frag. 450 m (1476 ft), smoke: 1000 m (3280 ft), illuminating: 2000 m (6562 ft).

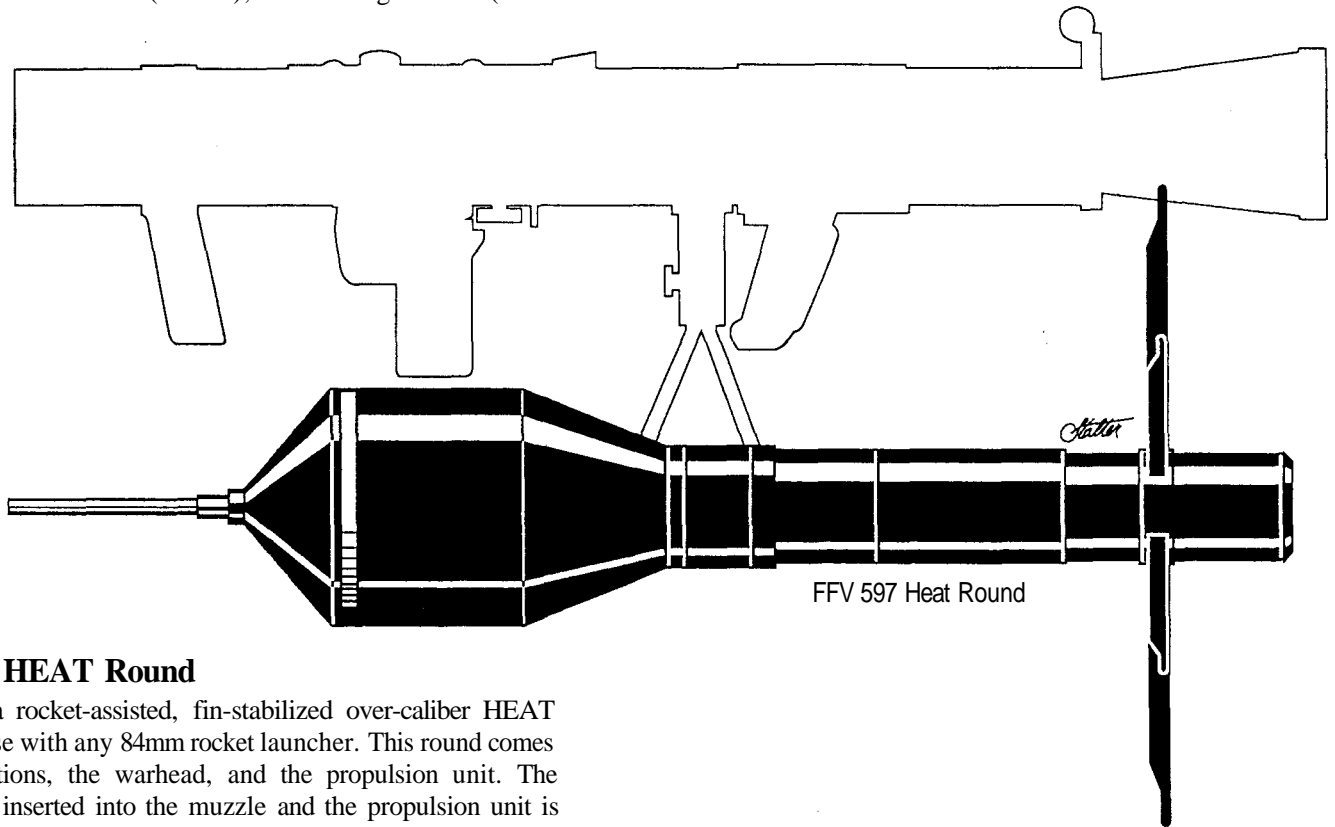

### FFV 597 HEAT Round

This is a rocket-assisted, fin-stabilized over-caliber HEAT round for use with any 84mm rocket launcher. This round comes in two sections, the warhead, and the propulsion unit. The warhead is inserted into the muzzle and the propulsion unit is loaded from the rear like a normal round. The two are joined inside the barrel by a connecting device.

**Caliber:** 132mm, **Weight of Rocket:** 9.5 kg (complete round) (propulsion unit 3 kg); **Length:** (loaded) 1.5 m, (warhead: 750mm), **Muzzle Velocity:** 115 m/s, **Penetration:** 900mm, **Damage:** 2D4×100, **Effective Range:** 300 m (984 ft).

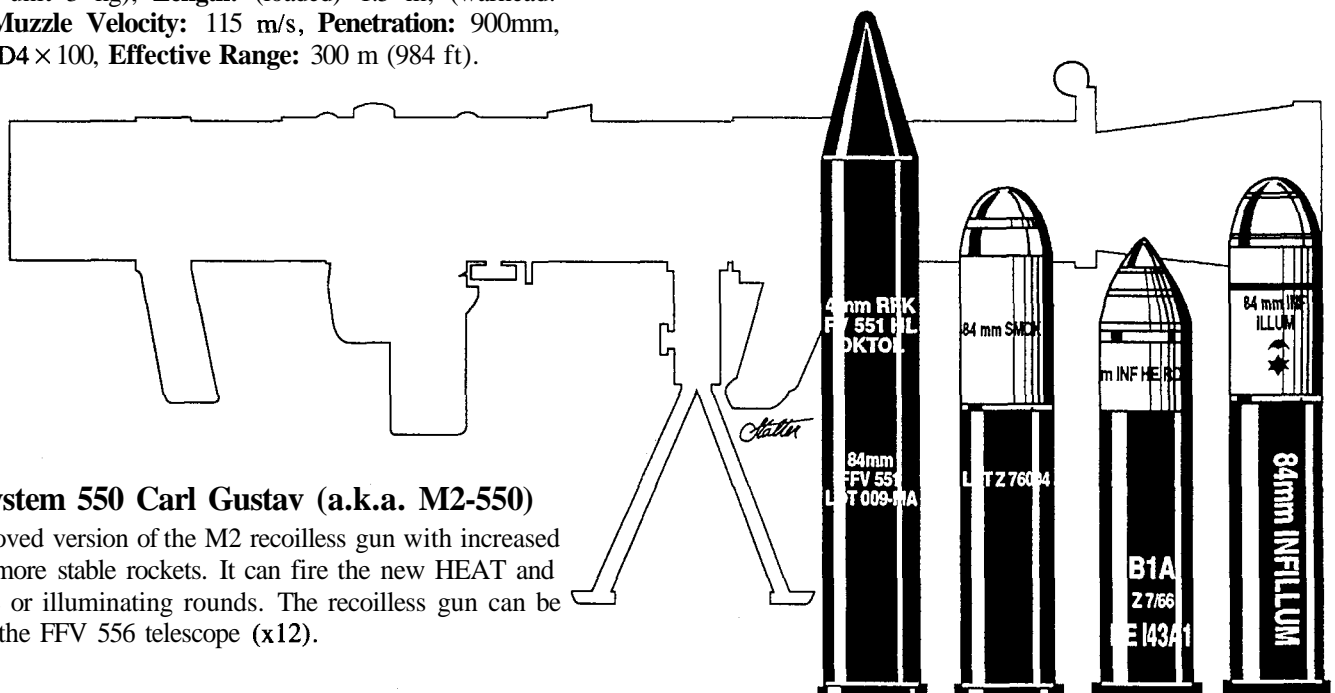

### 84mm System 550 Carl Gustav (a.k.a. M2-550)

An improved version of the M2 recoilless gun with increased range and more stable rockets. It can fire the new HEAT and HE, smoke or illuminating rounds. The recoilless gun can be fitted with the FFV 556 telescope (x12).

**Caliber:** 84mm, **Weight:** 15 kg, **Length:** 1130mm (loaded and ready to fire), **Launch Velocity:** 260 m/s, **Feed:** Single-shot, **Rate of Fire:** 4-6 rounds per minute, **Penetration:** 400 mm, **Blast Diameter:** 15 m (50 feet), **Damage:** Typical HEAT 1D6×100, FFV 502 HE/HEAT 2D4×100, or HE 1D4×100, **Approx. Effective Range:** HEAT: 450 m (1476 ft), HE or smoke: 1000 (3280 ft), illuminating: 2000 m (6562 ft).

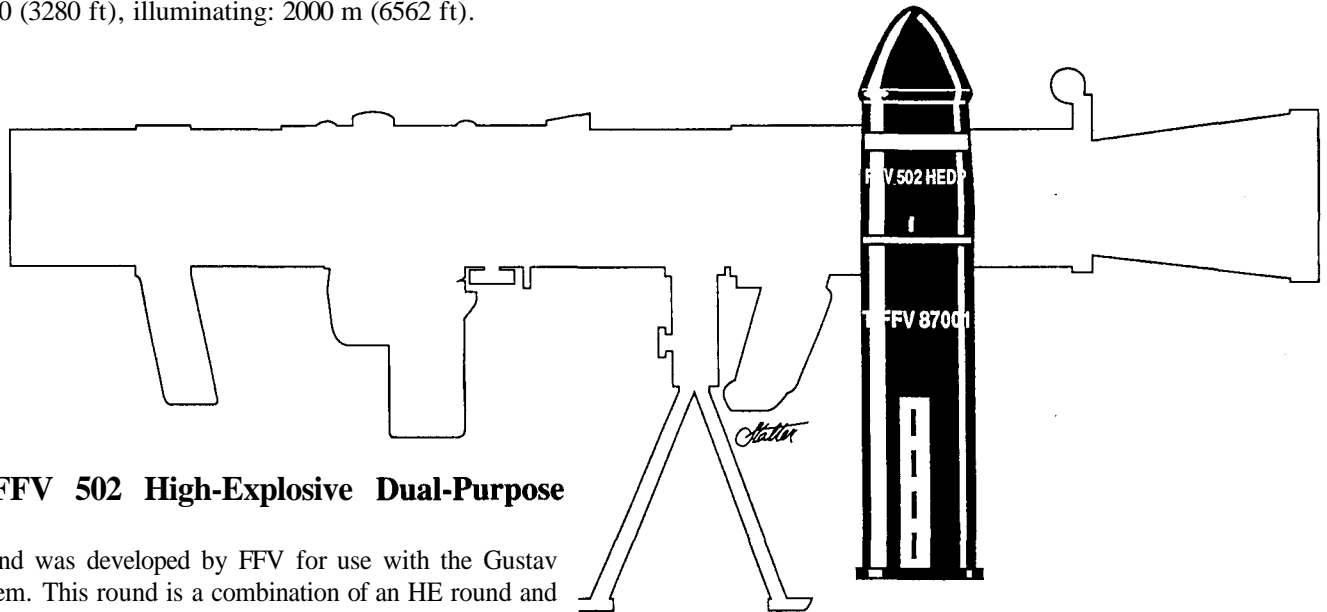

### HEDP FFV 502 High-Explosive Dual-Purpose Round

This round was developed by FFV for use with the Gustav 84mm system. This round is a combination of an HE round and a HEAT round. When used as a HEAT round it is a highly effective **behind-armor** round with a high kill ratio. When used as an HE round the fuse can be set for a time delay or contact firing. **Caliber:** 84mm, **Weight:** (complete round) 3.2 kg, **Damage:** 2D4×100, **Muzzle Velocity:** 235 m/s, **Penetration:**

greater than 150 mm of plate steel, **Effective Range:** Moving targets 300 m (984 ft), (bunkers) 500 m (1640 ft), (unprotected troops) 1000 m (3280 ft).

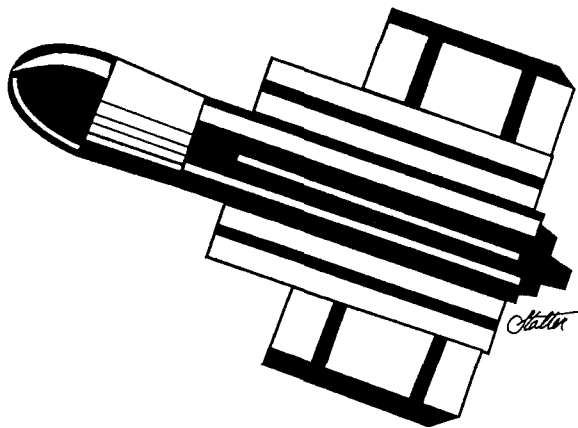

Bantam Portable Anti-Tank Missile

### Bantam Anti-Tank Missile

A disposable, one-man, wire guided, manual command to line of sight missile (MCLOS) carried in a box launcher which also holds a 21 meter (70 ft) control cable. The control unit consists of an optical sight, firing button, and joystick to control the missile. The missile container is attached to a harness for transport.

The breakdown of the system's weight is as follows: missile and container 11.5kg; with 20 meters of cable and harness + 3.5 kg; control unit 5 kg.

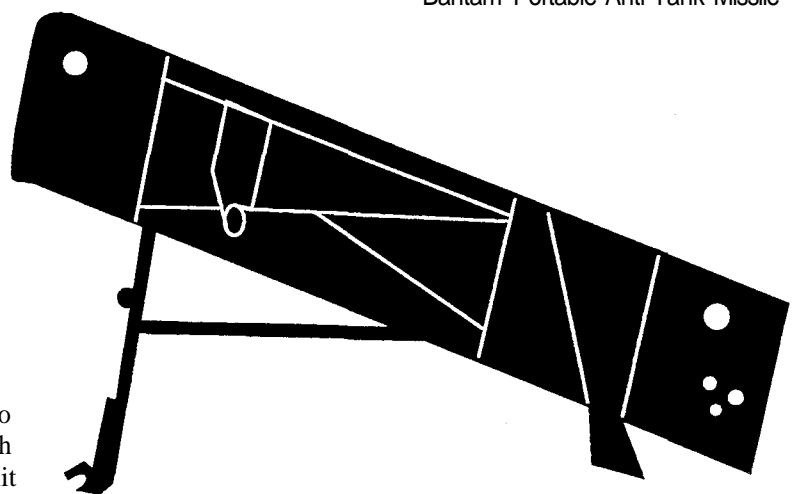

**Caliber:** 84mm, **Weight:** 20 kg (complete unit), **Length:** 1400mm (loaded and ready to fire), **Launch Velocity:** 85 m/s, **Feed:** Single-shot, disposable, **Penetration:** 500 mm, **Blast Diameter:** 21 m (70 feet), **Damage:** 1D4×100, **Minimum Range:** 300 m (984 ft), **Approx. Effective Range:** 2000 m (6562 ft).

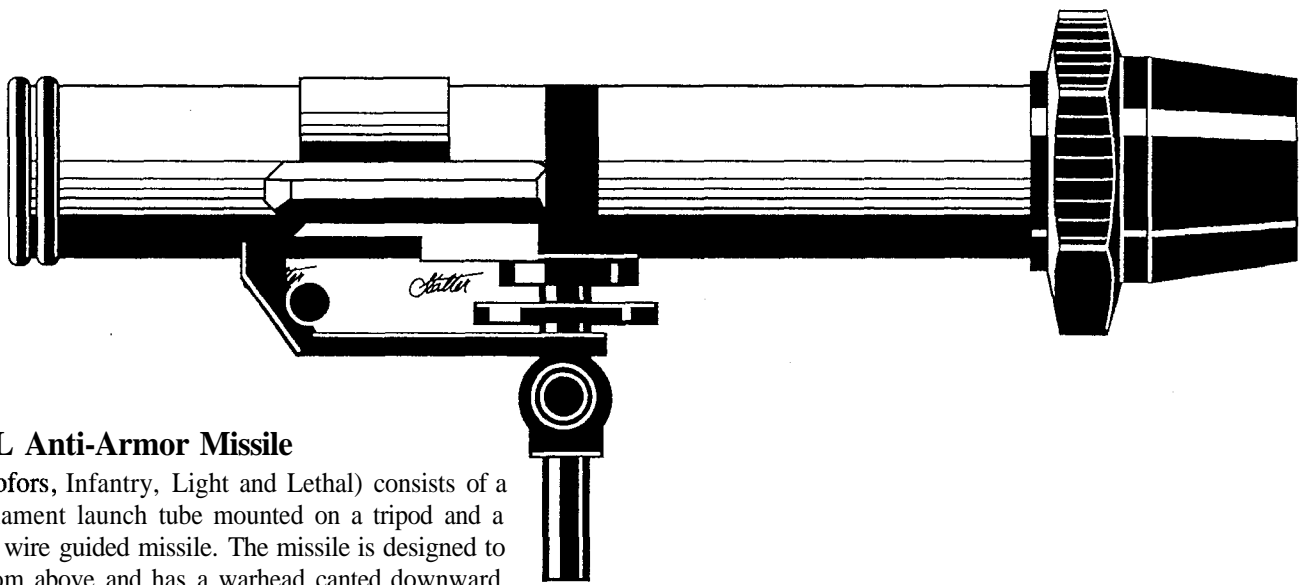

### RBS 56 BILL Anti-Armor Missile

The BILL (Bofors, Infantry, Light and Lethal) consists of a Kevlar/epoxy filament launch tube mounted on a tripod and a semi-automatic, wire guided missile. The missile is designed to attack targets from above and has a warhead canted downward 30 degrees. It is detonated by means of a proximity fuse. The missile automatically flies one meter above the line of sight so if the operator aims for the joint between the turret and hull of a tank, he will place it over the top in optimum attack position. The man portable unit is carried in two parts: the missile (weight 16 kg) and the stand with sight (weight 11 kg).

**Caliber:** 150mm, **Weight:** 11 kg (launch unit), **Length:** 1400mm (loaded and ready to fire), **Missile Weight:** 16 kg, **Launch Velocity:** 200 m/s, **Feed:** Single-shot, **Rate of Fire:** 8 rounds per minute, **Penetration:** 500 mm, **Blast Diameter:** 21 m (70 feet), **Damage:** 1D4×100, **Minimum Range:** 150 m (492 ft), **Approx. Effective Range:** 2000 m (6562 ft).

## SWITZERLAND

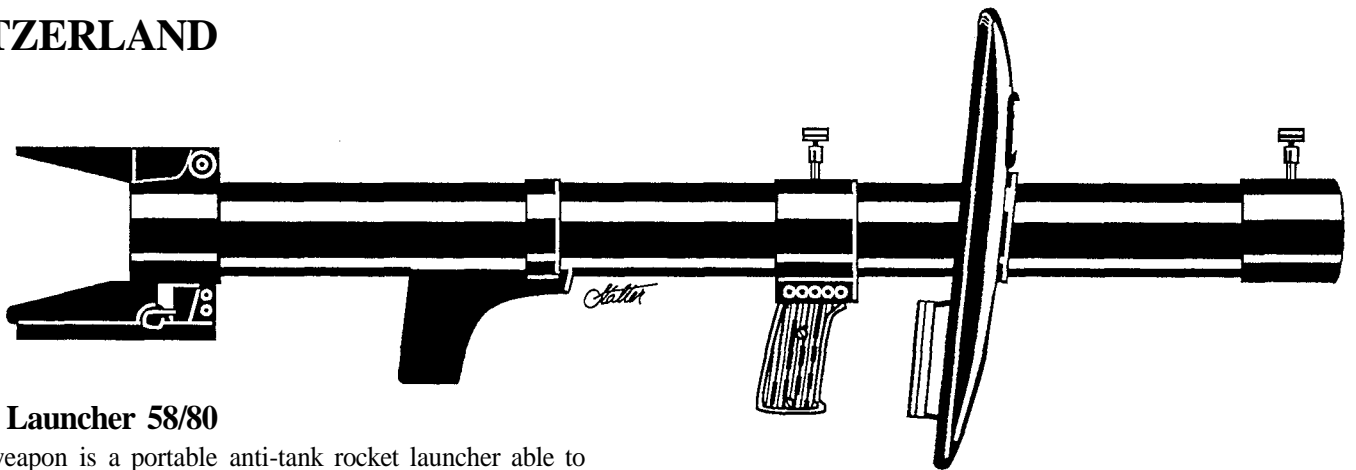

### Rocket Launcher 58/80

This weapon is a portable anti-tank rocket launcher able to fire standard 83mm projectiles. It is fitted with simple sights, a blast shield, carry strap, and trigger mechanism. Minimum safe backblast distance is 3 to 5 meters (10 to 18 ft).

**Caliber:** 83mm, **Weight:** 8.5 kg, **Length:** 1300mm (loaded and ready to fire), **Launch Velocity:** 175 m/s, **Feed:** Single-shot,

**Rate of Fire:** 6 to 8 rounds per minute, **Penetration:** 300 mm, **Blast Diameter:** 21 m (70 feet), **Damage:** 1D4 x 100, **Approx. Effective Range:** 300 m (984 ft).

## The Old U.S.S.R.

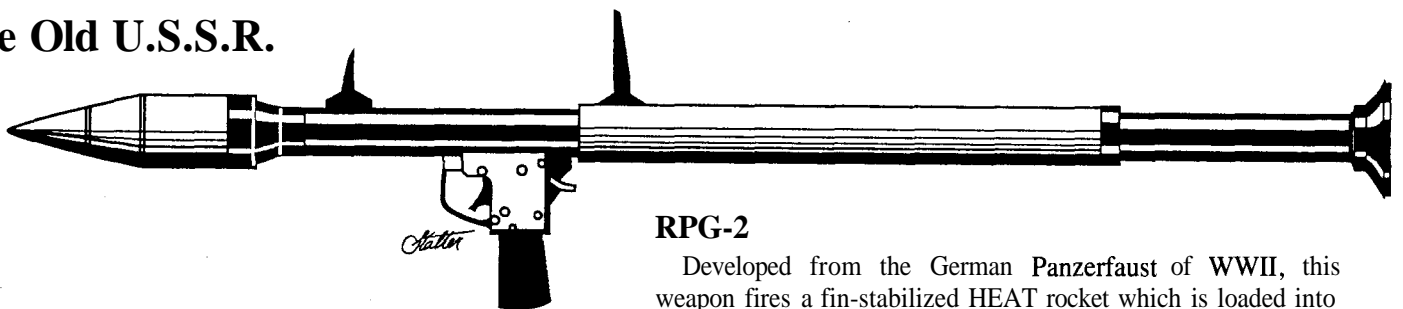

### RPG-2

Developed from the German Panzerfaust of WWII, this weapon fires a fin-stabilized HEAT rocket which is loaded into the muzzle of the launcher. The metal tube of the launcher is partially encased in wood to protect the firer from the heat of the blast. Simple sights assist in aiming the rocket. Minimum safe distance behind the weapon is 3 to 4 meters.

**Caliber:** 82mm, **Length:** 1492mm, **Launch Velocity:** 150 m/s, **Weight:** Launcher: 2.83 kg, missile: 1.84kg, **Feed:** Single-shot, **Rate of Fire:** 3-4 rounds per minute, **Penetration:** 180mm, **Blast Diameter:** 12 m (40 feet), **Damage:** 4D4×10, **Approx. Effective Range:** 200 m (656 ft). **Note:** Popular "knock-offs" include the Chinese Type 56, Czech's Type P-27 'Pancerovoka', and Yugoslav M57.

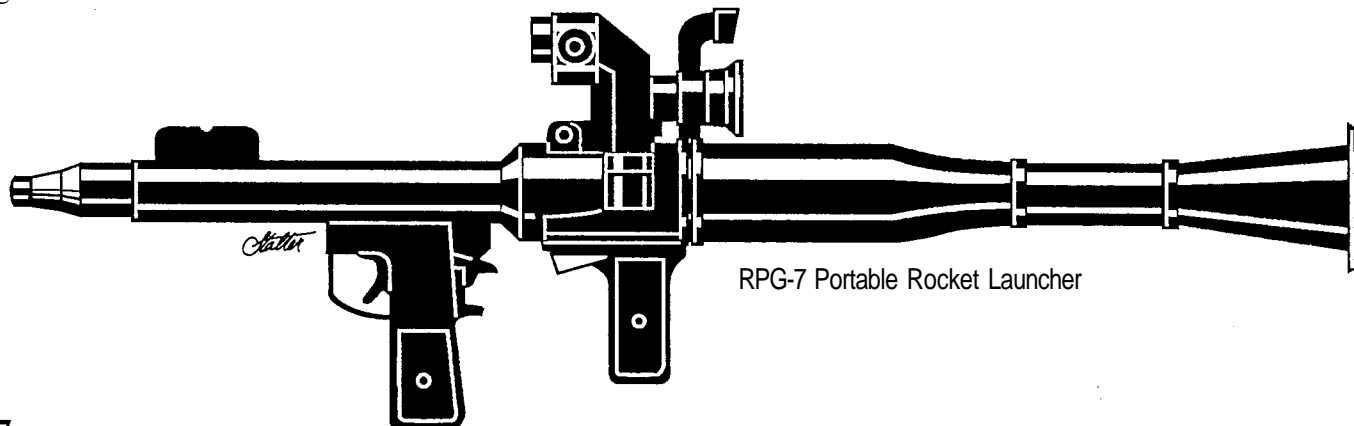

RPG-7 Portable Rocket Launcher

### RPG-7

This is an improved version of the RPG-2 fitted with a range-finding optical sight for day use and an image intensifier sight for night use. The missile has large knife-like fins which spring out after it is launched, assisting in stabilizing it in flight. Although reasonably accurate when there are no cross winds, in windy conditions it is erratic. In addition to the HEAT round, an anti-personnel rocket is available with a blast radius of 25 meters.

**Caliber:** 85mm, **Length:** 950mm, **Launch Velocity:** 300 m/s, **Weight:** Launcher: 7.9 kg, missile: 2.25 kg, **Feed:** Single-shot, **Rate of Fire:** 4-5 rounds per minute, **Penetration:** 330mm armor, **Blast Diameter:** 15 m (50 feet), **Damage:** HEAT 1D4 x 100, HE 4D6 X 10, Frag. 4D4 x 10, or smoke, **Approx. Effective Range:** 300 m (984 ft) against moving targets, **Maximum Range:** 920 m (3018 ft; self destructs at 920 m/3018 ft). **Note:** Popular "knock-offs" include the Chinese Type 69 and the Egyptian PG-7.

### RPG-18 anti-armor weapon

A Soviet copy of the US M72, this weapon is a one shot disposable rocket launcher with simple sights. The side of the launcher has a series of simple drawings depicting its use. Maximum back blast is 2 meters.

**Caliber:** 64mm, **Weight:** 10 kg (launch unit), **Length:** 705mm closed and 1100mm extended and ready to fire, **Missile Weight:** 2.7 kg, **Launch Velocity:** 115 m/s, **Feed:** Single-shot, dispos-

able, **Penetration:** 375 mm, **Blast Diameter:** 15 m (50 feet), **Damage:** Frag. 4D6×10, HE 1D4×100, HEAT 1D6×100, **Minimum Range:** 20 m (68 ft), **Approx. Effective Range:** Moving targets: 150 m (492 ft), stationary targets: 500 m (1640 ft), **Maximum range:** 1000 m (3280 ft). **Hit Probability:** 95% moving and stationary targets, 70% when fired at targets beyond 500 m (1640 ft). **Note:** It can also fire smoke and illuminating rounds.

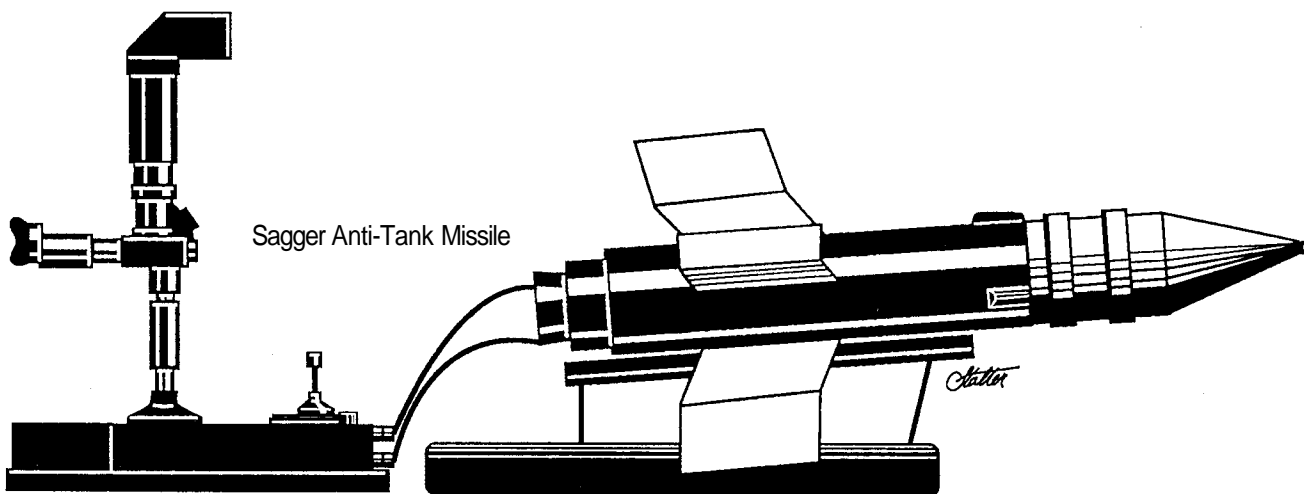

Sagger Anti-Tank Missile



## Sagger anti-tank guided missile

Sagger is the NATO code name for the Soviet wire-guided SACLOS anti-tank missile also known as the AT-3. The man portable version of the weapon is carried in a fiberglass case with the warhead separated from the motor. The front legs of the motor section are fitted to the lid of the case, elevating the missile slightly. The case lid is positioned and then strapped to stakes driven into the ground. The warhead is fitted to the motor and the leads are attached to the guidance/firing unit. A ten power periscopic sight is used to guide the missile to targets which are over 1000 meters (3280 ft) distant.

**Caliber:** 120mm, **Weight:** 11.3 kg (launch unit), **Length:** 880mm, **Missile Weight:** 5.2 kg, **Launch Velocity:** 250 m/s, **Feed:** Single-shot, **Penetration:** 400mm, **Blast Diameter:** 30 m (100 feet), **Damage:** HE 1D6×100 or HEAT 2D4×100, **Minimum Range:** 200 m (656 ft), **Approx. Effective Range:** Moving targets: 500 m (1640 ft), **Maximum range:** 3000 m

(9843 ft). **Hit Probability:** 95% moving and stationary targets, 85% when fired at targets beyond 500 m (1640 ft). Note: *The Sagger BRDM mounted system* is a vehicle launch system (often used for reconnaissance) attached to a light armored vehicle. It has a six (6 missile) rack launch rail under a steel hood or hatch. It is identical in every way to the man operated system previously described. *The United Kingdom's MCLOS, Swingfire Anti-Tank guide missile system* is similar to the Sagger BRDM in damage and range.

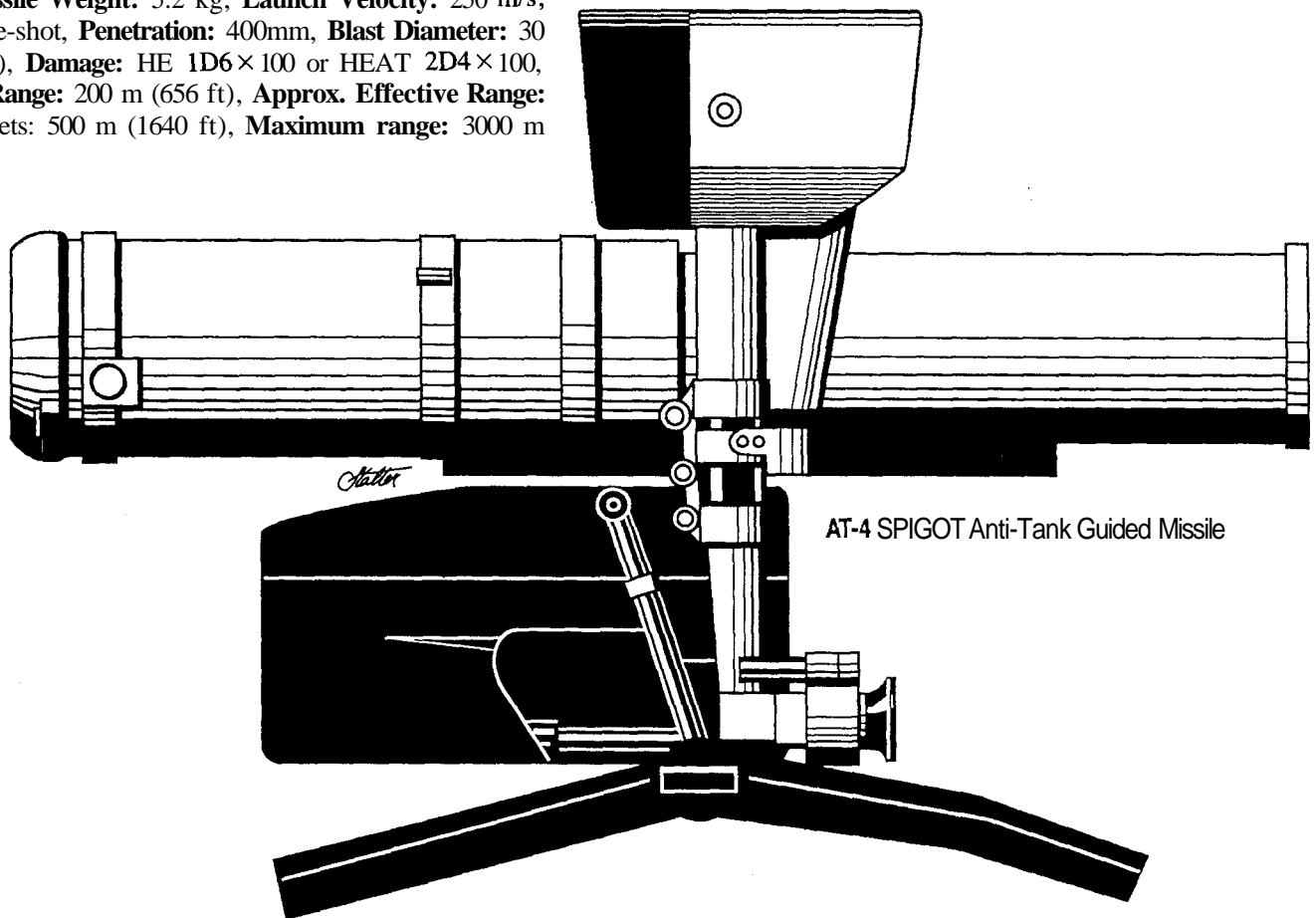

## SPIGOT Anti-Tank Guided Missile

SPIGOT is the NATO code name for the Soviet semi-automatic, wire-guided SACLOS missile also known as the AT-4. Although slightly smaller than the French MILAN, it bears a great resemblance to it and is similar in operation.

**Caliber:** 120mm, **Weight:** 40 kg (loaded/ready to fire), **Length:** 1200mm (ready to fire), **Weight of Missile:** 6.5 kg, **Launch Velocity:** 200 m/s, **Feed:** Single-shot, **Rate of Fire:** 4 rounds per minute, **Penetration:** 550mm, **Blast Diameter:** 21 m (70 feet), **Damage:** HEAT 1D6×100 or HE 1D4×100, **Approx. Effective Range:** 25 to 2000 m (85-6562 ft).

## UNITED KINGDOM

### LAW 80 Light Anti-tank Weapon system

The LAW 80 is a one-shot, low cost, disposable, short-range anti-tank recoilless weapon. The system is used as an individual weapon, issued to infantrymen in combat situations, with a carrying handle and shoulder sling. It has a proven, double failure safety system, is simple and cheap, and designed for wide scale use.

**Caliber:** 94mm, **Weight:** 9 kg (launcher ready to fire), **Length:** one meter folded or 1.5 loaded and ready to fire, **Launch Velocity:** 200 m/s, **Feed:** Single-shot, disposable, **Penetration:** 650+ mm, **Blast Diameter:** 15 m (50 feet), **Damage:** Frag. 3D4×10, HE 4D6×10, HEAT 1D6×100, **Minimum Range:** 20 m (68 ft), **Maximum Effective Range:** 500 m (1640 ft).

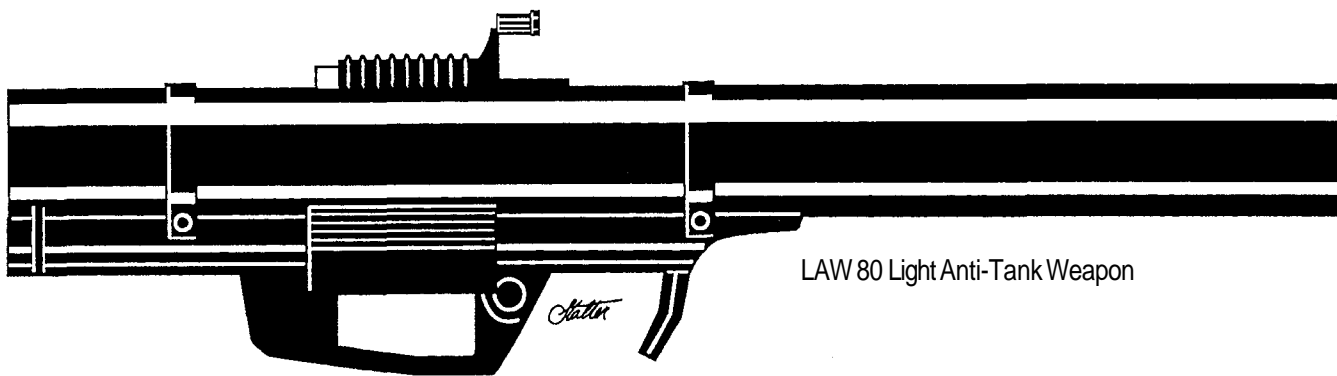

LAW 80 Light Anti-Tank Weapon

## UNITED STATES OF AMERICA

### 140mm Brunswick RAW HE Rocket

RAW is an acronym for "Rifleman's Assault Weapon." This weapon could be considered an extension of the concept of rifle launched grenades, however, it is a different concept in terms of size and effectiveness.

The RAW was developed for urban warfare. Many times infantrymen engaged in close combat in cities are faced with the problem of an enemy who is cloistered in a building and completely protected. What was needed was something to create sizeable holes in masonry and concrete, this is what the RAW does. It has a larger than normal charge of explosives and is able to be accurately placed and exploded.

**Caliber:** 85mm, **Weight:** 2.72 kg, **Length:** 305 mm, **Feed:** Single-shot, **Rate of Fire:** 4-6 per minute, **Penetration:** 100mm, **Blast Diameter:** 1.5 m (5 feet), **Damage:** Frag. 1D4×10, HE 1D6 X 10, HEAT 2D4 X 10, **Approx. Effective Range:** 300 m (984 ft). **Possible Payloads:** HE, smoke, flame, chemical, fragmentation, shape charge (HEAT), AP, smoke and stun.

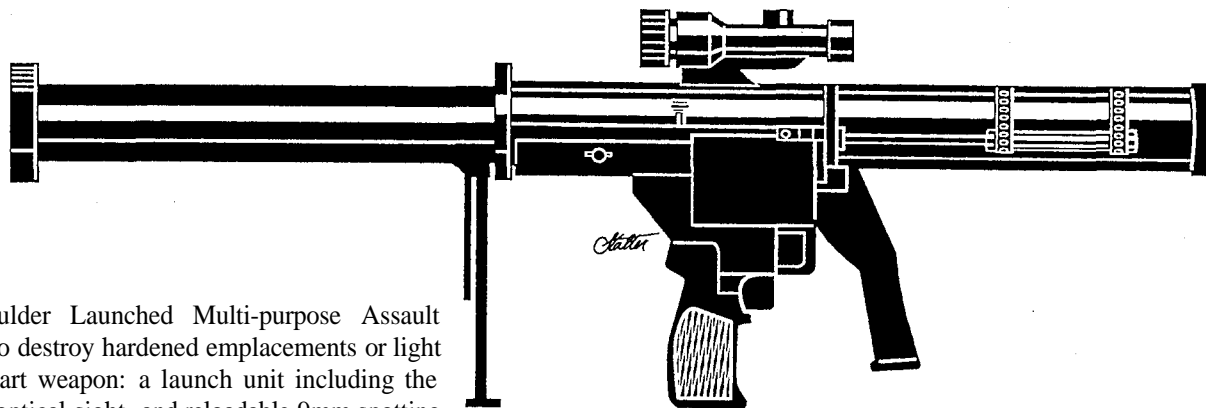

### SMAW

The SMAW (Shoulder Launched Multi-purpose Assault Weapon) is designed to destroy hardened emplacements or light vehicles. It is a two-part weapon: a launch unit including the firing mechanism and optical sight, and reloadable 9mm spotting rifle used in the British LAW 80. The rocket is supplied pre-packed in a sealed tube which is attached to the launcher and discarded after firing.

**Caliber:** 83mm, **Weight:** 13.4 kg (launcher ready to fire), **Length:** 826mm, **Launch Velocity:** 220m/s, **Feed:** Single-shot, **Rate of Fire:** 4 rounds per minute, **Penetration:** 300 mm, **Blast Diameter:** 15 m (50 feet), **Damage:** Frag. 3D4×10, HE 4D4 X 10, HEAT 1D4 x 100, **Approx. Effective Range:** 500 m (1640 ft). **Note:** It can also fire smoke and illuminating rounds.

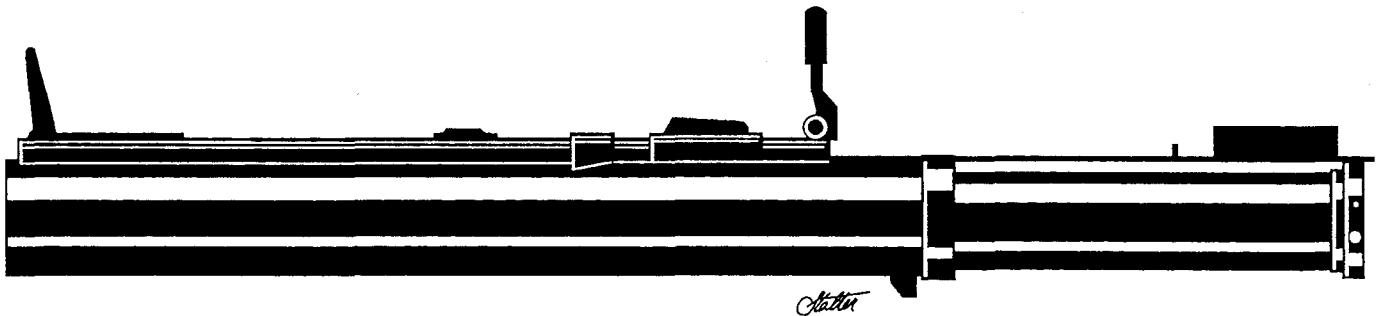

### M72A2 and M72A3 rocket launcher

The M72 series are single-shot disposable rocket launchers consisting of two concentric tubes. The outer tube carries the trigger and safety mechanisms as well as the sighting assembly. The inner aluminum tube extends telescopically rearward and cocks the weapon when fully deployed. The rocket carries a HEAT warhead which detonates on impact.

**Caliber:** 150mm, **Weight:** 11 kg (launch unit), **Length:** 655mm closed and 893mm extended and ready to fire, **Missile Weight:**

**1 kg, Launch Velocity:** 150m/s, **Feed:** Single-shot, disposable, **Penetration:** 500 mm, **Blast Diameter:** 15 m (50 feet), **Damage:** Frag. 4D6 × 10, HE 1D4 × 100, HEAT 1D6 × 100, **Minimum Range:** 20 m (68 ft), **Approx. Effective Range:** Moving targets: 150 m (492 ft), stationary targets: 500 m (1640 ft), and maximum range: 1000 m (3280). **Hit Probability:** 95% moving and stationary targets, 70% when fired at targets beyond 500 m (1640 ft). **Note:** It can also fire smoke and illuminating rounds.

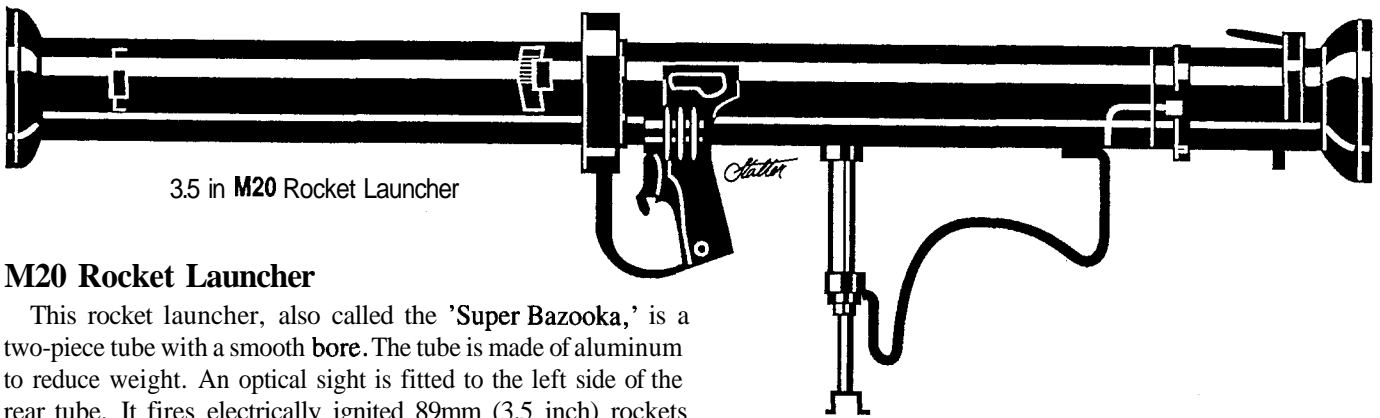

3.5 in M20 Rocket Launcher

### M20 Rocket Launcher

This rocket launcher, also called the 'Super Bazooka,' is a two-piece tube with a smooth bore. The tube is made of aluminum to reduce weight. An optical sight is fitted to the left side of the rear tube. It fires electrically ignited 89mm (3.5 inch) rockets which are currently made in various countries, most notably Spain and China.

**Caliber:** 89mm, **Weight:** 5.5 kg (launcher), **Length:** one meter folded or 1.5 loaded and ready to fire, **Weight of Rocket:** 4.04 kg, **Launch Velocity:** 250 m/s, **Feed:** Single-shot, **Rate of Fire:** 4-6 rounds per minute, **Penetration:** 200+ mm, **Blast Diameter:** 15 m (50 feet), **Damage:** Frag. 3D4 × 10, HE 4D4 × 10,

HEAT 1D4 × 100, **Approx. Effective Range:** Moving targets: 150 m (492 ft), stationary targets: 500 m (1640 ft), and maximum range: 1200 m (3937 ft). **Hit Probability:** 90% moving and stationary targets, 60% when fired at targets beyond 500 m (1640 ft). **Note:** It can also fire smoke and illuminating rounds. The Brazilian M20-A1B1 is another version of the M20.

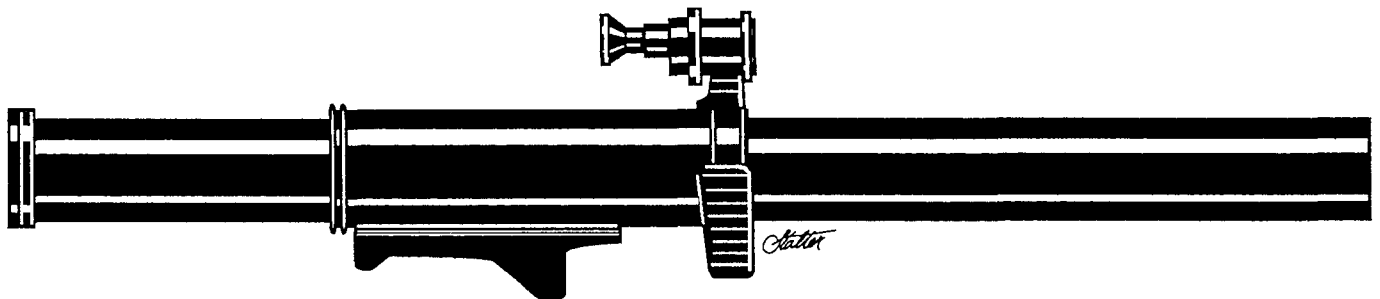

### M67 Recoilless Rifle

This is a large, two-man weapon used against tanks and fixed emplacements. It is designed to be fired from the ground on a monopod or bipod, but it can also be fired from the shoulder. The M67 is a breech-loading, air-cooled weapon fitted with an optical sight and percussion firing mechanism. Sustained fire is one round per minute to allow for cooling. A rapid rate of 5 rounds in 30 seconds can be achieved but this must be followed by a 15 minute cooling period. Overheating will make the recoilless rifle too hot to touch/load and may warp/damage the weapon

(will not shoot accurately; -30%). There is also a possibility that the round placed inside the unit will explode before it is fired (50% chance).

**Caliber:** 90mm, **Weight:** 16 kg (launcher), **Length:** 1346 mm, **Weight of Rocket:** 4.2 kg, **Launch Velocity:** 213 m/s, **Feed:** Single-shot, **Rate of Fire:** One per minute is recommended but as many as 4-6 rounds per minute, **Penetration:** 250+ mm, **Blast Diameter:** 21 m (70 feet), **Damage:** Frag. 1D4 × 100, HE 1D6 × 100, HEAT 2D4 × 100, **Approx. Effective Range:**

Moving targets: 400 m (1312 ft), stationary targets: 800 m (2625 ft), and maximum range: 2000 m (6562 ft). **Hit Probability:** 90% moving and stationary targets, 70% when fired at targets beyond 500 m (1640 ft). **Note:** It can also fire smoke and illuminating rounds.

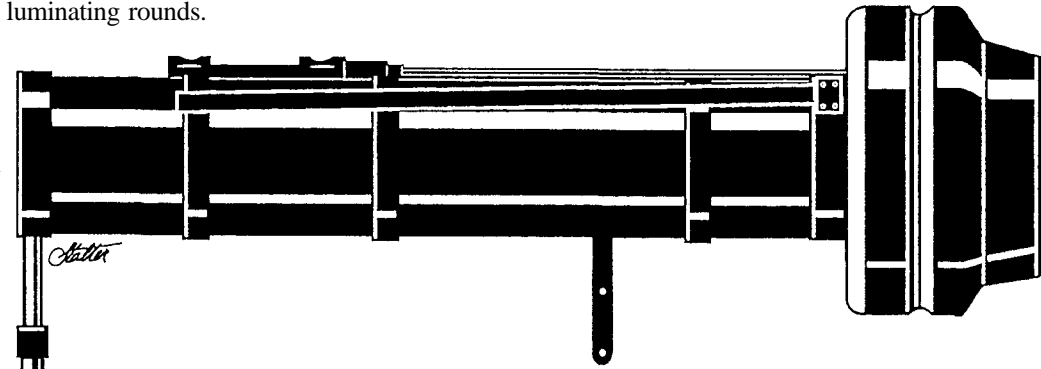

### M47 Dragon Medium Anti-Tank/Assault Weapon

This weapon consists of two parts, the launcher and the missile (which is stored inside the launch tube). The launcher is made of fiberglass and is fitted with a bipod, launcher/tracker connector, and carry strap. Once the missile is fired the tracking mechanism is removed and the tube discarded. The missile is on a wire guided SACLOS system and semi-automatic in operation. The sighting device can include nightvision capabilities. Current generation systems are fitted with vision systems capable of seeing through smoke, haze, or fog.

The first, Generation 2 Dragon missile weighs 6.2 kg and has a range of 1000 meters (many are still in use). The current, Generation 3 Dragon, missile weighs 10 kg and has a range of 1500 meters (4921 ft).

**Caliber:** 85mm, **Weight:** 13.8 kg Generation 2 Dragon, 21.5 kg Generation 3 Dragon launcher, **Length:** 1154 mm, **Weight of Rocket:** 10 kg, **Launch Velocity:** 213 m/s, **Feed:** Single-shot, **Rate of Fire:** 4-6 per minute, **Penetration:** 500mm, **Blast Diameter:** 21 m (70 feet), **Damage:** Frag. 1D4 x 100, HE 1D6 x 100, HEAT 2D4 x 100, **Approx. Effective Range (Generation 3 Dragon):** 1500m (4921 ft). **Hit Probability:** 90%.

### TOW Heavy Anti-Tank Weapon System

This weapon is a man portable or vehicle mounted heavy anti-tank system. The entire weapon consists, basically, of a fiberglass launch tube, tripod, traversing unit, optical sight, missile guidance unit, and battery. The missile is on a wire guided SACLOS system and tracks its target by flares/heat emission which serve as an infrared source. These infrared emissions are detected by the guidance unit and are used to calculate flight corrections which are signalled back to the missile. The firer needs only to keep the cross-hairs on the target to have a high probability of a hit.

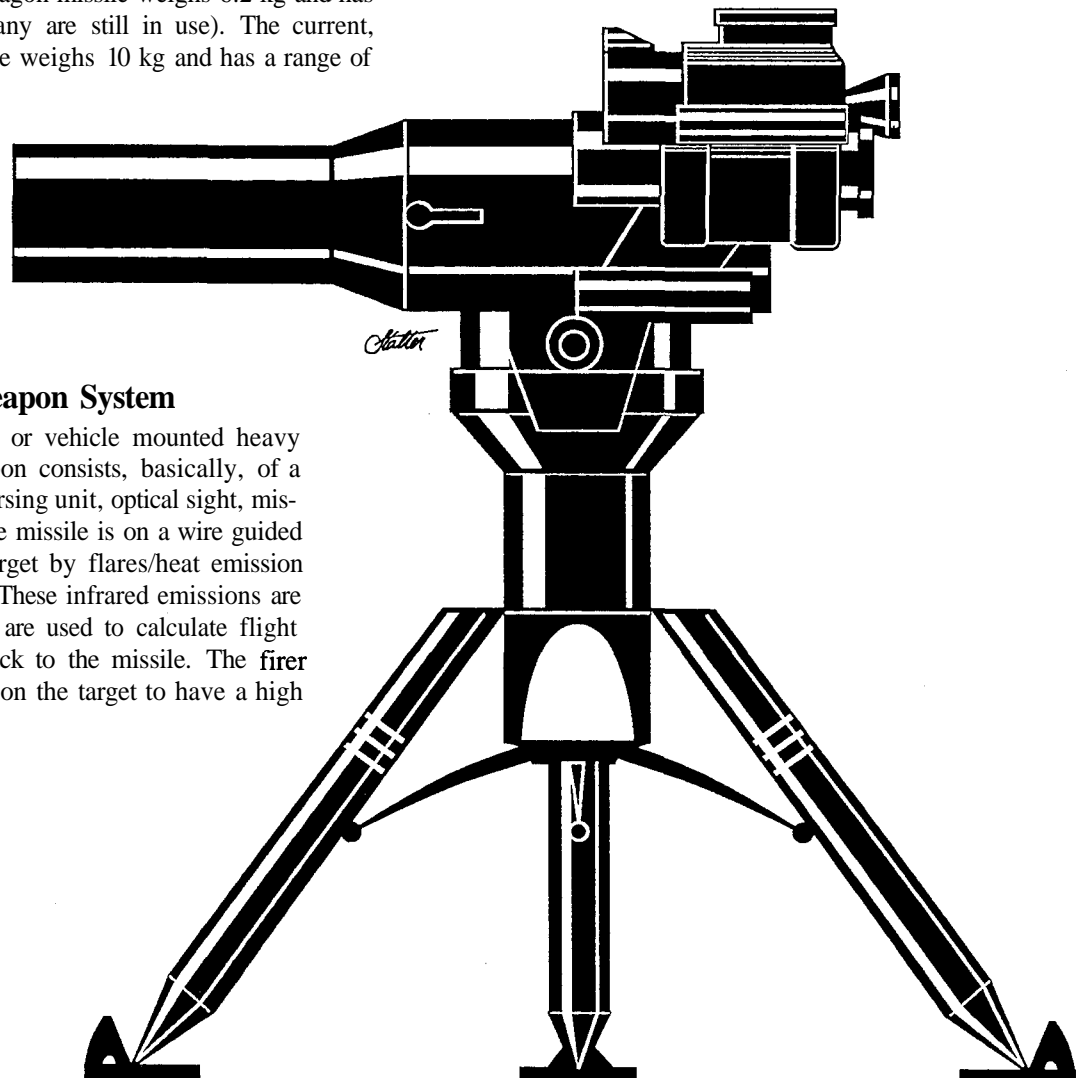

The missile flight motor ignites about 12 meters (40 ft) from the launcher, thus protecting the crew. The three main missiles developed for this system are the basic TOW (22.5 kg), the ITOW (25.7 kg), and the TOW 2 (28.1 kg). The TOW system can be used on heavy ground vehicles and helicopters — it is the M65 on the AH-1 Cobra series of combat helicopters, as well as on Huey's, Sikorsky S-76 and others.  
**Caliber:** 127mm/152mm, **Weight:** Launcher: 93 kg, missile:

22.5 to 28.1 kg, **Length:** 2210mm, **Launch Velocity:** 200 m/s, **Feed:** Single-shot, **Rate of Fire:** 2-4 per minute, **Penetration:** 600 to 900mm, **Blast Diameter:** 30 m (100 feet), **Damage:** TOW: 1D6 x 100, ITOW (HEAT): 2D4 X 100, TOW 2 (HEAT): 3D4 x 100, **Minimum Range:** 65 m (213 ft), **Approx. Effective Range:** 2000 m (6562 ft), **Maximum Range:** 3750 m (12,303 ft), **Hit Probability:** 96%, reduced to 85% for targets beyond 2000 meters.

## YUGOSLAVIA

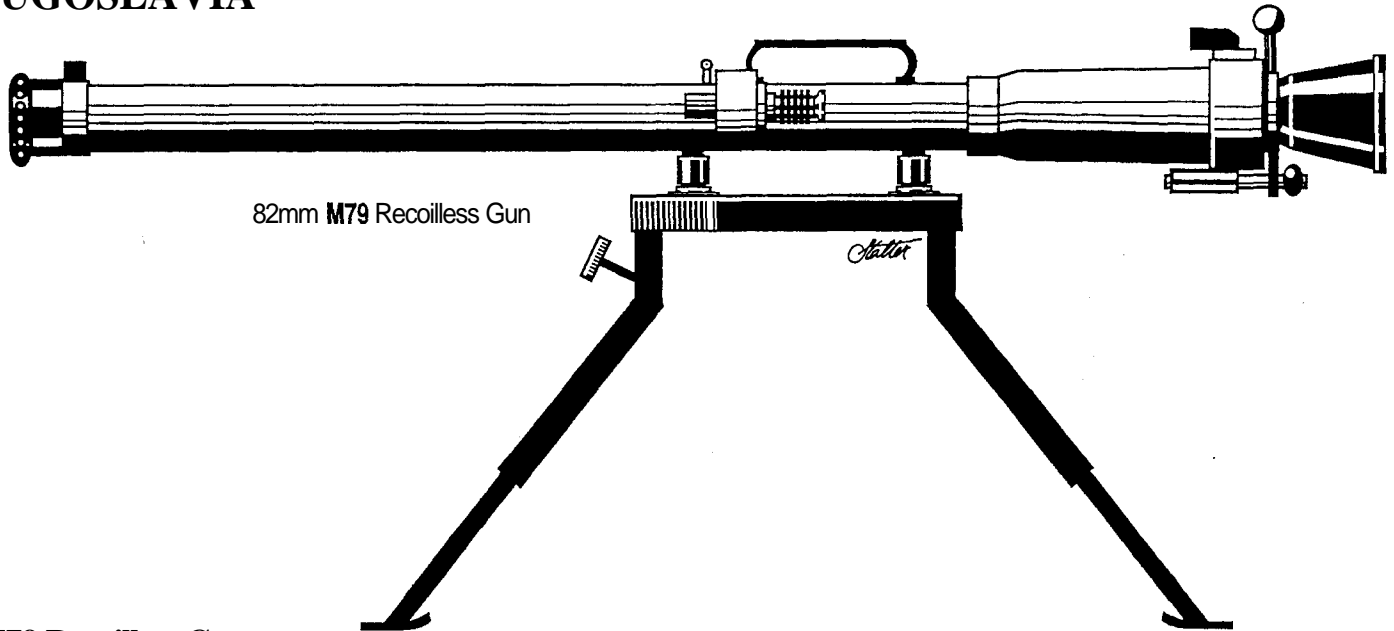

### M79 Recoilless Gun

This relatively lightweight weapon has a launch tube made of high-tensile steel which is fitted with an optical sight. The HEAT warhead has an operational range of 670 meters while the HE round can reach up to 2000 meters.

**Caliber:** 82mm, **Weight:** 27.5 kg (loaded/ready to fire), **Length:** 1.78 m (ready to fire), **Weight of Missile:** 6.5 kg, **Launch Velocity:** 330 m/s, **Feed:** Single-shot, **Rate of Fire:** 4 rounds per minute, **Penetration:** 350mm, **Blast Diameter:** 21 m (70 feet), **Damage:** HEAT 1D6 x 100 or HE 4D6 x 10, **Approx. Effective Range:** 450 m (1476 ft), **Maximum Range:** 2000 m (6562 ft, but reduce accuracy by 30%).

90mm M79 Rocket Launcher

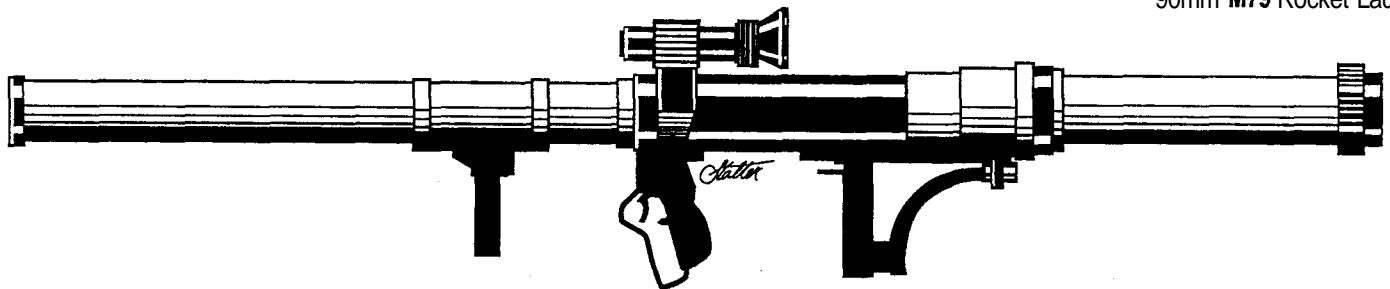

### M79 Rocket Launcher

This design is similar to the French LRAC-89, i.e., a pre-packaged rocket is fitted to the rear of the launch tube and the empty combustion chamber is discarded after firing.

**Caliber:** 90mm, **Weight:** 24.5 kg (loaded/ready to fire), **Length:** 1432mm (ready to fire), **Weight of Missile:** 3.5 kg, **Launch**

**Velocity:** 250 m/s, **Feed:** Single-shot, **Rate of Fire:** 4-6 rounds per minute, **Penetration:** 400mm, **Blast Diameter:** 25 m (82 feet), **Damage:** HEAT 1D6 x 100 or HE 1D4 x 100, **Approx. Effective Range:** 600 m (1969 ft), **Maximum Range:** 2000 m (6562 ft, but reduce accuracy by 20%).

---

# Anti-Aircraft Weapons

---

## Surface to Air Missiles (SAM)

Man portable air defence missile systems were first developed in the 1960's. One of these weapons, the SA-7, was used extensively by Arab forces in the 1973 Arab-Israeli War and played a major role in the conflict. Similar in many respects to anti-tank missiles, these weapons normally consist of a missile, launch tube, and firing/guidance unit.

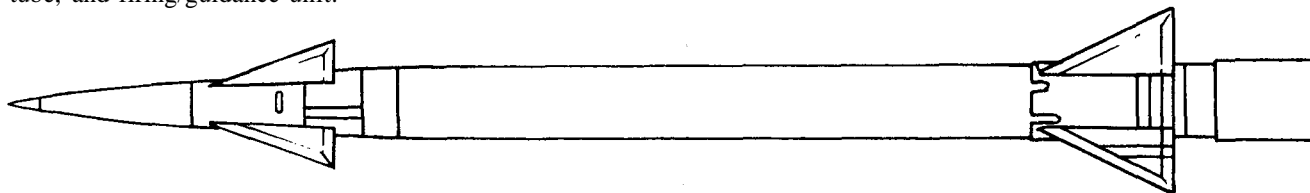

### Blowpipe & Javelin SAM

The **Blowpipe** is a self-contained SAM system that has seen service in both the Falklands War and in Afghanistan. It consists of two units: the missile sealed in a launch canister and the launch/guidance unit which is clipped to the missile tube prior to firing. When the firer has acquired a target, he launches the missile and guides it to the target by means of a thumb stick/thumb joystick; flight corrections are sent to the missile by radio.

**Blowpipe: Country:** UK, **Weight:** 21.9 kg (complete system), **Length of Missile:** 1.4 m, **Missile Weight:** 11 kg, **Penetration:** 400 + mm, **Feed:** single-shot, **Blast Diameter:** 30 m (100 feet), **Damage:** 1D6 × 100, **Range:** 4 km (2.5 miles), **Flight Speed:** 2000 km/h (Mach 1.5), **Altitude Ceiling:** 2000 m (6562 ft), **Hit Probability:** 94%. **Note:** Many countries use this weapon, including Argentina, Ecuador, Chile, Canada, UK, Nigeria, and Thailand.

The **Javelin** utilizes the same missile as the Blowpipe but with an improved guidance system and better rocket motor. This missile uses a SACLOS guidance system which allows the operator to only keep the target in the cross-hairs while guidance corrections are automatically determined and sent to the missile.

**Javelin: Country:** UK, **Weight:** 21.9 kg (complete system), **Length of Missile:** 1.4 m, **Missile Weight:** 11 kg, **Penetration:** 500 + mm, **Feed:** single-shot, **Blast Diameter:** 30 m (100 feet), **Damage:** 2D4 × 100, **Range:** 6 km (3.8 miles), **Flight Speed:** 2000 km/h (Mach 1.5), **Altitude Ceiling:** 4500 m (14,765 ft), **Hit Probability:** 95%.

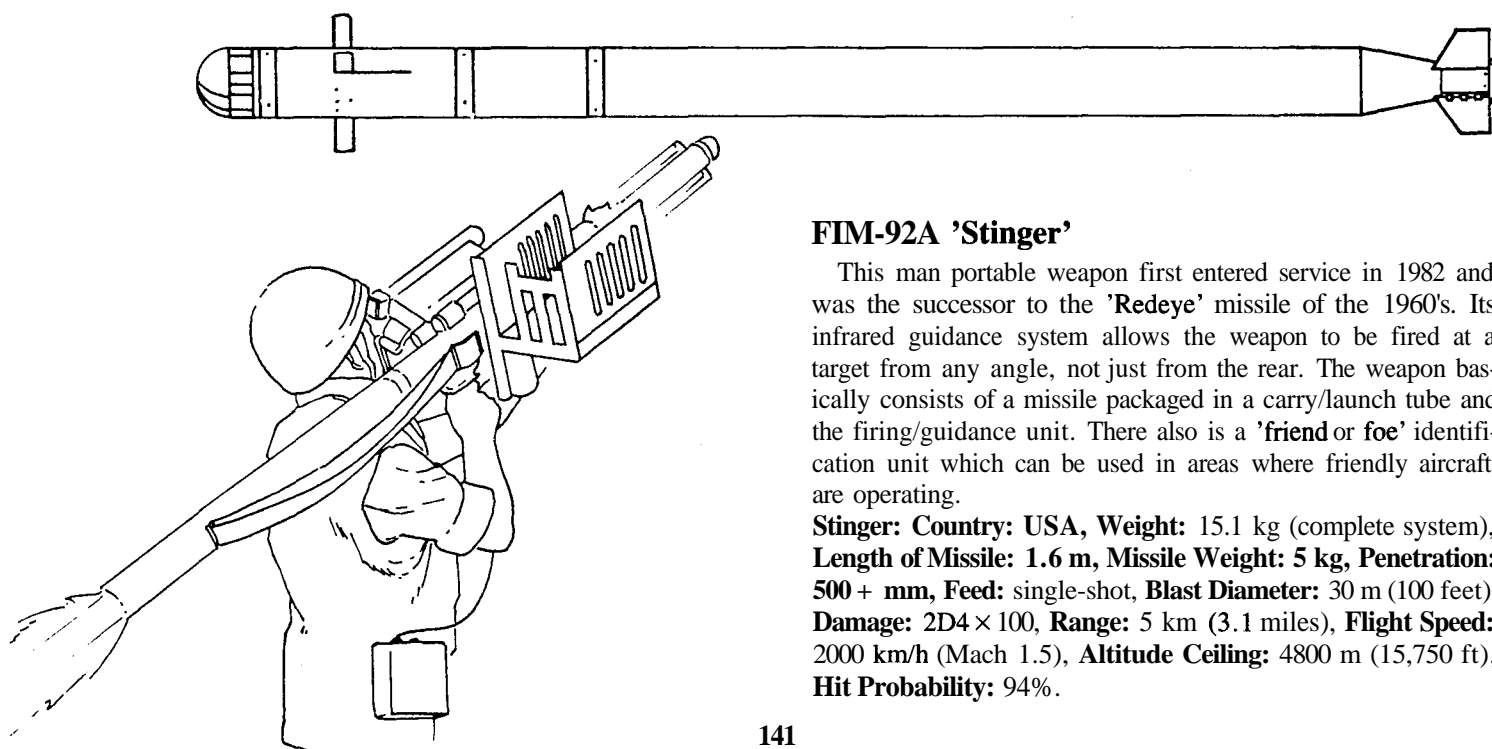

### FIM-92A 'Stinger'

This man portable weapon first entered service in 1982 and was the successor to the 'Redeye' missile of the 1960's. Its infrared guidance system allows the weapon to be fired at a target from any angle, not just from the rear. The weapon basically consists of a missile packaged in a carry/launch tube and the firing/guidance unit. There also is a 'friend or foe' identification unit which can be used in areas where friendly aircraft are operating.

**Stinger: Country:** USA, **Weight:** 15.1 kg (complete system), **Length of Missile:** 1.6 m, **Missile Weight:** 5 kg, **Penetration:** 500 + mm, **Feed:** single-shot, **Blast Diameter:** 30 m (100 feet), **Damage:** 2D4 × 100, **Range:** 5 km (3.1 miles), **Flight Speed:** 2000 km/h (Mach 1.5), **Altitude Ceiling:** 4800 m (15,750 ft), **Hit Probability:** 94%.

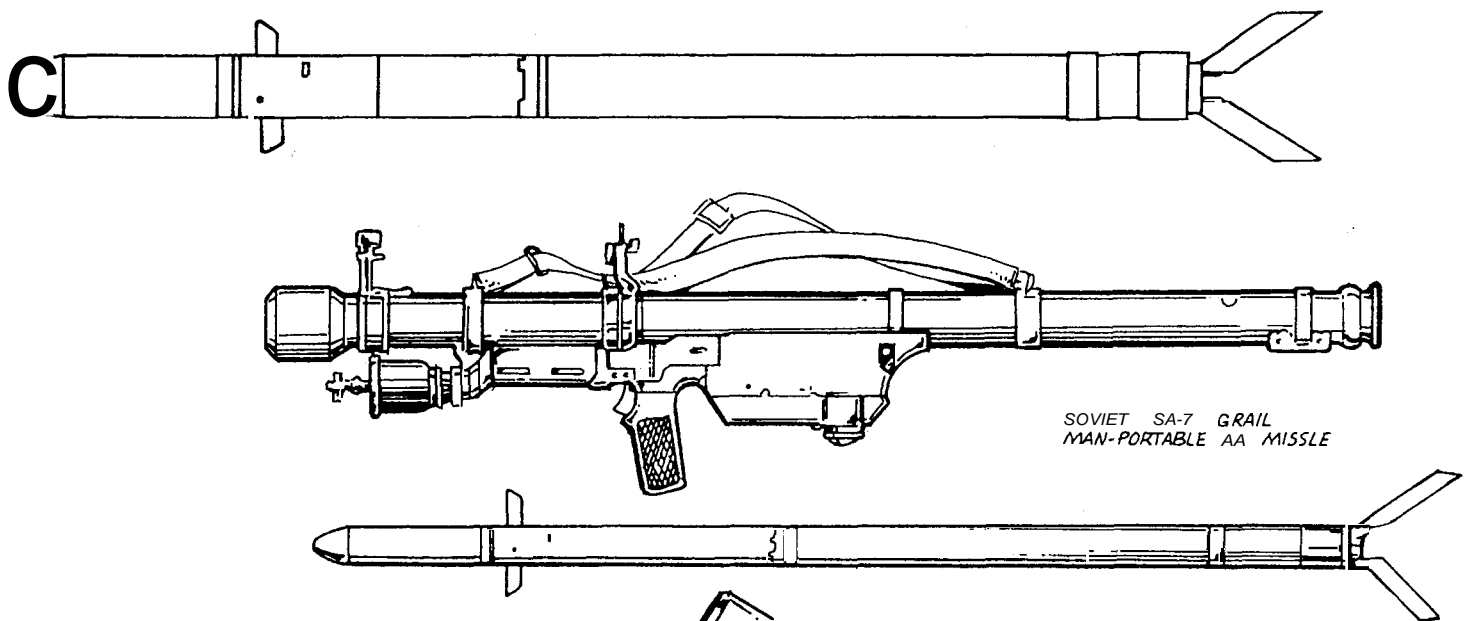

## SA-7B 'Grail'

This simple infantry weapon was originally called "Strela" (Arrow) by the west. Early versions resembled the US Redeye and shared its shortcomings. Although the SA-7B has improved guidance, it still is most effective against aircraft when fired from behind the craft, but it is effective against helicopters from any angle.

The firer uses the weapon by first aiming it at the target and partially depressing the trigger. This activates a battery and the firer then waits for an audible warning and the red light to turn green, indicating the missile seeker has locked on. The firer then fully depresses the trigger to launch the missile. The missile warhead is fitted with an impact fuse and is really effective only against small aircraft. In the 1973 Arab/Israeli War, many Israeli planes were hit by these missiles and were still able to return to base.

**SA-7 Grail: Country:** USSR, **Weight:** 19.3 kg (complete system), **Length of Missile:** 1.35 m, **Missile Weight:** 9.2 kg, **Penetration:** 400+ mm, **Feed:** single-shot, **Blast Diameter:** 30 m (100 feet), **Damage:** 1D6 × 100, **Range:** SA-7A: 3 km (2 miles), SA-7B: 5 km (3.1 miles), **Flight Speed:** SA-7A: 1600 km/h (Mach 1), SA-7B 2000 km/h (Mach 1.5), **Altitude Ceiling:** 1500 m (4921 ft), **Hit Probability:** 90%.



# Mortars

The following are just a few samples of mortars. There are also a handful of light, mortar-like grenade/rocket launchers found under the sections on grenade and rocket launchers. The main difference between a "true" mortar and a grenade launcher is that a mortar fires a larger shell and has far greater range.

## 81mm SMI Mortar

**Country:** Austria, **Caliber:** 81mm, **Weight:** 12.25 kg (launcher), **Length:** 1330mm (folded), **Weight of Projectile:** 4.15 kg, **Launch Velocity:** 300 m/s, **Feed:** Single-shot, **Rate of Fire:** 4-6 rounds per minute, **Penetration:** 250+ mm, **Blast Diameter:** 21 m (70 feet), **Damage:** Frag. 1D4 × 100, HE 1D6 × 100, **Range:** 5800 m (19,000 ft, over 3½ miles), **Accuracy/Hit Probability:** Moving targets: 40%, stationary targets: 60% (50% when fired at targets beyond 2000 m/6562 ft); 50% of all the bombs fall within a zone 40 m (131 ft) long and 21 m (70 ft) wide. Note: It can also fire smoke, CS, and illuminating rounds.

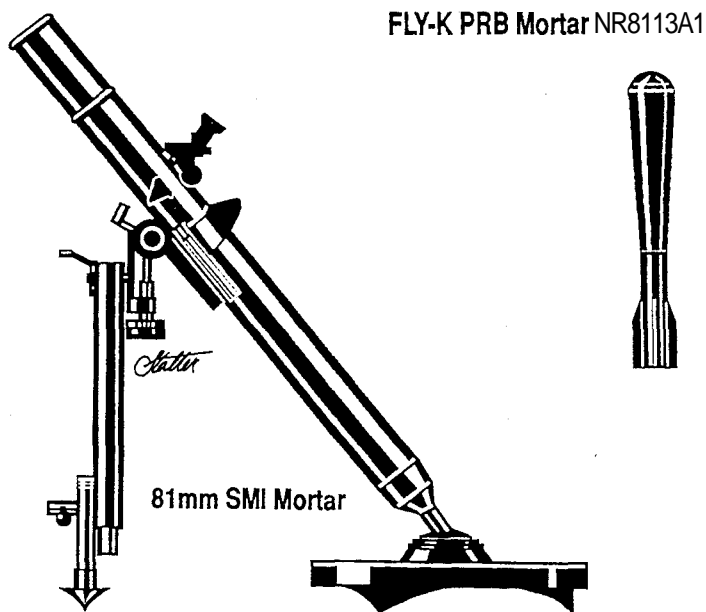

FLY-K PRB Mortar NR8113A1

81mm SMI Mortar

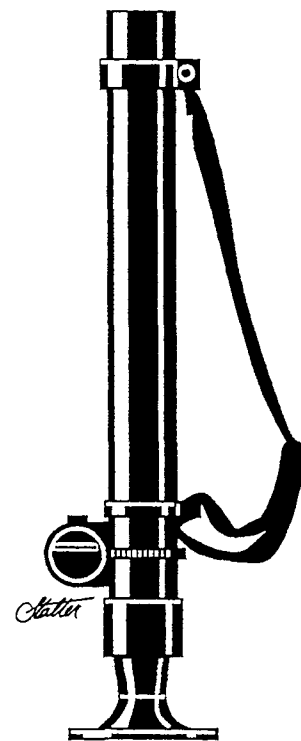
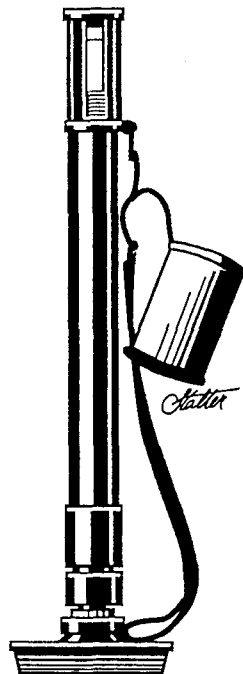

60mm Commando Mortar

### FLY-K PRB Mortar

This mortar uses a propulsion system previously known as a "Jet Shot." With this unit there is very little noise, no emission of explosive gases and no flash emitted which makes detection of the firing location very difficult. Also with this system, the barrel of the mortar does not get hot so that the chance of infrared detection is dramatically reduced (25%).

**Country:** Belgium, **Caliber:** 52mm, **Overall Weight:** 4.5 kg (Barrel: 2.15 kg, base-plate: 2.07 kg, sight: 120 grams), **Overall Length:** 710mm, **Diameter:** 60mm, **Weight of Projectile:** 4.15 kg, **Launch Velocity:** 300 m/s, **Feed:** Single-shot, **Rate of Fire:** 4-6 rounds per minute, **Penetration:** 250+ mm, **Blast Diameter:** 21 m (70 feet), **Damage:** Frag. 6D6×10, HE 1D6×100, **Approx. Effective Range:** 700 m (2297 ft) **Maximum Range:** 2000 m (6562 ft, over one mile), **Accuracy/Hit Probability:** Moving targets: 50%, stationary targets: 75% when within 700 m, (50% when fired at targets beyond 700 m/2297 ft); 50% of all the bombs fall within a zone 40 m (131 ft) long and 21 m (70 ft) wide. **Note:** It can also fire practice, smoke, CS, and illuminating rounds.

FAMAE 81mm Mortar

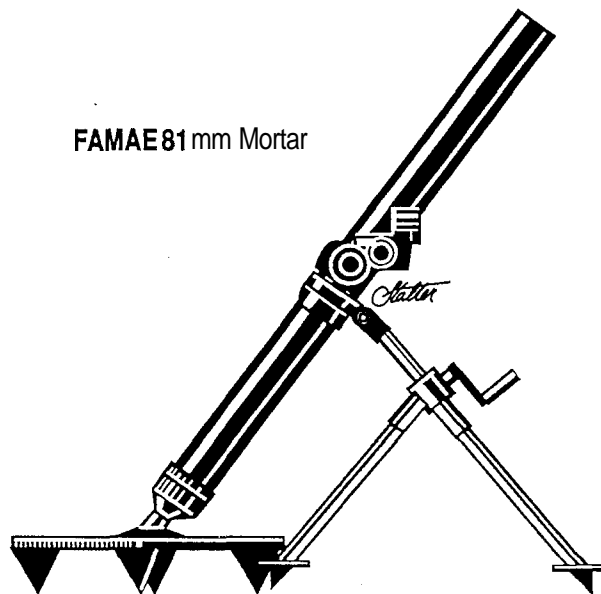

### 81mm FAMAE Mortar

This is a heavy, two man weapon.

**Country:** Chile, **Caliber:** 81mm, **Weight:** Barrel: 20.6 kg, base-plate: 28 kg, tripod: 17.2 kg, **Overall Length:** 680mm (barrel length is 650mm), **Weight of Projectile:** 4.4 kg, **Launch Velocity:** 200 m/s, **Feed:** Single-shot, **Rate of Fire:** 4-6 rounds per minute, **Penetration:** 250+ mm, **Blast Diameter:** 21 m (70 feet), **Damage:** typically HE 1D6 X 100, **Minimum Range:** 200 m (656 ft), **Approx. Effective Range:** 200 to 2000 m (656 to 6562 ft), **Maximum Range:** 4200 m (13,780 ft), **Accuracy/Hit Probability:** Moving targets: 40%, stationary targets: 75% when within 1000, (50% when fired at targets beyond 2000 m); 50% of all the bombs fall within a zone of 40 m (131 ft) long and 21 m (70 ft) wide. **Note:** It can also fire frag, smoke, CS, and illuminating rounds.

### 60mm Commando Mortar

**Country:** Chile, **Caliber:** 60mm, **Overall Weight:** 7.7 kg, **Overall Length:** 680mm (barrel length is 650mm), **Weight of Projectile:** 4 kg, **Launch Velocity:** 300 m/s, **Feed:** Single-shot, **Rate of Fire:** 4-6 rounds per minute, **Penetration:** 250mm, **Blast Diameter:** 21 m (70 feet), **Damage:** Frag. 6D6 x 10, HE 1D4×100, **Approx. Effective Range:** 700 m (2297 ft), **Maximum Range:** 1050 m (3,445 ft), **Accuracy/Hit Probability:** Moving targets: 40%, stationary targets: 70% when within 700m, (45% when fired at targets beyond 700 m/2297 ft); 50% of all the bombs fall within a zone 40 m (131 ft) long and 21 m (70 ft) wide. **Note:** It can also fire practice, smoke, CS, and illuminating rounds.



## NR 8120 PRB Grapnel Launcher

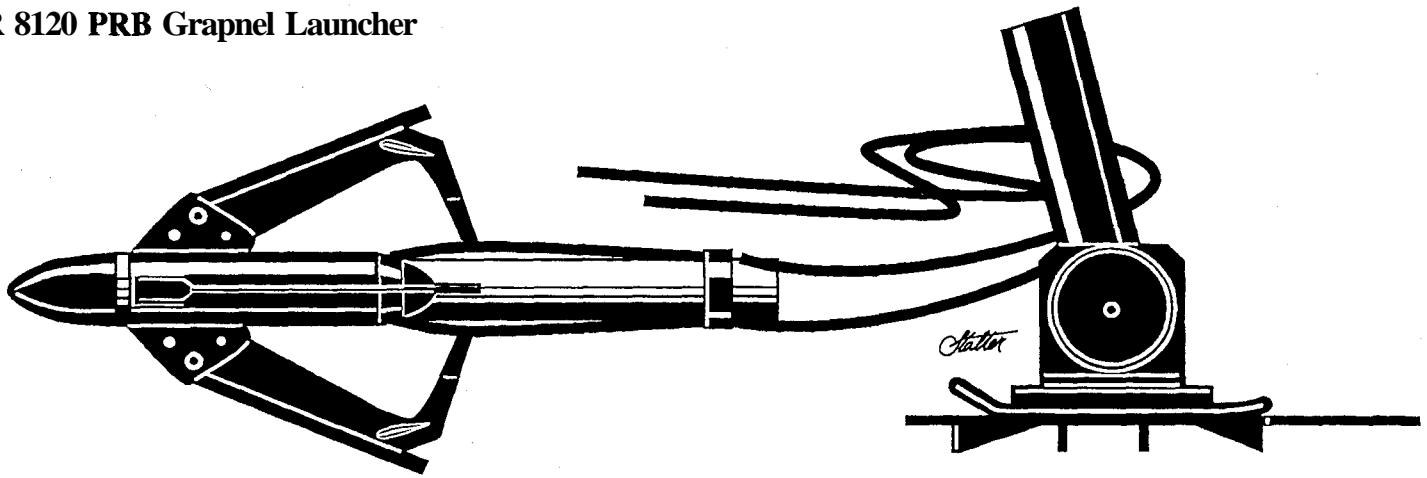

This is a short mortar that uses the same principle as the FLY-K mortar. This weapon can be trigger fired or remote cord fired. The normal firing crew is two men. It is specifically designed to fire a grapnel from boats or other vehicles, but can also fire live ammunition.

**Country:** Belgium, **Caliber:** 52mm, **Overall Weight:** 9.3 kg, **Overall Length:** 710mm, **Diameter:** 60mm, **Weight of Projectile:** 4.15 kg, **Launch Velocity:** 150 m/s, **Feed:** Single-shot, **Rate of Fire:** 4-6 rounds per minute, **Penetration:** 250 + mm, **Blast Diameter:** N/A with grapnel, **Damage:** None from grapnel (hooks onto other vessels), or Frag. 1D4 × 100 or HE 1D6 × 100, **Approx. Effective Range:** 200 m (656 ft), **Maximum Range:** 500 m (1640 ft), **Accuracy/Hit Probability:** Moving targets: 40%, stationary targets: 70% when within 200 m, (45% when fired at targets beyond 200 m/656 ft); 50% of all the bombs fall within a zone 40 m (131 ft) long and 21 m (70 ft) wide. Note: It can also fire practice, frag., HE, smoke, CS, and illuminating rounds.

## 128 mm Light Rocket Launcher M71

### Launcher:

**Caliber:** 128 mm, **Weight:** 22 kgs, **Detachment:** 2 men.

### Rocket:

**Weight:** 23kg, **Weight of Warhead:** 7.55kg, **Length with Fuse:** 814 mm, **Minimum Range:** 1000m, **Maximum Range:** 8600 m, **Damage:** 1D6 × 100.

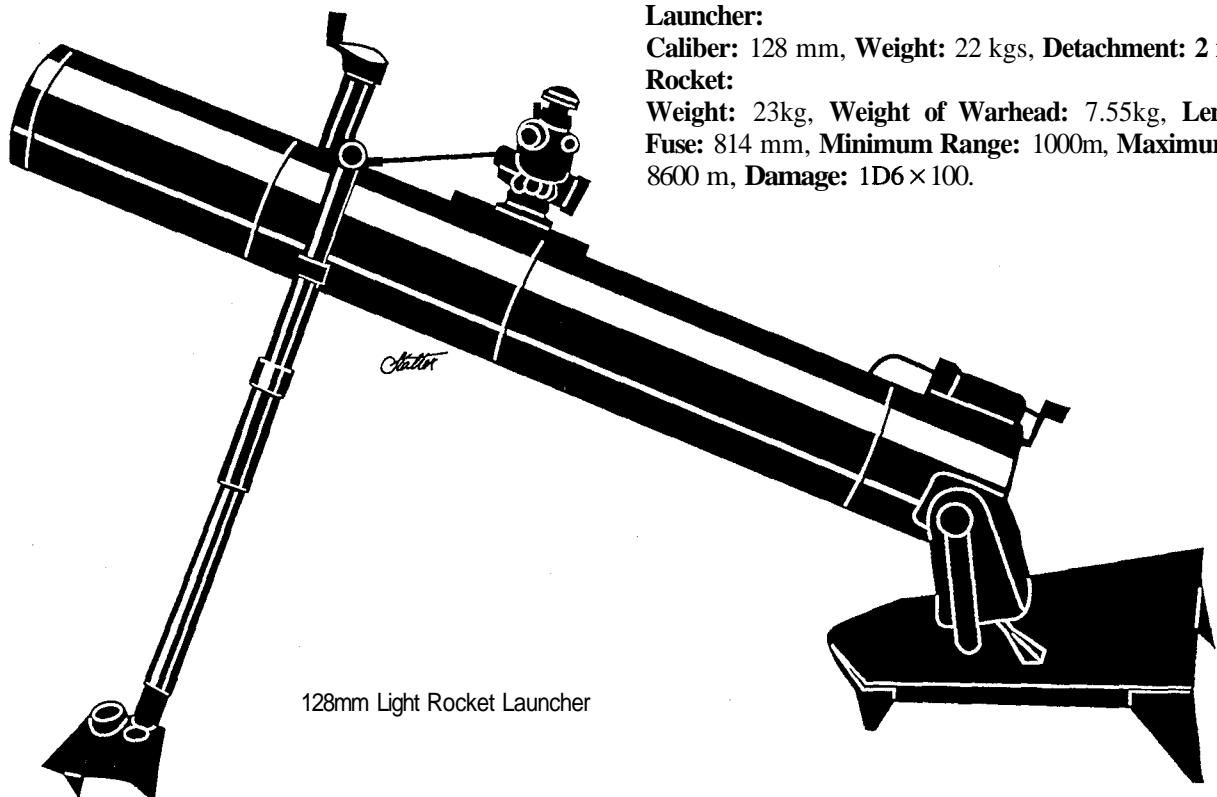

128mm Light Rocket Launcher

## M23 Mortar Ballistic Computer

This is also a portable computer for use with 60mm, 81mm and 107mm mortars. It can handle 3 concurrent fire missions, 3 firing locations, 18 individual weapon locations and 12 observer locations.

**Country:** USA, **Dimensions:** 267 X 182 x 60 mm, **Weight:** 3.2 kg, **Power Supply:** 20-32 v dc external, or battery pack.

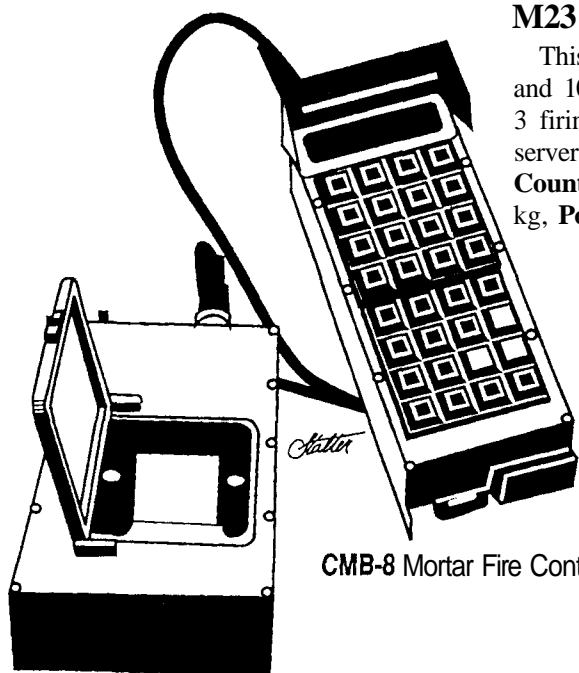

CMB-8 Mortar Fire Control Computer

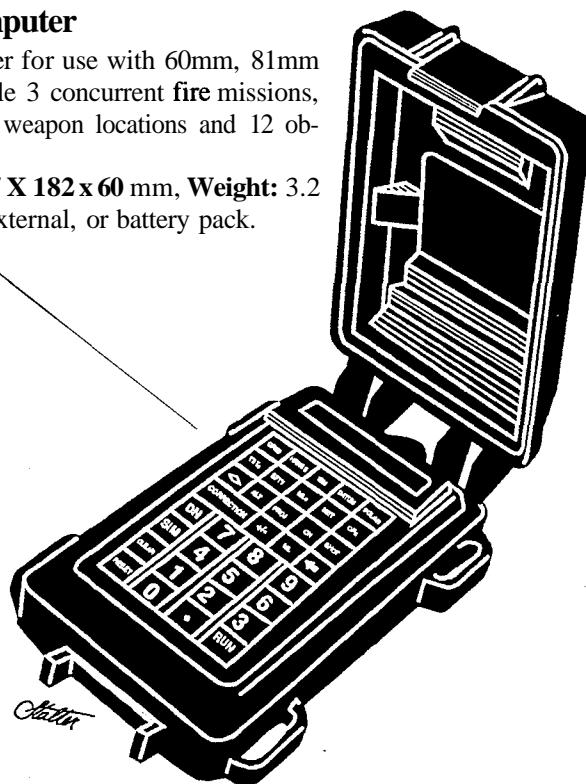

## CMB-8 Mortar fire control computer

This is a military handheld computer which can automatically compute the procedures needed to fire a battery of six mortars. It can be connected to a military hand-portable printer for recording the procedures. **Country:** Italy.

# Pyrotechnics

Pyrotechnics includes cartridges and grenades that emit smoke, sparks or flare. None are intended to be damaging explosive devices like hand grenades; they are usually meant to signal and illuminate. Note: Most pyrotechnic grenades are cylindrical, egg-shaped, or round. Most flares are cylindrical. The examples that follow, have been taken from specific countries, but most police and/or armed forces have a full range of similar cartridges, flares, trip flares, smoke grenades, signal pistols and launchers. Many of the items listed are self-contained, disposable units. Additional smoke and luminous grenades are described in the section on hand grenades, riot control and grenade launchers.

## Defence Smoke Cartridge

This is a smoke cartridge used for screening effects and also for obscuring aerial observation. The cartridge can be fired from ground or vehicle mounted projectors.

**Country:** Austria, **Weight:** 2.3 kg, **Length:** 180mm, **Diameter:** 80mm, **Weight of Charge:** 2.30 kg, **Delay Time:** 3 seconds, **Diameter/area of smoke cloud:** 21 m (70 ft), **Firing Range:** Varies with type of projector, typically 100 to 300 m (328 to 984 ft).

## Smoke Cartridge HC-72

This is a smoke canister electrically fired from a disposable metal canister (Discharger Equipment 69) which contains a propellant. On firing, the grenade is thrown a distance of about 50 m (164 ft) and the smoke composition ignites within 5-7 seconds after launching.

**Country:** Austria, **Weight:** 5 kg, **Length:** 322mm, **Diameter:** 80mm, **Delay Time:** 5-7 seconds, **Diameter/area of smoke cloud:** 12 m (40 ft), **Firing Range:** 50 m (164 ft). **Duration of the smoke:** 70 to 90 seconds; typically grey or white in color.

## Smoke Generator HC-75

This large smoke generator can create smoke for up to 22 minutes. It should not be used in confined areas and the amount of sparks it releases has been known to set dry grass on fire.

**Country:** Austria, **Weight:** 10.50 kg, **Height:** 200mm, **Diameter:** 120mm, **Delay Time:** 4.5 seconds, **Diameter/area of smoke cloud:** 30.5 m (100 ft), **Firing Range:** Usually placed and activated by hand, or fired from large launchers. **Duration of the smoke:** 18 to 22 minutes; typically grey or white in color.

## Illuminating Mine LK-40

This is a trip-operated flare unit that can be activated by pull, pressure or the cutting of the tripwire.

**Country:** Austria, **Weight:** 450 grams, **Height:** 120mm,

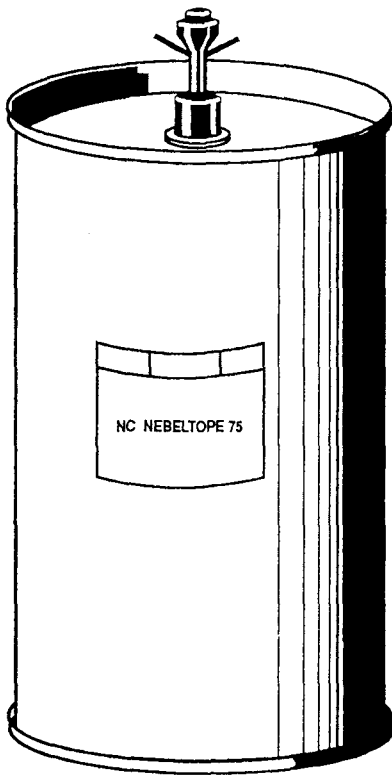

Smoke Generator HC-75

**Diameter:** 55mm, **Delay Time:** 1 second, **Diameter/area of smoke cloud:** N/A, **Luminous Power:** 280,000 candela, typically yellow or white color. **Firing Range:** Immediate trip area. **Duration of the flare:** 40 seconds.



Illuminating Mine LK-40

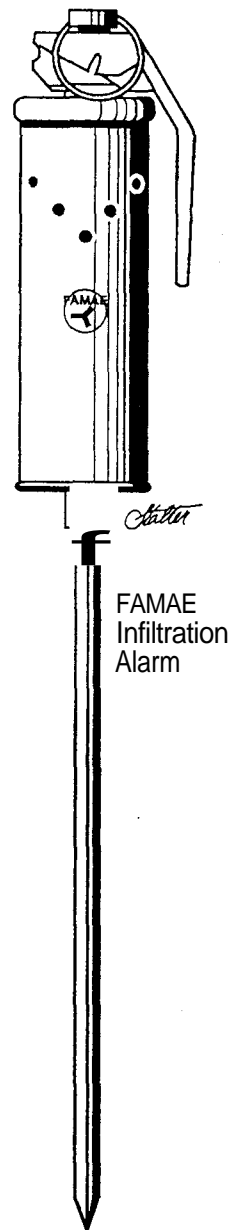

FAMAE Infiltration Alarm

### FAMAE Infiltration Alarm

This is a trip-flare that emits a bright white light for 20 seconds followed by a loud detonation.

**Country:** Chile, **Weight:** 430 grams, **Height:** 125mm, **Diameter:** 55mm, **Delay Time:** 1 second, **Diameter/area of smoke cloud:** N/A, **Luminous Power:** 280,000 candela, typically a bright white color. **Damage:** 1D4 to a 1.2 meter area (4 ft). **Firing Range:** Immediate trip area. **Duration of the flare:** 20 seconds.

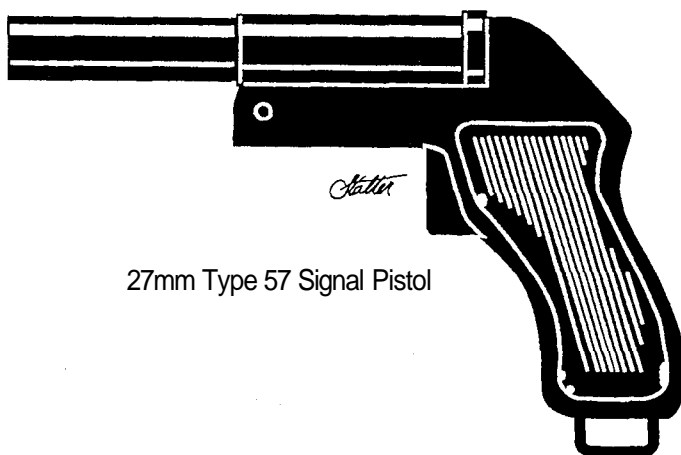

27mm Type 57 Signal Pistol

### 27mm Type 57 Signal Pistol

This is a single-shot pistol used for firing signal flares. The cartridge is typically 27mm.

**Country:** China, **Pistol weight:** 900 grams, **Pistol length:** 220mm, **Flare:** 27mm, **Delay time:** 1.5 seconds, **Diameter/area:** N/A, **Luminous Power:** 50,000 candela, **Colors of the flare:** Yellow, white, red or green. **Pistol rate of fire:** 10 to 12 rounds per minute, **Damage:** N/A, unless deliberately shot directly at/into somebody, then it will inflict 1D6 damage (P.V. 1) and has a 50% chance to cause combustible material to catch fire. **Firing range:** 90 m (height: 295 ft). **Duration of the flare:** 6 to 7 seconds.

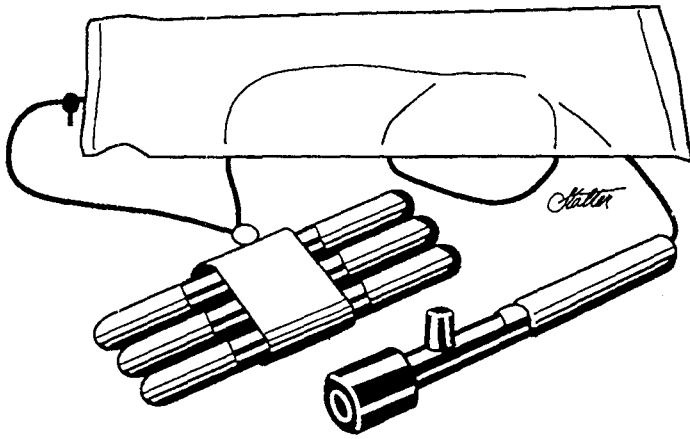

### Type 428 Distress Signal Kit

This kit consists of a launcher and six red flares, which when fired vertically can reach a height of 400 m and can be seen 60 km (38 miles) on a clear night. There is no recoil or spark from the launcher.

**Country:** France, **Weight of kit:** 250 grams, **Dimensions of kit:** 140mm×70×15, **Delay Time:** 2.5 seconds, **Diameter/area:** N/A, **Luminous Power:** 5000 candela each, typically a bright white color. **Firing Range:** 400 m (1312 ft; height). **Duration of the flare:** 11 seconds. **Visibility:** Up to 60 km (38 miles) on a clear night.

The aircraft dispensing this cartridge should not be more than 100 m (328 ft) high and can not be traveling more than 400 km/h (250 mph). A greater height or speed will prevent an accurate drop and may damage the message cartridge.

**Country:** Germany, **Delay:** 2 seconds, **Diameter/area:** N/A, **Color:** Red smoke. **Firing Range:** 100 m (328 ft; height). **Duration of the smoke:** 30 seconds.

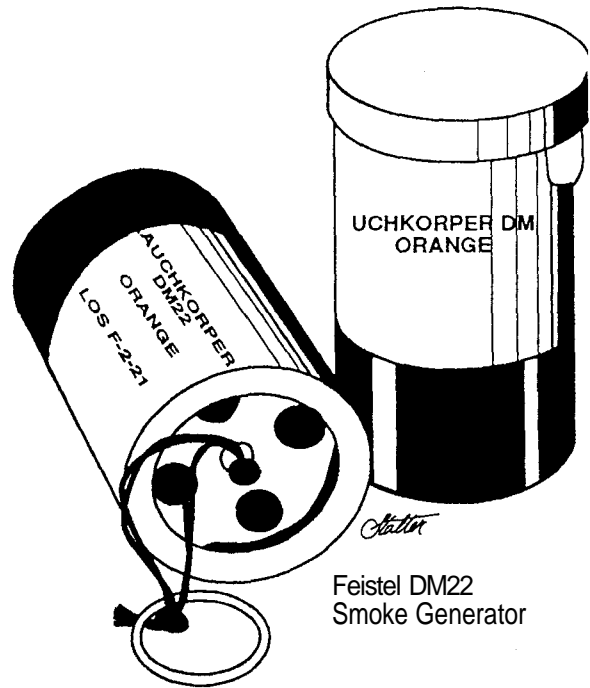

Feistel DM22  
Smoke Generator

### Feistel DM22 Smoke Generator

This type of generator is used mostly for marking landing areas or indicating wind direction or strength.

**Country:** Germany, **Delay:** 4 seconds, **Diameter:** 50mm, **Length:** 95mm, **Weight:** 185 grams, **Color:** Typically orange. **Firing Range (from typical grenade launcher):** 400 m (1312 ft). **Duration of the smoke:** 60 to 90 seconds.

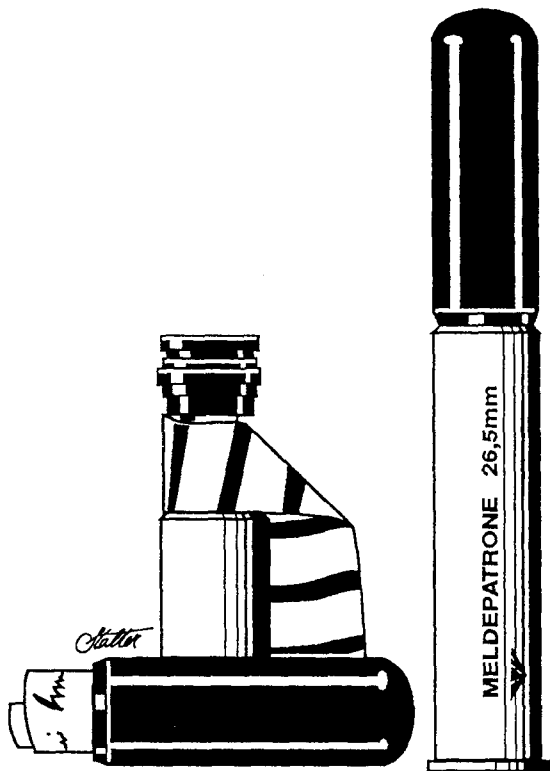

### Feistel 26.5mm Message Cartridge

This is a device which is intended for the purpose of conveying messages from aircraft to ground troops. It consists of a metal case and a propellant. Once the cartridge is ejected, it emits a red smoke for about 30 seconds and also deploys a red & white ribbon so the landing point can be easily identified. Once located, the nose is removed and the message can then be taken out of the casing.

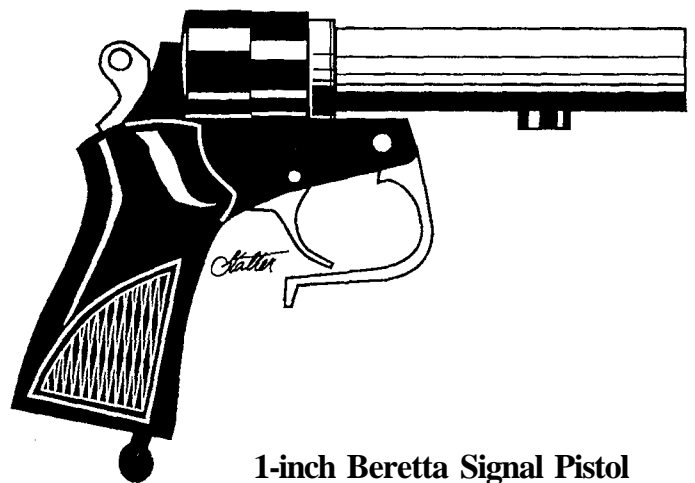

### 1-inch Beretta Signal Pistol

This is a simple single-action pistol. One of the unique features of this weapon is that by using a .32 blank cartridge this weapon can be used as a line-thrower. An ordinary fishing wheel is attached to the barrel. A nylon muzzle cap is placed on the end of the barrel with the fishing line attached. It can be fired about 50 m (164 ft), and reeled back if necessary.

**Country:** Italy, **Caliber:** 1 inch (25 mm) and can fire 15 to 22 mm flares, **Weight:** 590 grams, **Length:** 213 mm, **Height:** 150 mm, **Weight with line-thrower attached:** 920 g, **Barrel Length:** 145 mm, **Range with line-thrower:** 50 m (164 ft). **Firing Range (for typical flare):** 100 m (328 ft). **Duration of the flare:** 6 to 12 seconds.



### 38 mm handheld rockets

This tubular launch weapon was developed for ease of operation. The top and bottom caps are removed from the launch tube and the trigger mechanism is then freed. While holding the rocket casing firmly, the trigger (bottom) is pressed against the casing and the rocket is ignited. The rocket flare is typically of the parachute variety and can be used to signal location, distress or to light up an area.

**Country:** United Kingdom, **Delay:** 2.5 seconds, **Diameter:** 48mm, **Length:** 267mm, **Weight:** 345 grams, **Luminous Power:** 150,000 candela, **Color:** Red or green (signal distress), maroon with flashes and loud report (for radar location), orange (paratarget target/parachute drop site), and white for illuminating, **Firing Range (height):** 300 m (1148 ft) vertical firing/30 degree angle or 200 m (656 ft) when launched at a 45 degree angle, **Duration of the Flare:** 30 to 90 seconds. **Visibility:** 6.2 km (4 miles) in daylight, or 21 km (13 miles) in darkness.

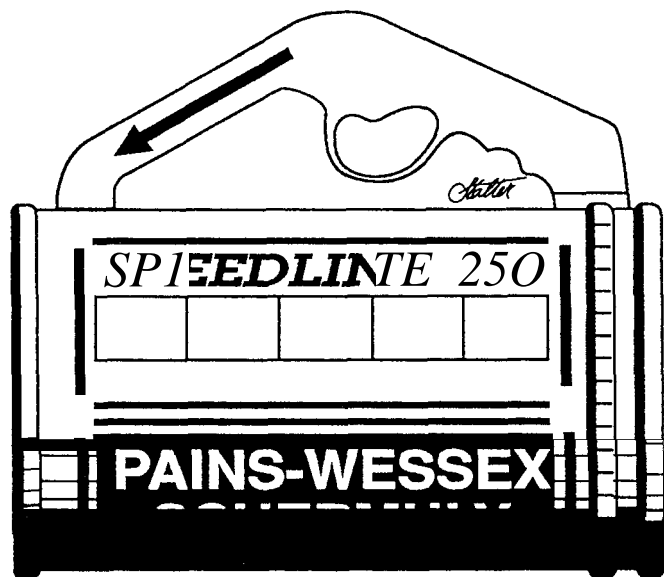

### Portable Speedline 250 Line-throwing Unit

This unit was designed for use by the Navy and Coast Guard Forces (it is also used by UK submarines). It is completely waterproof and can be fitted with a buoyant head or a grapnel.

**Country:** UK, **Weight:** 4.6 kg (complete unit), **Length:** 334 mm, **Container Diameter:** 190 mm, **Range with line-thrower:** 50 m (164 ft). **Line Length:** 275 m (902 ft), **Line Diameter:** 4 mm, **Operational Range:** 250 m (820 ft) in calm weather.

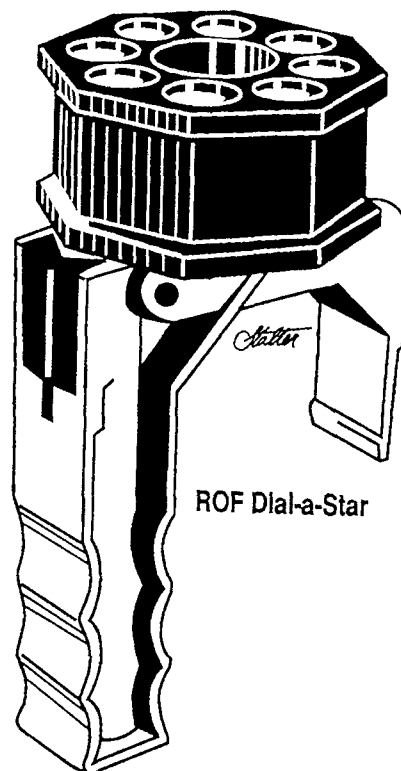

ROF Dial-a-Star

### ROF Dial-A-Star

This signaling kit was developed for combat as well as rescue use. The hand operated unit can fire up to eight flares of different colors in rapid succession or a single flare by rotating the indexing cassette. A glove must be worn when firing this item to avoid burns from the discharge (1D6 damage).

The flare device is very weatherproof and can be submerged in seawater for up to 24 hours and still be operational. It has a five-year storage life.

**Country:** United Kingdom, **Delay:** 2 seconds, **Weight:** 190 grams, **Luminous Power:** 100,000 candela, **Color:** Red or green (signal distress), maroon with flashes and loud report (for radar location), orange (paratarget target/parachute drop site), and white for illuminating, **Firing Range (height):** 300 m (1148 ft) vertical firing/30 degree angle or 200 m (656 ft) when launched at an 45 degree angle, **Duration of the Flare:** 20 to 45 seconds. **Visibility:** 3.2 km (2 miles) in daylight, or 11 km (7 miles) in darkness.

# Surveillance Equipment

## Binoculars, Night Sights & Scopes

**Note:** The following are a selection of various scopes and optical enhancement equipment from around the world. Most Armed Forces have the entire range of optical equipment available to them.

**Night Sight or Night Vision:** Refers to optical enhancements that amplify *ambient* light (existing, natural light). This is also referred to as a *passive* system because these scopes and optic systems do not emit any light of their own.

**Moonlight:** The typical "night sight" scope is a light amplification system. The viewing distance for "moonlight" will always be greater because the ambient light is greater.

**Starlight:** Means there is no moon and only starlight (or the equivalent).

**Infrared:** The old infrared night sight systems emitted a beam of infrared light that is invisible to the human eye and enabled the user of the system to see wherever the infrared light beam was projected. This system had two main problems. One, the energy of the battery was depleted much more rapidly (within a few hours). Two, another person with an infrared optic system could see any other infrared light. Thus, an enemy could follow the light beam back to its point of origin. No infrared systems are listed in this book.

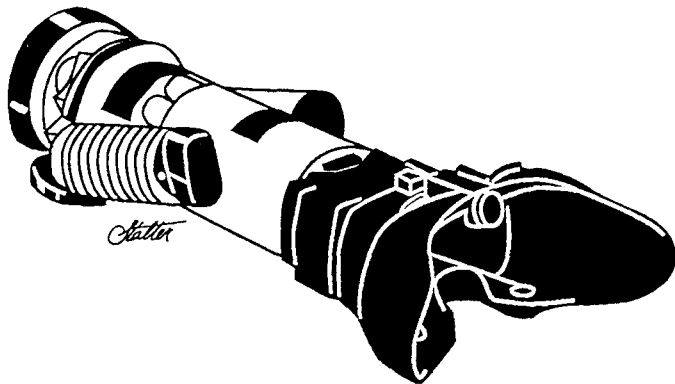

### OB-44 SOPELEM Night Observation Binocular

This is a low light level viewer designed for general night observation. It can also be used from a moving vehicle.

**Country:** France, **Magnification:**  $\times 2.5$ , **Focus Range:** 21 m (70 ft) to infinity, **Range Performance:** 600 m (1969 ft) for human targets, 1200 m (3937 ft) for large/tank targets, **Dimensions:** 90 X 120 x 330 mm, **Weight:** 2.25 kg. **Battery Powered:** 27V mercury or lithium battery or 2 x 15 commercial standard batteries, **Battery Life:** Approximately 40+ hours of use.

### OB-50 Mk 2 SOPELEM Night Firing Scope

This scope is designed for observation and aiming with artificial lighting of the target. The telescope is adaptable to all current types of infantry weapons and is very well suited for rifles,

machine guns and light anti-tank rocket launchers.

**Country:** France, **Weight:** 0.9 kg, **Length:** 230 mm, **Magnification:**  $\times 3.2$ , **Battery Powered:** 27V mercury or lithium battery or 2 x 15 commercial standard batteries, **Battery Life:** Approximately 40+ hours of use.

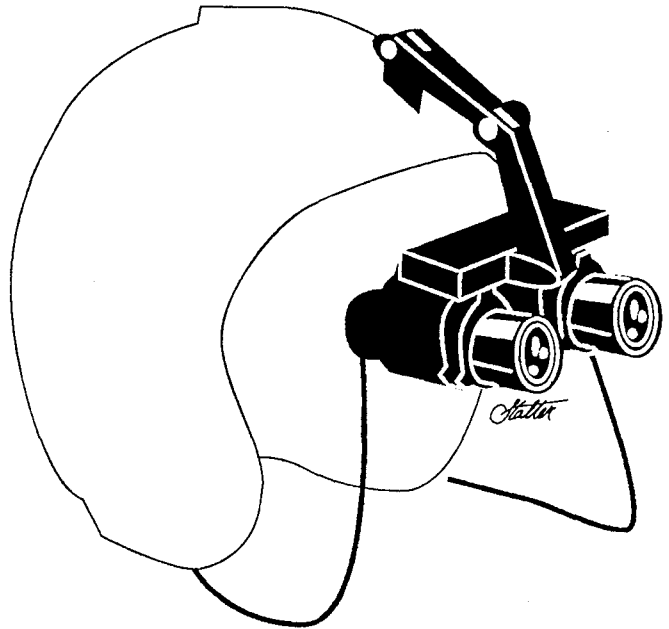

### CN2H SOPELEM Night Flying Goggles

These goggles are designed for night observation, night flying, and instrument and map reading in helicopters and aircraft.

**Country:** France, **Magnification:**  $\times 1$ , **Weight:** 560 grams (binoculars only); 935 grams (complete equipment). **Powered Supply:** On board system or one PS31, 3.5V battery, **Battery Life:** On board is indefinite, batteries 40+ hours of use.

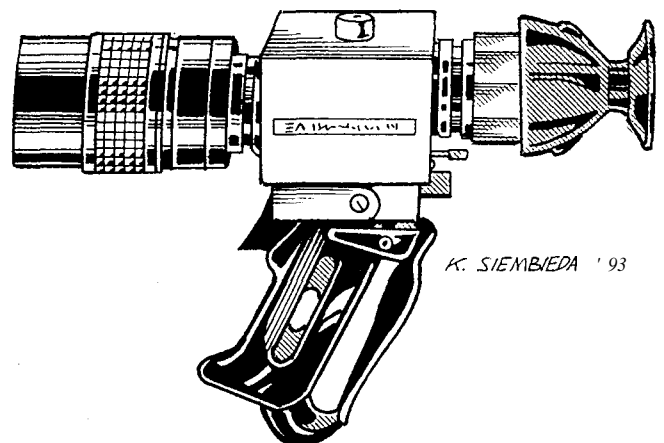

### Euroscope H II Night Viewing Device

This device is handy for many different applications. This is a low light device which can have several different lenses, eyepieces, adaptors for SLR cameras, motion picture or video cameras and laser illuminators.

**Country:** Germany, **Magnification:** x 3, **Dimensions:** 280 x 80 x 255 mm, **Weight:** 1.68 kg complete, **Battery powered:** Two AA cells/LR6 batteries. **Battery Life:** Approximately 30+ hours of use.

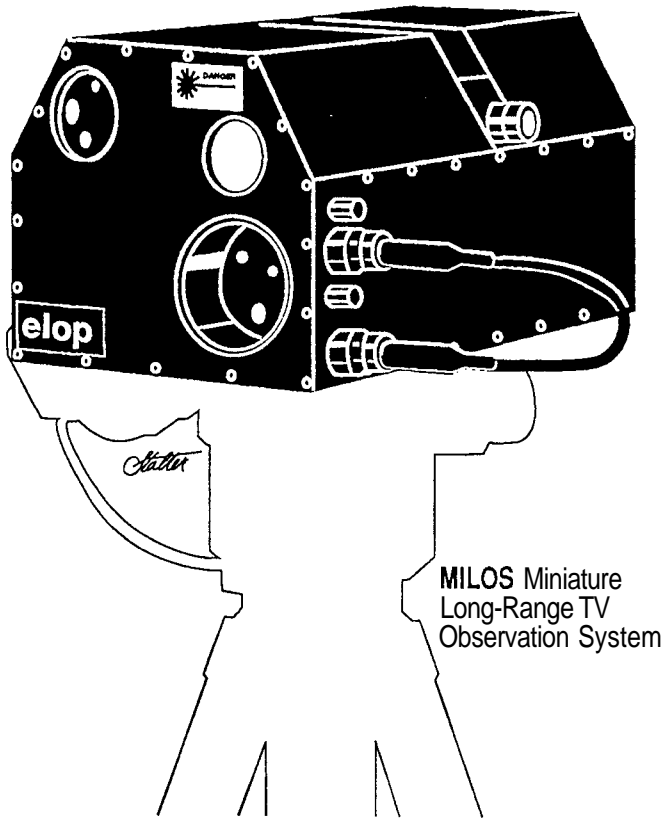

MILOS Miniature Long-Range TV Observation System

### MILOS Miniature long-range TV observation system

This is a lightweight, portable, long-range television observation system. The system has two TV fields of view, with a laser range finder and a tilt pedestal. It is a stand-alone system with a night vision option.

**Country:** Israel, **Rangefinder Coverage:** At least 40 km (25 miles) to any visually recognizable target, **Weight:** 13 kg, **Dimensions:** 230 x 250 x 530 mm. **Battery Powered:** 24V vehicle battery or NiCd lithium battery pack, **Battery Life:** Approximately 50 hours.

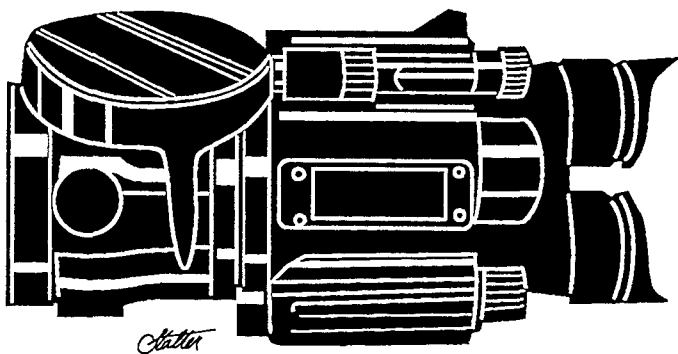

### KOT-II Night Observation Binocular

**Country:** South Africa, **Dimensions:** 340 x 165 x 110 mm, **Weight:** 2.7 kg, **Magnification:** x4.35, **Focus Range:** 30 m (100 ft) to infinity, **Battery powered:** Two AA cells. **Battery Life:** Approximately 40+ hours of use.

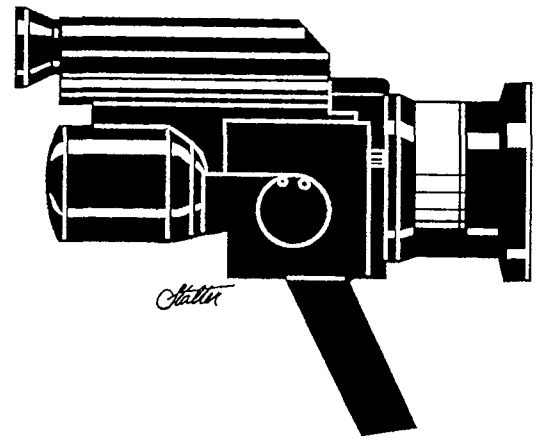

### HHI-8 Handheld Thermal Imager

This is a self-contained, fully portable imager that gives high quality pictures in total darkness, through battle field smoke and most mist and fog. Operation is simple and requires little training. Compressed air and electrical current are activated by the use of a single control and the imager is ready in a few seconds. The image is then projected on a green CRT screen and it can be selected to show white-hot or black-hot images as desired. Alternatively, the image display unit can be detached from the body for remote viewing and can be linked by a scan converter to a T.V. monitor.

**Country:** UK, **Dimensions:** 410 x 140 x 140 mm, **Weight:** 4.5 kg, **Field of View:** 70 m x 40 m (narrow field; 230 x 130 ft), 170 m x 100 m (wide field; 560 x 330 ft). **Battery powered:** Two AA cells. **Battery Life:** Approximately 40+ hours of use.

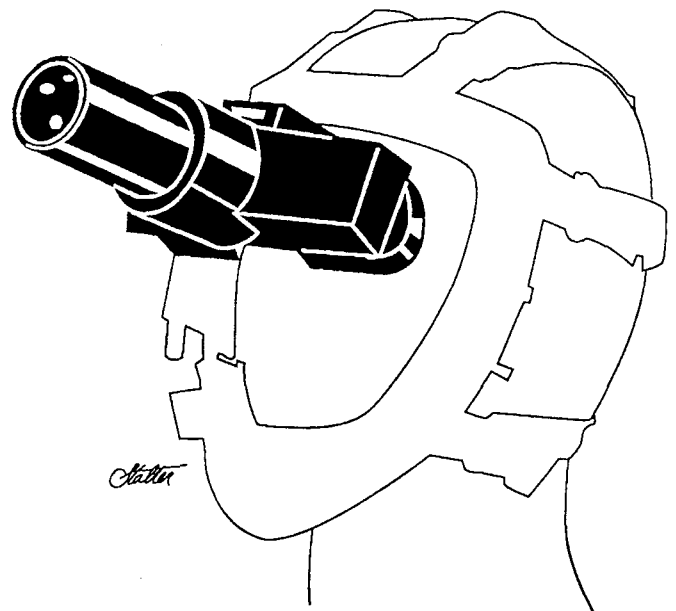

### Baird General-Purpose Night Vision Goggles

This is a general purpose night vision goggle which is attached to a simple face mask with a quick release for donning and removing the apparatus. The goggle can also be handheld or mounted on a helmet.

**Country:** USA, **Weight:** 450 grams, **Magnification:** x 1, **Focus Range:** 250 mm to infinity, **Battery powered:** 2.8 V, type E132. **Battery Life:** Approximately 45+ hours of use.

# Sighting Equipment

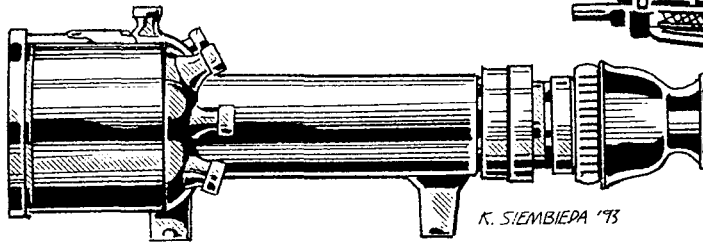

## Orion 80 Passive Night Sight

This is a small arm night sight.  
**Country:** Germany, **Magnification:**  $\times 4$ , **Focus Range:** 21 m (70 ft) to infinity, **Max. Diameter:** approx. 95mm, **Length:** approx. 290mm, **Weight:** approx. 1.8 kg, **Battery powered:** 2.5V NiCd rechargeable battery, **Battery Life:** Approximately 45+ hours of use.

## EEV Lion Night Sight

The 'Lion' (Lightweight Individually-Operated Night) sight is a simple night sight for individual weapon systems. It also has a pistol grip attachment available for handheld applications.  
**Country:** UK, **Length:** 273mm, **Diameter:** 80mm, **Magnification:**  $\times 3.5$ , **Focus Range:** 25 m (80 ft) to infinity, **Range:** 600 m (1969 ft), **Battery powered:** 2  $\times$  AA alkaline batteries or NiCd lithium battery. **Battery Life:** Approximately 100+ hours of use.

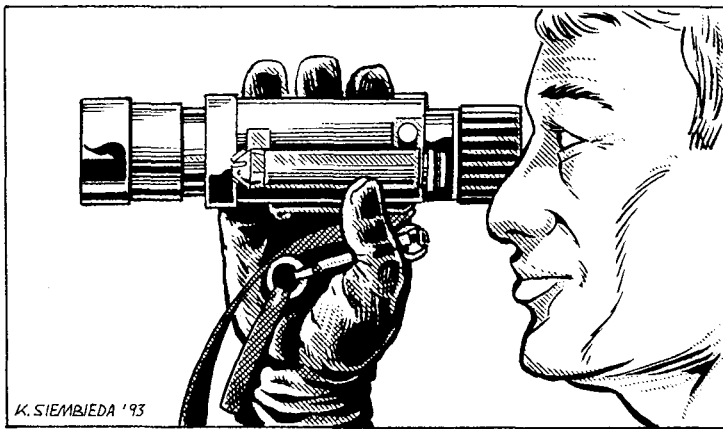

## Type SS82 Lightweight Pocketscope/Weapon Sight

Compact pocketscope that can be attached to a weapon or handheld.  
**Country:** UK, **Weight:** 700 grams, **Magnification:**  $\times 2$ , **Length:** 230mm, **Width:** 75mm, **Height:** 70mm. **Battery powered:** 2.7V mercury battery as standard (or AA alkaline batteries; optional). **Battery Life:** Approximately 50+ hours of use.

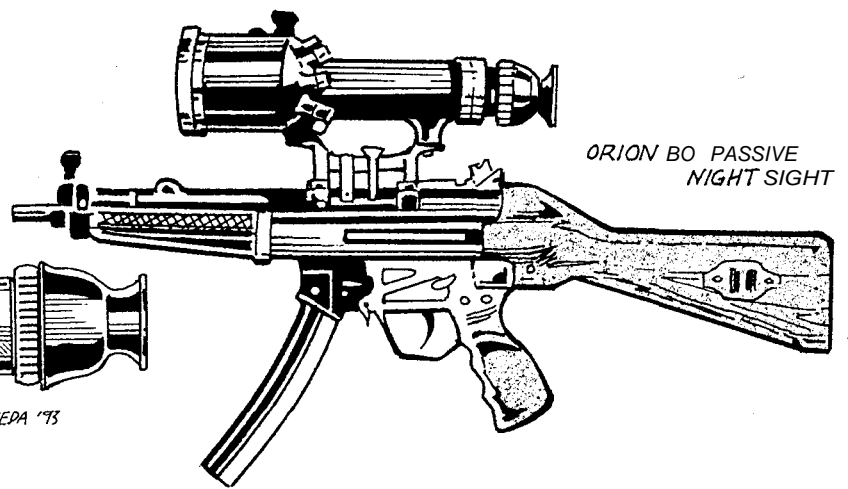

## W201 Individual Weapon Sight

The W201 is a newer design and is lighter and shorter than similar scopes. Mounting brackets are available for most weapons and it has the standard NATO fixing centers.  
**Country:** UK, **Range:** (in starlight) 500 m (1640 ft) on infantry weapons, up to 5 km (3 1/2 miles) for surveillance depending on light level and terrain, **Magnification:**  $\times 3$ , **Length:** 216mm, **Weight:** 1.2 kg, **Overall Diameter:** 110mm. **Battery powered:** 2.7V mercury battery (or AA alkaline batteries; optional). **Battery Life:** Approximately 50+ hours of use.

## AN/PVS-2 Starlight Scope

This can be used as a handheld visual observation device or a night sight.  
**Country:** USA, **Dimensions:** 457  $\times$  89 mm, **Weight:** 1.8 kg, **Magnification:**  $\times 4$ , **Range:** starlight: 300 m (984 ft); moonlight: 400 m (1312 ft). **Battery powered:** 6.75V disposable battery. **Battery Life:** Approximately 72 hours of use.

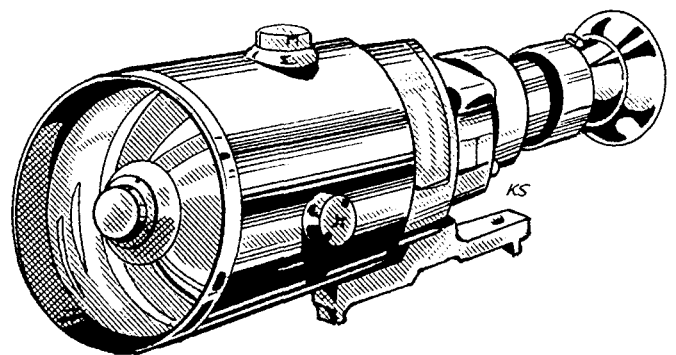

## NVS-800 Night Vision System

This system was designed for use with heavy automatic weapons, recoilless guns and armament of similar sizes.  
**Country:** USA, **Magnification:**  $\times 6$  (nominal), **Viewing Range:** Moonlight: 25-2000 m (85 to 6562 ft) or starlight: 25-1200 m (85 to 3937 ft), **Length:** 355.6mm, **Diameter:** 165mm, **Weight:** 3.856 kg, **Battery powered:** 2.7V mercury battery (or AA alkaline batteries; optional). **Battery Life:** Approximately 60 hours of use.



## Simrad KN250 image intensifier

This imager is intended to be used with traditional telescope day sights, laser rangefinders and other daylight imaging devices such as video cameras.

**Weight:** 740 grams, including batteries, **Magnification:** x 1, **Range:** 25-1000 m (85 to 3280 ft), **Battery powered:** 2.7V mercury battery (or AA alkaline batteries; optional). **Battery Life:** Approximately 40 hours of use.

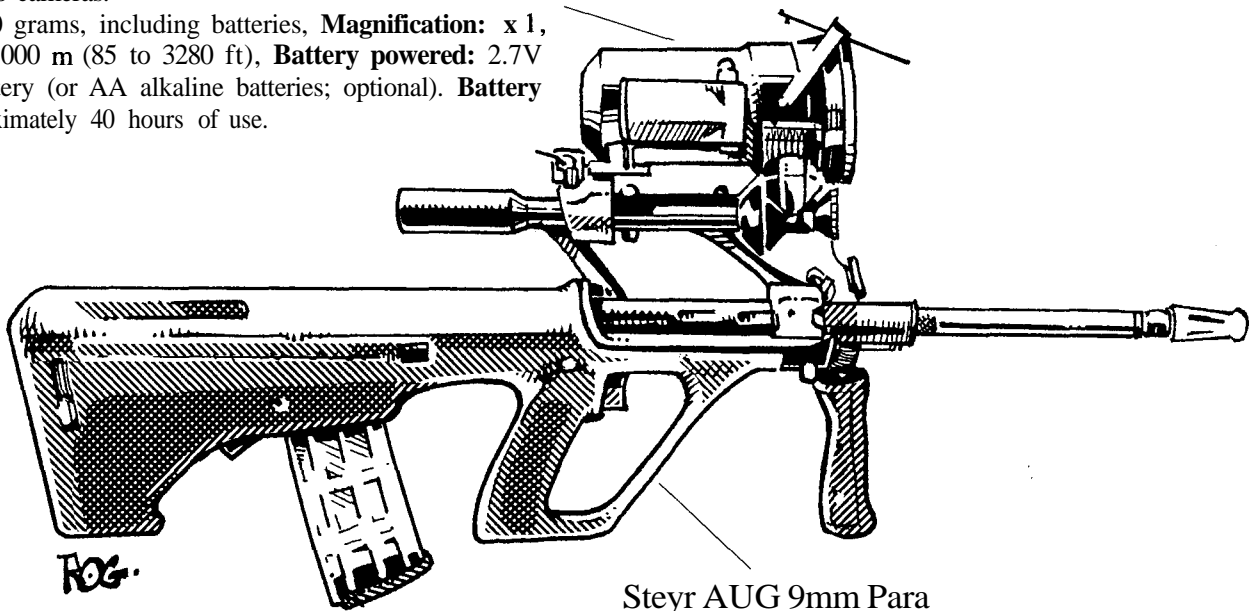

Steyr AUG 9mm Para

**Cartridge:** 9×19mm Parabellum, **Damage:** 2D6, **P.V.:** 4, **Feed:** 25 or 32 round mag., **Weight:** 3.3 kgs, **Barrel Length:** 420mm, **Muzzle Velocity:** 400 m/s, **Rate of Fire:** 650-700 rounds/min., **Approx. Effective Range:** 200 m (656 ft).

## Simrad KN 200 Image Intensifier

**Country:** Norway, **Magnification:** x 1, **Weight:** 1.4kg(1.45kg with adjustable focus) including battery. **Powered Supply:** 2.8v DC nominal, **Battery Life:** 40 hours.

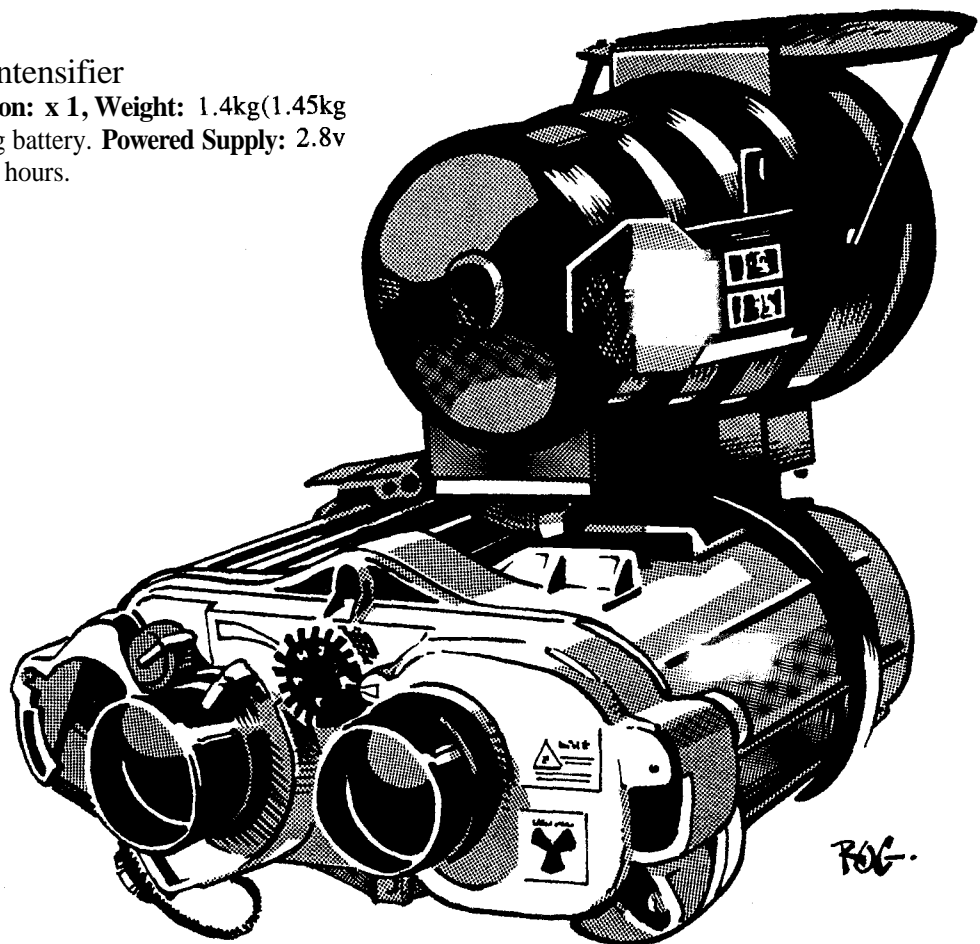

### RB 12A battlefield surveillance radar

This unit is designed to detect targets automatically, to determine ranges and bearings and to identify the nature of a moving target by means of its Doppler characteristics.

**Weight:** 32 kg, **Range:** 3.2 km (2 miles) on pedestrians, 5 km (3 1/2 miles) on vehicles.



### Laser Target Indicator

This is a lightweight laser projector which is mounted on a rifle or other direct-fire weapon. This sight can mark a target with a spot of light up to 500 m (1640 ft) away. The spot is invisible to the naked eye and therefore must be used in conjunction with an image intensifier.

**Weight:** 340 grams, **Length:** 162mm, **Diameter:** 40mm.

ROG.

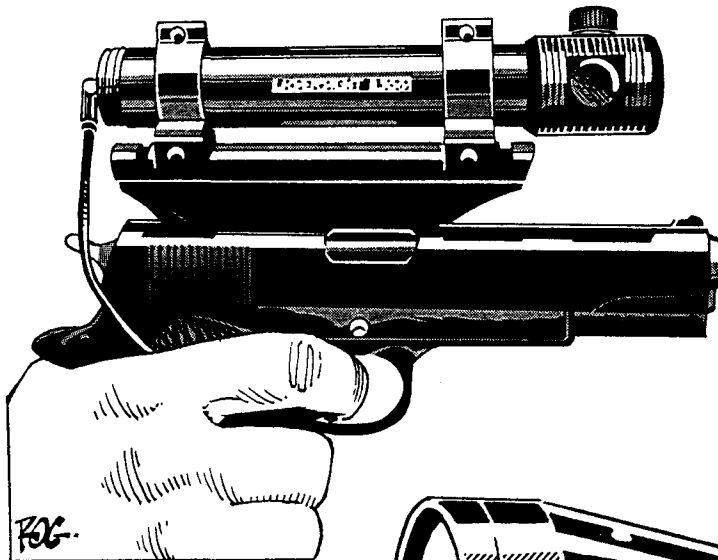

### LS55 Laser aiming system

This compact aiming system adds an accurate point-and-shoot capability to almost all personal weapons.

**Weight:** 650 grams, **Length:** 176 mm, **Width:** 25 mm.

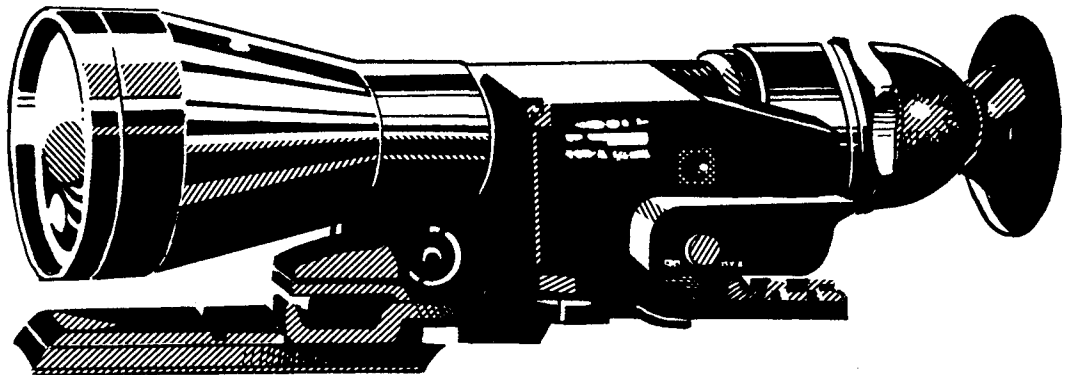

ROG.

### Aquila Mini weapon sight

**Weight:** 1.1 kg, **Magnification:** 4x, **Focal Range:** 25 m (85 ft) to infinity.

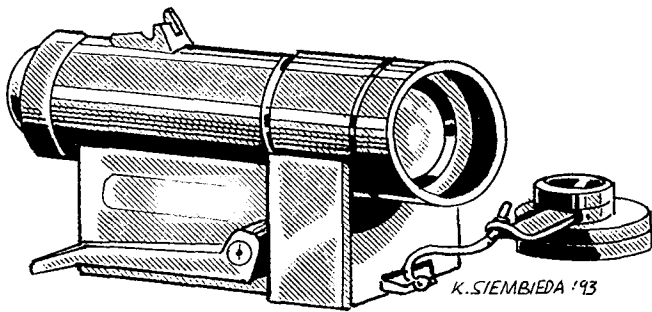

### UP 1040 Self-Powered Observation Sight

**Country:** Norway, **Magnification:** 1.5 x , **Weight:** 1.5kg, **Powered Supply:** Manually generated power supply, **Focus:** fixed at 300m.

### UP 1042 Handheld Thermal Camera

This is a low-budget, handheld thermal camera which provides visibility in all ambient light conditions, including day, night, smoke, dust and haze. The signal output of the camera is such that it can be viewed directly by the viewer as well as being recorded on standard video equipment.

**Weight:** 1.9 kg, **Focusing Range:** 25 m to infinity.

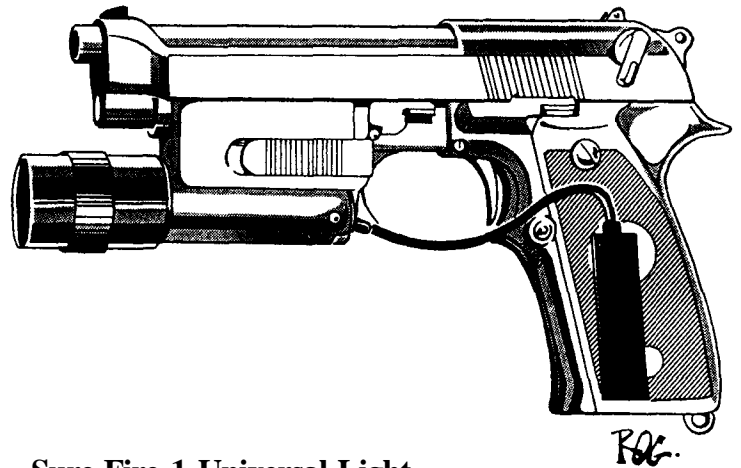

### Sure-Fire 1 Universal Light and Laser Sight System

This system provides the light needed for night-time searches and positive target identification. It also has a laser aiming beam for rapid targetting and positive aiming.

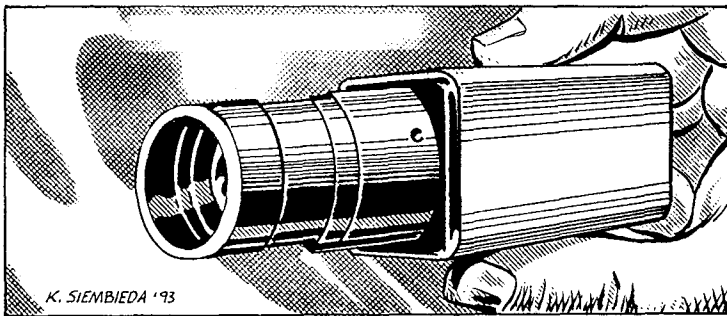

### KH 92S CCD Camera

**Country:** United Kingdom, **Resolution:** 350 TV lines, **Weight:** approx. 150g, **Powered Supply:** 12 VDC 150 mA, **Dimensions:** 34 x 36 x 69 mm, **Image Size:** 6.3(h) x 4.8(v).

### KH190R CCD Camera

This is a miniature surveillance camera.

**Dimensions:** 30 x 66 mm, **Weight:** approx. 70 grams, **Image Size:** 6.4 x 4.8 mm. **Resolution:** 350 TV lines.

### Model 97 explosives detector

This is a lightweight, easy to use explosive detection unit. It is self-contained in a simple attache-type case which is highly portable and quickly set up. Training in the use of this equipment is minimal.

**Type of Explosives Detected:** Commercial and most known military explosives. **Response Time:** 2 seconds, **Dimensions:** 500 x 370 x 160mm, **Weight:** Complete unit in case is 13.5 kg, **Battery Life:** 6 hours.

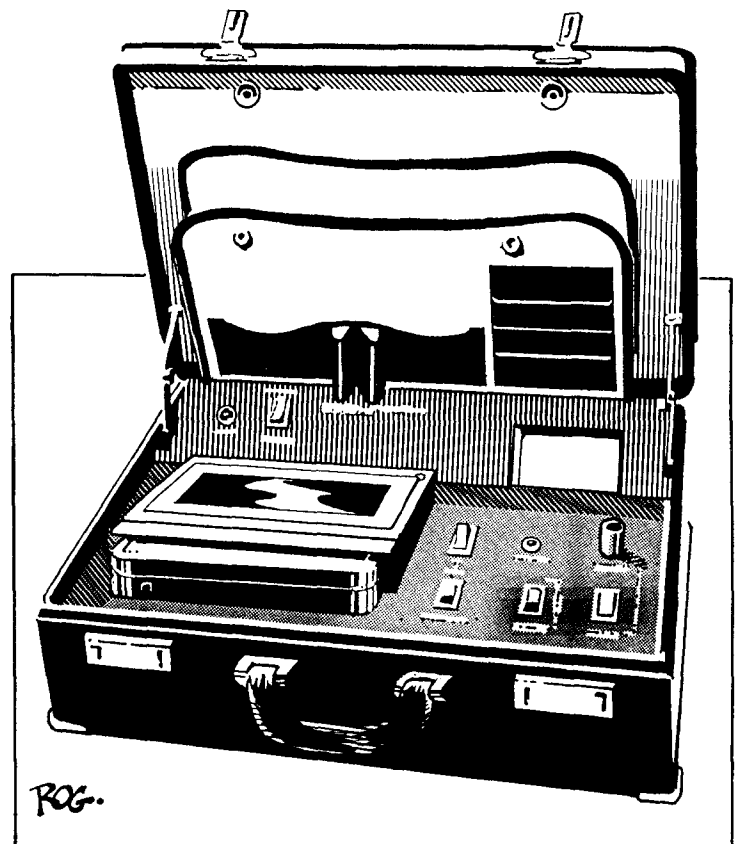

### CVS 380 discreet video system

This is a video-briefcase. The complete package of miniature camera, recorder and monitor are concealed in a normal briefcase. The unit can be operated by adjusting the combination lock or by a manual switch inside. The unit contains its own rechargeable power supply and can be left to operate for several hours.

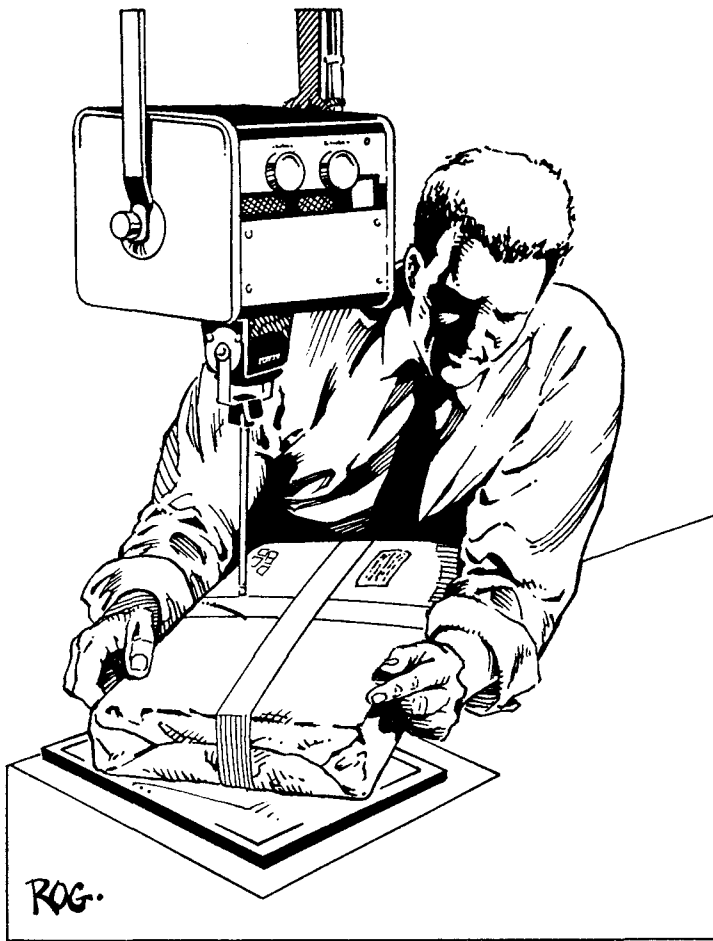

### TR Micro TransporteX portable X-ray unit

This is a small x-ray unit which can be used for internal as well as external security investigations. It is especially used for checking office equipment for transmitters or recorders, examining suspect packages in difficult locations and checking vehicles and packages for arms, ammunition and explosives or drugs.

**Case Dimensions:** 430 x 210 x 260mm, **Case Weight:** 12.5 kg, **Support Stand:** 1100 x 170 x 100mm, **Support Stand Weight:** 7.25 kg, **Processor Dimensions:** 590 x 390 x 340mm, **Processor Weight:** 16 kg.

### AS 360 MS5 ROV sonar system

This sonar device was specifically designed to be used with unmanned remote controlled vehicles. It is also designed to be used on land or in water.

**Beam Width:** Transmit and receive 1.5 degrees x 50 degrees, **Height:** 137mm, **Diameter:** 88mm, **Weight:** In air 2.3 kg; in water 1.4 kg, **Depth Rating:** 750 m (2461 ft).

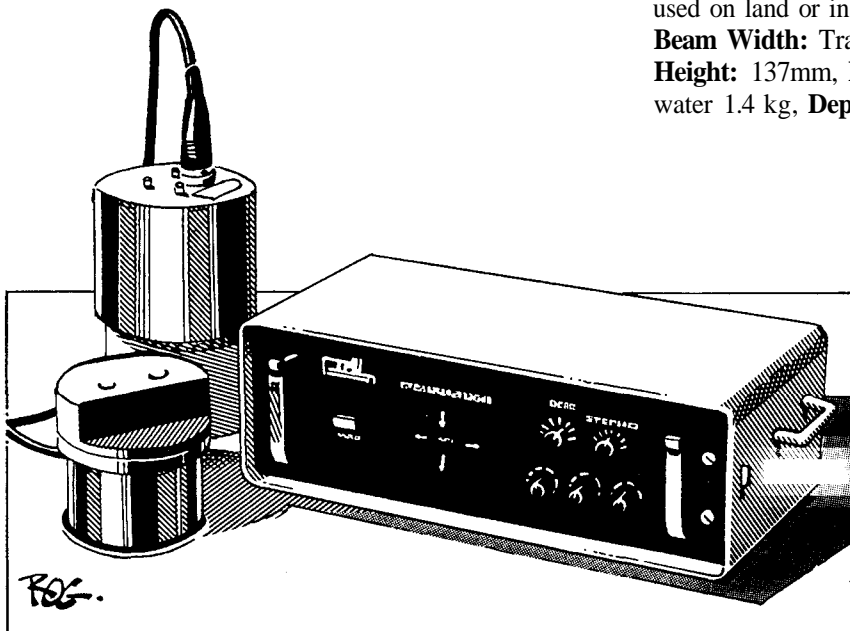

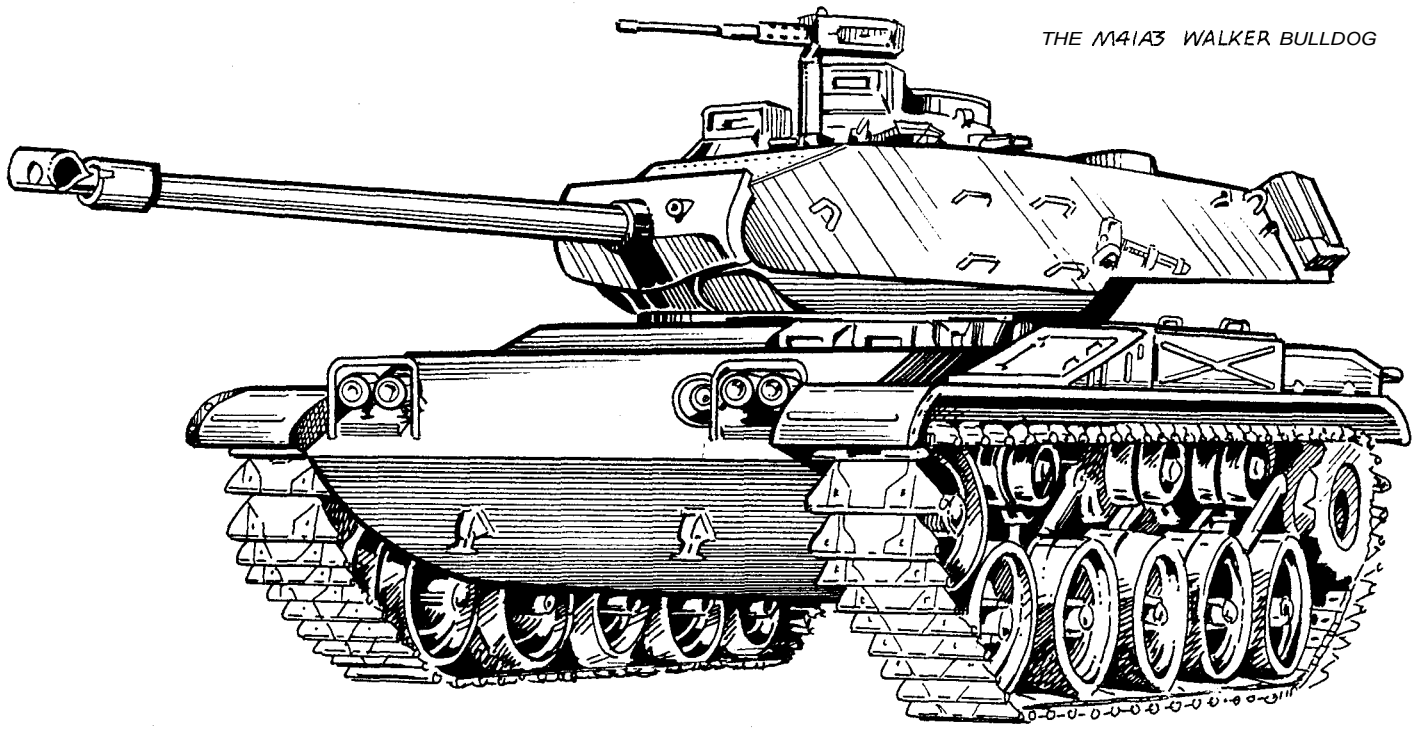

# Tanks & Armored Vehicles

The concept of the tank first came into combat during World War I, however, it was not until World War II that the armored vehicle played a major roll in infantry combat. During that war, there were three types of tanks, light, medium and heavy. By the 1950's, the idea of having three ranks of tanks disappeared, in favor of one, typically heavily armored vehicle commonly referred to as the Main Battle Tank (MBT). Advancements in electronics and **micronization** have made the modern main battle tank a versatile combat vehicle (the often delicate electronics have also increased the level of maintenance and breakdowns in the field). In recent years, ground skirmishes and limited wars have placed a new emphasis on the value of the armored vehicle.

Over the last two decades, most main battle tanks have been fitted with Nuclear, Biological and Chemical (NBC) systems to enable the war machine and crew to continue to operate in contaminated environments. Fire control systems always include a laser **rangefinder** and ballistic computer.

What once might have been considered the light and medium tank has been replaced by small, comparatively fast, light armored cars, trucks and amphibious troop carriers.

**Structural Damage Capacity:** The S.D.C. is an arbitrary damage level for role-playing game purposes. The S.D.C. number can be used directly with the *Palladium RPG system* but may have to be adjusted for other game systems.

**S.D.C. of the average tank:** Main body: 800 to 1200 points, main gun: 200, treads: 75 each pair, large wheels: 40 each wheel.

**S.D.C. of the average light/medium armored vehicle:** 400 to 700 points.

**S.D.C. of the average combat helicopter:** 300 to 400 points.

**S.D.C. of the typical mid-sized sedan (for comparative purposes):** 200 to 300 points.

**Typical Weight of a Main Battle Tank:** 30 to 56 tons.

**Range of the typical tank cannon:** 2000 to 4000 m (6562 to 13,123 ft). The blast radius is usually equal to that of a rocket launcher, with a typical blast area of about 21 m (70 ft) in diameter.

**Maximum Range:** Refers to the number of miles/kilometers that the armored vehicle can travel on a full fuel reserve.

**Maximum Speed:** Is the maximum speed the vehicle can move.

Most armored vehicles are not made for speed. Those that are fast usually sacrifice armor and firepower for speed.

## BRAZIL

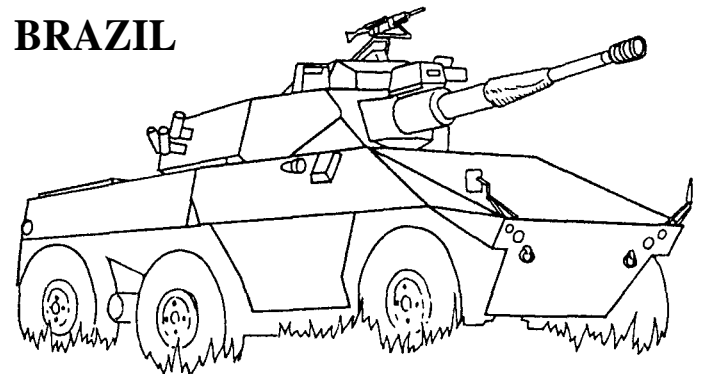

### ENGESA EE-9 Cascavel Armoured Car

This armored car is designed with a 6 X 6 wheel configuration for maximum cross-country mobility. The armaments on this vehicle include: a 90mm Cockerill MkIII gun, a 7.62mm machine gun co-axially mounted with the main armament, and a 12.7mm machine gun mounted on the roof for anti-aircraft defence.

**Country:** Brazil, **Crew:** 3, **Weight:** 12 tons, **Length:** (gun forward) 6.22 m (20 ft, 5 inches), **Width:** 2.59 m (8 ft, 6 inches), **Height:** 2.29 m (7 ft, 6 inches), **Maximum Speed:** 100 km/h (62 mph), **Maximum Range:** 1000 km (620 miles). **Weapons & Damage:** 90mm gun: Frag. 6D6 x 10, HE 1D4 x 100 or HEAT 1D6 x 100, one 12.7mm heavy machine gun: 1D6 x 10 + 6 (P.V. 7), one 7.62mm medium machine gun (P.V. 6): 6D6. Note: The 90mm cannon can also fire practice, smoke, and illuminating rounds. **Structural Damage Capacity (S.D.C.):** 560.

## FRANCE

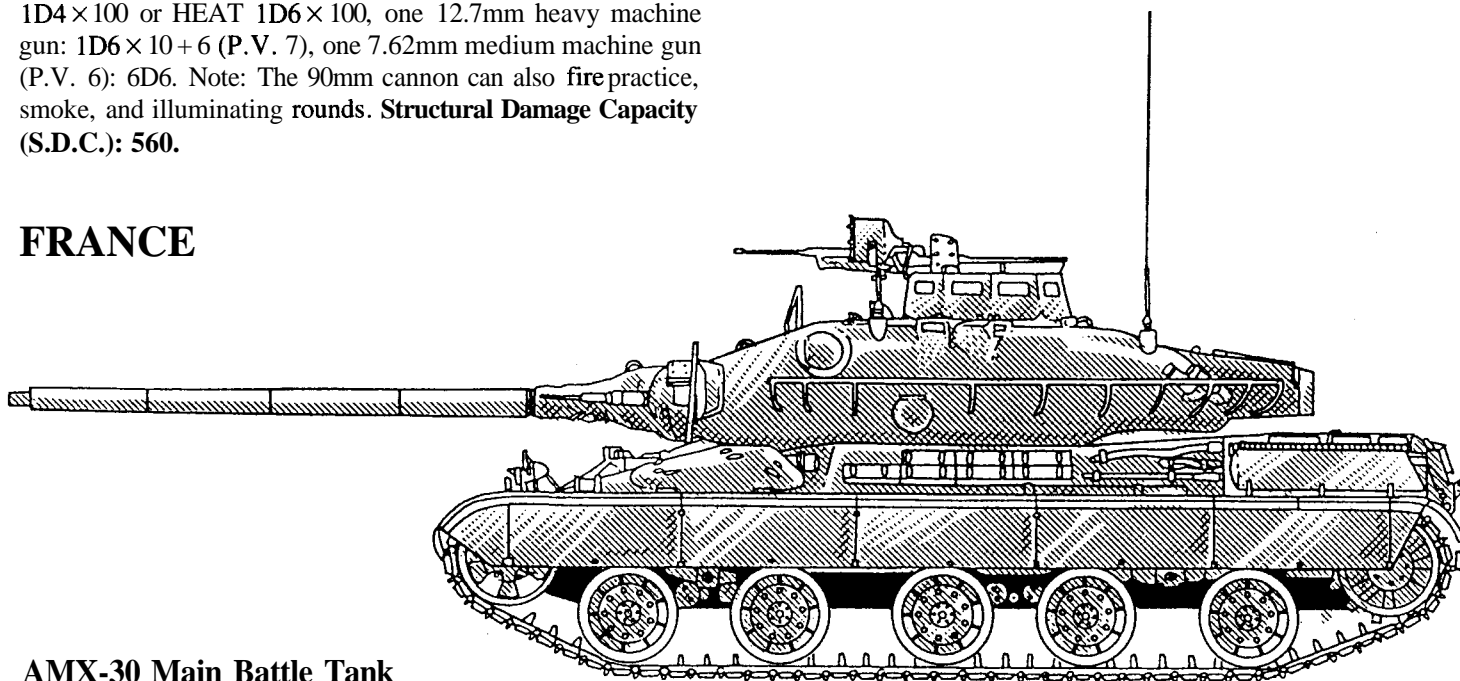

### AMX-30 Main Battle Tank

The AMX-30 is one of the lightest and quickest of the NATO tanks. Its main armaments consist of a 105mm gun with a 20mm cannon and a 7.62mm machine gun on the commander's cupola. A total of 47 rounds of ammunition is carried for the 105mm gun, of which 19 are in the turret and the remaining 28 are in the hull. A total of 1,050 rounds of 20mm ammo and 2,050 rounds of 7.62mm ammo are also carried. The 105mm gun can fire HEAT, HE, smoke and illuminating rounds. However, this tank does not have a stabilization system, consequently it can not fire its weapons when moving!

**Country:** France, **Crew:** 4, **Weight:** 36 tons, **Length:** (with gun forward) 9.48 m (31 ft, 1 inch), **Width:** 3.1 m (10 ft, 2 inches), **Height:** 2.86 m (9 ft, 4 inches), **Maximum Speed:** 65 km/h (40 mph), **Maximum Range:** 500 to 600 km (311 to 373 miles). **Weapons & Damage:** 105mm gun: HE 6D6 x 10 or HEAT 2D4 x 100, Note: The AMX-30 can also fire practice, smoke, and illuminating rounds. **Structural Damage Capacity (S.D.C.):** 1000.

### AMX-13 Light Tank

The original model of the AMX-13 tank was designed with an FL-10 turret armed with a 75mm gun and a 7.62mm machine gun. The 75mm gun is fed by two revolver type magazines, each of which holds six rounds of ammunition. The types of ammunition were fixed HE and HEAT rounds.

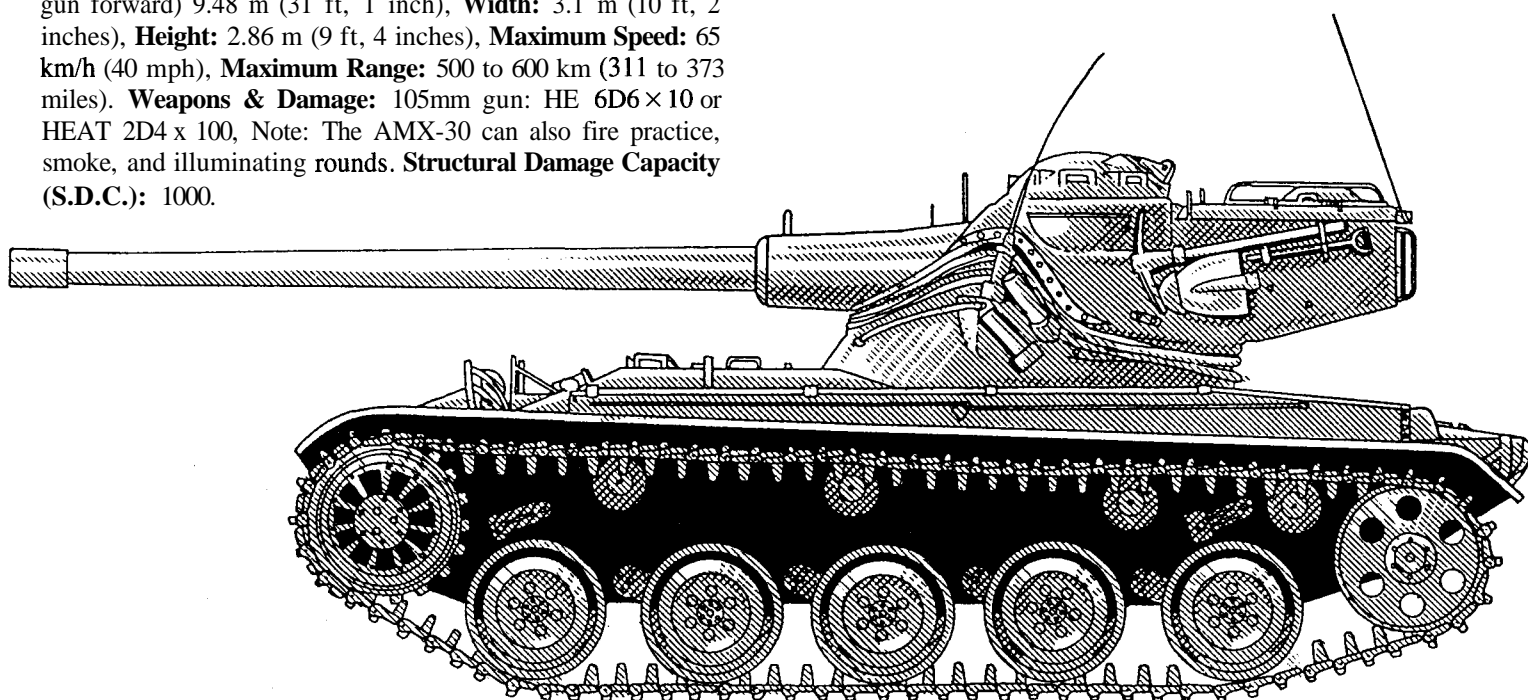

**Country:** France, **Crew:** 3, **Weight:** 15 tons, **Length:** (including gun) 6.36 m (20 ft, 10 inches), **Width:** 2.50 m (8 ft, 2 inches), **Height:** 2.30 m (7 ft, 6 inches), **Maximum Speed:** 60 km/h (37 mph), **Maximum Range:** 350-400 km (220-250 miles). **Weapons & Damage:** 75mm gun: HE 4D6 X 10 or HEAT 1D6 x 100, and 7.62mm medium machine guns (2; P.V. 6): 6D6, **Structural Damage Capacity (S.D.C.):** 700.

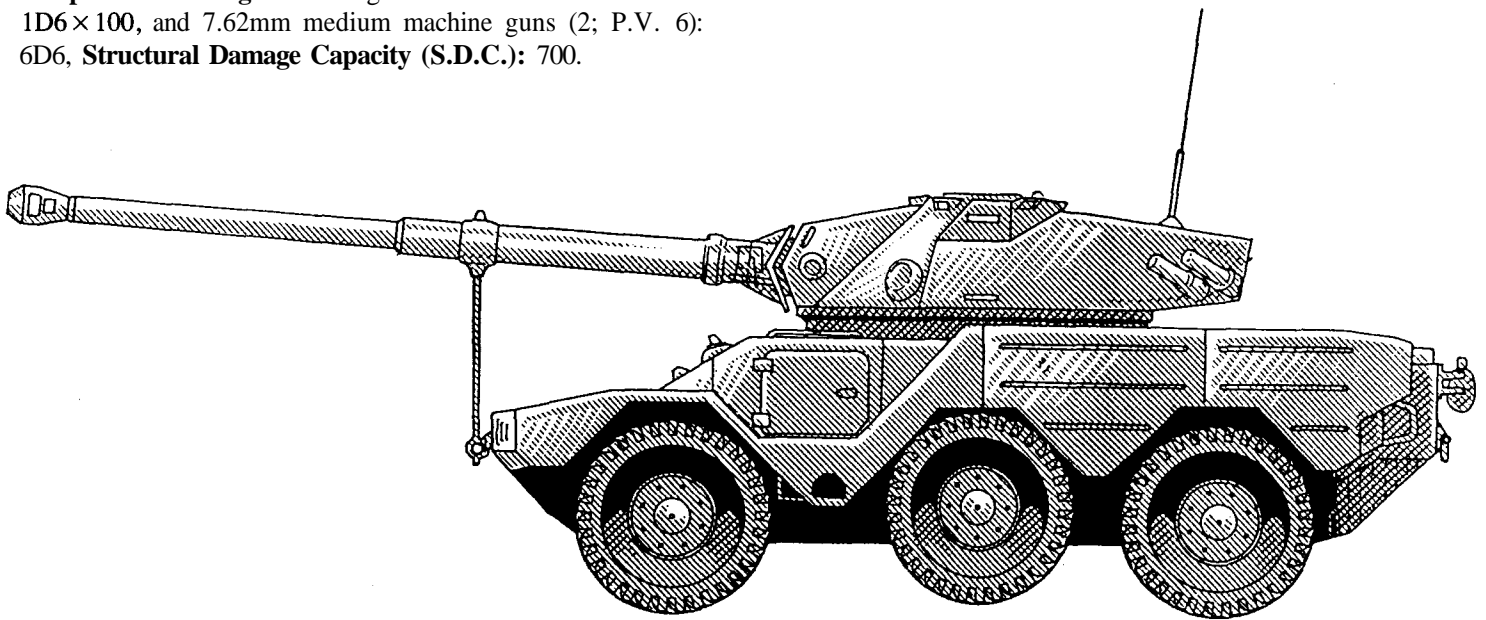

### Panhard ERC Sagaie Armored Car

This is a fully amphibious 6 x 6 vehicle. In the water it can move at a rate of 4.5 km/h (2.8 mph). Before the vehicle enters the water, a trim vane is erected at the front of the hull and two snorkels are erected at the rear. The two middle wheels can be raised off the ground for road travel and lowered again for cross-country travel. This vehicle is fitted with a 90mm gun which can fire the following types of rounds: HE, HEAT, smoke and APFSDS. A 7.62mm machine gun is mounted co-axial with the main armament, and two smoke dischargers are mounted on each side of the turret. Twenty rounds of 90mm and 2,000 rounds of 7.62mm machine gun ammo are carried.

**Country:** France, **Crew:** 3, **Weight:** 7.65 tons, **Length:** (gun forward) 7.693 m (25 ft, 3 inches), **Width:** 2.495 m (8 ft, 2 inches), **Height:** 2.07 m (6 ft, 9 inches), **Maximum Speed:** 90 km/h (56 mph), **Maximum Range:** 800 km (500 miles). **Weapons & Damage:** 90mm gun: HE 1D4 x 100, AP: 1D4 x 100, HEAT: 1D6 x 100, and one 7.62mm medium machine gun (P.V. 6): 6D6, **Structural Damage Capacity (S.D.C.):** 500.

PANHARD VBL SCOUT CAR

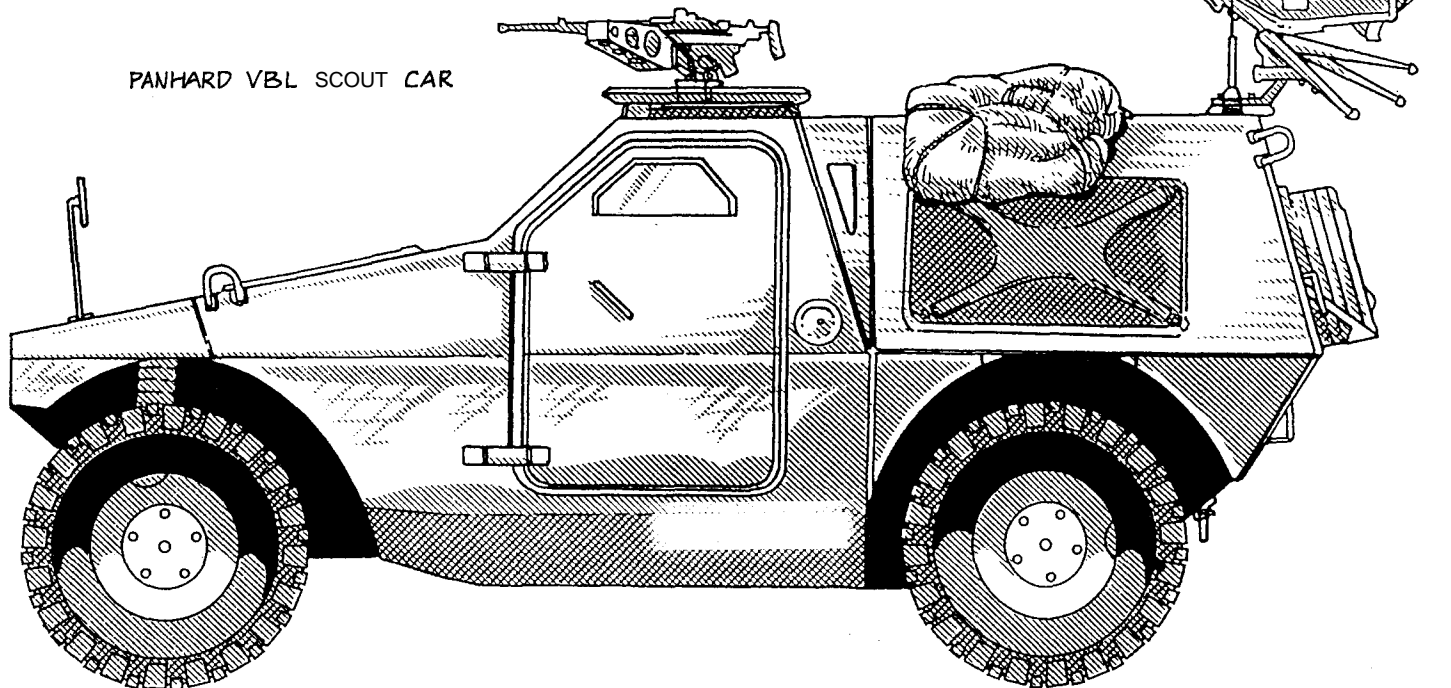

## Panhard VBL Scout Car

This is a small, light and fast armored car. Its two main functions are as a **battlefield**, anti-tank vehicle and as a reconnaissance/scout vehicle. This vehicle is fully amphibious with very little preparation, and is moved through the water by a propeller at the rear of the **hull**. It is fitted with a Milan anti-tank guided missile launcher with six missiles and a 7.62mm machine gun with 3,000 rounds of ammunition.

**Country:** France, **Crew:** 2 or 3 (depending on the mission), **Weight:** (empty) 2850 kg (6,238 lbs), (loaded) 3550 kg (7,826 lbs), **Length:** 3.82 m (12 ft, 6.4 inches), **Width:** 2.02 m (6 ft, 5 inches), **Height:** 1.70 m (5 ft, 9 in), **Maximum Speed:** 100 km/h (62 mph), **Maximum Range:** 1000 km (621 miles). **Weapons & Damage:** Milan rocket launcher: HEAT 1D6 X 100 or HE 1D4x 100, and one 7.62mm medium machine gun (P.V. 6): 6D6, **Structural Damage Capacity (S.D.C.):** 400.

## GERMANY

### TM 170 Armored Personnel Carrier

This APC can carry two crewmen and 12 fully equipped infantrymen. Because it is lightly armored, this unit is, more often than not, used for internal security roles for the rapid and safe transport of riot squads to spots where they are needed. The driver and commander, who sit in the front of the vehicle, are protected by bullet-proof glass which is covered by armored shutters in combat. When the shutters are in place, a periscope is used for observation. A 7.62mm machine gun or 20mm cannon may be fitted to the top of the vehicle. The vehicle is also amphibious (fitted with waterjets which give it a maximum speed of 9 km/h/5.6 mph).

**Country:** Germany, **Crew:** 2+ 12, **Combat Weight:** 10.47 tons (9500 kg/20,944 lbs), **Length:** 6.10 m (20 ft), **Width:** 2.45 m (8 ft), **Height:** 2.22 m (7 ft, 3 inches), **Maximum Speed:** 100 km/h (62 mph), **Maximum Range:** 670 km (416 miles).

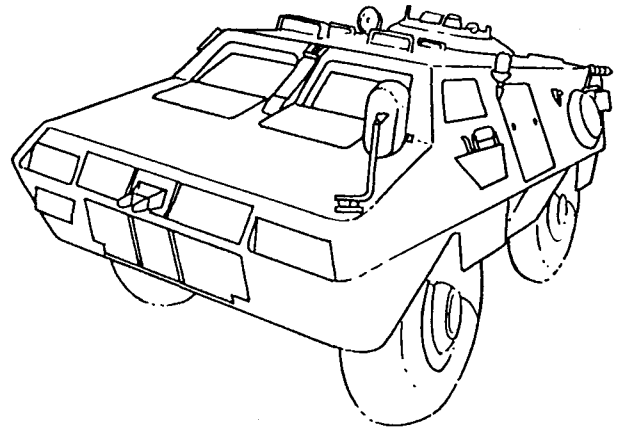

**Weapons & Damage:** One or two 7.62mm medium machine guns (2; P.V. 6): 6D6, or 20mm cannon (frag. 2D6x10 or 6D6x10 HE), or riot control equipment. **Structural Damage Capacity (S.D.C.):** 525.

## ISRAEL

### Merkava Main Battle Tank

The most unique aspect of this tank is the layout of its interior workings. The entire front of the tank houses the **engine**, transmission, cooling system and fuel tanks. The driver is seated in front of the turret while the commander, gunner and loader are seated just behind him. The rear of the hull has a cargo compartment which can be used to carry additional ammunition or four stretcher patients or 10 fully equipped infantrymen! There is a special hatch in the rear to allow rapid exit for the crew or infantrymen. The armaments for this tank include: A 105mm gun which can fire a wide range of rounds and a heavy machine gun.

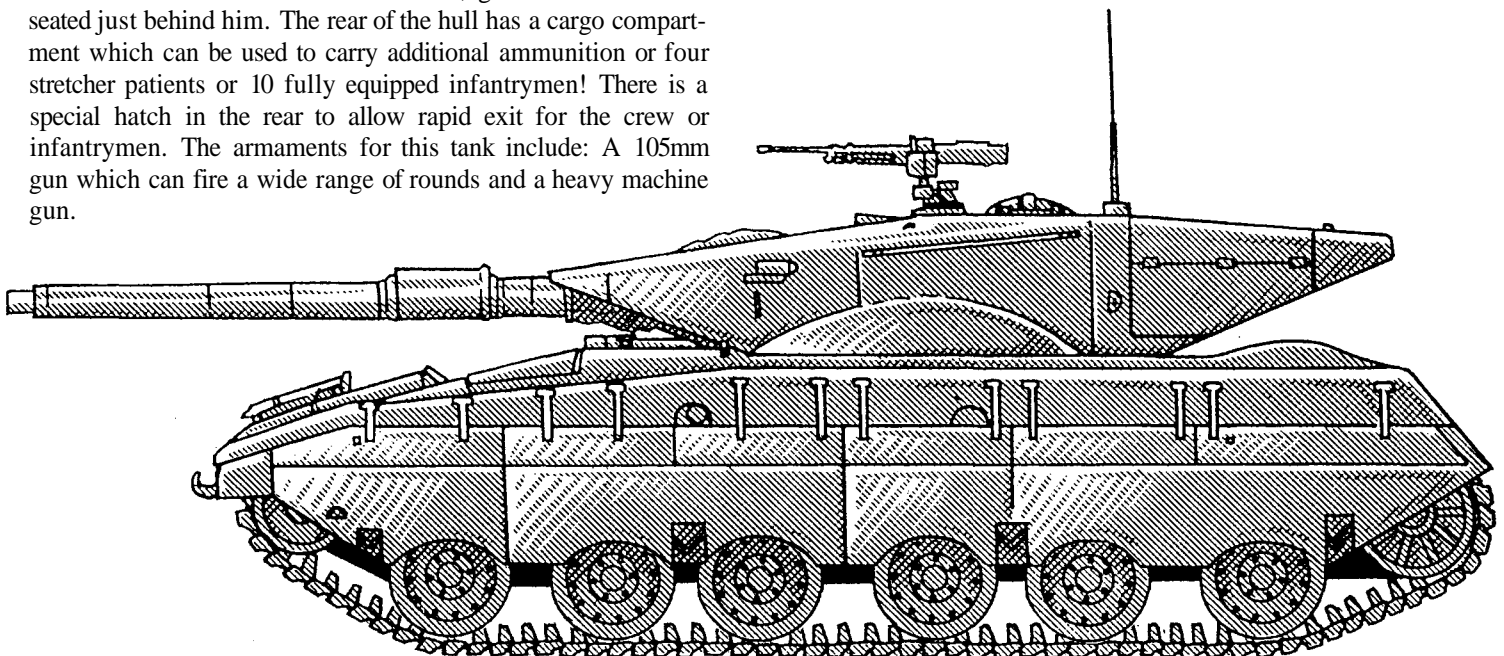



**Country:** Israel, **Crew:** 4, **Weight:** 56 tons, **Length:** (with gun forward) 8.36 m (27 ft, 5 inches), **Width:** 3.72 m (12 ft, 2 inches), **Height:** 2.64 m (8 ft, 8 inches), **Maximum Speed:** 46 km/h (28.6 mph), **Maximum Range:** 500 km (311 miles). **Weapons & Damage:** 105mm gun: Frag. 1D4 x 100, HE 1D6 X 100 or HEAT 2D4 x 100, and one 12.7mm heavy machine gun: 1D6 X 10 + 6 (P.V. 7), Note: The 105mm cannon can also fire practice, frag., AP, CS, stun, smoke, and illuminating rounds. **Structural Damage Capacity (S.D.C.):** 1200.

## SOUTH AFRICA

### Ratel 20 Infantry Fighting Vehicle

This vehicle carries a total of 11 men in the form of a commander and gunner in the turret, the driver at the front, the anti-aircraft/machine-gunner at the rear and seven fully equipped infantrymen. The turret is armed with a 20mm dual-feed cannon as well as a 7.62mm machine gun. Another 7.62mm machine gun is located on the turret roof for anti-aircraft defence.

**Country:** South Africa, **Crew:** 11, **Combat Weight:** 20.94 tons (19,000 kg/41,888 lbs), **Length:** 7.212 m (23 ft, 8 inches), **Width:** 2.516 m (8 ft, 3 inches), **Height:** 2.915 m (9 ft, 6 inches), **Maximum Speed:** 105 km/h (65 mph), **Maximum Range:** 1000 km (621 miles). **Weapons & Damage:** 20mm gun: Frag. 2D6 X 10, HE 6D6 x 10 or HEAT 1D4 X 100, one forward facing 7.62mm machine gun: 6D6 (P.V. 6), and one 7.62mm top mounted (anti-aircraft) machine gun: 6D6 (P.V. 6), **Structural Damage Capacity (S.D.C.):** 800.

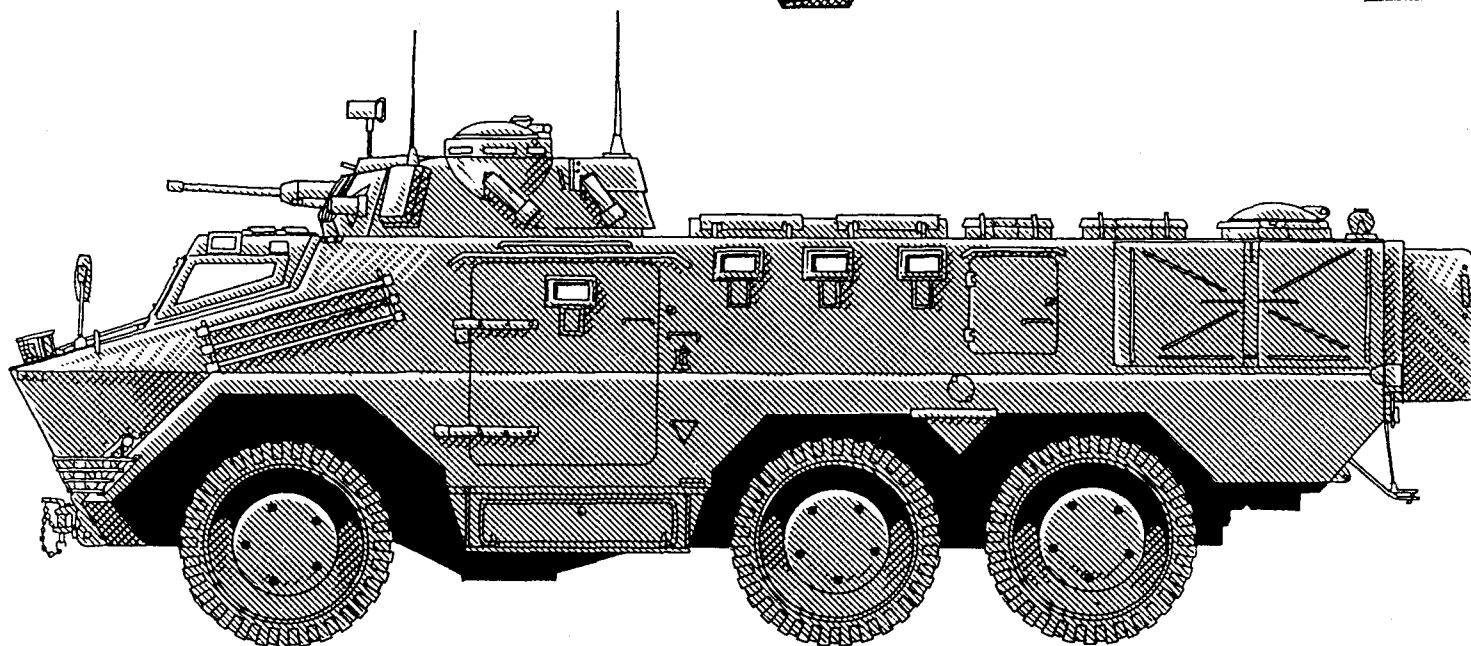
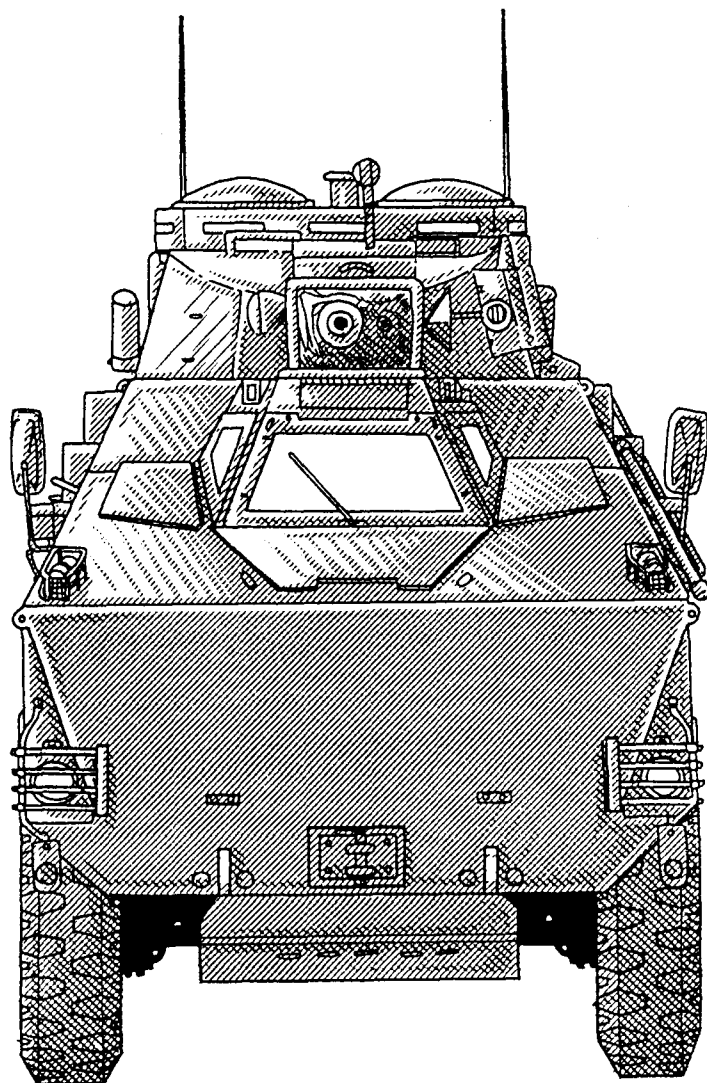

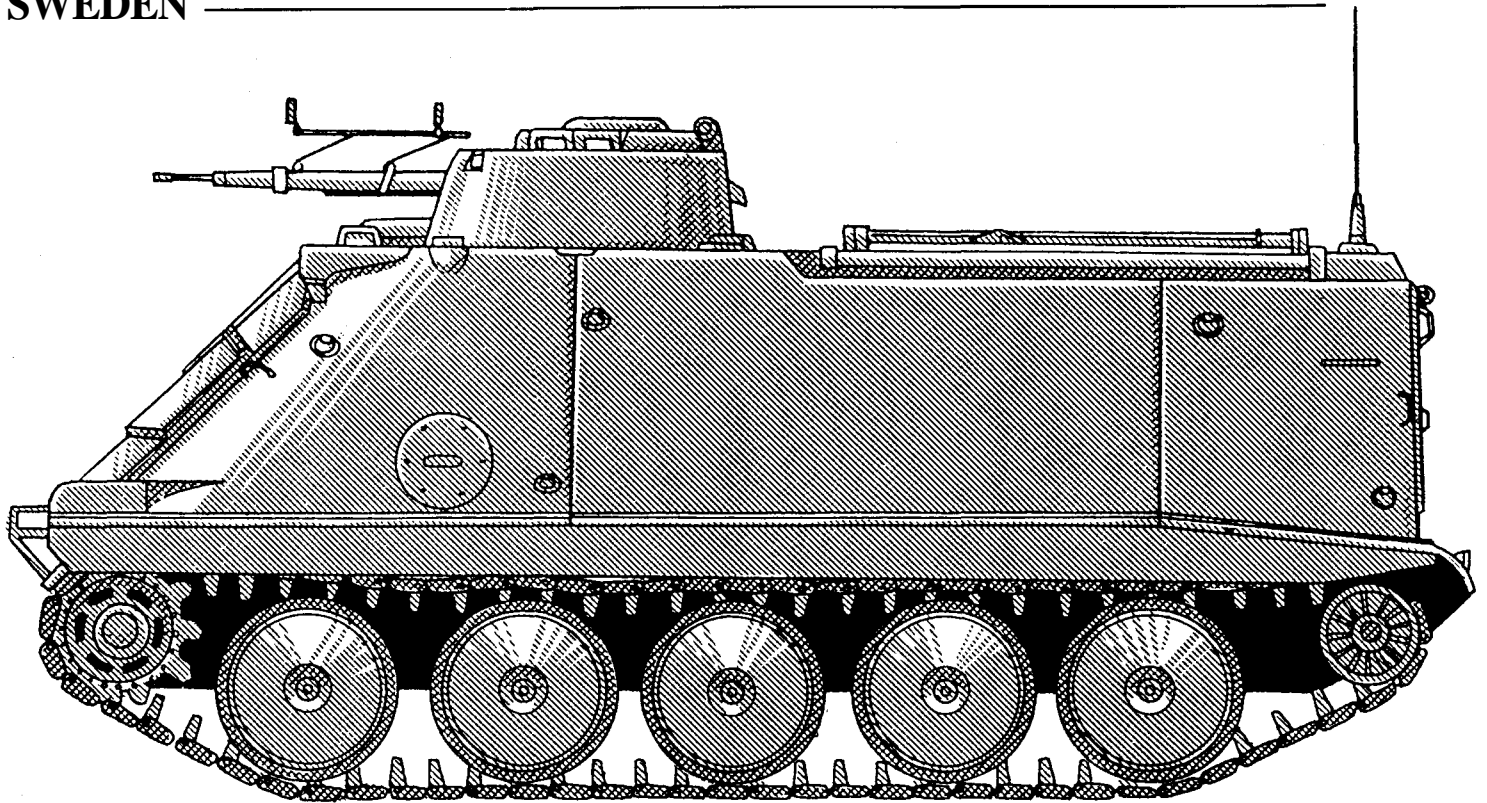

**Pbv Armored Personnel Carrier**

This vehicle is designed to carry 10 fully equipped infantrymen as well as two crewmen. The main armaments of this vehicle include a 20mm Hispano cannon mounted in a turret. The cannon can fire either high explosive rounds, in belts of 135 rounds, or armor-piercing rounds, in 10 round magazines.

**Country:** Sweden, **Crew:** 2 + 10, **Weight:** 14.88 tons (13,500 kg/29,762 lbs), **Length:** 5.35 m (17 ft, 7 inches), **Width:** 2.86 m (9 ft, 5 inches), **Height:** 2.50 m (8 ft, 2 inches), **Maximum Speed:** 66 km/h (41 mph), **Maximum Range:** 300 km (186 miles). **Weapons & Damage:** AP: 6D6 × 10, HE: 1D4 × 100, or smoke. **Structural Damage Capacity (S.D.C.):** 575.

UNITED KINGDOM

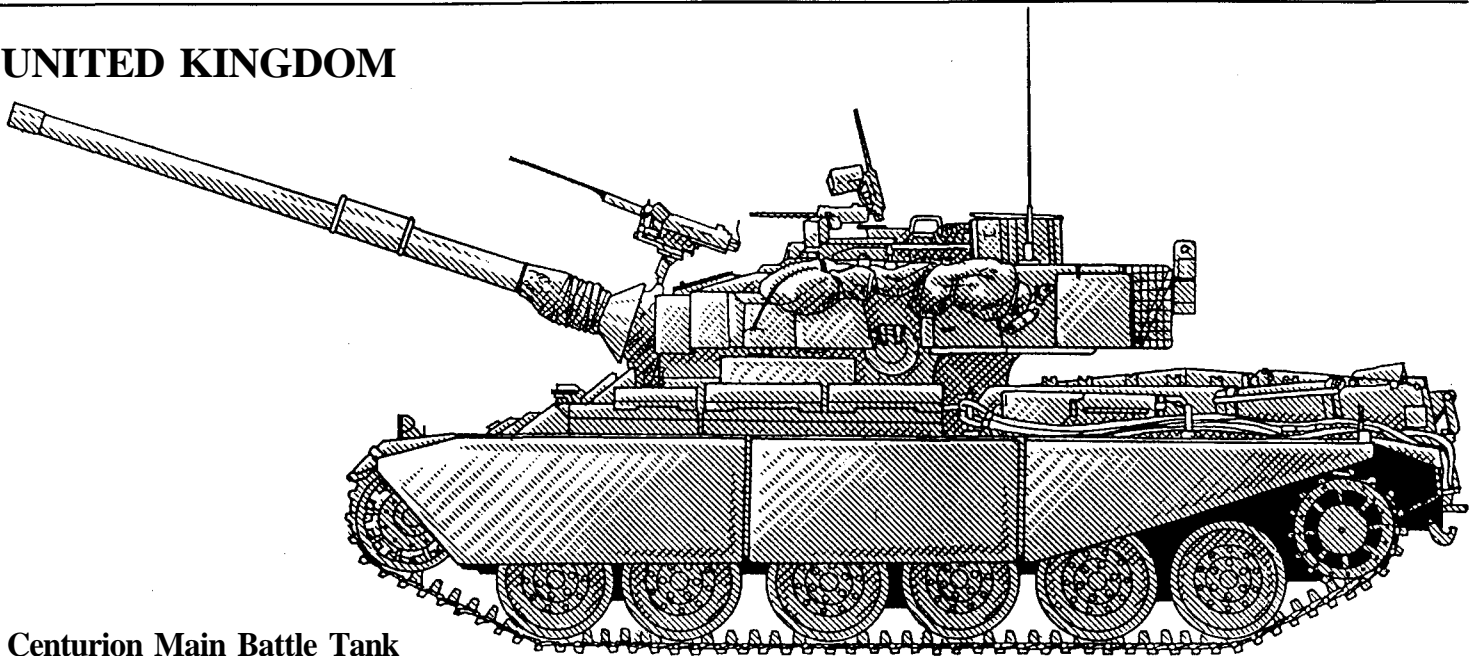

**Centurion Main Battle Tank**

Because of its adaptability, the Centurion Tank has long been considered one of the most successful tank designs in modern armored warfare. Its armaments consist of a 105mm L7 gun, two 7.62mm machine guns and a 12.7mm heavy machine gun which provides the maximum firepower at close range. It has

also been fitted with a stabilization system which keeps the gun on target when the tank is moving across country.

**Country:** United Kingdom, **Crew:** 4, **Weight:** 51.82 tons, **Length:** (with gun forward) 9.854 m (32 ft, 4 inches), **Width:** 3.39 m (11 ft, 1 inch), **Height:** 3.09 m (9 ft, 10 inches),

**Maximum Speed:** 34.6 km/h (21.5 mph), **Maximum Range:** 190 km (118 miles). **Weapons & Damage:** 105mm gun: HE 1D6×100 or HEAT 2D4×100, 12.7mm heavy machine gun: 1D6 x 10 + 6 (P.V. 7), 7.62mm medium machine guns (2; P.V. 6): 6D6. Note: The 105mm cannon can also fire practice, smoke, and illuminating rounds. **Structural Damage Capacity (S.D.C.):** 1200.

### Challenger Main Battle Tank

The Challenger is considered to be one of the most powerful battle tanks in production. The reason for this is it has reinforced armor and a 120mm gun which can fire HEAT warheads.

**Country:** United Kingdom, **Crew:** 4, **Weight:** 60 tons, **Length:** (with gun forward) 11.55 m (37 ft, 10 inches), **Width:** 3.51 m (11 ft, 6 inches), **Height:** 2.89 m (9 ft, 5 inches), **Maximum Speed:** 56 km/h (35 mph), **Maximum Range:** 500 km (310 miles). **Weapons & Damage:** 120mm gun: HE 1D6×100 or HEAT 3D4 X 100, 7.62mm medium machine guns (2; P.V. 6): 6D6. Note: The 120mm cannon can also fire practice, smoke, and illuminating rounds. **Structural Damage Capacity (S.D.C.):** 1200.

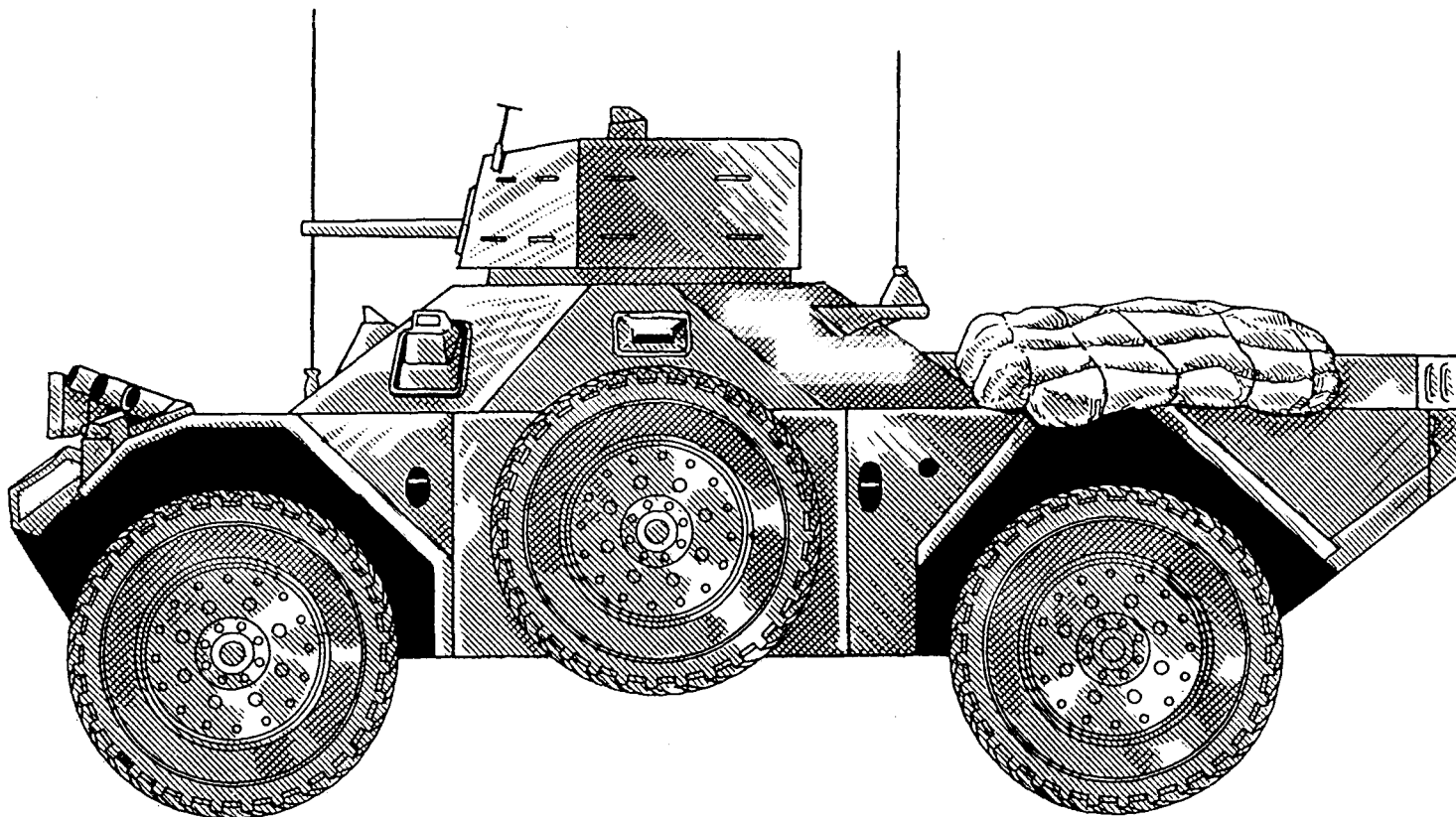
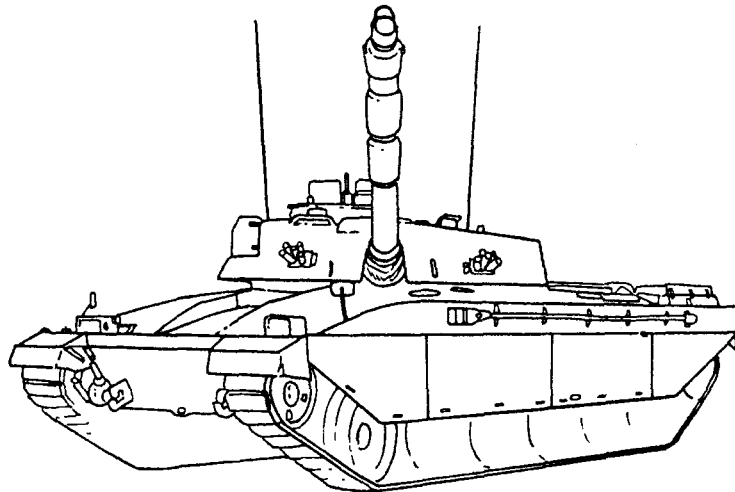

### Daimler Ferret Mk 2/3 Scout Car

The Ferret Scout Car has had many uses in its history. Not only is it effective as a scouting vehicle, it is widely used in internal security roles. It is also capable of amphibious travel with the addition of a flotation screen, being propelled in the water by its wheels. Its only armament is a 7.62mm machine gun mounted on the turret.

**Country:** United Kingdom, **Crew:** 2, **Weight:** 4.395 tons, **Length:** 3.835 m (12 ft, 7 inches), **Width:** 1.905 m (6 ft, 3 inches), **Height:** 1.879 m (6 ft, 2 inches), **Maximum Speed:** 93 km/h (59 mph), **Maximum Range:** 306 km (190 miles). **Weapons & Damage:** Only one 7.62mm medium machine gun (P.V. 6): 6D6. **Structural Damage Capacity (S.D.C.):** 425.

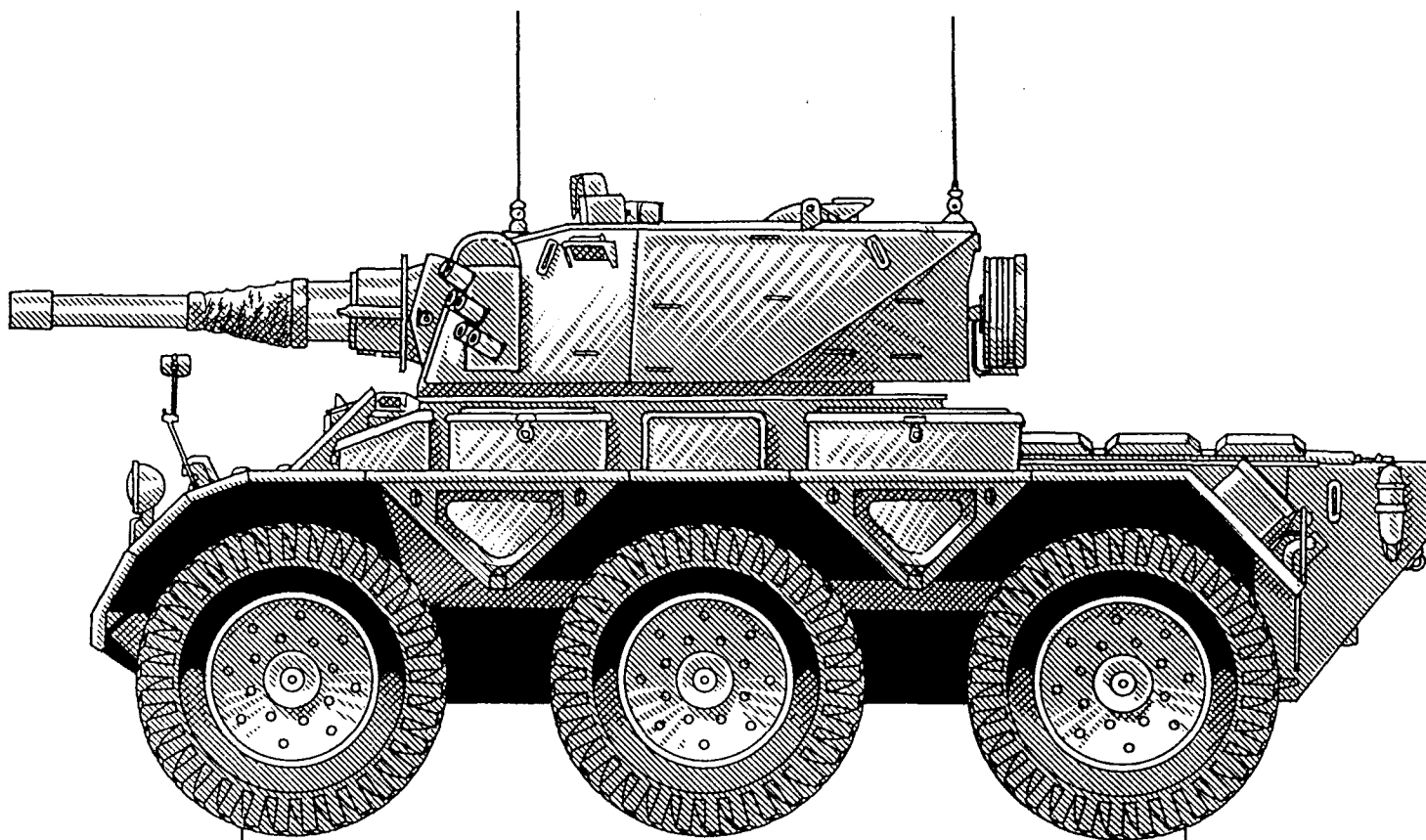

### **Alvis Saladin Armored Car**

The Saladin is the wheeled version of the Alvis Scorpion. All six wheels of the Saladin are powered, with steering on the four front wheels. The vehicle can be driven even if one of the wheels is blown off. The Saladin has the same armaments as the Scorpion, which include a 76mm gun for which a total of 42 rounds may be carried on board. It also has a 7.62mm machine gun mounted co-axial with the main armament, and a similar weapon is mounted on the turret roof for anti-aircraft defence. A total of 2,750 rounds of 7.62mm ammunition is carried.

**Country:** United Kingdom, **Crew:** 3, **Weight:** 11.59 tons, **Length:** 5.28m (17ft, 4 inches) (including gun), **Width:** 2.54 m (8 ft, 4 inches), **Height:** 2.93 m (9 ft, 7 inches), **Maximum Speed:** 72 km/h (45 mph), **Maximum Range:** 400 km (250 miles), **Weapons & Damage:** 76mm gun: Frag. 4D6×10, HE 1D4X 100 or HEAT 1D6x 100, one 7.62mm medium machine gun (P.V. 6): 6D6. Note: The cannon can also fire practice, smoke, and illuminating rounds. **Structural Damage Capacity (S.D.C.):** 550.

## Alvis Scorpion Reconnaissance Vehicle

The Scorpion has been tested in both warm weather and cold weather situations and proven to be highly effective. The vehicle also comes equipped with a flotation screen, which is stowed collapsed around the top of the hull. When in the water it is propelled by its tracks and can move at about 6 km/h (3.7 mph). The armaments on the vehicle include: a 76mm gun, with a total of 40 rounds of ammunition, a 7.62mm machine gun with a total of 3,000 rounds carried for this weapon. It can also be equipped with smoke dischargers on each side of the turret to the front.

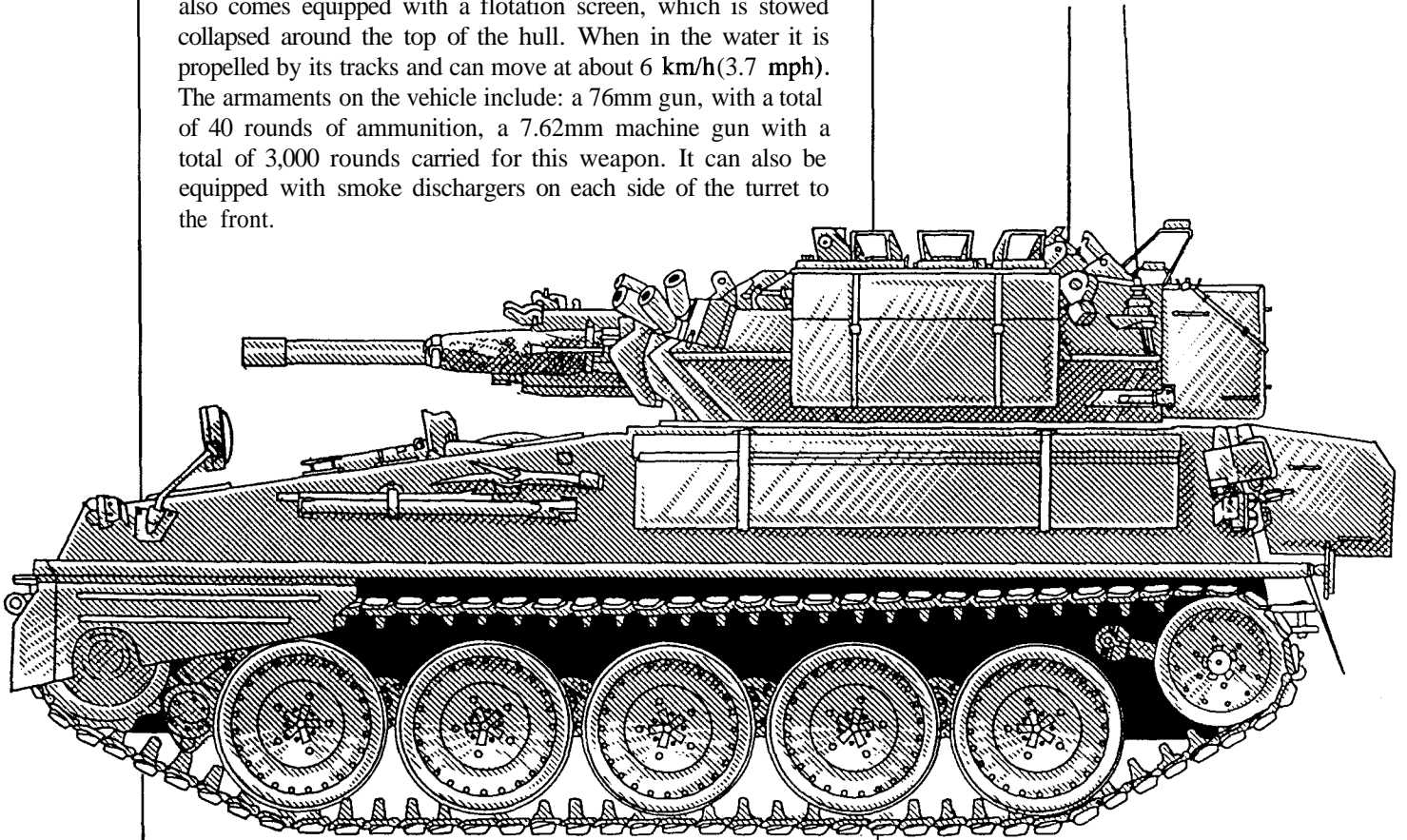

**Country:** United Kingdom, **Crew:** 3, **Weight:** 8.073 tons, **Length:** 4.794 m (15 ft, 8 inches), **Width:** 2.235 m (7 ft, 4 inches), **Height:** 2.102 m (6 ft, 10 inches), **Maximum Speed:** 80 km/h (50 mph), **Maximum Range:** 644 km (400 miles). **Weapons & Damage:** 76mm gun: Frag. 4D6 x 10, HE 1D4 X 100 or HEAT 1D6 x 100, one 7.62mm medium machine gun (P.V. 6): 6D6. Note: The cannon can also fire practice, smoke, and illuminating rounds. **Structural Damage Capacity (S.D.C.):** 500.

# UNITED STATES OF AMERICA

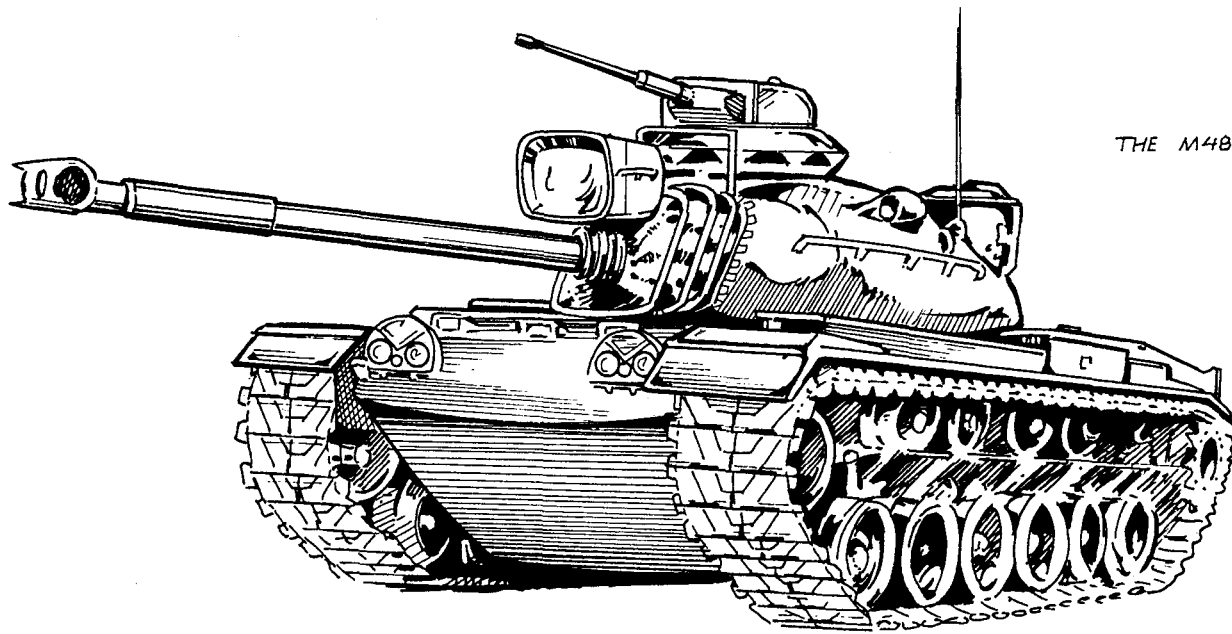

THE M48A3 PATTON

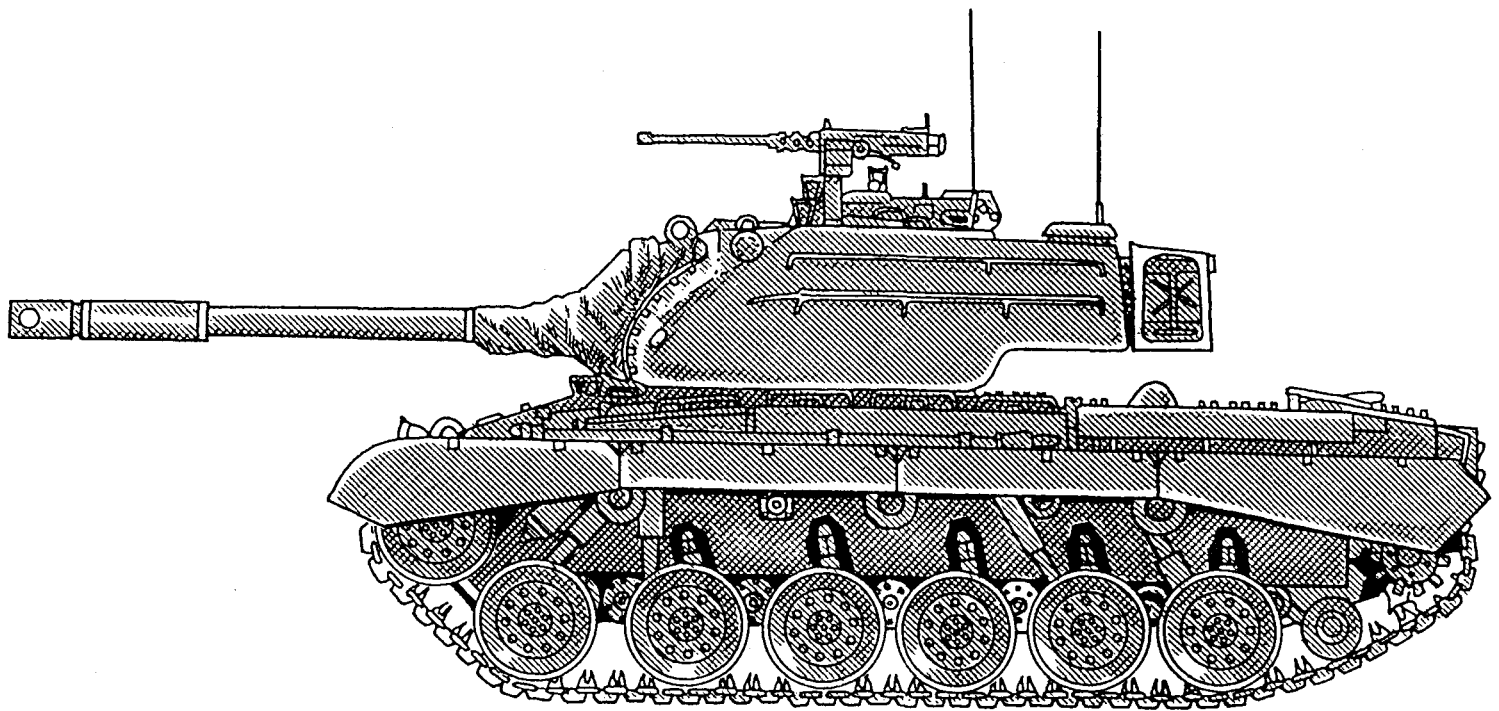

## M48A3 Main Battle Tank

This is a medium sized battle tank which was developed out of the need for smaller tanks during the conflict in Korea, in 1950. After much trial and error, the M48 series of tanks was finally developed into an efficient fighting vehicle. Its armaments include: a 90mm gun, with a 7.62mm machine gun mounted co-axially with the main armament and a 12.7mm machine gun mounted on the commander's cupola.

**Country:** USA, **Crew:** 4, **Weight:** 47.17 tons, **Length:** (with

gun forward) 8.686 m (28 ft, 6 inches), **Width:** 3.631 m (11 ft, 11 inches), **Height:** 3.124 m (10 ft, 3 inches), **Maximum Speed:** 48.2 km/h (30 mph), **Maximum Range:** 463 m (288 miles). **Weapons & Damage:** 90mm gun: Frag. 6D6 x 10, HE 1D4 x 100 or HEAT 1D6 x 100, one 12.7mm heavy machine gun (P.V. 6): 6D6, Note: The 90mm cannon can also fire practice, smoke, and illuminating rounds. **Structural Damage Capacity (S.D.C.):** 1200.

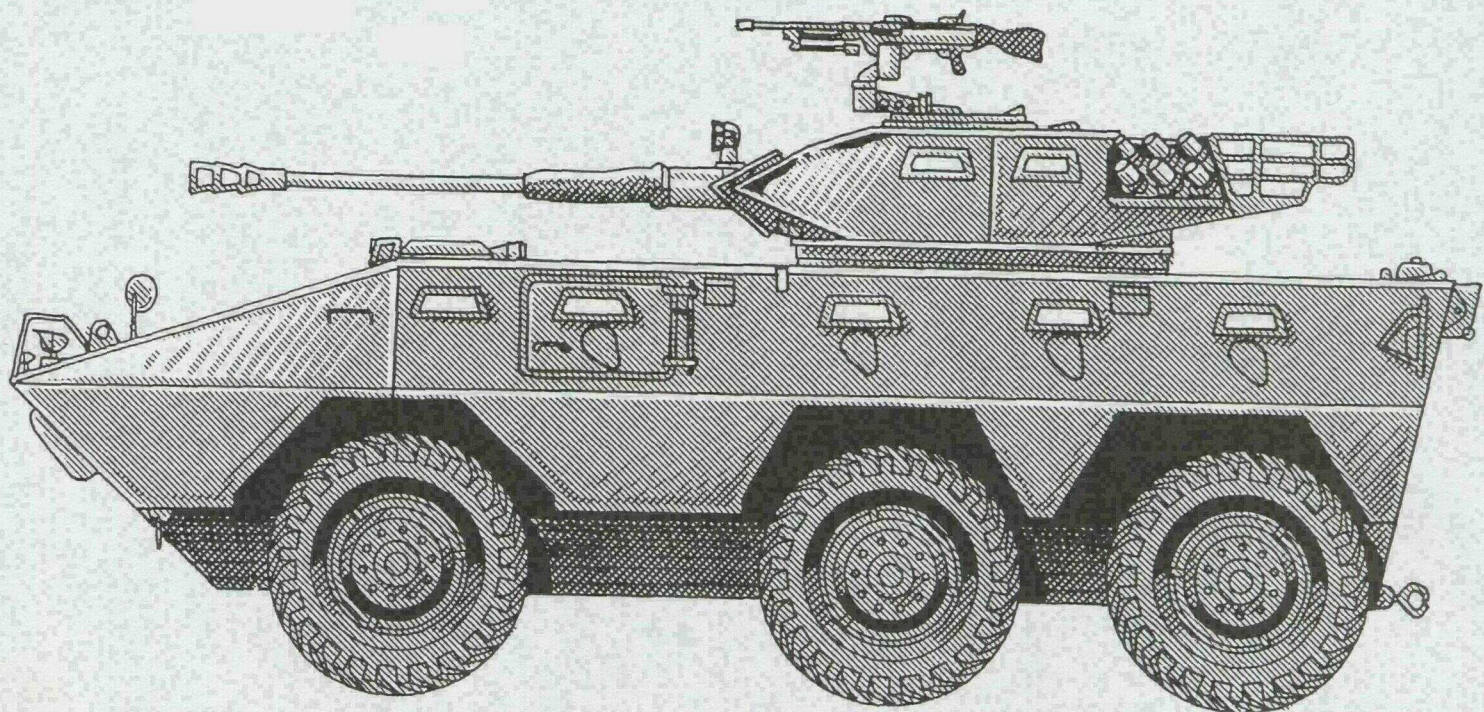

### Cadillac Gage V-300 Commando Armored Personnel Carrier

This vehicle is capable of carrying nine infantryman as well as three crewmen. The troops enter and exit through two doors in the rear of the vehicle. In addition to these, there are hatches in the roof and firing ports with a vision block in the sides and rear. The turret is armed with a 90mm MkIII gun. There is also a 7.62mm machine gun mounted co-axial with the main armament.

**Country:** USA, **Crew:** 3 + 9 (commander, gunner, driver and 9 infantry), **Combat Weight:** 14.5 tons (13,137 kg/28,962 lbs), **Length:** 6.40 m (21 ft), **Width:** 2.54 m (8 ft, 4 inches), **Height:** 1.981 m (6 ft, 6 inches), **Maximum Speed:** 93 km/h (58 mph), **Maximum Range:** 700 km (435 miles). **Weapons & Damage:** 90mm gun: Frag, 6D6 X 10, HE 1D4 x 100 or HEAT 1D6 X 100, and one 7.62mm medium machine gun (P.V. 6): 6D6. **Note:** The 90mm cannon can also fire practice, smoke, and illuminating rounds. **Structural Damage Capacity (S.D.C.):** 650.

### Cadillac Gage Commando Ranger Armored Personnel Carrier

This vehicle is also referred to as the Peacekeeper because its main use is to carry out patrols on air bases and escorting convoys carrying ordnance to and from bases. It can accommodate six passengers as well as two crew members. The inside of the Ranger is insulated and air-conditioned to lessen crew fatigue. There is a mount for a 7.62mm machine gun or rocket launcher near the top hatch.

**Country:** USA, **Crew:** 2 + 6, **Combat Weight:** 5 tons (4536 kg/10,000 lbs), **Length:** 4.699 m (15 ft, 5 inches), **Width:** 2.019 m (6 ft, 7 inches), **Height:** 1.981 m (6 ft, 6 inches), **Maximum Speed:** 112.5 km/h (70 mph), **Maximum Range:** 556 km (345 miles). **Structural Damage Capacity (S.D.C.):** 490.

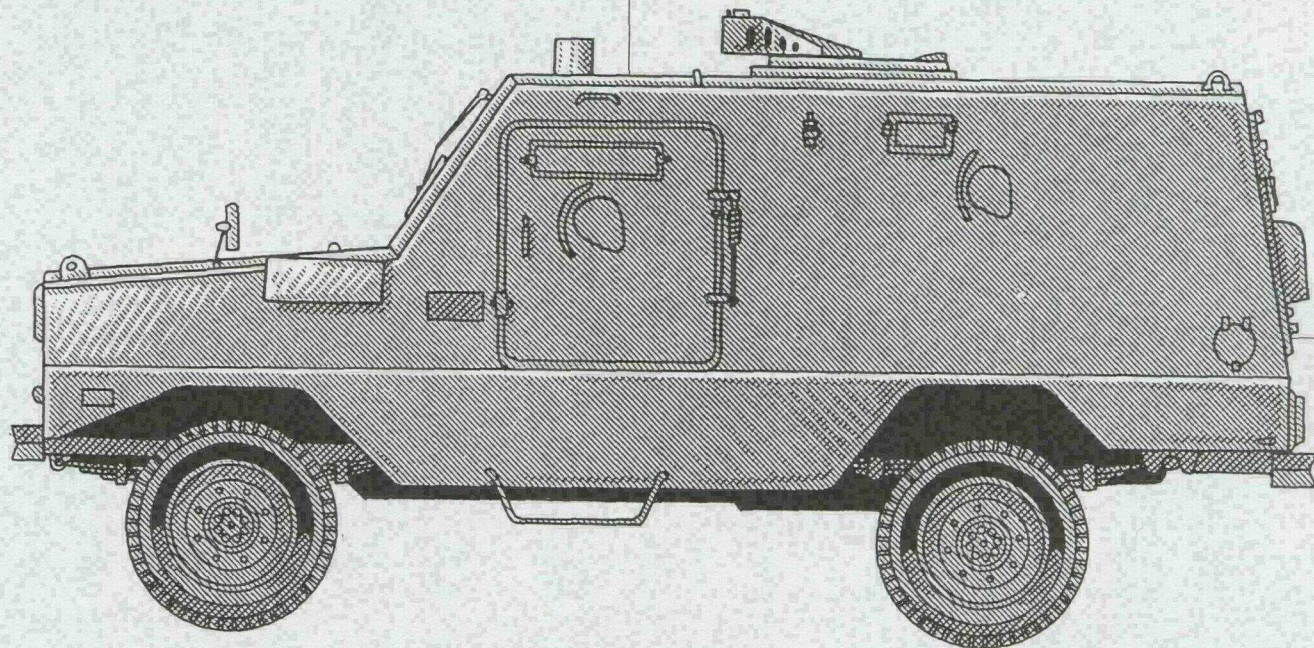

## M2 Bradley Infantry Fighting Vehicle

This vehicle is equipped to carry seven infantrymen and three crewmen. The troop compartment has six firing ports and periscopes to allow the men to fire from within the vehicle. It is equipped with a 25mm dual-feed Chain Gun; there is also a 7.62mm co-axial machine gun and a twin launcher on the left side of the turret for launching TOW missiles. This vehicle has a stabilization system to enable the gunner to fire the 25mm cannon while moving cross country.

**Country:** USA, **Crew:** 3 + 7, **Weight:** 25 tons, **Length:** 6.453 m (21 ft, 2 inches), **Width:** 3.20 m (10 ft, 6 inches), **Height:** 2.972 m (9 ft, 9 in), **Maximum Speed:** 66 km/h (41 mph), **Maximum Range:** 483 km (300 miles). **Weapons & Damage:** 25mm gun: Frag. 2D6 X 10, HE 6D6 x 10 or HEAT 1D6 x 100, one 7.62mm machine gun: 6D6 (P.V. 6), TOW Missiles (2): TOW 2 (HEAT): 3D4 x 100, **Structural Damage Capacity (S.D.C.):** 950.

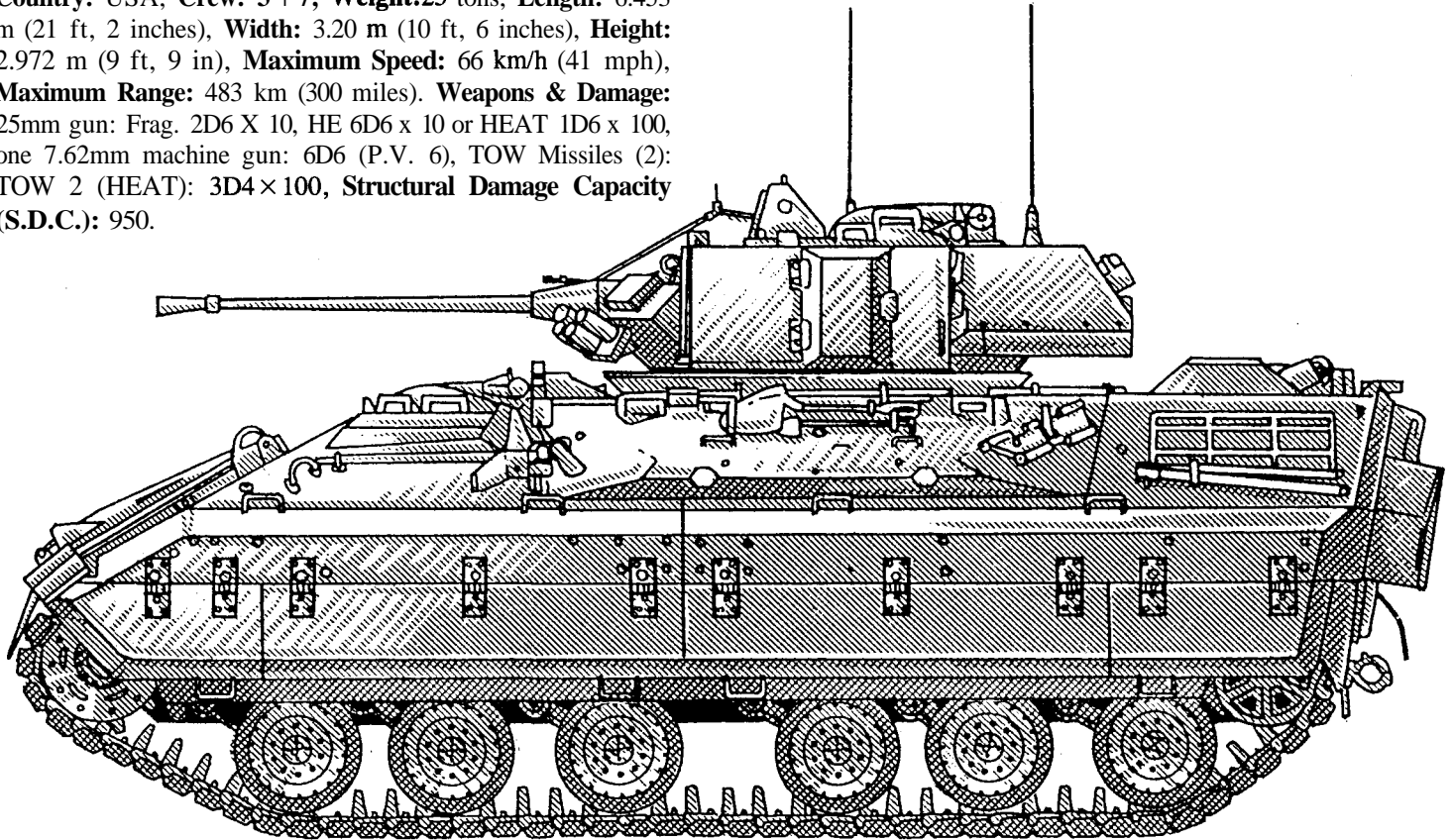

## The Old U.S.S.R.

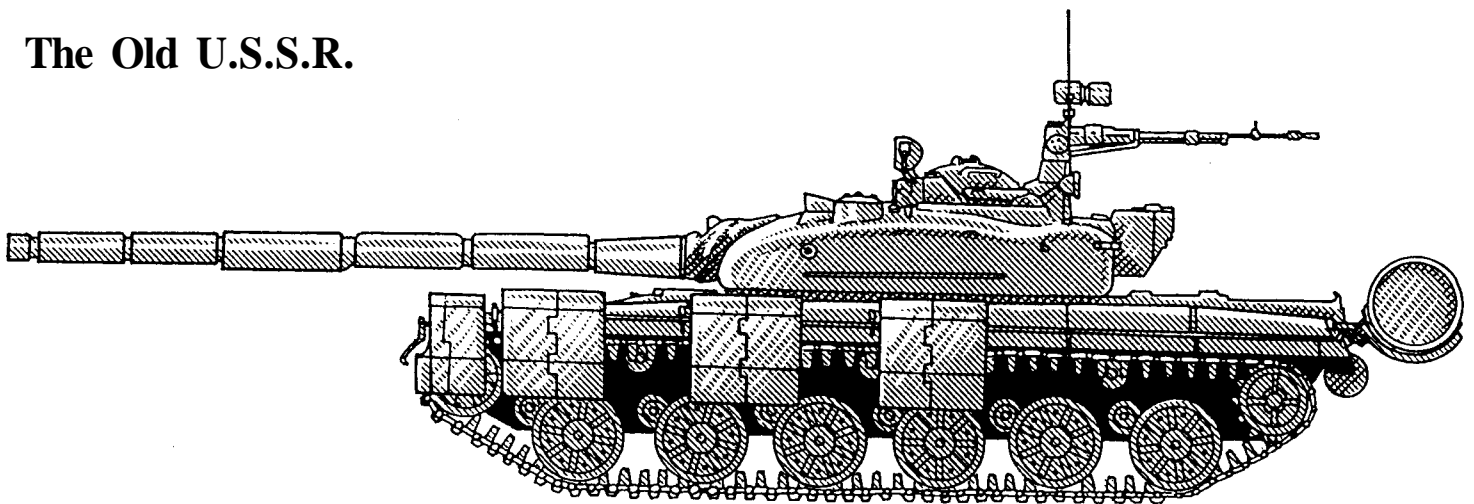

## T-72 Main Battle Tank

The T-72 is one of the few tanks in production which is known to be highly effective in protecting the crew from nuclear contamination (it has a skin layer of lead-based foam). The armaments on this tank include a 125mm fully stabilized gun and a 7.62mm PKT machine gun which is mounted co-axially with

the main armament. A total of 40 rounds of 125mm ammunition is carried, a typical load consists of 12 APFSDS, 22 HE, and 6 HEAT.

**Country:** USSR, **Crew:** 3, **Weight:** 41 tons, **Length:** (with gun forward) 9.24 m (30 ft, 3 inches), **Width:** 3.6 m (11 ft, 9



inches), **Height:** 2.37 m (7 ft, 9 inches), **Maximum Speed:** 60 km/h (37.25 mph), **Maximum Range:** 480 km (298 miles). **Weapons & Damage:** 125mm gun: Frag. 1D4×100, HE 1D6 X 100 or HEAT 3D4 X 100, and one 7.62mm PKT machine

gun: 1D4×10+10 (P.V. 7), **Note:** The cannon can also fire practice, AP, CS, stun, smoke, and illuminating rounds. **Structural Damage Capacity (S.D.C.):** 1100.

### BRDM-2 Amphibious Scout Car

The turret of this vehicle has no roof hatch. The only means of entry into this vehicle are two single-piece hatch covers that open vertically in the front of the vehicle. The turret is equipped with a 14.5mm KPV heavy machine gun and a co-axial 7.62mm PKT machine gun. A total of 500 rounds of 14.5mm and 2,000 rounds of 7.62mm ammunition are carried.

**Country:** USSR, **Crew:** 4, **Weight:** 7 tons, **Length:** 5.75 m (18 ft, 10 inches), **Width:** 2.35 m (7 ft, 8 inches), **Height:** 2.31 m (7 ft, 7 inches), **Maximum Speed:** 100 km/h (62 mph), **Maximum Range:** 750 km (465 miles). **Weapons & Damage:** 14.5mm Heavy machine gun: 1D6x 10 (P.V. 7) and one 7.62mm PKT machine gun: 1D4 x 10 + 10 (P.V. 7), **Structural Damage Capacity (S.D.C.):** 725.

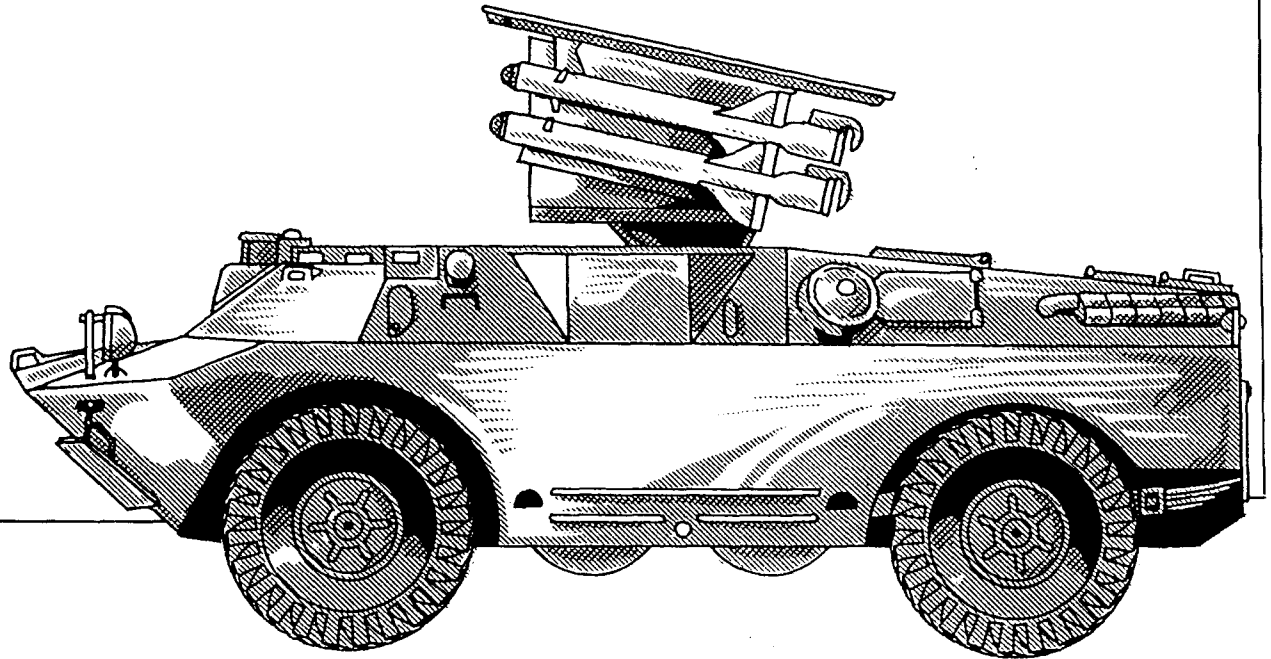

### BMD Airborne Combat Vehicle

This vehicle was designed to give airborne troops more mobility and protection once they have infiltrated behind enemy lines. There are two single 7.62mm machine guns mounted internally at the front of the hull. There is also a 73mm gun, a 7.62mm co-axial machine gun and a rocket launcher rail for the AT-3 'Sagger' mounted above the main gun. **Country:** USSR, **Crew:** 7, **Weight:** 7.38 tons (6700 kg/14,771

lbs), **Length:** 5.40 m (17 ft, 9 inches), **Width:** 2.63 m (8 ft, 8 inches), **Height:** 1.62 m (5 ft, 4 inches), **Maximum Speed:** 70 km/h (43 mph), **Maximum Range:** 320 km (200 miles). **Weapons & Damage:** 73mm gun: HE 6D6 X 10 or HEAT 1D6×100, three 7.62mm PKT machine guns: 1D4×10+10 (P.V. 7), and a Sagger Missile: HE 1D6×100 or HEAT 2D4×100, **Structural Damage Capacity (S.D.C.):** 600.

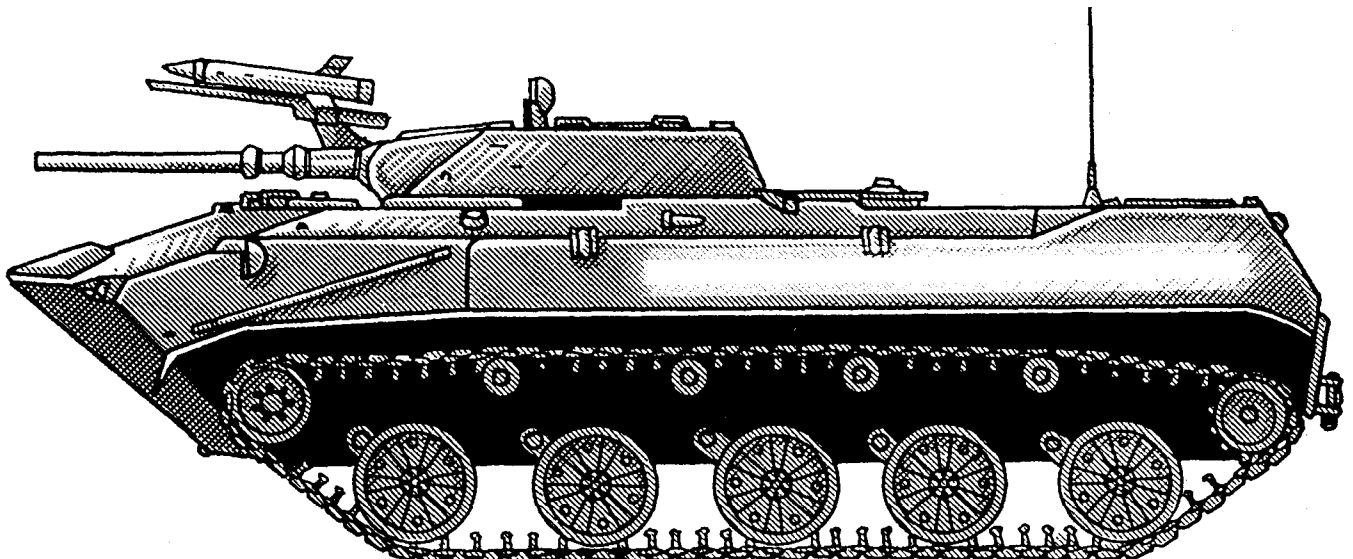

---

## Bibliography

The books listed in this bibliography are just the most notable of the titles used in our research. The researchers/authors also referred to numerous magazines, catalogs and other books for cross references and confirming data.

### Key Books

**Jane's Armor and Artillery 1988-1989**, Christopher F. Foss, editor.

**Jane's Infantry Weapons 1988-1989**, Ian V. Hogg, editor.

**Jane's Infantry Weapons 1991-1992**, Ian V. Hogg, editor.

**Jane's Security and Co-In Equipment 1991-1992**, Ian V. Hogg, editor.

**International Defence Equipment Catalogue 1988-1989 (3 volumes)**

**Winchester Ammunition**; Winchester, East Alton, Illinois; 1991.

Adam, Robert; **The World's Most Powerful Rifles & Handguns**; ChartwellBooks, Secaucus, New Jersey; 1991.

Ezell, Edwards; **Small Arms Today, 2nd Edition**; Stackpole Books, Harrisburg, Pennsylvania; 1988.

Ezell, Edwards; **Small Arms of the World, 12th Edition**; Marboro Books Corporation; 1983.

Hogg, Ian V.; **Military Pistols and Revolvers**

Hogg, Ian V.; **The World's Firearms**; A & W Publishers, Inc. N.Y., New York; 1978.

Siembieda, Maryann; **Contemporary Weapons**; Palladium Books, Detroit, Michigan; 1984

Warner, Ken; **Gun Digest 1993**; DBI Books, Inc., Northbrook, Illinois; 1993

Walmer, Max; **Weapons of the Special Forces**, Prentice Hall, New York; 1989.

### Other References of Note

Hogg, Ian V.; **Military Small Arms of the 20th Century**; DBI Books, Inc., Northbrook, Illinois; 1985

Markham, George; **Guns of the Elite**; Arms & Armour Press, London; 1987

Myatt, Frederick; **An Illustrated Guide to Rifles & Automatic Weapons**, 1982

Rosser-Owen, David; **Vietnam Weapons Handbook**; Thorsons Publishing Group, 1986

Stevenson, Jan; **Modern Sporting Guns**; Crown Publishing, N.Y., New York; 1988

Walker, Louis; "Defense Ammo Performance"; **Guns & Ammo Annual 1992**

# INDEX

<b>Body Armor Classes</b> . . . . .	<b>21</b>	<b>Stingball Grenade</b> . . . . .	<b>34</b>
Class <b>I/IA</b> Body Armor (P.V. 1-4) . . . . .	21	<b>Comboball M452C</b> . . . . .	34
Class <b>II/IIA</b> Body Armor (P.V. 1-5) . . . . .	22	<b>M429 Grenade Launching System</b> (for revolvers & shotguns) . . . . .	34
Class <b>III</b> A (P.V. 1-6) . . . . .	22	<b>EOD Equipment</b> . . . . .	<b>35</b>
Class <b>IV</b> A (P.V. 1-6 & Many Special Rounds) . . . . .	22	<b>Manurhin Disrupter Gun</b> . . . . .	35
Class <b>IVB/C</b> (P.V. 1-6, handguns, rifles & All Special Rounds) . . . . .	22	<b>Hobo L3A1 EOD Robot</b> . . . . .	35
Class <b>V</b> (P.V. 6, handguns, rifles & All Special Rounds) . . . . .	23	<b>Bomb Suppression Blankets</b> . . . . .	35
Weight of Body Armor . . . . .	23	<b>SC-2 Safety Circle</b> . . . . .	35
<b>Liukko Survival &amp; Rescue Suits (Finland)</b> . . . . .	23	<b>Imp Miniature EOD Robot</b> . . . . .	36
German Body Armor . . . . .	24	<b>Liquid Nitrogen Neutralizer</b> . . . . .	36
Fragmentation Vest <b>MIL-110</b> . . . . .	24	<b>Model 1152 Disruptor</b> . . . . .	36
Bombsuit <b>MIL-300</b> . . . . .	24	<b>Letter-bomb Suppression Pouch</b> . . . . .	36
Other German Vests of Note . . . . .	24	<b>AUTOMATIC PISTOLS</b> . . . . .	<b>37</b>
<b>Slip-On Vest S 811</b> . . . . .	24	<b>ARGENTINA</b> . . . . .	<b>38</b>
<b>Slip-On Vest Type T-200</b> . . . . .	24	.45 Ballister Molina Pistol . . . . .	38
Vest Type <b>S 321</b> . . . . .	24	<b>AUSTRIA</b> . . . . .	<b>39</b>
Vest Type <b>S 911</b> . . . . .	24	9mm GB Steyr . . . . .	39
German Ballistic Protective Shield . . . . .	24	<b>Glock 17</b> . . . . .	39
Eagle armored body-suit (Israel & NATO) . . . . .	25	<b>BELGIUM</b> . . . . .	<b>39</b>
<b>SEMA Personal Armour (France)</b> . . . . .	25	Browning GP 35 . . . . .	39
<b>UK Series 25 Modular Armour</b> . . . . .	26	Browning Nomad . . . . .	39
<b>Model FW25</b> . . . . .	26	7.65mm 140 Double-Action <b>FN</b> . . . . .	39
Restricted Entry Vest <b>REV/25</b> . . . . .	26	9mm FN Browning High Power . . . . .	40
General Purpose Vest <b>GPV/25</b> . . . . .	26	9mm <b>Fabrique Nationale</b> Standard Double-Action Model . . . . .	40
<b>Armorshield Ultra-Light Flak Jacket 777/FL17</b> . . . . .	26	9mm <b>Fabrique Nationale</b> Medium Double-Action Model . . . . .	40
<b>ML Lifeguard Body Armor (UK)</b> . . . . .	26	9mm <b>Fabrique Nationale</b> Compact Double-Action Model . . . . .	40
<b>Ambassador Protective Vest</b> . . . . .	26	<b>Barracuda FN Revolver</b> . . . . .	40
<b>Anti-knife jacket</b> . . . . .	27	5.7mm FN P90 Personal Weapon (Auto-pistol) . . . . .	40
<b>Helicopter jacket</b> . . . . .	27	<b>CANADA</b> . . . . .	<b>41</b>
<b>SWAT Model Jacket</b> . . . . .	27	Brigadier . . . . .	41
<b>Soft body armor TFV-U/0-9NATO</b> . . . . .	27	<b>CHINA, PEOPLE'S REPUBLIC</b> . . . . .	<b>41</b>
<b>Flak Jacket</b> . . . . .	28	7.62mm Type 51 or Type 54 . . . . .	41
<b>Immediate Response Jacket</b> . . . . .	28	7.65mm Type 64 or Type 67 Silenced . . . . .	41
<b>Rigid body amour TFV-R-G20 (Italy)</b> . . . . .	29	.22LR Firing Combat Knife . . . . .	41
<b>RBR 3001 Military Jacket (UK)</b> . . . . .	29	<b>CZECHOSLOVAKIA</b> . . . . .	<b>42</b>
<b>Highmark Bomb Disposal Suit (Ireland)</b> . . . . .	30	7.62mm Model 52 Pistol . . . . .	42
<b>Body Shield Fragmentation Vest (USA)</b> . . . . .	30	7.65mm Model 50 . . . . .	42
<b>BETA Vest (USA)</b> . . . . .	30	7.65mm Model 61 <b>Skorpion</b> . . . . .	42
<b>Ranger Tactical Vest (USA)</b> . . . . .	31	9mm Model 75 . . . . .	42
<b>Ultra Cool Ventilating Undergarment (USA)</b> . . . . .	31	<b>EGYPT</b> . . . . .	<b>42</b>
<b>RIOT CONTROL DEVICES</b> . . . . .	<b>31</b>	9mm Tokagyp . . . . .	42
Riot Control Shields . . . . .	31	<b>FINLAND</b> . . . . .	<b>43</b>
Riot & Combat Helmets . . . . .	31	Lahti Model 35 and Model 40 . . . . .	43
Browning SA Pneumatic Grenade Launcher . . . . .	32	<b>FRANCE</b> . . . . .	<b>43</b>
<b>MECAR Disorienting Grenade DS-RFL-35 BTU M278</b> . . . . .	33	Model D MAB . . . . .	43
<b>MECAR Anti-Riot Baton AR-RFL-75 BTU M296</b> . . . . .	33	9mm Model 1950 MAS <b>Self-Loading</b> . . . . .	43
<b>FRANCE</b> . . . . .		9mm PA15 MAB . . . . .	43
<b>Ruggieri Illuminating Rifle Grenade</b> . . . . .	33	Unique Model Bcf-66 . . . . .	43
<b>Ruggieri Type 241 Blinding Hand Grenade</b> . . . . .	33	.357 MR 73 Manurhin Revolver . . . . .	44
<b>Ruggieri Spider In-Vehicle Defence System</b> . . . . .	33	MR 32 Match Manurhin . . . . .	44
<b>UNITED KINGDOM</b> . . . . .			
<b>Arwen Ace Low Lethality Weapon</b> . . . . .	33		
<b>UNITED STATES OF AMERICA</b> . . . . .			
<b>Federal L6 37mm Multi-launcher</b> . . . . .	34		
<b>Stun-Gun System</b> . . . . .	34		

<b>GERMANY</b> . . . . .	<b>44</b>	9mm Model 28DA Double-Action Star . . . . .	53
Pistole M . . . . .	44	9mm Model A80 <b>Double-Action Astra</b> . . . . .	54
Ariminius (Weirauch) HW3 . . . . .	44	.38 Special Model 960 Astra Revolver . . . . .	54
Erma Olympia . . . . .	44	<b>SWEDEN</b> . . . . .	<b>54</b>
Erma KGP 68 . . . . .	45	9mm Model 40 <b>Husquarna</b> . . . . .	54
Mauser 1934 . . . . .	45	<b>SWITZERLAND</b> . . . . .	<b>54</b>
7.65mm (or 9mm) <b>HSI</b> Mauser . . . . .	45	Hammerli Model 208 . . . . .	54
.38 Special Mauser Revolver . . . . .	45	P210-5 & 9mm Model 49 <b>SIG</b> . . . . .	54
<b>Parabellum</b> Mauser . . . . .	45	P220 (Model 75) Sig Sauer . . . . .	55
Sauer Behorden Model . . . . .	46	P230 Sig Sauer . . . . .	55
Sauer Model 38H . . . . .	46	P225 (P9) Sig Sauer . . . . .	55
Volkspistole . . . . .	46	<b>TURKEY</b> . . . . .	<b>55</b>
7.65mm PP Walther . . . . .	46	9mm <b>MKE</b> & 7.65mm <b>MKE</b> . . . . .	55
7.65mm PPK Walther . . . . .	46	The <b>Old U.S.S.R.</b> . . . . .	55
9mm Model <b>P1</b> Walther . . . . .	46	7.62MM <b>TT-33 Tokarev</b> . . . . .	55
9mm Model <b>P5</b> Walther . . . . .	47	9mm <b>Stechkin</b> Auto (APS) . . . . .	56
9mm <b>P9S</b> Heckler & Koch . . . . .	47	9mm <b>Makarov</b> Self-Loading (PM) . . . . .	56
<b>HK4</b> Self-Loading Heckler & Koch . . . . .	47	<b>UNITED KINGDOM</b> . . . . .	<b>56</b>
9mm <b>P7 (PSP)</b> Self-Loading Heckler & Koch . . . . .	47	<b>Welrod</b> . . . . .	56
9mm <b>VP70M</b> & <b>VP70Z</b> Auto Heckler & Koch . . . . .	47	.38 No. 2 Pistol Revolver . . . . .	56
<b>HUNGARY</b> . . . . .	<b>48</b>	.38 Special, .357 Magnum Sterling Revolver . . . . .	56
Frommer M37 . . . . .	48	<b>UNITED STATES OF AMERICA</b> . . . . .	<b>57</b>
7.62mm Model 48 . . . . .	48	Auto Mag . . . . .	57
9mm or 7.65mm <b>PA63</b> . . . . .	48	9mm Calico M-950 Pistol . . . . .	57
<b>INDONESIA</b> . . . . .	<b>48</b>	Colt .45 Pistol . . . . .	57
9mm Pindad Pistol . . . . .	48	Colt .45 Model 15 General Officers Pistol . . . . .	57
<b>ITALY</b> . . . . .	<b>48</b>	Colt 2000, 9mm Pistol . . . . .	58
7.65mm Model 81 <b>Double-Action Beretta</b> . . . . .	48	Colt 10mm Delta Elite Pistol . . . . .	58
9mm Model 1934 Beretta . . . . .	49	<b>Dardick</b> . . . . .	58
9mm Model 1951 Self-Loading Beretta . . . . .	49	<b>Harrington &amp; Richardson</b> Defender Revolver . . . . .	58
9mm Model 84 Double-Action Beretta . . . . .	49	High Standard <b>Supermatic</b> . . . . .	58
9mm Model 92 Double-Action Beretta . . . . .	49	High Standard Victor . . . . .	59
9mm 93R Selective Fire Beretta . . . . .	49	Kimball . . . . .	59
9mm Model <b>951R</b> Semi & Full Auto Beretta . . . . .	50	Model GS-32N Military Ruger Revolver . . . . .	59
<b>Bernadelli</b> Model 60 . . . . .	50	Ruger Single-Six . . . . .	59
<b>P-018</b> & <b>P-018-9</b> Bernadelli . . . . .	50	.38 Service-Six Ruger Revolver . . . . .	59
Model 80 Mauser HSc Renato <b>Gamba</b> . . . . .	50	ASP 9mm Combat version of Smith & Wesson M39 . . . . .	60
.38 Trident Super 4 Renato Gamba Revolver . . . . .	50	.44 Magnum Ruger ' <b>Super Redhawk</b> ' Revolver . . . . .	60
9mm ' <b>Baby</b> ' Tanfoglio Pistol . . . . .	51	<b>YUGOSLAVIA</b> . . . . .	<b>60</b>
.38 RF83 Luigi Franchi Revolver . . . . .	51	7.62mm Model M57 . . . . .	60
<b>JAPAN</b> . . . . .	<b>51</b>	<b>RIFLES</b> . . . . .	<b>61</b>
Japanese Model 94 . . . . .	51	<b>AUSTRALIA</b> . . . . .	<b>61</b>
9mm Model 57A Auto New <b>Nambu</b> . . . . .	51	7.62mm L1A1 & L1A1-F1 . . . . .	61
7.65mm Model 57B Auto New <b>Nambu</b> . . . . .	51	7.62mm L2A1 . . . . .	61
.38 Model 60 New <b>Nambu</b> Revolver . . . . .	52	<b>AUSTRIA</b> . . . . .	62
<b>KOREA, Democratic People's Republic</b> . . . . .	<b>52</b>	7.62mm SSG 69 . . . . .	62
7.62mm Type 68 . . . . .	52	5.56mm Army Universal Gun Steyr . . . . .	62
7.65mm Type 64 . . . . .	52	<b>BELGIUM</b> . . . . .	<b>62</b>
<b>MEXICO</b> . . . . .	<b>52</b>	.30 Type D Automatic . . . . .	62
.45 Obregon . . . . .	52	7.92mm M49 <b>FN Semi-Automatic</b> . . . . .	62
<b>POLAND</b> . . . . .	<b>53</b>	7.62mm Model 30-11 Sniping <b>FN</b> Rifle . . . . .	63
9mm Model 35 Random . . . . .	53	5.56mm <b>CAL</b> Rifle . . . . .	63
9mm Wz 63 (PM63) Machine Pistol . . . . .	53	7.62mm <b>FN FAL</b> Para Rifle 5063 . . . . .	63
9mm <b>P64</b> Self-Loading . . . . .	53		
<b>SPAIN</b> . . . . .	<b>53</b>		
9mm Super Star . . . . .	53		

<b>BRAZIL</b> . . . . .	<b>63</b>	<b>SWEDEN</b> . . . . .	<b>73</b>
5.56mm Model 03 LAPA FA Assault Rifle . . . . .	63	6.5mm AG42 ( <b>Ljungman</b> ) Rifle . . . . .	73
<b>CANADA</b> . . . . .	<b>64</b>	5.56mm 890C FFV Assault Rifle . . . . .	73
7.62mm C1A1 Modified Rifle . . . . .	64	<b>SWITZERLAND</b> . . . . .	<b>74</b>
7.62mm C2 & C2A1 Automatic Rifle . . . . .	64	7.62mm SG 510-4 <b>SIG</b> . . . . .	74
<b>CHINA</b> . . . . .	<b>64</b>	540 Series <b>SIG-Manurhin</b> Assault Rifle . . . . .	74
7.62mm Type 53 Carbine . . . . .	64	Federal Arms Factory Assault Rifle MP E21 . . . . .	74
7.62mm Type 56 Carbine . . . . .	64	5.56mm SG541 <b>SIG</b> Assault Rifle . . . . .	74
7.62mm Types 56 & 56-1 Assault Rifles . . . . .	65	<b>TAIWAN</b> . . . . .	<b>75</b>
7.62mm Type 68 . . . . .	65	5.56mm Type 65 Assault Rifle . . . . .	75
<b>CZECHOSLOVAKIA</b> . . . . .	<b>65</b>	<b>The Old U.S.S.R.</b> . . . . .	<b>75</b>
7.62mm Models 52 & 56/57 Self-Loading . . . . .	65	7.62mm <b>M1891/30</b> Mosin-Nagant Sniping Rifle . . . . .	75
7.62mm M54 Sniping Rifle . . . . .	65	7.62mm Simonov <b>Self-Loading</b> (SKS) . . . . .	75
7.62mm Model 58 Assault Rifle . . . . .	65	7.62mm <b>AK-47</b> (East German Version) . . . . .	75
.30 Model 2 & 62 <b>Cristobal</b> Light Rifles . . . . .	66	7.62mm <b>AKM</b> Assault Rifle . . . . .	75
<b>FINLAND</b> . . . . .	<b>66</b>	7.62mm Dragunov Sniper (SVD) . . . . .	76
M60, M62, & M76 Automatic <b>Valmet</b> . . . . .	66	5.45mm <b>AK-47</b> Assault Rifle . . . . .	76
5.56mm M76 Short (Model 255 470) Automatic Valmet . . . . .	66	<b>UNITED KINGDOM</b> . . . . .	<b>76</b>
7.65mm MAS M 36 Rifle . . . . .	66	.303 <b>Lee-Enfield</b> . . . . .	76
7.5mm MAS 49 Rifle . . . . .	66	7.62mm L1A1 . . . . .	76
7.5mm Model M 1949/56 Rifle . . . . .	67	7.62mm Envoy Target Rifle . . . . .	76
<b>FRF1</b> Sniping Rifle . . . . .	67	7.62mm Enforcer Sniper Rifle . . . . .	77
5.56m FA MAS Rifle . . . . .	67	7.62mm <b>L42A1</b> . . . . .	77
Vaime Silenced Sniping Rifle . . . . .	67	5.56mm <b>XL 70 E3 Enfield</b> . . . . .	77
<b>GERMANY</b> . . . . .	<b>68</b>	7.62mm Model 82 <b>Parke-Hale</b> Sniping Rifle . . . . .	77
Model 98 Mauser . . . . .	68	5.56mm <b>AR18 Sterling-Armalite</b> . . . . .	77
7.62mm G3 Heckler & Koch . . . . .	68	5.56mm <b>AR180 Sterling-Armalite</b> . . . . .	78
7.62mm×51 <b>PSG1</b> High-Precision		5.56mm <b>AR18S Sterling-Armalite</b> . . . . .	78
Marksman Heckler & Koch . . . . .	68	7.62mm Sterling Sniper Rifle . . . . .	78
4.7mm <b>G11</b> Caseless Heckler & Koch Rifle . . . . .	69	5.56mm <b>Enfield L-85-A1</b> (Individual Weapon) . . . . .	78
7.62mm Model <b>SP66</b> Mauser Sniping Rifle . . . . .	69	7.62mm <b>BGR</b> Sniping Rifle . . . . .	79
<b>WA2000</b> Walther Sniping Rifle . . . . .	69	<b>UNITED STATES</b> . . . . .	<b>79</b>
<b>HUNGARY</b> . . . . .	<b>69</b>	.30 <b>M1917</b> (Enfield) . . . . .	79
7.62mm <b>AMD65</b> Assault Rifle . . . . .	69	.30 <b>M1</b> . . . . .	79
<b>ISRAEL</b> . . . . .	<b>70</b>	.30 <b>M1 Carbine</b> . . . . .	79
5.56mm <b>ARM/AR Galil</b> Assault Rifle . . . . .	70	.30 <b>Browning</b> Automatic Rifle . . . . .	80
5.56mm <b>SAR Galil</b> Assault Rifle . . . . .	70	7.62mm <b>NATO M14 &amp; M14A1</b> . . . . .	80
7.62mm <b>ARM/AR Galil</b> Assault Rifle . . . . .	70	7.62mm <b>AR-10</b> Assault Rifle . . . . .	80
7.62mm <b>SAR Galil</b> Assault Rifle . . . . .	70	5.56mm <b>M16 &amp; M16A1</b> . . . . .	80
7.62mm Galil Sniping Rifle . . . . .	70	5.56mm <b>Colt Commando</b> Assault Rifle/Sub-Machinegun . . . . .	81
<b>ITALY</b> . . . . .	<b>71</b>	5.56mm <b>Mini-14</b> Ruger . . . . .	81
7.62mm <b>BM 59 Beretta</b> . . . . .	71	5.56mm <b>AC-556</b> Ruger Selective Fire Weapon . . . . .	81
5.56mm <b>AR 70/223</b> Beretta . . . . .	71	5.56mm <b>Hughes Lockless</b> Rifle/Machine Gun . . . . .	81
5.56mm <b>SC70/90</b> Beretta Rifle . . . . .	71	7.62mm <b>RAI</b> Convertible Long-Range Rifle Model 300 . . . . .	81
7.62mm Beretta Sniper Rifle . . . . .	71	5.56mm <b>Colt M16A2</b> Model 723 Carbine . . . . .	82
5.56mm <b>Socimi</b> AR 871 Weapon System . . . . .	71	Springfield Armory <b>M6</b> Survival Gun . . . . .	82
<b>JAPAN</b> . . . . .	<b>72</b>	<b>YUGOSLAVIA</b> . . . . .	<b>82</b>
7.62mm Type 64 . . . . .	72	7.62mm <b>M59/66 A1</b> . . . . .	82
<b>SINGAPORE</b> . . . . .	<b>72</b>	7.62mm <b>M70B1 &amp; M70AB2</b> . . . . .	82
5.56mm <b>SAR80</b> Assault Rifle . . . . .	72	7.92mm <b>M76 Semi-Auto</b> Sniping Rifle . . . . .	82
<b>SOUTH AFRICA</b> . . . . .	<b>72</b>	7.62mm <b>M77B1</b> Assault Rifle . . . . .	83
5.56mm <b>R4</b> Assault Rifle . . . . .	72	5.56mm Assault Rifle . . . . .	83
<b>SPAIN</b> . . . . .	<b>73</b>	<b>RIFLE ACCESSORIES</b> . . . . .	<b>83</b>
7.62mm Model <b>E</b> <b>CETME</b> Assault Rifle . . . . .	73	<b>Ciener</b> AR15/M16 Beltfeed Mechanism . . . . .	83
5.56mm Model <b>L &amp; LC</b> <b>CETME</b> Assault Rifle . . . . .	73	<b>MWG</b> 5.56mm 90 Round Magazine . . . . .	84
		<b>Redi-Mag</b> Speed Loading System . . . . .	84

<b>SHOTGUNS</b> . . . . .	<b>85</b>	9mm Dux . . . . .	93
<b>ITALY</b> . . . . .	<b>85</b>	9mm MP-K & MP-L Walther . . . . .	93
12 Gauge RS 200 Beretta Shotgun . . . . .	85	9mm MP5 Heckler & Koch . . . . .	93
Model 12 SPAS Franchi Shotgun . . . . .	85	9mm MP5 SD Heckler & Koch . . . . .	94
12 Gauge Franchi SPAS 15 Shotgun . . . . .	85	9mm MP5K Heckler & Koch . . . . .	94
12 Gauge Bernadelli B4 Shotgun . . . . .	86	<b>INDONESIA</b> . . . . .	<b>94</b>
<b>SOUTH AFRICA</b> . . . . .	<b>86</b>	9mm PM Model VII . . . . .	94
12 Gauge Striker semi-automatic Shotgun . . . . .	86	<b>ISRAEL</b> . . . . .	<b>94</b>
<b>UNITED STATES</b> . . . . .	<b>86</b>	9mm Uzi . . . . .	94
Model 37M Ithaca Shotgun . . . . .	86	9mm Mini Uzi . . . . .	94
Stakeout Ithaca Shotgun . . . . .	87	9mm Micro-Uzi . . . . .	94
Model 3000 Police Smith & Wesson . . . . .	87	<b>ITALY</b> . . . . .	<b>95</b>
12 Gauge Defender Winchester Shotgun . . . . .	87	9mm Model 1938A Beretta (1st variant) . . . . .	95
12 Gauge Stainless Marine Winchester Shotgun . . . . .	87	9mm Model 38/42 Beretta . . . . .	95
Pancor Jackhammer Mark 3A2 . . . . .	87	9mm Model 12 Beretta . . . . .	95
Remington M870 Mark 1 U.S. Marine Corps Shotgun . . . . .	88	9mm Model 12S . . . . .	95
		9mm Model LF 57 Franchi . . . . .	95
<b>SUB-MACHINEGUNS</b> . . . . .	<b>88</b>	<b>JAPAN</b> . . . . .	<b>96</b>
<b>ARGENTINA</b> . . . . .	<b>88</b>	9mm Model 66 SCK . . . . .	96
9mm PA3DM sub-machinegun . . . . .	88	<b>LUXEMBOURG</b> . . . . .	<b>96</b>
<b>AUSTRALIA</b> . . . . .	<b>88</b>	9mm Model Super Sola . . . . .	96
<b>Owen MK1</b> . . . . .	<b>88</b>	<b>MEXICO</b> . . . . .	<b>96</b>
<b>AUSTRIA</b> . . . . .	<b>89</b>	<b>9mm Model HM-3</b> . . . . .	<b>96</b>
9mm MPi 69 & MPi 81 Steyr . . . . .	89	<b>PORTUGAL</b> . . . . .	<b>96</b>
<b>BELGIUM</b> . . . . .	<b>89</b>	9mm M948 FMBP . . . . .	96
9mm Mitraillette Vigneron M2 . . . . .	89	9mm INDEP M86 . . . . .	96
5.7mm FN P90 personal weapon . . . . .	89	9mm M976 FMBP . . . . .	97
<b>BRAZIL</b> . . . . .	<b>89</b>	<b>ROMANIA</b> . . . . .	<b>97</b>
9mm BSM/9 M3 . . . . .	89	9mm Orita Model 19 . . . . .	97
9mm MD1 and MD-1A1 IMBEL . . . . .	89	<b>SOUTH AFRICA</b> . . . . .	<b>97</b>
9mm MD2 IMBEL . . . . .	90	9mm SANNA 77 . . . . .	97
.45 INA MB 50 . . . . .	90	<b>SPAIN</b> . . . . .	<b>97</b>
9mm LAPA SM Model 02 . . . . .	90	9mm Model Z62 Star . . . . .	97
9mm Uru Mekanika . . . . .	90	9mm C2 . . . . .	97
<b>CANADA</b> . . . . .	<b>91</b>	<b>SWEDEN</b> . . . . .	<b>98</b>
9mm CI . . . . .	91	9mm Model 45 . . . . .	98
<b>CHINA, PEOPLE'S REPUBLIC</b> . . . . .	<b>91</b>	<b>SWITZERLAND</b> . . . . .	<b>98</b>
7.62mm Type 64 . . . . .	91	MP310 SIG . . . . .	98
<b>CZECHOSLOVAKIA</b> . . . . .	<b>91</b>	<b>TURKEY</b> . . . . .	<b>98</b>
Model 23, 24, 25 & 26 . . . . .	91	9mm Model 1968 . . . . .	98
<b>DENMARK</b> . . . . .	<b>91</b>	<b>The Old U.S.S.R.</b> . . . . .	<b>98</b>
9mm Model 49 Hovea . . . . .	91	7.62mm pps43 . . . . .	98
9mm Madsen . . . . .	91	5.45mm AKSU74 . . . . .	98
<b>FINLAND</b> . . . . .	<b>92</b>	<b>UNITED KINGDOM</b> . . . . .	<b>99</b>
9mm Model 1931 . . . . .	92	9mm Sten MKII . . . . .	99
9mm Model 1944 . . . . .	92	9mm Sten MK IIS . . . . .	99
9mm Jati-Matic . . . . .	92	9mm Sten MK III . . . . .	99
<b>FRANCE</b> . . . . .	<b>92</b>	9mm Sten MK V . . . . .	99
7.65mm Model 38 MAS . . . . .	92	9mm L2A3 Sterling . . . . .	99
9mm MAT 49 . . . . .	92	9mm L34A1 Sterling MK5 . . . . .	99
9mm Gevarm . . . . .	93	<b>UNITED STATES</b> . . . . .	<b>100</b>
<b>GERMANY</b> . . . . .	<b>93</b>	.45 Thompson M1 . . . . .	100
9mm MP40 . . . . .	93		

.45 M3	100
Ingram Model 10	100
9mm Viking	100
Ares FMG Folding Sub-Machinegun	100
5.56mm Ruger AC556F	101
9mm Weaver PKS9 Ultralite	101
KFAMP Assault Machine Pistol	101
<b>VIETNAM</b>	<b>101</b>
7.62mm K-50 Modified	101
<b>YUGOSLAVIA</b>	<b>101</b>
7.62mm M49 & M49/57	101
7.62mm M56	101
<b>MACHINE GUNS</b>	<b>102</b>
<b>AUSTRIA</b>	<b>102</b>
5.56mm Steyr Army Universal Gun	
Light Machine Gun Version	102
<b>BELGIUM</b>	<b>103</b>
7.62mm FN MAG General Purpose Machine Gun	103
<b>CHINA</b>	<b>103</b>
7.62mm Type 67 Light Machine Gun	103
12.7mm Anti-Aircraft Machine Gun Type 77 & W-85	103
7.92mm Model 37 Medium Machine Gun	103
14.5mm Anti-Aircraft Machine Gun Type 75	103
<b>CZECHOSLOVAKIA</b>	<b>104</b>
7.62mm Model 52 Light Machine Gun	104
<b>DENMARK</b>	<b>104</b>
7.62mm Madsen-Saetter General Purpose Machine Gun	104
<b>FINLAND</b>	<b>104</b>
7.62mm M78 Valmet Light Machine Gun	104
<b>FRANCE</b>	<b>105</b>
7.62mm AA 52 General Purpose Machine Gun	105
<b>GERMANY, FEDERAL REPUBLIC</b>	<b>105</b>
7.92mm MG 34	105
5.56mm HK 13 Heckler & Koch Light Machine Gun	105
7.62mm HK 21A1 Heckler & Koch	106
<b>ITALY</b>	<b>106</b>
5.56mm Model 70-78 Beretta Light Machine Gun	106
<b>JAPAN</b>	<b>106</b>
7.62mm Model 62	106
<b>MEXICO</b>	<b>106</b>
.30 RM2 Mendoza Machine Gun	106
<b>SPAIN</b>	<b>106</b>
5.56mm CETME Ameli Light Machine Gun	106
<b>SWITZERLAND</b>	<b>106</b>
7.62mm SIG 710-3 General Purpose Machine Gun	106
<b>The Old U.S.S.R.</b>	<b>106</b>
7.62mm RPD Model 4 Light Machine Gun	106
7.62mm SGM (Goryunov) Medium Machine Gun	106
12.7mm Degtyarev (Dsh K-38 & Model 38/46) Heavy Machine Gun	106
14.5mm KPV Heavy Machine Gun	106

<b>UNITED KINGDOM</b>	<b>107</b>
.303 Mark 1 Vickers Machine Gun	107
<b>UNITED STATES</b>	<b>107</b>
7.62mm M60 General Purpose Machine Gun	107
.30 Caliber Model 1919 A4 Browning Machine Gun	107
.50 Caliber Browning Heavy Machine Gun	107
.50 Caliber Saco Defense 'Fifty/50'	
.50 inch Heavy Machine Gun	108
.50 Caliber GECAL 50, Six Barrel, Machine Gun	108
5.56mm XM-214/Six-Pak Mini-Gun	108

## **COMBAT HAND GRENADES . . . . .109**

<b>AUSTRIA</b>	<b>109</b>
Type HG77 Fragmentation Hand Grenade	109
Type HG80 Mini-Fragmentation Grenade	109
<b>BELGIUM</b>	<b>109</b>
PRB NR 423 Hand Grenade	109
<b>BRAZIL</b>	<b>109</b>
M3 Defensive/Offensive Hand Grenade	109
<b>CHILE</b>	<b>110</b>
Mini Hand Grenade	110
OD/82 Hand Grenade	110
<b>POLAND</b>	<b>110</b>
Model 31, Fragmenting Hand Grenade (& Rifle version)	110
<b>The Old U.S.S.R.</b>	<b>110</b>
<b>RPG-43 Anti-Tank Hand Grenade</b>	<b>110</b>
<b>UNITED STATES OF AMERICA</b>	<b>110</b>
M67 Delay Fragmentation Hand Grenade	110
An-M14 TH3 Incendiary Hand Grenade	110
<b>YUGOSLAVIA</b>	<b>111</b>
Yugoslav M69 Anti-Personnel Hand Grenade	111
Yugoslav M79 Anti-Tank Hand Grenade	111

## **LIGHT SUPPORT WEAPONS . . . . .112**

<b>Flamethrowers</b>	<b>112</b>
<b>BRAZIL</b>	<b>112</b>
LC T1 M1 Flamethrower	112
<b>GERMANY</b>	<b>112</b>
HAFLA DM 34 Hand Flame Cartridge Launcher	112
<b>ITALY</b>	<b>113</b>
Mod T148 Portable Flamethrower	113
<b>TAIWAN</b>	<b>113</b>
Type 67 Flamethrower	113
<b>UNITED STATES</b>	<b>113</b>
66mm M202A2 Multi-Shot Portable Flame Weapon	113
ABC-M9-7 Portable Flamethrower	113

## **GRENADE & ROCKET LAUNCHERS . . . 114**

<b>Grenade Launchers</b>	<b>114</b>
<b>AUSTRIA</b>	<b>114</b>
M203 Grenade Launcher	114

Arges 40mm grenades for M79/M203 Pattern Launchers . . . . .	114	<b>FRANCE</b> . . . . .	<b>125</b>
Rifle-launched HG84 fragmentation grenades (SGG) . . . . .	115	LRAC 89 Anti-Tank Rocket Launcher . . . . .	125
<b>BELGIUM</b> . . . . .	115	SEP DARD 120 Close <b>Anti-Armor</b> Weapon . . . . .	125
FLY-K PRB Grenade Launcher/Mortar . . . . .	115	Eryx Anti-Tank Missile . . . . .	126
NR 8464 PRB Multiple Grenade Launcher/Mortar . . . . .	115	MILAN Anti-Tank Weapon . . . . .	126
MECAR Disorienting Grenade DS-RFL-35 BTU M278 . . . . .	115	APILAS anti-armor weapon . . . . .	126
35mm HE-RFL-35 BTU M262		<b>GERMANY</b> . . . . .	<b>127</b>
Anti-Personnel MECAR Rifle Grenade . . . . .	115	Panzerfaust 3 . . . . .	127
<b>Types of Rifle Grenades</b> . . . . .	115	Panzerfaust Off-Route Mine System . . . . .	128
NR 208 Rifle Grenade . . . . .	115	PZF 44 2A1 (Lanze) . . . . .	128
NR 209 Rifle Grenade - illuminating . . . . .	115	Armbrust Anti-Armor & Self Defense Weapon . . . . .	129
NR 210 Rifle Grenade - smoke . . . . .	116	<b>ISRAEL</b> . . . . .	<b>129</b>
<b>GERMANY</b> . . . . .	116	B-300 Anti-Armor Weapon . . . . .	129
40mm Granat-pistole Grenade Launcher . . . . .	116	<b>ITALY</b> . . . . .	<b>129</b>
HK79 Add-On Grenade Launcher . . . . .	116	Folgore Anti-Tank Rocket . . . . .	129
<b>SINGAPORE</b> . . . . .	116	<b>SPAIN</b> . . . . .	<b>130</b>
CIS-40GL grenade launcher . . . . .	116	M65 Anti-Tank Rocket Launcher . . . . .	130
<b>SOUTH AFRICA</b> . . . . .	117	C-90 C and CR Anti-Tank Weapons . . . . .	130
40mm Armscor Grenade Launcher . . . . .	117	<b>SWEDEN</b> . . . . .	<b>131</b>
40mm Armscor MGL 6-Shot Grenade Launcher . . . . .	117	Miniman Anti-Armor Weapon . . . . .	131
37mm Stopper Riot Control Weapon . . . . .	118	AT4 FFV Anti-Armor Weapon . . . . .	131
<b>SWITZERLAND</b> . . . . .	118	M2, and M3 Carl Gustav gun . . . . .	131
35mm Arpad 600 Close Support Weapon . . . . .	118	FFV 597 HEAT Round . . . . .	132
<b>The Old U.S.S.R.</b> . . . . .	118	84mm System 550 Carl Gustav (a.k.a. M2-550) . . . . .	132
AGS-17 grenade launcher . . . . .	118	HEDP FFV 502 High Explosive <b>Dual-Purpose</b> Round . . . . .	133
BG-15 Grenade Launcher . . . . .	118	Bantam Anti-Tank Missile . . . . .	133
<b>UNITED KINGDOM</b> . . . . .	118	RBS 56 BILL Anti-Armor Missile . . . . .	134
L1A1 Grenade Discharger . . . . .	118	<b>SWITZERLAND</b> . . . . .	<b>134</b>
Hilton MPRG <b>Multi-Purpose</b> Gun . . . . .	118	Rocket Launcher 58/80 . . . . .	134
Schermuly multi-purpose riot gun . . . . .	119	<b>The Old U.S.S.R.</b> . . . . .	134
<b>UNITED STATES</b> . . . . .	119	RPG-2 . . . . .	134
PIM203 40mm Grenade Launcher . . . . .	119	RPG-7 . . . . .	135
40mm MM-1 Multiple Grenade Launcher . . . . .	120	<b>RPG-18</b> anti-armor weapon . . . . .	135
40mm Mark 19 Mod 3 Automatic Grenade Launcher . . . . .	120	Sagger anti-tank guided missile . . . . .	136
AAI Close Assault Weapon System (CAWS) . . . . .	120	SPIGOT Anti-Tank Guided Missile . . . . .	136
Olin/Heckler and Koch		<b>UNITED KINGDOM</b> . . . . .	<b>136</b>
Close Assault Weapon Systems (CAWS) . . . . .	121	LAW 80 Light Anti-tank Weapon system . . . . .	136
Scorpion Urban Fighting Weapon . . . . .	121	<b>UNITED STATES OF AMERICA</b> . . . . .	<b>137</b>
Pancor <b>Jackhammer</b> Mark 3-A2 . . . . .	121	140mm Brunswick RAW HE Rocket . . . . .	137
Pancor 'Bear Trap' Anti-Personnel Device . . . . .	122	SMAW . . . . .	137
		M72A2 and M72A3 rocket launcher . . . . .	138
		M20 Rocket Launcher . . . . .	138
		M67 Recoilless Rifle . . . . .	138
		M47 Dragon Medium <b>Anti-Tank/Assault</b> Weapon . . . . .	139
		TOW Heavy Anti-Tank Weapon System . . . . .	139
		<b>YUGOSLAVIA</b> . . . . .	<b>140</b>
		M79 Recoilless Gun . . . . .	140
		M79 Rocket Launcher . . . . .	140
		<b>ANTI-AIRCRAFT WEAPONS</b> . . . . .	<b>141</b>
		Surface to Air Missiles (SAM) . . . . .	141
		Blowpipe & Javelin SAM . . . . .	141
		FIM-92A 'Stinger' . . . . .	141
		SA-7B 'Grail' . . . . .	142
<b>SPECIAL SUPPORT WEAPONS</b>			
<b>&amp; ANTI-TANK WEAPONS</b> . . . . .	<b>123</b>		
<b>AUSTRIA</b> . . . . .	<b>123</b>		
LAT 500 Anti-Tank Weapon . . . . .	123		
<b>CHINA</b> . . . . .	<b>123</b>		
Red Arrow 8 Guided Weapon System . . . . .	123		
40mm Type 69 Anti-Tank Grenade Launcher . . . . .	124		
<b>CZECHOSLOVAKIA</b> . . . . .	<b>124</b>		
RPG-75 Light Anti-Armor Weapon . . . . .	124		
Type P-27 ( <b>Pancerovoka</b> ) Anti-Tank Grenade Launcher . . . . .	124		
<b>FINLAND</b> . . . . .	<b>125</b>		
M-55 recoilless launcher . . . . .	125		



<b>MORTARS</b> . . . . .	<b>142</b>
81mm SMI Mortar . . . . .	142
FLY-K PRB Mortar . . . . .	143
60mm Commando Mortar . . . . .	143
81mm FAMAEMortar . . . . .	143
NR 8120 PRB Grapnel Launcher . . . . .	144
128 mm Light Rocket Launcher M-71 . . . . .	144
CMB-8 Mortar fire control computer . . . . .	145
M23 Mortar Ballistic Computer . . . . .	145

<b>PYROTECHNICS</b> . . . . .	<b>145</b>
Defence Smoke Cartridge . . . . .	145
Smoke Cartridge HC-72 . . . . .	145
Smoke Generator HC-75 . . . . .	145
Illuminating Mine LK-40 . . . . .	145
FAMAEM Infiltration Alarm . . . . .	146
27mm Type 57 Signal Pistol . . . . .	146
Type 428 Distress Signal Kit . . . . .	147
Feistel 26.5mm Message Cartridge . . . . .	147
Feistel DM22 Smoke Generator . . . . .	147
1-inch Beretta Signal Pistol . . . . .	147
38 mm handheld rockets . . . . .	148
ROF Dial-A-Star . . . . .	148
Portable Speedline 250 Linethrowing Unit . . . . .	148

<b>SURVEILLANCE EQUIPMENT</b> . . . . .	<b>149</b>
Binoculars, Night Sights & Scopes . . . . .	149
OB-44 SOPELEM Night Observation Binocular . . . . .	149
OB-50 Mk 2 SOPELEM Night Firing Scope . . . . .	149
CN2H SOPELEM Night Flying Goggles . . . . .	149
Euroscope H II Night Viewing Device . . . . .	149
MILOS Miniature long-range TV observation system . . . . .	150
KOT-II Night Observation Binocular . . . . .	150
HHI-8 Handheld Thermal Imager . . . . .	150
Baird General-Purpose Night Vision Goggles . . . . .	150

<b>SIGHTING EQUIPMENT</b> . . . . .	<b>151</b>
Orion 80 Passive Night Sight . . . . .	151
EEV Lion Night Sight . . . . .	151
Type SS82 Lightweight Pocketscope/Weapon Sight . . . . .	151
W201 Individual Weapon Sight . . . . .	151
AN/PVS-2 Starlight Scope . . . . .	151
NVS-800 Night Vision System . . . . .	151
Simrad KN200 Image Intensifier . . . . .	152
Simrad KN250 Image Intensifier . . . . .	152
RB 12A Battlefield Surveillance Radar . . . . .	153
Laser Target Indicator . . . . .	153
LS55 Laser aiming system . . . . .	153
Aquila Mini weapon sight . . . . .	153
UP 1040 Self-Powered Observation Sight . . . . .	154
UP 1042 Handheld Thermal Camera . . . . .	154
KH92S CCD Camera . . . . .	154
KH190R CCD Camera . . . . .	154
Model 97 explosives detector . . . . .	154
Sure-Fire 1 Universal Light and Laser Sight System . . . . .	154
CVS 380 discreet video system . . . . .	154
TR Micro TransporteX portable X-ray unit . . . . .	155
AS 360 MS5 ROV sonar system . . . . .	155

<b>TANKS &amp; ARMORED VEHICLES</b> . . . . .	<b>156</b>
<b>BRAZIL</b> . . . . .	<b>156</b>
ENGESA EE-9 Cascavel Armoured Car . . . . .	156
<b>FRANCE</b> . . . . .	<b>157</b>
AMX-30 Main Battle Tank . . . . .	157
AMX-13 Light Tank . . . . .	157
Panhard ERC Sagaie Armored Car . . . . .	158
Panhard VBL Scout Car . . . . .	159
<b>GERMANY</b> . . . . .	<b>159</b>
TM 170 Armored Personnel Carrier . . . . .	159
<b>ISRAEL</b> . . . . .	<b>159</b>
Merkava Main Battle Tank . . . . .	159
<b>159 SOUTH AFRICA</b> . . . . .	<b>160</b>
Ratel 20 Infantry Fighting Vehicle . . . . .	160
<b>SWEDEN</b> . . . . .	<b>161</b>
Pbv Armored Personnel Carrier . . . . .	161
<b>UNITED KINGDOM</b> . . . . .	<b>161</b>
Centurion Main Battle Tank . . . . .	161
Challenger Main Battle Tank . . . . .	162
Daimler Ferret Mk 2/3 Scout Car . . . . .	162
Alvis Saladin Armored Car . . . . .	163
Alvis Scorpion Reconnaissance Vehicle . . . . .	164
<b>UNITED STATES OF AMERICA</b> . . . . .	<b>165</b>
M48A3 Main Battle Tank . . . . .	165
Cadillac Gage V-300 . . . . .	166
Commando Armored Personnel Carrier . . . . .	166
Cadillac Gage Commando Ranger . . . . .	166
Armored Personnel Carrier . . . . .	166
M2 Bradley Infantry Fighting Vehicle . . . . .	167
<b>The Old U.S.S.R.</b> . . . . .	<b>167</b>
T-72 Main Battle Tank . . . . .	167
BRDM-2 Amphibious Scout Car . . . . .	168
BMD Airborne Combat Vehicle . . . . .	168



K. SIEMBIEDA '93

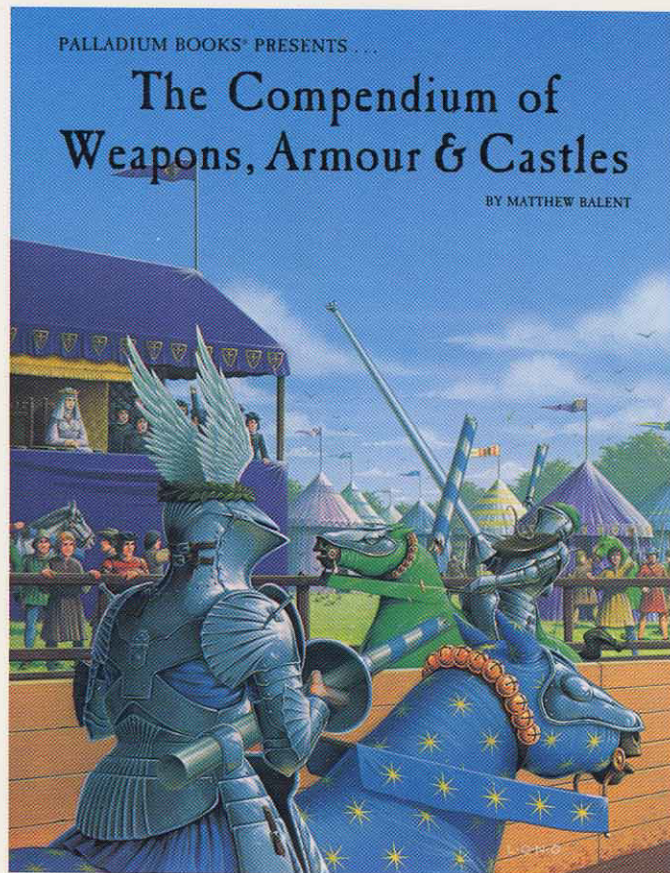

Also from Palladium Books®

## The Compendium of Weapons,™ Armour & Castles

- Over 700 ancient weapons from around the world.
- Over 45 different types of armour.
- Siege weapons & techniques.
- 40 Castles with floor plans.
- Everything beautifully illustrated.
- Written by Matthew Balent
- Illustrated by Long, Siembieda & Gustovich.
- Suitable for use with ALL role-playing games!
- 224 Pages — \$19.95 — Available at stores everywhere!

## The Compendium of Contemporary Weapons™

- For use with ANY game system.
- Hundreds of weapons! Complete with statistical data.
- Revolvers and pistols.
- Rifles and shotguns.
- Machineguns and sub-machineguns.
- Rocket and grenade launchers and mortars.
- Grenades and flamethrowers.
- EOD, scopes, and accessories.
- Perhaps one of the most comprehensive guides to modern weapons ever made for role-playing games.

**Suitable for use with ALL role-playing games.**

Directly compatible with RECON®, Heroes Unlimited™, Ninjas & Superspies™, Beyond the Supernatural™ and the entire Palladium Books® Megaverse®.

**\$19.95**  
**Cat. No. 415**  
**I.S.B.N. 0916211-65-7**

ISBN 0-916211-65-7

