

LEGENDS & LAIRS™

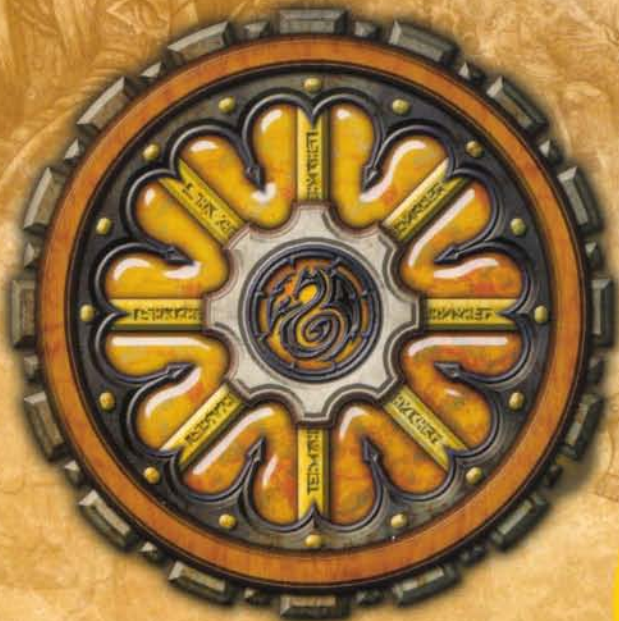

MASTERCRAFT™ ANTHOLOGY



COLLECTED LORE OF
LEGENDS AND LAIRS

LEGENDARY
CONTENT!
\$4.95
U.S. MSRP
EPIC PRICE!

Requires the use of the
Dungeons & Dragons® Player's Handbook,
Third Edition, published by Wizards of the Coast®

LEGENDS & LAIRS™

20
system

MASTERCRAFT™ ANTHOLOGY



COLLECTED LORE OF
LEGENDS AND LAIRS

MASTERCRAFT ANTHOLOGY

CREDITS

LEAD DEVELOPER

Rob Vaughn

MANAGING DEVELOPER

Greg Benage

GRAPHIC & COVER DESIGN

Scott Nicely

LAYOUT

Rob Vaughn

PUBLISHER

Christian T. Petersen

PRINTING

Bang Printing

WRITING

Justin Bacon, Greg Benage, Ed Bouelle, Clay Breedlove, Kurt Brown, Shaun Cashman, Mark Chance, David Chart, Catten Ely, Brian Ferrenz, Tod Gelle, Chris Hussey, Lizard, David Lyons, Michelle Lyons, James Maliszewski, Mike Mearls, Rick Neal, Brian Patterson, Peter Schweighofer, Scott Stoecker, Paul Sudlow, William Timmins, Wil Upchurch, Rob Vaughn, Sam Witt, Bree Zastrow

ILLUSTRATIONS

Toren "Macbin" Atkinson, Andy Brase, Paul Butler, Mitch Cotie, Scott Drouin, Alan Dyson, Jesper Ejsing, David Griffith, Kenneth Kay, Eric Lofgren, Alex Oliver, Hian Rodriguez, Brian Schomburg, Chris Seaman, Chad Sergesketter, Tyler Walpole, Kieran Yanner

FANTASY FLIGHT GAMES

1975 W. County Rd. B2

Roseville, MN 55113

651.639.1905

www.fantasyflightgames.com

'd20 System' and the 'd20 System' logo are Trademarks owned by Wizards of the Coast and are used according to the terms of the d20 System License version 1.0. A copy of this License can be found at www.wizards.com.

Dungeons & Dragons® and Wizards of the Coast® are Registered Trademarks of Wizards of the Coast and are used with permission.

Copyright © 2003 Fantasy Flight Publishing, Inc. Legends & Lairs™, Mastercraft Anthology™, Monster's Handbook™, Mythic Races™, Path of Faith™, Path of Magic™, Path of Shadow™, Path of the Sword™, Seafarer's Handbook™, Traps & Treachery™, and Traps & Treachery II™ are trademarks of Fantasy Flight Publishing, Inc. All Rights Reserved. This work, or parts thereof, may not be copied without permission.



CONTENTS

MYTHIC RACES	5
PATH OF THE SWORD	20
PATH OF SHADOW	34
PATH OF FAITH	48
PATH OF MAGIC	62
SPELLS & SPELLCRAFT	74
SEAFARER'S HANDBOOK	88
MONSTER'S HANDBOOK	100
TRAPS & TREACHERY	114
TRAPS & TREACHERY II	128

INTRODUCTION

Speaking as a gamer, I think it's safe to say that we as a group are living contradictions. We can be incredibly detail-oriented, wanting to know every last bit of minutia about our favorite setting, rules set, or genre. On the other hand, we seem to be insatiable for variety and new stuff.

Some players love a specific character class: perhaps fighters, whether they be brawlers, duelists, tanks, or archers. Some players love over-the-top characters of any class, whether they be explosive evokers, bombastic barbarians, or crusading clerics. Some want crunchy bits to drop into their game, some want suggestions on shaping societies and organizations. Some want it all. That's what defines the **Legends & Lairs** series.

Conveniently enough, it also defines the book that you're holding. We call it the *Mastercraft Anthology* because it has a little of the best from the first 10 **Legends & Lairs** books. Notice I say "a little" . . . we've been publishing this line for a year and a half, now, and each book seems better than the last, so it was impossible to fit all the good stuff in. There's enough here, however, to both act as a sampler for the rest of the series and to stand on its own as a valuable sourcebook for your d20 system games.

Rob Vaughn
Fantasy Flight Games

WELCOME

Fantasy Flight Games is pleased to present the *Mastercraft Anthology*, a sample collection of the first 10 volumes in our **Legends & Lairs** line of sourcebooks for the d20 System. *Mastercraft Anthology* brings together highlights from each book, as well as demonstrating some of what you'll find in the series as a whole.

First we have a sample of *Mythic Races*, a tome of new races of all shapes, sizes, dispositions, and themes.

The segment of *Path of the Sword*, our

sourcebook for the fighting classes, gives you a prestige class, new feats, and a new character development tool called a combat school. Think we only have those features for the frontliners? Not a chance. You'll find those and more in each of our *Path* books.

Getting tired of paging through swarms of overspecialized and rigid prestige classes to find one that fits your character? The section from *Path of Shadow* introduces legendary classes, a unique new option that allows you to tailor your high-level character in the direction you want, at the rate you want, choosing your own strengths and weaknesses. Again, if they're in one sample section, you can bet they're going to be in the other books as well.

The rest of the sample sections are just as packed. New spells, powering up your familiar, "small" gods, core class variants, rituals, ship combat rules, a focus on one type of monster, new insidious traps . . . it's all here.

Enjoy for now, because we're not done yet!

THE OPEN GAME LICENSE

Mastercraft Anthology is published under the terms of the Open Game License and the d20 System Trademark License. The OGL allows us to use the d20 System core rules and to publish gaming material derived from those rules.

Material that is strictly rules related is Open Content.

Not everything in this book is Open Content, however. The names of races, feats, skills, equipment, spells, magic items, and rules derived from the d20 SRD are designated as Open Content. Descriptive text, unless otherwise noted, is closed content and cannot be republished, copied, or distributed without the consent of Fantasy Flight Games. A note at the beginning of each section describes the open and closed content found within.

All illustrations, pictures, and diagrams in this book are Product Identity and the property of Fantasy Flight Games, © 2002.

The Open Game License is printed in its entirety at the end of this book. For further information, please visit the Open Gaming Foundation website at www.opengamingfoundation.org.

MYTHIC RACES

Dwarves are sturdy. Elves are graceful. Gnomes are clever, halflings curious, humans diverse, half-orcs brutal.

These races and their trademark traits are the staples of fantasy role-playing. They serve well as the basic cast for any campaign. But eventually every player or GM wants to take on a new role, to explore the roleplaying possibilities of new cultures, beings, and powers.

That is what inspired *Mythic Races*. Some of the new creatures here are classic racial types, like aquatic humanoids, winged peoples, and animal-human hybrids. Some are familiar entities but are not traditionally seen in the role of the PC, like undead races or living constructs.

But most of the entries in this compendium are purely original, plucked from our writers' imaginations. Familiar or alien, however, each entry includes a wealth of background information for GM and player alike. Every race is accompanied by a physical description and multiple illustrations. You'll also find a comprehensive cultural description that includes

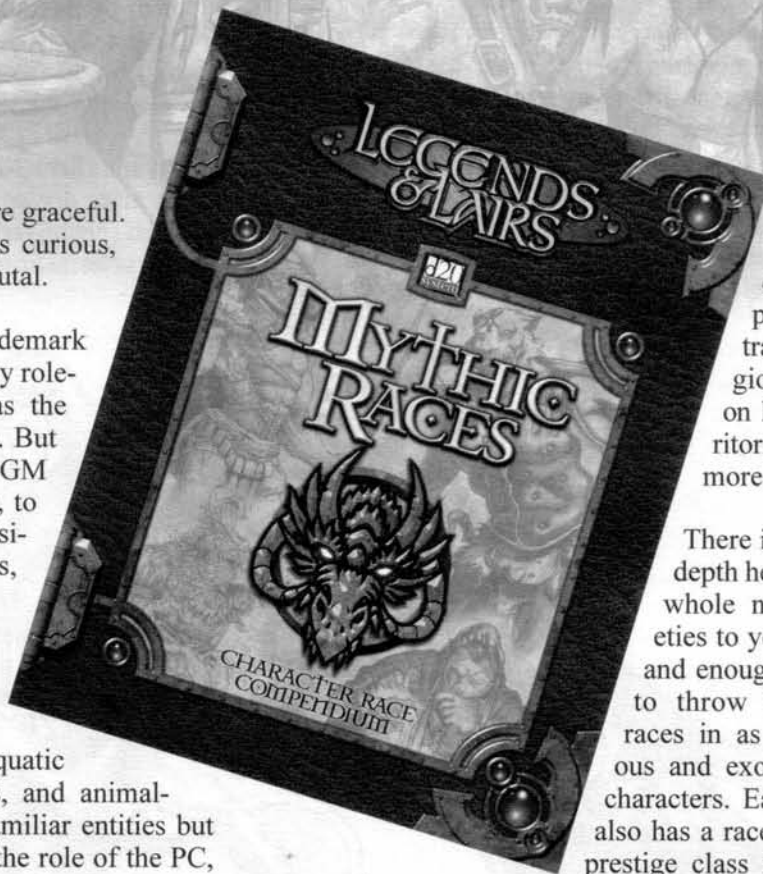

names, common personality traits, religion, details on home territories, and more.

There is enough depth here to add whole new societies to your game and enough variety to throw the new races in as mysterious and exotic guest characters. Each entry also has a race-specific prestige class for those who want to explore the

heritage and focus of the race.

The names of races, feats, skills, equipment, and any rules or game mechanics derived from the d20 System Reference Document are considered **Open Game Content**. All background text describing these races is considered closed content.

LUMINOUS

Centuries ago, the luminous greatly resembled the elven races, with slender builds and a graceful yet powerful presence. Unlike the elves, the luminous devoted their entire existence to the destruction of evil, often taking the role of paladins and clerics of benevolent deities. As the efforts of the luminous escalated, so too did the efforts of evil. This led luminous sages to begin experimenting with the forces of the positive energy plane, a plane that many of the luminous champions called upon regularly to aid them in battle. The sages believed that a way could be found to literally integrate these forces into the physiology of the luminous race.

After generations of research, the sages had made steps in the right direction but stood no closer to their final goal. It would take a great tragedy and divine intervention to allow the luminous to realize their dream. As legends tell it, a war raged across the lands and the death tolls reached unimaginable numbers as the forces of a great evil ravaged the innocent. At

the forefront of the resistance stood the luminous who valiantly fought the undead legions, caring not for themselves but rather for the survival of the other races who had fallen.

On the eve of the luminous' near extinction, the race took a collective stand against the enemy, sacrificing thousands of their numbers to save the land from the evil forces. Though the luminous were victorious, it came at a heavy cost as only a fraction of the race survived. Legend holds that a deity of chivalry and heroism took notice of the sacrifice made by the luminous and offered a sign of thanks and acceptance by granting them the connection with the positive energy plane that they desired.

Since that momentous event, the luminous have worked to live up to the faith placed in them by the deity by working as champions of good and justice. They are living conductors of positive energy and a bane to the forces of evil, especially the undead.

Personality: More focused than friendly and far more driven than flippant, the luminous are often perceived as aloof or antisocial. This characterization is rarely true; in fact, the lumi-

nous make great efforts to find acceptance in the lands of other races.

Luminous are natural-born champions of honor, justice, and chivalry. They use their unique appearance both to frighten those who would commit evil and to calm or inspire their allies.

Physical Description:

Luminous stand between five and a half and six and a half feet tall and weigh between 115 and 225 pounds. Though they once resembled elves, the luminous have become some-

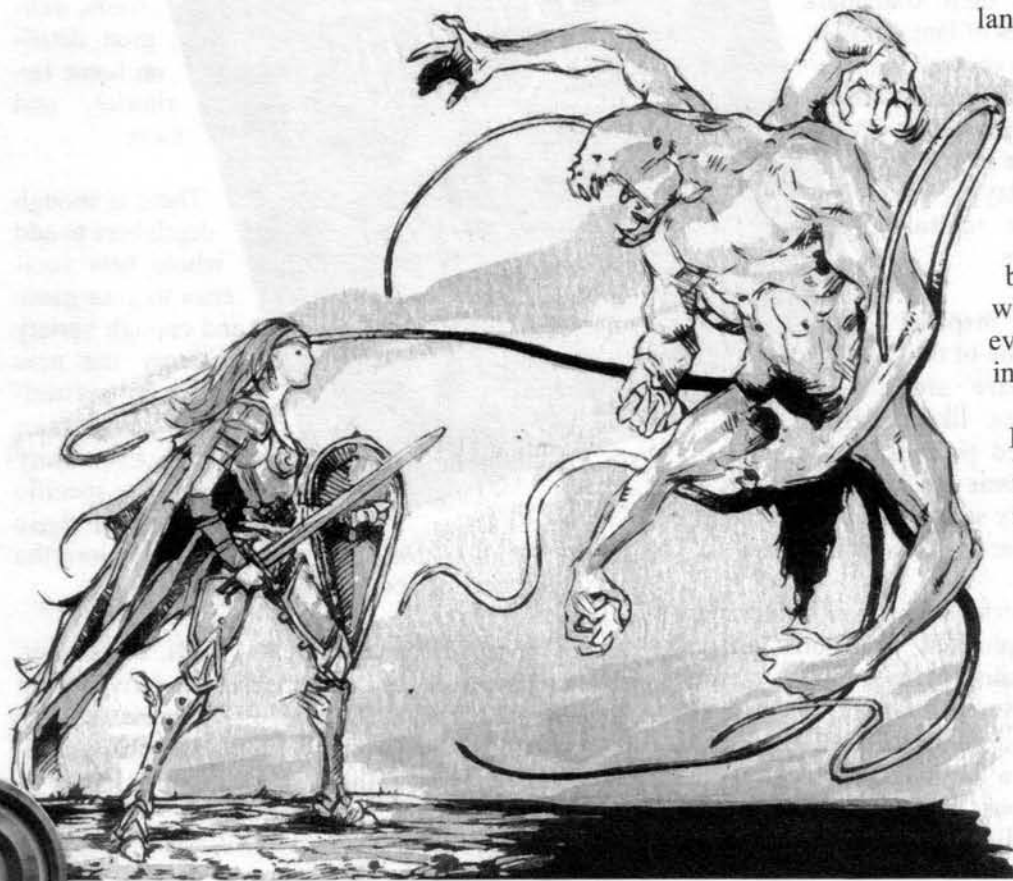

thing more by acting as living conductors of the positive energy plane. In appearance, the luminous possess the basic figure of a humanoid, but they have translucent skin that serves as a seal to contain and shape the positive energies that make up their anatomy and form. They have no hair, and their bodies lack the detail that those of normal races possess. Their bodies feature just enough defining characteristics to distinguish between males and females. The luminous do wear clothing and armor, favoring the styles of their home region or those they travel through.

As creatures of energy, the luminous glow with a light that increases and decreases in intensity with the changing of their moods. This energetic glow is also affected by physical injuries the luminous suffer. They possess no bodily organs or fluids—the luminous do not shed blood, they bleed the life energy upon which their existence depends. A luminous still loses hit points due to injury and dies when his life energies are dispersed. Additionally, death magic and similar effects that would harm another race are equally effective against the luminous, unless their racial traits or other special abilities state otherwise.

The luminous do not need to eat or even sleep. The average life span of a luminous is 300 years. The passing of an elder luminous is celebrated in a ritual ceremony in which his family and friends gather to share fond memories and bid him farewell.

When a luminous couple decides to conceive a child, both must sacrifice a portion of their own life energy. These energies meld and produce the child, mimicking many of the same reproductive processes of more mundane races.



Relations: Luminous are often outcasts in human lands, as their unique appearance tends to either uplift or frighten casual onlookers. As chivalrous as the luminous are, their devotion to the destruction of evil makes them a very focused, and unfortunately, very unsociable race. Despite their lack of social graces, they are one of the most devoted and fiercely loyal races one is likely to encounter. When a luminous devotes himself to a cause, he will act as its champion for life.

Alignment: Luminous believe in law and order, and they are devoted to the struggle

PURIFYING LIGHT [GENERAL]

As a luminous, you can use your energies to aid allies from the harmful effects of poisons.

Prerequisites: You must be a luminous.

Benefit: Each day, a number of times equal to your Wisdom modifier, you can channel your energies to grant a victim stricken by poison an additional saving throw (if the first failed). You also give the victim a +2 sacred bonus on the second save attempt against the poison.

against evil. Many luminous view the ways of chaos as sternly as they view the ways of evil, believing them to be two sides of the same dark path.

Luminous Lands: The luminous usually dwell in human lands, viewing many of the other races as too disorganized or chaotic. While the luminous often respect dwarves, they have a more difficult time finding their place in dwarven lands. The luminous do not often stay for long in the lands of other races, but this does not mean they will not champion other peoples if the need arises. Most luminous travel across the realms fighting evil wherever they find it. An ancient luminous saying proclaims, "Evil knows no borders, and neither shall we."

Religion: The luminous worship deities of law, heroism, and chivalry. Centuries of

devotion to the deity who transformed them have solidified their bond to the forces of light and order. However, rumors persist of a corrupted faction that has turned to evil, their life energies having been tainted by the negative energy plane. If these rumors are true, these evil luminous have succeeded in concealing

UNYIELDING AURA [GENERAL]

By carefully controlling and manifesting your energies, you can aid and inspire your allies in battle.

Prerequisites: You must be a luminous.

Benefit: Once per day, you can manifest the forces of the positive energy plane to create a 20-foot radius aura that grants all of your allies in the area of effect a +1 morale bonus to all attack rolls, damage, and saving throws. However, you must take 1 hit point of damage for each round you manifest the aura.

themselves, even from the elders of their race.

Language: The luminous speak a strange hybrid of Common, Elven, and Celestial called Lumin. The language is almost impossible for most other races to speak, aside from the elves and pevishan (see *Mythic Races*, page 91). Some sages suggest that the early luminous had strong ties to the ancient pevishan, thus explaining the latter's affinity for Lumin.

Names: Luminous names are often as orderly as the race itself. A mother and father will sometimes spend weeks or even months researching ancestral texts and records before choosing a child's name. Luminous usually have two names—a Lumin one and a Common one. The mother chooses the Lumin name and the father chooses the Common name. Among many luminous circles, it is considered very rude to speak the Lumin name in the presence of those who do not speak the language.

Male Names: Lumin—Qiol, Ulizanz, Ruilixn, and Equirizolo. Common—Dirk, Faren, and Millikan.

Female Names: Lumin—Zzirta, Willjula, and Aqixan. Common—Talliya, Lucinda, Eveliya.

Adventurers: Luminous typically adventure for one reason: to fight the forces of evil. Luminous often join good-aligned adventuring companies or knightly orders to gain allies in their struggle.

In recent years, elders have described a prophecy that foretells the return of their ancient enemy and a thousand years of pain and suffering to follow. With this revelation, many of the luminous have renewed their efforts to train their young and prepare for the coming battle. Others wander the lands looking for those responsible for the enemy's return.

LUMINOUS RACIAL TRAITS

- **+2 Wisdom, -2 Charisma:** Luminous are gifted with insight and a strong bond to both divine powers and the positive energy plane. Their rigid beliefs and values sometimes lead to the luminous being characterized as harsh and closed minded, and this often impairs their ability to interact with others.
- **Medium-size:** As Medium-size creatures, luminous have no special bonuses or penalties due to their size.
- **Poison Immunity:** As beings of energy, luminous have a racial immunity to all natural poisons. This ability does not protect the luminous from magical or supernatural poisons.
- **+4 racial bonus on all saving throws vs. Necromancy magic.** As beings of positive energy, the luminous have an increased resistance to the powers of necromancy.
- **Unique Anatomy:** As a being of pure energy, a luminous can intensify his natural glow to match the effects of torchlight or moonlight. A luminous can also dim this glow at times when stealth is called for, but this is more difficult to accomplish. A luminous must make a Fortitude save (DC 15) to dim his glow for a number of rounds equal to his Constitution score. The character can attempt this any number of times, but it requires a Fortitude save each time.
- **Enhanced Turning:** As beings of positive energy, the luminous are deadly foes to the undead. A luminous character who has the ability turns undead as a character two levels higher.
- **Automatic Languages:** Lumin and Common. **Bonus Languages:** Celestial and Elven. A well-traveled luminous can learn a wide variety of languages.
- **Favored Class:** Paladin. A multiclass luminous' paladin class does not count when determining whether he suffers an XP penalty for multiclassing. The luminous are inherently suited to lives as champions of law and goodness.

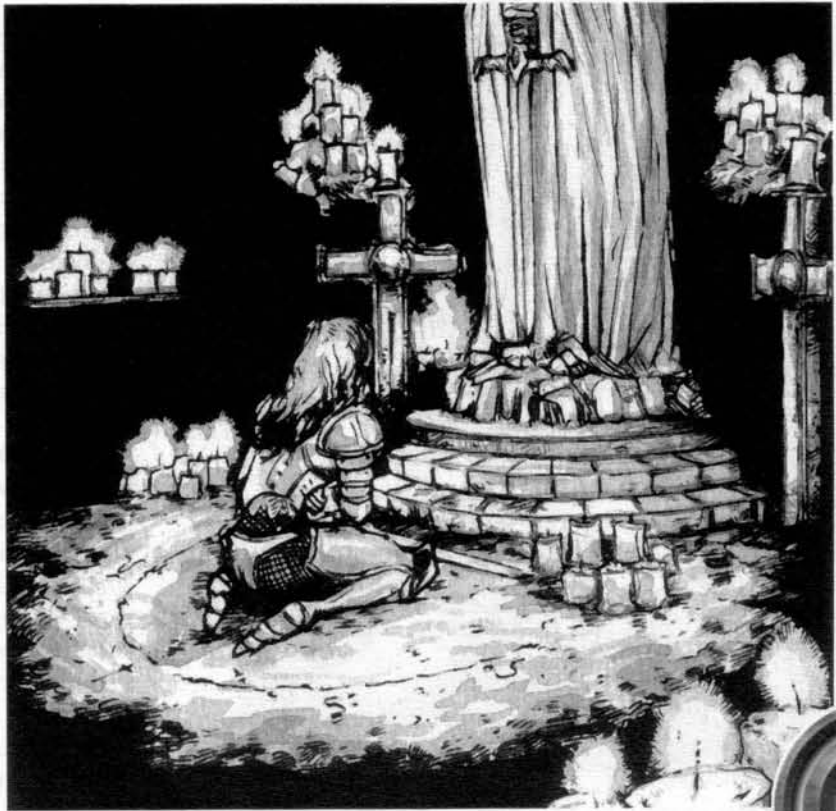



ILLONIS

Shrouded in mystery and plagued by a curse that has haunted them for more than a millennium, the illonis move from plane to plane on a seemingly hopeless quest. The illonis' plane of origin is unclear as is the reason they are doomed to wander the multiverse. Generations of rumors, hearsay, and tall tales have blurred the line between fact and fiction, even among the illonis themselves. It is thought that the illonis were once a proud race of traders and explorers who pioneered several methods of planar travel when the human race was still young. Intelligent and daring, the illonis traveled the multiverse, trading exotic goods across the infinite planes. Then the peaceful race incited the fury of a vengeful god.

Legend has it that the illonis elders cast a high priest of an evil deity into unknown planes during a confrontation in which the cleric attempted to steal the travelers' secrets. Enraged by the incident, the dark god laid a horrid curse on the illonis, dooming them to a life of misery as they were magically compelled to search the multiverse for the lost priest. They would never see their home plane again and never find lasting acceptance in the worlds they traveled.

Personality: The illonis are a determined race. Generations of wandering and seemingly pointless searching should have left them in despair. The torments of their cursed, unsettling appearance and strange afflictions should have robbed them of all hope long ago, but the illonis have persevered. Many other races do not understand what keeps the illonis going—their curse or the sheer determination of their unbreakable spirit? The illonis never give in to hopelessness and always find the strength to battle impossible odds. This is their nature.

Physical Description: The image of the race they once were is all but lost to the passage of time and the ravages of a cursed existence, and all illonis now face the challenges of finding a small measure of acceptance on the planes they visit. Illonis are humanoid creatures standing between six and six and a half feet tall, weighing an average of 155 pounds. They have thin gray skin spotted by black birthmarks that resemble the war branding of some barbarian tribes. Most illonis have deep gray or black hair

worn at varying lengths depending on the individual. Many, even the women, have recently taken to shaving their heads.

Illonis possess many of the standard humanoid characteristics: two arms, two legs, a mouth, nose, and ears. All of these features are reminiscent of the human or elven races but for two notable differences. First, illonis possess six long, triple-jointed digits on each hand, and this feature gives them remarkable talents with musical instruments. Secondly, illonis have no eyes but rather “see” with a strange form of echosense. Stories suggest the race was once known for its art and culture, hence the cruelty of the deity’s curse: With no eyes and no sense of color, the illonis’ artistic abilities are now almost entirely limited to music.

Most illonis take great care to hide their affliction from others, wearing blindfolds, deep hoods, or other coverings.

Alignment: Struggling to best the curse laid upon them and spite the vengeance of an angry deity, most illonis favor chaotic and neutral ways but still remain good spirited and tend to have a flair for heroics.

Illonis Lands: Illonis have no lands of their own and merely wander the countless lands of the other races. As ordained by the deity’s curse, illonis must wander the multiverse in search of the lost priest, and while most realize the priest is very unlikely to remain alive, the curse still haunts them and they must continue their hopeless search until their dying days. The curse is such that the race is bound to one plane for a century. When that time has passed, the illonis must leave for a new plane or the entire race will die.

On most planes, some of the illonis search for the lost priest, while others simply wander, aiding those in need and spreading their story until a century has passed. They resolve to spend their allotted time helping others rather than continuing a hopeless quest imposed on them by an evil god. Individual illonis may have no contact with others of their kind for decades, but as the century draws to a close, the survivors gather together to prepare for their journey to the next plane.

Religion: Hundreds of years of planar travel have transformed the illonis into an eclectic

race in terms of religion. With no knowledge of their original patron deities, many illonis choose a different patron deity on each plane they visit, choosing one who most closely embodies the illonis worldview or personal beliefs. Deities of music, freedom, art, and poetry are among those most commonly worshipped. Some illonis adventurers follow gods of fortune, travel, and knowledge.

While the illonis are not renowned for their religious devotion, illonis clerics can be among the most devoted, as they see faith and divine power as the only hope their race has to escape the terrible curse laid upon them.

Language: All illonis speak Common. However, after centuries of planar travel and exposure to hundreds of languages, the illonis possess the ability to learn any language their vocal anatomy will allow them to speak. Strangely, illonis have no language of their own: This is another artifact of their curse, as their native language has been lost after centuries of wandering the planes.

Names: As with most of their culture, illonis names have changed dramatically over centuries of planar wandering. There are no truly common illonis names, as they tend to vary from plane to plane. Naming customs are often adopted from countless different cultures and places. As a result, however, a knowledgeable illonis can often determine another’s age and

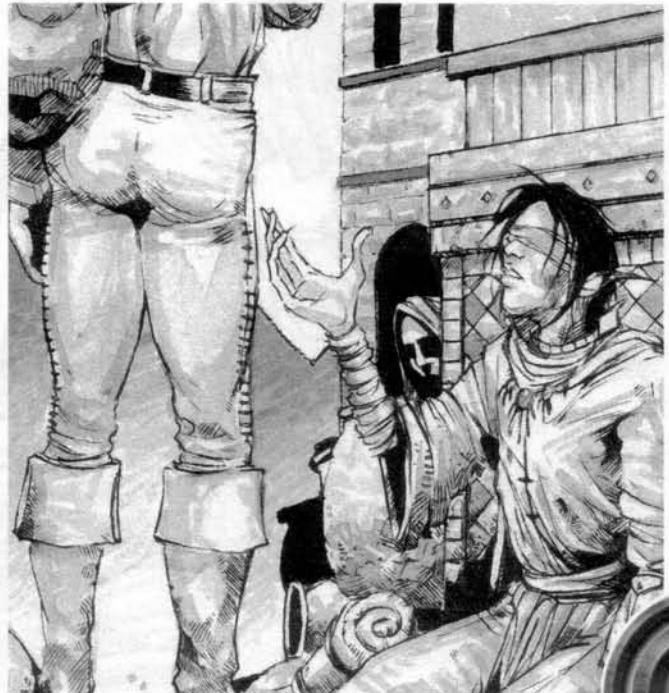

plane of origin by the name he bears.

Male Names: Yrasjin, Trask, Fillimon, Jesker, and William.

Female Names: Uulinia, Ewilous, Leeya, and Sareh.

Adventurers: Despite their curse—or perhaps because of it—illonis are often called down the path of adventure. Most illonis adventure with one of two goals in mind: to search for the lost priest responsible for their curse or to wander the realms giving aid to the weak and downtrodden. The illonis, possibly more than any other race, consider it an obligation to champion the lost causes of others and spread peace between different cultures and societies.

ILLONIS RACIAL TRAITS

- **+2 Dexterity, +2 Charisma, -2 Strength:** A lifetime of hiding their afflictions makes most illonis somewhat self-conscious, but many races view them as a unique and incredible people. Their slender, multi-jointed fingers give the illonis remarkable manual dexterity, but their slight frames make them less physically imposing than other races.



- **Medium-size:** As Medium-size creatures, illonis have no special bonuses or penalties due to their size.

- **Illonis base speed is 30 feet.**

- **Echosense:** The curse cost the illonis their eyes, and they now depend on a unique form of echolocation to sense their environment. Echosense works just like blindsight (see MM). Using this sense, illonis cannot distinguish textures, contrasts, or colors. As a result, illonis characters cannot read or write without magical aid. This limitation has motivated them to spread their story—and learn those of others—through an enduring oral tradition.

- **Ambidexterity:** As a naturally graceful and unusually coordinated race, illonis characters gain the Ambidexterity feat for free, even if they do not meet the prerequisite.

- **+2 racial bonus on Perform checks:** While the curse of the illonis has limited their artistic talents, they still possess an uncanny talent for the arts of music and storytelling.

- **Speak Language:** As a race of planar travelers, illonis have learned a wide variety of languages and have a natural aptitude for learning new ones. Illonis characters at 1st level gain one Speak Language skill for free in addition to any they choose individually.

- **Favored Class:** Bard. A multiclass illonis's bard class does not count when determining whether he suffers an XP penalty for multiclassing. With such a strong affinity for music and storytelling, a bard's life is ideal for an illonis.

- **Level Equivalent:** Class levels +1.

ELETI

The eleti (sing. eletum) are undead. They form no societies and rarely group together. Using disguise, stealth, and cunning they hide among the living for fear of destruction. The eleti look similar to skeletons. Unlike skeletons, eleti have independent minds and can learn and adapt. They seek to explore a world that would destroy them if it discovered their nature.

An eletum is an animate skeleton formed from the remains of a humanoid creature. An eletum gathers the necessary magical energy into one of its own bones over the course of a year. It then places the empowered bone within a skeletal corpse that becomes its "child." This process is somewhat uncomfortable for the parent but not really painful.

Eleti do not eat or sleep as a living creature does. They also do not grow old in any noticeable way and do not expire from age. Eleti are, in effect, immortal.

Personality: Eleti are envious of the ease with which living folk interact. Most want the life that is denied to them and to enjoy the diverse cultures they can only glimpse from the shadows. Eleti follow a spiritual path, attempting to attune themselves with their own magical energies. In this way they hope to gain more control over themselves and influence with the world around them. Most eleti go about this in one of three ways. These factions are seekers, judges, and slayers.

Seekers among the eleti strive to help other races and earn respect and trust from the living. Their goals in this effort are to make friends among living races and to help protect the welfare of others. They try to connect themselves to others and appease their sense of longing and separation.

Judges prefer to destroy the unworthy or unjust. Some eleti judges seek out evil undead to destroy. They hope to demonstrate their own independent nature and to differentiate themselves from the monsters they fight. Many others instead hunt the criminal and unjust elements of living society. By doing so, they feel that they contribute to the general welfare and create a place for themselves in the living world.



Eleti slayers see living races as enemies. Slayers operate alone as murderers or may raise armies of undead followers. They lash out at others and become universally feared, even among eleti. Slayers are the epitome of unliving vengeance.

Physical Description: These creatures appear as animate humanoid skeletons. Little flesh clings to their bones, and their joints are held together solely by magic. Their eyes come closest to seeming alive. They are normal eyes, typically green or blue, but sometimes brown. These eyes, set within sockets of a barren skull, mark their strangeness.

Eleti stand five to six feet tall and weigh 60 to 80 pounds. Eleti of small size are three to four feet tall and weigh 20 to 25 pounds. This weight is clearly more than bones, but it is unknown what adds to their weight.

Eleti dress to hide their appearance. They favor cold climates, where everyone wears many layers of cloth and fur. While around other races, they try to blend in by covering their faces with veils, masks, or hoods.

Relations: Eleti suffer from poor relations with other races. Living races are mistrustful of undead. Though they avoid betraying their undead nature, most eleti harbor no ill feelings toward others. Eleti earn no special treatment from other undead, so they understand the living races' mistrust. Due to their lack of acceptance, an eletum will develop a close friendship with living creatures that accept it. They have few friends, and those they have are dear.

Alignment: Eleti are independent creatures, given to no alignment. They may be malicious, kind, or lawless depending on their own nature. Eleti do not trust others enough to reveal themselves. Each is raised by its parent, taught how to move in the world and interact with

others. Because of this closeness, an eletum often has an alignment similar to its parent's.

Eleti Lands: Eleti control few lands. There is a risk in gathering. If they draw attention to themselves, they are hunted down. However, sometimes eleti will form societies far from the lands of the living. Requiring no food and feeling no discomfort from extreme environments, eleti can find safety in inhospitable cold or the heat of the deep desert.

When they gather, eleti are peaceful. They have no material needs and can avoid the conflicts over resources that other races confront. However, some eleti grow angry at the living races. Such eletum often become slayers, gathering armies and attacking the living. They attempt to exact revenge for imagined wrongs. Such attacks only feed the fear and mistrust humanoid races have for eleti.

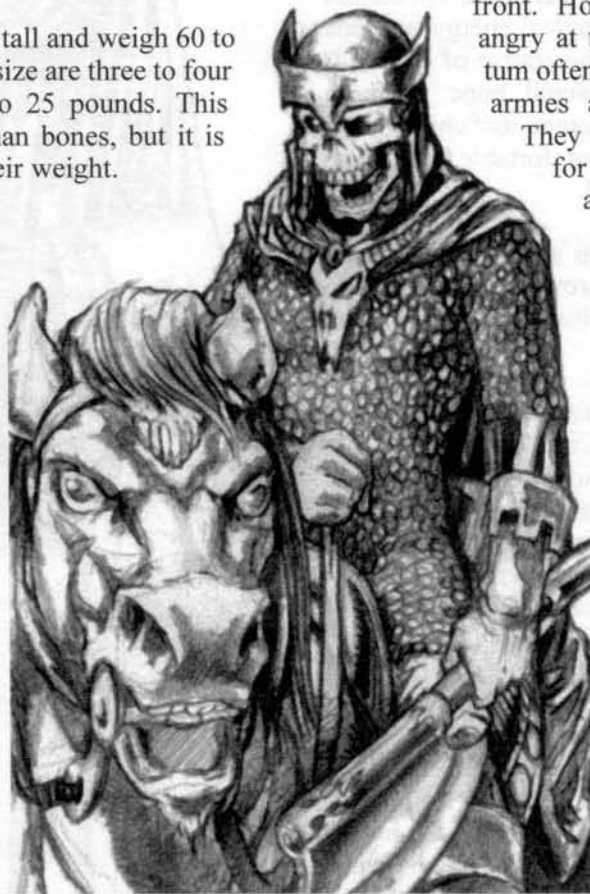

When moving through the lands of other creatures, eleti travel with caution. They use masks and disguises when possible and rely on stealth and cunning otherwise. Some eleti find friends among the living. Some people look past the undead face and see the good of which an eletum is capable. Other men of evil nature have no qualms about dealing with undead. Whatever the nature of the relationship, eleti rely upon living friends

to conduct business and help them hide from humanity.

Religion: Some eleti offer homage to gods of death, believing that they owe their existence to the beneficence of these gods. Others worship gods appropriate to their skills and interests. Followers of good-aligned deities are rare: These gods often show a vengeful aspect due to the ability of their priests to destroy undead.

Language: Eleti have no language of their own. They speak Common but may learn any other languages they choose. Despite the lack of a throat, eleti can speak clearly. Their voices sound human, though there is a subtle hollow ring to be distinguished by astute listeners.

Names: Eleti usually use only one name. Most use human names from the lands around them. Others use more guttural names from orc or other humanoid tribes. Few eleti use elven or dwarven names, because their intense mistrust of undead makes it difficult for eleti to remain near those races.

Adventurers: The lives of eleti are adventurous. Rarely able to stay in one place for long, they wander through barren or inhospitable lands to avoid the attention of those who would destroy them. Some eleti adventure to seek wealth and fame, believing that success will help others accept them. Others adventure to gain the power they need to exact revenge. Always alone among living men, eleti also adventure to seek allies or followers in common cause, whether that cause is good or evil.

ELETI RACIAL TRAITS

- **+2 Dexterity:** The magical nature that binds the eleti together gives them great speed and flexibility.
- **No Constitution:** Eleti are not living creatures and have no metabolism. They do not have a Constitution score, and as a result, eleti are immune to any effect that requires a Fortitude save unless the effect works on objects. A spellcasting eletum uses its Charisma modifier when making Concentration checks.
- **Medium or Small size:** Eleti may be of either Medium or Small size. They gain all the normal benefits and restrictions for their size.
- **Eleti base speed is 30 feet for Medium-size or 20 feet if they are Small.**
- **Darkvision:** Eleti can see up to 60 feet without any source of light. Darkvision is black and white only, but otherwise it functions just like normal sight.
- **+2 racial bonus on Hide and Move Silently checks.** Eleti are naturally adept at stealth.
- **Immunities:** Eleti are immune to cold damage and take only half damage from piercing or slashing weapons as they lack internal organs.
- **Undead:** As undead creatures, eleti are immune to mind-influencing effects, poison, sleep, paralysis, stunning, and disease. They are also not subject to critical hits, subdual damage, ability damage, ability drain, energy drain, or death from massive damage.
- **Turn and Rebuke Undead:** Eleti are subject to turning attempts by clerics and paladins. For purposes of turning, the eletum possesses a number of Hit Dice equal to its class levels. Turn and rebuke attempts have their normal effects on eleti. If a turn undead attempt would normally destroy an undead of the eletum's level outright, it receives a Will saving throw (DC 10 + cleric's class level + cleric's Charisma modifier). If the save fails, the eletum is destroyed. Even if the save succeeds, the eletum is still subjected to the turn effect.
- **Command Undead:** Successful command undead attempts allow the eletum a Will save (DC 10 + cleric's class level + cleric's Charisma modifier). If the Will save fails, the cleric may control the eletum as if by a *dominate person* spell. If the save succeeds, the eletum is able to retain control, though it is still affected as if by *charm person*.
- **Turn Resistance:** Eleti may gain Turn Resistance as a general feat whenever they are allowed to learn a new feat.
- **Automatic Languages:** Common. Bonus Languages: Any (other than secret languages, such as Druidic). Eleti may encounter any sorts of creatures during their travels and often learn to speak a broad variety of languages.
- **Favored Class: Fighter.** A multiclass eletum's fighter class does not count when determining whether it suffers an XP penalty for multiclassing.
- **Level Equivalent:** Class levels +3.

RHOODE

The rhoode work as capable servants to the rhonians (see *Mythic Races*, page 108-114) and other masters who depend on an autonomous, subservient labor class to maintain their society. Their sturdy, toadlike bodies make them ideal for a variety of mundane tasks for which their lords have little time: housework, farming, construction, crafting, and general labor. Their squat build also helps make them innocuous despite their ubiquitous presence in communities that rely on rhoode labor. Many accompany their masters in their wanderings and foreign duties. Although they openly serve their lieges efficiently and loyally, rhoode often harbor some hidden degree of callous resentment.

Personality: The general rhoode personality displays two facets, one servile facade in public, and one more boastful, cranky demeanor among themselves.

When in their masters' presence or among strangers, rhoode play the part of the humble, busy servant. They rush about trying to execute every last order even as it's uttered. They dutifully run errands, work tirelessly at their manual labor, and honestly administer the petty domestic and professional domains their lords entrust to them. Rhoode wear a face of complicit obedience, a neutral expression that never reveals their true opinion of their masters' wishes. They show no emotion in public; they do not smile, cry, or laugh aloud. Rhoode speak only when initially addressed, remain quiet in their work, and refrain from complaining about their lot in life. In return for their service they expect to enjoy the high standard of living their masters provide.

In private, however, the rhoode are a vulgar bunch, disrespectful of authority, critical of their masters, and weary of their servitude. Gather a crowd of rhoode in the kitchen corner when chores are done and one hears complaints, sob stories, vile jokes, and sarcastic voices mocking their lords. They secretly hate everything that isn't of their own doing and hold others in quiet contempt.

Despite this deep-seated discontent with their station in society and a perpetual infe-

rriority complex, rhoode cannot rouse themselves from their servile state. Although they excel at whining about things, they're not very organized or dedicated to improving their lot. They'd rather sit about during off hours complaining than band together and rebel against their masters—that would entail taking responsibility for the manner in which they ran society, and that's far more work and trouble than the average rhoode wants. Rumors claim the rhoode once rose up against their rhonian lords, only to founder without the wealth, leadership, and determination of society's upper echelons.

Physical Description: Since rhoode descend from swamp-bound amphibians, they share many physical characteristics with toads. Their bodies combine the stocky elements of head and torso with more gracefully lengthened limbs. Bulging eyes rise from their broad heads on short stalks. Two nostrils sit above wide, slit mouths that nearly bisect their heads. Elongated arms sprout from their hunched shoulders, while sinewy legs double up beneath their squat torsos. Their hands and feet have vestigial webs between their digits, making rhoode exceptional swimmers. Rhooedes' hairless bodies often display coloration well adapted to their environments: mottled browns and subtle greens, often accentuated with yellow patches or red streaks. They stand between three and four feet tall and weigh 50 to 75 pounds. Most rhoode reach maturity at 15 years, and live as long as 50 or 60 years.

Their masters often restrict rhoode to wearing plain clothes suitable for servants. Colors and styles often reflect their lords' tastes or cultural heritage. Those who accompany their liege on business abroad often receive special dispensation to wear light armor and carry a simple weapon in case they must defend their master and his property.

Relations: Rhoode appear subservient to all non-rhoode, especially those in their masters' company. They obey all requests but resent those that entail a great amount of work. Among themselves they judge others based on their kindnesses and requests. Those who assume rhoode must serve them as well they serve their masters gain the creatures' contempt, while others who view them as worthy individuals earn the rhoode's mutual respect. Rhoode become particularly fond of those who reward them well for their efforts or who

attempt to treat them as equals—a situation that often irks their masters but rarely prompts reprisals. Most societies frown upon beating servants and rhoode in particular.

Alignment: Rhoode tend toward neutrality. During generations of servitude they have adapted to both strict order of routine and society (a lawful trait) and the appearance of various unanticipated developments that naturally plague a servant's life (a trait common to chaos). This balance also reflects their station in life. Rhoode dislike their servile status but aren't ambitious enough to do anything to really change it.

Rhoode Lands: In the ancient past, before the rhonians bound them to servitude, the rhoode inhabited numerous small villages scattered throughout a vast swamp. Although their civilization developed quite well on its own, they could never tolerate working together to forge a single kingdom. After the rhonians incorporated them into their own society, the rhoode forgot many elements of their own original culture and adapted to their masters' society.

Rhoode now inhabit the locales and kingdoms their masters call home. Many labor in the rhonian marsh enclaves or accompany rhonian envoys on diplomatic missions. Those serving others make their homes in their lords' lands. Rhoode first emerged from the swamps, so they have a natural affinity to work for those who live in marshlands and forests. Arid climates do not agree with rhoode, but they tolerate these regions with the usual amount of grumbling to themselves.

Religion: Rhoode subscribe to a variety of religious beliefs, often dependent on their masters and duties. In many cases they follow the same religion as their lords, partly as an open show of respect, but mostly for convenience. Some masters require rhoode assistance in performing holy ceremonies, so the servants find sharing the same beliefs expedient.

Many rhoode believe in neutral deities who reflect their role in society. Domestic servants often place their faith in

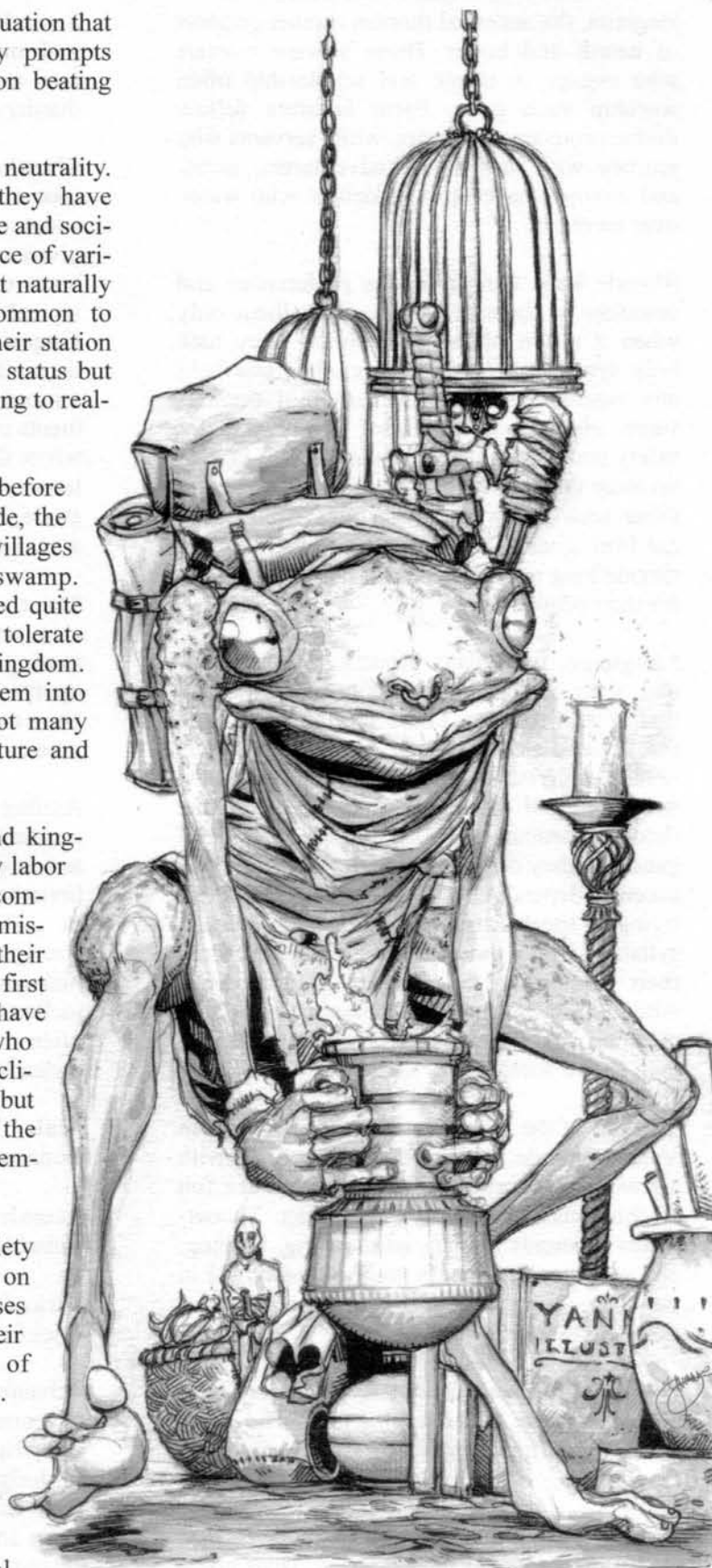

Hegretta, the ancestral rhonian mother goddess of hearth and home. Those serving masters who engage in magic and scholarship often worship such gods. Farm laborers follow divine protectors of nature, while servants who journey with their lords (adventurers, sages, and envoys) have faith in deities who watch over travelers.

Rhoode keep their religious preferences and practices to themselves, revealing them only when it might please their lords. They tuck holy symbols beneath their clothes and hold any ceremonies in the seclusion of the servants' quarters. If they utter any prayers for safety and endurance in public, they're kept to no more than a grumble or whisper. One might think such overworked creatures would seek aid from gods of discontent and rebellion, but rhoode long ago learned such deities care little for their plight.

Language: Like many aspects of rhoode culture, their own language has been usurped by that of their masters. Those serving elves learn the Elven dialects; rhoode working for dwarf nobles understand Dwarven. Their wide jaw structures and fat tongues do not allow the rhoode to articulate any language in its full elegance, so they often speak with various clumsy accents (depending on the language). Rhoode trying to speak Elven vary their pitch on each syllable, while those forcing Common from their mouths often elongate their vowels. Although they can still communicate their meaning, rhoode sound more like village idiots than native speakers.

Vestiges of the rhoode home-tongue remain in Vulgar Rhoode, a singsong tongue filled with sarcasm and mimicry, often used to make fun of their masters behind their backs. To outsiders it sounds like casual croaking, burping, and yakking. Rhoode do not use this tongue in public, reserving it expressly for communication among their own kind.

All rhoode speak Rhonian, Common, and Vulgar Rhoode. Those serving lords who speak a different primary language are also fluent in that tongue.

Names: Like their language, rhoode names reflect the whims of their masters. Their given names often echo their duties: Cutter, Ink-Fingers, Tanner, Thimble, Wet-Hands.

Some lords deign to distinguish their servants with more elegant names typical of their culture, a vain attempt at treating them with the dignity accorded to others in society.

Rhoode do not have family names. Instead they take a surname based on their liege. Some adopt one of his names, either his title or a given or clan name. Cutter Dawnsfire combines the rhoode servant name Cutter with a typical rhonian first name, Dawnsfire. Ink-Fingers Judge probably works as a secretary for a village justice. Sometimes rhoode receive a more elaborate last name incorporating elements of their master's domain or the location where they work: Wet-Hands of House Navene labors for the Navene family, probably on their estate; Tanner of the Brown Yard might work in a mud-walled courtyard.

These various combinations—plus sometimes-awkward given names—do not make for the most graceful-sounding names. Rhoode gave up trying to find pride in their names long ago. Now they just accept whatever names they're given.

Among themselves the rhoode keep "secret" nicknames that mirror their true personalities and objectives. One who listens carefully to household gossip and informs his peers might be called "Scuttlebutt." A rhoode who constantly mooches from the larder could earn the nickname "Skimmer." Individuals keep these nicknames from other non-rhoode, as they often reveal their actual disposition lurking beneath their subservient exterior.

Male Names: Cutter, Fieldling, Mortar, Runner, Scriber, Stonewall, Tanner, Trudgeon.

Female Names: Ink-Fingers, Mapper, Thimble, Weaver, Wet-Hands.

Nicknames: Blabber, Nibbler, Nimblepurse, Prickfinger, Scuttlebutt, Skimmer, Slipsilver.

Adventurers: Rhoode leave their home on adventures to accompany their lords. They carry baggage, cook meals, make arrangements for lodging, and deal with undesirables beneath their masters' station. Rhoode even take up arms to defend their lieges. Everything an adventuring rhoode does caters to his self-interest. If one's lord is satisfied, he provides all a servant needs to live, often with rewards

for good service. A gracious master even shares a portion of treasure with his servant.

Adventurous rhoode view travel as a means to learn about their world and find opportunities for gain within it. In the open a servant may kowtow to his master, obeying his every wish. When left alone, however, he often schemes for his own personal gain, making deals on the side and pursuing prospects for greater wealth.

Rhoode should find an appropriate character within the party whom they serve. This indentured servitude has obligations for both master and servant—the lord agrees to provide for and protect his faithful rhoode, while the servant pledges obedience and labor to the liege. In rare cases where nobody else in the party agrees to take a servant, the rhoode attaches himself to the most likely candidate (often a wealthy or seemingly authoritative character) and serves this person as if they truly had a master-servant arrangement.

RHOODE RACIAL TRAITS

- +2 Dexterity, +2 Constitution, -2 Intelligence, -2 Wisdom: Rhoode are nimble and durable workers, but rely more on their masters' intellect and common sense.
- Small: As Small creatures, rhoode gain a +1 size bonus to Armor Class, a +1 size bonus on attack rolls, and a +4 size bonus on Hide checks, but they must use smaller weapons than humans use, and their lifting and carrying limits are three-quarters of those of Medium-size characters.
- +2 racial bonus to Bluff, Forgery, Gather Information, Innuendo, Listen, and Move Silently checks: Generations of servitude have ingrained in rhoode a knack for certain skills useful for those laboring as a subordinate caste in society.
- +2 racial bonus to Swim checks: As descendants of amphibians, rhoode still retain a natural affinity for water and are able to navi-

gate it with ease.

- -2 penalty for others using Sense Motive to read a rhoode's expressions or interpret the tone of a rhoode's voice. This also applies to Gather Information checks that rely on reading body language for verifying facts. Others have difficulty trying to see beneath rhoodes' neutral expressions and demeanor—as servants they conceal their emotions from their masters and strangers.
- +2 racial bonus to Craft: This bonus reflects experience rhoode gained from service in a particular chore. At the time of creation, a rhoode character should select a specific craft in which he focused as part of his servile labor.
- Automatic Languages: Common, Rhonian, and Vulgar Rhoode. Bonus languages: Dwarven, Elven, Gnome, Giant, and Orc. Rhoode quickly adapt to the language used by their masters and in the labor communities in which they work.

- Favored Class: Rogue. A rhoode's rogue class does not count when determining whether he suffers a multiclassing XP penalty. Masters frown upon their servants pursuing their own careers, but the rogue class allows rhoode to attain their goals in secret without openly offending their lords.

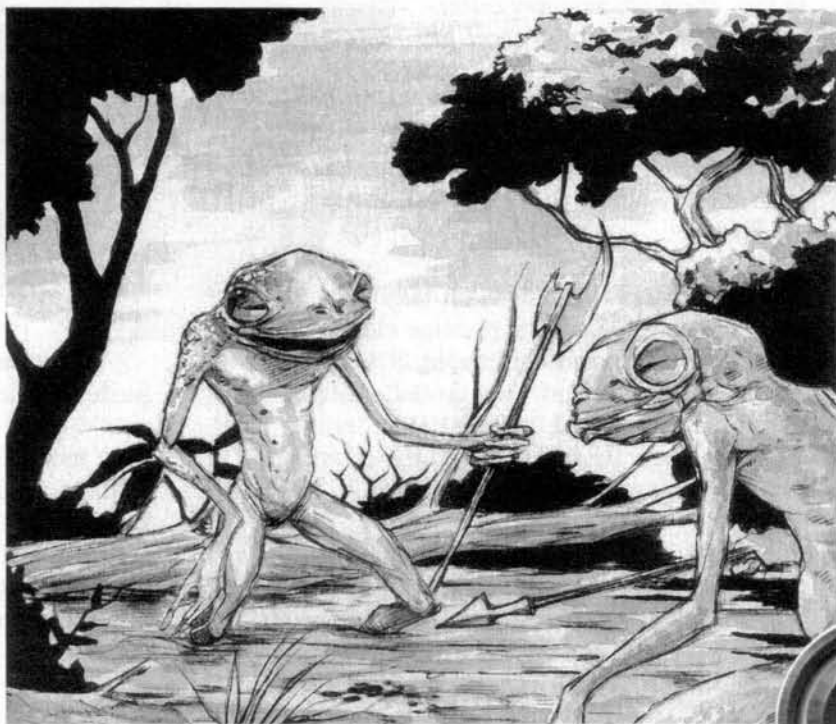

PATH OF THE SWORD

Fighting classes represent the heroes we all grew up with. They are the brave warrior, the determined hunter, the unstoppable barbarian, the dextrous swordsman, the keen-eyed archer, the wise martial artist.

In fact, there are as many different kinds of fighters as there are personalities. Core feats and classes are wonderful tools in d20 system roleplaying to develop such fighters, but for those who want even more we proudly offer *Path of the Sword*.

The book offers expansions on familiar game elements like feats, prestige classes, and weapons and equipment. It even provides organization backgrounds that will help GMs and players alike with adapting a new prestige class to the campaign. But it doesn't stop there.

Legendary classes are one highlight for those characters deserving of such renown. If you'd rather play your chosen path from the beginning but can't get there with the core rules, try out our variant classes: alternative core

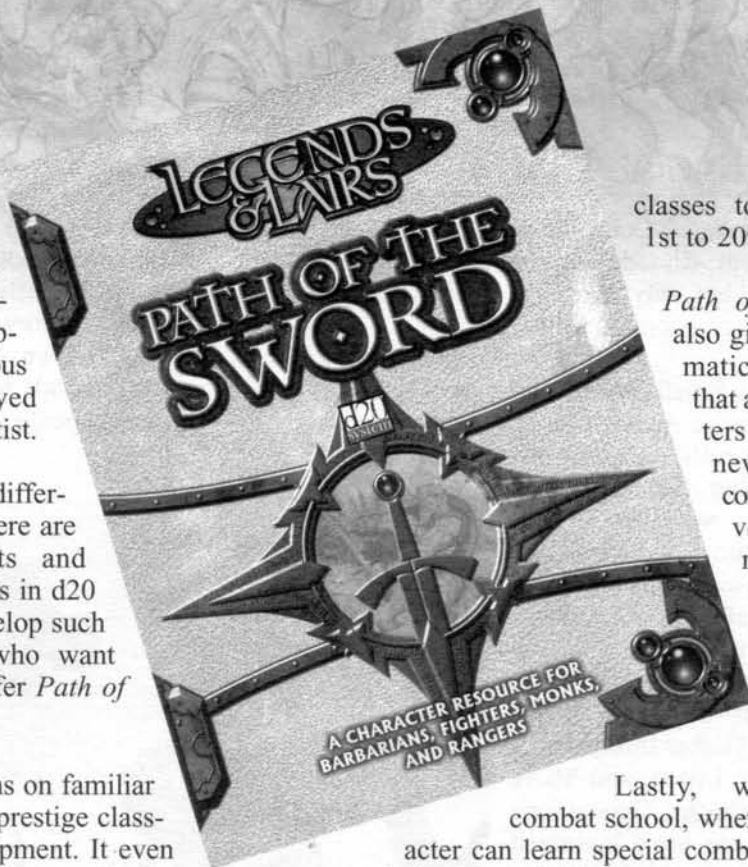

classes to take from 1st to 20th level.

Path of the Sword also gives you dramatic new rules that allow characters to perform new acrobatic combat maneuvers and mounted combat maneuvers without having to spend feats.

Lastly, welcome to combat school, where your character can learn special combat tricks that push the rules whichever way you want them.

The names of classes, feats, skills, combat schools, equipment, and any rules or game mechanics derived from the d20 System Reference Document are considered **Open Game Content**. All other text is considered closed content.

PRESTIGE CLASS

DRAGON WARRIOR

The draconic races have been mixing their blood with that of lesser races for ages beyond counting. It's said that almost any thinking race has at least a trickle of draconic blood in it, for the ability to tear forth magic from the universe and shape it at will has been found in nearly every species—sometimes as rarely as once in a millennia, but it has almost always been found. For as long as there have been those who use their tainted blood to wield arcane might, there have been those who foreswore that path, and chose another. Only recently, however, have the dragons taken notice of these prodigal children and turned them into pieces in their game.

The first dragon warrior was Aedel Morivan, and the blood of the red dragons was in his heart, though he did not know it for most of his life. He was a man of fury, and chaos, and power, and it is said that even when he had not fought in days, blood would pool where his feet

left marks upon the earth. One day, standing in a smoking slurry of ash, blood, and bones which had once been a town, an old man approached him. Aedel turned to cut him down, but something held him back. He lowered his blade and watched.

The two studied one other. Then the old man spoke. "You are great, but you could be far greater. You shall be far more than any of my other children." There was a roar of sound and flame, and both Aedel and the man vanished.

A year later, Aedel returned. His naked skin turned back blades and his breath turned wood to ash, and when wizards tried to take him down, he caught their spells and hurled them back, laughing at the astonishment that was seared into their faces as they died. For another year, he rampaged without any purpose but to destroy, and then, at the same place where he had met his father, another warrior came to challenge him.

"I am Edallin, and I am of the gold," said the challenger as both charged into battle. Neither survived that fight, but the opening moves in a centuries-long game had been made. All that remained was for all the players to choose their pieces.

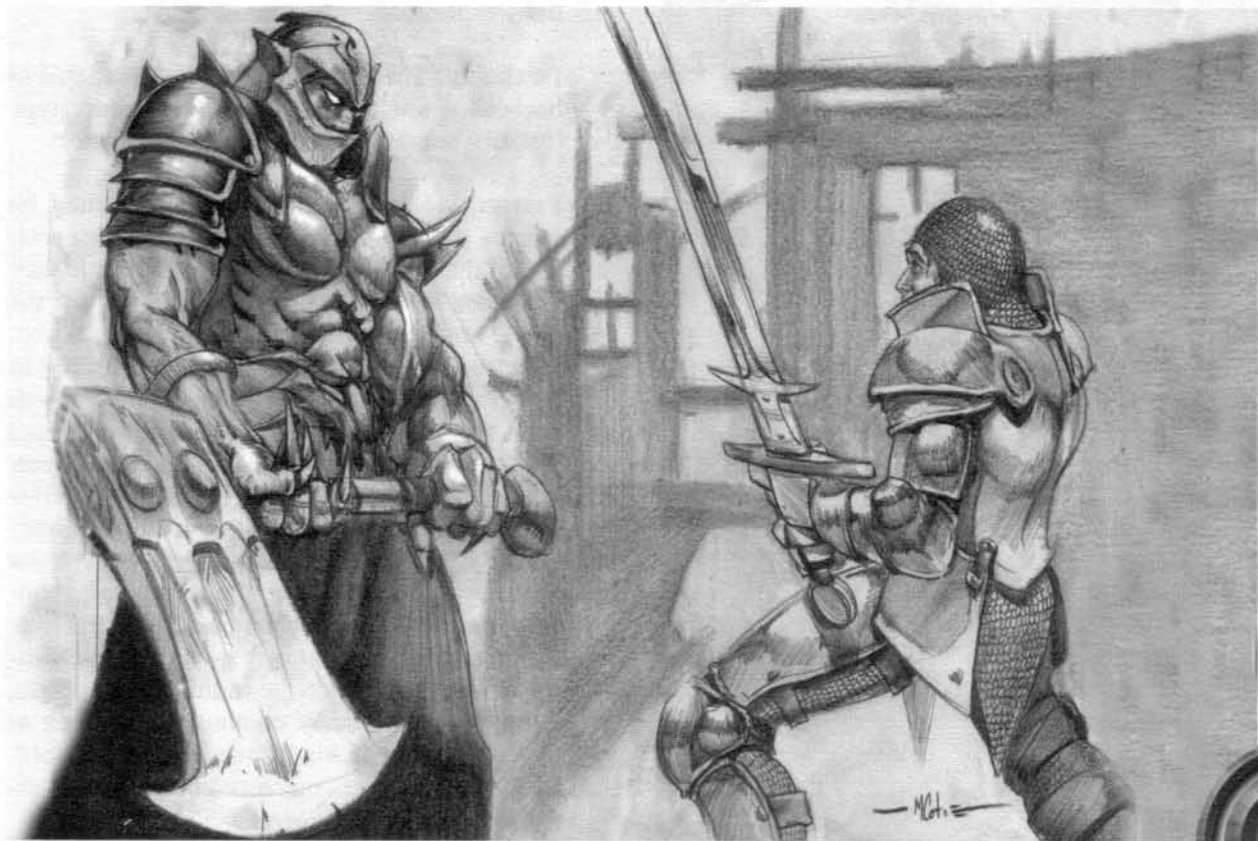



Hit Die: d12.

REQUIREMENTS

To become a dragon warrior, a character must fulfill the following requirements.

Base Attack Bonus: +4.

Alignment: Chaotic good or chaotic evil.

Feats: Power Attack, Toughness.

Special: Ability to rage. Ability to cast arcane spells spontaneously. Must be recruited by a dragon.

CLASS SKILLS

The dragon warrior's class skills (and the key ability for each skill) are Climb (Str), Concentration (Con), Craft (Int), Intimidate (Cha), Intuit Direction (Wis), Jump (Str), Listen (Wis), Ride (Dex), and Swim (Str).

Skill Points at Each Level: 2 + Int modifier.

CLASS FEATURES

The following are class features of the dragon warrior prestige class.

Weapon and Armor Proficiency: Dragon warriors are proficient with all simple and martial weapons, all armor, and shields.

Drakekin: The dragon warrior is considered to be both a dragon and his base creature type (usually humanoid) for all purposes.

Patron: When a dragon warrior is recruited, he gains a patron—a dragon that is a distant relative of the character. The type of dragon is very important, and should be decided on by the player and DM before this class is chosen. (Alternatively, a player may express interest in this class, and have the DM surprise him with what type of dragonblood flows in his veins.) The patron will rarely, if ever, interfere directly in the life of the warrior; the dragon warrior serves the dragon, not vice-versa! Still, a particularly loyal and skilled warrior might make a small request for aid, or might receive a spontaneous gift of a minor magic item or the like. Other agents of the same dragon might be willing to help him. Once the training is complete, a dragon warrior may continue to advance in this class even if his patron is dead. Indeed, there are three cases on record of a dragon warrior slaying his own patron.

DRAGON WARRIOR

Level	Base Attack	Save	Fort Save	Ref Save	Will Special	
1	+1		+2	+0	+0	Drakekin, patron, rage ability
2	+2		+3	+0	+0	Slashing rage, wyrm tongue
3	+3		+3	+1	+1	Drakefoe +1
4	+4		+4	+1	+1	Elemental resistance
5	+5		+4	+1	+1	Spellrage
6	+6		+5	+2	+2	Drakefoe +2
7	+7		+5	+2	+2	Armored rage
8	+8		+6	+2	+2	Burning rage
9	+9		+6	+3	+3	Drakefoe +3
10	+10		+7	+3	+3	Winged rage

Rage Ability: Beginning at 1st level, the dragon warrior advances his rage abilities as if he had gained a level in barbarian. In effect, his barbarian levels and dragon warrior levels stack when determining these abilities.

Wyrm tongue: At 2nd level, the dragon warrior learns to speak Draconic.

Slashing Rage: Starting at 3rd level, the character's hands become claws and his teeth become fangs when he rages. These are now considered natural weapons, his claws attacking at his highest base attack bonus and his bite at his second highest. The damage dealt depends on the dragon warrior's size, as shown on the following chart.

Size	Claw	Bite
Small	1d3	1d4
Medium-size	1d4	1d6
Large	1d6	1d8

Drakefoe: Against dragons (or dragon warriors) of the opposite alignment (on the good/evil axis) of their patron, dragon warriors gain a +1 bonus to attack and damage rolls. This increases to +2 at 6th level and +3 at 9th level.

Elemental Resistance: At 4th level, the dragon warrior gains elemental resistance 15 versus the element of his patron (fire for red, electricity for blue, and so on).

Spellrage: Beginning at 5th level, the dragon warrior gains the ability to extend his rage by

sacrificing stored arcane energy. As a free action, the dragon warrior may sacrifice one or more spell slots to extend his rage for a number of rounds equal to the total number of spell levels sacrificed.

Armored Rage: Beginning at 7th level, the dragon warrior gains damage reduction 2/- when raging.

Burning Rage*: Starting at 8th level, the dragon warrior gains a breath weapon when raging. This weapon can be used once per rage, deals 1d8 points of damage per point of Constitution modifier, and has additional characteristics based on the chart below.

*This ability is renamed according to the dragon type—Freezing Rage, Caustic Rage, Shocking Rage, and so on.

Color	Breath Weapon	DC
Black	Line* of acid	17
Blue	Line of lightning	18
Green	Cone** of acidic gas	17
Red	Cone of fire	19
White	Cone of cold	16
Brass	Line of fire	17
Bronze	Line of lightning	18
Copper	Line of acid	17
Gold	Cone of fire	20
Silver	Cone of cold	18

*A line is always 5 ft. high, 5 ft. wide, and 60 ft. long.

**A cone is always 30 ft. long.

Winged Rage: When raging, the dragon

warrior grows wings (the dragon warrior must have his armor customized, costing 300 gp, otherwise this ability deals him 2d6 points of damage each time it is activated). These wings allow the character to fly at his normal movement speed with average maneuverability.

Ex-Dragon Warriors: Should a dragon warrior ever become lawful, he can no longer rage, and loses all rage-related abilities. Lawful characters may not gain levels as a dragon warrior, even if their patron dragon is lawful—a dragon warrior embodies the raw fury that is in the secret heart of even the most benign and disciplined of dragons.

ORGANIZATION:

BROOD OF VERTHAXIS

PURPOSE

The Brood exists only to serve the whimsical and self-serving interests of its patron, the red wyrm Verthaxis, whatever they may be.

LEADER

Arrixaka (CE human female Bar9/Sor2/Drw9)

CURRENT ACTIVITIES

For reasons few can guess, dragons have always taken an interest in humanoid species, particularly humans. This interest takes many forms, including the desire to sire children upon humanoids. These children show the marks of their draconic ancestor to varying degrees, but the ability to cast spontaneous magic is one of the surest signs. Denigrated by many wizards as freaks, the descendants of dragons are rare and misunderstood—and often feared. It is this fear that the powerful red dragon Verthaxis wished to harness when he organized his Brood.

The Brood of Verthaxis is a small but dangerous cult totally dedicated to the wishes of Verthaxis, one of the most destructively evil and immensely self-absorbed dragons in living memory. Verthaxis understood, as all dragons do, that humanoids descended from him possessed powers and abilities beyond those of their fellows. Yet, Verthaxis was one of the first to recognize that those powers could be

harnessed toward ends other than simple spell casting. Indeed, he believed he had found the means to encourage his “children” to develop further along the path of dragon-kind than was considered possible, all the while serving his evil ends.

Verthaxis gathered together the strongest and most powerful of his descendants and revealed himself to them. He inculcated them in a philosophy of evil and showed them that strength came through fear and destruction. He encouraged them to turn on each other and to show no mercy and give no quarter. He watched as his children slowly destroyed one another, separating the wheat from the chaff until finally only a few remained. These, Verthaxis decided, were his true children; they were his Brood. They were as like him as any humanoid could be and he would teach them so much more, so that they too might become creatures of unremitting destruction and thoroughgoing evil.

The plan of Verthaxis worked all too well. In short order, his surviving children began to show their draconic heritage even more strongly. Bit by bit, they began to exhibit further powers and abilities to distinguish themselves from ordinary mortals. The more they served Verthaxis, the more they performed according to his will, the stronger they became. It was as if they could transcend their humanoid forms by behaving more like the bestial creature that was their sire.

The Brood of Verthaxis now act as the great wyrm’s personal agents. They travel about the countryside on missions that serve their master’s interests, whatever they happen to be at a given time. Most often, they rain random destruction down on anyone who dares to enter the dragon’s domain. At other times, they seek out would-be slayers of Verthaxis and destroy them before they have the opportunity to try. The Brood also makes war upon the children of other dragons, some of whom show characteristics similar to their own. Verthaxis seems convinced that he too can gain greater power by indulging in his basest instincts. He uses the Brood to advance his own ascension toward “perfection” and would willingly sacrifice them to achieve that insane end. For now, the Brood remains his good right arm and the instrument of his evil.

NEW RULES:

MOUNTED COMBAT

These maneuvers do not necessarily require feats to use. They are meant to present more combat options to characters based on their existing skills rather than enhancing a character's overall abilities.

CATCHING PREY

Prerequisites: Aerial mount, Trample feat.

Benefit: When performing a trample on an opponent from an aerial mount, a character may decide to grab the opponent instead of dealing damage, provided the mount has claws or arms. On a successful trample, the mount makes a grapple check with a +4 bonus to the attempt. This does not provoke an attack of opportunity. Afterwards, the mount may continue its movement for that round. Opponents suffer no damage from being grappled, but a dropped opponent suffers 1d6 points of damage for every 10 feet fallen.

Drawback: A mount can only attempt this maneuver against an opponent at least two size categories smaller than it.

CHARGED JUMP

Prerequisites: Ride 5 ranks.

Benefit: If an experienced rider's mount makes a full double move in a straight line before attempting a jump, the rider can make a Ride check (DC 10) to aid the mount's Jump check (see cooperating in the core rules, PHB 62).

COAX THE BEAST

Prerequisite: Ride 5 ranks

Benefit: An experienced rider can push a mount to run even after it is exhausted. By making a successful Ride check (DC 20 + number of previous checks) the character can delay one point of Constitution damage to his mount from pushing its movement. This does not actually negate the damage, but delays it until the rider and mount stop. Once stopped, the horse takes all of the Constitution damage at once, often killing the mount on the spot. A rider can only coax the beast one time for every three Constitution points



PATH OF THE SWORN

the mount has. After this point, the mount begins losing Constitution at a rate of one point per minute until it has reached its total current ability damage, at which time it collapses.

DEFT DODGING

Prerequisites: Mounted Combat, Ride 5 ranks.

Benefit: By focusing on dodging opponents and defensive maneuvers, the character grants both he and his mount a bonus to AC. If both he and his mount perform nothing but a single move in a round, the mount gains a +4 dodge bonus to AC and the rider gains a +2 dodge bonus to AC.

DIVING ASSAULT

Prerequisites: Aerial mount, Ride 5 ranks, Ride-By Attack.

Benefit: When performing a diving assault, an aerial mount flies straight down to an opponent to make an attack. The mount gains a +4 bonus to its attack roll that round.

Drawback: The rider must spend his full effort controlling the mount and may not attack until the next round.

HIT AND RUN

Prerequisites: Ride 10 ranks, Ride-By Attack.

Benefits: The mounted character can make an attack against any adjacent enemy that he approached in the previous round and then move away without suffering an attack of opportunity.

Drawback: Due to the haste of the attack, the character suffers a -1 penalty on his attack roll.

JUMPING ON HORSEBACK

Prerequisites: Ride 8 ranks, Balance 8 ranks, Dex 15+.

Benefit: A character can stand and jump while on horseback to avoid low obstacles that might otherwise unseat her. This requires a successful Balance check (DC 20). Failure indicates that the character slipped, taking 1d6 points of physical damage, 1d6 points of subdual damage, and falling prone.

LASSO AND DRAG

Prerequisites: Ride 5 ranks, Strength

13+, Use Rope 5 ranks.

Benefits: As a standard melee attack, a character can try to lasso and drag an opponent with a rope. It takes a full round action and a successful Use Rope check (DC 15) to prepare the lasso for the attack. An opponent hit by a lasso can shed it as a move-equivalent action any time before the knot is secured; once secured it requires a full round action and an Escape Artist check (DC 20) to release. The rope can be burst with a Strength check (DC 23). In order to secure the lasso, the character that threw it must make a Use Rope check (DC 15). If this check fails, the lasso comes loose and falls to the ground harmlessly. If it succeeds, the knot tightens and the lasso grapples the target, pinning him.

If the character's mount continues to move, he must make a Strength check (DC 15) or be yanked off his horse. A stock saddle adds a +2 circumstance bonus to this check. The pinned opponent is dragged behind the horse, taking 1d6 points of subdual damage per round until he escapes.



LEAPING ONTO YOUR HORSE

Prerequisites: Ride 5 ranks, Jump 5 ranks, Dex 13+.

Benefit: A character can leap from a 20-foot height or less into the saddle of his horse without damage to him or the animal. Characters must make a successful Ride check (DC 20) in order to land safely and avoid spooking the animal. On a failed check, the character and the horse both take 1d6 points of damage and the animal spooks. The character's armor check penalty, if any, does apply to this roll.

RIDER'S LEAP

Prerequisites: Dexterity 13+, Ride 8 ranks.

Benefit: The character can combine riding skill, agility, and a bit of luck to manage to jump onto a horse (or any other animal the character can ride) that is both in motion and being ridden by another character. To do this, he must get to within 5 ft. of the target animal and on an elevation at least equal to the target mount's back. This can be accomplished by riding next to it, by leaping from a branch as it passes underneath, or any other such means.

The character then makes a Jump check (DC 15). If the check succeeds, the character is now perched on the target animal, behind the current rider. It is possible to attack the rider from this position, using any weapon that could be used in a grapple. The rider does not gain his Dexterity bonus to AC and may not use a shield. Either rider can make an opposed Ride check as a standard action to attempt to unseat the other. If a defender loses this check, he falls from the mount, taking damage as appropriate.

SIDESWIPE

Prerequisites: Ride 8 ranks, Ride-By Attack.

Benefit: A mounted character can try to knock over a smaller creature by slamming into it from the side as a part of the movement action. To perform a sideswipe, the mount makes a melee touch attack against an opponent that is at least one size category smaller. If the touch attack succeeds, the mount and target must make opposed Strength checks. If the mount wins, the target falls to the ground and takes 1d6 points of subdual damage. If the target wins, the mount fails to knock the target down and takes 1d6 points of subdual damage.

Drawback: The character must make a Ride check (DC 20) or the mount stops moving for the round. If this check succeeds, the mount

can finish its move normally.

SNATCH AND GO

Prerequisites: Dexterity 13+, Ride 8 ranks.

Benefit: As a standard action, a character can lean over the side of a moving mount and pick something up. If the object is on the ground, the rider must make an unarmed attack against AC 10. If the character attempts to grab an object or weapon from an opponent's hand, he must make a standard disarm attempt, except the opponent has a -4 penalty to his attack of opportunity. If this attempt fails, the opponent does not get the opportunity to disarm the character.

Drawback: The character cannot have any weapons drawn when performing the snatch.

SPINNING KICK

Prerequisites: Ride 8 ranks.

Benefit: A four-legged mount can make this attack in any round in which it moved 5 ft. or less. The mount spins around and lashes out with its rear legs, causing tremendous damage to anything struck. The attack deals 2d6 points of damage plus one and a half times the mount's Strength bonus. Any target of this attack must also make a Strength check (DC 5 + the damage inflicted) or be pushed 5 ft. back and knocked to the ground.

Drawback: The mount's rider may not attack during a round in which his mount performs a spinning kick, and he must make a Balance check (DC 10) or fall off the mount.

STRADDLING TWO HORSES

Prerequisites: Ride 8 ranks, Balance 8 ranks, Dex 15+.

Benefit: A character can straddle two horses and control them simultaneously. This maneuver can also be used to bring harnessed animals to a stop, or to help control a horse whose rider has been incapacitated. This maneuver requires two horses of roughly the same size (two light warhorses, two riding horses, etc.). In order to straddle two horses, the character must make a successful Ride check (DC 20). Failure indicates that he is unable to control the horses and falls prone, taking 1d6 points of both normal and subdual damage.

SWITCHING HORSES IN MID-GALLOP

Prerequisites: Ride 8 ranks, Balance 5 ranks, Dex 15+.

Benefit: A character can switch from his horse to another horse in mid-gallop, as long as the horses are alongside each other with no more than 5 feet between them. He must make a Ride check (DC 15) or miss the target and fall, taking 1d6 points of damage.

If the target horse has a rider, this maneuver provokes an attack of opportunity. Once the two riders are on the same horse, they may struggle to unseat one another. The two characters must make opposed Ride checks, with the first character to lose two consecutive checks being thrown from the horse, taking 1d6 points of damage from the fall and ending up prone.

TACKLE

Prerequisites: Jump 3 ranks, Ride 5 ranks.

Benefit: A character using this maneuver can leap off his mount to initiate a trip or grapple attack on an opponent without provoking an attack of opportunity. The character gains a +2 bonus to the touch attack to initiate a grapple or trip, and a +4 bonus to the Strength check to resolve a trip.

Drawback: If the character fails to trip or successfully initiate a grapple, he automatically falls prone in a square next to his opponent.



SCHOOLS OF COMBAT

As a discipline grows and matures, it develops into branches. These branches are unique in and of themselves, and yet still tied to the whole. Combat, like the mighty oak, has many branches.

It all begins with an idea of a different way to fight. The idea takes shape and becomes a unique style. The style is refined. It is given boundaries and rules. Specialists emerge. They put the style to use and soon teach others who in turn become the next generation of masters. And thus the cycle continues and a school is born.

Anyone who wishes to learn a unique fighting style is called a student. The student must undertake a series of lessons that break down the philosophies of the school. Once a student has learned at least half of the lessons a particular school offers, he is considered a master and may teach the techniques he has learned to others. A student who learns from more than one school will never be considered a master, although he may still teach lessons as long as he has learned at least half of the lessons from a school.

Most combat schools have 10 individual lessons. Each lesson teaches a special technique, but in order to gain the technique, a student must spend the appropriate time and experience costs necessary to learn the lesson. A student must always learn the first lesson of a school before advancing further. This determines the course of education for the student. That first school is called the primary school and all other schools become secondary. Because each school has its own way of learning, it is more difficult for a student to learn the techniques of a secondary school. As such, a student must pay twice the normal XP cost to learn a lesson from any secondary school.

Only a master can instruct others in a school's secrets, but not all masters can use the techniques they teach. The Veruthian Slayers, for example, are mainly taught by clerics of the

SCHOOLS OF COMBAT

Lesson	XP Cost	Time Cost	Level Cap
1	100	1 week	1
2	300	1 day	2
3	600	2 days	4
4	1,000	3 days	6
5	1,500	4 days	8
6	2,100	1 week	10
7	2,800	1 week, 3 days	12
8	3,600	2 weeks	15
9	4,500	3 weeks	18
10	5,500	1 month	20

god of death. These clerics cannot use the techniques of the Slayers, but each has spent the time necessary to acquire the knowledge so that they can pass it to others. A master never needs to spend the XP required to teach a lesson, only the time and, if appropriate, the gold.

The level cap listed in the table above details the ideal level that a student should be before attempting to learn a lesson. If the student wishes to undertake a lesson and does not meet the level cap, the XP costs are increased by 20% to reflect the difficulty of the lesson.

ACADEMIES AND TRAVELING MASTERS

In order to learn the techniques of a school, a student must seek out either an academy or a traveling master.

Academies are large, usually self-funded, organizations dedicated to instruction. Most academies are found within cities and metropolises, but a rare few are mobile. An academy has training rooms, all the necessary educational equipment, and a staff of masters, usually one for every five students. They are cheaper than traveling masters and many offer scholarships for talented, yet destitute, fighters. The local government may sponsor a young student in return for future work with the town guard or army.

On the other side, a traveling master can be found almost anywhere, from the most dangerous dungeons to the corner of a seedy tavern. A character can locate a traveling master by suc-

ceeding at a Gather Information check (DC 25) and spending 1d4 weeks searching. These ronin masters are under no obligation to teach and can charge whatever rate they feel like. Some may ask for gold or favors, and a few teach for more personal reasons, such as vengeance or boredom.

Some masters do not teach at all and may require strong convincing to take on a student. Traveling masters are usually expensive, but having the one-on-one kind of education found only with a traveling master reduces the required time to learn a lesson by 15 percent.

THE JADAN SPEARMEN

Few schools are given as much honor and respect as the Jadan Spearmen. The school's origins can be traced to guard posts in the mountainous country of Jadan, although they now have academies in most major cities. The Spearmen were at one time the only protection against orc and goblin attacks along the mountainous highways of Jadan. They received the title of Spearmen because of the ornate magical spears called the Orc Slayers that they once carried. The spearmen wielded these weapons with a deadly efficiency, but the art of making these weapons was lost during the great orcish wars of Jadan and most of the spears were destroyed. The few remaining spears now reside in private collections or are forgotten deep among the goblin caves. An academy is often willing to give a good reward for the retrieval of one of these historic weapons.

School Motto: The Only Good Orcs are Dead

ACADEMY

The Elkbrothers Jadan Academy in the city of Binder occupies an entire city block. They are respectable sorts and give a weekly parade in honor of the local goddess of life. Costs for study are 15 gp per week and they offer a small room and board for an additional 3 gp per week. The headmaster is Samus Warrick, a friendly old man who purchased the academy from the Elkbrothers almost two decades ago.

TRAVELING MASTER: JERIBEL ELKBROTHER

Male human Ftr13; Size M (5 ft., 2 in. tall); HD 13d10+26; hp 117; Init +6; Spd 30 ft.; AC 23; Attack +19/+14/+9 melee (1d8+8 longspear), or +15/+10/+5 ranged (1d8+7 longspear); SV Fort +10, Ref +6, Will +2; AL N; Str 16, Dex 15, Con 14, Int 12, Wis 7, Cha 10.

Skills and Feats: Climb +14, Craft +17, Jump +13, Listen +4, Ride +17, Tumble +6; Blind-Fight, Cleave, Dodge, Endurance, Expertise, Improved Critical (longspear), Improved Initiative, Leadership, Power Attack, Quick Draw, Sunder, Weapon Focus (longspear), Weapon Specialization (longspear).

Possessions: +2 *longspear of frost*, +3 *chain-mail, cloak of protection +2, potion of protection from elements (fire)*, 280 gp.

Jadan Spearman Lessons: Spear Expertise, High Brow, The Iron Curtain, Low Blow, Flying Spear, Backstep, Vaulted Kick.

Jeribel Elkbrother decided some years ago to become a man of travel after selling the academy that he and his brothers Simia and Reginald spent a lifetime building together. Jeribel wants to see adventure and battle before he meets with his ancestors, and so he is always looking for new forms of excitement. Although he wants little to do with them, his brothers still live in the town of Binder, enjoying their wealthy retirements. Jeribel charges 2 gp per day for lessons and is a decent, if distracted, teacher.

LESSONS

Lesson 1 – Spear Expertise

The Spearman begin their training with the longspear and practice to improve their control and handling of the long and challenging weapon. The swinging thrusts, kicks, and

maneuvers are quite impressive to behold, and they take incredible strength and concentration to perform. The spear expertise technique grants a character the Weapon Focus (longspear) feat.

Lesson 2 – High Brow

The first attack the spearmen learn to perform is the high brow. In this attack, a spearman strikes with a reach weapon at a distance using the front end of the weapon and then follows it with a close attack using the reverse end. A character must declare he is using a high brow attack before the attack roll is made. When using this technique, the character makes one attack at a distance with his full base attack bonus, then the character moves within 5 ft. of the opponent and initiates a second attack at a –5 penalty to the attack roll. This movement does not incur an attack of opportunity. This ability requires a full attack action to perform.

Lesson 3 – The Iron Curtain

By holding out his weapon horizontally in front of him and rushing forward, a Spearman can use his longspear to clothesline enemies. When using the iron curtain technique, a character performs an overrun and can strike all individuals in a 10-ft. wide line. Opponents that do not elect to jump out of the way are subject to a trip attack.

Lesson 4 – Low Blow

This technique teaches a spearman to use his spear as an effective tripping tool. A character that knows this maneuver can make a trip attack on any opponent within 10 feet. This attack does not provoke an attack of opportunity, and if the attack fails his opponent may not attempt to trip him back.

Lesson 5 – Flying Spear

Often a spearman finds himself the target of ranged attacks, spells, or natural attacks from unreachable foes. In this case, the experienced spearman has an option, albeit one that leaves him deprived of his favored weapon. This advanced Jadan technique allows the spearman to throw his longspear at his enemies. The weapon has a range increment of 15 ft. and deals its normal damage on a successful strike. The Jadan masters teach their students to only use this technique as a last resort.

Lesson 6 – Backstep

It is very difficult to follow through with a hit

up close and a Spearman needs room to move after performing a high brow or being pressed in melee. As such, Jadan masters train their students in the art of making a quick backstep. When using this technique, a character can move up to 10 feet back without incurring an attack of opportunity for leaving his opponent's threatened area. He suffers attacks of opportunity for moving through other opponents' threatened areas as normal.

Lesson 7 – Vaulted Kick

In this lesson, a student learns that a weapon can be used both for balance as well as for attacking. The vaulted kick allows a character to make an unarmed kick attack while using his large weapon as a counterweight. This technique grants the character a +4 circumstance bonus to a single unarmed attack, which does not provoke an attack of opportunity even if the character does not have Improved Unarmed Strike, and requires a full attack action to perform. The target of the vaulted kick must also make a Strength check (DC 10) or be pushed back 5 ft. by the spearman's assault in addition to normal damage.

Lesson 8 – Up-Close Combat

A common misconception that usually gets an enemy killed is that the Spearmen are helpless against foes that come close due to the large size of their weapons. However, the Spearmen

are highly trained in this type of combat and merely suffer a -4 penalty to attack rolls with reach weapons against foes within 5 ft. Spears used in this manner use the same weapon statistics as a club.

Lesson 9 – Wall of Blades

When the orcish hordes were attacking, the Spearmen knew that they were hopelessly outnumbered and could easily be overrun. As such, they developed the wall of blades technique in order to scare the orcs and make their own forces seem more powerful. As a spell-like ability a character with wall of blades can cast *mirror image* as if he was a 3rd-level sorcerer. This ability can be used once per day.

Lesson 10 – Superior Spearfighting

Some opponents are just too tough to keep away, and continue to press a spearman despite his best efforts and the lessons that he has learned. A master Jadan Spearman that has learned this technique can turn his spear on its side, using it as a quarterstaff to form a double weapon. The spear is in all ways like a quarterstaff being wielded as a double weapon, except that its damage is 1d8/1d6. In addition, the Jadan master wields this weapon as if he had the Ambidexterity, Improved Two Weapon Fighting, and Two Weapon Fighting feats, effectively reducing his penalty when fighting in this manner.



GUARDIAN OF THE WAY

Eventually, a monk's skills surpass those of other monks in his monastery. Once this happens, the monk is asked to become the guardian of the way. The monk must act as the monastery's ambassador, cultivating friendships with important patrons and increasing the fame of his monastery by acts of heroism. Occasionally, the guardian of the way will be asked to take along a new monk and train her in the art while adventuring.

Hit Die: d8.

REQUIREMENTS

To qualify as a guardian of the way, the character must meet the following requirements.

Skills: Craft (calligraphy) 5 ranks, Diplomacy 8 ranks.

Feats: Deflect Arrows, Improved Unarmed Strike, Lightning Reflexes, Stunning Fist.

CLASS SKILLS

The guardian of the way's class skills (and the key ability for each skill) are Balance (Dex), Climb (Str), Concentration (Con), Craft (Int), Diplomacy (Cha), Escape Artist (Dex), Hide (Dex), Jump (Str), Listen (Wis), Move Silently (Dex), Perform (Cha), Profession (Wis), Swim (Str), and Tumble (Dex).

Skill Points at Each Level: 4 + Int modifier.

CLASS FEATURES

The following are class features of the guardian of the way prestige class.

Weapon and Armor Proficiency: A guardian of the way is not proficient with any armor or shields, and is proficient with the same weapons as a monk (club, crossbow (light or heavy), dagger, handaxe, javelin, kama, nunchaku, quarterstaff, shuriken, siangham, and sling). Guardians of the way cannot use their special abilities, unarmed attacks, unarmed damage, AC bonus, or unarmored speed while wearing armor heavier than leather armor.



GUARDIAN OF THE WAY

Level	Base Attack	Unarmed Attack	Fort Save	Ref Save	Will Save	Special
1	+0	+0	+2	+2	+2	Defensive spin, monk abilities
2	+1	+1	+3	+3	+3	Guarded thoughts, ki strike (+1)
3	+2	+2	+3	+3	+3	Pain touch
4	+3	+3	+4	+4	+4	Aura of friendship 1/day
5	+3	+3	+4	+4	+4	Levitation
6	+4	+4/+1	+5	+5	+5	Ki strike (+2)
7	+5	+5/+2	+5	+5	+5	Aura of friendship 2/day
8	+6	+6/+3	+6	+6	+6	Luck of the rabbit
9	+6	+6/+3	+6	+6	+6	Persuasive calligraphy
10	+7	+7/+4/+1	+7	+7	+7	Ki strike (+3)

Monk Abilities: Beginning at 1st level, the guardian of the way advances the unarmed damage, AC bonus, and unarmored speed monk abilities as if she had gained a level in monk. In effect, her monk levels and guardian of the way levels stack when determining these three abilities.

Defensive Spin: As a full round action, the guardian of the way can give himself the equivalent of nine-tenths concealment (granting a 40% miss chance to any attacks aimed against him) until his next action by focusing in on his attacker's blows and deftly avoiding them.

Guarded Thoughts: At 2nd level, the guardian of the way gains a +4 bonus to saving throws against spells that read her thoughts or detect mistruths. If such a spell does not grant a saving throw, the guardian of the way gains one, although without the +4 bonus. Spells affected by this ability include: *detect thoughts*, *discern lies*, and *zone of truth*.

Ki Strike: Starting at 2nd level, a guardian of the way's unarmed attack is empowered with ki. The unarmed strike damage from such an attack can deal damage to a creature with damage reduction as if the blow were made with a weapon with a +1 enhancement bonus. Ki strike is a supernatural ability.

Pain Touch: At 3rd level, the guardian of the way can inflict great pain with a simple touch. This is a melee touch attack that uses up one of the guardian of the way's stunning attacks for the day. The victim must make a Fortitude save with a DC equal to that of the character's stun-

ning attack or suffer two points of temporary Dexterity damage and a -4 penalty to attack rolls, skill checks, and ability checks. These penalties last for 1 round per class level.

Aura of Friendship: At 4th level, the guardian of the way can emit an aura of goodwill that affects those in his immediate area. This ability is usable once per day and acts in all ways as an *emotion (friendship)* spell cast by a 9th-level bard.

Levitation: When the guardian of the way reaches 5th level, he gains the ability to *levitate* three times per day. Treat this ability as the spell cast by a 10th-level sorcerer, except the character may only affect himself with the spell.

Luck of the Rabbit: At 8th level, the guardian of the way can add his class level to any roll after seeing the results of that roll. This ability modifies the total, not the die result, so it may not be used to achieve a critical threat, although it could be used to confirm a critical. The character can only use this ability once per day.

Persuasive Calligraphy: At 9th level, the guardian of the way learns to invoke powerful magic using his calligraphy. He may draw patterns in the air or on paper that have incredible effects on those around him. This pattern acts as a *symbol of persuasion* cast by a 14th-level cleric.

PATH OF SHADOW

Everyone knows that rogues are the best class to play in d20 system fantasy settings. They're the most self-reliant, pragmatic, and resourceful of all the character types. Unfortunately their universal appeal comes along with a universal bad rap. Players and NPCs alike are determined to distrust them, label them criminals, and claim that they're dangerous.

Path of Shadow lets you prove them right.

The excerpt that follows focuses on one of Fantasy Flight's most novel inventions: legendary classes. Legendary classes are the answer to that dreaded question "what next?" After a while players become bored with traditional character advancement, yet might not be interested in any of the rigid and specialized prestige classes available.

That's where legendary classes come in. They allow characters to get new and greater powers as they increase in ability, skill, and renown, and to gain those powers in the order and level of focus that they want.

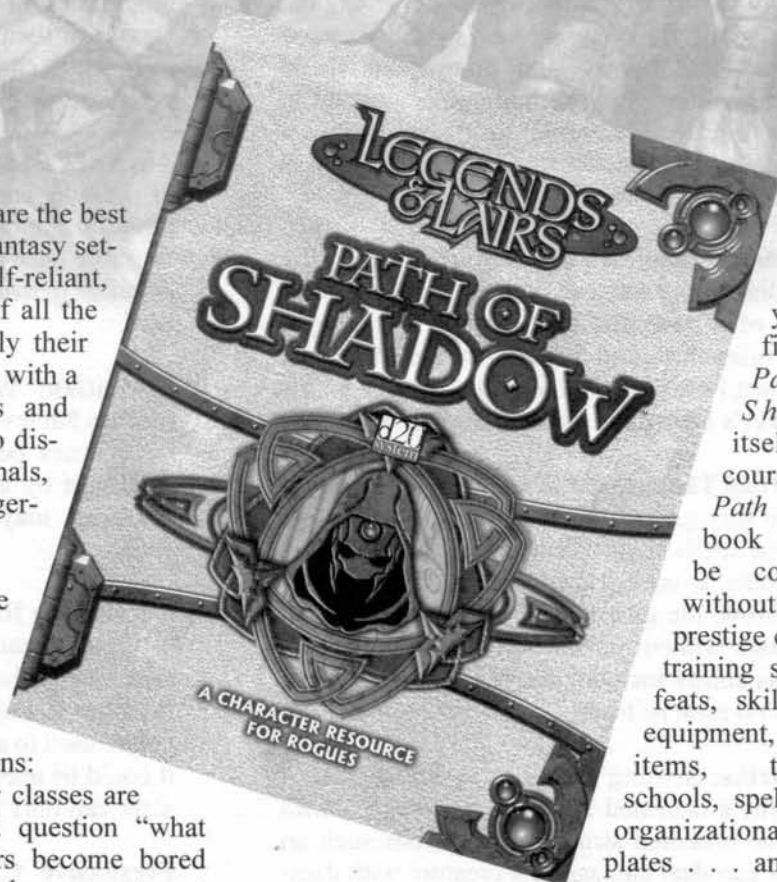

That's not all you'll find in *Path of Shadow* itself, of course. no *Path* sourcebook would be complete without new prestige classes, training schools, feats, skill uses, equipment, magic items, training schools, spells, and organizational templates . . . and each and every one of them is designed specifically

for larceny, skulking, infiltration, assassination, and whatever other roguishness you can imagine.

The names of classes and any rules or game mechanics derived from the d20 SRD are considered **Open Game Content**. All other text is considered closed content.

LEGENDARY CLASSES

So you stole the Kingston diamond, passed the guild's tests, and became a master thief. Or perhaps you've mastered the whirling blades and won a handsome fee in the arena. Maybe you are a wizard who mastered the elements and learned to carry the stuff of fire within your very body. What is left for men and women such as you, who have conquered every challenge, solved every puzzle, and defeated every enemy?

There is one challenge left: to become a legend.

Legendary classes present high-level options for characters on the verge of greatness, whose names will be scribed eternally and against whose deeds each man shall measure his own. Although similar in concept and appearance to prestige classes, they represent far more. They describe the pinnacle of a profession or culture, the kind of opportunity that only appears once in a generation. Someone who decides to walk the path of a legendary class may be fulfilling his people's oldest myth, or a society's greatest fear. It is never an easy path, nor one many would choose. Those who do take up the mantle award themselves great power as well as great danger, and only the boldest are able to fulfill their destiny.

CLASS MECHANICS

Legendary classes have all the same progressions as normal classes: base attack bonus, saving throws, and special abilities. They also have unique class skill packages and proficiencies. Like a prestige class, there are prerequisites that must be fulfilled before the first legendary class level may be selected. Some of these are left open for the DM's discretion, so that he can customize them to his home campaign. This allows the DM to include feats from official sources that have not been released as **Open Game Content**.

THE PREPARATION

A character must announce his intention to take a legendary class well in advance of ever tak-

ing a level in it. In game terms, this represents the character trying to catch the attention of a deity or powerful extra-planar being, applying for a position within an organization, or channeling the spirits of his ancestors. Two levels before the character takes his first legendary class level, he must announce his commitment. This means that if Dran decides to be reborn in order to become a blood thief at 13th level, he must announce his intention no later than the point at which he reaches 11th level. Once the character has announced the level at which he will become a legend, there is no turning back.

Each legendary class has among its prerequisites a list of quests, each of which must be fulfilled in between the time of commitment and the acquisition of the first level of the class. The character may not complete them before he announces his intentions. Once each quest has been fulfilled and all other prerequisites are met, the character may take a legendary class level.

Legends wait for no man. If some or all of the quests go unfulfilled, the character may not advance in level until they are. All excess experience gained in the meantime is lost. This means that in the above example, if Dran reached 77,999 experience points without completing the quests, he would gain no more experience until he had done so. The character need not meet all the prerequisites of the class upon announcing his intentions, but he must meet them before taking the first legendary class level. If he does not, the same penalty described above applies.

THE POWER

Legendary characters have access to powers and abilities beyond the reach of those who have chosen ordinary lives and less impressive legacies. They also wield greater control over the development of their powers than other characters, having choices to make as they rise in level and power. Even though two characters march down the same path, each may end up quite differently depending on these choices.

For each legendary class level gained, the character may choose one special ability from those listed. The power and scope of this ability are determined at that time and do not increase as the character goes up in levels. This is known as the ability's power level. No



power may be chosen more than once. This always means a sacrifice for the character, but sometimes the rewards of patience are worth the wait.

EXAMPLE POWERS OF A 5TH-LEVEL ABYSSAL INFILTRATOR

Deadly Precision I: The character's death attack DC gains a +1 legendary bonus.

Enhanced Strength II: The abyssal infiltrator gains a +2 legendary bonus to Strength.

Abyssal Skill III: The character gains a +9 legendary bonus to Disable Device.

Smite Good IV: 4 times per day, the abyssal infiltrator may attempt to smite good with one normal melee attack. She adds her Charisma modifier (if positive) to her attack roll and deals 8 extra points of damage.

Enhanced Dexterity V: The abyssal infiltrator gains a +5 legendary bonus to Dexterity.

THE PRICE

Once a character has begun to walk the path of a legend, he may not turn back even if his faith is shattered or his kingdom lost. The forces acting upon him are great, and he cannot resist the tidal wave of fate he has chosen to ride. Once a character chooses to take a legendary class level, he may not choose any other classes until the legendary class has been completed. Although this may seem restrictive, it is a small price to pay for the power and prestige afforded a legend.

ABYSSAL INFILTRATOR

Deep within the fortified temple of the Valor god, a shriek of terror echoes. Acolytes rush into the chambers of the canon to find the body of the old, wise, and powerful cleric who has spearheaded the faith for decades. Beside the body, a grizzly calling card signifies the involvement of the Flame Masters, an infamous group of fiends that oppose the Valor god in every fashion. "But the temple is protected from such beings," an acolyte mutters. "This was not the work of those devils, at least not directly. This was the work of Sarin the infiltrator."

Among the societies of demons and devils, one

THE ABYSSAL INFILTRATOR

Class Level	Base Attack Bonus	Fort Save	Ref Save	Will Save
1st	+1	+1	+3	+3
2nd	+2	+1	+4	+4
3rd	+3	+2	+4	+4
4th	+4	+2	+5	+5
5th	+5	+2	+5	+5

Special

Abyssal Infiltrator Ability
Abyssal Infiltrator Ability
Abyssal Infiltrator Ability
Abyssal Infiltrator Ability
Abyssal Infiltrator Ability

assassin is called into the service of death. No mere hired killer, this individual worships the dark powers that command the lower planes of fire and evil. Her talents in death, infiltration, and the servitude of the devils have earned her a legendary infamy. She is the abyssal infiltrator.

A character who chooses to become an abyssal infiltrator must be prepared for a life devoted to death, suffering, and lies. She must first master the arts of death and infiltration. The abyssal infiltrator must also harbor a deep and true hatred for all things good and noble. In most cases, she must carry a particular hatred for a deity or noted worshipper of that deity's faith (such as a high priest). Finally, she must study the dark arts, not as a spellcaster but as a worshipper ready to offer herself to fire and death. Performing these dangerous acts will earn her the favor of her demonic patrons and the gifts they provide, as well as the infamy of the mortal world.

Hit Die: d6.

REQUIREMENTS

To qualify to become an abyssal infiltrator, a character must fulfill all the following criteria.

Alignment: Any evil.

Base Attack Bonus: +8.

Skills: Hide 15 ranks, Intimidate 10 ranks, Knowledge (arcana) 7 ranks, Move Silently 15 ranks, and Open Lock 15 ranks.

Special: The character must have the death attack special ability.

QUESTS

- The character must seek out and assassinate a ranking member of the Valor god's faith (or another religion prominent in the DM's campaign world). This assassination cannot be

aided; the character must perform the act alone. If successful, she must leave behind the calling card (such as a standard, mark, etc.) of the patron demon or devil she wishes to serve.

- The character must journey to the outer planes and contact the patron demon or devil she wishes to serve. If she survives the journey and approaches the patron, she must survive the Trial of Abyssal Fire. If successful, she will be welcomed into the service of the patron.

- The character must perform a ritual involving the blood of a cleric of the Valor god and the sacrificing of her own blood. This self-inflicted blood loss must result in one point of permanent Constitution drain. If the offering is given, the patron may assign a task to the character to prove her desire to join its legions.

CLASS SKILLS

The abyssal infiltrator's class skills (and the key ability for each skill) are Appraise (Int), Balance (Dex), Bluff (Cha), Climb (Str), Craft (Int), Decipher Script (Int, exclusive skill), Diplomacy (Cha), Disable Device (Int), Disguise (Cha), Escape Artist (Dex), Forgery (Int), Gather Information (Cha), Hide (Dex), Innuendo (Wis), Intimidate (Cha), Intuit Direction (Wis), Jump (Str), Listen (Wis), Move Silently (Dex), Open Lock (Dex), Perform (Cha), Pick Pocket (Dex), Profession (Wis), Read Lips (Int, exclusive skill), Search (Int), Sense Motive (Wis), Spot (Wis), Swim (Str), Tumble (Dex), Use Magic Device (Cha, exclusive skill), and Use Rope (Dex).

Skill Points at Each Level: 8 + Int modifier.

CLASS FEATURES

Weapon and Armor Proficiency: The abyssal infiltrator gains no new weapon

or armor proficiencies. Note that armor check penalties for armor heavier than leather apply to the skills Balance, Climb, Escape Artist, Hide, Jump, Move Silently, Pick Pocket, and Tumble. Also, Swim checks suffer a -1 penalty for every 5 pounds of armor, equipment, or loot carried.

ABYSSAL INFILTRATOR ABILITIES

Enhanced Dexterity: The path that has led the abyssal infiltrator from lowly assassin to favored minion of a dark power was a path of skill and sacrifice. This devotion has increased her dexterity to legendary heights. The character gains a +1 legendary bonus per power level to her Dexterity score. This is a one-time bonus.

Enhanced Strength: As a servant of the dark powers of the abyss, the abyssal infiltrator is fueled with flame and hatred. This hatred increases her killing prowess, her chances of survival, and her potential for dealing massive amounts of damage in combat. The character gains a +1 legendary bonus per power level to her Strength score. This is a one-time bonus.

Abyssal Skill: The abyssal infiltrator is a true servant to fiends and the dark desires they represent. But it was the true skill and talent of the abyssal infiltrator that gained the favor of her patron. As an abyssal infiltrator, this legendary skill continues to grow and develop. With this ability, the abyssal infiltrator may select one skill from her class skill list per power level and gain a +3 legendary bonus per power level to her bonus with that skill. This legendary bonus stacks with any skills, feats, abilities, or spells that provide a bonus to the selected skill.

Deadly Precision (Ex): The skill of the abyssal infiltrator is legendary. Her skill in the art of death is feared. It is this natural talent that allows her to become even more deadly with her killing blows. This ability gives the abyssal infiltrator a +1 legendary bonus per power level to the DC to resist the effects of her successful death attacks.

Resist the Power of Faith (Ex): As an agent for the dark powers of flame, the abyssal infiltrator must regularly confront the forces of good and justice. In preparation for such conflicts, the patron of the abyssal infiltrator bestows a protection upon her against the magic of divine heroes. With this ability, the

abyssal infiltrator gains spell resistance of 10 + 4 per power level against the divine magic of good-aligned characters. For example, Sarin is an abyssal infiltrator who took this ability at power level three. Against the divine magic of a cleric of a good deity, she has SR 22. This ability does not stack with spell resistance from other sources. If spell resistance from two or more sources could be applied against a given spell, the player must choose which ability to use.

Smite Good (Su): Once per day per power level, an abyssal infiltrator may attempt to smite good with one normal melee attack. She adds her Charisma modifier (if positive) to her attack roll and deals 2 extra points of damage per power level. If the abyssal infiltrator accidentally smites a creature that is not good, the smite has no effect but it still counts as one use for the day.

Unseen Assassin (Sp): The fiendish powers that she serves provide the abyssal infiltrator with many gifts to aid her in her vile duties. This ability allows the abyssal infiltrator to cast *invisibility* and *ethereal jaunt* a number of times per day equal to her power level. This ability acts as the spells cast by a 12th-level sorcerer.

FORTUNE'S FOOL

Some people get lucky. Other people simply *are* lucky. For the fortune's fool, luck is an ever-present master and slave. Lady luck lingers at his side and will never leave. Luck becomes a way of life for the fortune's fool, because his luck never ends.

The fortune's fool follows the course of his life with a string of luck that never seems to end. His feats and accomplishments marvel those who could only dream of surviving what the fortune's fool has been through. While he may be skilled, cunning, or strong, it is always his luck that sees him through.

Hit Die: d6.

REQUIREMENTS

To qualify to become fortune's fool, a character must fulfill the following requirements.

Alignment: Any non-lawful.

Wisdom: 13 or less.

Skills: Balance 10 ranks, Bluff 15 ranks, Diplomacy 12 ranks, Escape Artist 10 ranks, Sense Motive 12 ranks, Spot 10 ranks, Tumble 8 ranks.

Feats: Alertness, Combat Reflexes, Dodge, Improved Initiative, Quick Draw.

QUESTS

- Anyone wishing to become a fortune's fool must play a game of chance against the three Lords of Shadow. He must defeat each of them in turn.

- Once this is accomplished, he must prove his luck by seeking out the Wind of Fate and making a bet against it. If the character wins the bet against the Wind of Fate, he can become a fortune's fool.

CLASS SKILLS

The fortune's fool's class skills (and the key ability for each skill) are Appraise (Int), Balance (Dex), Bluff (Cha), Climb (Str), Craft (Int), Decipher Script (Int, exclusive skill), Diplomacy (Cha), Disable Device (Int), Disguise (Cha), Escape Artist (Dex), Forgery (Int), Gather Information (Cha), Hide (Dex), Innuendo (Wis), Intimidate (Cha), Intuit Direction (Wis), Jump (Str), Listen (Wis), Move Silently (Dex), Open Lock (Dex), Perform (Cha), Pick Pocket (Dex), Read Lips (Int, exclusive skill), Search (Int), Sense Motive (Wis), Spot (Wis), Swim (Str), Tumble (Dex), Use Magic Device (Cha, exclusive skill), Use Rope (Dex), and Wilderness Lore (Wis).

Skill Points at Each Level: 8 + Int modifier.

CLASS FEATURES

All of the following are class features of the fortune's fool legendary class.

Weapon and Armor Proficiency: A fortune's fool is proficient with all simple weapons and light armor, but not with shields. Note that armor check penalties for armor heavier than leather apply to the skills Balance, Climb, Escape Artist, Hide, Jump, Move Silently, Pick Pocket, and Tumble. Also, Swim checks suffer a -1 penalty for every 5 pounds of armor, equipment, or loot carried.



THE FORTUNE'S FOOL

Class Level	Base				Special
	Attack Bonus	Fort Save	Ref Save	Will Save	
1st	+0	+0	+2	+2	Fortune's Fool Ability
2nd	+1	+0	+3	+3	Fortune's Fool Ability
3rd	+2	+1	+3	+3	Fortune's Fool Ability
4th	+3	+1	+4	+4	Fortune's Fool Ability
5th	+3	+1	+4	+4	Fortune's Fool Ability

FORTUNE'S FOOL ABILITIES

Clever: The fortune's fool gains a +1 legendary bonus to Intelligence per power level.

Nimble: Swift and dexterous, the fortune's fool gains +1 legendary bonus to Dexterity per power level.

Fortuitous: The fortune's fool gains a +1 legendary bonus per power level to all saving throws.

Fool of Fortune (Su): The fortune's fool has accepted his place and his lot in life. In learning to accept his luck, he can turn it to his advantage. Twice per day per power level, the fortune's fool can declare a re-roll of any dice roll made by a character or creature within 5 ft. per power level, whether that action was taken by himself, his allies, or his enemies. The fortune's fool chooses which roll (the original or the re-roll) takes effect.

Insight of the Fool (Sp): Once per day per power level, a fortune's fool may cast *foresight* as a sorcerer of his character level, except that the duration is one minute.

Luck of the Survivor (Ex): The fortune's fool slips through every situation with seemingly impossible luck. He is nearly impossible to affect with magic or attacks if there is any chance of his escaping the effect. The fortune's fool selects a type of saving throw (Fortitude, Reflex, or Will). When the fortune's fool makes a saving throw of that type, he rolls a number of additional dice equal to his power level and takes the best result. This ability may be selected more than once. Its effects do not stack. Each time the fortune's fool gains this ability, it applies to a different saving throw type.

Lucky Shot (Ex): Once per day per power level, the fortune's fool can declare that he has gotten lucky. This gains him a +4 luck bonus to attack rolls or a +10 luck bonus to any skill check or saving throw. This ability applies to only a single roll but may be declared after the attack or skill check is rolled. Multiple uses of this ability do not stack with each other.

GREY HAND

The silent stroke that can destroy even the most stalwart opponents. The whisper of death on the wind at the coming of night. The soul of determination that lives only to end the lives of others. All of these things describe the grey hand, an assassin of legendary skill. Everyone who knows of him fears to draw his attention and few could match the price he might ask for his skills.

The grey hand is a master of dispensing death, silently and skillfully. His deeds are legend, and it is said that he cannot be seen or found unless he wishes it. All who fall under his gaze are said to be marked by the shadow of death that lingers about the grey hand. Certainly no one who comes into contact with him leaves unaffected by his calm and deadly demeanor or the certainty in his eyes that his is the hand of death.

Hit Die: d6.

REQUIREMENTS

To qualify to become a grey hand, a character must fulfill the following requirements.

Base Attack Bonus: +9.

Sneak Attack: +5d6.

Skills: Disguise 10 ranks, Hide 15 ranks,

Intimidate 10 ranks, Move Silently 15 ranks.

Feats: Improved Critical and Weapon Focus with weapon of choice, Skill Focus (any required skill).

Special: A grey hand must have the death attack special ability.

QUESTS

- When an assassin hopes to become a grey hand, he must set before himself three nearly impossible tasks to prove his skills. First, he must survive the poison barbs of the venomous grey dragon. This will prove he is the master of his life.
- Next, he must venture into the lands of the dead and drink from the river that is death and silence. He must find his way back from the river to the living world without succumbing to sleep or hunger. This will place the seed of death within him and make him the master of death.
- Last, he must prove his skills and his mastery over the life, death, and unlife of others. He must find and steal the phylactery of a living lich. He must keep the phylactery with him for a month and a day and then return it to its master. If he survives the ordeals, he can become a grey hand.

CLASS SKILLS

The grey hand's class skills (and the key ability for each skill) are Balance (Dex), Bluff (Cha), Climb (Str), Craft (Int), Decipher Script (Int, exclusive skill), Diplomacy (Cha), Disable Device (Dex), Disguise (Cha), Escape Artist (Dex), Forgery (Int), Gather Information (Cha), Hide (Dex), Innuendo (Wis), Intimidate (Cha), Intuit Direction (Wis), Jump (Str), Listen (Wis), Move Silently (Dex), Open Lock (Dex), Pick Pocket (Dex), Read Lips (Int, exclusive skill), Search (Int), Sense Motive (Wis), Spot (Wis), Swim (Str), Tumble (Dex), Use Magic Device (Cha, exclusive skill), and Use Rope (Dex).

Skill Points at Each Level: 8 + Int modifier.

CLASS FEATURES

All of the following are class features of the grey hand legendary class.

Weapon and Armor Proficiency: A grey hand is proficient with all simple and martial



THE GREY HAND

Class Level	Base				Special
	Attack Bonus	Fort Save	Ref Save	Will Save	
1st	+1	+1	+3	+1	Grey Hand Ability
2nd	+2	+1	+4	+1	Grey Hand Ability
3rd	+3	+2	+4	+2	Grey Hand Ability
4th	+4	+2	+5	+2	Grey Hand Ability
5th	+5	+2	+5	+2	Grey Hand Ability

weapons, light armor, and medium armor. Note that armor check penalties for armor heavier than leather apply to the skills Balance, Climb, Escape Artist, Hide, Jump, Move Silently, Pick Pocket, and Tumble. Also, Swim checks suffer a -1 penalty for every 5 pounds of armor, equipment, or loot carried.

GREY HAND ABILITIES

Cunning: The grey hand's wit and perception are legendary. He gains a +1 legendary bonus to Intelligence per power level.

Killer's Grace: Athletic and lithe, the grey hand gains a +1 legendary bonus to Dexterity per power level.

Killing Attack (Ex): Once per day per power level, the grey hand can use his sneak attack to slay his enemies outright. An enemy struck by the grey hand's killing attack must succeed at a Fortitude saving throw (DC 15 + power level + Intelligence modifier) or die. The grey hand must declare the killing attack before making the attack roll for a sneak attack. If the attack misses, that use of killing attack is wasted.

Coup de Main (Ex): The grey hand moves with a decisive suddenness that can take opponents off-guard and give him the advantage in a confrontation. He gains a +2 legendary bonus per power level on initiative checks.

Fading Presence (Ex): The grey hand's mastery of stealth and shadows takes on a preternatural quality. He moves with silence and slips from view without effort. Any penalties to the grey hand's Hide or Move Silently skill checks, such as for movement or environmental conditions, are reduced by 2 per power level. If attempting to hide or move silently when no

penalties apply, the grey hand may apply a +1 legendary bonus per power level to these skill checks. Furthermore, the grey hand is always considered to be taking 10 on Hide and Move Silently checks unless he specifically chooses to be seen and heard. Characters or creatures must succeed opposed checks using their Spot or Listen skills to notice the grey hand.

Murderous (Ex): The grey hand can use momentary advantages and surprise attacks to bring the strongest enemies down. He gains +1d6 additional sneak attack damage per power level.

Shadow of Death (Ex): When the grey hand sets out to end a life, almost nothing can deter the shadow of death from falling over the chosen victim. When the grey hand selects his next victim, he gains a +1 legendary bonus per power level to attack rolls, skill checks, and AC against that opponent until his victim is slain. Until that target is slain, the grey hand may not select another victim for the shadow of death. If the grey hand fights another enemy while his chosen victim still lives, his unfinished murder acts as a distraction and he suffers a -1 circumstance penalty per power level to attack rolls.

Unrepentant (Ex): The grey hand does not seek peace or escape, nor does he accept them if they come. He faces his life and deeds with acceptance and a determination to finish what he has begun. Whenever he is reduced to 0 or fewer hit points, the grey hand can continue acting normally for 2 rounds per power level. During this time, he is not reduced to partial actions and may perform strenuous activity without danger of taking damage each round. Only after the duration of this ability has expired will the grey hand succumb to his wounds normally.

JACK-OF-KNIVES

What weapon is more symbolic of rogues than the dagger? None, or so says the jack-of-knives, and no one without a death wish contradicts him too loudly. With a dagger clenched in each fist, a jack-of-knives dances into melee as a whirling dervish of death, striking repeatedly with uncanny precision and emerging from the fight unharmed by his foe's weapon. His skill at knife fighting transcends normal limits, taking on supernatural characteristics.

A jack-of-knives is still a rogue, and he can function in shadow quite effectively. There is, however, one shadow that the jack-of-knives refuses to step into, and that is the one cast by fighters and other warriors over melee combat. While his weapon of choice seems pale in comparison to a greatsword or a dire flail and his leather armor can't turn an attack like half-plate, the jack-of-knives remains a foe to be reckoned with. He is a battle-tested expert with a narrow focus and within that focus can be every bit as deadly as a skilled fighter.

In legends, the jack-of-knives inspires awe and cold fear. Few jacks-of-knives are dashing, romantic figures. Instead they are grim drifters who see no need to use stealth and guile in their larcenous pursuits when it is easier to just cut their targets to ribbons and take what they want. This is not to say that a jack-of-knives is necessarily evil. He is not, but neither is he likely to be the sort of hero who earns the warm adoration of those he helps. The jack-of-knives is about being the best at knife fighting, and knife fighting is a brutal occupation.

Hit Die: d6.

REQUIREMENTS

To qualify to become a jack-of-knives, a character must fulfill the following requirements.

Feats: Dodge, Mobility, Point Blank Shot, Two-Weapon Fighting, Weapon Focus (dagger).

Skills: Balance 15 ranks, Jump 15 ranks, Tumble 15 ranks.

QUESTS

- When a rogue feels he is ready to become a jack-of-knives, he must embark on a dangerous adventure suitably challenging to characters of



THE JACK-OF-KNIVES

Class Level	Base			
	Attack Bonus	Fort Save	Ref Save	Will Save
1	+1	+2	+2	+0
2	+2	+3	+3	+0
3	+3	+3	+3	+1
4	+4	+4	+4	+1
5	+5	+4	+4	+1

Special

Jack-of-Knives Ability
 Jack-of-Knives Ability
 Jack-of-Knives Ability
 Jack-of-Knives Ability
 Jack-of-Knives Ability

his level, including due consideration for any allies that accompany him. From start to finish of the adventure, the rogue is not permitted to use any weapons except a pair of nonmagical masterwork daggers. It is permissible for the rogue or an ally to temporarily augment these daggers with the likes of the *magic weapon* spell. During the adventure, the rogue must enter melee on a regular basis.

• After establishing his reputation as a deadly knife fighter, the rogue must enter a large town or larger community and find the thieves' guild. He must tell the thieves' guild that he intends to become a jack-of-knives and issue a challenge to anyone who thinks they can best him in a knife fight at an announced location at an announced time. Singlehandedly, the rogue must defeat the first five challengers to arrive, one at a time without pause for rest between fights. No one can assist the rogue in these fights, but he is free to use whatever magic items he owns with one proviso: The rogue must make ranged and melee attacks only with daggers.



CLASS SKILLS

The jack-of-knives's class skills (and the key ability for each skill) are Appraise (Int), Balance (Dex), Bluff (Cha), Climb (Str), Craft (Int), Decipher Script (Int, exclusive skill), Diplomacy (Cha), Disable Device (Int), Disguise (Cha), Escape Artist (Dex), Forgery (Int), Gather Information (Cha), Hide (Dex), Innuendo (Wis), Intimidate (Cha), Intuit Direction (Wis), Jump (Str), Listen (Wis), Move Silently (Dex), Open Lock (Dex), Pick Pocket (Dex), Read Lips (Int, exclusive skill), Ride (Dex), Search (Int), Sense Motive (Wis), Spot (Wis), Swim (Str), Tumble (Dex), Use Magic Device (Cha, exclusive skill), and Use Rope (Dex).

Skill Points at Each Level: 8 + Int modifier.

CLASS FEATURES

All the following are class features of the jack-of-knives.

Weapon and Armor Proficiency: A jack-of-knives is proficient with all simple weapons and with light armor. He is not proficient with

shields. Note that armor check penalties for armor heavier than leather apply to the skills Balance, Climb, Escape Artist, Hide, Jump, Move Silently, Pick Pocket, and Tumble. Also, Swim checks suffer a -1 penalty for every 5 pounds of armor, equipment, or loot carried.

JACK-OF-KNIVES ABILITIES

Amazing Grace (Ex): The jack-of-knives gains a +1 legendary bonus to Dexterity per power level.

Bane Strike (Su): Once per day per power level, a jack-of-knives imbues a single dagger attack with fatal power. His dagger's effective enhancement bonus increases by +2 and a successful attack inflicts +1d6 points of bonus piercing damage per power level. The player must declare the use of this ability prior to making his attack roll. A missed attack therefore ruins the bane strike attempt.

Blade Friend (Su): So attuned to bladed weapons has the jack-of-knives become that he gains a measure of immunity to their attacks. For one minute per power level per day, the jack-of-knives gains DR 10/— against slashing and piercing weapons. Blade friend does not defend against natural attacks such as claws or fangs. The jack-of-knives need not use his daily time allotment all at once, but any use of blade friend counts as at least one minute.

Crippling Accuracy (Su): Once per day per power level with a successful dagger attack, a jack-of-knives can strike so as to weaken his foe. In addition to the damage inflicted by the attack, the victim suffers 2 points of temporary Strength damage. The player must declare the use of this ability prior to his attack roll, but a missed attack or an attack that inflicts no damage (due to DR, for example) does not cause this use of the ability to be lost. Creatures immune to critical hits are not affected by crippling accuracy. Crippling accuracy can be used more than once in a round. Its effects stack with the rogue's crippling strike special ability.

Dagger Master (Ex): The jack-of-knives gains a +1 legendary bonus per power level to attack rolls and weapon damage rolls when using a dagger.

Deadly Speed (Su): For one minute per power level per day, the jack-of-knives can make additional dagger attacks per round when tak-

ing the full attack action. His iterative attacks are recalculated to occur at a bonus 3 less than his base attack bonus instead of 5 less. For example, a 13th-level rogue/1st-level jack-of-knives has a base attack bonus of +10/+5. Using deadly speed as a power level 1 ability, for 10 rounds per day the jack-of-knives's base attack bonus becomes +10/+7/+4/+1. Deadly speed only works when wielding daggers, whether in melee or as thrown weapons.

Sneak Attack (Ex): The jack-of-knives' bonus sneak attack damage increases by 1d6 per power level. This bonus damage stacks with any sneak attack damage gained from levels in a previous class. However, the jack-of-knives only gains the bonus damage from this legendary class ability when making sneak attacks with daggers.

QUEEN OF SHADOWS

In rogue societies, there are several archetypes. Many rogues live a life of petty crime and larceny, while others become masters of the killing arts, and a select few follow the path of shadows. For shadowdancers, the ritual and tradition of the shadow arts lead to amazing abilities and a connection with the shadows themselves. In time, the shadowdancer learns to manipulate the shadows as an artist manipulates paint onto a canvas. Among this secretive order exists a legend. She too is a shadowdancer, but her skills are far beyond those of others in her trade. She is a genius, a master, and a queen among shadowdancers. She is envied by peers, respected by students, and feared by enemies. She is the queen of shadows.

To become a queen of shadows, a female character must develop a sense of spirituality and discipline that many cannot master. For her, the shadows are a friend, an ally, a lover, and a soulmate. Where others find a cold, uncaring touch in the darkness, the queen of shadows finds warmth. The queen of shadows worships and covets the darkness but equally respects the light. She knows that there cannot be one without the other and that not all heroes wear shining armor and champion their causes on the fields of war. Those marked by villainy and greed often seek her skills, as do noble kings and protectors of free lands. She is hunted by those desperate to both steal her power and master her skills.

THE QUEEN OF SHADOWS

Class Level	Base				Special
	Attack Bonus	Fort Save	Ref Save	Will Save	
1st	+1	+1	+3	+1	Queen of Shadows Ability
2nd	+2	+1	+4	+1	Queen of Shadows Ability
3rd	+3	+2	+4	+2	Queen of Shadows Ability
4th	+4	+2	+5	+2	Queen of Shadows Ability
5th	+4	+2	+5	+2	Queen of Shadows Ability

Hit Die: d6.

REQUIREMENTS

To qualify to become a queen of shadows, a character must fulfill all the following criteria.

Base Attack Bonus: +8.

Skills: Move Silently 15 ranks, Hide 15 ranks, Perform 10 ranks.

Feats: Dodge, Mobility, Spring Attack, and one feat of the DM's choice.

Special: Shadowdancer level 1+.

QUESTS

- The character must find the three *Scrolls of Deepest Shadow* and read them. The knowledge within the scrolls allows the character to become a queen of shadows.
- At any given time, there may only be one queen of shadows. The current queen, Nadina Shadowstep, is rumored to regularly frequent the Free City Opera House. The character must find, challenge, and defeat Nadina. If successful, the power seed of the queen of shadows will pass to the character.
- The character must enter the plane of shadow and survive there for one full week. During this time, she may not return to the material plane for any reason. If she returns before one week has passed, she must start over.

CLASS SKILLS

The queen of shadows class skills (and the key ability for each skill) are Appraise (Int), Balance (Dex), Bluff (Cha), Climb (Str), Craft (Int), Decipher Script (Int, exclusive skill), Diplomacy (Cha), Disable Device (Int), Disguise (Cha), Escape Artist (Dex), Forgery (Int), Gather Information (Cha), Hide

Special

Queen of Shadows Ability
Queen of Shadows Ability
Queen of Shadows Ability
Queen of Shadows Ability
Queen of Shadows Ability

(Dex), Innuendo (Wis), Intimidate (Cha), Intuit Direction (Wis), Jump (Str), Listen (Wis), Move Silently (Dex), Open Lock (Dex), Perform (Cha), Pick Pocket (Dex), Profession (Wis), Read Lips (Int, exclusive skill), Search (Int), Sense Motive (Wis), Spot (Wis), Swim (Str), Tumble (Dex), Use Magic Device (Cha, exclusive skill), and Use Rope (Dex).

Skill Points at Each Level: 8 + Int modifier.

CLASS FEATURES

All of the following are features of the queen of shadows legendary class.

Weapon and Armor Proficiency: The queen of shadows gains no additional weapon or armor proficiencies. Note that armor check penalties for armor heavier than leather apply to the skills Balance, Climb, Escape Artist, Hide, Jump, Move Silently, Pick Pocket, and Tumble. Also, Swim checks suffer a -1 penalty for every 5 pounds of armor, equipment, or loot carried.

QUEEN OF SHADOWS ABILITIES

Enhanced Dexterity: The queen of shadows is a rogue at heart and the time spent training to become a legend has honed her dexterity to a razor's edge. The character gains a +1 legendary bonus per power level to her Dexterity score. This is a one-time bonus.

Enhanced Charisma: The queen of shadows' mastery of stealth approaches an artform, and her performances are often stunning to those rare few who witness them. The character gains a +1 legendary bonus per power level to her Charisma score. This is a one-time bonus.

Reaching the Shadow (Su): The queen of shadows must first master the arts of shadow-

dancing and improved stealth to become a legend. As a queen of shadows, her prowess with this ability reaches legendary heights. The queen of shadows may hide in plain sight an additional 10 ft. away from a shadow per power level. For example, if Nadina takes this ability at power level three, she can hide in plain sight within 40 ft. of a shadow (base 10 ft. plus 30 ft. for this legendary ability).

Darkvision (Su): Spending most of her lifetime within the cold, dark embrace of the shadows allows the queen of shadows to become more comfortable and effective within them. The queen of shadows gains the darkvision ability with a range of 60 ft. plus 20 ft. per power level. If the character already has darkvision, her range is extended by 20 ft. per power level.

Powered by Shadow (Su): As the shadows envelop the queen of shadows, so too do they enhance the weapons that she uses. She and the shadows are one; the shadows defend her as a loyal knight defends his queen. With this ability, any slashing weapon held by the queen of shadows functions as an enchanted weapon with an enhancement bonus equal to her power level. Once she releases the weapon, the enchantment is lost. The enhancement bonus from this ability does not stack with any other enhancement bonuses.

Legendary Talent (Ex): The queen of shadows is a legend. Her stealth and speed are equally legendary. This ability grants the queen of shadows a +2 legendary bonus per power level to her Hide and Move Silent skill checks, as well as a +1 bonus to her Initiative rolls.

Shadow Sentinels (Ex): The shadows are loyal servants and protectors to the queen of shadows. This loyalty allows the queen of shadows to call upon the protection of her subjects when faced with physical dangers. With this ability, the queen of shadows gains a +1 legendary bonus per power level to her Armor Class and Reflex saving throws while within darkness or heavy shadows.



PATH OF FAITH

Religion is a powerful thing in our world; how much moreso is it in a fantasy world where miracles may be witnessed daily, where the devoted can call upon their deities for aid and where gods may walk the earth?

Religions in fantasy roleplaying move armies, shape nations, and create heroes. *Path of Faith's* purpose is to give players and DMs alike the resources they need to develop those world-spanning forces and their heroic servants.

You'll find prestige classes, a variant core class, and racial faith ceremonies in the pages ahead. These are just a small representation of the new options for clerics, druids, and paladins in *Path of Faith*.

DMs that wish to work with the common fantasy theme of small "territorial" gods will finally be able to create them and specify the powers given to their disciples.

Players will find a wide array of tools to define and refine their clerical characters.

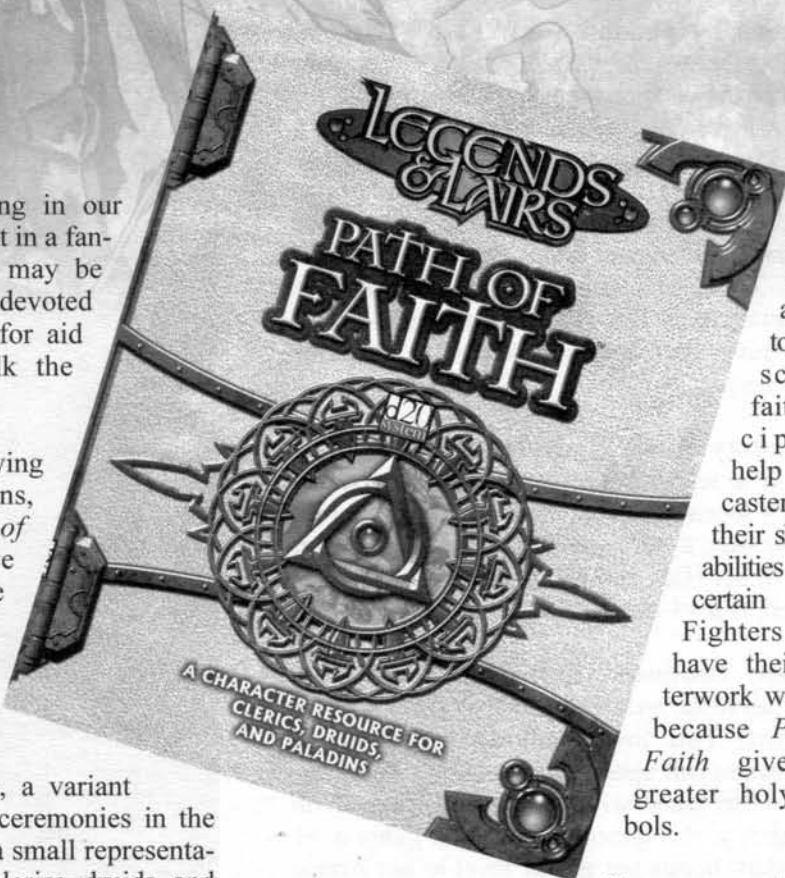

The cleric's answer to combat schools, faith disciplines help divine casters focus their skills and abilities toward certain goals. Fighters can have their masterwork weapons, because *Path of Faith* gives you greater holy symbols.

Now get out there and preach the faith!

All of the names and text in this section describing rules for prestige classes, variant classes, and racial faith ceremonies are considered **Open Game Content**. All background text describing these classes and rituals is considered closed content.

PRESTIGE CLASSES

FAITH GUARDIAN

A faith guardian is a welcome addition to any adventuring party. They are skilled protectors who have devoted their lives to helping others. Harnessing the magical energies around them, faith guardians shield and heal those who travel with them. Rarely do members of this prestige class settle in one place, preferring the open life of the road so they can help as many people as possible. Sometimes several faith guardians band together to act as traveling healers, especially in times of war or pestilence.

Most faith guardians begin as clerics who enjoy the expanded strength of healing and protection offered by this prestige class. However, paladins and druids may also be enticed by the selfless nature of the faith guardian.

Hit Die: d8.

REQUIREMENTS

To become faith guardian, a character must fulfill the following requirements.

Alignment: Any good.

Skills: Alchemy 3 ranks, Concentration 4 ranks, Heal 8 ranks, Profession (herbalist) 4 ranks.

Feats: Skill Focus (Heal).

Spellcasting: Ability to cast divine spells of 1st level or higher.

CLASS SKILLS

The faith guardian's class skills (and the key ability for each skill) are Alchemy (Int), Concentration (Con), Heal (Wis), Knowledge (religion), Profession (Wis), Spellcraft (Int), and Wilderness Lore (Wis).

Skill Points at Each Level: 2 + Int modifier.

CLASS FEATURES

The following are class features of the faith guardian prestige class.

Weapon and Armor Proficiency: Faith guardians are proficient with all simple weapons, all types of armor (light, medium, heavy), and shields.

Spells: A faith guardian remains truthful to her spiritual growth and continues to gain levels in



FAITH GUARDIAN

Class Level	Base Attack	Fort Save	Ref Save	Will Save	Special	Spellcasting
1st	+0	+2	+0	+2	Shield other	
2nd	+1	+3	+0	+3	Sacred ground	+1 of existing level
3rd	+2	+3	+1	+3	Hands of the healer	
4th	+3	+4	+1	+4	Restore mind	+1 of existing level
5th	+3	+4	+1	+4	Elemental sphere	
6th	+4	+5	+2	+5	Field of peace	+1 of existing level
7th	+5	+5	+2	+5	Eyes of the healer	+1 of existing level
8th	+6	+6	+2	+6	Fear of redemption	+1 of existing level
9th	+6	+6	+3	+6	Divine resilience	+1 of existing level
10th	+7	+7	+3	+7	Soul of the healer	+1 of existing level

divine magic. Thus for every two levels of faith guardian gained, the character gains new spells per day as if she had also gained a level in a divine spellcasting class that she belonged to before adding the prestige class. However, she does not gain any other benefits that would normally be associated with the other class such as increased undead turning. If a character had more than one divine spellcasting class before she became a faith guardian, she must decide to which class she adds each level of faith guardian for purposes of determining her spells per day. She cannot add the new level to an arcane spellcasting class.

Shield Other (Sp): The faith guardian can cast *shield other* at will, but may only ward one creature at a time.

Field of Peace (Su): At 2nd level, a faith guardian can designate an area of peace around her that discourages fighting. She can use this supernatural ability once per day and it lasts one round per level. The field of peace covers a 10-ft. radius around the faith guardian and moves with her. Enemies and allies within the field attempting to strike or otherwise act in aggression must make a Will save (DC 15 + faith guardian's Wisdom modifier). Failing the save means that the creature cannot attack or take any aggressive action in that round. A successful save means that a character is not affected by the field of peace for that round attack. If the faith guardian takes any aggressive action while the field is active, the effect immediately ends and the character is considered fatigued for the rest of the battle.

Hands of the Healer: Upon reaching 3rd level, a faith guardian becomes more skilled at healing wounds. All of her spells that restore lost hit points heal an additional point of damage per class level and she gains a +2 circumstance bonus to all Heal checks.

Restore Mind (Sp): Faith guardians strive to protect the mind as well as the body from harm. At 4th level, a faith guardian can *break enchantment*, as per the spell, once per week.

Elemental Sphere (Su): At 5th level, a faith guardian generates a small sphere of protection against elemental damage that moves with the character. The sphere absorbs the first two points of damage each round from acid, cold, electricity, fire, and sonic sources (natural and magical). This protection extends to all creatures within a 10-ft. radius.

At 10th level, the sphere absorbs the first 5 hit points of damage each round.

Sacred Ground (Su): At 6th level, once per day, a faith guardian can declare an area around her to be consecrated. This creates a supernatural barrier that covers a 20-ft. radius around the faith guardian. This barrier does not move until the character leaves it or wills it to end, or when someone within the barrier takes an aggressive action. Undead creatures and evil outsiders that come into contact with the barrier will find it an impassable wall.

Eyes of the Healer (Ex): Beginning at 7th level, a faith guardian has complete mastery over her healing magic. All her healing spells

that required touch can be cast with range of Close (25 ft. + 5 ft./2 levels).

Fear of Redemption (Sp): At 8th level, a faith guardian can project an impression of supernatural wonder that inspires fear in those who would cause great harm. Three times per day as a spell-like ability, a faith guardian can target an enemy with the fear of redemption. This power floods the enemy's mind with images of eternal punishment and divine wrath. This ability acts in all ways as a *symbol (fear)* spell cast by a 20th-level sorcerer.

Divine Resilience (Ex): At 9th level, a faith guardian gains damage reduction 1/–, as the power of her faith makes her incredibly resilient to damage.

Soul of the Healer (Su): Upon reaching 10th level, a faith guardian understands the very flow of life. She can now transfer her own life energy into other creatures in order to heal them more quickly. The character may now heal characters with her own hit points, at a rate of two points of healing for every hit point so lost. Thus, if a faith guardian sacrificed 10 hit points, she could heal 20 hit points of damage to a touched creature. This may also be used as an attack, harming undead at the same rate on a successful melee touch attack. The faith guardian may sacrifice up to five hit points per point of Wisdom modifier per day with this ability.

TRUE CRUSADER

Some come for the glory, others for money, but a chosen few come because they are divinely inspired. The crusader is a warrior with a mission and a purpose. Huge armies of these champions are often brought together under one banner to fight for some noble goal. However, many of them are not true crusaders. These special warriors are blessed and carefully watched over by the heavenly sponsor that chose them.

True crusaders can come from almost any background, from the lowliest farmer to the most heroic knight. Although each is unique, all crusaders have one feature that ties them together: they are chosen to complete a quest. This quest could be finding a lost holy relic, overthrowing a wicked monarch, or whatever happens to be in the deity's designs. A true cru-



TRUE CRUSADER

Class Level	Base Attack	Fort Save	Ref Save	Will Save	Special	Spellcasting
1st	+1	+2	+0	+0	Divine strength, loyalty	+1 level of existing class
2nd	+2	+3	+0	+0	Sworn enemy	+1 level of existing class
3rd	+3	+3	+1	+1	Divine strength 2/day	+1 level of existing class
4th	+4	+4	+1	+1	Devoted warrior	+1 level of existing class
5th	+5	+4	+1	+1	Divine strength 3/day	+1 level of existing class
6th	+6	+5	+2	+2	Holy shield	+1 level of existing class
7th	+7	+5	+2	+2	Divine strength 4/day	+1 level of existing class
8th	+8	+6	+2	+2	Heroes from beyond	+1 level of existing class
9th	+9	+6	+3	+3	Divine strength 5/day	+1 level of existing class
10th	+10	+7	+3	+3	Aura of strength	+1 level of existing class

sader's quests are most often given through a vision, a dream, a manifestation, or through an intermediary like a cleric or an oracle.

Once begun, a true crusader must try to complete his quest and may continue to add levels in this prestige class once the quest is completed. Any character may become a true crusader but it is most favored by paladins since they can take it without the multilevel restriction normally placed on their class. As such, a paladin may still take levels in his paladin class even after taking the true crusader prestige class.

Hit Die: d10.

REQUIREMENTS

To become a true crusader, a character must fulfill the following requirements.

Wisdom: 14+.

Alignment: Lawful good.

Base Attack Bonus: +5.

Spellcasting: Ability to cast divine spells.

Special: The character must be given a holy quest by a deity.

CLASS SKILLS

The true crusader's class skills (and the key ability for each skill) are Concentration (Con), Climb (Str), Diplomacy (Cha), Heal (Wis), Intuit Direction (Wis), Jump (Str), Knowledge (religion) (Int), Listen (Wis), Profession (Wis), Scry (Int), Search (Int), Sense Motive (Wis), Swim (Str), and Spellcraft (Int).

Skill Points at Each Level: 2 + Int modifier.

CLASS FEATURES

The following are class features of the true crusader prestige class.

Weapon and Armor Proficiency: True crusaders are proficient with all simple and martial weapons, with all types of armor, and with all shields.

Spells: The true crusader continues to grow in his knowledge of magic throughout his studies. Thus when a new true crusader level is gained, the character gains new spells per day as if he had also gained a level in a divine spellcasting class that he belonged to before adding the prestige class. If a character had more than one divine spellcasting class before he became a true crusader, he must decide to which class he adds each level of true crusader for purposes of determining his spells per day.

Loyalty: The true crusader cannot willingly jeopardize his success or lose interest in the holy quest that has been set before him. Doing so without just cause invokes the punishment of the sponsoring deity, who may strip the true crusader of all his special class abilities.

Divine Strength (Su): When the journey becomes tough and the need is great, a true crusader can call on his sponsoring deity to grant him a small boon that makes him stronger, quicker and more durable. As a supernatural ability, a true crusader can invoke divine strength to temporarily gain a +2 sacred bonus to Strength, Constitution, and Charisma. This blessing lasts for a number of rounds equal to 3 + the character's Wisdom modifier. A true cru-

sader can call upon divine strength only once per battle and only a certain number of times per day (determined by level). Calling on divine strength is a free action.

Sworn Enemy: At 2nd level, a true crusader chooses a sworn enemy from a religion that opposes his own. Against creatures, followers, and clerics of the chosen religion, a true crusader gains a +2 circumstance bonus to attack and damage. This is an extraordinary ability and the bonus does not apply to creatures immune to critical hits or when the character does not know of his opponent's religious affiliation.

Devoted Warrior (Ex): Beginning at 4th level, a true crusader becomes so zealous, so caught up with his purpose, that he can force his body to withstand extreme punishment. If reduced to 0 hit points, a true crusader is not considered disabled, but still takes 1 point of damage after completing any action. From -1 to -9 hit points, a true crusader may remain conscious by making a Fortitude save (DC 15). If the crusader fails this roll, he goes unconscious. If he succeeds, he remains standing and is considered fatigued (suffering a -2 penalty to Strength and Dexterity, and unable to run or charge.) His chances for stabilization are standard and he still loses one hit point per round until stabilized. The fatigue ends once the character's hit points are brought above 0.

Holy Shield (Su): At 6th level, a true crusader can summon forth a magical shield to aid him in battle. This shield conveys a +2 bonus to AC and radiates a small aura of protection against evil or good, which is chosen upon acquiring this ability and does not change. Opponents of the chosen alignment suffer a -1 penalty to attack and damage against a character wielding this shield. However, no one other than the true crusader may handle this shield, which can be summoned or dismissed at will as a free action.

Heroes From Beyond (Sp): At 6th level, a true crusader gains the ability to summon help once per day. This requires one full round action to perform and calls forth 1d4+1 3rd level fighters who will help the true crusader in any reasonable way they can. Although these are spiritual warriors and have no real ties to the material plane, they will not follow ridiculous or suicidal orders such as jumping into an active volcano or walking down a trap-infested tunnel.

The fighters remain for one round per level or until killed.

Hero From Beyond: Medium-size outsider; HD 3d8+6+3; hp 22; Init +5; Spd 20 ft; AC 18; Atk +5 melee (1d8+2), +4 ranged (1d8); AL: LG; SV Fort +5, Ref +4, Will +4; Str 15, Dex 12, Con 14, Int 12, Wis 12, Cha 10.

Skills: Climb +8, Jump +8, Ride +8, Spot +4, Swim +8; **Feats:** Toughness, Improved Initiative, Power Attack.

Equipment: Splint mail, large steel shield, longsword, composite longbow, 20 arrows.

Aura of Strength (Su): At 10th level, a true crusader can pass on the blessing bestowed by divine strength to those around him. Allies within a 10-ft. radius of a true crusader gain the bonuses to Strength, Constitution, and Charisma when the true crusader calls upon divine strength. They lose these bonuses should they leave the aura's area of effect.

VARIANT CLASSES

This section offers a variant core class—a new version of the cleric class designed for players to take at first level.

FAITH CASTER

For many, faith is a weapon in times of the greatest darkness. True faith is unshakable when faced with even the greatest odds. It moves mountains, determines the victors of battle, and allows the downtrodden to overcome what is thought to be impossible. It is faith that attracts so many like-minded followers to the teachings and beliefs of a patron god. For a well-known deity, these followers can number in the hundreds of thousands. Each offers a piece of themselves to a deity in hopes of receiving a small glimmer of hope, spiritual guidance, and leadership.

It is from within these legions of followers that an oddity among the faithful



emerges. She is a cleric in many aspects, teaching the word of her patron god and defending his beliefs in the face of adversity. But unlike other clerics or warriors of the cloth, she is special, granted abilities unlike those of her fellow worshippers. She is the faith caster.

Adventures: Like the cleric, the faith caster is a champion of her faith and to the teachings of her patron deity. Of course, the teaching of her deity greatly influence her actions in life. For example, good faith casters work to help people and defeat the evil influences of the world around them. Evil faith casters strive to see the weak brought beneath them and the influence of their evil gods spread across the lands like a plague.

The faith caster is a living extension of her god's will and is granted abilities above and beyond those of conventional clerics. It is this distinction that endangers the life of a faith caster, as she becomes a target for enemies of her faith, or those who do not understand her power. As a result, she must travel the land in search of willing students, potential slaves, or daring adventurers, depending on her alignment.

Alignment: There are faith casters of all alignments, just as there are clerics. They are almost equal in number, as the number of worshippers a particular god has is irrelevant to how he doles out his divine power. Faith casters tend more toward chaos than clerics, just as sorcerers eschew the structured training of a wizard's school.

Religion: As mentioned, there is at least one faith caster active within the ranks of each deity's followers. In these cases, the solitary faith caster may be revered as a living embodiment of a god's will and placed into a position of authority. Other faiths may see the occurrence of faith casters as common practice.

Oddly, it is the deity of magic and knowledge who boasts the most prolific amount of faith casters among his followers. Sages speculate that it is the god's comprehension of arcane studies that allow him to bestow the gifts of the faith caster among so many of his faithful.

Background: Much like the sorcerer, the faith caster begins to display extraordinary talents and abilities at puberty. But unlike a sorcerer, the faith caster displays talents of a divine nature. These talents may manifest in the form

FAITH CASTER

Level	Base				Special	Spells Per Day									
	Attack Bonus	Fort Save	Ref Save	Will Save		0	1	2	3	4	5	6	7	8	9
1	+0	+2	+0	+2	Spontaneous casting	3	1+1	-	-	-	-	-	-	-	-
2	+1	+3	+0	+3		4	2+1	-	-	-	-	-	-	-	-
3	+1	+3	+1	+3		4	2+1	1+1	-	-	-	-	-	-	-
4	+2	+4	+1	+4		4	3+1	2+1	-	-	-	-	-	-	-
5	+2	+4	+1	+4		4	3+1	2+1	1+1	-	-	-	-	-	-
6	+3	+5	+2	+5		4	3+1	3+1	2+1	-	-	-	-	-	-
7	+3	+5	+2	+5		4	4+1	3+1	2+1	1+1	-	-	-	-	-
8	+4	+6	+2	+6		4	4+1	3+1	3+1	2+1	-	-	-	-	-
9	+4	+6	+3	+6		4	4+1	4+1	3+1	2+1	1+1	-	-	-	-
10	+5	+7	+3	+7		4	4+1	4+1	3+1	3+1	2+1	-	-	-	-
11	+5	+7	+3	+7		4	4+1	4+1	4+1	3+1	2+1	1+1	-	-	-
12	+6/+1	+8	+4	+8		4	4+1	4+1	4+1	3+1	3+1	2+1	-	-	-
13	+6/+1	+8	+4	+8		4	4+1	4+1	4+1	4+1	3+1	2+1	1+1	-	-
14	+7/+2	+9	+4	+9		4	4+1	4+1	4+1	4+1	3+1	3+1	2+1	-	-
15	+7/+2	+9	+5	+9		4	4+1	4+1	4+1	4+1	4+1	3+1	2+1	1+1	-
16	+8/+3	+10	+5	+10		4	4+1	4+1	4+1	4+1	4+1	3+1	3+1	2+1	-
17	+8/+3	+10	+5	+10		4	4+1	4+1	4+1	4+1	4+1	4+1	3+1	2+1	1+1
18	+9/+4	+11	+6	+11		4	4+1	4+1	4+1	4+1	4+1	4+1	3+1	3+1	2+1
19	+9/+4	+11	+6	+11		4	4+1	4+1	4+1	4+1	4+1	4+1	4+1	3+1	3+1
20	+10/+5	+12	+6	+12		4	4+1	4+1	4+1	4+1	4+1	4+1	4+1	4+1	4+1

PATH OF FAITH

of an exceptional ability to treat wounds, nightly visions, a drastic change in hair color (such as from black to white), or the appearance of a birthmark that resembles a deity's holy symbol. This period of time is crucial for the young faith caster, as some cultures may perceive these odd traits as bad omens or signs of demonic influence.

If allowed to grow and learn, the faith caster develops her talents and her connection with her patron deity, eventually understanding what she is and what she can do. If successful enough to master her gifts and truly embrace the path laid before her, the faith caster can become anything she chooses. Whether this is a spiritual leader, a tyrant following the whims of a maniacal god, or a simple sage studying the lost wonders of the world is up to the player and DM to decide.

Race: Most faith casters are humans or elves, as the path is of a more magical than traditionally clerical nature. That said, a faith caster can appear in any racial profile and on behalf of any deity. In fact, the most powerful faith caster to date is rumored to be an ancient eye tyrant

hidden deep within the bowels of the Underdark.

Other Classes: Naturally faith casters find a close kinship with other characters of divine backgrounds (clerics, paladins, and druids), as they tend to share an understanding of the divine cosmology that others may not comprehend. Wizards and sorcerers tend to respect the spellcasting prowess of the faith caster, while bards, monks, fighters, rogues, and barbarians are indifferent to her.

GAME RULE INFORMATION

Faith casters have the following game statistics.
Abilities: Like the cleric, Wisdom determines how powerful a faith caster's spells will be, how many she can cast per day, and how difficult her spells are to overcome. To cast a spell, a faith caster must have a Wisdom score of 10 + the selected spell's level. A faith caster receives bonus spells based on her Wisdom. The DC of saving throws to resist the faith caster's spells are 10 + the selected spell's level + the faith caster's Wisdom ability score modifier. Also, as a rare follower of her

faith, the faith caster may rely on her Charisma score for diplomatic relations and intimidation tactics.

Alignment: Any (as typically determined by the alignment of the faith caster's patron deity).

Hit Die: d6.

CLASS SKILLS

The faith caster's class skills (and key ability for each skill) are: Concentration (Con), Craft (Int), Heal (Wis), Knowledge (arcana) (Int), Knowledge (religion) (Int), Listen (Wis), Profession (Wis), and Spellcraft (Int).

Skill Points at First Level: (2 + Int modifier) x 4.

Skill Points as Each Additional Level: 2 + Int modifier.

Starting Gold: 5d4x10.

CLASS ABILITIES

All of the following are class features of the faith caster.

Weapon and Armor Proficiencies: Faith casters are proficient with the club, dagger, heavy crossbow, light crossbow, and quarterstaff. They are also proficient with light armor, but not shields. Note that armor check penalties for armor heavier than leather apply to the skills Balance, Climb, Escape Artist, Hide, Jump, Move Silently, Pick Pocket, and Tumble.

Spontaneous Divine Spells: The faith caster casts divine spells. Unlike clerics who must prepare spells for each day, the faith caster may select her spells from the cleric spell list as she needs them, provided that she can cast spells of that level or type (alignment restrictions that would normally apply to a cleric also apply to the faith caster). The DC of saving throws to resist the faith caster's spells are 10 + the selected spell's level + the faith caster's Wisdom ability score modifier.

The faith caster meditates or practices a daily ritual aligned with the doctrine of her patron deity's faith. Though she need not prepare her spells in advance, she must still practice the rituals of praise and worship to her deity. If she is unable to perform such a ritual, she does not gain new spells for the day and may not use

any domain abilities until she does.

Domains: Faith casters choose two domains from their deity's list at the time they are created. They gain the domain abilities of both, and like their other spells, they may choose which domain spell to cast each day spontaneously, as needed. A faith caster's domain spells, unlike a cleric, are not added to her list of available spells, so she may not cast them spontaneously other than as her one domain spell per day.

RACIAL FAITH CEREMONIES

The following ceremonies use the rules for ceremony design found in *Spells & Spellcraft*.

Just as there are ceremonies for each of the different class types, the different races have ceremonies of their own. In this section, ceremonies for some of the races found in the PHB are explored, along with some information on how ceremonies can be strengthened by the number of participants, and the steps necessary to coordinate large groups of people when performing a ceremony. All of the ceremonies presented in this section are religious in nature and require all members to be of the same faith, as well as race.

Though it is certainly possible for members of another race to receive the benefits of a racial faith ceremony (such as the frequent requests by humans for elven healing ceremonies), it is a rare event. In most cases, outsiders who request such personal ceremonies must prove themselves worthy of the gift by performing some quest, bestowing a particularly rich offering, or otherwise displaying their goodwill and appreciation for those whose aid they seek. In some cases, particular races may have agreements through which they exchange ceremonial benefits, strengthening ancient ties and reminding one another of the alliances of ages past.

The ceremonies presented herein are not tied to any particular deity, but rather to the entire pantheon of creative forces linked to each of the races. Though elves, for example, may have a dozen different gods, none of these ceremonies invoke any one of these deities by name—

instead, they call upon the racial elements common to all the deities, which makes many of the ceremonies quite powerful indeed. All of the ceremonies found herein are not meant to be performed lightly; while a very powerful cleric may find himself able to perform a ceremony single-handedly, others will need assistance in order to succeed.

FOLLOWERS AND CEREMONIES

A racial faith ceremony is always performed by one or more clerics. Though some races hold druids in high regard, only clerics understand enough of the ritual and theological underpinnings of the racial faiths to successfully perform one of these ceremonies. One of these clerics must be the leader, the ultimate coordinator of the litanies and ceremonial rites necessary to successfully produce the desired effect. He may have a number of assistants equal to one-half of his current level. All assistants must have at least one level of cleric and may not have more levels of cleric than the leader's current clerical levels minus one. For each assistant involved in the ceremony, a number of followers equal to one half the assistant's total clerical levels may also be involved, providing their own belief and faith to help bring the ceremony to fruition.

These assistants do not reduce the DC of the ceremony, but for every four followers involved, the leader of the ceremony receives a +1 circumstance bonus to his Spellcraft check to perform the ceremony. This bonus may never exceed +10. At the end of a ritual, the priest acting as the leader must make a Spellcraft roll against the ritual's DC in order to see if the ritual succeeds.

The leader, assistants, and all followers involved in the ceremony must all be of the same race (and racial sub-type, so wood elves and high elves cannot work together, for example) and must share the same essential faith. Dwarves from two different clans who venerate the same essential pantheon, even though the exact details of the deity names and particulars may be somewhat different, may assist one another during a racial faith ceremony. Dwarves from the same clan who worship very different gods, however, may not help one another in a ceremony—it is the combination of race and faith that is necessary for these cer-



emonies to function properly.

The leader of a ceremony will know within a few moments of the ceremony's beginning whether or not all those involved are of the proper race and faith. A successful Knowledge (religion) check (DC 15 + number of assistants and followers involved in the ceremony) will identify one individual who is not compatible with the ceremony (whether due to race or religion) for every 5 full points by which the leader of the ceremony succeeds at the check. This skill check requires a full five minutes to conduct, during which time the leader of the ceremony must continue to go through the motions of the ceremony, even knowing the ceremony will fail.

When outsiders infiltrate a ceremony in this way, it will always fail and the participants must wait at least five days before they may attempt the ceremony again. Because of this, most ceremonial sites are carefully protected and hidden in areas where other races will be less likely to slip in undetected. The penalties for such invasions by other races vary, but most communities will take the disruption of a sacred religious rite very seriously and have no trouble killing or imprisoning intruders.

DWARVEN FAITH CEREMONIES

Amongst the dwarves, most ceremonies center on ensuring the survival of the community against hostile threats or the many natural hazards of life far below the ground. Unless otherwise noted, all of the ceremonies listed below must be performed below the ground in a mine or dwarven forge that has been in use within the past five days. Always a practical people, the dwarves are most easily able to draw upon the power of their faith when their ceremonies are performed in areas where work has taken place in the recent past.

DWARVEN COMPONENTS

Dwarves may provide a +1 circumstance bonus to the Spellcraft checks of a ceremonial leader for every 500 gp worth of metals, either raw or forged, or gems in materials expended during the ritual. These components must come from the labor of the community performing the ritual or, if several communities are involved, in the forge or mine from which the materials were worked or extracted from the earth. The bonus provided by these components

may never exceed +5.

EMBRACE OF FLOWING STONE

The dwarves are aware of the treacherous nature of the earth in which they make their homes. Rockslides and cave-ins claim the lives of miners from every clan, and the rare flood has been known to burst forth from a mine to wipe out an entire dwarven settlement. Of all these threats, however, lava remains the one that is not only deadly, but potentially very useful as well. The flows of lava can be used by dwarves to construct tunnels of their own, and the flowing rock can also be used as a source of heat and light.

Some dwarven clans regard lava as a protector of the earth, a deadly snake of crimson rock and liquid steel that lashes out at those who are too foolish or too ignorant to avoid its crimson tongue. These clans venerate active lava flows and have learned to use them in their religious ceremonies. The Embrace of Flowing Stone is the most common of these ceremonies and is known to most dwarven clans.

When the ceremony is complete, anyone who took part in its performance may dip a hammer or axe into the lava to temporarily grant the weapon a +2 enhancement bonus and the flaming burst special ability (DMG, Magic Item Descriptions). These improvements last for 1d4+1 days.

Note that neither of these enhancements applies to weapons that are already magically enhanced in any way.

Caster Requirements: A 10th-level cleric to lead the ceremony and enough assistants to coordinate the activities of all the followers who wish to take part in the ceremony. For this ceremony only, no followers who take part in the ceremony provide any bonus to the ceremony's leader, though the number of followers is still limited as detailed above (see Followers and Ceremonies).

Time Requirements: This ceremony requires two hours of preparation and one hour to perform.

Place Requirements: The ceremony must take place below ground and within sight of an active lava flow.

Material Components: This ceremony requires the sacrifice of one small ruby (100 gp or greater value) for each follower and assistant taking part in the ceremony. The dwarves must inscribe their name on the ruby prior to the ceremony's performance.

Preparation: The cleric leading the ceremony instructs the dwarves taking part in it as to the proper method for inscribing their names upon their ruby. The process is time consuming and involves much concentration and praying as the cleric and his assistants help the followers properly prepare their components for the ceremony.

The Ceremony: A lengthy prayer to the dwarven deities is offered up, calling on each of them in turn to bless the assembled dwarves and to calm the spirits inhabiting the lava. As the prayer comes to an end, each of the dwarves steps forward and drops his ruby into the lava flow. As the ruby disappears into the lava, the dwarf may then place the head of his weapon into the lava. If the ritual is a success, all of the weapons will flare to life as the cleric closes the ceremony and be wreathed in a brilliant orange glow. If the ceremony fails, however, the weapons will crumble to blackened ash the instant the ceremony ends.

Ritual DC: 20.

ELVEN FAITH CEREMONIES

For the elves, life is a journey with no end in sight. They live their lives lightly on the land, doing their best to protect the natural world around them and enjoy their lives to the fullest. Sadly, many elves find themselves set upon from many sides and must make war against neighbors they would much rather dwell with in peace. The elven ceremonies detailed below were designed to assist the elves in their times of need, granting them an edge in their battles and allowing them to avoid those fights that they would rather not wage.

ELVEN COMPONENTS

Elves value items of beauty, particularly works of art or things with magical properties. For every 500 gp worth of art objects or magical items sacrificed during the performance of a ceremony, an elven cleric gains a +1 circumstance bonus to the Spellcraft checks made to perform the ritual. This bonus may never go above +5.



SHADOWS OF ELVENKIND

For all their peaceful ways and wise demeanor, the elves are willing to fight tooth and claw to protect their homeland. The elves of the Divawi Shade learned long ago they could not wage an open battle and have any chance of success, and so they took to the shadows. Since that time they have shared the details of this ceremony with other elven peoples, allowing those with low birth rates and few numbers to successfully battle against

more numerous enemies.

When this ceremony is complete, all shadows within 10 miles of the site at which the ceremony was performed willingly embrace any elf who belongs to the community that performed the ritual. This provides a +10 circumstance bonus to any Hide checks made within the affected area and a +5 circumstance bonus to any Move Silently checks. Additionally, any elf who makes a sneak attack from hiding while this ceremony is active may immediately attempt to hide again as if he had not been exposed.

Caster Requirements: A 10th-level elven cleric who lives within the area to be affected by the ceremony. This cleric must be able to cast the *true seeing* and *freedom of movement* spells.

Time Requirements: This ceremony takes a full eight hours to complete and four hours of preparation.

Place Requirements: This ceremony must take place in a forest in which the performing elves live.

Material Components: The elves must sacrifice a tree that is at least 100 years old in order to perform this ceremony.

Preparation: The leader, assistants, and followers who are going to perform the ritual must gather around the tree to be sacrificed. One by one, they bite into the tree with a ceremonial dagger, carefully circumscribing the trunk of the tree. When an inch-wide wound has been hewn into the side of the tree, the elves each kiss the naked flesh of the tree and take a bite from the fibrous tissue. This opens the connection between the elves and the tree, allowing them to commence the ceremony, using the tree to forge a bond with the rest of the wood. Though the tree dies, its location will forever after be marked with a stark white circle upon the ground.

The Ceremony: With the tree stripped and ready for sacrifice, the leader of the ceremony begins singing the history of the tree and the people who dwell around it. The names of elves who lived and died within the forest are inscribed into the wound inflicted upon the tree, and the followers cry out their names in agony as they

feel the pain given to the tree.

As the ceremony progresses, the elves spill their blood upon the soil around the tree and the leader of the ceremony rubs the crimson fluid into the names he carved into the tree. Each of the followers of the ceremony is then gifted with a short vision from the lives of those who came before, tying them back to the land and their ancestors.

At the height of the ceremony, the tree bursts into shadow flames. Tongues of pitch black fire race up and down the bark, stripping it away and releasing small bat-like wisps of ash and shadow. These wisps then race through the forest and, where they pass, the shadows grow deeper and longer, providing cover for the elves.

The effects listed above last for one day for every 10 elves involved in the ceremony, but may never last longer than a single week. Though it may not seem like a long time, the elves of Divawi Shade were able to drive out an entire clan of orcs before the effects of the ceremony faded, killing them from the shadows with their deadly archery.

Ritual DC: 25.

HALF-ORC FAITH CEREMONIES

Like the half-elves, half-orcs are caught between two worlds. On the one hand, they are the product of the orcish blood running in their veins: nasty, brutish, and angry at the world in general. On the other hand, they are very much human, capable of transcending their heritage to achieve great feats and quite adaptable to a wide variety of situations. Half-orcs, then, attempt to draw upon the best of both worlds in their ceremonies, pulling elements from the orcish pantheon as well as the human deities of their ancestors.

HALF-ORC COMPONENTS

Half-orcs always use weapons and armor in their ceremonies, though the precise types vary from area to area. Most of the components used in this way represent a merging of orcish strength with human finesse, producing some of the finest weapons seen outside of a dwarven forge. For every 500 gp worth of arms and armor (either magical or mundane) used in a ceremony, the half-orc who leads the ritual receives a +1 circumstance bonus to any

Spellcraft checks made during the ceremony.

RITUAL OF RESILIENT BLOOD

The hardiness of the orc and the flexibility of the human are bound together in this ritual, which can drastically increase a half-orc's survivability. Known primarily to the barbarians of the Ultera Naku glacier, this ceremony is freely shared with other half-orcs, provided they are willing to partake of the ceremony with the barbarians.



When performed, all of the half-orcs who take part in the ceremony receive a +1 bonus to their Constitution and Dexterity. These bonuses last until one week has passed, but may be increased by the actions taken by the half-orc. Each worthy creature (a creature with a CR at least equal to the half-orc's current levels) that the half-orc solely defeats in combat increases the bonus for one of the abilities, chosen by the half-orc. Note that these bonus increases must alternate (if Constitution is chosen first, for example, then Dexterity must receive the second increase), and a maximum of +4 can be applied to either ability.

Caster Requirements: A half-orc cleric of at least 9th-level must lead this ceremony.

Time Requirements: This ceremony takes 8 hours to complete but no preparation time is necessary.

Place Requirements: The ceremony must take place on the site of a great battlefield. If humans or orcs were the primary combatants during the battle, the leader of the ceremony receives a +1 circumstance bonus to all Spellcraft skill checks made during the ceremony.

Material Components: There are no material components required for this ceremony.

Preparation: The only preparation required for this ceremony is a gathering of several half-orcs.

The Ceremony: The ceremony is simple and straightforward—the half-orcs brandish their weapons and chant the names of the deities of battle they venerate. Led by the cleric, the ceremony rises to a fever pitch as the half-orcs vent their rage and draw into their spirits the violence and rage of battle. The ceremony almost always ends in battle as the orcs charge out to face whatever enemy prompted the performance of the ceremony in the first place.

Though it happens only rarely, there are times when the half-orcs allow humans into their ceremonies. This is most common when a threat to both human and half-orcs presents itself. When humans are involved in these ceremonies, an additional four hours is required as the humans are inducted into the half-orc people as honorary half-orcs.

Ritual DC: 20.

PATH OF MAGIC

Magic comes in many forms. From necromantic conjurations to fey enchantments, it can be horrible or delightful. Some summon arcane power from hours of tedious study, others bring it forth from the casual strumming of an instrument.

That may be what makes arcane casters so appealing. They're always a bit mysterious, a bit on the outside and the inside at the same time. Sure, everyone knows the rules for casting spells, but the characters that interact with yours never quite know **how** you do what you do . . . all they know is that when your mind-affecting song paralyzes the evil warlord and your gouts of arcane flame turn his minions into heaps of ash, they're glad that you're along.

Path of Magic is about harnessing that mystery for your character and campaign. We've presented a sampling of prestige classes and new feats here to show what sorts of variety and tools the rest of the book can lend to arcane casters.



Those tools include the same kinds of goodies you'll find in the other *Path* books, all designed to augment the arcane. It's got legendary classes like the oracle and elemental lord, variant classes like the arcane engineer and arsenalist, and new rules that turn bards into characters that every party will want along.

All of the text in this section describing rules for and names of prestige classes and feats is considered **Open Game Content**. All background text describing these classes and feats is considered closed content.

PRESTIGE CLASSES

ARCANE NEGOTIATOR

Brazix stands alone, surrounded by the forces of the Black Circle gang and facing impossible odds. The clerics of the dark god laugh and taunt Brazix, speaking of the pain in his near future and asking if the mage has any last words. With a simple smile, Brazix utters a name, and in a flash of light surrounded by an angelic chorus his most trusted ally, Yendel the solar, emerges. Needless to say, the odds are no longer stacked against Brazix.

The arcane negotiator is a prestige class that many wizards, more specifically conjurers, choose in order to gain the service and friendship of powerful outsiders. By using ability modifiers and prepared spell slots each day, the arcane negotiator summons forth her allies to do battle on her behalf. In time, she herself takes on some of the traits of those she calls forth to her service.

Hit Die: d4.

REQUIREMENTS

To qualify to become an arcane negotiator, a character must fulfill the following requirements.

Spellcasting: Must be able to cast 5th-level arcane spells.

Skills: Diplomacy 3 ranks, Knowledge (the planes) 5 ranks, Sense Motive 3 ranks.

Feats: Spell Focus (Conjuration).

Special: The character must specialize in the Conjuration school of magic.

CLASS SKILLS

The arcane negotiator's class skills (and the key ability for each skill) are Bluff (Cha), Concentration (Con), Craft (Int), Diplomacy (Cha), Knowledge (all skills, taken individually) (Int), Profession (Wis), Sense Motive (Wis), and Spellcraft (Int).

Skill Points at Each Level: 4 + Int modifier.

CLASS FEATURES

All the following are class features of the arcane negotiator prestige class.

Weapon and Armor Proficiency: The arcane negotiator is not proficient in any weapon or armor.

Spells per Day: Whenever a new arcane negotiator level is gained, the character gains new spells per day as if she had also gained a level in her previous arcane spellcasting class. However, she does not gain any other benefits that a character would have gained at that level. If the character possessed more than one spellcasting class before she became an arcane negotiator, she must specify which class to advance her new spells with each new level as an arcane negotiator.

Summon Ally I: At 1st level the arcane negotiator can summon forth her first ally. This specialized summoning ritual initially involves the use of candles, long incantations, and a period of concentration no shorter than two hours. After the two hour period has passed, the arcane negotiator rolls percentile dice to determine the ally summoned by her ability. After this first ritual, it merely requires a standard action to enact the summoning. Once the roll is made the ally of the arcane negotiator materializes before her.

d%	Ally
01-25%	Imp
26-40%	Janni
41-60%	Lantern Archon
61-85%	Quasit
86-100%	Hound Archon

Of course, there are issues with the arcane negotiator's alignment and the alignment of the summoned ally to consider. Good aligned arcane negotiators might not find a completely willing ally in the form of a quasit and vice versa for evil arcane negotiators and such beings as an archon. An arcane negotiator can affect the outcome of the summoning in two ways. The first is with a successful Knowledge (arcana) check (DC 20), which allows her to add or subtract from her roll in order to reach a more favorable outcome. She may add or subtract 1% for every point by which she exceeds the DC of her check. The second

method is by knowing the name of the ally the arcane negotiator wishes to summon. Knowing the ally's true name negates any need for a percentile roll and the ally is summoned. DMs should feel free to substitute different possible allies for the ones presented on this list in order to mesh such summonings more closely with their campaign world.

If the summoned ally and the arcane negotiator are of opposite alignments on the good/evil axis, the character must make a successful Diplomacy check (DC 20) each time the ally is summoned or the ally will not perform any actions for the arcane negotiator. Of course, conditional modifiers can adjust the DC of this check in a case-by-case fashion. The ally cannot knowingly harm the arcane negotiator, however, as the summoning ritual prevents that. Once the ally arrives, it can take any of the actions outlined below so long as the arcane negotiator meets the necessary requirements.

The ally and arcane negotiator share the following abilities at all times.

Speech: The ally and arcane negotiator can understand each other regardless of whether or not they share a common language.

Life Sense: The ally and arcane negotiator are aware the instant that either of them dies. Death of the arcane negotiator frees the ally from service (see below for details).

The summoned ally can perform any of the following tasks at the behest of the arcane negotiator, and will do so to the best of its ability. In exchange for this service, the arcane negotiator must invest some of her own magical energy into the summoned creature, an action that the summoning ritual specifically opens the proper channels for. Doing so is a free action.

Combat: If the arcane negotiator removes one of his prepared spells for that day, the ally will enter combat in his service. The ally will remain for a number of rounds equal to the level of the spell removed. Once in combat, the ally acts freely and follows the tactical advice of the arcane negotiator.

Perform Mundane Activities: The ally will use any skill that it possesses at the behest of the arcane negotiator. In addition, it can use special movement to aid the character and her allies (such as shuttling her and her allies over a cliff with its flight) or use its superior physical characteristics to aid the character. Any time it is



ARCANE NEGOTIATOR

Level	Base Attack	Fort Save	Ref Save	Will Save	Special	Spellcasting
1	+0	+0	+0	+2	Summon ally I	+1 level of existing class
2	+1	+0	+0	+3	Great negotiator	+1 level of existing class
3	+1	+1	+1	+3	Ally's gift I	+1 level of existing class
4	+2	+1	+1	+4	Summon ally II	+1 level of existing class
5	+2	+1	+1	+4	Multiple summoning	+1 level of existing class
6	+3	+2	+2	+5	Ally's gift II	+1 level of existing class
7	+3	+2	+2	+5	Summon ally III	+1 level of existing class
8	+4	+2	+2	+6	Multiple summoning	+1 level of existing class
9	+4	+3	+3	+6	Ally's gift III	+1 level of existing class
10	+5	+3	+3	+7	Summon ally IV	+1 level of existing class

asked to use such an ability, the character must divest himself of one prepared spell or spell slot for the day; it does not matter what level spell slot the character chooses.

Use Spell-Like Abilities: An ally will use any spell-like ability it has in exchange for the energy of a spell of the same level from the arcane negotiator (1st-level spells for 1st-level spell-like abilities, etc.). The negotiator can remove spells of higher levels if necessary, but this does not allow for multiple uses of the ally's spell-like ability.

There are several ways to lose a summoned ally. The death of the arcane negotiator frees the ally from service. The death of the ally frees it from service, and it cannot be summoned by the arcane negotiator again. If the arcane negotiator attacks the ally, it is freed from service and cannot be summoned again. This does not normally have an effect, as the character can merely summon another individual of the same type, but if the character loses a named ally in such a way it can be a blow to her power.

The arcane negotiator may use this ability a number of times per day equal to her Intelligence modifier, but she may only have one summoned ally in her service at one time until she reaches higher levels.

Great Negotiator: Over time the character's skill with negotiations improves to an extraordinary level. At 2nd level the arcane negotiator gains a +4 bonus to all Bluff, Diplomacy, and Sense Motive skill checks.

Ally's Gift: Over a period of time, the arcane negotiator begins to exhibit some of the traits of her allies as her affiliation with them grows. At 3rd level, the arcane negotiator can choose one special ability from the list of abilities useable by the ally. The arcane negotiator can choose only one ability from the list below.

- Improved Vision (the character gains low-light vision, or darkvision if she already has low-light; if she has darkvision, her range doubles.)
- +4 bonus to Fortitude saves against poison
- Elemental resistance 5 against one element (acid, cold, electricity, fire, or sonic)
- One spell-like ability from the following list, 3/day: *detect evil*, *detect good*, *detect magic*, *enlarge*, *reduce*, *speak with animals*

Summon Ally II: At 4th level the arcane negotiator gains the ability to summon more powerful allies. She may still choose to summon lesser allies from the list found under the summon ally I ability. The new list can be found below.

d%	Ally
01-25%	Kyton
26-40%	Djinni
41-60%	Avoral
61-85%	Succubus
86-100%	Trumpet Archon

Multiple Summoning: With practice, skill, and an understanding of her allies' powers, the arcane negotiator learns to summon more than one ally at a time. At 5th level, the arcane negotiator can summon up to two allies at a time, though each requires a separate

summoning ritual and counts against her total number of allies for the day.

Ally's Gift II: At 6th level, the arcane negotiator can choose one special ability from the following list of abilities.

- Spell resistance 15
- Elemental resistance 10 against one element (acid, cold, electricity, fire, or sonic). If she chooses the same element as she chose at 3rd level, the resistances stack giving her a total resistance of 15 against a single energy type
- One spell-like ability from the following list, 3/day: *blur*, *charm monster*, *cure moderate wounds*, *detect thoughts*, *gaseous form*

Summon Ally III: At 7th level, the arcane negotiator gains the ability to summon more powerful allies. She may still choose to summon lesser allies from the list found under the summon ally I or II abilities. The new list can be found below.

d%	Ally
01-25%	Erinyes
26-40%	Efreeti
41-60%	Astral Deva
61-85%	Glabrezu
86-100%	Planetar

Multiple Summoning: At 8th level, the arcane negotiator can now summon up to three allies at one time. Each summoning requires a standard action and her number of summoning abilities per day are still reduced, but up to three allies can be active at one time.

Ally's Gift III: At 9th level, the arcane negotiator can choose one special ability from the following list of abilities.

- Spell resistance 20 (does not stack with existing spell resistance)
- Immunity to one element (acid, cold, electricity, fire, or sonic)
- One spell-like ability from the following list, 3/day: *improved invisibility*, *lesser restoration*, *polymorph self*, *remove curse*, *suggestion*

Summon Ally IV: At 10th level, the arcane negotiator gains the ability to summon more powerful allies. She may still choose to summon lesser allies from the list found under any of the previous summon ally abilities. The new list can be found below.

d%	Ally
01-25%	Pit Fiend
26-40%	Noble Djinn
41-60%	Solar
61-85%	Balor
86-100%	Titan

CHANTER

The legendary power of the dwarven chanters has been the source of much scholarly and religious speculation. Many attribute the very success of the dwarven race to this special gift. Ancient dwarven lore speaks of chanters who led their people through the dark undercaverns for weeks at a time, allowing them to outpace enemies who surely would have destroyed them. Other tales speak of incredible mining expeditions that returned with five times the yield thought possible by employing chanters with their mining groups.

Chanters were present in all past dwarven empires, and it is suggested that the ancient kingdom of Lattan could not be shattered until all of its chanters had been assassinated or incapacitated. After the destruction of so much of their power, the chanters were forced to recede and slowly build back their numbers. At the present time, chanters are working their way back into dwarven society. They work as foremen, clergy, advisors, and military personnel. Wherever they go the chanters are able to bring aid and prosperity, and no large dwarven army or community is without several of these powerful allies. Some chanters choose to take up the adventuring life, often to spread the word of their gods or to assert the power and relevancy of the dwarven race. Many were adventurers before they were called to this path and are simply continuing their journeys, albeit with newfound abilities and powers far surpassing what they had achieved before.

Hit Die: d6.

REQUIREMENTS

To qualify to become a chanter, a character must fulfill all the following requirements.

Bardic Music class ability

Constitution: 13+.

Skills: Concentration 8 ranks, Perform 8 ranks.

Feats: Great Fortitude.

CLASS SKILLS

The chanter's class skills (and the key ability for each skill) are Alchemy (Int), Appraise (Int), Balance (Dex), Bluff (Cha), Climb (Str), Concentration (Con), Craft (Int), Decipher Script (Int, exclusive skill), Diplomacy (Cha), Escape Artist (Dex), Gather Information (Cha), Intuit Direction (Wis), Jump (Str), Knowledge (all skills, taken individually)(Int), Listen (Wis), Perform (Cha), Profession (Wis), Sense Motive (Wis), Spellcraft (Int), Tumble (Dex), and Use Magical Device (Cha, exclusive skill).

Skill Points at Each Level: 4 + Int modifier.

CLASS FEATURES

All the following are class features of the chanter prestige class.

Weapon and Armor Proficiency: Chanters are skilled with all simple weapons. In addition, the chanter is proficient with one of the following weapons: greatclub, heavy flail, light flail, light hammer, or warhammer. Chanters are proficient with light and medium armor, but not shields. Note that armor check penalties for armor heavier than leather apply to the skills Balance, Climb, Escape Artist, Hide, Jump, Move Silently, Pick Pocket, and Tumble. Also, Swim checks suffer a -1 penalty for every 5 pounds of equipment carried.

Timing Chant: At 1st level, the chanter learns to use his rhythmic chanting to aid laborers in tedious, repetitive work. The four most common timing chants are the Miner's Song, the Forger's Steel, the Marching Tune, and the Labor Song. In order to initiate the timing

chant, the chanter must chant for a full minute while accompanying himself on a percussion instrument. During this time, all who wish to be affected must join the chant and continue to accompany the chanter for the duration of the effect. The effect of this chanting is to increase the speed and production capabilities of the affected individuals. A chanter confers a +2 bonus per class level to any checks related to



the activity at hand. A military unit might gain a bonus to Constitution checks on a forced march or a group of miners might receive a bonus to their Profession checks to determine the value of their work.

The timing chant is not without a physical toll for those involved, however. At the beginning of each new hour the chanter must make a Perform check (DC 10+# of hours worked). If successful, he continues to inspire his fellows. If he fails his check, however, the chant falters. Anyone affected by the timing chant (including the chanter) must make a Fortitude save (DC 5+# of hours worked) or be forced to stop whatever he is doing and rest as if the timing chant had ended. The chanter may continue the chant with another Perform check (DC 20); if he fails, the

timing chant ends immediately.

At the end of a timing chant, all affected individuals are considered dazed until they rest completely for one hour per hour worked. No magical healing or abilities such as soothing chant will reduce the amount of time needed to shake off the effects of a timing chant.

Endurance: At 1st level, the chanter gains the benefits of the Endurance feat.

CHANTER

Level	Base Attack	Fort Save	Ref Save	Will Save	Special	Spellcasting
1	+0	+2	+0	+2	Timing chant, endurance	+1 level of existing class
2	+1	+3	+0	+3	Soothing chant (1/day)	+1 level of existing class
3	+2	+3	+1	+3	War chant (1/day)	+1 level of existing class
4	+3	+4	+1	+4	Counter chant	+1 level of existing class
5	+3	+4	+1	+4	Continuous spellcasting	+1 level of existing class
6	+4	+5	+2	+5	War chant (2/day)	+1 level of existing class
7	+5	+5	+2	+5	Trance	+1 level of existing class
8	+6	+6	+2	+6	Healing chant (1/day)	+1 level of existing class
9	+6	+6	+3	+6	War chant (3/day)	+1 level of existing class
10	+7	+7	+3	+7	Alapantin's kiss (1/day)	+1 level of existing class

Soothing Chant: At 2nd level, the chanter learns to use his chanting to calm and relax his comrades, speeding the natural healing process. To activate this ability, the chanter must chant for one full hour and be within 60 feet of any character that he wishes to affect. Characters under the influence of a soothing chant may not walk around, memorize spells, heal themselves, eat, or perform any activity other than rest; otherwise they lose the benefits of the chant. Beings affected by the soothing chant recover one hit point per level and recover all subdual damage. Also, any exhausted, fatigued, or nauseated character is relieved of those conditions. Any Heal checks made while a person is under the benefits of the soothing chant gain a +2 morale bonus.

War Chant: Beginning at 3rd level, the chanter is able to inspire his allies and demoralize his foes by leading a fearsome chant in combat. Similar to the bardic ability inspire courage, a war chant not only provides bonuses to his allies but also imposes penalties on his enemies due to the fearsome effect of the chant. Allies of the chanter must participate in the chant and be able to hear the chanter to be affected; enemies must only be able to hear the chanting. Affected allies gain a +1 morale bonus to initiative and a +2 morale bonus to attack rolls, damage rolls and saving throws vs. charm and fear effects. Enemies suffer a -1 penalty to initiative and a -2 morale penalty to attack and damage rolls. During the war chant, the chanter may fight, but he cannot cast spells, activate magic items by spell completion (such as scrolls), or activate magic items by magic word (such as wands). This ability can be used three times per day, for up to one minute per use.

Counter Chant: At 4th level, the chanter gains the ability to "attack" existing spells. By performing a powerful counter chant, the chanter can temporarily suppress magical effects. This works exactly as if the chanter were casting a targeted *dispel magic* spell. For this purpose, the character may add his chanter levels to his arcane spellcasting class levels for the purpose of his dispel check. The spell or spells are not destroyed by the counter chant, however, they are only suppressed for as long as the chanter continues his song. In order to switch targets, the chanter must begin a new counter chant.

Continuous Spellcasting: At 5th level, the chanter is able to boost his concentration by focusing his mind on his song, thus ignoring distractions while spellcasting. While he is reciting this special song, the chanter need not make additional Concentration checks when casting spells for the duration of the chant. In addition, the chant acts as the Verbal component of any spell he casts for its duration. The chanter begins his chant and makes a Concentration check (DC 15). He is then able to maintain incredible focus for one round for every point by which he exceeded the DC. For example, Dartek the Incanter rolls a 22 on his initial Concentration check, and is thus able to cast spells without fear of distraction for seven rounds (22 check result - 15 DC).

It is a full round action to initiate this ability. Because of the incredible mental focus necessary, the chanter must not be interrupted (take damage or be forced to make a saving throw) during the initiation round. If he is, the ability fails to activate and he must spend another round preparing his mind.

Trance: At 7th level, the chanter learns to focus his mind so keenly on one task that he can perform the task indefinitely. After 10 minutes of uninterrupted meditation, the chanter shuts down all mental and physical functions that are not necessary for the task at hand. At this point the chanter begins the set activity (marching, mining, studying, combat, etc.) until a preset condition occurs. For instance, the chanter may have entered the trance to "read until I have read every book in the library."

Trances are never entered lightly, however, because they present a danger to the chanter. The chanter does not eat, drink, or sleep during the trance, straining his body to endure the lack of these vital functions. For every 4 hours that goes by, the chanter must make a Fortitude save (DC 12+# of previous saves), or suffer 1d4 points of temporary Constitution damage. A character brought to 0 Constitution in this way dies immediately.

Regenerative Chant: At 8th level, the chanter learns to use his rhythmic song as a method for biofeedback. By attuning his chant to the natural rhythms of his body, he stimulates his body to heal damage very quickly.

It is a full round action to initiate the regenerative chant. It can be sustained until the chanter is at full hit points at which time the chant fails. During the regenerative chant, the character gains the extraordinary ability fast healing 1.

Alapantin's Kiss: At 10th level, the chanter can channel the power of the earth itself by vocalizing the natural vibrations of the land around him.

He must be in contact with the earth for five full rounds while he chants this powerful song, and if he takes damage during this time he must make a Concentration check as if he were casting a spell. After the 5th round, the chanter channels the power he has summoned to shake the foundations of any structure in contact with the earth. For each round he chants thereafter, to a maximum number of rounds equal to his Constitution score, he may deal 10d6 points of damage to one natural or shaped structure within 500 feet. This may include trees, a mountain, a castle, a building, or any other structure in contact with the earth. Obviously the chanter will not be able to topple a mountain, but he

may deal it enough damage to allow entry into a formerly blocked passage, or create a massive cave-in to impede some subterranean horror. He may shift targets as often as he likes as a standard action as long as the chant is not broken. Other than changing targets, he may only perform movement actions while maintaining the chant, though he may not run. The chanter may perform Alapantin's kiss once per day.

NEW FEATS

The following section describes several new feats for use in any d20 System game. Several of the feats have prerequisites that are also listed as class abilities for certain classes, such as Scribe Scroll for a wizard. If a character has a class ability that mirrors a feat, then that will pass for the appropriate prerequisite. If the character somehow loses this ability, however, he will no longer have access to any feats that require it.

ADEPT MASTERY [GENERAL]

You are talented at mastering the intricacies of spells you cast.

Prerequisites: Int 17+, Spell Mastery.

Benefit: You may double the number of spells you master every time you choose the Spell Mastery ability.

Normal: Without this feat you would only gain a number of mastered spells equal to your Intelligence modifier.

ARCANE ARTISAN [GENERAL]

You are skilled at creating items for magical experimentation.

Prerequisites: Int 13+, Craft skill.

Benefit: You gain a +2 circumstance bonus to all Craft checks when crafting an item to be enchanted, and the cost to create the magic item is reduced by 10%.

ARCANE EXPERTISE [SPECIAL]

You are able to draw upon your spellcasting power to use a weapon with which you are not normally proficient.

Prerequisite: Bard level 3+.

Benefit: You may use a weapon with which you are not proficient without suffering the usual penalty. To do so, however, you must expend one spell level per round in which you use the weapon. This feat represents the ability of bards to act as

though they have some ability even when they are not truly skilled at a task.

Normal: A character who uses a weapon without being proficient with it suffers a -4 penalty on attack rolls.

ARCANÉ SHAPER [METAMAGIC]

You can shape a prepared spell into another effect.

Prerequisite: Quicken Spell.

Benefit: You can change any prepared spell into another spell that you know (but do not necessarily have prepared). The new spell must be at least two levels lower than the spell you are shaping.

ARCANÉ STRIKE [SPECIAL]

You can deliver a touch spell via a melee attack with any weapon.

Prerequisites: Spellcaster level 1+.

Benefit: You may imbue a normal or magical melee weapon with one spell that you have prepared. The spell remains active for up to one round per level, after which time it dissipates harmlessly. If you hit a target with a successful melee attack with the weapon while it is charged, the spell is discharged in addition to normal damage. Only masterwork weapons may be so imbued, and a magical weapon can hold up to one spell per point of enhancement bonus. All spells stored in a single weapon are discharged upon the first successful melee strike. Only the character that cast the spell can cause the weapon to discharge in combat; the weapon functions normally for all other characters.

BARDIC CHANTING [SPECIAL]

You are able to create a mystical performance using chanted verses.

Prerequisites: Bardic music.

Benefit: You are able to use expanded bardic music abilities (see *Path of Magic*, chapter 3).

CRAFT ELDRITCH STAFF [ITEM CREATION]

You have found the raw materials for your eldritch staff and are now able to create and wield this item of power.

Prerequisite: Able to cast 1st-level arcane spells.

Benefit: You are able to create and wield an eldritch staff and attune new elements to its arcane matrix (see *Path of Magic*, chapter 5).

COUNTERSPELL RİPOSTE [METAMAGIC]

You can attack instantly following a successful counterspell.

Prerequisites: Arcane spellcaster level 1+.

Benefit: When you successfully perform a counterspell action, you can then instantly cast another prepared spell in response. The spell selected for a riposte must not have a casting time of greater than one action. The spell prepared for a riposte uses up a slot two levels higher than the spell's actual level.

COMPPELLING SONG [GENERAL]

Your ability to *fascinate* others through bardic music is greater due to your compelling voice and captivating songs.

Prerequisites: Cha 15+, Perform 6 ranks, bard level 1+.

Benefit: While using your bardic music ability to *fascinate* creatures, you gain a +4 circumstance bonus to your Perform check.

DECEPTIVE CASTING [GENERAL]

You are able to fool rival spellcasters who attempt to counterspell you by using false somatic components during casting.

Prerequisites: Int 13+, Bluff 1 rank.

Benefit: Choose a number of spells equal to your spellcasting-dependent ability modifier, with this feat you may now use the Bluff skill to create false (yet effective) somatics to fool counterspelling opponents. By doing this, you make a Spellcraft skill check against a Spellcraft check of your opponent. If you succeed, the opponent believes that your spell is different from the one you are casting and prepares the wrong counterspell. If you fail, your opponent sees through your ruse and prepares the correct spell (if possible).

Special: If you have 5 or more ranks in the Bluff skill you gain a +2 synergy bonus to your Spellcraft check to fool a rival spellcaster's counterspell attempt.

ELDRITCH DEFENSE [GENERAL]

You are able to survive otherwise deadly injuries by supplementing your life force with arcane energy.

Prerequisite: Spellcaster level 3+.

Benefit: When an attack would reduce you to 0 or fewer hit points, you can instantly expend one of your spell slots for the day as a

free action to reduce the damage. You suffer one less hit point of damage per spell level thus expended. The character may only do this once per day and cannot expend more than one spell slot at a time.

ENHANCED FAMILIAR [GENERAL]

The bond between you and your familiar is so powerful that it enhances the familiar's abilities.

Prerequisite: *Summon familiar* ability.

Benefit: For the purpose of determining your familiar's abilities, you are treated as if you are two levels higher than your actual level.

Special: A character can gain this feat multiple times and its benefits stack.

EXPERT BARDIC KNOWLEDGE [SPECIAL]

You are able to coax information from the most reluctant of subjects – magic items.

Prerequisites: Perform 6 ranks, any two of Bardic Chanting, Bardic Dancing, Bardic Instrumental, or Bardic Singing.

Benefit: You are able to identify the properties of magic items by entering a trance-like mystical performance. Though time consuming, this is the surest method for uncovering the secrets of such powerful objects.

To use this feat, the bard must be alone with the item and have plenty of time to enter his trance and explore the item's magical resonances. After 1d4 hours, the bard slips into a performance trance. Each hour after this, he is allowed to make a single Perform check (DC 20). If the check succeeds, the bard discovers one of the item's functions and understands how that function is activated. If the bard exceeds the DC by 10 or more, he uncovers two of the item's functions and how to activate them. Conversely, if a bard fails two of his Perform checks in a row, he is unable to divine any more useful information about the item. He may investigate the item again after achieving a level, but is otherwise unable to determine anything about the item.

The bard may continue exploring the item for up to eight hours, after which he must receive a full night's rest before he can use this feat again.

INTERCEPTING VOICE [GENERAL]

Your ability to countersong against spellcasting

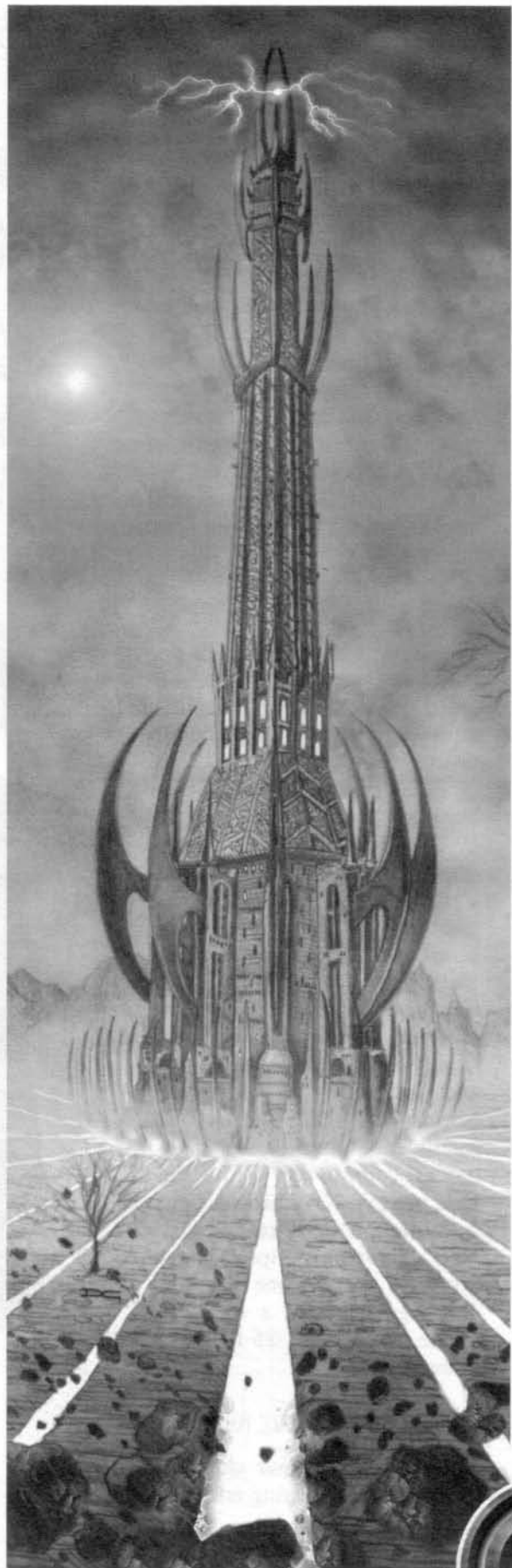

opponents is improved by your penetrating voice.

Prerequisites: Cha 15+, Perform 3 ranks, bard level 1+.

Benefit: While using your bardic music to *countersong*, you gain a +4 circumstance bonus to your Perform check.

QUICK LEARNER [GENERAL]

You pick up new skills quickly and master them in a short amount of time.

Prerequisites: Int 15+.

May only be taken at 1st level.

Benefit: You gain one bonus skill point every level.

Special: This bonus skill point stacks with the bonus point granted to humans.

RAPID SCRIBING [METAMAGIC]

You are able to scribe scrolls you know at a very rapid pace, provided you are willing to sacrifice more experience to accelerate the process.

Prerequisites: Scribe Scroll.

Benefit: When determining how long it takes to scribe a scroll, you must spend one day per 2,000 gp in the scroll's base price. For spells that cost less than 2,000 gp, you may scribe multiple scrolls in the day, provided their total value does not exceed 2,000 gp and you scribe a number of scrolls no greater than your Intelligence modifier in a single day. You must pay 1/15th the base price in XP when scribing scrolls at this faster rate.

Normal: Spellcasters normally require one day per 1,000 gp value of a scroll to scribe it and pay 1/25 the base price in XP.

REDUCED SPELL FAILURE [GENERAL]

You can reduce your chance of arcane spell failure while wearing armor in which you are proficient.

Prerequisite: Dex 13 +, Armor

Proficiency (appropriate to the armor worn).

Benefit: Reduce your arcane spell failure percentage by 10%.

Special: A character may gain this feat multiple times, but each time it must apply to a different class of armor (light, medium, or heavy).



SONGS OF THE SUGGESTIVE SIREN [GENERAL]

Your voice and songs carry greater power when attempting to make a *suggestion* to a *fascinated* creature.

Prerequisites: Cha 17+, Perform 9 ranks, bard level 1+.

Benefit: While using your bardic music to make a *suggestion*, your DC to resist this ability is increased by two, changing the DC to 15 + your Charisma modifier.

Normal: Without this feat, the DC to resist your *suggestion* would be 13 + your Charisma modifier.

SONGS OF TRIUMPH [GENERAL]

Your ability to recall stories of great triumph improves your ability to inspire others.

Prerequisites: Cha 15+, Perform 6 ranks, bard level 1+.

Benefit: While using your bardic music to *inspire courage*, you grant allies a +4 morale bonus to saving throws against charm and fear effects, as well as a +2 morale bonus to attack and weapon damage rolls.

Normal: Without this feat, you would only grant a +2 morale bonus to saving throws and a +1 morale bonus to attack and weapon damage rolls.

SPELL EFFECTS [GENERAL]

You can add, subtract, or otherwise modify the sensory effects of any spell you cast.

Prerequisite: Ability to cast spells

from the Illusion school.

Benefit: Through the use of illusions, you may alter any of the sensory effects of any spell you cast. This alteration includes the addition and subtraction of elements, so that, for example, a *fireball* might glow with a greenish hue or a *magic missile* might take on the shape of a shard of glass. None of these alterations can affect the way a spell works. Thus, a *fireball* could be made to appear like a ball of ice but the spell would still deliver fire damage rather than cold damage.

Special: At the DM's discretion, particularly unusual or out of the ordinary alterations may increase the DC of Spellcraft checks to identify the spell by as much as five.

SPELLBOOK MASTERY [SPECIAL]

You learn more spells upon achieving a new level.

Prerequisite: Int 15+, Spellcraft 5 ranks, must prepare spells from spellbook.

Benefit: Upon gaining a new level, you gain a number of new spells of any level or levels that you can cast (according to your new level) equal to your Intelligence modifier.

Normal: Each time a wizard achieves a new level, she gains two new spells of any level or levels that she can cast (according to her new level).

SUPERIOR FAMILIAR [GENERAL]

Your familiar gains a feat.

Prerequisite: *Summon familiar* ability.

Benefit: By taking this feat, your familiar gains a new feat of its own, provided that it meets the prerequisites, if any, for that feat. This new feat is usable only by the familiar, except insofar as its benefits are transferable to another. Should the familiar permanently die or be dismissed, the master can choose a new feat for his familiar.

THRIFTY WIZARD [GENERAL]

You have a talent for fitting extra spells into your spellbook.

Prerequisites: Int 13+, wizard level 1+.

Benefit: The number of pages required for a spell to be copied into your spellbook is reduced by one, to a minimum of one.

VOICE OF INNER STRENGTH [GENERAL]

Your ability to *inspire greatness* is greater due

to the power of your inner strength, which you share with allies through song and story.

Prerequisites: Cha 17+, Perform 15 ranks, bard level 1+.

Benefit: While using your bardic music to *inspire greatness*, you grant the following boosts to an ally:

- +4 Hit Dice (d10s that grant temporary hit points)
- +4 competence bonus on attacks
- +1 competence bonus on all saving throws

Normal: Without this feat, your *inspire greatness* ability would only grant +2 HD, a +2 bonus to attacks, and a +1 bonus to Fortitude saving throws.

WORLDLY KNOWLEDGE [GENERAL]

You are wizened to the world and have the knack for picking up various facts and stories.

Prerequisites: Bardic knowledge. May only be taken at 1st level.

Benefit: You gain a +2 circumstance bonus to all bardic knowledge checks and Gather Information check.



SPELLS & SPELLCRAFT

Spells & Spellcraft is d20 system magic the way it was meant to be. You want magic items that will improve as you do? We've got rules for that. You want to build constructs that aren't just cookie-cutter golems? We've got rules for that. You want your character to be able to spend time, money, and energy doing research and alchemical experimentation . . . and actually be rewarded for it? We've got rules for that.

The book has options, too, for the sort of magic we've always imagined and read about in fiction but haven't seen in the d20 core rules. Haven't we seen wizards inscribe protective runes with more flexibility and more of a power range than allowed by basic spells? Haven't we watched sorcerers gather hard-to-find materials as spell components to make their spells more potent? Haven't we marvelled at heroic wizards shaping the raw power of magic and blasting their foes with it?

At the risk of sounding redundant, we've got rules for that.



To whet your appetite, we've presented some great crunchy bits in this sample section. You'll find new spells, rules for improving your familiar (at last!), systems for designing small gods, and a few druidic rituals to replicate the mysticism that should be present when an animal companion is summoned or a grove is consecrated.

All of the text in this section describing rules for and names of spells, familiar enhancements, and rituals is considered **Open Game Content**. All background text describing these spells, enhancements, and rituals is considered closed content.

NEW SPELLS

BLACK CLOUD OF HORROR

Evocation [Fear, Mind-Affecting]

Level: Clr 3

Components: V, S

Casting Time: 1 action

Range: Medium (100 ft. + 10 ft./level)

Effect: Cloud that spreads 30 ft. and is 20 ft. high

Duration: 1 round/level (D)

Saving Throw: Will partial (see text)

Spell Resistance: Yes (see text)

This spell creates a stationary cloud of black mist that has two effects. First, it obscures sight, including darkvision, beyond 5 feet. Creatures within 5 feet are treated as if they have one-half concealment (imposing a 20% miss chance for attacks). Those farther than 5 feet away have total concealment, which imposes a 50% miss chance, and the attacker cannot use sight to locate his target. There is no saving throw against these effects, nor does spell resistance apply. In addition, any creature caught within the vapors is affected as if by a *cause fear* spell. The *black cloud of horror* manifests the fears of each creature in an attempt to drive them away. A Will save is allowed to resist the fear; otherwise, the creatures react as if influenced by *cause fear*. Spell resistance also applies against the fear effect.

A moderate wind, such as that created by *gust of wind*, breaks up the cloud in 4 rounds. Stronger winds disperse the cloud in 1 round. Fiery spells, such as *fireball* or *wall of fire*, burn away any portion of the cloud with which they come into contact.

The *black cloud of horror* cannot be used underwater.

BURROWING BONY DIGITS

Necromancy

Level: Sor/Wiz 4

Components: V, S, M

Casting Time: 1 action

Range: Medium (100 ft. + 10 ft./level)

Target: Up to five creatures, no two of which



can be more than 15 ft. apart

Duration: See text

Saving Throw: Reflex partial

Spell Resistance: Yes

By means of this fiendish spell, you cause up to five skeletal fingers to streak forth and imbed themselves in the flesh of the targets. Each digit inflicts 1d6 points of damage upon striking its target. They do not stop there, though.

Any creature that failed its Reflex save was unable to extract the bony digit before it could lodge itself into the wound. The bony digit continues to penetrate the creature's body for one round for every 3 levels of the caster, dealing 1d6 damage per round. Once the bony digit is lodged in the wound, it cannot be extracted.

A creature can only be targeted by one finger at a time.

Arcane Material Components: Five humanoid fingers stripped of flesh and muscle. The individual finger bones must then be tied together with black thread.

CRESCENDO OF INDEFATIGABILITY

Enchantment [Mind-Affecting]

Level: Brd 1

Components: V

Casting Time: 1 action

Range: Personal

Area: You

Duration: 1 round/level

By means of this single, pure note, you acquire great resolve toward succeeding at a specific task whose outcome is determined by a single die roll. This task can be an attack roll, a damage roll, a saving throw, an ability check, or a skill check. The task must be specified at the time of casting. The bard enjoys a +2 inspiration bonus on the relevant die roll for the duration of the spell.

DIG

Transmutation

Level: Clr 2, Dru 2, Sor/Wiz 2

Components: V, S, M/DF

Casting Time: 1 action

Range: Medium (100 ft. + 10 ft./level)

Target: Up to one 20 ft. by 20 ft. by 20 ft. cube

Duration: Instantaneous

Saving Throw: See text

Spell Resistance: Yes (see below)

This spell instantly clears out a section of earth and piles the remains nearby. The area cleared can be up to a 20 ft. by 20 ft. by 20 ft. cube or a 10 ft. by 10 ft. by 40 ft. area. A smaller area can be designated as well. The dirt cleared is piled nearby, creating evidence of what has occurred. You may affect any earthen material with a hardness of 5 or less.

If used against a creature with the Earth subtype, this spell deals 2d6 points of damage + 1 per caster level. A successful Fortitude save negates the damage entirely.

Material Component: A lump of clay molded into the shape of a shovel.

DIRGE OF THE WALKING DEAD

Necromancy

Level: Brd 2, Clr 3

Components: V

Casting Time: 1 action

Range: Medium (100 ft. + 10 ft./level)

Target: One living creature

Duration: Concentration, up to 1 round/ level (D)

Saving Throw: Will negates (harmless)

Spell Resistance: Yes (harmless)

By means of this spell, you enable one living creature within range to continue to act normally even if its hit points have been reduced to 0 or below. If you are somehow rendered unable to sing, the spell is negated immediately. When the spell is negated, the target does not suffer any additional damage, but immediately suffers the effects appropriate to its current hit point level (meaning, usually, that he is unconscious and slowly bleeding to death). If your target is reduced to -10 or fewer hit points, it dies immediately even if under the influence of this spell.

DIVINE HEART

Necromancy

Level: Clr 2

Components: V, S, DF

Casting Time: 1 action

Range: Touch

Target: Living creature touched

Duration: 10 minutes/level

Saving Throw: None

Spell Resistance: Yes (harmless)

This spell is prized by good-aligned clerics for its ability to protect against fear effects, allowing them to attempt even more heroic deeds. *Divine heart* makes the subject immune to all fear effects, both magical and mundane.

FLEET FEET

Transmutation

Level: Clr 2, Drd 2, Rgr 2

Components: V, S, M/DF

Casting Time: 1 action

Range: Close (25 ft. + 5 ft./2 levels)

Target: One creature/level

Duration: 1 round/level

Saving Throw: Will negates (harmless)

Spell Resistance: Will negates (harmless)

You increase the base speed of several creatures within range. For the duration of the spell, all affected creatures have their base speeds increased by 10 ft. *Fleet feet* only affects land speed. It cannot increase, for example, speed while swimming or flying.

Arcane Material Component: A roadrunner feather.

NECROTIC BLAST

Necromancy [Evil]

Level: Sor/Wiz 5

Components: V, S, M

Casting Time: 1 action

Range: Medium (100 ft. + 10 ft./level)

Area: 20-ft.-radius spread

Duration: Instantaneous

Saving Throw: Reflex half

Spell Resistance: Yes

This spell taps into the dark energies generated in fresh corpses as the creature's soul leaves its material prison. In order to cast this spell, there must be fresh humanoid corpses (no more than a week old) within the range of the spell. During the casting, the necrotic energies in the corpses are drawn into a ball between your hands. You then hurl the ball at your target, causing damage to all living creatures within a 20-ft. radius.

Each corpse provides 1d6 damage (max. 10d6). The necrotic blast also automatically spoils food and water and corrupts holy water within the blast radius. One pound of food, one gallon of water, or one vial of holy water is ruined for each die of damage the necrotic blast possesses.

Negative energy protection provides protection from this spell. Undead caught within the blast are actually healed, gaining a number of hit points equal to the damage rolled.

Arcane Material Components: Translucent gemstone of any sort worth at least 50 gold pieces.

PERIVAX'S POISON PILLAR

Conjuration (Creation)

Level: Clr 6, Drd 5

Components: V, S, M/DF

Casting Time: 1 action

Range: Medium (100 ft. + 10 ft./level)

Area: Cylinder (5-ft. radius, 40 ft. high)

Duration: Instantaneous

Saving Throw: Fortitude negates

Spell Resistance: Yes

Perivax's poison pillar produces a vertical column of rancid poison that cascades downward onto its targets. Any creature struck by the pillar must make a successful Fortitude save or take 1d10 points of temporary Constitution damage; one minute later the creature must



make another save or suffer an additional 1d10 points of temporary Constitution damage.

QUAKE THRUST

Evocation
Level: Sor/Wiz 1
Components: V, S, M
Casting Time: 1 action
Range: 20 ft.
Effect: Upheaval in a 20 ft. radius centered on you
Duration: Instantaneous
Saving Throw: Reflex negates
Spell Resistance: No

This spell allows you to cause an upheaval in any solid ground around you. You must be standing on a stretch of ground at least 50 ft. deep for this spell to work, so you could not cast it on the deck of a ship or the second story of a home.

Upon casting this spell, all creatures of Large size or smaller within a 20 ft. radius must make Reflex saves or be thrown to the ground by the violent upheaval. Creatures with more than two legs or that are otherwise more stable than normal gain a +4 bonus on their Reflex saves. This spell does not affect flying creatures or creatures otherwise not standing on the ground.

SLIPPING THE RANKS

Transmutation [Teleportation]
Level: Brd 2, Sor/Wiz 2
Components: V, S
Casting Time: 1 action
Range: Personal
Target: You
Duration: 1 round/level

You gain the power to perform a 10-foot teleportation in place of a 5-foot step. Moving in this manner does not provoke an attack of opportunity, and is subject to all the normal rules governing a 5-foot step. If the area you arrive in is occupied by a solid object, you become trapped in the astral plane. Returning from the astral plane can be accomplished in the same manner as described under dimension door.

TITAN'S STRENGTH

Transmutation
Level: Brd 4, Clr 4, Sor/Wiz 4, Strength 4
Components: V, S, M/DF
Casting Time: 1 action
Range: Touch
Target: Creature touched
Duration: 1 minute/level
Saving Throw: Will negates (harmless)
Spell Resistance: Yes (harmless)

The subject becomes able to perform great feats of strength, even those that his body would not normally tolerate. These feats may range from moving a boulder out of a doorway or holding up a large part of a falling building long enough for trapped townsfolk to escape. The character gains an effective Strength score of 40 for performing activities such as lifting, holding, bracing, and the like. His strength is unchanged for the purpose of combat, though using this spell to drop boulders on opponents is certainly an option.

Arcane Material Component: A piece of granite about the size of a fist.

WEIGHTLESS CUBE

Transmutation
Level: Brd 2, Sor/Wiz 2
Components: V, S, M
Casting Time: 1 action
Range: Medium (100 ft. + 10 ft./level)
Effect: 20 ft. cube in which gravity does not exist
Duration: 1 minute/level
Saving Throw: See text
Spell Resistance: No

This spell creates an invisible 20-ft. cube in which normal gravity does not exist. The cube completely negates all gravity effects in the affected area. A character that pushed off the ground would sail to the full height of the cube, where he would float half in and half out of the cube as if submerged in water. If placed over a pit, chasm, or other obstacle, the weightless cube would allow characters to sail across as if flying, landing on the other side of the cube harmlessly.

Any character entering the cube without knowledge of its presence must make a Reflex save or spin out of control, landing forcefully on the other side of the cube and sustaining 1d4

points of subdual damage. The creature also falls prone. A creature that runs or charges into the weightless cube automatically fails its Reflex save and is thrown 10 ft. past the cube's edge on the opposite side, suffering 2d4 points of subdual damage and falling prone.

Arcane Material Component: An empty box.

IMPROVING A FAMILIAR

Over time, spellcasters may choose to develop their familiars by enhancing their abilities or even giving them new ones. Although this slows the spellcaster's personal development, there are many benefits to having a strong familiar. Boosting a familiar can give it more skill points, feats, and special powers that could enhance its master's abilities and even save his life.

FAMILIAR GROWTH

Familiars normally develop powers and abilities as their masters grow in strength. The mystical bond between familiar and master strengthens with time and proximity. While this connection is more than enough for many sorcerers and mages who would rather devote their time and energy to personal development, some grow to value their familiars as companions and friends. Some mages merely come to understand their familiar's utility and seek to further increase the abilities of this valuable asset. In either case, it is possible for a character to channel some of his life energy into his familiar, giving it extraordinary powers and abilities.

A familiar always grows through its master's gifts and does not gain experience on its own. The master chooses how much experience

goes to his familiar and when. The process is simple: the familiar's master must acquire a special incense, costing 100 gp per burning, and meditate over the familiar for one hour per 1,000 XP being transferred. A master cannot take back experience given to a familiar, nor can a master give so much experience that it would cause him to lose a level. If the mage chooses to give his familiar less XP than necessary for the desired effect, that XP will reside within the familiar until the transfer is complete. There is no limit to the amount of time in between rituals. If the familiar or his master dies, this unspent XP is lost, even if the master is brought back to life.

SPECIAL POWERS

All familiars become magical beasts once they bond with their master, and many gain special powers as a result of the transformation. The familiar's master may also transfer some of his XP into the familiar granting it additional abilities. Some allow a familiar to grant a bonus to its master, others aid the familiar itself. In order to provide its master a bonus, the familiar must be within 5 ft. of the master. These bonuses do not stack. For example: Nalani's familiar Tibul gives the sorceress cold resistance 5. Tibul cannot take the same power again to increase its master's resistance to cold, but he could take it again to give Nalani resistance to fire. Nalani



may still use other means to increase her resistance to cold as normal.

In all special power descriptions, the term "master level" refers to the arcane class level of the familiar's master. All abilities are supernatural unless otherwise noted.

POWER DESCRIPTIONS

Alter Form: The familiar has a single alternate form, which can be any object of the same size as the creature. The form must be chosen when the ability is granted. The familiar can hold this form as long as it wants. Changing into an object negates any other bonuses usually given to the master even if it is within 5 ft.

Blindsight: The familiar gains blindsight to a range of 30 ft. See MM for more details.

Blink: Three times a day, for 1 round per master level, the familiar can blink in and out of the ethereal plane, as per the *blink* spell.

Breath Weapon: The familiar has a breath weapon of any type (acid, cold, electricity, fire, or sonic) that causes 3d6 damage (Ref save DC 14 for half). The breath weapon may be used three times per day. The master must decide what type of damage and the shape of the attack (cone or line) at the time it is bestowed.

Breathe Air: The familiar can breathe air in addition to its normal respiration.

Breathe Water: The familiar can breathe in water in addition to its normal respiration.

Burrow: The familiar can dig and burrow through the ground, gaining a movement

rate of burrow 15 ft. This is an extraordinary ability.

Constrict: On a successful grapple roll the familiar can crush an opponent of its size category or smaller, dealing twice his normal unarmed damage. This is an extraordinary ability.

Corporeal: The familiar may become corporeal twice per day for up to one minute at a time. The familiar must be naturally incorporeal in order to gain this ability.

Cute: The familiar has an otherworldly beauty about it that makes it seem adorable. This mild Enchantment effect gives it a +2 on its NPC reaction roll. Any creature with hostile intentions toward the familiar must roll a Will Save (DC 10) in order to attack it.

Damage Reduction: The familiar gains damage reduction 5/+1.

Darkvision: The familiar gains darkvision up to 60 ft.

Disease: The familiar carries a viral infection that is transmitted through its primary attack. The disease has a one minute incubation period and causes 1d4 temporary Constitution damage. The Fortitude save to resist the infection is DC 12.

Displace: The familiar gains the ability to appear as if under the effect of a *displacement* spell. It may activate this ability at will as a move-equivalent action.

Energy Drain: The familiar's primary attack inflicts one negative level in addition to normal damage. The Fortitude save to remove the negative level is DC 12.

Energy Resistance: The familiar gains energy resistance 20 against one energy type (acid, cold, electricity, fire, or sonic).



FAMILIAR SPECIAL POWERS

Special Power	XP Cost	Special Power	XP Cost
Alter Form	300 XP	Glow	125 XP
Blindsight	500 XP	Immunity (T)	1,500 XP
Blink	720 XP	Improved Grab	250 XP
Breath Weapon	750 XP	Incorporeal	500 XP
Breathe Air	720 XP	Invisible	300 XP
Breathe Water	720 XP	Low-light Vision (T)	250 XP
Burrow	100 XP	Poison	500 XP
Constrict	100 XP	Rage	750 XP
Corporeal	250 XP	Regeneration	2,000 XP
Cute	250 XP	Scary	250 XP
Damage Reduction	300 XP	Scent (T)	250 XP
Darkvision (T)	400 XP	See Invisibility (T)	400 XP
Disease	200 XP	Size Increase	1,000 XP
Displace	1,200 XP	Smite	300 XP
Energy Drain	500 XP	Speak Language	100 XP
Energy Resistance (T)	750 XP	Spell-Like Ability	Spell level squared x 100 XP
Etherealness	750 XP	Trip	100 XP
Fast Healing (T)	1,000 XP	Turn Resistance (T)	250 XP
Flying (winged)	250 XP		
Flying (wingless)	500 XP		
Gaseous Form	600 XP		

(T) indicates that the master also gains this ability if the familiar is within 5 ft.

Etherealness: The familiar can enter the ethereal plane for up to 1 minute per day. The time may be divided into non-consecutive rounds, and the familiar may move back and forth as a standard action.

Fast Healing: The familiar gains fast healing 1 as an extraordinary ability.

Flying (winged): The familiar gains a new movement rate of fly 50 ft. in addition to its normal movement. This is an extraordinary ability.

Flying (wingless): The familiar gains the ability to fly at a speed of 90 ft.

Gaseous Form: Three times per day, the familiar can change itself into *gaseous form*, as per the spell. It can hold this form for up to 1 minute and cannot perform any actions aside from movement during this time.

Glow: The familiar can shed light similar to a torch. Activating this ability is a free action and does not hinder the creature in any way.

Immunity: The familiar gains immunity to one energy type: acid, cold, electricity, fire, or sonic.

Improved Grab: If the familiar hits with a normal attack it can perform a grapple check as a free action without provoking an attack of opportunity. This works exactly like the ability as outlined on MM 9.

Incorporeal: The familiar may become incorporeal for up to 1 minute at a time, three times per day.

Invisibility: The familiar may turn invisible as a free action for a number of minutes per day equal to its master's level. The familiar may use this ability as many times as it likes as long as the total duration of the invisibility does not exceed its maximum. This ability functions just like the *invisibility* spell in all other respects.

Low-light Vision: The familiar gains low-light vision.

Poison: The familiar's primary attack can deliver a deadly poison in addition to

normal damage. The poison deals 1d4/1d4 points of temporary Strength damage. The Fortitude save to resist this effect is DC 14. This ability is usable three times per day.

Rage: The familiar can enter a bloodthirsty rage three times per day. During the rage it gains +2 Strength, +2 Constitution, and a +1 morale bonus on Will saves, but suffers a -2 to AC. The rage lasts for 5 rounds. This is an extraordinary ability.

Regeneration: The familiar gains regeneration 1 as an extraordinary ability. Fire, acid, and magical effects all deal normal damage to the familiar.

Scary: The familiar has an unsettling aura surrounding it at all times. This works as a mild fear effect and gives the familiar a -2 on its NPC reaction roll. Any creature with hostile intentions toward the creature must make a successful Will Save (DC 15) or furiously attack the object of its fear, receiving a -4 penalty on all attack and damage rolls against the familiar.

Scent: The familiar gains Scent as an extraordinary ability, as detailed on MM 10.

See Invisibility: Familiars with this power can see *invisible* at will as per the spell. A familiar cannot help target an invisible creature, but it can alert its master to the creature's presence and general location.

Size Increase: The familiar grows one size category, gaining all the benefits and disadvantages of the new size.

Smite: Once per day, the familiar may attempt a smite attack against creatures of a particular alignment. The spellcaster chooses the alignment aspect that this ability targets upon granting his familiar the power, and he may not choose to target creatures with an aspect of his alignment. Thus, a chaotic good sorcerer may only grant his familiar the ability to smite law or evil. This attack works exactly like a paladin's smite evil ability.

Speak Language: The familiar can speak one language known by its master. The level of conversation is still based on the intelligence of the familiar.

Spell-like Ability: The familiar gains the ability to cast one spell, three times per day, as a spell-like ability. The caster level of the spell is always the minimum necessary, and the saving throw is 12 + spell level.

Trip: A familiar that hits with its primary attack may attempt to trip any opponent of its size or smaller as a free action that does not provoke an attack of opportunity. If the attempt fails, the opponent may not react to trip the familiar.

Turn Resistance: Only available for undead familiars. The familiar gains +2 turn resistance.

SMALL GODS

Not all sources of divine blessings are as potent and broad as those typically available to clerics. Whether lesser gods of a polytheistic religion, devas and totems of a pantheistic religion, or powerful spirits of animism or ancestor worship, worship of less powerful beings has its own merits. These less powerful beings of worship are known as small gods.

Small gods are more likely to lend direct aid to their followers. They are concerned about the welfare of their people, though this can be a drawback at times. Small gods disciples are often subject to limits in how far their power may grow, but the benefits may be worth the limitation. Since small gods are more directly involved with their followers, they may expect more from them as well. Divine manifestations are much more common for worshippers of a small god, and the being may task his followers on a regular basis.

Most small gods can be based on outsiders listed in the core rules. Any creature of at least CR 5 may have a few worshippers, but most are at least CR 9. True gods, by comparison, are at least CR 24. The challenge rating of a small god is used to determine various effects.

DIVINE SPECIAL QUALITY

All small gods have the divine special quality. This quality allows a small god to sense requests for intercession and to channel the power of believers into spells for her disciples. The domains that a small god may grant access

SMALL GOD QUALITIES

Small god CR	Highest Disciple Level	Number of Disciples*	Number of Worshippers Necessary
5	1	1	100
6	2	3	400
7	3	7	1,100
8	4	15	2,600
9	5	31	5,700
10	6	63	12,000
11	7	127	24,700
12	8	255	50,200
13	9	511	101,300
14	10	1,023	203,600
15	11	2,047	408,300
16	12	4,095	817,800
17	13	8,191	1,636,900
18	14	16,383	3,275,200
19	15	32,767	6,551,900
20	16	65,536	13,105,500
21	17	131,071	26,212,600
22	18	262,143	52,426,900
23	19	524,287	104,855,600
24	20	1,048,575	209,713,100

*Disciples refers to divine spellcasters.

to are indicated in parentheses. Divine creatures act as their own divine focus for spellcasting purposes. This quality is inherently linked to the number of followers that the small god has at any given time.

A small god can support a pyramid of disciples, starting with one who is at least four divine casting levels below its challenge rating. Each level below the first disciple has twice as many as the previous. So a CR 18 small god could support one 14th-level disciple, two 13th-level disciples, four 12th-level disciples, and so on.

For each level of spellcasting disciple, there must be 100 non-spellcasting members of the religion. Worshippers provide the spiritual energy that a spirit needs to bestow divine magic. A small god can only delegate as much spiritual energy as described above. Small gods with more worshippers may control larger territories, but cannot generate more energy for disciples. True gods may have many guises, and are worshipped across entire worlds and possibly on many at the same time. Not all small gods follow this pattern. In some cases, gods can channel power to a smaller number of more powerful disciples. In this case, each shift

down in the number of followers shifts up the highest follower level possible for that small god.

Killing off disciples is an effective way of eliminating the power of small gods. As the number of worshippers drop, they support fewer disciples. As the flow of divine energy falters, some followers may lose higher level spells, while others may be stripped of their spellcasting abilities completely.

DISCIPLE ABILITIES

Small gods disciples sacrifice long term power for more direct contact with their god. Only the most powerful small gods are able to grant access to domain spells and abilities, and the power of the spells they can grant is limited as well. However, small gods are more likely than true gods to intervene on behalf of their disciples, even allowing themselves to be called with some frequency. Although the form that their aid takes may vary, small gods disciples benefit from their more personal connection to their god.



INTERCESSION

Once a week, any follower of a small god may pray for an intercession. The disciple makes a divine spellcaster level check against a DC of the small god's CR +2. If successful, the divine being directly aids the worshipper in some way.

A character may attempt multiple intercession calls during a week, but each additional attempt in the same week (regardless of previous success or failure) adds a cumulative +5 to the DC. Most small gods will get annoyed at this, and often indicate their displeasure at

being hounded by their followers.

If successful, the deity will intervene in some fashion. At the very least, a helpful effect is generated, which may range anywhere from an orison to the small god itself showing up and assisting directly. Under some circumstances, a small god will not react immediately but choose to act later. Additionally, if the event is important to the god in question, it may choose to intervene with no formal request. Small gods can and do intervene when the fate of a community is at stake, or when rival gods or other powerful beings are attacking their followers. It must be stressed that most gods prefer to work through others. Much of the point of granting spells and powers to followers is so that they may perform the will of the god. A cleric that asks for intervention continually rather than using the gifts his god has granted him may be required to fulfill an *atonement*.

In animist or pantheist religions, the spirits do not necessarily have any particular liking for their disciples. Worship is more of an exchange. A follower may offer entertainment, some item the spirit desires, or may be assisted in exchange for not bothering the spirit. Ancestor worship is much the same. Though ancestors are interested in the general welfare of their family line, the form this takes may not please their descendents. In all of these cases, calls for intercession are often answered grudgingly or as the repayment of a favor.

GREATER SPIRITS

Any small god with a CR of 18 or greater is considered a greater spirit. Greater spirits are less likely to directly intervene in the affairs of their disciples, but they offer much greater power in return. Disciples of greater spirits are granted access to one domain, like the cleric of a true god. This domain must be related to the spirit's area of influence, and the DM has final say on all small gods' domains.

RANGE OF INFLUENCE

The amount of territory in which a god is worshipped is based on its population. A CR 7 small god may be followed in a small number of hamlets, a rural region, or perhaps only in one small town. Greater spirits are conceivably worshipped throughout large nations or in broad regions. In effect, a small god has influence (can effectively channel power to disci-

ples) in a radius equal to its CR multiplied by 10. So, a CR 7 small god has influence over an area equal to 70 miles in radius.

Where worship of a small god is not so strong, the effective CR for the small god is -4 for spell purposes. That is, the spellcaster's level is capped by that supported at the new CR for gaining new spells and number of spells gained daily, but is considered normal spellcaster level otherwise. Being far from the area of a small god's influence also increases the intercession DC by 4.

Some small gods may provide less magic than others, but may cover larger territories than usual. As a simple modification, lowering one value allows another value to go up a rank. A CR 15 totem can double the number of its worshippers by accepting a limit of 10th-level followers. This decision must be made by the small god, who can expand his territory at any time. This often causes disciples to work against their god to avoid a reduction in their personal power.

DRAWBACKS

The main drawback to following a small god is that such gods may be destroyed. Also, their interests and power are fairly localized. Though a character enjoys a closer relationship, this is a closeness that can involve great danger when a small god maneuvers against larger powers.

If a small god is destroyed, another soon rises to take its place. Disciples must petition the new being for patronage, but worshippers need not do anything. The new being simply takes over the spiritual void left empty by the other creature's death. Petitioning for patronage follows the same rules as serving out an *atonement*, and all divine powers, abilities, and spellcasting are lost until the new being accepts the follower as his own.

In some religions, small gods may be part of a hierarchy. Individual gods may be less powerful fragments of greater beings. Worship of lesser gods is rolled up into the power of their greater selves. The local god of death might be a simple reflection of the overall manifestation of death. This manifestation may be a true god or other being of at least CR 30. Such a power may have two incarnations beneath it, four incarnations beneath them, eight beneath them,

and so forth until you have a great number of death spirits of varying mien.

ELIBIA, GODDESS OF THE ERESPOINT

Elibia, the lady of the Erespont River, is worshipped by communities all along the river. She is usually depicted as a blue-green maiden with flowing white robes, laying just under the water, an arm rising above the surface.

The leaders of her faith are two 5th-level clerics, each an elder of a village on opposite sides of the river. These two villages lie just down the river from each other, creating a friendly rivalry in both mercantile and religious matters. This rivalry comes to a head during the annual spring festival, where brightly colored boats made entirely of flowers are set out upon the river in Elibia's name. Her demands are not great, mainly coming in the form of music and festivals featuring flowers spread across the surface of the river. She is worshipped in small shrines tended by local families, usually near piers or otherwise close to the water.

Elibia regards her followers as her children, albeit children she does not understand very well. Her worship is found all along the river, both in the largest towns and in the smaller communities around them. Further inland and along the ocean coast her worship is weaker. If her clerics travel too far inland, they are limited to only 1st-level spells until they return closer to her domain.

Elibia, Goddess of the Erespont, CR 9; Medium-size water elemental; Clr6; HD 4d8+12+6d8+18; hp 82; Init +1 (Dex); Spd 20 ft., swim 90 ft.; AC 19 (+1 Dex, +8 natural); Atk +10/+5 melee (1d8 + 4 slam); SA Water mastery, drench, vortex; SQ divine being (Trickery, Water), elemental; AL N; SV Fort +12, Ref +4, Will +10; Str 16, Dex 12, Con 17, Int 6, Wis 17, Cha 13.

Skills: Concentration +9, Listen +7, Spot +7.
Feats: Enlarge Spell, Extend Spell, Iron Will, Power Attack.

Special Attacks: Drench, vortex, water mastery.
Special Qualities: Divine being, elemental.

Small God Qualities: Number of followers: 52; highest follower level: 5; number of worshippers: 10,591; intercession DC: 12.



DRUID CEREMONIES

Calm as a rock or fierce as a storm, druidic ceremonies take many shapes, and those who perform them care less about the appearance of the ritual than about the results. Druids carefully guard the secrets of their ceremonies and teach them only through word of mouth. The ceremonies often take place at night in secluded areas away from civilization, such as a wooded glen or a sacred tree. Druids do not concern themselves with time as much as the other divine classes, so a druidic ceremony may last minutes, hours, days, or even weeks. The ceremonies themselves are enchanting and sometimes frightening to watch. A great gathering of druids, called a conclave, is rare and never open to outsiders. Some druidic ceremonies are described below.

SUMMONING AN ANIMAL COMPANION

A druid sometimes seeks a forest friend to follow him in his journeys. These animals are loyal, helpful, and caring. In order to find the best companion available in an unfamiliar area, a druid may perform a short summoning ritual.

Caster Requirements: A druid of any level.

Time Requirements: This ceremony takes about half a day.

Place Requirements: A deep forest.

Material Components: A piece of chalk, a jar of honey, four leaves from four different trees, a smooth rock, a blade of grass.

The Ceremony: The ceremony begins at dawn with the druid setting out on a thoughtful walk in the forest. During this walk he must acquire the four leaves to be used in the ritual. Around noon and away from civilization and roads, the druid must find a place to write, such as the trunk of a large tree, a boulder, or a sandy surface. Once a suitable place is found, the druid takes out the chalk and draws a triangle inscribed in a circle. After completing the drawing, a smooth stone must be placed in the center. Then the druid takes seven steps away and sits down, placing the four leaves facing north, south, east, and west around him. The

druid must then meditate on the desired animal companion for one hour. After meditation, the druid places some honey on his tongue, being careful not to swallow it. Then, holding the blade of grass with both hands, the druid blows through it like a whistle. The grass emits a shrill sound that echoes for miles around. If the desired animal companion is within 10 miles, it speeds to the druid with all haste, arriving in 1d4 minutes. The summoned animal is a fine specimen that has +2 to the ability score of the druid's choice.

Ritual DC: 15.

PLANTING IN A SACRED GROVE

The backbone of druidic faith is the purity of nature and the clarity one gains from embracing it. All druids have one place that they turn to for meditation and reflection. A sacred grove is to a druid as a temple is to a cleric. They are places of power, beauty, and knowledge. A naturally formed grove takes centuries to grow, but a druid may shape and develop a new one more quickly. These groves represent the labors of the druid's life and are not just created anywhere. A druid often scours far and wide to find new plants and new dirt to strengthen a new sacred grove or repair a damaged one. However, the druid must sanctify and bless each new plant and clump of earth to keep the balance of a grove intact.

Caster Requirements: A druid that can cast *hallow* and *plant growth*.

Time Requirements: This ceremony takes a little less than one hour to complete.

Place Requirements: A sacred grove.

Material Components: The new plant or dirt, a wooden bowl, fresh spring water, and a pinch of sundust. Sundust is dust that has been held under a sunbeam peeking through the leaves of a tree at dusk.

Preparations: The new plant or dirt must be placed in a wooden bowl and prayed over for ten minutes.

The Ceremony: Once preparations are complete, the bowl is placed upon the ground and the druid slowly dances around it. After dancing seven complete circles around the bowl, she sprinkles fresh water over it and praises the rain for giving life. She then dances seven more circles around the bowl. After the second dance, she sprinkles the sundust over the bowl

and praises the land and sun for giving strength and prosperity. Again, she must dance seven times around the bowl. After the final dance, she casts *hallow* and *plant growth* over the bowl. The new plant or dirt may now be carried into the grove for planting.

Ritual DC: 10.

THE SHATTERING

Many druids have little use for weapons of war and see such instruments as dangerous to nature. Powerful relics or holy items, whether good or evil, can be very destructive and these druids would prefer to eliminate such things. Druids of the White Lady use the Shattering to destroy minor holy relics, weapons or armor with a +2 bonus or less, and minor wondrous items.

Caster Requirements: Three 5th-level druids that can cast *call lightning*, *produce flame*, and *soften earth and stone*.

Time Requirements: This ceremony begins at midnight and lasts for one hour.

Place Requirements: A grove in which there are currently no magical items or effects.

Material Components: Three handbells and a block of limestone upon which the item can be placed.

Preparations: The holy item must be placed on the block of limestone with widening circles of mud smeared around it.

The Ceremony: The ceremony begins at midnight with the druids chanting prayers of peace. Each druid rings one bell and walks around the holy item counter-clockwise. After 15 minutes, all three druids turn, face the holy item, and cast *soften earth and stone* on the limestone. As the holy item slowly sinks into the limestone, the druids return to walking and ringing the bells, only this time they move clockwise around the item. After 15 more minutes, the druids turn again and cast *produce flame* to harden the limestone and solidify the holy item within. The druids then return to walking and ringing the bells in a counter-clockwise direction. After 15 more minutes, the druids stop, face the holy item, and cast *call lightning* on the limestone. If the holy item is not too powerful, the lightning destroys the item along with the stone.

Ritual DC: 28

SEAFARER'S HANDBOOK

Pike sprang into action, leaping from his ship's forecastle toward the orcish warship. One hand gripped his scimitar while the other reached out and caught a guy line. Reflexively, he wrapped the rope about his wrist and slashed with the blade at the same time, cutting the line. Now free to swing, his momentum carried him over the orcish warship's deck. He split an orc's skull with a sharp chop from his blade, and then let go of the rope, somersaulting through the air to land on the warship's aft deck.

Battle on the high seas. It's the stuff of legend, but the complicated variables involved with ships in combat can deter even the most ambitious DM. No longer.

The next few pages will give you a comprehensive set of rules for running maritime combat, including the benefits of having a capable commander instead of an inexperienced captain, a sturdy ship instead of a waterlogged scow, and a full set of artillery instead of a bunch of landlubbers with crossbows.

The rest of the *Seafarer's Handbook* is equally



ripe with rules and campaign options for running adventures on the waves . . . or beneath them.

Build the ships that your characters will fight on. Trade in those traditional spells that are useless on the sea. Read the first-published comprehensive system for d20 System underwater combat.

All of the text in this section describing rules for ship-to-ship combat is considered **Open Game Content**. All background text, examples, and diagrams are considered closed content.

BATTLE ON THE HIGH SEAS

The orcish warship, her slaves straining at the oars, her blood-red sails billowing before the strong tailwind, cut through the choppy, gray-green sea. On the bow, the ballista crew stood ready, waiting for the signal from the boson. A boarding party crowded the starboard rail, grappling hooks and ropes at the ready, their cruel eyes bright with anticipation of the impending battle.

Two hundred yards away, the merchant vessel raced at full sail, the captain anxiously watching the warship from the aft deck. His ship was sleek and agile, but lacked the power of a full rowing galley. Fortunately, he was not alone. The accompanying mercenary captain gave the order to bring his longship about. Before those orcs would lay hands on any cargo, they'd have to get past Pike's marines....

ENCOUNTER DISTANCE

Naval engagements often begin at very long ranges. Encounter distance is determined according to the core rules (DMG). On the open ocean, visibility is very good and spotting distance is $1d10 \times 1,000$ ft. (5,000 ft.). For the purposes of spotting difficulty, a small sail reduces the DC by 2, a medium sail by 4, and a large sail by 8.

SHIP SPEED

A ship's speed is based on its hull size and propulsion system. This rule is a gross generalization that ignores a host of factors such as wind speed and direction, cargo weight, and ocean currents. Nevertheless, the goal is to simulate tactical ship movement as simply as possible.

A ship can increase its speed 5 feet per round until it reaches top speed. A ship can also decelerate by up to 10 feet per round. The speeds and other game statistics of a variety of ships can be

found in the ship designs chapter (see Chapter 5).

In some situations, deceleration may be involuntary. Should a ship pull in its oars or lose a sail, its speed decreases by 10 feet per round until the adjusted speed is reached. For example, a galley with a medium sail and active rowing crews has a speed of 40 feet per round. If the captain orders the oars to be pulled in, the galley's speed drops to 30 feet the first round and 25 feet the second round (the top speed of the ship under sail).

TURNING

Ships can turn while sailing. Each 45° turn to port or starboard must be preceded by forward movement based on the ship's hull size.

Hull Size	Turn Rate
Small	5 feet
Medium	10 feet
Large	15 feet
Huge	20 feet
Gargantuan	50 feet
Colossal	100 feet

Diagram 1

A Huge sailing ship moving 20 feet per round wants to make a 90° change of heading to starboard. This requires two rounds of movement. On the diagram, A indicates the ship's original position, and the arrow projecting from its bow indicates the direction of sail. In round one, after 20 feet, the ship turns 45° starboard, changing its position and heading to B. During round two, after another 20 feet of movement, the ship makes a second 45° turn to starboard. Point C indicates the sailing ship's final position and heading.

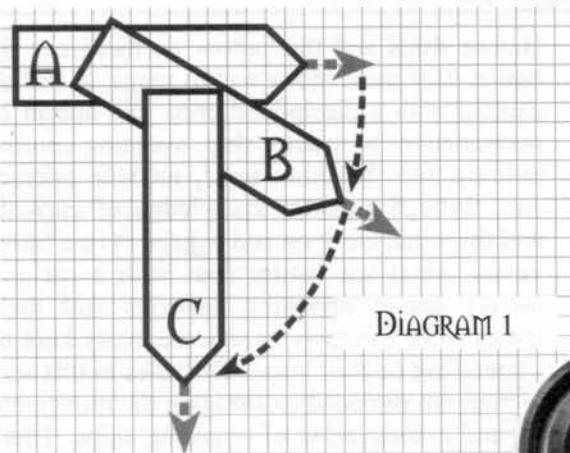

Instead of executing a turn, which changes direction of travel, a ship can drift port or starboard but maintain its current heading. For every 10 feet of drift, subtract 5 feet from the ship's current speed. A 5-foot drift does not slow a ship down. A ship's movement rate cannot be reduced below 5 feet per round due to drift (see diagram 2.)

Diagram 2

A sailing ship is heading due east at 20 feet per round. The captain needs to adjust the ship's position, but not its heading, and orders a starboard drift. Point A indicates the ship's starting location. In the first round, the vessel drifts 10 feet starboard, reducing its speed to 15 feet per round and changing its position to B. In the second round, the ship increases its speed by 5 feet (to 20 feet per round) and drifts a sharp 30 feet starboard. This reduces the ship's forward speed to 5 feet (the minimum) and changes the ship's position to C. In the third round of maneuvering, the ship increases its forward speed to 10 feet and executes a 5-foot starboard drift to end up in position D.

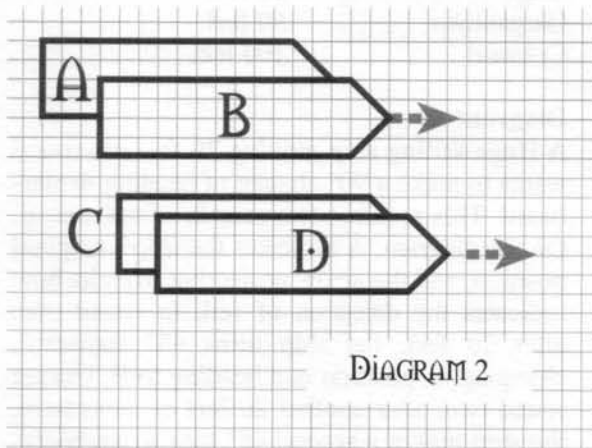

MANEUVERING

Before ships and the sailors on them can do battle, they must move within range. A skilled captain with a disciplined crew can outrun or outmaneuver an enemy ship, avoiding combat entirely. On the other hand, an able pursuer can, through superior knowledge of currents and the wind, close on and engage even a faster vessel. Most sea battles start with a cat and mouse game; opposing captains and their crews work furiously to squeeze every knot of speed out of their ships. The rules in this section are intended to simulate the movement and maneuvering of opposing ships. There

are six crucial pieces of information needed for each ship involved:

- The ship's speed
- The captain's Profession (sailor) skill
- The captain's Charisma modifier (if any)
- The percentage of the ship's crew on duty
- The crew's quality modifier
- The current sea/weather conditions

SHIP COMBAT SEQUENCE

The normal combat sequence is altered slightly to take ship movement into consideration. The following text is an amended and abridged version of the combat sequence described in the core rules (PHB).

1. Combatants start the battle flat-footed. Once a combatant has acted, he is no longer flat-footed.
2. Determine whether or not a surprise round is required. Combatants not surprised roll initiative as normal, but any unsurprised captain automatically has an initiative one greater than the highest non-captain's initiative result. Command totals are generated for unsurprised captains. Ships are moved in order of command totals (from highest to lowest). A surprised captain's ship continues its present heading at its present speed. All other unsurprised combatants act in initiative order, from highest to lowest.
3. Anyone who has not yet rolled initiative does so. All captains have an initiative one greater than the highest non-captain's total. The first regular round begins.
4. Generate command totals and move ships.
5. Combatants act in initiative order.
6. When everyone has taken a turn, repeat steps 4 through 6 until combat ends.

COMMAND TOTALS

Maintaining command of a ship during movement and maneuvering is a standard action that does not provoke attacks of opportunity. The captain stays busy observing the ship, its crew, and its enemies, as well as issuing commands and taking reports from various crewmembers and officers. A captain's command total is determined at the beginning of each round by a Profession (sailor) check that includes addi-

Captain	Ship Type	Starting Speed	Profession (sailor)	Charisma Modifier	On Duty Modifier	Crew Modifier
Fugug	warship	50 ft.	9	+2	+0	+0
Pike	longship	25 ft.	6	+3	+0	+2
Quay	sailing ship	20 ft.	8	+1	-2	+4

tional modifiers. The captain adds his Charisma modifier, the on duty modifier, the crew quality modifier, and any modifiers for weather and sea conditions to his Profession (sailor) check.

To determine the on duty and crew quality modifiers, consult the following tables. A ship with less than 10 percent of its crew available for duty cannot sail.

Crew On Duty	On Duty Modifier	Crew Quality	Modifier
> 80%	+0	Green	-2
41-60%	-2	Average	+0
21-40%	-4	Veteran	+2
10-20%	-6	Elite	+4

Each captain generates a command total. The

command totals are then compared to each other and to DC 25. Determine the difference between each command total and DC 25. For each point above 25, the captain can increase the ship's speed by an additional 5 feet. An exceptionally poor command total can reduce a ship's speed. For every point that a command total falls below 10, the ship's speed is reduced by 5 feet. A ship can always move 5 feet. Finally, it is time to move the ships.

DECLARATION AND MOVEMENT

Starting with the *lowest* command total, each captain declares his intentions for the round. Ship movement occurs in descending order of command totals, beginning with the highest, at the beginning of the round. All ships travel their full speed. This process enables captains

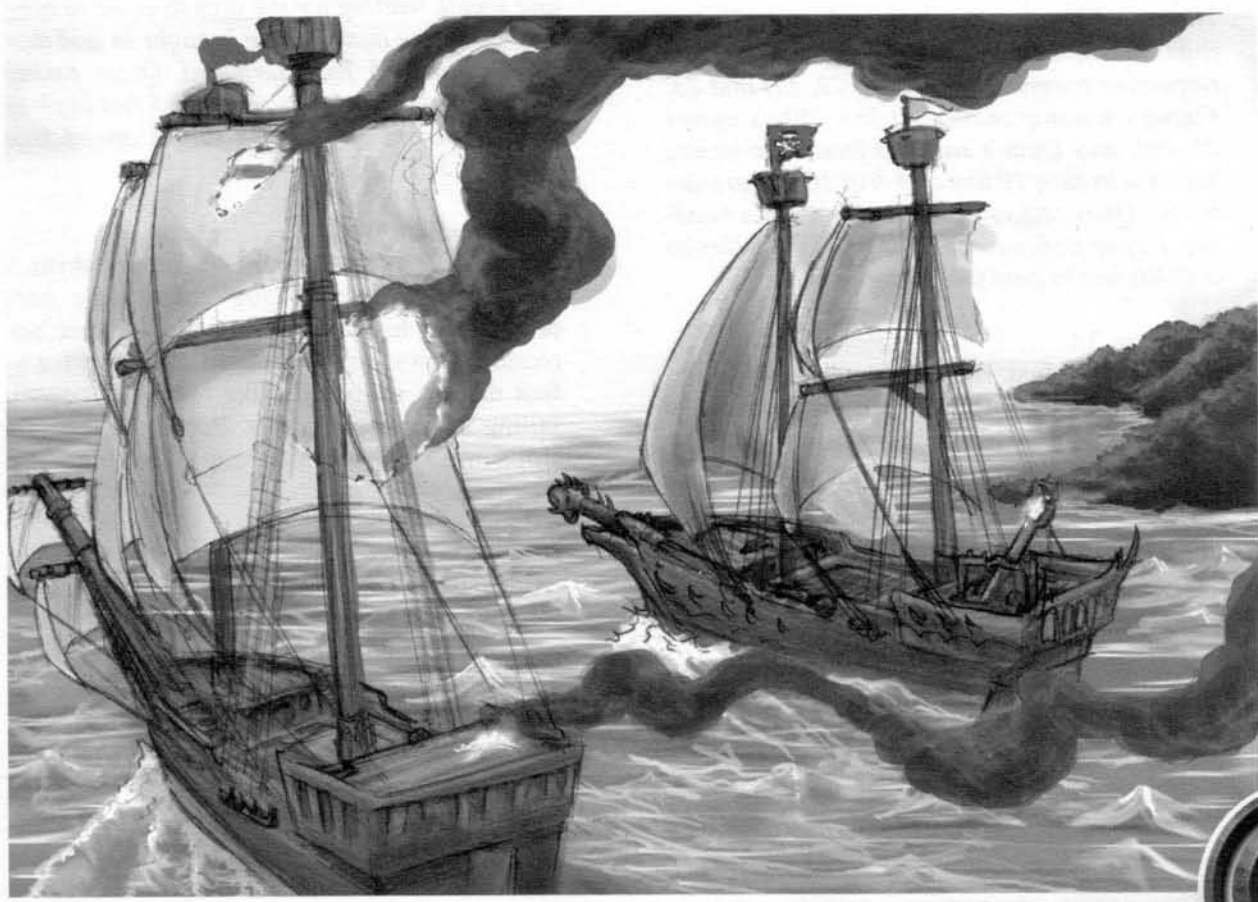
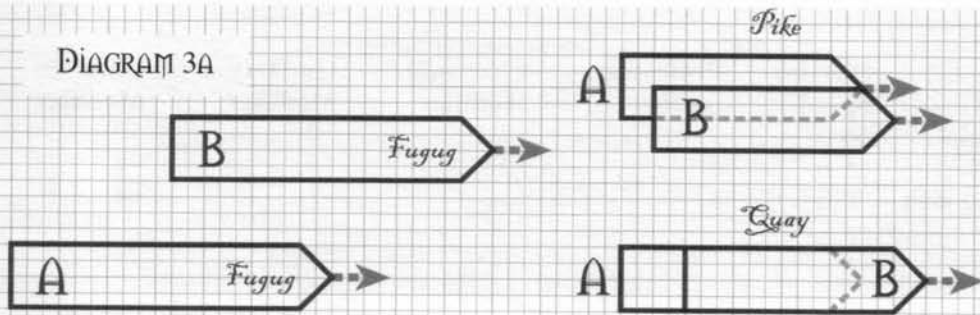

DIAGRAM 3A



with superior command totals to react to the declarations of captains with lower totals. The normal rules for acceleration and deceleration do not affect speed adjustments that result from command totals. During battle, a ship's captain and crew work as quickly and as hard as possible to maximize their vessel's capabilities.

Example

Three captains are engaged. Fugug leads an orcish warship with rowers. Pike is in charge of a mercenary longship without rowers. Quay commands a sailing ship with a crew stricken by illness, preventing about half of the sailors from working. See the chart below that summarizes their game statistics. At the beginning of the engagement, Quay is 100 feet from Fugug, and Pike is 40 feet to Quay's port.

The captains generate command totals. Fugug rolls an 18, Pike a 6, and Quay a 12. Their respective command totals are 29, 17, and 23. Fugug's warship moves 70 feet, Pike's moves 25 feet, and Quay's sails 20 feet. Pike orders his crew to slow 10 feet and drift 10 feet to starboard. Quay orders his crew to maintain heading. Fugug issues commands for his warship to drift 40 feet to port (see diagram 3A).

Diagram 3A

Fugug moves first. His warship drifts 40 feet to port, which subtracts 20 feet from this round's speed of 70 feet. The orcish vessel advances 50 feet. Quay's sailing ship continues ahead 20 feet. Pike's longship drops speed to 15 feet per round, and drifts 10 feet to starboard, subtracting another 5 feet from his speed. The mercenaries' longship moves ahead 10 feet.

The second round of naval combat begins and new command totals are generated. Fugug's luck holds, while Pike's and Quay's take a turn for the worse. Fugug rolls another 18, Pike rolls a 3, and Quay rolls a 5. The command totals are 29, 14, and 16, respectively. Pike orders his crew to accelerate to 20 feet per

round and drift another 10 feet starboard. Quay, not wanting to be rammed, orders a sharp drift 25 feet to starboard. Fugug wants to come alongside the sailing ship, but does not want

to be trapped between Quay and Pike. The orcish captain decides to take out the mercenaries first. He orders a 35-foot drift to port (see diagram 3B).

Diagram 3B

Fugug again moves first. With a 35-foot port drift, he reduces his 70-foot movement rate to 55 feet. Fugug surges forward, his bow coming even with Pike's port aft. The sailing ship commanded by Quay moves 10 feet forward and 25 feet to starboard. Pike sails 15 feet ahead and drifts 10 feet starboard.

Round three begins. New command totals are generated. They are 20 for Fugug, 18 for Pike, and 30 for Quay. Pike, figuring that Fugug is trying to engage him directly, holds his course and speed, waiting for the orcs to come to him. Fugug orders that oars be brought in and that the ship drift 5 feet starboard. Quay, taking advantage of the situation, drifts 5 feet back to port, increases speed, and surges ahead (see diagram 3C).

Diagram 3C

Quay's ship surges forward 40 feet and drifts 5 feet to port. Since Fugug ordered the oars brought in, his speed drops by 10 feet per round. The warship sails ahead 40 feet with a 5-foot drift to starboard. Pike holds his course, sailing on another 15 feet. Pike's and Quay's ships are now within range for boarding attempts.

Pike knew Quay couldn't outrun the warship, and so ordered his crew to cut speed and move starboard, hoping to shrink the distance between his longship and Quay's sailing ship. The distance between the warship and the merchant vessel narrowed steadily. Quay fancied that the orcs were close enough to catch a whiff of their stench. Recklessly, boldly, Fugug gave the command to surge forward and to port, maybe to drive his warship between Pike and

Quay like a wedge.

"Fire!" the orcish boson cried, and the ballista crew followed the command. The heavy projectile fell low, crashing into the aft hull. The merchant captain watched through his spyglass as the orcs reloaded and adjusted the ballista's aim. They'd be going for the sails. Once the proper trajectory had been set, fire would follow.

The orcish captain was no fool. He did not want to pilot his ship between Quay and Pike, which would mean fighting off boarders from both sides at once. The warship sliced hard to port, its bow bouncing across Pike's wake, while Pike moved again to starboard. The orcs were making ready to attack the mercenaries. Should they win that battle, Quay's ship would be an easy target.

SHIP WEAPONS

The procedure for firing both heavy and light catapults is briefly described on page 106. The process is somewhat complicated, but the guidelines below simplify the steps. Remember that a catapult's payload lands somewhere, even if not on target. If there are people or objects in the impact zone, they are damaged. A catapult does not fire a single rock; such a projectile would be too heavy to load or else too small to inflict full damage.

Rather, the basket of a catapult is loaded with several rocks or other heavy objects. Thus, the individual projectiles spread a bit during flight and rain down on the impact area. Both types of catapults affect a 5-foot radius around the impact point. A person in the center of the impact area can make a Reflex save (DC 15) for half damage. Individuals outside the impact but within the radius can make a Reflex save (DC 15) to avoid all damage entirely. Aiming a catapult from the deck of a ship at a moving target is difficult at best. The Profession (siege engineer) check's DC is 25 instead of the normal 20. The steps involved in firing a catapult are as follows.

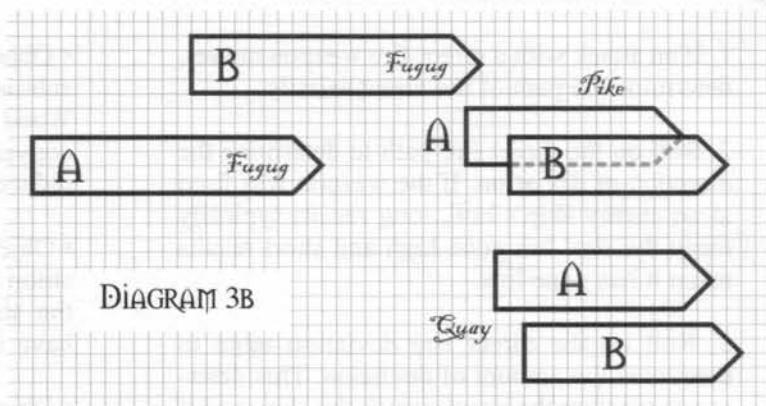

DIAGRAM 3B

1. Artillerist chooses a desired impact point.
2. Artillerist makes a Profession (siege engineer) check (DC 25). If this check succeeds, go to step 5. If it fails, go to step 3.
3. DM secretly determines a new impact point using the Deviation (10 to 16 feet) Diagram (DMG 68). Go to step 4.
4. Determine actual impact point using the Deviation (10 to 16 feet) Diagram. Go to step 5.
5. Apply damage.

Firing a ballista is simpler. A ballista attack is

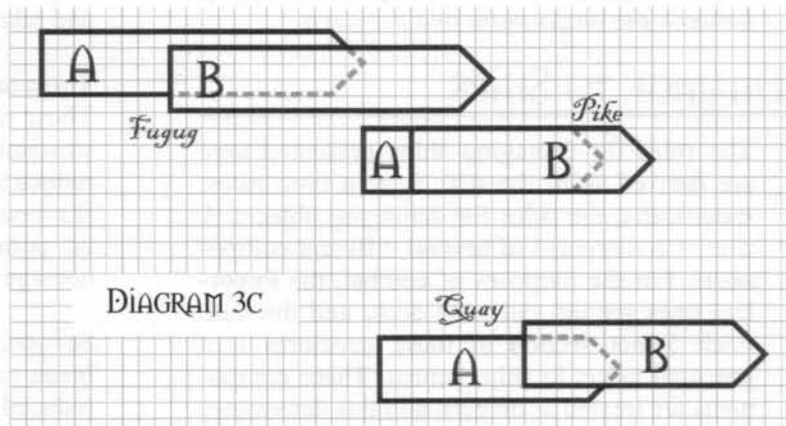

DIAGRAM 3C

resolved with a straight attack roll (d20) using no modifiers except those for range. An artillerist can add his Wisdom modifier to his attack roll if he directs the firing of the ballista.

A ballista is usually fired at an enemy ship's sail. In this case, you don't have to worry about deviation: the sail's AC is modified for its size, and a failed attack roll simply indicates a miss. However, direct-fire weapons may also be fired at the ship's deck or hull. In this case, the bolt may miss the section the artillery crew was aiming for but still strike the ship somewhere. Use the variant rules for firing into a crowd (DMG) to resolve this possibility. In ship combat, this rule is pretty simple.

1. If an attack with a direct-fire weapon misses, determine the path of the errant missile.
2. Roll on the direct fire path to determine the direction of deviation. If the weapon was fired at an enemy ship's hull, long results typically mean the shot has gone high and short results mean it has gone low.
3. Roll on the direct fire deviation table to determine the amount of deviation. This determines whether the attack struck the ship, and if so, its point of impact.

Example

Fugug's ballista crew fires their weapon at the center of the Quay's hull at the waterline, and the shot misses. The DM rolls on the direct fire path table and gets a 16, so the shot went wide right. Next, the DM rolls on the direct fire deviation table and gets a 9, so the shot deviated 1/10 the distance between the attacker and target. Fugug's ship is 200 feet away from Quay's, so the deviation is 20 feet. Since Quay's ship is 80 feet long, the bolt hit the ship about midway between the target point and the stern.

DAMAGE TO SHIPS

The rules for damaging ships presented here are derived from the d20 System core rules; specifically, the rules for damaging objects. A ship is constructed of several different components. For the purposes of combat, the important ones are the sails, the deck, and the hull. Each 5-foot section of these structures is a potential target in ship combat. These components are treated as objects, and this determines the way damage is dealt to them. In the d20 System core rules, a number of unique characteristics apply to objects.

- The Armor Class of an object is adjusted by its modifiers for size and Dexterity. Every 5-foot section of a ship's hull or deck is treated as an individual target, so the size modifier is always +0. In the core rules, inanimate objects are considered to have Dexterity 0, so a -5 Dex penalty is applied. Based on these modifiers, any given 5-foot section of a ship's primary structural components will be AC 5. See the construction rules (See *Seafarer's Handbook*, Chapter 4) for exceptions based on alternative materials. A small sail is AC 5, a medium sail is AC 3, and a large sail is AC 1.

- Objects have a hardness rating. This rating is subtracted from all damage dealt to the object. Wood is hardness 5, so all damage dealt to a conventional ship's hull, deck, or masts is reduced by 5.

- Objects have hit points based on their composition and thickness. Wooden objects, such as the standard structural components of ships, have 10 hit points per inch of thickness.

- Objects are immune to critical hits and sub-lethal damage.

- Objects take half damage from personal ranged weapons, such as bows and slings. Divide the damage dealt by 2 before subtracting the object's hardness rating. Siege weapons, such as catapults and ballistae, do full damage to objects.

- Objects take half damage from acid, fire, and lightning attacks, quarter damage from cold attacks, and full damage from sonic attacks. A ship's sails are particularly vulnerable to fire and take full damage from fire attacks.

There are two ways to break or breach objects. These rules use both to resolve damage to the structural components of ships. First, you can reduce the object's hit points to 0. For example, if a boat's hull is two inches thick and has 20 hit points, a catapult strike for 25 points of damage will put a hole in it.

Second, sudden force applied to an object can break or breach it, even if its hit points are not reduced to 0 by the attack. The attacker makes a Strength check; if the result matches or exceeds the object's Break DC, it is broken or breached. When an object has lost half or more of its total hit points, its Break DC is reduced by 2. Of course, an object that has lost all of its hit points is broken, regardless of whether or not its Break DC has been bested.

Siege weapons, such as catapults and ballistae, are not powered by characters or creatures with Strength scores, but they can still deliver a great enough impact to break or breach the structural components of a ship. Rules for resolving this are provided below.

The following sections list the three primary structural components of ships and present

rules for resolving damage to them. Rules for repairing damage to each component are also provided.

SAILS

Damage to its sails can slow or stop a ship. An average sail is made of durable cloth. Standard sails have a hardness of 0 and 2 hit points, so they are extremely easy to pierce. A single hole or tear in a sail is typically not a danger, however.

Several tears in a sail may cause the material to rip apart under the pressure of the wind. Each tear in a sail counts as a cumulative 6 points of Strength. Each round a damaged sail is in use, make a Strength check against Break DC 23. If the Strength check succeeds, the sail tears apart and is useless. A ship that loses a sail has its speed reduced accordingly.

Example

Fugug's ballista crew has hit one of Quay's medium sails three times, yielding an effective Strength of 18 for the Strength check against Break DC 23. A d20 roll results in a 19, which is added to the +4 Strength modifier. Quay's sail shreds, reducing his ship's speed by 25 feet.

Repairing a single tear in a sail requires a Craft (shipmaking) check (DC 10). The base time required for the task is 10 minutes (100 rounds), but a sailor can attempt to do it more quickly. For every minute by which this time is reduced, the DC is increased by 2. A sail that has been shredded cannot be repaired. Rigging a new sail requires one crewmember and 5 minutes for a small sail, five crewmembers and 10 minutes for a medium sail, and 10 crewmembers and 15 minutes for a large sail. Crewmembers repairing a sail or rigging a new sail do not count for the purposes of determining the ship's command total.

DECK

A ship's deck presents three main targets: enemy sailors, a mast, or the deck itself.



Attacks against sailors are resolved using the standard combat rules. A typical mast is AC 5 and has a hardness of 5. Its hit points and Break DC are based on the size of the sail it supports.

Size	Hit Points	Break DC
Small	50	18
Medium	150	23
Large	300	30

A broken mast cannot be repaired and typically cannot be replaced outside of a shipyard. A ship that loses a mast loses the sail, and its speed is affected as described previously.

A 5-foot-square section of deck is AC 5, and has a hardness of 5, 50 hit points, and a break DC of 26. Every hit point of damage dealt by siege weaponry in a single attack (after hardness is subtracted) counts as 3 cumulative Strength points for a break attempt.

The collapse of a section of the deck renders the adjacent decking structurally unsound. Anytime significant weight or force is applied to an adjacent section (such as by a crewmember walking on it or a weapon striking it), make a check for the adjacent section using the original Strength score. If this section collapses, all the squares adjacent to it become unsound.

Example

Quay returns fire with the ship's heavy catapult and ballista. The catapult crew



aims for the deck where the orcish ballista is located. The ballista crew fires at the warship's single mast. The catapult aims true, striking the deck for 12 points of damage after hardness is subtracted. This yields a Strength 36 break attempt against Break DC 26. A d20 roll yields a 14, which is sufficient to pierce the deck when modified by the +13 Strength bonus. The ballista falls through the hole made by the catapult's missile. Each 5-foot section around this collapsed area is now structurally unsound. If one of these sections is damaged or forced to support any significant weight, a new Strength check is made with a +13 bonus against Break DC 26.

The ballista bolt fired at the same time as the catapult hits the mast for 7 hit points of damage after hardness is subtracted. A Strength 21 check against Break DC 23 is made, but fails. The mast is damaged, but unbroken.

A collapsed section of the deck can be repaired with a Craft (shipmaking) check (DC 12). The base time required for the task is 10 minutes (100 rounds), but a sailor can attempt to do it more quickly. For every minute by which this time is reduced, the DC is increased by 2. If a section is repaired, the areas adjacent to it are no longer considered structurally unsound. Crewmembers assigned to repairs are not counted as crew for the purposes of determining command totals.

HULL

Finally, the ship's hull can be targeted. The goal is to pierce the hull at or close to the waterline, thus causing the ship to take on water and slowly sink. Each 5-foot-square section of hull is AC 5, modified by any magic bonus provided by the ship's construction (see Chapter 4). A wooden hull has hardness 5 and 10 hit points per inch of thickness, but alternative materials may have different values. To determine if a section of the hull is breached, follow the same procedure described above for mast and deck hits. The Break DCs for hull materials are: Wood 28, Iron 33, Mithral 35, Adamantite 40.

The severity of the breach depends on the size of the weapon used in the attack. The following table lists a range of attacks and the breach severities they cause.

Breach Severity	Attacks
Minor	Attacks by Medium-size or smaller creatures
Moderate	Attacks by Large or Huge creatures, light siege weapons (light catapult, ballistae)
Major	Attacks by Gargantuan or Colossal creatures, heavy siege weapons (heavy catapult, cannon)

A ship with a hull breach begins to take on water, and a ship can only take on so much water before it founders and begins to sink. The rate at which a ship takes on water is measured in buckets. A "bucket" is simply a convenient name for an abstract volume of water that a single crewman can bail in a minute (10 rounds).

Minor: A minor breach creates a small hole or tear in the hull, and the ship begins leaking slowly. A minor breach admits one bucket of water a minute.

Moderate: A moderate breach creates a larger

hole or tear in the hull, and the ship begins leaking much more quickly. A minor breach admits five buckets of water a minute.

Major: A major breach creates a severe hole or tear in the hull, and the ship begins taking on water very quickly. A major breach admits 10 buckets of water a minute.

When a ship has taken on more buckets of water than it can handle, it founders and begins to sink. The amount of water a ship can handle is based on the size category of its hull.

Size	Buckets
Small	10
Medium	20
Large	50
Huge	100
Gargantuan	500
Colossal	1,000

Crewmembers can be assigned to bail water, and a single crewmember can bail one bucket of water each full minute he is working. A single crewmember can prevent a ship from taking on any water from a minor breach, but 10 crewmembers are necessary to prevent a ship that has suffered a major breach from taking on water. Crewmembers assigned to bail are not counted as crewmembers for the purposes of determining command totals.

A ship that takes on half its allowance of water is crippled. Its top speed is halved and its captain suffers a -4 circumstance penalty on his Profession (sailor) checks to determine command total. A ship that takes on its full allowance of water is foundering. The ship loses 10 feet of speed per round until it is dead in the water. The ship can no longer move under its own power and begins sinking. The ship has taken on enough water that it is past the point of no return, and bailing will no longer save it. The amount of time it takes for the ship to sink is based on its size.

Size	Time
Small	5 rounds
Medium	1 minute
Large	5 minutes
Huge	10 minutes
Gargantuan	30 minutes
Colossal	1 hour



DIAGRAM 4

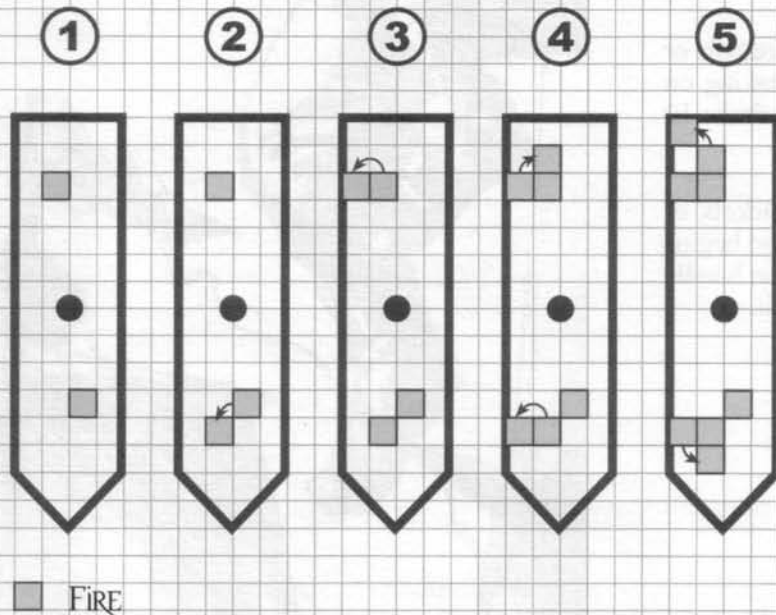

FIRE!

Fire is an especially dangerous hazard to a ship. Most vessels are constructed almost entirely of wood. The sails and the ropes used to control them are flammable. A ship's fresh water supply is limited, and is not stored for firefighting purposes. True, the ocean itself can be used to extinguish a flame, but seawater must be hauled onboard using buckets and ropes. The basic mechanics of catching on fire are provided in the core rules (DMG 86), but these apply only to characters and their equipment.

A ship subjected to fire attacks, such as alchemist's fire, a burning ballista spear, or a catapult basket full of hot coals, is not allowed a Reflex save to avoid catching fire. However, the ship's structural components—except the sails—take half damage from fire. The damage dealt by the attack determines whether a fire starts. Also, an untended fire may spread and grow in size and intensity. A fire attack on a ship is divided into two sections: the initial damage and the possible resulting secondary damage.

If a modest section of a ship—a 5-foot-square section of deck, a mast, or a sail—is exposed to fire, the DM should make a fire check. Roll 1d20 and add 1 for each point of fire damage inflicted (after subtracting hardness, if

applicable). If the total is equal to or greater than 15, a fire has been started and secondary damage results. Otherwise, the initial fire attack burns itself out as normal.

Example

An orcish boarder lobs a vial of alchemist's fire at Pike's marines. The vial hits the deck, shatters, and blazing liquid spreads. The alchemist's fire deals 2 points of damage, which is negated by the deck's hardness. The DM rolls 1d20 for a fire check and the result is a 12. The wood is not set aflame, but the alchemist's fire burns normally. In the second round, the alchemist's fire burns for another 3 points of damage. A second fire check is made, and this time the DM rolls a 16. The 5-foot-square section of deck is now burning on its own.

If secondary fire damage results from a successful fire check, the burning structure's hardness is no longer applicable and it takes full damage from the blaze. The burning structure suffers 1d6 points of damage every round directly to its hit points. If the conflagration is left unchecked, the fire may spread. The DM makes a fire check each round (DC 20), adjusted by damage as normal.

A success means the fire spreads to another adjacent area and its damage is increased by 1d6 (maximum 5d6). Determine the direction the fire spreads based on wind direction or use the grenade-like weapons diagram (PHB). Remember that fire spreads upward as well as horizontally.

Example

A section of deck on Pike's longship is ablaze. A new combat round begins. The DM determines that the deck section suffers 4 points of damage directly to its hit points. He then makes a fire check, adding 4 to the roll. The total is 20, so the fire spreads. Using the grenade-like weapons diagram, the DM determines that the fire spreads to the 5-foot section that supports the mast. The next round, the blaze deals 2d6 points of damage. If left unchecked, the fire probably moves up the mast to the sails.

Of course, fire can be fought. Water or sand can be thrown onto the flames, or materials such as tarps or cloaks can be used to try to smother the flames. An appropriately equipped firefighter makes a Reflex save (DC 15). If successful, he has extinguished a single 5-foot-square section. The blaze still deals 1d6 points of damage per section. So, for example, a blaze reduced from 10 sections to nine sections still deals 5d6 points of damage; a blaze reduced from five sections to four deals only 4d6 damage. If more than one person battles a blaze in a single section, use the highest Reflex save bonus and grant a +2 circumstance bonus on the save. Firefighters are not counted as crew for the purposes of determining command totals.



A ship's deck may have multiple fires (see diagram 4). Each fire is tracked separately until spreading causes them to join. At that point, treat the previously distinct fires as a one larger blaze, but remember that the damage cap is still 5d6.

Diagram 4

There are two fires causing secondary fire damage aboard the ship, one fore and the other aft. On round one, the bow fire inflicts 1 point of damage and the aft fire 4 points. Two fire checks are made; the adjusted totals are 5 and 21 respectively. The bow fire spreads, increasing that fire's damage to 2d6. Round two begins. The bow fire deals 11 points of damage; the aft fire deals 5 points of damage. Amazingly, the bow fire does not spread, but the aft fire does. Round three begins and the fires each deal 8 points of damage. Fire checks are made, and both conflagrations spread. The bow fire continues its trek toward starboard, while the aft flame spreads back to port. Round five starts with two 3d6 blazes burning on the ship. The bow fire deals only another 8 points of damage, while the aft blaze deals 12 points. Both fires spread further. By the end of round five, half the starboard aft is in flames and much of the bow is being consumed as well.

The ballista crew knew their job well. A heavy spear tore through the mainsail of Quay's ship and became twisted in the heavy fabric. Under the pressure of the wind and its weight, it would do further damage, but the captain could not afford to strike the sail in order to remove the spear. Besides, a torn sail was the least of his problems.

On the warship's deck, the orcs reloaded the ballista, but this time the spear's tip had been soaked in pitch. One orc touched a torch flame to the projectile. Tongues of fire sprang to life, feeding on the pitch, and the boson gave the order. The second spear that hit the mainsail was ablaze. Threads of flame raced up the sail from the point of impact and danced out along the crossbeams and guy lines. Sailors raced to the edges of the ship, pitching buckets tied to ropes overboard to haul water back on deck. The fire had to be contained, or all was surely lost.

Fortunately, Quay would have a break from the ballista attacks. Pike's marines were between him and the orcs now. Bestial war cries ripped the salt air as orc warriors tossed grapple lines at the longship's port bulwarks. The marines readied their weapons, awaiting Pike's command to engage the enemy. Both wooden deck and salty brine would soon be stained red with blood...

MONSTER'S HANDBOOK

Monsters. You can use them to challenge the characters, to make them sweat, to give them worthy opponents in their harrowing adventures. You can pit the party against legions of powerful foes, wave upon wave of ground-thundering, wind-churning, red eyed howling packs of beasts and enemies.

Or you can terrify them with kobolds.

The *Monster's Handbook* takes the d20 System concept of advancing and classing monsters to a whole new level. Aberrations and undead have different goals, different surroundings, different strengths and weaknesses . . . and now they have different options for advancement, specialization, and alteration.

The book separates monsters by subtype, giving unique templates for each, new feats tailored for creatures of that type, even racial prestige classes.

We've also included comprehensive tips on

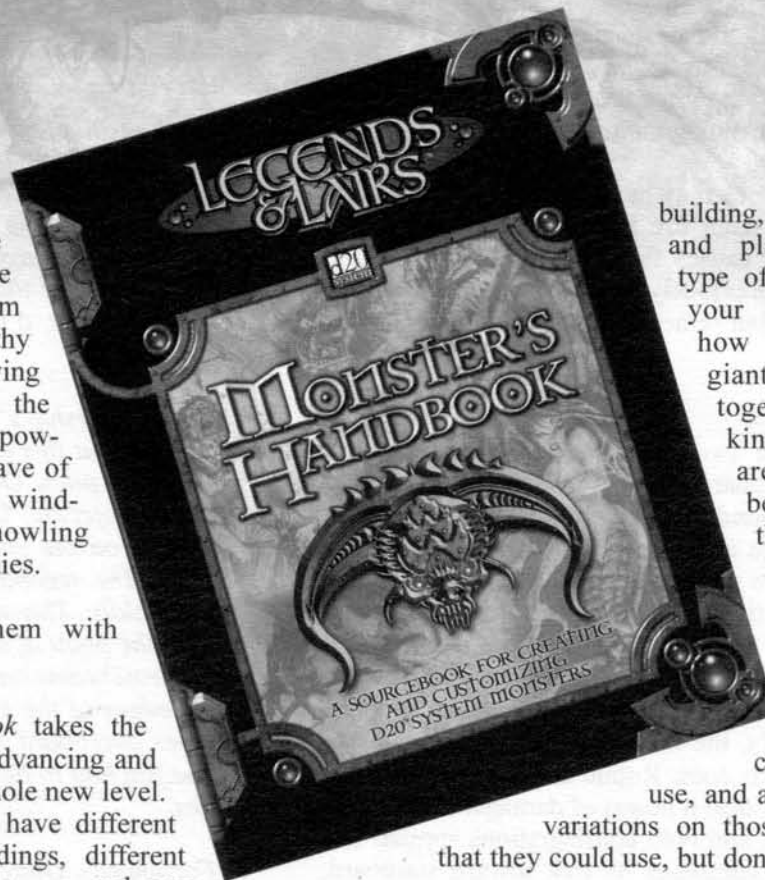

building, integrating, and playing each type of monster in your game. Just how well do giants work together? What kind of skills are the most beneficial or the most likely for an outsider? What kind of tactics do fey most commonly use, and are there any variations on those strategies that they could use, but don't?

For your enjoyment we present here the chapter on humanoids. The *Monster's Handbook*. Don't assault your party without one.

All of the text in this section describing rules for and names of feats, classes, and templates is considered **Open Game Content**. All background text describing these is considered closed content.

BUILDING HUMANOIDS

Of all the monster types available to DMs, humanoids offer perhaps the most flexibility in options in designing them for use in adventures. The highest CR amongst both humanoids and monstrous humanoids is 7 for the yuan-ti abomination, with kobolds at the low end of CRs with 1/6. Thus, these creatures are easily augmented with class levels even against 1st, 2nd, or 3rd-level characters. In most cases, these creatures need class levels to pose a threat to characters or must be matched with powerful creatures that serve as their leaders or overseers.

Humanoids lack the extreme ability scores of most other creature types. They cannot approach magical beasts or giants in terms of Strength, while they lack the innate magical powers of aberrations or outsiders. Monstrous humanoids usually have a few abilities that give them an unexpected edge over the characters. Against low-level parties, they can serve as combatants without any additional feats or levels. Still, in order to use them against more powerful characters you must deploy them in great numbers or rely on class levels and abilities to toughen them up.

CLASSES

Compared to other creature types, humanoids are a virtually blank canvas on which you can project nearly any class, feat combination, or special ability. With their low CRs, they can afford to take on quite a few class levels and tend to reap a much greater return on the increased CR. For instance, a CR 11 creature gains little from one or two class levels compared to its base abilities. On the other hand, humanoids function much like player character races in that they rely on class abilities and magic items as the sole source of fantastic, powerful abilities.

Just as a party of adventurers relies on a good mix of classes to overcome challenges, so too does a broad selection of divine and arcane casting ability, combat skill, and stealth make humanoids tougher obstacles for the characters. When designing encounters against higher level characters, distribute a few levels in several classes to a group of humanoids. A few orc fighters, for example, can form a defensive wall that allows a few orc sorcerers and clerics to rain spells down on the party. Meanwhile, a 1st-level orc bard can inspire confidence in the monsters while a few low-level rogues circle



around or use the Tumble skill to attack the party's spellcasters. No one character class can offer the same range of abilities and threaten the characters as well as a small group of classed humanoids working together.

FEATS

The best feat selections for humanoids and monstrous humanoids allow them to function well when they outnumber an opponent. Feats such as Cleave and Great Cleave are normally useless against adventurers, as only rarely will a humanoid have a high enough Strength and powerful enough weapon to drop a character in one blow and a have a good chance of delivering a deadly attack against a second PC. For similar reasons, any feat that reduces an attack's accuracy normally makes a poor choice. Power Attack and Rapid Shot are best left to humanoids with several class levels or a base attack bonus of around +5 or better.

When building an encounter with a large number of humanoids or designing a tribe, alter the base creature's feats to focus on its role. Orcs that fight as archers should have Point Blank Shot and Precise Shot, while the tribe's main warriors need Weapon Focus and Dodge to help them out against the PCs. Never be afraid to alter the default choices given in a humanoid's standard stat block. Specialization is the name of the game when you have an encounter that features lots of creatures.

EQUIPMENT

Many DMs overlook the possibilities offered by simply equipping a humanoid or monstrous humanoid with the right gear. Ideally, in an encounter between a group of humanoids and a party of adventurers, no monsters should ever spend a round just standing there, waiting to move up into melee. Outfit your humanoids each with a melee weapon, reach weapon, and missile weapon. Crossbows pack a good punch and are best for creatures that only receive one attack per round. Longspears are the first reach weapon that come to mind, but never overlook guisarmes and ranseurs for their bonuses to trip or disarm attacks. The flail is probably the best weapon for a humanoid, as it can make both disarm and trip attacks without exposing its user to any undue danger.

For armor, go with a mix of light and heavy. Humanoids that you intend to use as frontline fighters need not worry about speed. Equip them with large shields and chainmail if the EL is high enough that you can spend part of their treasure allocation on it. Other humanoids, such as archers and scouts, should wear light armor to give them the best chance to surround the PCs or find lines of fire against them. The tower shield is probably the most overlooked item in the game for these creatures. A few hobgoblins toting them can form a mobile defensive wall for archers and spellcasters.

MAGIC AND MAGIC ITEMS

Since humanoids have such low CRs, any of the spellcasting classes is a good choice for them. When picking spells, you have two basic options. If the EL is high enough that you can add many low-level casters to the mix, spells that incapacitate a target on a failed save are a good choice. Normally, the characters have saves that outpace the spell DCs of low-level casters. However, you can make up for that by designing an encounter where a group of humanoids can cast the same spell seven or eight times against the party in hopes that one or two failed saves takes them out.

For magic items, the same advice given earlier applies. Pick items that play into a humanoid's specialty. Sneaky ones should have *cloaks of elvenkind* and similar items, fighters need magic weapons, while *amulets of natural armor* are excellent choices for humanoids that can wear only light or no armor. Use the sample NPCs presented in the core rules as a guideline on how to equip a leveled humanoid.

HUMANOID PRESTIGE CLASSES

Of all the monster types, humanoids and monstrous humanoids have by far the greatest selection of prestige classes available to them. Many DMs overlook the potential of using strange or unique prestige classes with the creatures they design. More importantly, many monstrous humanoids fulfill the requirements to join a prestige class without taking levels in any of the core classes. For example, a medusa can qualify for the assassin class merely by reallocating a few of its skill ranks.

ARDENT PROTECTOR

Trained to stand by his employer and shield him from combat, the ardent protector is a highly specialized bodyguard who can bat away missile fire, trip up tumbling attackers, and shield his charge from melee attacks. Ardent protectors are as valued as they are rare. In some humanoid societies, the station of the ardent protector is a valued, respected station passed down from generation to generation. Other times, a wizard or high priest may recruit and train a monstrous creature to fulfill this duty. Amongst a powerful cult, a monster associated with the sect's deity is sometimes bound into service via an ancient, divine treaty and tasked with protecting high priests or holy shrines. Wizards and sorcerers, especially evil ones, employ spells such as *charm monster* to bind a servant and rely on specialist animal handlers and trainers to break and train a captured creature.

Hit Die: d10.

REQUIREMENTS

To become an ardent protector, a character must fulfill all the following criteria:

Base Attack Bonus +5.

Skills: Listen 5 ranks, Spot 5 ranks.

Feats: Combat Reflexes, Deflect Arrows, Shield Proficiency.

Optional: A humanoid creature that was raised to attain the position of an ardent protector in his tribe may ignore the requirements listed here. Long years of training have allowed him to immediately enter this prestige class. This option is available only to NPCs.

CLASS SKILLS

The ardent protector's class skills (and the key ability for each) are Climb (Str), Handle Animal (Cha), Intimidate (Cha), Jump (Str), Listen (Wis), Ride (Dex), Spot (Wis), and Swim (Str).

Skill Points at Each Level: 4 + Int modifier.

CLASS FEATURES

All of the following are class features of the ardent protector prestige class.



Weapon and Armor Proficiency: Ardent protectors are proficient with all simple and martial weapons, shields, and light, medium, and heavy armor.

Defend Area: The ardent protector is an expert at preventing attackers from reaching the person or creature he must protect. When making an attack of opportunity triggered by movement, he may choose to force his opponent to stop moving rather than inflict damage if his attack hits.

Rapid Strike: Watchful of his opponents and ready to strike the moment their guard drops, the ardent protector gains one additional attack of opportunity per round. This attack must be used as a standard attack of opportunity.

Arrow Catcher: At 2nd level, the protector learns to knock aside not only missiles fired at him but also those directed at an ally. He may use his Deflect Arrows feat to defend attacks made against one person he designates who stands within 5 feet.

Watchful Defender: Even a wily rogue or monk cannot slip past the ardent protector's watch. If an opponent attempts to

ARDENT PROTECTOR

Level	Base Attack	Fort	Ref	Will	Special
1	+1	+2	+2	+0	Defend area, rapid strike
2	+2	+3	+3	+0	Arrow catcher, watchful defender
3	+3	+3	+3	+1	Intercept opportunity attack, shield ally
4	+4	+4	+4	+1	Improved defender, living wall
5	+5	+4	+4	+1	Intercept attack

use the Tumble skill to move past the protector's threatened area or the space he occupies, the skill check necessary to enter and leave this area is equal to an attack roll made with the protector's best base attack bonus and all relevant modifiers. Treat a missed check as normal for a failed Tumble attempt.

Intercept Opportunity Attack: Once per round, the ardent protector may foil an attack of opportunity made against an ally who stands fully within his threatened area. When the protector's friend draws that attack, the protector may make an attack roll using his best base attack bonus and all standard modifiers. If the result of this roll is higher than the total attack result, the attack of opportunity automatically misses. Each time the ardent protector uses this ability, he expends one of his attacks of opportunity for the round.

Shield Ally: During his action on each round of combat, the protector may designate one person who stands within his threatened area as his ward. The target gains a +2 circumstance bonus to AC as long as he remains within the protector's threatened area.

Improved Defender: The ardent protector's experience and training combine to make him very good at tripping up attackers who try to slip by him. He may now use a trip attack with greater efficiency against anyone who draws an attack of opportunity from him due to movement. When using this ability, the protector's target does not have a chance to trip the protector should the trip attack fail.

Living Wall: If the protector does not move during his action, he counts as granting full cover to any creature or target if he stands between an attacker and a target whose size is equal to or less than his own. The protector stands resolute while his charge hides

behind him. However, as the protector exposes himself to fire in an effort to block attacks, he suffers a -2 AC modifier while using this ability. The protector may opt to use this class feature any time he does not move and is standing, regardless of his other actions for the round.

Intercept Attack: If the protector devotes all of his energies to keeping his charge safe, none but the most skilled warriors can penetrate his defenses. As a full action, the protector may designate one person within his threatened area as his charge. Whenever that charge is attacked, the protector may make an attack roll using his best base attack bonus and all relevant modifiers. If this total is higher than his opponent's attack roll, the attack against his charge misses. This ability applies only to melee attacks. Each time the protector attempts to block an attack in this way it counts as one of his attacks of opportunity for the round. The protector may only attempt to block attacks so long as his charge remains within his threatened area.

HUMANOID FEATS

In the typical adventure involving humanoids, these creatures rely on numbers to make up for their individual weakness compared to more powerful monsters. Most of the feats included here are designed to allow orcs, goblins, and other creatures to withstand attacks from more powerful foes such as ogres, giants, and high-level characters. Since monstrous humanoids cover so much ground, it is difficult to create feats for them that do not apply only to one specific monster.

CROUCHING FIGHTER [GENERAL]

In battle, you crouch low to the ground, allowing your allies to fire over you or use reach weapons without hindering their efforts.

Prerequisite: Dodge.

Benefit: When an ally attacks or fires through your space, reduce the cover AC you grant to your ally's target by two.

Special: A creature without this feat may duck down to avoid granting his enemies a cover bonus to AC. You may use a move-equivalent action to duck down in your space. You reduce the cover AC bonus you provide by two, but suffer a -4 penalty to your attacks and a -2 penalty to your own AC.

DISTANCE DISRUPTION [GENERAL]

You unleash a heavy stream of arrow fire at a spellcaster in an attempt to break his concentration and ruin his spells. Your attack has little chance to hit, but it buzzes past your target and wrecks his focus.

Prerequisite: Point Blank Shot.

Benefit: You may hold your action to fire a missile weapon at a spellcaster who attempts to use a spell. When your target begins casting, roll an attack against AC 10. If you hit, your target must make a Concentration check with a DC of $15 +$ the spell's level.

Normal: In order to force a Concentration check, you must hit and injure a spellcaster.

IMPROVED AID ANOTHER [GENERAL]

You are skilled at helping your allies evade enemy attacks. Less skilled fighters can only aid one of their friends, but you can help out several allies at once.

Prerequisite: Base attack bonus $+1$.

Benefit: When using the aid another action, you can opt to inflict a -1 penalty to the attack rolls of an opponent that you can normally attack in melee. You must hit AC 10 with an attack as normal in order to grant this bonus. Note that as an unlabeled modifier, this penalty stacks with anything. Thus, it is possible for a group of creatures to inflict a heavy penalty on one target.

PLAY DEAD [GENERAL]

Embracing a proven method for surviving combat amongst kobolds, goblins, halflings,



and other cowardly races, you crumple to the ground and feign death immediately after an opponent strikes you.

Prerequisite: Bluff skill.

Benefit: If you hold an action to play dead immediately after being hit in combat, you may crumple to the ground and make a Bluff check. You gain a bonus to this skill check equal to the damage inflicted by the hit that prompted the use of this skill. Your opponents must make a Sense Motive check with a DC equal to your Bluff check in order to notice that you are not disabled. When using Bluff in this manner, you must fall prone.

Normal: You may use the Bluff skill to play dead, but you do not gain a bonus to your check equal to the damage inflicted upon you.

PRESS IN [GENERAL]

You are trained to fight in close ranks, allowing you to use your weight to support an ally's attack.

Prerequisite: Str 13+.

Benefit: In combat, you may use a full attack action to make an opposed Strength check against a foe if one of your allies stands immediately between you and the target of this check. If your check succeeds, your opponent is immediately pushed 5 feet backward, while you and the ally who stood between you and your target immediately move 5 feet forward. Until your next action, an opponent pushed back in this manner suffers a -1 penalty to AC.

SHIELD WALL [GENERAL]

You stand in close quarters with your allies, allowing you to form a wall of shields that grants your allies an AC bonus.

Prerequisite: Shield Proficiency.

Benefit: You may use a move-equivalent action to stand in place and grant a +1 shield bonus to AC with your shield to an ally who stands immediately adjacent to you. Your ally loses this bonus if he moves away from you or if you move away from him. You may use your standard action to attack as normal.

STORM OF ARROWS [GENERAL]

You let loose a swift flurry of arrows at a high trajectory against a target, filling an area with missile fire.

Prerequisite: Rain of Arrows, Rapid Shot.

Benefit: For each attack you may attempt using a full attack action, you may make an area of effect attack that fills two 5-foot-square areas as a standard action. If you use a full attack action, each additional attack beyond the first allows you to expand this area to an additional two 5-foot squares. These squares must all be adjacent. Make one attack against all opponents in this area at your best base attack bonus and compare it to each potential target's AC. Those you hit suffer normal damage.

A group of creatures with this feat may combine their efforts to saturate an area with fire. Each attacker beyond the first grants a +1 bonus to the damage inflicted by this attack.

TOWER SHIELDMAN [GENERAL]

You are skilled at bearing a tower shield in battle, allowing you to grant a cover bonus to allies who stand adjacent to you.

Prerequisite: Shield Proficiency, Shield Wall.

Benefit: Using a full attack action, you may grant a +4 cover bonus to the AC of any two allies who stand adjacent to you until your next action. If you or your allies move, they lose this AC bonus. While using a tower shield in this manner, it grants you full cover.

HUMANOID TEMPLATES

The templates presented here take opposite approaches to improving humanoid monsters. The dire humanoid template makes a single creature stronger and more powerful in combat. The swarm template is used to group a large number of individually weak creatures into one stat block, allowing you to unleash 100 kobolds on a party of adventurers without miring the game in endless bookkeeping and hundreds of die rolls.

SWARM

A horde of goblins charges down a corridor to

overwhelm a dwarf shield wall, heedless of the crossbow bolts that rip through their ranks. A mass of kobolds piles on to an adventurer in hopes of dragging him down to the ground to finish him with daggers, piling over the fallen as the warrior hacks at them. Sometimes, humanoid creatures use the sheer weight of their numbers to overwhelm enemies. Kobolds, goblins, and other small creatures typically lack the skill and strength to equal an ogre, dwarf, or troll. Instead, they attack en masse and hope to wear down the enemy with successive, relentless attacks. The swarm template represents this. Unlike other templates that apply to a single creature, this template allows you to group large numbers of small creatures into one stat block. Strengthened by their numbers, these humanoids gain a few special attacks to use against adventurers.

CREATING A SWARM

“Swarm” is a template that may be added to any large group of humanoids, monstrous humanoids, animals, beasts, or vermin of size Small or less. The group must number at least 10 and consist of creatures of the same race. The group’s creature type remains the same. It gains a few special attacks that allow it to use its great numbers to overwhelm outnumbered foes.

A swarm uses its base creature’s characteristics except where noted below.

Size: A swarm’s size is determined by its total number of creatures.

Creatures in Swarm	Size
10 – 20	Large
21 – 40	Huge
41 – 100	Colossal
100+	Gargantuan

Hit Dice: A swarm’s HD equal half the total HD of its members. Compute its hit points based on this HD total and the swarm members’ average Constitution modifier.

Initiative: Swarms are slow to react to new threats, giving them a –2 competence penalty to all Initiative rolls.

Speed: Swarms move at the speed of their slowest member.

AC: Swarms use the most common AC of their



members. Note that a swarm’s size modifies this AC.

Attacks: A swarm may make one slam attack against each creature within its threatened area. This attack is made at the base creature’s attack bonus with a +4 modifier due to the massive number of attacks made by the swarm members.

Swarms with ranged attacks may make one attack at a +4 bonus for every 10 creatures in the swarm.

Damage: As base creature.

Face/Reach: Swarms use the following facings based on their size. A swarm’s reach is always 5 feet.

Size	Face
Large	5 ft. by 10 ft.
Huge	10 ft. by 10 ft.
Gargantuan	10 ft. by 15 ft.
Colossal	20 ft. by 20 ft.

Special Attacks: Swarms gain the following special attack.

Entrapment (Ex): If a creature shares a space with a swarm, it must make an opposed Strength check to move that round. The swarm gains a +4 bonus to this check. On a failed check, the creature uses its move-equivalent action and may not move that round. Special modes of movement, such as flying, jumping, or levitation, ignore this check but may draw attacks of opportunity.

Moving through a swarm automatically draws two attacks at the swarm's base attack bonus for each 5-foot space moved. These attacks do not count against the swarm's attacks of opportunity or other actions for that round.

Overwhelm (Ex): If on the swarm's action an opponent stands fully within its area, it may attempt to overwhelm its opponent through sheer numbers. As a full attack action, the swarm makes a grapple attack against its enemy. This grapple draws an attack of opportunity, but if this strike hits the grapple is not ruined. The swarm gains the special size modifier for a grappler of its size. Furthermore, it applies this bonus to the touch attack made to grab an opponent rather than the normal size penalty to its attacks. While grappling, the swarm may damage its opponent using its standard attack but gaining four attacks per round. It may also pin its target. If it does this, the swarm gets six attacks per round against its pinned foe with an additional +4 bonus to attacks in addition to the +4 for attacking a pinned foe.

Swarming Charge (Ex): A swarm that uses a charge action may move into spaces occupied by enemies. Opponents surrounded in this manner may make attacks of opportunity against the swarm as they move over them. When the swarm moves over an opponent in this manner, it immediately makes a single attack with a +4 bonus and deals double damage on a hit. This attack counts as a standard armed attack. A swarm may take no more than one of these attacks against a creature per round. There is no limit to the total number of attacks a swarm may make in this manner.

If the swarm moves into a creature's space, it may stop there and leave its opponent within its area. See the entrapment special attack above.

Special Qualities: Swarms are granted the following special quality.

Strength in Numbers (Ex): Since a swarm is a large collection of small creatures, it gains some immunities to spells and shrinks as it takes damage. All spells that deal hit points of damage affect the swarm as normal. Spells that deal special effects, such as sleep, paralysis, or ability score damage, affect the swarm if they are area of effect spells that cover at least half of the swarm's area. *Hold person* has no effect on a swarm, while *sleep* may. When determining if a spell can affect a creature of the swarm's HD, use the total HD of its smallest member. For example, a swarm of kobolds could be affected by *color spray* even if the swarm as a whole has 20 HD. Spells that affect a total number of HD worth of creatures must affect at least three-quarters of the swarm's total HD to work against the swarm as a whole.

As a swarm takes damage, it shrinks in size. When a swarm is reduced to half its starting hit points, it drops one size level. When it is reduced to a quarter of its starting hit points, it drops another level. When brought to less than one-eighth its starting hit points, the swarm is considered destroyed. Its surviving component monsters automatically scatter.

Using a coup-de-grace against a swarm requires one full-round action for each 5 ft. by 5 ft. square the swarm occupies.

Saves: Swarms are easy to target with area effect spells, as their members trip over each other to evade a spell or explosion. Swarms suffer a -4 penalty to all Reflex saves.

Abilities: As base creature.

Skills: As base creature.

Feats: A swarm is too large and unwieldy to coordinate its actions well enough to make use of its feats.

Climate/Terrain: As base creature.

Challenge Rating: A swarm's CR equals the EL of its component creatures +1.

Treasure: As base creature.

Alignment: As base creature.

DIRE HUMANOID

In some forgotten, isolated regions, there dwell humanoid creatures that exist in a feral, animalistic state. Relying on their natural strength and abilities rather than weapons, armor, and other technological innovations, these primitive humanoids are stronger and tougher than their civilized kin. Much as a dire animal represents a larger, primitive version of a creature, so too does the dire humanoid template create savage, stronger, and bigger versions of standard humanoids. A dire humanoid can represent a caveman, a devolved offshoot of a race, or the results of magical experiments that increase a humanoid's physical abilities at the price of its mental faculties.

CREATING A DIRE HUMANOID

"Dire" is a template that may be added to any humanoid or monstrous humanoid. The base monster's creature type remains the same. It gains improved strength, endurance, better combat abilities, and natural attacks. However, its mental abilities are all reduced by this template. Dire humanoids excel in physical combat but make poor spellcasters.

A dire humanoid uses its base creature's characteristics except where noted below.

Hit Dice: Dire humanoids are bigger and tougher than their base races. They use a d12 for HD rather than a d8. In addition, dire humanoids gain two additional HD due to their increased size and toughness.

Speed: With their increased size and strength, dire humanoids are swifter on foot than their civilized cousins. They gain a +10 foot bonus to their ground speed. Other movement modes remain unchanged.

AC: Dire humanoids gain a +2 natural AC bonus. If the base creature already has a bonus of this type, increase it by two.

Attacks: Dire humanoids are natural born fighters. Their base attack bonus equals their base HD.

Most dire humanoids fight without weapons, though they use them when they can find them. They gain claw and bite attacks that deal damage according to their size. A dire humanoid may make two claw attacks at its best base



attack bonus and one bite at a -5 penalty. The Multiattack feat reduces the bite attack's penalty to -2. A dire humanoid that fights with weapons may still use its bite in addition to its armed attacks. These claw and bite attacks count as armed strikes.

Damage: The tables below summarize the dire humanoids' claw and bite damage.

Size	Bite Damage
Tiny	1d3
Small	1d4
Medium-size	1d6
Large	1d8
Huge	2d6
Gargantuan	2d8
Colossal	4d6

Size	Claw Damage
Tiny	1
Small	1d2
Medium-size	1d3
Large	1d4
Huge	1d6
Gargantuan	1d8
Colossal	2d6

Face/Reach: As base creature.

ABILITY MODIFICATION COSTS

Stat Bonus	Research Cost	Market Cost	CR
+1	2,000 gp	4,000 gp	+1/10
+2	4,000 gp	8,000 gp	+1/5
+3	7,000 gp	14,000 gp	+3/10
+4	10,000 gp	20,000 gp	+1/2
+5	15,000 gp	30,000 gp	+2/3
+6	20,000 gp	40,000 gp	+1

Special Qualities: Dire humanoids are granted the following special qualities.

Animal Instinct (Ex): As near-wild animals, dire humanoids rely on raw physical strength to overpower their enemies. When pressed in combat, they may rage as per the barbarian class once per day. The dire humanoid draws on its instincts and will to survive to transform itself into a frothing berserker.

Hunter's Stealth (Ex): Long years of stalking prey grant dire humanoids improved ability to sneak up on opponents. They gain a +4 racial bonus to Hide and Move Silently checks. Furthermore, they may move up to full speed while using these skills without penalty.

Saves: As base creature.

Abilities: Dire humanoids gain +4 Strength, +2 Dexterity, +4 Constitution, -6 Intelligence, and -6 Charisma. Though tougher than their civilized counterparts, they are simple creatures often barely above animal intelligence.

Skills: Dire humanoids gain none of their base creature's skills. Instead, they have a total of 10 ranks +2/HD to spend on skills. They may spend ranks on the following skills:

Climb (Str), Concentration (Con), Escape Artist (Dex), Handle Animal (Cha), Heal (Wis), Hide (Dex), Intimidate (Cha), Intuit Direction (Wis), Jump (Str), Listen (Wis), Move Silently (Dex), Spot (Wis), Swim (Str), and Wilderness Lore (Wis).

Feats: Dire humanoids gain none of their base creature's feats. Instead, they gain one feat plus an additional one for every 4 HD.

Climate/Terrain: Typically wilderness and frontier forests, jungles, and mountains.

Organization: Tribe (6 - 24).

Challenge Rating: As base creature +1.

Treasure: Half standard.

Alignment: As base creature.

EXPERIMENTAL CREATURES

The new rules presented here cover the magical creation of new humanoid species. Unlike the monster creation rules, these guidelines are focused on modifying humanoid species that have few abilities of their own and serve best as long term enemies who grow in power via class levels over the course of a game. Fantasy literature is rife with instances of wizards creating new life forms to serve them as slaves and warriors. The rules presented here allow an evil spellcaster to develop humanoid life and bend it to his needs.

To create an experimental creature, a character must select the following feat:

ARCANE SURGEON [ITEM CREATION]

Your study of magic combined with your knowledge of nature, biology, and medicine allows you to construct living creatures from parts derived from and added to humanoid creatures. You stitch a viper's fangs into an orc's mouth, add gills to a human, or increase a gnoll's muscle mass by implanting organs taken from a carnivorous ape.

Prerequisite: Arcane spellcaster level 7+, Heal

skill (5 ranks), Knowledge (arcana) (12 ranks), non-good alignment.

Benefit: You may modify living creatures using the system outlined below.

OVERVIEW

A caster must pick the new options he wishes to grant to a humanoid from the lists given below. These options work much like the special abilities detailed in Chapter 1 and in each creature-type chapter of this book. If you want to create a new humanoid for your campaign, the process works exactly as modifying a creature with new special abilities. If a character or NPC undertakes this process, he must then calculate the time and money needed to complete the modification.

Characters may opt to receive these abilities. If they choose to do so, they must pay twice the listed cost to pay a surgeon to modify them. In a campaign world where such modifications are common, an entire guild and industry could grow around custom-designed body modifications.

After picking out modifications, the arcane surgeon must then make a Heal check to successfully operate on his patient. A failure indicates a mishap. Full details for this process are given after the feature descriptions.

CREATURE MODIFICATION

When applying these changes to a humanoid, do not increment its HD as suggested in Chapter 1 of the *Monster's Handbook*. The changes listed here are not radical enough to justify increasing both a creature's CR and its HD. None of them replicate attacks or spells. Each feature lists a CR modifier, the research cost paid by the arcane surgeon, and the market price for the package. Since the CP costs are paid by an existing creature, simply keep track of all modifications and adjust a creature's CR as soon as it gains enough modifications to warrant an increase.

Arctic Package: Creatures granted organs and traits taken from arctic animals receive cold resistance 5 and a +2 natural armor bonus due to thick fur. Polar bears, frost worms, and remorhazes all provide body parts necessary for these creatures.

Absolute Cost: 25 CP; *Research Cost:* 4,000 gp; *Market Price:* 8,000 gp.

Claws: By mounting steel razors on the upper ends of a humanoid's hands, a surgeon can grant an otherwise unarmed creature a useful natural attack. Creatures with this ability may attack twice per round with their claws at their normal attack bonus if they do not wield a weapon. They count as armed when fighting in this manner and deal damage according to the table below.





Size	Claw Damage
Small	1d3
Medium-size	1d4
Large	1d6
Huge	1d8

Absolute Cost: 25 CP; *Research Cost:* 2,000 gp; *Market Price:* 4,000 gp.

Fangs: Removing a humanoid's natural, simple teeth and replacing them with fangs taken from a great cat, serpent, or other creature allows it to bite in combat. It may fight with a weapon at its normal bonus and bite at a -5 penalty, or bite at its full attack bonus if it takes no other attacks. The Multiattack feat reduces the penalty to -2. A humanoid with this feature may be given a poison attack as per Chapter 1.

Size	Bite Damage
Small	1d3
Medium-size	1d4
Large	1d6
Huge	1d8

Absolute Cost: 25 CP; *Research Cost:* 1,200 gp; *Market Price:* 2,400 gp.

Horns: Careful modifications of the skull allow an experienced surgeon to add a pair of long, powerful horns to a humanoid. The creature may make a gore attack once per round that deals damage based on its size. Furthermore, if it charges into combat and attacks with its horns, it deals double damage. Only creatures of the sizes listed on the table below may gain this ability. A humanoid with this ability may attack with its horns at a -5 penalty in addition to fighting with its normal weapons. The Multiattack feat reduces this penalty to -2.

Size	Horn Damage
Medium-size	1d6
Large	1d8
Huge	2d6

Absolute Cost: 25 CP; *Research Cost:* 1,500 gp; *Market Price:* 3,000 gp.

Piscine Package: Using gills, flippers, fins, and other parts taken from water-going creatures, an arcane surgeon can grant a humanoid the ability to breathe underwater and gain a swim speed equal to one half its base speed.

Absolute Cost: 50 CP; *Research Cost:* 1,000 gp; *Market Price:* 2,000 gp.

Scales: Starting with the hide of a crocodile, rhino, or other thick-skinned creature, a surgeon can transplant fresh skin onto a humanoid in order to grant it improved protection from attacks. The recipient of this procedure gains a +4 natural armor bonus.

Absolute Cost: 50 CP; *Research Cost:* 16,000 gp; *Market Price:* 32,000 gp.

Scent: Alterations to the olfactory nerve can grant a humanoid the ability to track by scent much like a bloodhound or similar animal. A creature with this feature gains the scent special ability.

Absolute Cost: 25 CP; *Research Cost:* 2,000 gp; *Market Price:* 4,000 gp.

Wings: The most complicated procedure possible under these rules, the surgeon transplants wings taken from a harpy, giant bat, or similar creature and implants them into a humanoid's back. The creature may fly at twice its base speed with a maneuverability class of clumsy. Its wingspan equals 10 feet.

Absolute Cost: 100 CP; *Research Cost:* 5,000 gp; *Market Price:* 10,000 gp.

ABILITY MODIFICATIONS

The process of altering a humanoid can also extend to granting it better reflexes, greater muscle mass, and a heartier form. A creature's Strength, Dexterity, and Constitution may all be increased by paying the costs listed below. Intelligence, Wisdom, and Charisma cannot be modified in this manner.

Table 8-2 lists the base cost for a total bonus. A creature that buys a +2 bonus and later opts for a +4 bonus must pay the full price, even though the bonuses do not stack. Buying a smaller bonus does not serve as a down payment on a later upgrade. Increases beyond +6 are not possible with these procedures.

SURGERY AND MODIFICATION RESULTS

The base Heal DC to implement a set of modifications is 10 + the total research cost of the modifications divided by 1,000. It takes one day of work for every 2,000 gp, or fraction thereof, in the total research cost of the treatments, during which the subject can do absolutely nothing other than endure his treatment.

Failed treatments have the potential to scar the subject permanently. On a failed roll, the subject must make a Fortitude save with a DC equal to the Heal check DC. On a failed save, the subject permanently loses 1d4 points from a random ability. This score becomes the character's new maximum and cannot be restored with any magic short of a *wish*. The arcane processes behind these treatments subvert and alter the subject's fundamental nature.

SAMPLE CREATURE: BROLGASH'S ORCS

The half-orc archmage Brolgash has labored long and hard to produce these beasts, the pinnacle of orckind. Crafted from raw biological materials, he now harvests them in the caves beneath his tower and plans to unleash them on the world. Granting them great horns, sharp claws, and thick, tough hides, they rely on their natural weapons to overwhelm foes.

Brolgash's Orcs: CR 2; Large humanoid; HD 4d8; hp 18; Init +0; Spd 20 ft. (scale mail); base

30 ft.; AC 18 (+4 scale mail, +4 natural); Atk +5 melee (1d6+2, 2 claws), +3 melee (1d8+1, horns); Reach 10 ft.; SA Charge (double damage with horns); SQ Darkvision 60 ft., light sensitivity, body modifications (horns, claws, scales); SV Fort +4, Ref +1, Will +0; Str 15, Dex 10, Con 11, Int 9, Wis 8, Cha 8.

Skills: Listen +2, Spot +2, Wilderness Lore +2.
Feats: Multiattack.



TRAPS & TREACHERY

Traps & Treachery was the first in the **Legends & Lairs** series, and remains a classic. It starts off innocently enough, giving roguish players new prestige classes, feats, skills, spells, equipment, magic items, poisons, and background information.

In the second chapter, the pain begins.

Traps are a player's worst nightmare. They're hard to detect, difficult to avoid, and strike tough fighters and weak spellcasters alike. No trap will ever have mercy on a PC or run away after being intimidated. If a trap were a monster, it would *always* coup de grace. Worst of all, traps use up time and effort even when they aren't there, just because you think they might be.

In other words, traps are a DM's best friend. There is little else in the game with which the DM can be so sneaky, so deadly, and so unabashedly mean.

The trap section starts off with guidelines

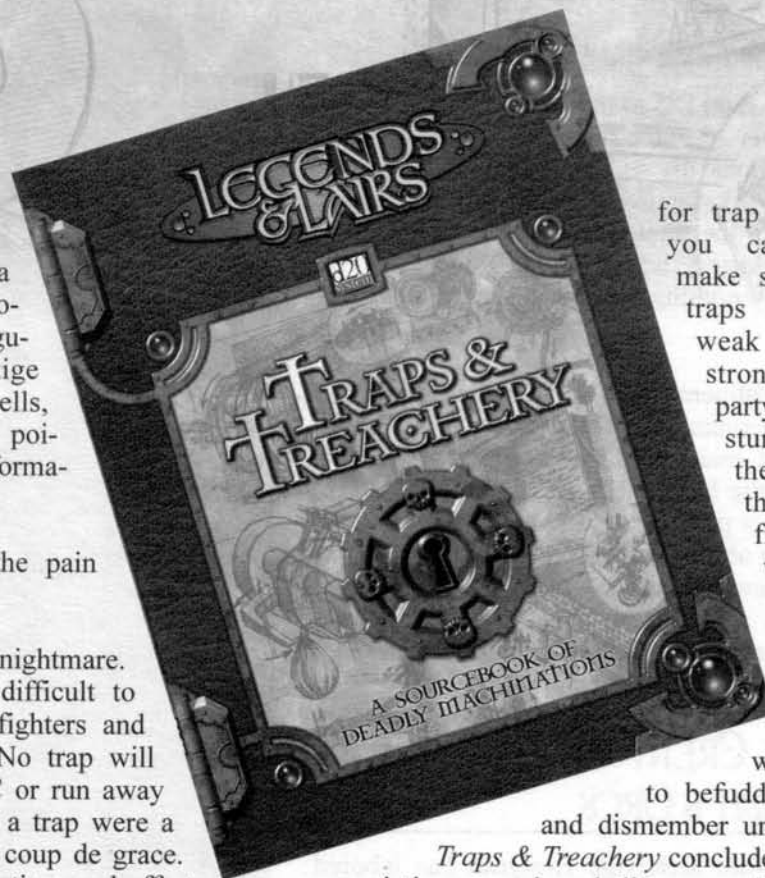

for trap design so you can finally make sure you're traps aren't too weak or too strong for the party that will stumble upon them. After that you'll find a huge variety of traps, both mechanical and magical, with which to befuddle, disturb, and dismember unwary PCs.

Traps & Treachery concludes with trap variations: puzzles, challenges, and riddles.

All of the text in this section describing rules for and names of traps, trap categories, and game mechanics derived from the d20 System Reference Document is considered **Open Game Content**. All background text describing these is considered closed content.

THE ROGUE'S ROLE

Your party is exploring the Lost Temple of the Fire King. Tyro the Mighty, his magical greatsword dripping gore, has rendered all life extinct throughout the upper levels of the dungeon. Mab the sorcerer's hands are still smoking from the gouts of flame that engulfed the enemy host. Father Mallory, the cleric, is prattling on about a great evil lying down the hall and behind an unopened crypt gate.

The game comes to a standstill as the DM asks, "So rogue, what do you want to do?"

This is your opportunity to shine! Other than periodically trying to get a sneak attack in, you've spent the last few hours making a log cabin out of pretzel rods and onion dip.

You declare with conviction, "Um, Simbo picks the lock on the gate!" Your DM gives you a blank look, fiddles with his dice for a moment and tells everyone that this would be a good point to break for dinner.

TRAP LORE

There are myriad ways to search an area and many of them will earn you praise and possibly even extra experience points. More importantly, you won't end up as rogue jerky for the wights behind the trapped gate.

As a rogue, you've been taught to be patient, and most importantly, observant. You are trained to recognize and manipulate scores of trapdoors, secret doors, false bottoms, murder holes, chutes, pressure plates, gears, pulleys, and a wide variety of locks and switches. Your life depends on your ability to observe and act on the smallest details.

A sorcerer looks at the gate and notes with satisfaction that it has a lock and that lock seems to be thrown closed. A rogue drops and eyeballs the floor to check for pressure plates and tripwires. He scans the ceiling and walls for any openings where blades, gas, acid, water, or myriad other





harmful agents and objects could be discharged. After deciding the area in front of the opening is safe to work in, the rogue starts checking out the gate itself.

Forget thieves' tools and lock picks—the five basic senses are the core tools the rogue relies on in a dungeon. The rogue has been trained to use them together or with any of them hindered or useless. While some are more developed than others, a successful rogue will use them all to gather as much information as possible.

After a detailed scan of the area, Simbo determines that the ancient gate is not only locked but armed with a two-stage trap. If the trap is not disabled, the floor on his side of the gate will collapse and the rigged ceiling will follow to crush his unknowing companions. Simbo decides to jam the collapsing floor first and then deal with the relatively simple gate lock.

When you return from dinner, the DM asks again, "So what exactly did you want to do?" You smile and start to describe, at length, your stealthy assault on the temple's crypt. After successfully jamming the trap, walking the walls, unlocking the gates, and retreating to a safe distance, you smile to yourself and wonder what else your rogue character may be capable of with a little planning.

CHALLENGE RATINGS

The Challenge Ratings of mechanical and magic traps can vary widely. They should typically be adjusted for such variables as the difficulty of detecting and disabling or avoiding the trap, and how effective or dangerous the trap is. Challenge Ratings for traps should generally range between 1 and 10.

MECHANICAL TRAPS

The base Challenge Rating for a mechanical trap is 1. This can be modified by the difficulty of detecting and disabling the trap.

SIMPLE MECHANICAL TRAPS

Search/Disable Device DC	CR Modifier
20	+0
21-25	+1
26-30	+2
31+	+3

COMPLEX MECHANICAL TRAPS

Search DC	CR Modifier
21	+0
22-25	+1
26-30	+2
31-35	+3
36+	+4

COMPLEX MECHANICAL TRAPS

Disable Device DC	CR Modifier
21	+0
22-25	+1
26-30	+2
31-35	+3
36+	+4

These modifiers are cumulative for the DCs of both Search and Disable Device checks. For example, the Challenge Rating of a simple trap with a Search and Disable Device DC of 22 would be increased by 2.

The Challenge Ratings of mechanical traps should also be modified by their effectiveness. For this purpose, you can assign an *effect level* to your mechanical trap.

For injury traps, the effect level is determined by the amount of damage the trap inflicts when activated. Once you've determined the effect level, simply add it to the base Challenge Rating of the trap. The base damage for an effect level 0 trap (no modifier to Challenge Rating) is 2d6. The effect level is increased by 1 for every additional 2d6 points of damage the trap inflicts. The following table also lists the average points of damage inflicted at each effect level.

The numbers for ability score damage refer to the maximum total initial and secondary damage. For example, burnt othur fumes cause 1 point of initial Con damage and up to 18 points of secondary Con damage, for a maximum total ability loss of 19. The base effect level for a trap using this poison would be 8.

INJURY TRAPS

Effect Level	Hit Point Damage	Ability Damage
0	2d6 (7)	—
1	4d6 (14)	1-3
2	6d6 (21)	4-5
3	8d6 (28)	6-8
4	10d6 (35)	9-10
5	12d6 (42)	11-13
6	14d6 (49)	14-15
7	16d6 (56)	16-18
8	18d6 (63)	19-20
9	20d6 (70)	21+

The effect level of ensnarement traps is based on the difficulty of escaping from the snare. For common snares, this is based on the snare's total grapple attack bonus (base attack bonus + Strength modifier + special size modifier).

ENSNAREMENT TRAPS

Effect Level	Grapple Attack Bonus
0	+1 to +5
1	+6 to +10
2	+11 to +15
3	+16 to +20
4	+21 to +25
5	+26 to +30
6	+31 to +35
7	+36 to +40
8	+41 to +45
9	+46 to +50

Other snares might require a skill check to escape, such as a Climb check to escape a pit or a Swim check to escape a water trap. In this case, the effect level should be based on the DC of the check.

Effect Level	DC
0	20
1	21-25
2	26-30
3	31+

The distance the victim is moved determines the effect level of movement traps. A trap with only a local effect, such as one that moves the victim to a nearby room, corridor, or area, is effect level 0. The classic example is a rotating wall that moves the character to an adjoining room. A trap that moves the character to a completely different area, such as another level of the dungeon, has an effect level of 1. A trap that moves the character to a



completely different region, such as one that takes the victim out of the dungeon entirely (or into it), has an effect level of 2. Note that movement traps typically have lower Challenge Ratings than those with injury or ensnarement effects, since they represent an inconvenience or setback, rather than a direct threat. Of course, they can be combined with other traps or monster encounters to dangerous effect, but these additional traps or monsters will have their own Challenge Ratings.

MOVEMENT TRAPS

Effect Level	Moved To
0	Nearby room, corridor, or area
1	Another area of the location, such as another dungeon level
2	A completely different region, such as out of the dungeon

The effect levels of hindrance traps can vary widely. As a general rule of thumb, the DM should assign a trap using a hindrance effect a subjective rating reflecting the severity of the hindrance. There are three broad categories to use when assigning this rating.

Effect Level Hindrance

0	Minor: The trap slows or delays the victim, but presents no danger and does not place the victim at a serious disadvantage.
1	Major: The trap puts the victim at a serious, albeit temporary, disadvantage, though it represents no direct danger. A trap that plunges the victim into darkness temporarily might be a major hindrance.
2	Severe: The trap puts the victim at a serious, long-term disadvantage. A trap that blinds the victim for an extended period of time might be a severe hindrance.
3	Catastrophic: While it inflicts no direct physical or mental harm on the victim, the trap puts him at a potentially devastating disadvantage. A trap that relieves the character of all his equipment and/or magic items might be a catastrophic hindrance.

Identification traps also tend to have relatively low effect levels, for the same reason as movement traps. An identification trap that alerts any nearby guardians to the presence of trespassers is effect level 0. This type of trap does not

specifically identify the character or characters who triggered the trap. An effect level 1 identification trap might alert any guardians in the area, such as the dungeon level, or specifically identify the characters who triggered the trap to nearby guardians. An effect level 2 identification trap might alert any guardians in the dungeon or adventure location, or specifically identify the characters who triggered the trap to any guardians in the area, such as the dungeon level. An effect level 3 identification trap would specifically identify the characters who triggered the trap to any guardians in the dungeon or adventure location.

Effect Level Identifies

0	Presence of unknown trespassers to nearby guardians
1	Presence of unknown trespassers to any guardians in the area, or specific character to nearby guardians
2	Presence of unknown trespassers to any guardians in the dungeon or adventure location, or specific character to any guardians in the area
3	Specific character to any guardians in the dungeon or adventure location

OTHER CR MODIFIERS

Feature	CR Modifier
Multiple Attacks	+1
No attack roll necessary	+1
Save to avoid	-1
Instant trap	+0
Extended trap	-1

MAGIC TRAPS

Determining Challenge Ratings for magic traps is much easier than for mechanical traps, because a system for measuring the effectiveness of magical effects is already in place. The Challenge Rating for a magic trap is simply equal to the *spell level* of the spell or spell-like effect used in the trap.

For magic traps that mimic spells whose effectiveness is dependent on caster level, the base Challenge Rating always assumes that the spell or spell-like effect functions as if cast by a spellcaster of the minimum allowable caster level. Increase the Challenge Rating by 1 for each level of increase in magic trap's caster

level. For example, a *fireball* trap that functions as if cast by a 6th-level wizard would have a Challenge Rating of 4 (3 for the spell level + 1 for the additional caster level).

NEW TRAPS

BLACKSTONE'S WICKED WINDOW

Trap Type: Scything Blade

Construction Type: Complex mechanical

Activation Type: Instant

Trigger: Local; switch

Mechanism: Spring

Effect: Injury

Attack Bonus: +10 melee

Damage: 1d8/x2 crit

Save: None

Search DC: 21

Disable Device DC: 21

Challenge Rating: 1

Construction Time/Cost: 1 week; 1,000 gp

This is a very basic mechanical trap used to protect a home or other secure site from trespassers and thieves. Most rogues expect doors to be locked and possibly trapped, and windows are often the favorite alternative point of entry.

This trap is built into a normal window, one with shutters but no windowpane. When the concealed pressure switch is depressed, a spring-loaded blade slices down like a guillotine, often severing curious fingers or severely injuring anyone attempting to climb through the window.

This device is among the simplest of complex mechanical traps. A cautious rogue will spot the opening along the top of the window frame that houses the blade. The pressure switch will also be apparent on close inspection. An iron spike or several well-placed nails hammered into the frame will usually prevent the trap from functioning. Once the trap is activated, the blade must be returned to its housing in the window frame and the spring mechanism reset.

BLOOD OF THE WILD

Trap Type: Monster Trap
Construction Type: Complex mechanical
Activation Type: Extended
Trigger: Local; switch and trapdoor
Mechanism: Pressure, gear
Effect: Identification
Attack Bonus: No attack roll necessary
Damage: None
Save: Reflex save (DC 22) avoids
Search DC: 21
Disable Device DC: 21
Challenge Rating: 1
Construction Time/Cost: 1 week; 1,000 gp

The Blood of the Wild is a two-step trap that uses a high-pressure spray of pig's blood to entice a pack of starving wolves into a feeding frenzy at the trespassers' expense.

Typically placed in an underground cave or long passageway that turns into a blind corner, this trap's first stage sprays unsuspecting characters with pig's blood. The characters can make a Reflex save (DC 22) to avoid the blood spray. This will often confuse paranoid adventurers, who assume that some sort of poison or spell effect is involved, but this is not the case. The trap is based on a simple premise: Starving wolves will be attracted to the scent of blood and attack its source.

When the blood spray is triggered, the trap's second stage is activated. A gearwork mechanism in the walls raises a cage door several yards away, typically around the corridor's blind corner. When the cage door is raised,

2d6 starving wolves (MM 204) are released. The wolves will focus their attacks on characters who have been sprayed with blood.

The listed CR applies only to the trap: Experience should also be rewarded for any creatures the characters must face. The DM can scale the encounter level by substituting dire wolves or other more powerful creatures.

An observant rogue, with a successful Search check, will most likely notice the outline of the pressure plate set in the floor of the corridor. Further investigation will lead to the discovery of the spray nozzle in the wall, adjacent to the floor panel. A rogue must jam the floor panel or plug the spray nozzle to disarm the trap.

"AFTER YOU!" TRAPS

The following traps are both designed as examples of traps intended for use inside an inhabited and active complex, such as a thieves' guild headquarters. More specifically, they are both based around defeating attempts to coerce an insider to lead invaders through the traps.

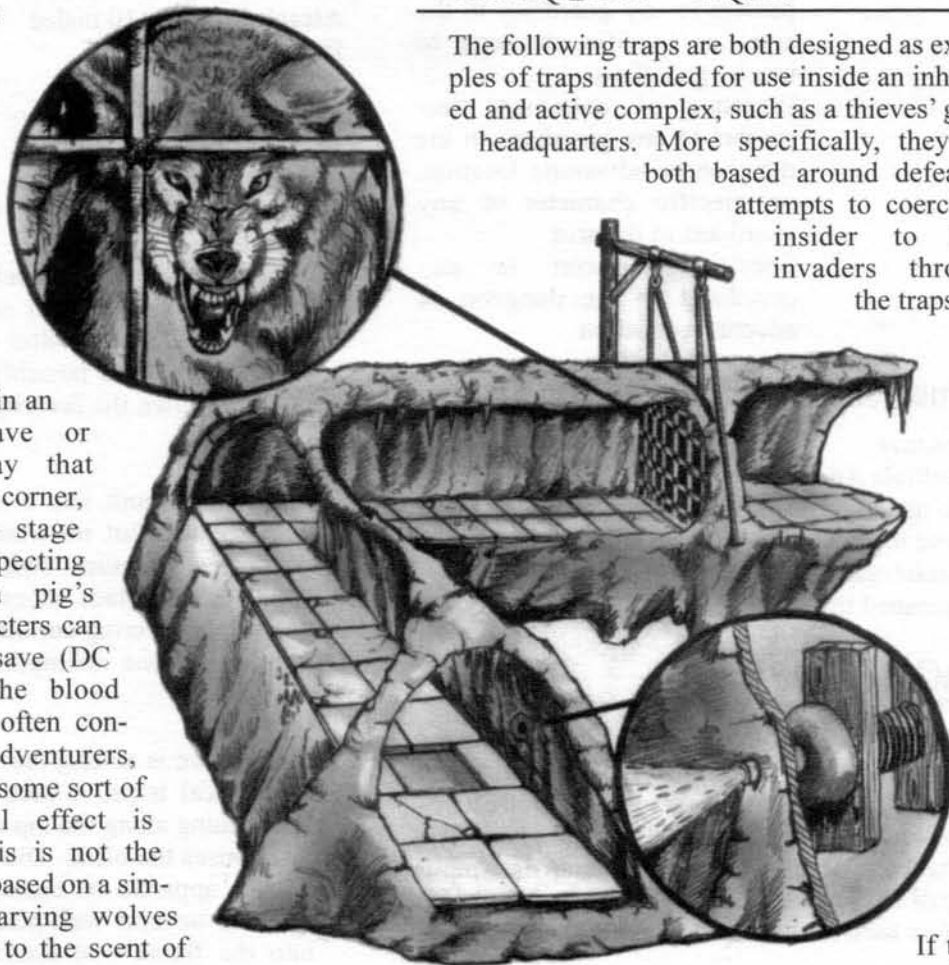

If these traps have been set up, and the original location then abandoned, amusing possibilities remain. Whoever is "taking point" will, if they fail to notice the traps, trigger them on those following behind.

The normal situation in which these traps are encountered, though, is this: The party, for whatever reason, needs to enter a place (a thieves guild, a temple of evil, a castle treasury) where they expect to encounter traps, snares, and the like. Since these locations are inhabited, and the “natives” need to be able to move freely among the traps, the party will find some likely individual, and, using debating skills, bribery, or a crossbow loaded and aimed at the back of the neck, convince this person to lead them through the dangers that await them.

The chosen “guide” will, after token resistance, comply, and “grudgingly” lead his captors into the labyrinth, where he will helpfully toggle switches, unhook wires, say the pass phrase, and otherwise “safely” escort his guests deeper into the complex. Of course, most of what he is doing is meaningless, and what isn’t meaningless is actually setting remote triggers for traps further along, not to mention tipping off the other inhabitants to be on their guard. Once the party is deep inside and cannot escape easily, traps begin going off even as the rest of the complex’s inhabitants move in to capture or kill the invaders.

The following are two typical “After You!” traps. These should serve as inspiration for similar variations on other traps. The key is to modify the trap so that a person who knows where the trap exists can cause it to trigger against others nearby while leaving that person unharmed and in a position to take further action.

BEHINDER Pit

Trap Type: Pit Trap

Construction Type: Simple mechanical

Activation Type: Instant

Trigger: Local; switch

Mechanism: Gravity

Effect: Injury, ensnarement

Attack Bonus: No attack roll necessary

Damage: 4d6

Save: Reflex save (DC 20) avoids

Search DC: 26

Disable Device DC: 20

Challenge Rating: 4

Construction Time/Cost: 4 weeks; 4,000 gp

This trap is a typical pit trap, with the distinction that the trigger for the trapdoor covering the pit is beyond the pit itself, assuming the usual direction of travel. An individual walks

across the trapdoor without it opening, then steps on a pressure plate just beyond the pit’s edge. This plate activates a simple mechanism that removes the rod securing the door so that it falls inwards, dumping those behind the individual who triggered the trap into the pit.

Variations: Almost any trap can be redesigned in this fashion, so that it is triggered/activated by a group leader and is sprung against those in the rear.

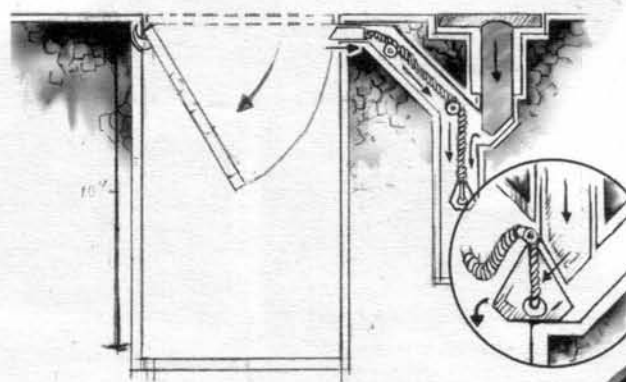

DOUBLE-ROPE DEADFALL NET

Trap Type: Net Trap
Construction Type: Complex mechanical
Activation Type: Instant
Trigger: Local; switch
Mechanism: Gravity
Effect: Ensnarement
Attack Bonus: +12
Damage: None
Save: Reflex save (DC 23) avoids
Search DC: 25
Disable Device DC: 28
Challenge Rating: 4
Construction Time/Cost: 4 weeks; 4,000 gp

The main purpose of this trap is ensnarement for later questioning. Like the Behinder Pit, it is designed to target those following a knowledgeable guide through a trapped warren.

The mechanism is fairly simple. Suspended above the corridor, hidden in ceiling shadows or concealed by clever stonework are heavy rope nets. Below the nets is a pressure plate that, when depressed, activates a mechanism that causes a small amount of acid to spill onto the ropes that keep the nets suspended. The first drops don't do enough damage to burn through the ropes—but the second time the plate is triggered, the rope will be burned through, the nets will fall, and the victims will be ensnared.

While this particular design is intended only to ensnare, more lethal variants exist. Following the same basic mechanism, the nets could be

filled with
 heavy
 boulders,

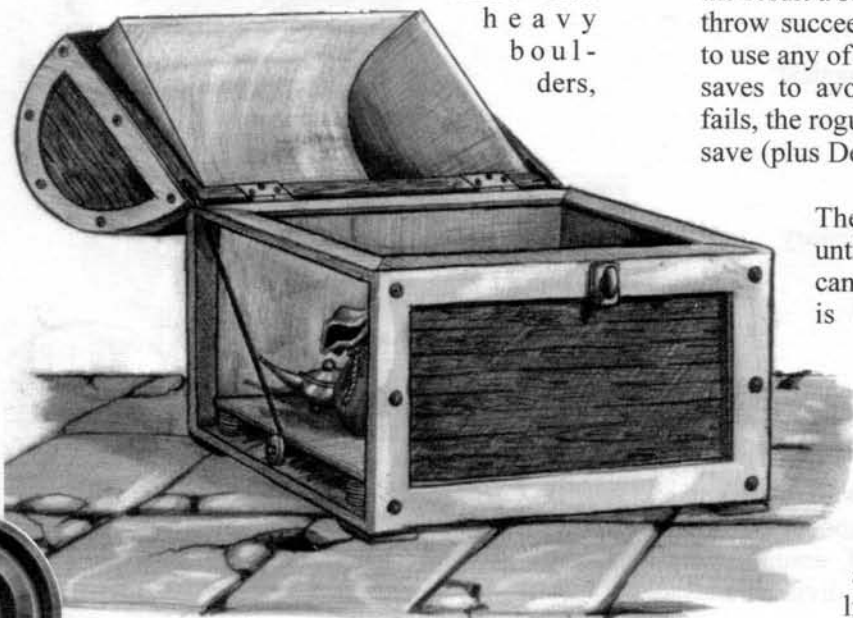

causing 4d10 points of damage to anyone in the area of effect (Fortitude save at DC 25 for half damage). Likewise, soaking the nets with poison, especially paralytic or sleep poison, can increase the effectiveness of this trap as well.

FOOL ME TWICE

Trap Type: Blade Trap
Construction Type: Complex mechanical
Activation Type: Instant
Trigger: Local; switch
Mechanism: Spring (elastics), gear
Effect: Injury
Attack Bonus: +9
Damage: 6d6
Save: Reflex save (DC 26) avoids
Search DC: 28
Disable Device DC: 25
Challenge Rating: 5
Construction Time/Cost: 5 weeks; 5,000 gp

Every veteran rogue who lives to enjoy any success has learned to live by a simple truth: Chests have traps. Only the most talented rogues, however, live long enough to learn that some chests have more than one...

This trap can be added to any chest that is already trapped. It is designed to be activated after the primary trap has been disarmed, to catch a thief who has let down his guard. Unless the player specifically states he is looking for a second trap, a rogue must make a Will save (DC 20) after opening the chest. The DM may choose to make this roll himself to keep the result a secret from the player. If the saving throw succeeds, the rogue is sufficiently alert to use any of his class or feat bonuses to Reflex saves to avoid the trap. If the saving throw fails, the rogue may only use his normal Reflex save (plus Dex bonus).

The trigger mechanism is locked until the first trap is disarmed, so it cannot be set off by accident. Once it is armed, though, even a slight change in pressure—such as that caused by a rogue rummaging through the treasure—will activate it.

Once activated, the mechanism uses the tightly coiled elastics to spin gears, which in turn cause the lid of the chest to slam shut. A

retractable razor-edged blade is set into the lid of the chest.

More than one enterprising rogue has had his career—and limbs—cut short by this device. These disabled veterans often help train novice recruits in the thieves' guild, providing a graphic demonstration of the perils of overconfidence.

BLACKSTONE'S SHREDDER CHUTE

Trap Type: Chute and Scything Blades Trap

Construction Type: Complex mechanical

Activation Type: Instant

Trigger: Local; trapdoor and switch

Mechanism: Gravity, gear

Effect: Injury, ensnarement

Attack Bonus: +10 melee, 1d4 blades

Damage: 1d8

Save: Reflex save (DC 20) avoids chute

Search DC: 20

Disable Device DC: 25

Challenge Rating: 3

Construction Time/Cost: 3 weeks; 3,000 gp

Blackstone's Shredder Chute is a complex mechanical trap that integrates a chute with a lethal blade trap. It is usually constructed in a dungeon corridor, though it can also be built in a room to protect a specific area.

The initial trigger for the trap is a mechanical trapdoor covering a steeply graded chute. A character who steps on the trapdoor and fails a Reflex save (DC 20) falls down the chute. A pressure plate located halfway down the chute triggers a spring-wound gear mechanism that powers a scything blades trap further down. The gear turns the blades and any character falling into them is attacked by 1d4 blades, each doing 1d8 points of damage on a successful hit. The character can attempt to grab onto the mechanism as he falls past with a successful Reflex save (DC 15). However, the character is subject to additional attacks each round as long as he is within 5 feet of the blade mechanism. Otherwise, a surviving character will continue tumbling past the scything blades, eventually landing in a small cell.

Escaping from the trap without assistance requires a Climb check (DC 15). If the character is unable to disable the blades, he will be subject to further attacks when he attempts to

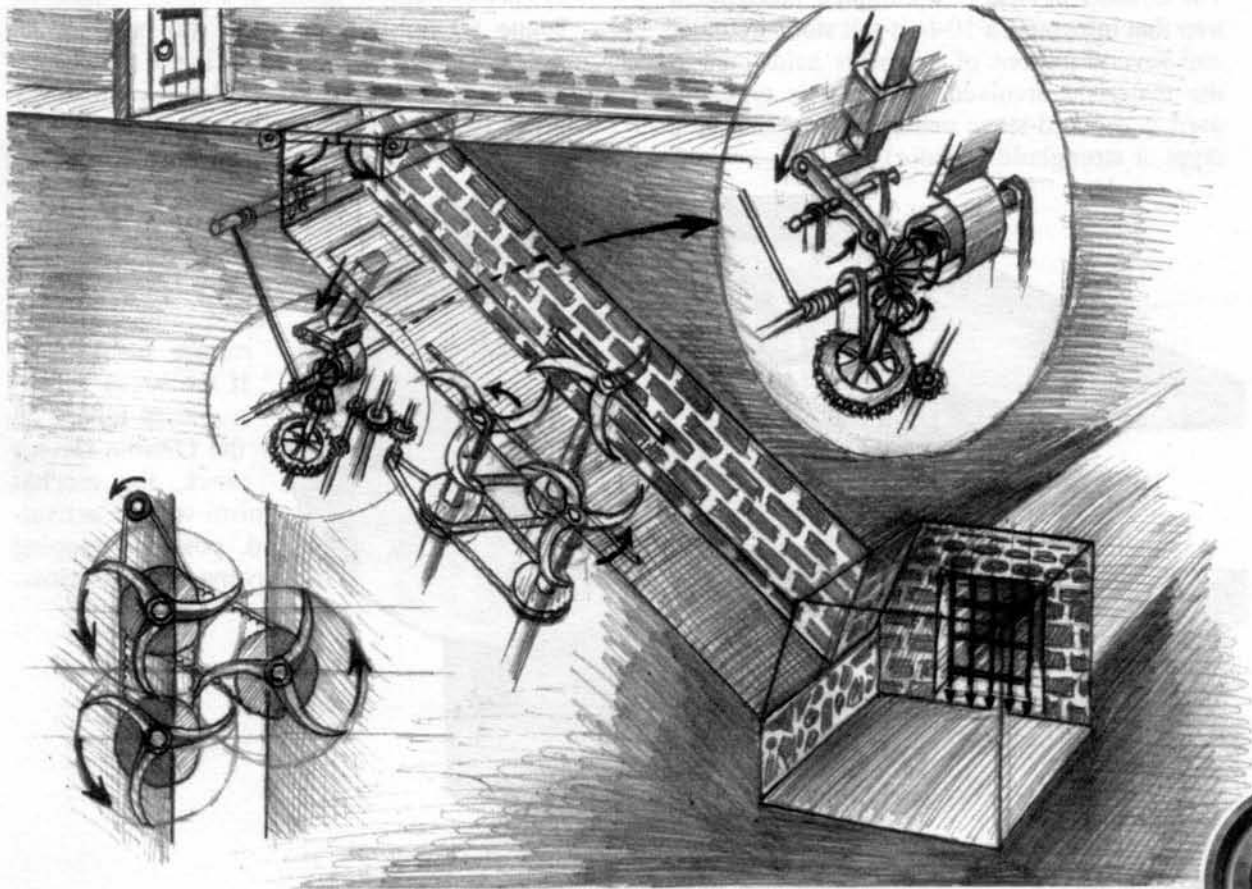

climb past them. The blades will continue to turn for five rounds, at which point the gear winds down and must be reset.

Because it relies on a simple trapdoor, Blackstone's Shredder Chute is not particularly difficult for an alert rogue to locate. Completely disarming the trap is more difficult. The rogue will have to locate the pressure plate and jam it, working in the dark, confined, and steeply sloped chute.

CYLINDER OF ACID

Trap Type: Acid Trap

Construction Type: Complex mechanical

Activation Type: Extended

Trigger: Local; switch (pressure plate)

Mechanism: Gravity

Effect: Ensnarement, injury

Attack Bonus: No attack roll necessary

Damage: 1d6 per round

Save: Reflex save (DC 20) avoids

Search DC: 30

Disable Device DC: 25

Challenge Rating: 6

Construction Time/Cost: 6 weeks; 6,000 gp

The Cylinder of Acid is a complex mechanical trap that integrates a 10-foot-tall stone cylinder and several gallons of corrosive acid. Due to the materials involved, this trap is typically used in worked-stone passageways (such as a crypt or stronghold corridor).

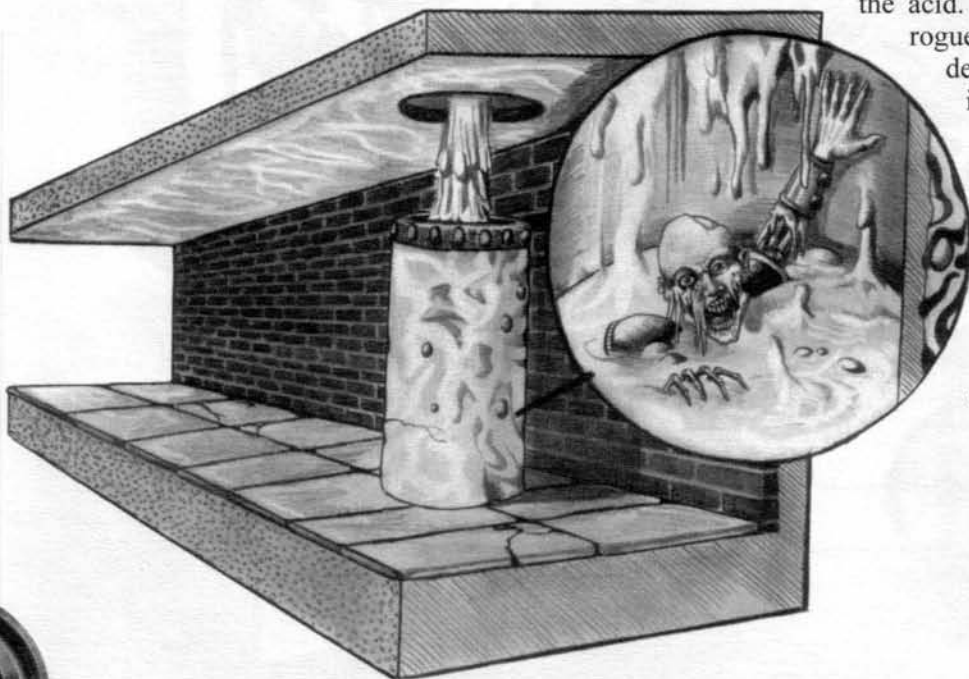

When triggered by a character, a large, ornately designed stone cylinder (usually 10 feet in diameter) falls from the ceiling, trapping the victim inside. Simultaneously, the falling cylinder triggers the release of several gallons of acid that are stored in the ceiling just above the shaft.

While trapped inside the cylinder, the victim suffers from acid exposure damage for each round he remains trapped within. It takes five rounds for the cylinder to completely fill with acid (see DMG 88 for full details on acid damage and the effects of acid immersion).

A Strength check (DC 20) is required to lift the cylinder high enough for a character to escape, unless another means of lifting can be utilized. A character on the outside of the cylinder attempting to lift it must make a Reflex save (DC 20) or take 1d6 points of damage from the acid spilling out into the corridor.

A spellcaster trapped in the cylinder who attempts to cast a spell must make a Concentration check (DC 15 + damage taken in the initial round) or be unable to cast spells.

Due to the cylinder's placement and design, it is very difficult to notice at a casual glance. A rogue taking time to study the area might notice the concealed trapdoor in the ceiling that covers the base of the cylinder. A particularly adept rogue may also notice discoloration and scarring on the floor caused by the acid. To disarm the trap, a rogue must reach the cylinder's base along the ceiling, pry open the trapdoor, and jam the release mechanism. If the rogue suffers a critical failure on the Disable Device check, the mechanism will be activated, possibly trapping anyone directly below.

PERIVAX'S PIT OF POISONED WATER

Trap Type: Poisoned Water Pit
Construction Type: Simple mechanical
Activation Type: Instant
Trigger: Local; trapdoor
Mechanism: Gravity
Effect: Ensnarement, injury
Attack Bonus: No attack roll necessary
Damage: 10d6 plus poison and drowning
Save: Reflex save (DC 20) avoids
Search DC: 20
Disable Device DC: 20
Challenge Rating: 7
Construction Time/Cost: 7 weeks; 7,000 gp

Perivax's Pit of Poisoned Water is a simple mechanical trap that utilizes a 100-foot-deep pit and a pool of poisoned, paralysis-inducing water to drown victims. The trap is typically used in less-traveled corridors and underground tunnels.

A trapdoor covers the pit opening, which is usually 10 feet square. When the trap is activated, the victim falls the full 100 feet and lands in a pool of stagnant water.

A character trapped in the pit soon realizes that the water is poisoned. Carrion crawler brain juice is the poison typically used (DMG). If the character successfully fights off the effects of the poison, he will have to make a successful Climb check (DC 20) to escape the pit and avoid another saving throw against the poisoned water. The trapdoors reset after being triggered, and a successful Strength check (DC 13) is required to keep the doors open.

While carefully hidden, the trapdoor should not be difficult for a skilled rogue to notice and easily avoid. A rogue might notice that the corridor has a thin layer of dust on the floor, except for the square that conceals the trapdoor, due to the trapdoor's being triggered prior to his arrival. To disarm the trap, a rogue need only wedge a climbing piton or dagger into the groove around the trapdoor's hinges to jam the mechanism.

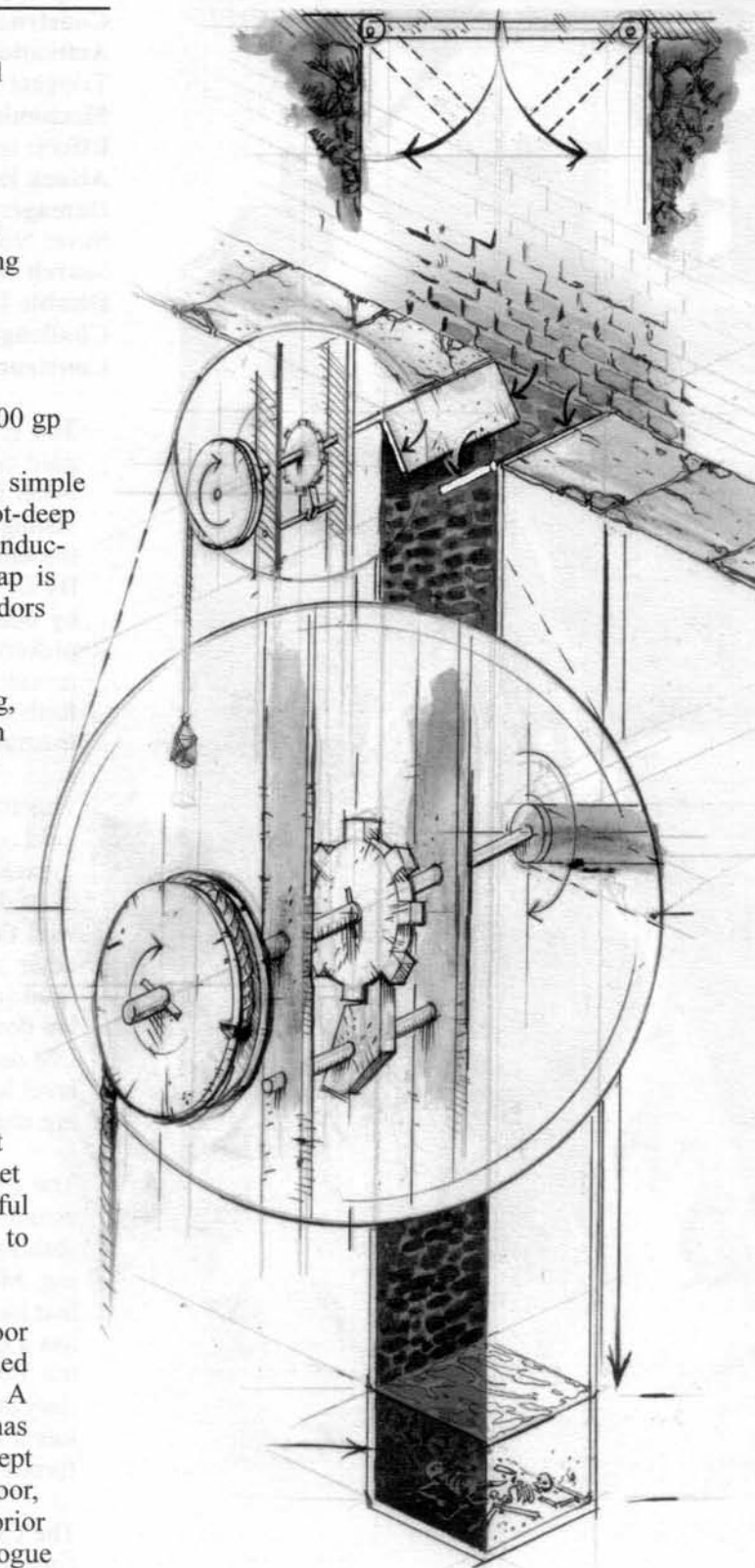



ONE LAST COIN

Trap Type: Monster Trap
Construction Type: Magic
Activation Type: Instant
Trigger: Local; magic
Mechanism: Magic
Effect: Injury
Attack Bonus: None
Damage: None (see text)
Save: None
Search DC: 25
Disable Device DC: None
Challenge Rating: 1
Construction Time/Cost: As *iron flask*

The physical trigger for this trap is a single gold coin, the last of a large treasure, hidden under a bag, crate, or chest. There is nothing to distinguish the coin from a normal one—it is the same size and shape, and it is not magical. By all appearances, it was merely covered over by other items in the trove. Once the coin is picked up, however, the trap itself is revealed—a *bound* (PHB 179) efreeti springs forth and takes out years of pent-up rage and frustration on the adventurers.

This trap can be placed anywhere that a single gold coin would not seem out of place. Typically, it is used as a last-ditch trap intended to defeat the adventurers before they escape with the last treasure in a dungeon, palace, or other secure area. Since the efreeti does not need sustenance while it is bound, this trap can lay dormant for years, decades, or longer. The DM may wish to increase the efreeti's effective level by one per decade, reflecting his increasing anger over his containment.

The trap is very difficult to detect. Since the actual magic is cast upon the efreeti itself, a *detect magic* spell cast on the coin reveals nothing. Moving the coin uncovers the small shaft that has held its tiny prisoner for years. A rogue has a chance to detect the trap by noticing that the floor around the coin is slightly warmer than the rest of the room (the heat of the creature's rage). There might also be a slight sulfurous odor in the area.

The Challenge Rating for the trap does not, of course, include the CR of the efreeti.

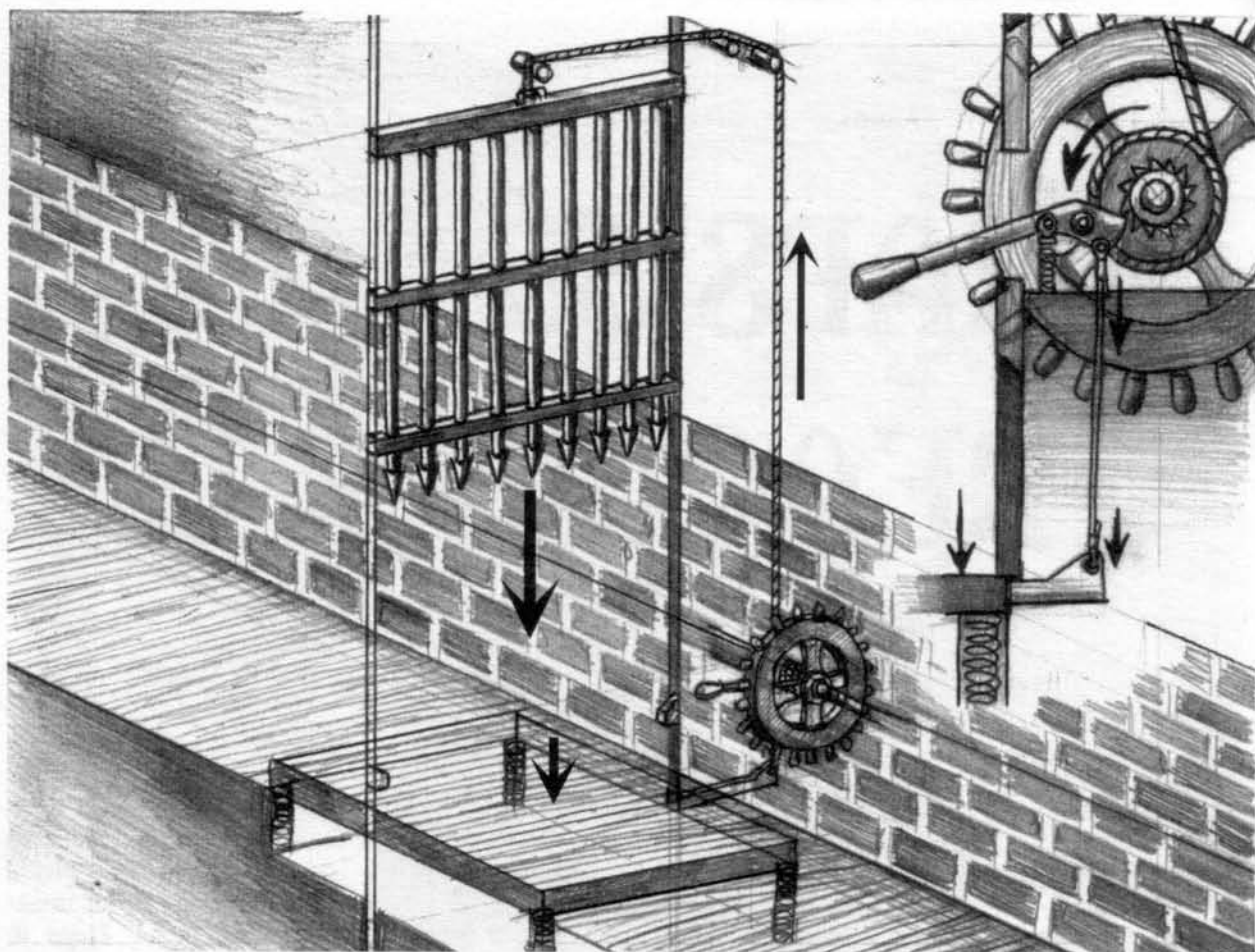

BLACKSTONE'S PARALYZING PORTCULLIS

Trap Type: Portcullis

Construction Type: Complex mechanical, magic

Activation Type: Instant

Trigger: Local; switch, magic

Mechanism: Gravity, magic

Effect: Ensnarement, injury

Attack Bonus: +10 melee (portcullis)

Damage: 3d6/crit x2

Save: Will save (DC 15) negates spell

Search DC: 25

Disable Device DC: 27

Challenge Rating: 3

Construction Time/Cost: 1 week, 2 days; 2,500 gp; 60 XP

The centerpiece of this trap is a standard portcullis, which can be placed in any doorway or corridor. A floor tile directly below the portcullis acts as a pressure plate for the mechanical trap, and a magic trigger for the spell trap. When a trespasser steps on the tile, the magic trap discharges a *hold person* spell.

If more than one person is standing on the tile, the spell will randomly affect one of them. The affected character must make a Will save (DC 15) to resist the effects of the spell.

A split second after the spell is discharged, the portcullis crashes down, just like a traditional portcullis trap. The portcullis makes a melee attack against any character standing under it. The portcullis will automatically hit any character affected by the *hold person* spell. An attack roll should still be made to resolve the possibility of a critical hit. Lifting the portcullis requires a Strength check (DC 25).

The spell trap has 50 charges when constructed. The floor tile that serves as both the pressure plate and spell trigger is the most vulnerable component to detection and disabling. Jamming the pressure plate can disable the mechanical component of the trap. The spell trigger is sensitive to the slightest pressure and is dangerous even if covered. To completely disarm the trap, the rogue must chip around the edges of the tile with a hammer and chisel, lifting and removing it entirely.

TRAPS & TREACHERY II

The dwarf trudged down the passage, grumbling. His human companion tried to hush him, fearing the tomb's ancient guardians would awaken to silence his complaints permanently. Suddenly from up ahead they heard several voices crying out in the barking language of gnolls.

"Quick, into those alcoves just ahead!" said Cress as he tumbled toward the left side of the corridor to avoid any oncoming arrows.

The dwarf was about to follow his lead, but just as he started to jump to his right he saw the floor underneath the rogue rise up and dump him into a chamber beyond.

"It's a trap!" yelled the dwarf. He lowered his head and charged the gnolls, cursing their decision to come into this unholy place.

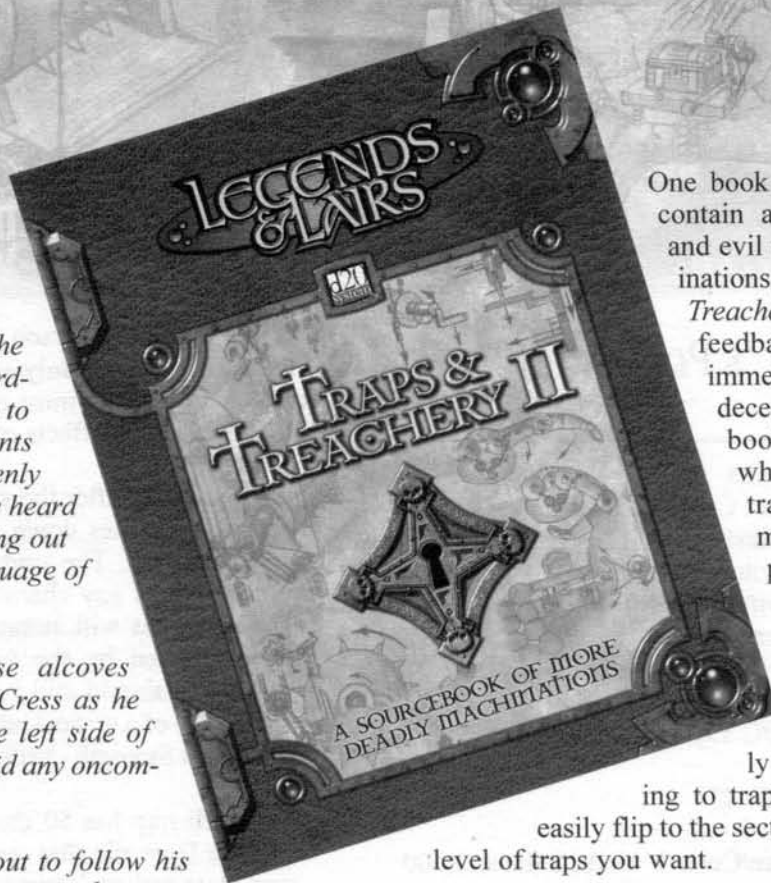

One book couldn't hope to contain all of the twisted and evil traps in our imaginations, hence *Traps & Treachery II*. We took the feedback from its immensely popular predecessor and created a book with more of what you loved: traps, traps, and more traps. Oh, and poisons. Got to have the poisons.

It's also worth noting that the book is handily organized according to trap CR, so you can easily flip to the section containing the level of traps you want.

Enjoy.

All of the text in this section describing rules for and names of traps, trap categories, and game mechanics derived from the d20 System Reference Document is considered **Open Game Content**. All background text describing these is considered closed content.

TRAP ENHANCEMENTS

The following ideas are not pure traps per se; they are ways to make traps more cunning and deadly, especially for high-level parties that might trivially overcome many challenges.

INVISIBLE MECHANISMS

The mechanics of a trap can be made *invisible*. This can be done by a 3rd-level mage with access to Craft Magic Trap and the *invisible object* spell from *Traps & Treachery*. The cost is 500 gp over and above any other costs for the trap. The effect is to make the trap much harder to detect, adding +5 to the DC of detecting the trap, and even then, the DM must rule there is some method of sensing or inferring that the trap is there. This enhancement is used primarily on locks, but is also useful anywhere a rogue visually inspects a mechanism for signs of a trap. Even if the trap is detected, Disable Device check DCs are also increased by 5, simply because it is harder to work on what you cannot see.

This adds +2 to the CR of the trap.

SUGGESTION GEMS

A *suggestion gem* is created via the Craft Magic Trap feat, requiring a 5th-level caster with the ability to cast *suggestion*, 2,500 gp, and 100 XP. The gem is then integrated into an area near a trap, usually as part of a wall decoration or a mosaic on the ceiling. The *suggestion* made is invariably some action that will trigger the trap, causing invaders or thieves to pull random levers, place their hands into alcoves, look through peepholes, hastily grab the idol from the pedestal, and otherwise act without caution.

Once removed from its location, the magic of a *suggestion gem* is broken, although it is still a high-quality gem (usually worth 500 gp or more).

This adds +2 to the CR of the trap.

ILLUSION DISGUISE

A relatively simple figment can be placed over the internal workings of a trap, making it seem to be a completely different trap and otherwise making it much harder to disable. In addition, illusions can be used to cover up joined stonework, hide pressure plates, conceal the space in the ceiling in which a deadfall is hidden, and so on. A mage with access to Craft Magic Trap and *silent image* can enhance a physical trap with an illusion for a cost of 500 gp and 20 XP. These illusions can have a range of effects, but the most common are:

Disguise the mechanism. This adds 5 to the Disable Device DC, unless the character makes a successful Will save (DC 15).

Disguise the trap. This adds 10 to the Search check to notice the trap, unless the character succeeds at a Will save (DC 15).

This adds +1 to the CR of the trap.

SPRING LOADED

Some trap mechanisms are designed to work exceptionally fast, so fast that even a skilled rogue might find himself taken by surprise. A spring-loaded trap is usually placed on a chest or a door lock, and the primary effect is to negate all or part of a rogue's enhanced resistance to traps. For 2,000 gp, the trap negates the rogue's evasion ability. For 500 gp per point of negated bonus, the trap negates one point of the rogue's uncanny dodge save bonus against traps. (In other words, for 500 gp, the uncanny dodge bonus is reduced by one, 1,000 gp buys a two point reduction, and so on.) The bonus can never be reduced below 0.

This adds +1 to the CR of the trap.

FALSE DISABLING

It is a fact known to every trapmaker that, sooner or later, someone will try to disable his creation. Some focus solely on making better traps, while others try more devious tricks. This is an example of the latter. A False Disabling trap is designed to appear trivial to disable—an obvious wire must be cut, an obvious piece of metal must be bent back. Unfortunately, this action will not disable the trap, but will trigger it. The true DC of disabling the trap is unchanged, but it appears to be a much



simpler mechanism than it really is, thus encouraging rogues to make a try at a task they might not be prepared for, take fewer precautions, etc. Any failure will trigger the trap. A Spot check (DC 25) is allowed just before the disable attempt to reveal the subterfuge.

This adds +1 to the CR of the trap.

FALSE TRAPS

False traps are slightly less lethal than normal traps but far more frustrating. The main purpose of such traps is to confuse or slow a party of invaders while keeping the cost of building traps considerably lower than normal. For 100 gp, a skilled craftsman can create the appearance of hairline seams in a wall, construct an elaborate but meaningless mechanism in a lock, or set stones in a pathway so that they appear to be trigger plates. It requires a successful Spot check (DC 20) to identify a false trap for what it is. Any Disable Device checks automatically fail, but with each attempt the character gains a new Spot check to note the deception.

One particularly fun false trap, called False

Hollow, requires Craft Magic Trap, *ghost sound*, 500 gp, and 20 XP to build. Characters who tap a wall or otherwise look for hollow spaces hear the faint echo that indicates a passage lurks just beyond a seemingly solid wall. Tremendous amounts of time could be spent looking for a secret door, or just trying to break down the wall. (If more than five cubic feet of stone is removed from the wall in which a False Hollow has been placed, the spell is broken.) This false trap's primary use is to keep a party occupied, and noisy, thus attracting guards and keeping the party in one place while the guards approach.

False Traps should be considered CR 1 to 3, and the DM should consider an ad hoc XP award to any character that figures out the ruse without resorting to skill checks.

LOCKPICK DESTRUCTION

There are several locks, usually door and chest locks, which are designed with complex mechanisms whose purpose is not to damage the thief, but his tools. The nasty bit is that in order to disarm these traps you need to put your tools into them, making even the slightest error extremely annoying.

Two common variants are the acid trap and the locking trap.

The acid trap usually has interior components made of ceramic and glass, or else the metal components are alchemically treated to resist acid. On any failed Open Lock or Disable Device check, the acid pours over the picks, destroying them unless the rogue succeeds at a Reflex save (DC 25) to yank them back. The rogue's bonus to Reflex saves due to uncanny dodge applies to this check.

The locking trap uses a set of gears and springs to clamp down on any picks or probes that have entered the lock. The picks are then held in the lock. Removing them without breaking them is difficult, requiring a successful Disable Device check (DC 25). Failure means that the tools are broken and the lock has been jammed or damaged, causing additional Open Lock checks to suffer a -4 penalty.

Locks with these mechanisms are considered CR 1.

NEW TRAPS

MEAL SPEARS

Trap Type: Spear Trap
Construction Type: Complex mechanical
Activation Type: Instant
Trigger: Local; pressure plate
Mechanism: Pressure, gear
Effect: Injury
Attack Bonus: +6 ranged
Damage: 1d8
Save: None
Search DC: 21
Disable Device DC: 21
Challenge Rating: 1
Construction Time/Cost: 1 week; 1,000 gp

Meal Spears is a mechanical trap designed to injure the unwary, who may be preoccupied with the room's other element.

The room that contains Meal Spears is a small dining hall, 40 ft. wide and 60 ft. long. A rectangular table surrounded by six short-backed chairs rests in the center of the room. A skeleton sits in the chair nearest to the door the PC's enter through, its skull resting on the table before it. A dagger lies next to the skeleton's head.

Ghostlike images inhabit the room, and they seem to be having a meal. When the characters enter, one of the ghosts, a woman, slowly walks behind the ghost of a man in the position of the skeleton, pulls a knife and sinks it into his back. The other dinner guests rise in shock and horror, and then the image fades out and repeats.

This illusionary dinner is meant to distract the PCs from the waiting trap. Underneath the skeleton's chair is a cleverly disguised pressure plate (Search check DC 21). When any additional weight is put on this large plate (for example, to examine the skeleton or grab the dagger) the trap is sprung. Several shortspears fire from holes in the walls opposite the dead skeleton. Anyone within 10 feet of the skeleton suffers 1d3 spear attacks. The spears have a ranged attack bonus of +6.

Disabling the trap can be accomplished in two ways, either by jamming the pressure plate or

noticing (Spot check DC 18) and plugging the holes from which the spears are fired.

ROOM OF CUNNING OBSERVATION

Trap Type: Magical Detection Trap
Construction Type: Magic
Activation Type: Instant
Trigger: Local; magic
Mechanism: Magic
Effect: Identification
Attack Bonus: No attack roll necessary
Damage: None
Save: None
Search DC: 26
Disable Device DC: 26
Challenge Rating: 1
Construction Time/Cost: 3 days; 2,500 gp; 250 XP

The Room of Cunning Observation is somewhat unique in that characters may very well walk into it, suffer the full effect of the trap, and yet never be aware they have been in a trap at all! The room is usually large, at least 30 ft. long, and placed along a main route through the dungeon. The only exit from the room is a heavy door (Break DC 26) along with a very well made masterwork lock. The function of the lock and the door is to keep the party busy for at least a few minutes. Meanwhile, the trap does its work.

Inlays of semi-precious gems all around the room's walls serve as both decoration and concealment. A small number of these gems are part of a magical scanning system that casts *detect magic* on the party and then relays the results (as well as an image of the party) to a watcher via *clairvoyance*. The watcher thus knows who has the most powerful magic, and has some sense of what those items might be. He also has a chance to listen to any conversation that occurs in the room, which might provide more clues as to the nature of the party members.

Then, armed with this knowledge, dungeon denizens are dispatched to encounter the party later, utilizing their knowledge to the fullest. If someone has a *flaming burst* weapon, for example, they may have prepared with *potions of resist elements (fire)*. Many similar stratagems are possible.

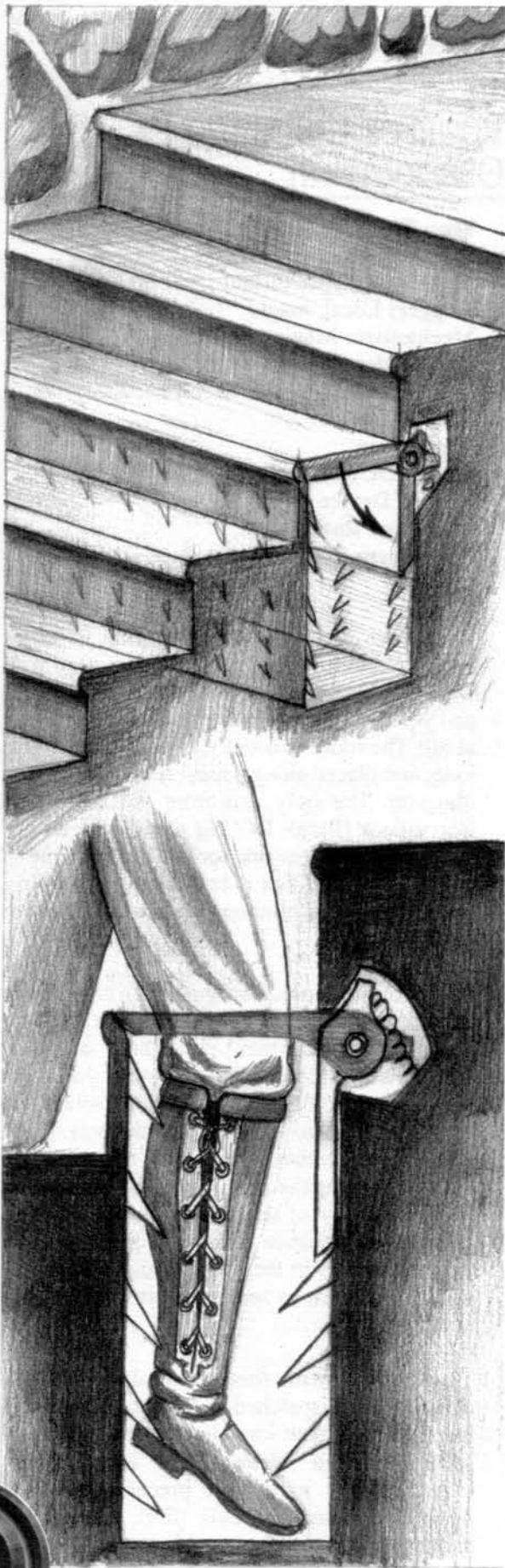

The fact that there is even a trap to detect is somewhat difficult to ascertain. A rogue with a level or two of wizard or one or more ranks in Knowledge (arcana) might notice an odd pattern in the gems, or might feel a faint magical stirring in the room. A successful Scry check (DC 15) allows a character to notice that he is being magically scanned, but he cannot discern the nature of the effect. Disabling the trap is a matter of smashing the appropriate gems in order to disturb the matrix. Of course, during each round that this is going on, the trap still functions.

The Grove of Woodland Insight is a similar concept, but placed, as the name implies, in a woodland grove. The gems are hidden carefully among the trees and the watcher is usually stationed nearby. This setup is popular among elves, fey, and other woodland races, but evil humanoid races sometimes produce wizards or sorcerers, and they can build this spy station as well. Since a grove cannot delay a party the way a locked room can, this trap is usually built in a place ideally suited for a quick rest stop. In the case of benign races, an emissary may be sent out to meet the party in the grove and keep them engaged long enough for the scan to be completed.

LEG SHREDDER

Trap Type: Barbed Leg Trap
Construction Type: Simple mechanical
Activation Type: Instant
Trigger: Local; trapdoor
Mechanism: Gravity
Effect: Ensnarement, injury
Attack Bonus: No attack roll necessary
Damage: 1d6
Save: Reflex save (DC 20) avoids
Search DC: 20
Disable Device DC: 20
Challenge Rating: 2
Construction Time/Cost: 2 weeks; 2,000 gp

The Leg Shredder is a trapdoor disguised as a step, which opens into a 24-inch deep compartment lined with flexible metal barbs. Generally built at the midpoint of a stone staircase, the trapdoor blends almost seamlessly among the other steps.

Creatures of small, medium or larger size that

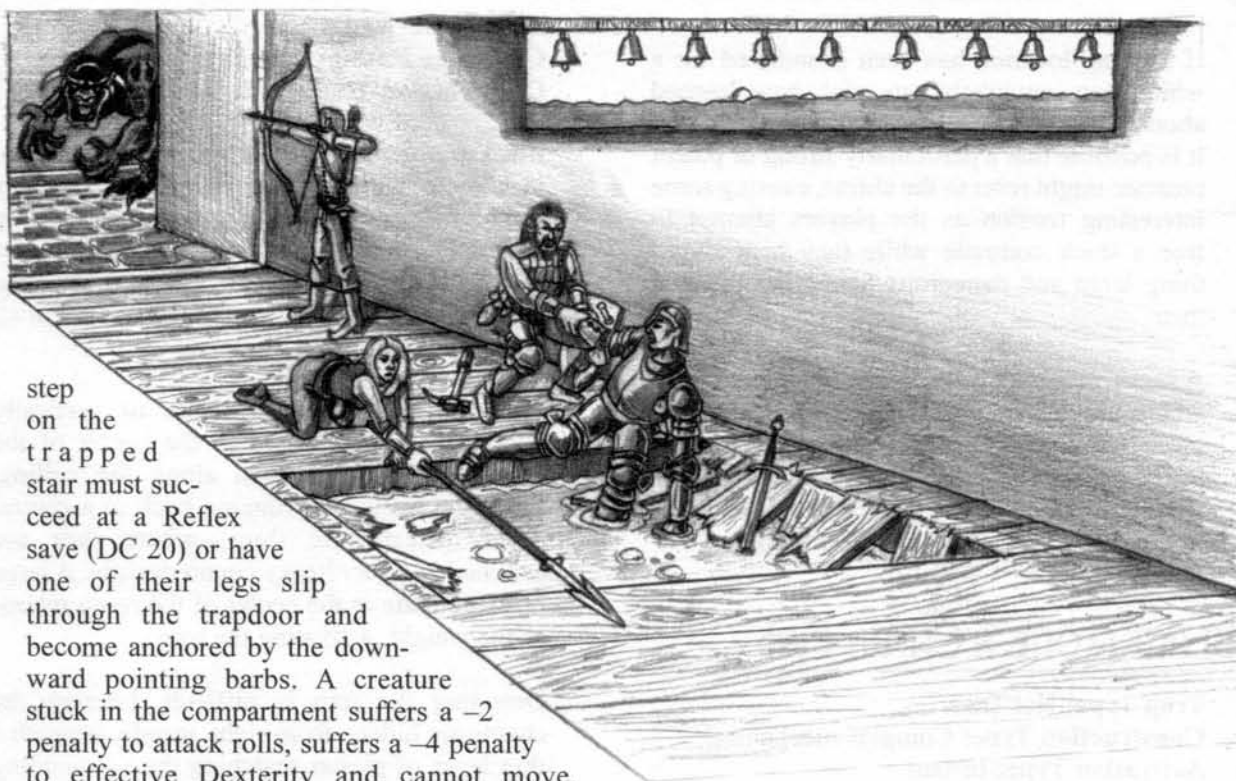

step on the trapped stair must succeed at a Reflex save (DC 20) or have one of their legs slip through the trapdoor and become anchored by the downward pointing barbs. A creature stuck in the compartment suffers a -2 penalty to attack rolls, suffers a -4 penalty to effective Dexterity and cannot move. Creatures taking a full-round action to make a Strength or Escape Artist check (DC 20) to pull free from the trap suffer an automatic 1d6 points of damage regardless of success or failure. A successful Disable Device check (DC 20) takes 1d4 rounds to complete and allows a creature to withdraw from the compartment without taking damage.

A successful Search check (DC 20) allows a creature to recognize the step as being a hidden trapdoor. If the Leg Shredder was added into an existing stairway instead of being built into the stairway as it was constructed, the Search DC is only 18 due to variations in stone color and craftsmanship. Disabling the Leg Shredder is a simple matter of jamming the trapdoor or filling the compartment beneath the step with rubble or garbage.

Sticky Situation

Trap Type: False Floor and Alchemical Glue
Construction Type: Simple mechanical
Activation Type: Instant
Trigger: Local; pressure plate
Mechanism: Gravity
Effect: Ensnarement; alarm
Attack Bonus: +12 melee
Damage: None
Save: Reflex save (DC 20) to avoid

Search DC: 20
Disable Device DC: 20
Challenge Rating: 2
Construction Time/Cost: 2 weeks; 2,000 gp

This is a very basic trap, one that is easily constructed even by technically inept beings. Since the trap is not directly lethal, it is very suitable for low-level adventurers. It consists of a fairly

small pit, perhaps a foot deep or so, dug into a section of corridor (usually a 5 ft. by 5 ft. square), and covered with a weakened layer of the same material used as flooring elsewhere in the corridor. The pit is then filled with alchemical glue very similar to that used in tanglefoot bags (PHB 114). The underside of the covering is lined with tiny bells.

When a person walks across the covering, it breaks, causing the trespasser to become stuck in the glue while the bells ring to alert nearby guards or monsters to the intruder. In some cases, this will cause guards to be summoned to deal with the interlopers; in others, wild beasts will be unleashed to run down the corridor. In some cases the guards might just line up 20 feet away from the victim and engage in a little target practice.

If the trap location has been abandoned for a while, then new inhabitants might have learned about the gluepit and set it up for their own use. It is possible that a particularly strong or potent creature might react to the chime, causing some interesting tension as the players attempt to free a stuck comrade while they hear something large and dangerous lumbering towards them.

A rogue may spot a slight discoloration or gap where the weaker floorboards join the strong ones. Small gobs of dried glue may be seen on the walls near the trap. There may be a distinctive, but faint, odor to the glue that a trained rogue can detect.

BLACKSTONE'S CHAIN FIST

Trap Type: Net Trap
Construction Type: Complex mechanical
Activation Type: Instant
Trigger: Local; switch
Mechanism: Gravity, counterweight
Effect: Ensnarement, injury
Attack Bonus: +8 melee
Damage: 2d6
Save: Special
Search DC: 21

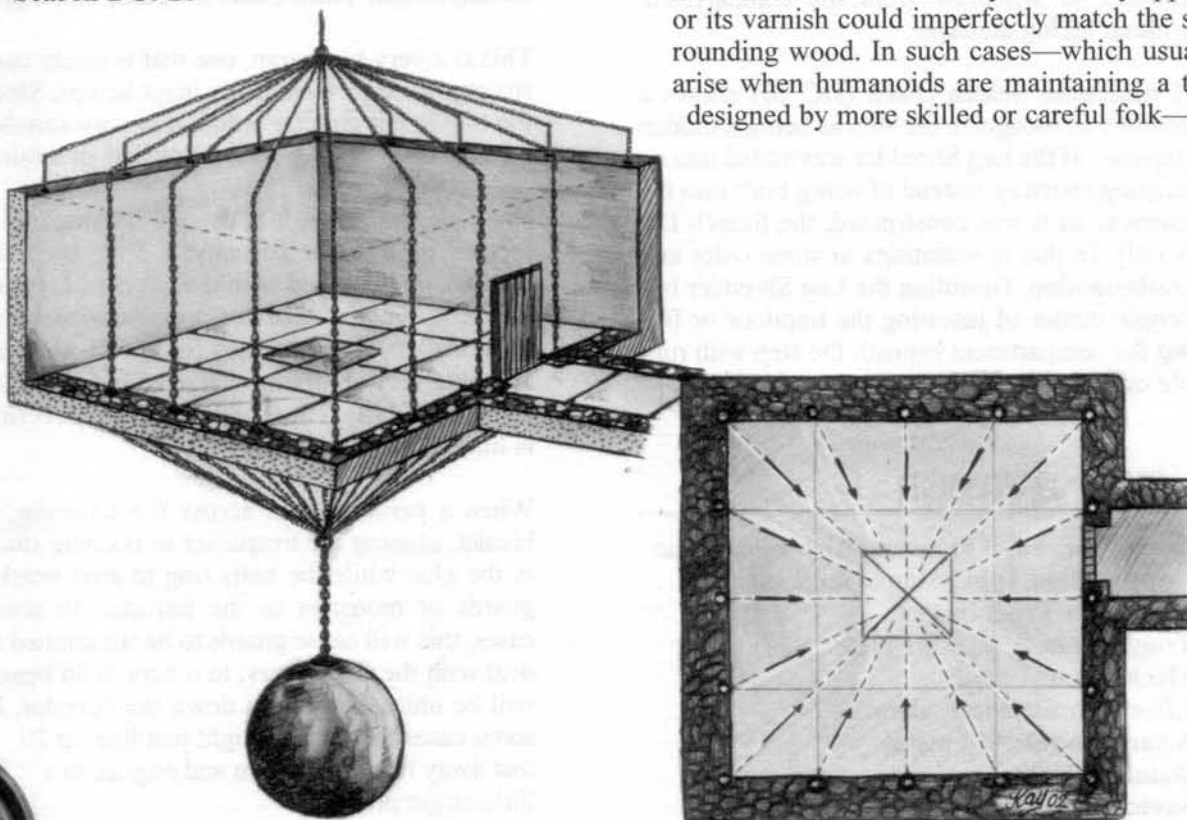

Disable Device DC: 21
Challenge Rating: 3
Construction Time/Cost: 3 weeks; 3,000 gp

Blackstone's Chain Fist is typically constructed in a room with few furnishings and roughly equal dimensions; to work properly the trap must have four walls. In the temples, palaces and mausoleums where the trap is most often deployed, such spartan anterooms are not at all uncommon.

The trap consists of a series of vertically aligned chains anchored in the center of the ceiling, fanning outward along the ceiling, down the walls, and running back to a central point beneath the floor—where they are attached to a very heavy counterweight. A large pressure plate in the center of the room releases the weight, activating the trap.

Detecting the trap is difficult, because the chains are hidden from sight, usually beneath a thin layer of plaster matching the surrounding surface or behind breakaway wood veneer. Unsprung traps are very difficult to detect, as are expertly reset traps, but clumsily reset traps may be betrayed. Poorly applied plaster may not quite match the wall's texture or coloration, revealing thin discolored lines running down the walls. Wood veneer may be crudely applied or its varnish could imperfectly match the surrounding wood. In such cases—which usually arise when humanoids are maintaining a trap designed by more skilled or careful folk—the

Search DC is reduced to 15.

The pressure plate is the most likely aspect of the trap to be detected. Disarming the trap is a matter of disabling the pressure plate.

The trap is activated when someone steps on the pressure plate, dropping the counterweight. Chains burst from the wall with great speed, gathering people (and objects) within their steely meshes, and mashing them into a painful vise of flesh at the center of the room. With a successful Reflex save (DC 20), people positioned at the outer edges of the trap can escape its clutches by twisting through the chains as they fly past, because the gaps between the chains average seven to 10 inches in width. Those standing just within an opening to the room escape with a successful Reflex save (DC 15). The unfortunate people standing within 10 ft. of the trigger do not receive a saving throw; by the time the chains reach them, there are only four-inch gaps between them.

The counterweight exerts considerable pressure on those caught within the trap—the damage inflicted is due to constriction within the stout chains. Additional damage might result from self-inflicted wounds; those who fail to drop sharp weapons or lanterns as the chains sweep them up may find cause to regret it. There is a 50% chance that any piercing or slashing weapon deals its damage to a random trapped character on the round after the trap is sprung.

If allies remain at large, escaping Blackstone's Chain Fist is a matter of snapping a few chain links with a small pry bar or saw (readily available in any thieves' kit), or of detaching the chains from the anchor in the ceiling by loosening the now-exposed bolts. Escaping from within the trap is a bit more difficult. Movement is severely restricted, and getting at tools or weapons might well be impossible. The Chain Fist is a Large net with a Strength bonus of +2, so the trap's Grapple DC is +14.

Variations: More deadly versions of this trap may be created by placing items in the room that will inflict damage on anyone who is caught in the chain vice along with them. Possibilities include heavy iron spheres, large spiked caltrops and terra cotta bottles of deadly acid. Such additions do make the presence of a trap a good deal more obvious.

IMPALING TREE

Trap Type: Impaling Defense Trap
Construction Type: Magic
Activation Type: Instant
Trigger: Local; magic
Mechanism: Magic
Effect: Injury
Attack Bonus: +8 melee
Damage: 4d6
Save: Reflex save (DC 17) partial
Search DC: 28
Disable Device DC: 28
Challenge Rating: 3
Construction Time/Cost: 1 week; 2,500 gp; 100 XP

This trap is usually worked into the trunks of trees that hold elven scouts or lookout posts. Such trees are found scattered throughout most forests with a large elven population, and can be identified by the keen-eyed by the small platforms built into the upper layers. Such platforms often hold supplies and ammunition, so they are ideal targets for bandits.

Unfortunately for those who would rob the elves, even an abandoned tree is not unprotected. A fairly simple ritual creates an Impaling Tree. Anyone climbing it without first speaking a safeword finds the tree sprouting long, lethal spikes from the trunk and branches. A Reflex save halves the damage, but the sudden shock can cause even a skilled climber to fall. A Climb check (DC 28) is required to avoid plunging from the tree. The spell usually does not activate until a climber is at least twenty feet up, so the fall often finishes what the spikes began.

Should a climber survive the spikes and retain their grip, there is a slight boon. The now-spiky tree is much easier to climb, reducing the Climb check DC for the remainder of the ascent by 5.

Possible means of detecting this trap include noticing odd lines carved very subtly in the trunk of the tree, flowing along the lines of bark but glistening with eldritch power. There may be odd distortions in the bark where the spikes had previously erupted, or a character might notice a corpse riddled through with what at first seem to be arrow wounds, but which on closer examination were clearly made by something else.

Disarming the trap can be accomplished by making careful incisions in the bark in order to disrupt the spell.

CHOKEHALL

Trap Type: Poison Gas Trap
Construction Type: Complex mechanical
Activation Type: Extended
Trigger: Remote; switch
Mechanism: Spring
Effect: Injury, hindrance
Attack Bonus: No attack roll necessary
Damage: Poison
Save: Fortitude save (DC 12) resists
Search DC: 22
Disable Device DC: 35
Challenge Rating: 5
Construction Time/Cost: 5 weeks; 5,000 gp

A sophisticated and difficult trap to beat, a Chokehall is designed to trap and possibly kill intruders between two lockable doors.

Entering the hall without unlocking both doors simultaneously triggers the initial phase of the trap. Thus, it normally takes two guards to allow safe passage through the hall, a very effective security measure. The initial phase of the trap involves a mechanism that bolts the unopened door shut. The open door shuts two rounds later, and it too is bolted. Both doors remain locked until keys are operated on the outside of both doors simultaneously. If this is done, the trap is disarmed and it begins to reset immediately, ultimately unbolting the doors.

Once the doors both bolt shut, valves near the floor of the corridor open, filling the space with pooling breather poison. The space fills one foot per round, until the eight-foot-tall ceiling is reached. The trap waits 10 minutes before pumping the gas back into the reservoirs. The doors then unbolt but remain locked.

A simple speakhorn allows guards on either side of the chokehall to communicate and coordinate their activities, though this also allows those using *gaseous form* or similar magic to bypass the hall.

There are several clues as to the nature of the trap. The first is revealed upon opening one of the external locks. In the process of opening it, the rogue may note a mechanism that has another purpose that is not immediately obvious. Another clue, once the rogue has the first door open, is the bolts in the floor and ceiling. The metal square ends of these are flush, but

any rogue that detects them should certainly be suspicious. Additionally, the hall may have the remains of previous victims, depending on how often the area is cleaned. If the first door is wedged or kept open, the keyhole on the opposite side can be accessed. A successful examination (Search check DC 23) reveals it to have no actual function.



The speakhorn, the small vents along the walls, and the revelation that the doors are airtight should give a rogue all that he needs to figure out the nature of the trap. There is no trace of water or odors, which may actually give an alchemist an indication of the gas used.

Disabling the trap is rather easy, in one sense. The initial door can be wedged open, thus disarming the trap. However, opening the other door, now bolted, requires a successful Strength check (DC 35). Otherwise the characters must hack their way through it, which may be difficult depending on the material used. Additionally, carefully plugging all the vents disables the trap. This has the advantage that, once employed, the trap can cycle, allowing the party to simply use the far door as normal since it is now neither locked nor barred.

The reservoirs require basic maintenance,

though judicious alchemy or magic can give the mechanism a long life. The trigger and reset mechanism are powered by counterweights, which must be wound back up through physical or magical means. The trap also works well if a few undead are placed in the hall, providing a useful distraction for those trapped within the hall. While the party can try to keep the door open while fighting, they may forget to do so once proceeding. A DM should indicate early on that the door has a tendency to swing shut when left on its own.

MISDIRECTED MECHANISM

Trap Type: Fire Trap
Construction Type: Magic
Activation Type: Instant
Trigger: Magic
Mechanism: Magic
Effect: Injury
Attack Bonus: No attack roll necessary
Damage: 2d6+9
Save: None
Search DC: 30
Disable Device DC: 25 (see below)
Challenge Rating: 5
Construction Time/Cost: 1 week; 9,000 gp; 360 XP

This trap appears to be a featureless door, with no handles or hinges obvious in its construction. Sixteen metal levers, numbered 1–16 in four rows, cover the wall beside it. Each has three marked settings. The first and last rows are all in the up position, and the middle two rows are in the down position. Inscribed above the levers is the phrase *'I and myself and myself make four, but nothing is five and six.'*

Anyone reaching for a lever takes 2d6+9 points of fire damage. If a lever is actually grasped, the character doing so takes a further 1d6 points of fire damage.

There is a permanent *wall of fire* with a permanent *invisibility* on it just in front of the levers. The heat side is aimed toward the levers on the wall. Anyone reaching for the levers must pass their arm through the fire. Furthermore, the levers are quite hot, causing additional damage if grasped.

The misdirection is that none of the levers actually do anything. They can be moved into various positions and will make a variety of click-

ing sounds. The phrase scrawled on the wall above them is meaningless.

The door has a *permanent image* placed upon it, hiding a recessed handle two feet to the right at a height of five feet. With a little bit of strength (Strength check DC 15), the door can be swung out into the room and passed through with no further trouble.

The wall and the door both detect as magical. Hitting the area with a *dispel magic* might dispel any or all of the effects present. The DC for such a check is 23.

A Disable Device check (DC 25), if successful, confirms the boundaries of the *wall of fire*, and that there is no triggering mechanism. It is a stationary, fixed effect and not a mechanism. This is a clue to what is going on.

This trap works well in protected interiors of organizations, like mage guilds. It is relatively expensive, but it is long lasting and has proven to be a useful method of keeping out even fairly strong groups. The Misdirected Mechanism works best if placed after a variety of lever-activated mechanisms, some trapped but most not. It is also suggested that traps with phrases be established as a test to be allowed to enter, either religious or intellectual. In this case, the test measures the party's lateral thinking capability.

GIANT SUCKING SOUND

Trap Type: Vacuum and Blades
Construction Type: Complex mechanical
Activation Type: Instant
Trigger: Local; pressure plate
Mechanism: Vacuum, spring
Effect: Movement, injury
Attack Bonus: +14 melee
Damage: 6d6
Save: None
Search DC: 24
Disable Device DC: 24
Challenge Rating: 6
Construction Time/Cost: 6 weeks; 6,000 gp

Gnomes are merry pranksters whose cunning may embarrass, but very rarely kills. While gnomes who dwell near civilized regions are seen as mostly harmless, gnomes who live in the deeper parts of the world, where their survival is earned by daily struggle, are



known to turn their keen minds more toward survival than games. Nothing demonstrates this better than this trap, which kills in a manner that is both inefficient and very unpleasant. This trap is difficult for non-gnomes to construct, but those who have conquered a gnomish realm may find it possible to at least keep the trap maintained and functioning.

A standard floor trigger initially sets off the trap. This activates a massive vacuum pump, which draws the person standing on the trigger upwards into a winding shaft. The same mechanism that drives the pump also drives a large rotating fan blade, which is mounted at the end of the shaft. The victim is pulled onto the blade, which proceeds to slice and dice, with the resulting mess being dumped into a feeding pit. The animals in the pit are usually of a type used as guard or hunting beasts. The trap is not their main source of sustenance, just the occasional tasty treat.

Anyone dumped onto the blades takes 6d6 points of damage before being dumped into the room beyond. The fan mechanism is fairly complex, and if the victim can deal 25 points of damage to it with a suitable weapon, it can be stopped. Unfortunately, dealing 30 or more points of damage also drops the blade and pump mechanism down into the room below, where the beasts therein lunge to the attack.

The trap can only grab one victim at a time, and after it spits the victim into the room beyond it takes it one round to get back to speed. So, there is a two round gap after the trap has claimed its first victim in which characters can traverse the shaft and sabotage the trap. All checks made on the second round, however, are made with a -2 circumstance penalty due to the suction created by the blades. On the third round and each round beyond, a Reflex save (DC 16) must be made to avoid being pulled into the blades.

Detecting this trap usually involves noticing the pressure switch located under the suspicious hole in the ceiling. Gnomes often disguise this with an illusion, however. Disarming the trap consists of disabling the trigger mechanism, but, once the trap has been activated, disarming the trigger does no good. Anyone not caught in the fan can attempt to disable the fan mechanism itself, but they suffer the dangers and penalties described above.

DISARMED AND DANGEROUS

Trap Type: Weapon Trap
Construction Type: Magic
Activation Type: Instant
Trigger: Local; magic
Mechanism: Magic
Effect: Injury
Attack Bonus: +8 melee
Damage: See below
Save: Will save (DC 17) resists
Search DC: 30
Disable Device DC: 30
Challenge Rating: 7
Construction Time/Cost: 1 week; 4,500 gp; 180 XP

This trap is usually set in a large, high-ceilinged room, though it does not need to be. The room is almost always empty, but placed at a crucial juncture. The spell is triggered when someone passes the centerpoint of the room, and it covers the entire area so all within the room when the spell is triggered are targeted. Whichever weapons or items are currently readied (held in the hand) are grabbed away by a variant *telekinesis* spell. Essentially the spell makes a Strength check against the character wielding the weapon or item it is trying to grab. The trap is considered to have a Strength of 18 for purposes of this check. If the trap wins this check, the weapon is yanked from the hand of the character and it immediately begins to attack him with an attack bonus of +8.

Any magical bonuses the weapon might have apply, but any special features of the weapon that do not automatically activate (in other words, which require a command phrase) are not used. Other weapon properties, such as flaming, shocking burst, and so on, do work. If the weapon is a



double weapon, the trap wields it as if it had the Ambidexterity and Two Weapon Fighting feats. Otherwise the trap only makes a single attack per round.

The spell effect lasts for nine rounds. During this time the weapons may be attacked as normal, but most characters will be hesitant to destroy their own weapons. The weapons do not leave the room to pursue the characters, but if the room is vacated and re-entered, the trap resets itself, and the weapons rise to the attack when the characters enter.

Intelligent weapons can make a Will save (DC 17) to resist being wielded against their bearer.

This trap is an interesting way to force characters to rely on secondary weapons, as their favorite weapons will be wielded against them for a short period of time.

DROWNING MAIDEN

Trap Type: Ensnaring Water Trap
Construction Type: Magic
Activation Type: Extended
Trigger: Magic
Mechanism: Magic
Effect: Ensnarement, injury
Attack Bonus: No attack roll necessary
Damage: Drowning

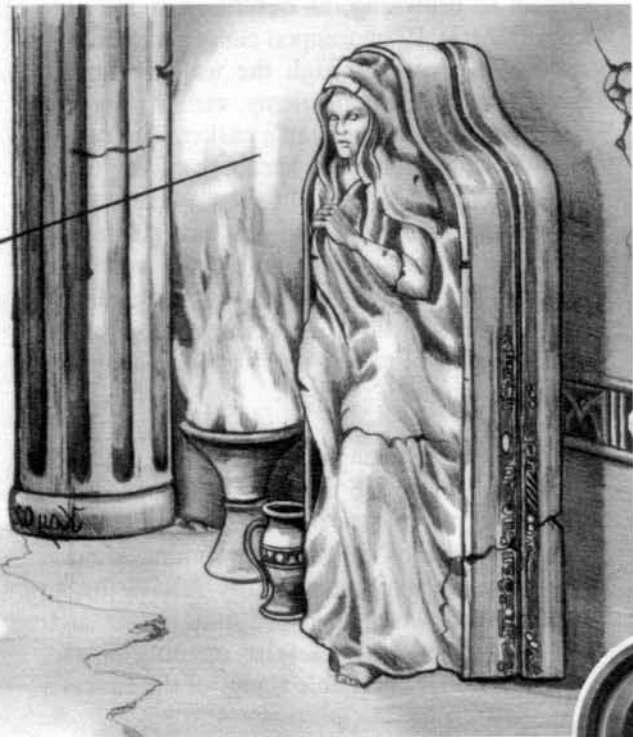

Save: Will save (DC 19) to resist
Search DC: 33
Disable Device DC: 33
Challenge Rating: 8
Construction Time/Cost: 1 day; 650 gp; 26 XP

The Drowning Maiden is a trap that combines a magic trigger and a sturdy, water-filled statue to punish the curious or greedy.

Typically placed in a hall or mausoleum filled with stone sarcophagi, the Drowning Maiden appears as a 6-foot-tall, ornate stone sarcophagi. The stonework is finely crafted, and is carved to resemble the visage of a beautiful young woman in flowing robes, her face smiling peacefully. This woman is different for every creator, as some use images of past lovers, family members, or perhaps the creator's idea of the perfect female. Many creators place treasures in nearby caskets to lure victims to the Drowning Maiden more easily by exploiting a character's greed.

Any character who touches the maiden must make a successful Will save (DC 19) or be instantly *teleported without error* to the inside of the maiden's casket. Unfortunately for the trapped character, the Drowning Maiden's casket design does not allow it to be opened as would a normal casket.

A character that is *teleported* into the maiden is subject to drowning, as described in the core rules (DMG). If the trapped character is able to breathe in water through the use of pre-cast spells, abilities, magic items, etc., she is still trapped within the maiden's casket. The casket is considered to have a hardness of 8, 90 hp, and a break DC of 35. Popular variations on this trap include the use of iron caskets instead of stone, poisons mixed within the water, or caskets filled with other suffocating materials (such as sand or dirt). There are rumors of the mad trapsmith Perivax placing ooze creatures within the maiden's casket.

Due to this trap's magical trigger, it is unusually difficult to notice at a casual glance. Also, because of the nature of the trap, rogues who carefully move closer to the Drowning Maiden to investigate may accidentally fall victim to the trap themselves. A rogue may notice such clues as the maiden's false opening crease, the fact that no visible traces of the casket's

ability to open are present, or a slight condensation on parts of the casket. Apart from dispelling the trap's magic, the only method for disarming this trap is to simply avoid it.

UNHINGED WALL

Trap Type: Siege Wall Trap
Construction Type: Complex mechanical
Activation Type: Instant
Trigger: Remote; switch
Mechanism: Gravity
Effect: Injury, hindrance
Attack Bonus: +10 melee
Damage: 18d6
Save: Reflex save (DC 25) avoids
Search DC: 25
Disable Device DC: 22
Challenge Rating: 10
Construction Time/Cost: 10 weeks; 10,000 gp

The Unhinged Wall is a siege trap on a tremendous scale, some versions are as long as 60 feet and as tall as 30 feet, designed to be used by a city's defenders when invaders are scaling its walls. Unlike most traps, the Unhinged Wall is intended to injure or kill dozens or even hundreds of victims at a time rather than individuals or small groups.

The principle behind the trap is simple. A huge and heavy iron lattice, with an outer surface covered in stonework to match the surrounding wall, fits flush over the upper reaches of a city or castle wall. It is anchored at the top of the wall by a series of linchpins and at the bottom by thick hidden hinges. When the linchpins are removed, the ponderous iron lattice drops down like a drawbridge to strike against the wall below it, crushing dozens of soldiers to a pulp and smashing nearby siege towers and ladders to splinters.

With a successful Reflex save (DC 25) a character can escape the Unhinged Wall by leaping to the ground. Doing so will likely inflict some falling damage, but that is almost always preferable to the punishment the trap deals out. Attackers have been known to make provisions for the trap by wheeling carts heaped with stone into the drop path of the lattice, or by building siege devices designed to counteract it. One such device is a cart with logs mounted at a 45-degree angle positioned to catch the lat-

tice on the way down. In such cases, victims may take half damage or no damage at all.

Unlike most traps, city defenders activate the Unhinged Wall rather than a mechanical or magical trigger. It cannot be disabled from outside the walls. The simplest method of disarming it is to infiltrate the upper walls and trigger it prematurely, when one's allies are not on the wall and at risk. When secrecy is required, attacking its two weak points, the linchpins and the hinges, can do the trick. These are only accessible from within the inner wall and are usually heavily guarded. Disarming the linchpins involves finding some way of anchoring them in the wall. The hinges, of course, must be likewise rendered inoperable.

Detecting the presence of an Unhinged Wall is difficult because there are few telltale signs to give it away. Adept observers may note that the upper wall in this area is slightly thicker than at other points along the wall, or that the gaps between certain stones are a bit wider than usual in some segments.

Cities and castles take some pains to keep the presence of an Unhinged Wall secret to preserve an element of surprise, though this is difficult to manage since it must be installed in full view of everyone. Secrecy is best achieved by installing the trap while the walls are being built. Then it can be swathed in scaffolding and hanging sheets, and the trap is rare enough that it is difficult to identify it merely by viewing its finished design. Obviously, those living near a suitably ancient Unhinged Wall may be unaware of its existence. This is especially true in city ruins, where rusty linchpins can cause an abandoned trap to collapse on unwary explorers.

SWINGING PLATFORMS

In this challenge, four circular platforms suspended over a chasm (which could be filled with water, lava, or just be a dead drop) present the characters their only option for crossing to the passageway beyond. Each platform is only 5 ft. in diameter, meaning that jumping from one to the other is beyond the ability of most characters since they cannot take running jumps (except from the original ledge to the first platform). The trick is that one character must jump to the first platform and start it

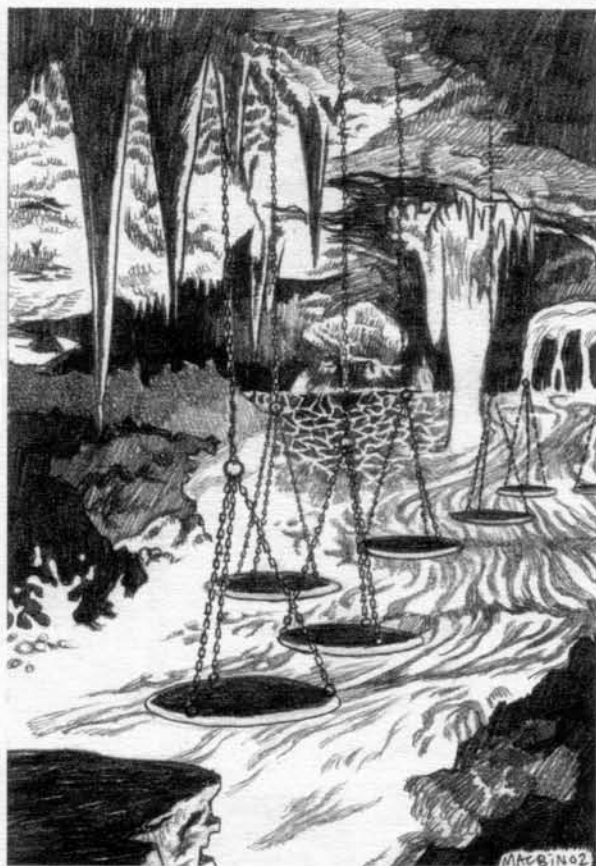

swinging; each is suspended by a chain long enough to allow it to swing near the next disk.

Starting a disk swinging requires an initial Strength check (DC 15), followed by two more successful Strength checks (DC 15) to swing the disk far enough in either direction. Once the disks are swinging, a Strength check (DC 10) is enough to keep them swinging for an additional two rounds. An unattended disk swings for a minute before settling back to its resting position. Jumping from a swinging disk to a still disk requires a Jump or Tumble check (DC 10). Failure indicates the character takes 1d6 points of subdual damage for falling, failure by 5 or more indicates that the character has slipped off the disk and into whatever awaits him below. Jumping onto a swinging platform, whether from stable ground or another swinging disk, is a bit more difficult, requiring a Jump or Tumble check (DC 15) to perform. Characters still take damage for failing the check, but can still make it onto the disk unless they fail by 5 or more, in which case they fall to the dangers below.

LEGENDS & LAIRS™

Essential



Traps & Treachery (DD17 \$24.95): The definitive resource for traps, tricks, puzzles, and poisons. This 176-page hardcover volume includes more than 60 detailed magic and mechanical traps, puzzles, challenges, and poisons.

Mythic Races (DD18 \$24.95): The essential resource for new character races and racial prestige classes. This beautifully illustrated sourcebook presents more than two dozen fully detailed and original races.



Seafarer's Handbook (DD27 \$24.95): A complete compendium of seafaring lore for aquatic campaigns and fantasy adventure on the high seas. This hardcover is packed full of new feats, skills, classes, races, spells, and magic items,

as well as rules for underwater combat, ship design, and ship-to-ship combat.

Spells & Spellcraft (DD28 \$24.95): This



essential hardcover volume presents more than 100 new spells, rules for construct design and familiars, rituals and ceremonies, and new magical traditions.

Traps & Treachery II

(DD29 \$24.95): The sequel to the bestselling and critically acclaimed Traps & Treachery, this hardcover presents more than 150 new magic and mechanical traps, new poison rules, new rules for upgrading and enhancing traps, and new puzzles and challenges.



Draconic Lore (DD33 \$14.95): This 64-page softcover is a compendium of awesome and terrifying dragons of sky, land, and sea. It presents more than 30 new species of dragons with which to torment and delight your players.

Path of Shadow (DD34 \$24.95): This character resource for rogues presents more than 30 new prestige classes and legendary classes of interest to rogue characters. This 176-page hardcover volume also offers new feats, equipment, weapons, and magic items, as well as shadow schools and roguish organizations.



Path of the Sword (DD30 \$24.95): This character resource for barbarians, fighters, monks, and rangers presents new feats, prestige classes, alternate core classes, and schools of combat for characters devoted to the fighting arts. The book also

introduces legendary classes, truly unique options for high-level characters.

Path of Magic (DD31 \$24.95): This character resource for bards, sorcerers, and wizards presents new feats, prestige classes, legendary classes, and magical traditions for characters devoted to the arcane arts. The book also offers new rules for bardic performances, arcane organizations, eldritch staves, and other unique magic items.



Necromantic Lore (DD35 \$14.95): This is a compendium of horrifying new undead from your darkest nightmares. It presents more than 30 new undead creatures that will haunt your players for weeks to come.

Path of Faith (DD36 \$24.95): This hardcover presents a host of new and exciting options for clerics, druids, and paladins, including new class abilities, ecclesiastical organizations, new feats, prestige classes, legendary classes, and rules for paladin mounts, holy symbols, cults, and much more.



Dungeoncraft (DD37 \$24.95): This hardcover volume contains complete rules for designing dungeons, from determining the dungeon's layout and denizens to exciting new dungeon templates that can recreate everything from the tunnels beneath a volcano to the cracks beneath a glacier.



Monster's Handbook (DD32 \$24.95): This resource for customizing and creating new monsters provides more than 60 new monster feats, new monster prestige classes, new special attacks, qualities, and traits, dozens of new monster templates, and rules for making the monsters in your campaign even more challenging.

THE ULTIMATE GAMING LIBRARY

SUBSCRIBE NOW
AND SAVE UP TO
\$73.00 OFF THE COVER
PRICE!



BUILD THE GAME YOU WANT WITH
DRAGON® AND DUNGEON®/POLYHEFRON®

- Rules, ideas, and advice from *DRAGON*.
- Exclusive official adventures from *DUNGEON*.
- Innovative Mini-Games from *POLYHEDRON*.

ORDER ONLINE NOW!

www.paizo.com

Call: 1-800-395-7760 • Email: dragon@pcspublink.com

paizo
PUBLISHING

OPEN GAME LICENSE Version 1.0a

The following text is the property of Wizards of the Coast, Inc. and is Copyright 2000 Wizards of the Coast, Inc ("Wizards"). All Rights Reserved.

1. Definitions: (a) "Contributors" means the copyright and/or trademark owners who have contributed Open Game Content; (b) "Derivative Material" means copyrighted material including derivative works and translations (including into other computer languages), potation, modification, correction, addition, extension, upgrade, improvement, compilation, abridgment or other form in which an existing work may be recast, transformed or adapted; (c) "Distribute" means to reproduce, license, rent, lease, sell, broadcast, publicly display, transmit or otherwise distribute; (d) "Open Game Content" means the game mechanic and includes the methods, procedures, processes and routines to the extent such content does not embody the Product Identity and is an enhancement over the prior art and any additional content clearly identified as Open Game Content by the Contributor, and means any work covered by this License, including translations and derivative works under copyright law, but specifically excludes Product Identity. (e) "Product Identity" means product and product line names, logos and identifying marks including trade dress; artifacts; creatures characters; stories, storylines, plots, thematic elements, dialogue, incidents, language, artwork, symbols, designs, depictions, likenesses, formats, poses, concepts, themes and graphic, photographic and other visual or audio representations; names and descriptions of characters, spells, enchantments, personalities, teams, personas, likenesses and special abilities; places, locations, environments, creatures, equipment, magical or supernatural abilities or effects, logos, symbols, or graphic designs; and any other trademark or registered trademark clearly identified as Product Identity by the owner of the Product Identity, and which specifically excludes the Open Game Content; (f) "Trademark" means the logos, names, mark, sign, motto, designs that are used by a Contributor to identify itself or its products or the associated products contributed to the Open Game License by the Contributor (g) "Use", "Used" or "Using" means to use, Distribute, copy, edit, format, modify, translate and otherwise create Derivative Material of Open Game Content. (h) "You" or "Your" means the licensee in terms of this agreement.

2. The License: This License applies to any Open Game Content that contains a notice indicating that the Open Game Content may only be Used under and in terms of this License. You must affix such a notice to any Open Game Content that you Use. No terms may be added to or subtracted from this License except as described by the License itself. No other terms or conditions may be applied to any Open Game Content distributed using this License.

3. Offer and Acceptance: By Using the Open Game Content You indicate Your acceptance of the terms of this License.

4. Grant and Consideration: In consideration for agreeing to use this License, the Contributors grant You a perpetual, worldwide, royalty-free, non-exclusive license with the exact terms of this License to Use, the Open Game Content.

5. Representation of Authority to Contribute: If You are contributing original material as Open Game Content, You represent that Your Contributions are Your original creation and/or You have sufficient rights to grant the rights conveyed by this License.

6. Notice of License Copyright: You must update the COPYRIGHT NOTICE portion of this License to include the exact text of the COPYRIGHT NOTICE of any Open Game Content You are copying, modifying or distributing, and You must add the title, the copyright date, and the copyright holder's name to the

COPYRIGHT NOTICE of any original Open Game Content you Distribute.

7. Use of Product Identity: You agree not to Use any Product Identity, including as an indication as to compatibility, except as expressly licensed in another, independent Agreement with the owner of each element of that Product Identity. You agree not to indicate compatibility or co-adaptability with any Trademark or Registered Trademark in conjunction with a work containing Open Game Content except as expressly licensed in another, independent Agreement with the owner of such Trademark or Registered Trademark. The use of any Product Identity in Open Game Content does not constitute a challenge to the ownership of that Product Identity. The owner of any Product Identity used in Open Game Content shall retain all rights, title and interest in and to that Product Identity.

8. Identification: If you distribute Open Game Content You must clearly indicate which portions of the work that you are distributing are Open Game Content.

9. Updating the License: Wizards or its designated Agents may publish updated versions of this License. You may use any authorized version of this License to copy, modify and distribute any Open Game Content originally distributed under any version of this License.

10. Copy of this License: You MUST include a copy of this License with every copy of the Open Game Content You Distribute.

11. Use of Contributor Credits: You may not market or advertise the Open Game Content using the name of any Contributor unless You have written permission from the Contributor to do so.

12. Inability to Comply: If it is impossible for You to comply with any of the terms of this License with respect to some or all of the Open Game Content due to statute, judicial order, or governmental regulation then You may not Use any Open Game Material so affected.

13. Termination: This License will terminate automatically if You fail to comply with all terms herein and fail to cure such breach within 30 days of becoming aware of the breach. All sublicenses shall survive the termination of this License.

14. Reformation: If any provision of this License is held to be unenforceable, such provision shall be reformed only to the extent necessary to make it enforceable.

15. COPYRIGHT NOTICE

Open Game License v 1.0 Copyright 2000, Wizards of the Coast, Inc.

System Reference Document Copyright 2000, Wizards of the Coast, Inc.; Authors Jonathan Tweet, Monte Cook, Skip Williams, based on original material by E. Gary Gygax and Dave Arneson. Monster's Handbook Copyright 2002, Fantasy Flight Publishing, Inc. Mythic Races Copyright 2001, Fantasy Flight, Inc. Path of Faith Copyright 2002, Fantasy Flight Publishing, Inc. Path of Magic Copyright 2002, Fantasy Flight Publishing, Inc. Path of Shadow Copyright 2002, Fantasy Flight Publishing, Inc. Path of the Sword Copyright 2002, Fantasy Flight Publishing, Inc. Seafarer's Handbook Copyright 2001, Fantasy Flight, Inc. Spells & Spellcraft Copyright 2002, Fantasy Flight, Inc. Traps & Treachery Copyright 2001, Fantasy Flight, Inc. Traps & Treachery II Copyright 2002, Fantasy Flight, Inc. Mastercraft Anthology Copyright 2003, Fantasy Flight Publishing, Inc.

MASTERCRAFT ANTHOLOGY

A wide-ranging set of new options for the d20 System!

This comprehensive sourcebook collects some of the most exciting and innovative aspects of the acclaimed Legends & Lairs series into one condensed, easy-to-use, eminently affordable anthology. Inside you'll find:

- A sampling of exotic, fully developed races from Mythic Races
- New rules that expand your characters' options and flexibility, including combat schools and options for mounted combat
- New prestige classes to shape your character, as well as the organizations that integrate them into your campaign world
- New feats and spells for spellcasters, as well rules for improving familiars
- Expansions for divine casters, including casting rituals and how to design small gods and their disciples
- A section on how to make your orcs the enemies they should be. New templates, feats, and even a prestige class, all specially crafted for humanoid opponents
- Devious and deadly traps complete with detailed mechanical illustrations from the best-selling Traps & Treachery and Traps & Treachery II

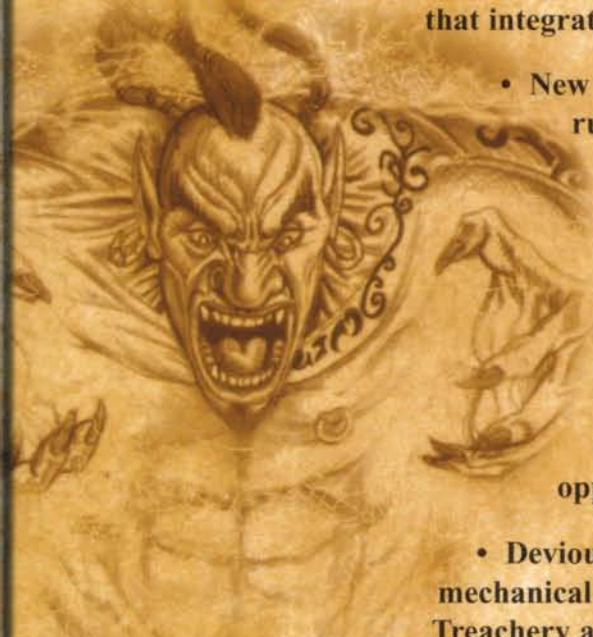

ISBN 1-58994-122-5



DD50

\$4.95

**FANTASY
FLIGHT
GAMES**



www.fantasyflightgames.com